

LAVAMAT 86800

Washing Machine

User information



Dear Customer,

Please read this user information carefully and keep it to refer to later. Please pass the user information on to any future owner of the appliance.

The following symbols are used in the text:



Safety instructions

Warning! Information that affects your personal safety.

Important! Information that prevents damage to the appliance.



Useful tips and hints



Environmental information

Contents

Operating Instructions	5
Safety	5
Disposal	6
Description of the appliance	7
Control panel	7
What is shown in the display	7
Programme overview	8
Prior to using for the first time	10
Switching on the appliance for the first time - setting the language.....	10
Setting the time.....	11
Carrying out a wash programme prior to first use.....	11
Preparing and sorting washing	11
Running a wash cycle	12
Opening the door/Loading the washing	12
Adding detergent /conditioner	12
Switching on the appliance/selecting a programme	13
Changing the temperature	14
Changing spin speed/selecting rinse hold.....	14
Setting options.....	15
Prewash, Sensitive, Stain, Night Cycle	16
Setting times	17
Time Saving: SHORT or VERY SHORT	17
Delay Start	18
Starting a programme.....	19
Programme progress	19
Interrupting a programme/Adding washing.....	19
Washing cycle complete/Removing the washing.....	20
Setup	21
Memory 1, 2, 3.....	21
SOUND	22
Extra Rinse	23
Language	23
Clock	24
Contrast and brightness	24

Child safety device	25
Cleaning and care	26
What to do if	27
Remedying small malfunctions	27
If the wash result is not satisfactory.....	29
Carrying out an emergency drain	30
Drain pump.....	31
Technical data	32
Consumption values	32
Installation and connection instructions	33
Safety information concerning installation	33
Installing the appliance	34
Transporting the appliance.....	34
Removing the transit packaging	34
Where to install	35
Making the appliance level.....	36
Electrical Connection	37
Connecting the appliance to the water supply	38
Water inlet	39
Water Drainage	40
Warranty conditions	42
Service and Spare Parts	43

Operating Instructions

Safety

Prior to using the appliance for the first time

- Follow the **"Installation and connection instructions"**.
- If the appliance is delivered in the winter months when there are minus temperatures: store the washing machine at room temperature for 24 hours before using for the first time.

Correct use

- The washing machine is only designed for the washing of normal domestic laundry at home.
- Additions or modifications to the washing machine are not permitted.
- Only use detergents/conditioners that are suitable for use in domestic washing machines.
- The washing must not contain any flammable solvent. The risk of explosion exists.
- Do not use the washing machine for dry cleaning.
- Dyes/colour removers may only be used in the washing machine, if the manufacturer of these products expressly permits this. We cannot accept liability for any damage arising.

Child safety

- Keep packaging away from children. There is a risk of suffocation.
- Children often do not recognise the hazards associated with electrical appliances. Don't allow children to use the washing machine unsupervised.
- Make sure that children and pets don't climb into the drum of the washing machine. The risk of death exists.

General safety

- Repairs to the washing machine may only be carried out by qualified/authorised service engineers.
- Never use the appliance when the electrical cable is damaged or the control panel, worktop or plinth area are damaged to such an extent that the inside of the appliance is openly accessible.

- Switch off the washing machine prior to cleaning it and carrying out maintenance. In addition, remove the power plug from the power point or – if the appliance has been hard-wired – switch off the cut-out in the fuse box or completely remove the fuse.
- If operation is stopped, disconnect the appliance from the mains supply and turn off the tap.
- Never remove the power plug from the power point by pulling on the cable. Always pull the plug.
- Multiway-plugs, connectors and extension cables must not be used. **Resulting overheating may constitute a fire hazard.**
- Never wash the washing machine down with a water jet. Danger of electric shock.
- When using wash programmes with high temperatures the glass in the door will become hot. Do not touch it!
- Before emergency emptying of the appliance, before cleaning the drain pump or opening the door in an emergency, let the water cool down.
- Small animals can nibble on electrical cables and water hoses. This can constitute a risk of electrocution and water damage. Keep small animals away from the washing machine.

Disposal



Packaging material

The packaging materials are environmentally friendly and can be recycled. The plastic components are identified by markings, e.g. >PE<, >PS<, etc. Please dispose of the packaging materials in the appropriate container at your local waste disposal facilities.



Old appliance

Please dispose of your old appliance in line with the guidelines for disposal in your area.



Warning: When your appliance has finished its working life, remove the plug from the mains socket. Cut off the cable and plug and dispose of them.

Destroy the door lock. This prevents children from trapping themselves inside and endangering their lives.

Description of the appliance

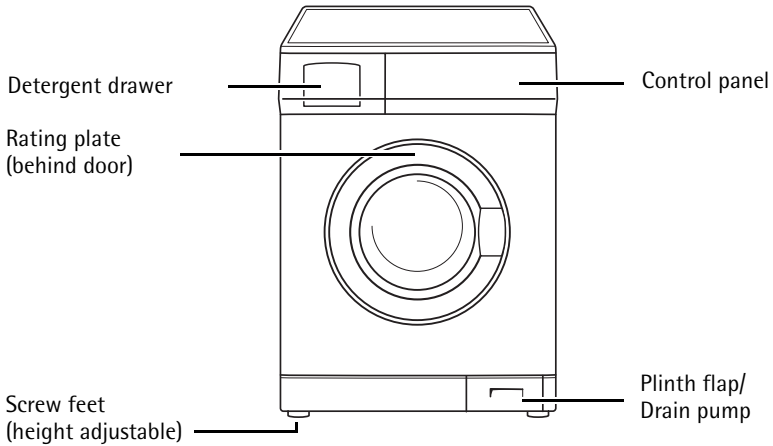

Control panel

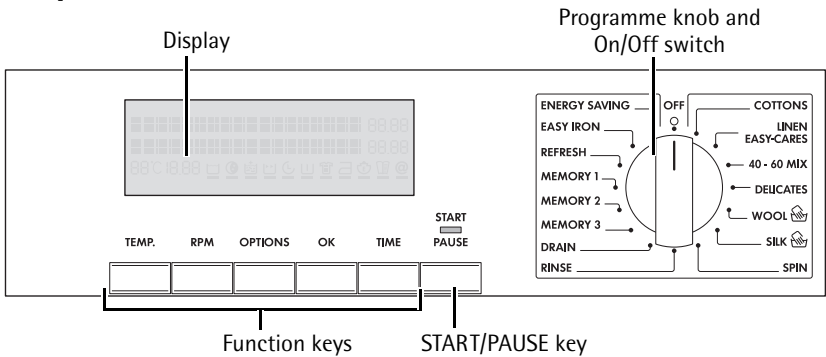

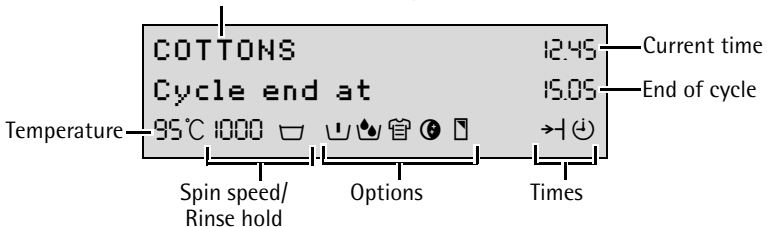

What is shown in the display

Information field, shows the current settings















Programme overview

Programme	max. Load ¹⁾ (dry washing)	Options				Times			Spin speed				
		PREWASH	SENSITIVE	STAIN	NIGHT CYCLE	SHORT	VERY SHORT	DELAY START	1600/1400	1200	1000/800/600/400	0	RINSE HOLD
ENERGY SAVING ²⁾	6 kg	•	•	•	•	-	-	•	•	•	•	•	•
COTTONS	6 kg	•	•	•	•	•	•	•	•	•	•	•	•
LINEN/EASY CARES 60°, 50°, 40°, 30°, Cold cycle	6 kg	•	•	• ³⁾	•	•	•	•	•	•	•	•	•
40 - 60 MIX	6 kg	•	•	•	•	-	-	•	•	•	•	•	•
DELICATES 40°, 30°, Cold cycle	3 kg	•	-	• ³⁾	•	-	•	•	-	•	•	•	•
WOOL/  (HANDWASH) 40°, 30°, Cold cycle	2 kg	-	-	-	-	-	-	•	-	•	•	•	•
SILK/  (HANDWASH)	1 kg	-	-	-	-	-	-	•	-	•	•	•	•
SPIN	6 kg	-	-	-	-	-	-	-	•	•	•	-	-
RINSE	3 kg	-	-	-	-	-	-	•	-	•	•	•	•
DRAIN	-	-	-	-	-	-	-	-	-	-	-	-	-
REFRESH	3 kg	-	-	-	-	-	-	•	-	•	•	•	•
EASY IRON 60°, 50°, 40°, 30°, Cold cycle	1 kg	•	-	•	•	•	•	•	-	•	•	•	•

1) A 10 litre bucket contains approximately 2.5 kg of dry washing (cotton).

2) Programme settings for testing in accordance with or in support of EN 60 456 and IEC 60 456 are described in the Chapter "Consumption Values".

3) STAIN can only be selected with wash temperatures of 40°C and above, as stain treatment products are only effective at higher temperatures.

Programmes/features:	Care symbols ¹⁾
Energy-saving programme at 60 °C for lightly to normally soiled whites/coloureds made of cotton/linen.	
Energy-saving programme at 95 °C for normally to heavily soiled whites/coloureds made of cotton/linen.	
General programme for whites/coloureds made of cotton/linen as well as for easy-care mixed fibres and synthetics. The wash programme is adjusted according to the different fabric types and load sizes. If loading only with easy-care washing, do not load more than 3 kg.	
Programme for whites/coloureds which are labelled for different wash temperatures. Items, which according to the care symbols are normally to be washed separately at 40 °C or at 60 °C, can be washed together in this programme. This makes better use of the drum capacity and thus saves energy. Through an increased wash time the washing results of a normal 60° programme are achieved.	
Gentle programme for delicate fabrics such as bonded fabrics, microfibres, synthetics, net curtains (max. load for net curtains 20 to 25 m ²). With RINSE HOLD also suitable for fabrics with climate membrane, e. g. outdoor clothing.	
Particularly delicate programme for machine washable and hand washable wool or wool mixtures.	
Particularly delicate programme at 30 °C, for machine washable and hand washable silk. Wash very delicate items individually.	
Pumps water out and spins, e. g. after a rinse hold/night cycle, or separate spin for hand-washed cottons/linens and easy-cares.	
Separate gentle rinse (3 rinses, liquid additive washed in from compartment  , gentle spin).	
Pumps water away after a rinse hold.	
Special programme at 30 °C, approx. 20 minutes, to quickly wash through e. g. lightly soiled sports clothing that has only been worn once or new clothes.	
Special programme for easy-care fabrics which, after this programme, need no or very little ironing.	

1) The numbers in the care symbols show the maximum temperatures.

Prior to using for the first time

Switching on the appliance for the first time - setting the language

The display is set to English as standard in the factory.



Important! If the display does not show the menu for setting the language when the appliance is switched on, the appliance has been switched on before. If this happens, please see the section "Setup/Language".

To switch on the appliance, turn the programme knob to any programme, e. g. COTTONS.

The display lights up and should look like the illustration opposite.

In addition the display shows:

- "To change push OPTIONS key"
- "To confirm push OK key"

If you want to keep the language:

Press the OK key.

If you want to change the language:

1. Press the OPTIONS key repeatedly, until the desired language appears in the display, e. g. ENGLISH.
2. Press the OK key.

In the display ENGLISH flashes several times and the display should then look like e. g. the illustration opposite.

3. To switch the appliance off, turn the programme knob to OFF.

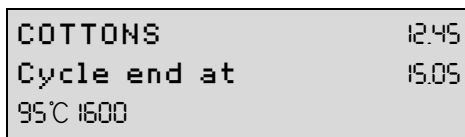
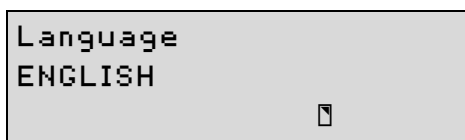
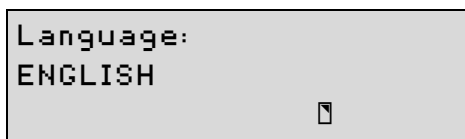

Setting the time

So that the time and the end of the programme are correctly displayed, please check the display and set the current time if necessary. To do this, please see the section "Setup/Clock".

Carrying out a wash programme prior to first use

In order to remove any residues from the drum and water container which may have been left during manufacturing, perform the first wash cycle without any washing in the machine. Programme: LINEN/EASY CARES 60 °C, option Time Saving: VERY SHORT, use approx. 1/4 measuring cup of detergent.

Preparing and sorting washing

Preparing washing

- Empty the pockets. Remove foreign bodies (e.g. coins, paper clips, nails, etc.).
- Do up zips, button up covers to prevent damage to washing.
- Remove the runners from net curtains or cover them with a net or a bag.
- Wash delicate and small items in a net/pillowcase, e. g. net curtains, tights, small socks, handkerchiefs, bras.

Important: Bras and other items containing wires should only be washed in a net bag. The wires can work loose and damage the appliance.

Sorting washing

- By colour: Wash white and coloured washing separately. Washing can run.
- By temperature, type of washing and care symbol.

Important: Do not wash fabrics with the  care symbol (= do not wash!) in the washing machine.

Running a wash cycle

Opening the door/Loading the washing

1. To open the door: pull the handle on the door.
2. Unfold washing and load it loosely into the machine. Mix large and small items.

Attention! Do not get any washing caught between the door and the rubber seal.

3. Push the door firmly shut. Door catch must audibly click shut.

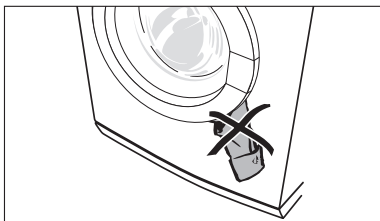

Adding detergent /conditioner

Important: Only use detergents/conditioners that are suitable for use in household washing machines.

Add detergent/conditioner in accordance with the detergent/conditioner manufacturer's instructions. Observe instructions on the packaging.

The amount of detergent used depends on:

- the degree of soiling,
- the load size
- the hardness of the tap water.
- If the manufacturer does not make any recommendations with regard to small volumes of washing: For a half-load use a third less, and for a very small load use only the half the amount of detergent that is recommended for a full load.
- Water softener should be used from water hardness range 2 (=medium). The amount of detergent used can then always be that as for hardness range 1 (=soft). Your local water company will provide you with information about water hardness in your area.

1. Pull out the detergent drawer as far as it will go.
2. Add the detergent/conditioner.
3. Push the detergent drawer in fully.

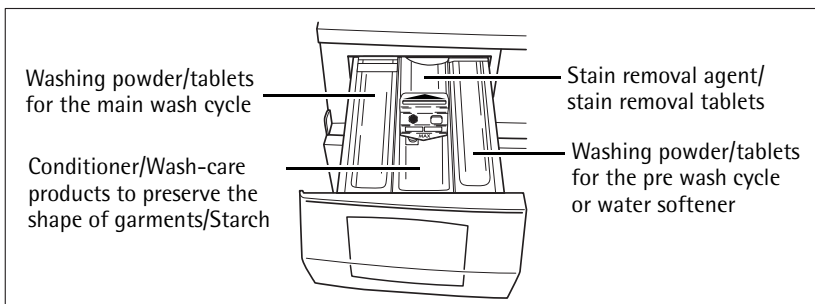

Washing powder/tablets for the main wash cycle

If you are using water softener and require the right compartment for detergent for the pre-wash cycle, add the water softener on top of the detergent for the main wash cycle in the left compartment.

Softener, wash-care products to preserve the shape of garments, starch

Fill the compartment to no more than the MAX indicator. Add water to thick liquid concentrates in accordance with the manufacturer's instructions before using them. Dissolve powder starch.

If you are using liquid detergent:

Add liquid detergent using measuring containers provided by the detergent manufacturer.

Switching on the appliance/selecting a programme

Select the programme using the programme knob, e. g., LINEN/EASY CARES.



When you select a programme, you switch the appliance on at the same time.

- The display lights up and shows the programme set, the current time and the estimated end of the cycle.
- Depending on the programme, the washing machine suggests a temperature and a spin speed. You can change these suggestions.
- The lighting for the display switches itself off at the end of the cycle or, if the appliance is not started after the programme is set, after 10 minutes. To switch the light on again, press any key or turn the programme knob.

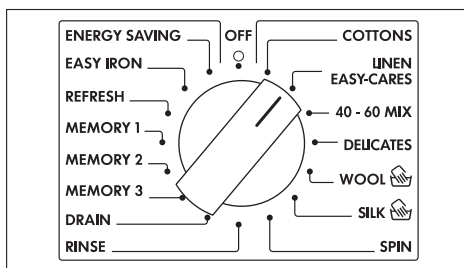

Changing the temperature

Press the TEMP. key repeatedly until the desired temperature is displayed.



Changing spin speed/selecting rinse hold

Press the RPM key repeatedly, until the desired spin speed or  RINSE HOLD is displayed.

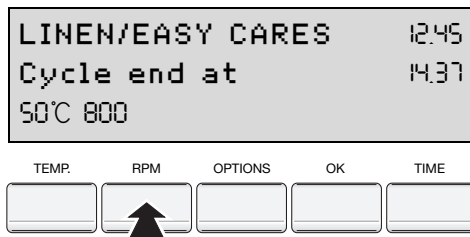

- With spin speed "0" the last rinse water is drained off at the end of the cycle, but the washing is not spun.
- With  RINSE HOLD the washing is left to soak in the last rinse water. There is no final spin after the intermediate spin(s). Intermediate spins are programme-dependent and cannot be altered.

Setting options

Options can be added to a wash cycle that has already been selected. Press the **OPTIONS** key. The display shows the symbols for the options.

PREWASH

Pre-washes at about 30 °C before the main wash cycle, which follows automatically.

SENSITIVE

Enhanced rinse action through an additional rinse cycle together with decreased drum movement (improved fabric care). Ideal when frequent washes are necessary, e. g. in cases of over-sensitive skin. An additional rinse cycle can also be permanently set (see section "Setup").

STAIN

For heavily soiled or stained washing. In-wash stain treatment products are washed in at the optimum time as the programme progresses.

NIGHT CYCLE

The washing is left to soak in the final rinse water. There is no final spin and no intermediate spin. Because of this the programme runs very quietly. **NIGHT CYCLE** is therefore particularly suitable if you want to wash at night.

Setup

The special functions that can be set under Setup remain permanently stored in the appliance, e. g., time, language, etc. (see section "Setup"), until they are changed or deactivated.

 Only the options that can be combined with the cycle that has already been set are shown in the display.

Prewash, Sensitive, Stain, Night Cycle

1. Press the OPTIONS key repeatedly until the desired symbol flashes, e. g.,  PREWASH. (With each press of the key, the next symbol flashes – moving from left to right.)



2. Press the OK key. The symbol stops flashing. A black bar appears under the symbol. The option is set. The display changes to the next option.

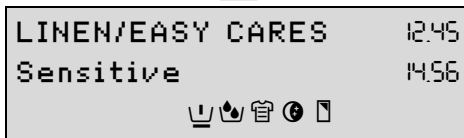

To switch off the option, press the OPTIONS key repeatedly until the symbol for the option flashes and then press the OK key. The black bar under the symbol disappears.



If other options are to be selected: press the OPTIONS key repeatedly until the desired symbol flashes and confirm each one with the OK key.

3. Press the OPTIONS key repeatedly, until the exit icon appears. The display shows the symbol for the selected option.

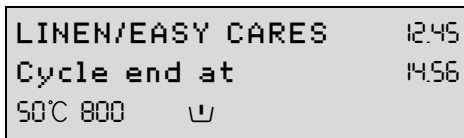

Setting times

Shortened cycles and the delay of the start time can be set for a wash cycle that has already been selected.

Press the TIME key. The display shows the symbols for Time Saving and Delay Start.

→| Time Saving: SHORT or VERY SHORT

Shortened wash cycle for lightly soiled washing.

- SHORT: only possible with the programmes COTTONS, LINEN/EASY CARES and EASY IRON
- VERY SHORT: only possible with the programmes COTTONS, LINEN/EASY CARES, EASY IRON and DELICATES.

⌚ Delay Start

To delay the start of a programme by between 30 minutes and a max. of 20 hours.

Time Saving: SHORT or VERY SHORT

1. Press the TIME key repeatedly, until the SHORT symbol →| flashes.

2. Press the OK key.

3. Press the TIME key. A black bar appears under the →| symbol, SHORT or VERY SHORT appears in the display.

4. To change from SHORT to VERY SHORT, press the TIME key again.



You can change between NORMAL, SHORT, and VERY SHORT using the TIME key.

5. Press the OK key to confirm the selection. The display changes to the symbol for Delay Start, i.e. Delay Start can now be set.

6. Press the TIME key, if no Delay Start is to be set. The display shows the SHORT symbol →| as well as the time for the end of the cycle.

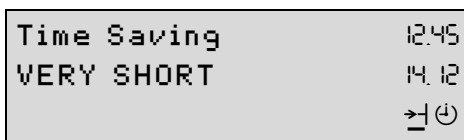
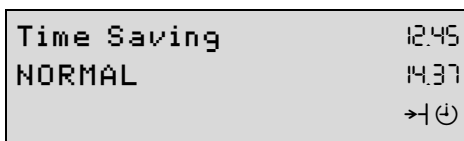

Delay Start

1. Press the TIME key repeatedly, until the DELAY START symbol ☹ flashes.
2. Press the OK key. "Start in 0 min" is shown in the display.

3. Press the TIME key repeatedly, until the display shows the desired period by which you want to delay the start, e. g. "Start in 4 h" (=4 hours). A black bar appears under the ☹ symbol.

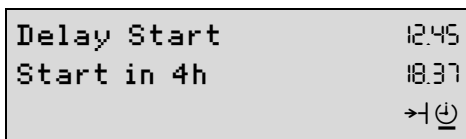

If 20 h is displayed and you press the key again, the delayed start is cancelled.

4. Press the OK key. The display shows the DELAY START symbol ☹ and the time until the end of the programme (including period by which the start has been delayed).

5. To activate the Delay Start, press the START/PAUSE key. The display now shows e. g., "Start in 4.00" (=4 hours). The display for the time remaining until the start of the programme is reduced in 30 minute intervals (e. g., 4.00, 3.30, 3.00, ... 0.30, 0).

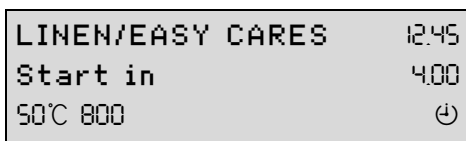

Starting a programme

1. Check that the water tap is open.
2. Press the START/PAUSE key.

The programme is started or it starts after the time delay set has elapsed.

- i** If after pressing the START/PAUSE key the display shows "Door not Closed", the door has not been shut properly. Push the door firmly closed and press the START/PAUSE key again.

Programme progress

The display indicates the stage of the programme that is currently being performed as well as the time to the end of the programme.

LINEN/EASY CARES	12.45
Washing	14.37
50°C 800	

- i** During the wash cycle the time to the end of the programme may change as the programme adjusts itself to different conditions (e. g., type and quantity of laundry, out of balance spin detection, special rinses, etc.).

TEMP.	RPM	OPTIONS	OK	TIME

Interrupting a programme/Adding washing

Interrupting a programme

- The programme can be interrupted at any time by pressing the START/PAUSE key. It is then re-started by pressing the key again.
- To stop the washing machine before the programme has ended, turn the programme knob to OFF.

Attention! Be careful if there is water in the appliance!

Adding washing

1. Press the START/PAUSE key.
 - If "Door locked" and "Pause" are alternately shown in the display, it is no longer possible to add washing, e. g. when the water level is too high.
 - If "Door unlocked" and "Pause" are alternately shown in the display, it is still possible to add washing:
2. Open the door.
3. Add washing and close the door again.
4. Press the START/PAUSE key again. The programme continues.

Washing cycle complete/Removing the washing

At the end of the cycle a long acoustic signal sounds 3 times (when the SOUND setting is NORMAL or LOW) and the messages "Cycle ended" and "Door openable" appear alternately in the display.

1. Open the door and remove the washing.
2. Turn the programme knob to OFF.
3. Turn off the tap.
4. After the wash, pull out the detergent dispenser drawer slightly to allow it to dry. Leave the door slightly open to air the inside of the washing machine.

If RINSE HOLD or NIGHT CYCLE was selected:

After a Rinse Hold or when a programme with NIGHT CYCLE has ended, the START/PAUSE indicator flashes. "Cycle ended" and "Door locked" appear alternately in the display.

The water must first be drained off:

- Turn the programme knob to OFF, then to DRAIN and press the START/PAUSE key (the water is drained without spinning),
or
- or turn the programme knob to OFF and then to SPIN. Change the spin speed if necessary and press the START/PAUSE key (the water is drained and the washing spun).

Setup

The special functions that can be set under Setup remain permanently stored independent of each washing cycle – even after the appliance has been switched off or the mains plug has been removed from the socket.



Memory 1, 2, 3

Programme combinations can be stored at programme knob positions MEMORY 1, 2, 3 and can then be selected using the programme knob. To do this the desired programme combination is first put together and then stored.

Setting the Memory

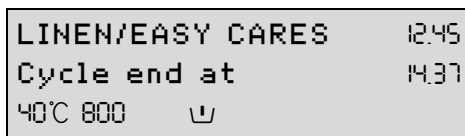
Example: Programme position MEMORY 1 is to be given the following programme combination: LINEN/EASY CARES 40 °C, 800 rpm, with PREWASH.



1. Turn the programme knob to LINEN/EASY CARES.
2. Press the TEMP. key repeatedly, until 40 °C appears in the display.
3. Press the RPM key repeatedly, until 800 appears in the display.
4. Using the OPTIONS key  set PREWASH and press the OK key. A black bar appears under the PREWASH symbol .
5. Press the OPTIONS key repeatedly, until the SETUP symbol  flashes.
6. Press the OK key. The display changes to the Special Functions level. Programme memory position MEMORY 1 is offered first.

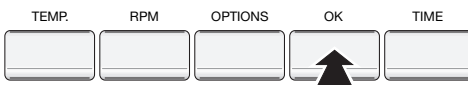
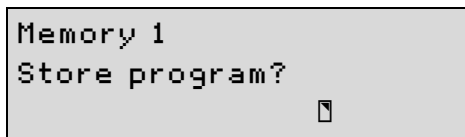

 To change to another memory position, press the OPTIONS key.

7. Press the OK key.

The programme combination is now stored to programme knob position MEMORY 1 and in the future can be selected directly using the programme knob.



The Memory can be overwritten at any time with a new programme combination (see "Changing the Memory"), but cannot be deleted.

Changing the Memory

1. Put together the new programme combination as required (for an example, see "Setting the Memory", steps 1 to 4).
2. Press the OPTIONS key repeatedly, until the SETUP symbol  flashes.
3. Press the OK key.
4. Using the OPTIONS key select the memory position to be changed, e. g. MEMORY 1.
5. Store the new programme combination using the OK key.



SOUND

The volume of the acoustic signal can be selected.

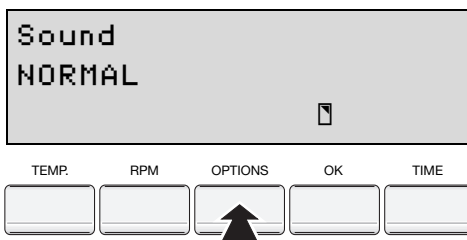
1. Turn the programme knob to any programme and press the OPTIONS key repeatedly until the SETUP symbol  flashes.
2. Press the OK key.
3. Press the OPTIONS key repeatedly, until the display shows SOUND.
4. Press the OK key.
5. Press the OPTIONS key repeatedly until the desired volume (NORMAL, LOW, NO SOUND) is shown in the display.
6. Press the OK key to confirm the setting. The icon changes to the next special function.
7. Press the OPTIONS key repeatedly until the exit icon is displayed.



Extra Rinse

1. Turn the programme knob to any programme and press the OPTIONS key repeatedly until the SETUP symbol  flashes.
2. Press the OK key.
3. Press the OPTIONS key repeatedly until EXTRA RINSE is shown in the display.
4. Press the OK key. The EXTRA RINSE symbol +  appears. The icon changes to the next special function.
5. Press the OPTIONS key repeatedly, until the exit icon appears.

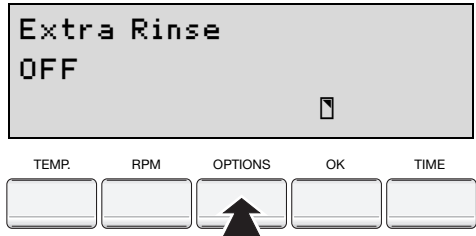

Language

1. Turn the programme knob to any programme and press the OPTIONS key repeatedly until the SETUP symbol  flashes.
2. Press the OK key.
3. Press the OPTIONS key repeatedly, until the display shows LANGUAGE.
4. Press the OK key.
5. Press the OPTIONS key repeatedly, until the desired language appears in the display, e. g. ENGLISH.
6. Press the OK key. The icon changes to the next special function.
7. Press the OPTIONS key repeatedly, until the exit icon appears.

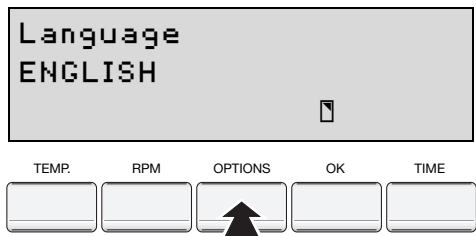

Clock

1. Turn the programme knob to any programme and press the OPTIONS key repeatedly until the SETUP symbol  flashes.
2. Press the OK key.
3. Press the OPTIONS key repeatedly until CLOCK is shown in the display.
4. Press the OK key.
5. Using the OPTIONS key set the desired time. With each press of the key, the display moves on by one minute. If the key is kept pressed, the display changes in 10 minute steps.
6. Press the OK key. The icon changes to the next special function.
7. Press the OPTIONS key repeatedly, until the exit icon appears.

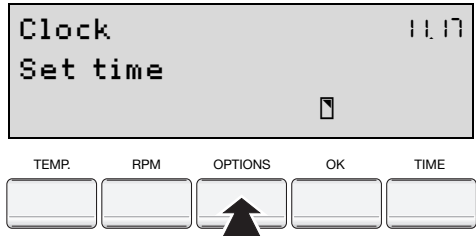

Contrast and brightness

1. Turn the programme knob to any programme and press the OPTIONS key repeatedly until the SETUP symbol  flashes.
2. Press the OK key.
3. Press the OPTIONS key repeatedly, until the display shows CONTRAST or or BRIGHTNESS.
4. Press the OK key.
5. Using the OPTIONS key set the desired setting. With each press of the key or if the key is kept pressed down, the black triangle in the diagram moves further to the right for more contrast or brightness. If the triangle reaches the right hand edge, it starts again from the left.
6. Press the OK key. The display changes to the next special function or back to the exit icon.
7. Press the OPTIONS key repeatedly, until the exit icon appears.

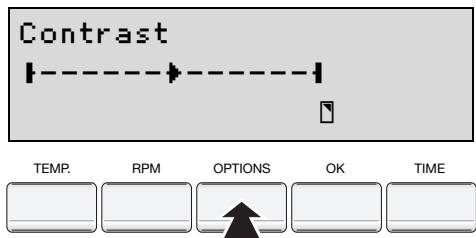

Child safety device

If the child safety device has been activated, the door can no longer be shut.

Activating the child safety device:

Use a coin to turn the knob (on the inside of the door) in a clockwise direction as far as it will go.

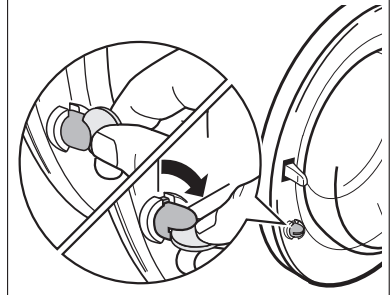

Warning! The knob must not be depressed after being set, otherwise the child safety device is not activated. The knob must stand proud as shown in the illustration.

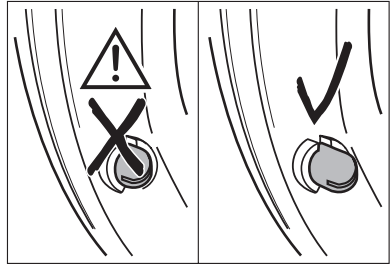

Deactivating the child safety device:

Turn the knob in an anti-clockwise direction as far as it will go.

Cleaning and care

Important: Do not use furniture cleaning products or aggressive cleaning agents to clean the appliance.
Wipe over the control panel and housing with a damp cloth.

Detergent drawer

The detergent drawer should be cleaned regularly.

1. Remove the detergent drawer by pulling firmly.
2. Remove the softener insert from the middle compartment.
3. Clean all parts with water.
4. Place the softener insert in as far as it will go, so that it is firmly in position.

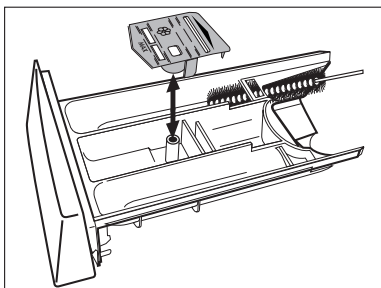

5. Clean the entire drawer recess area of the washing machine, in particular the jets on the upper side of the washing-in chamber, with a brush.
6. Place the detergent drawer in its guide rails and push it in.

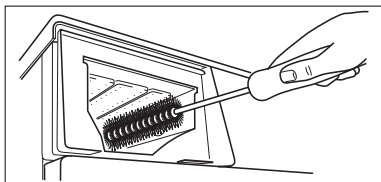

Washing drum

Rust deposits in the drum may occur due to rusting foreign bodies in the washing or tap water containing iron.

Important! Do not clean the drum with acidic descaling agents, scouring agents containing chlorine or iron or steel wool.

1. Remove any rust which has accumulated in the drum using a cleaning agent for stainless steel.
2. Run a washing cycle without any washing to clean off any cleaning agent residues. Program: LINEN/EASY CARES 60°, option Time Saving: VERY SHORT, add approx. 1/4 of a measuring cup of washing powder.

Door and rubber collar

Regularly check whether deposits or foreign substances are present in the folds of the rubber collar or inside on the door glass.
Regularly clean the door glass and the rubber collar.

What to do if...

Remedying small malfunctions

If while the appliance is operating a short acoustic signal sounds 3 times and one of the following messages appears in the display:

- "No incoming water/Check tap & Hose",
- "No drain/Check drain hose/filter" or "Pump Blocked",
- "Door not Closed",

please have a look at the following table.

When the fault is remedied, press the START/PAUSE key.

If "Warning: E and number or letter" is displayed: Switch the appliance off and on again. Re-set the programme. Press the START/PAUSE key.

If the warning is displayed again, please contact the Service Force Centre and inform them of the warning.

Problem	Possible cause	Remedy
Washing machine does not work.	Mains plug not plugged in or fuse not working.	Plug in mains plug. Check fuse.
	Door not closed properly.	Close door - there should be an audible click.
	START/PAUSE key was not pressed for long enough.	Press START/PAUSE key for longer.
The door cannot be closed.	Child safety device engaged.	Release the child safety device.
Display shows: "Selection error".	The selected function cannot be combined with other programme settings.	Make another selection.
Display shows: "Door not Closed/Please check"	Door not closed properly.	Close door - there should be an audible click. Start programme again.
Display shows: "No incoming water/Check tap & Hose"	Tap turned off.	Turn the tap on.
	The filter in the threaded inlet hose fitting is blocked.	Turn off the tap. Unscrew the hose, take out the filter and clean it.
	Water tap is blocked with limescale or faulty.	Check the water tap and have it repaired if necessary.

Problem	Possible cause	Remedy
The washing machine vibrates when operating or is not stable.	Transit bar has not been removed.	Removing the transit bar.
	The screw feet not correctly adjusted.	Adjust feet according to the Installation and Connection instructions.
	There is very little washing in the drum (e. g., just one bathrobe).	This does not affect how the machine operates.
Water is running out from under the washing machine.	Screw connection on the inlet hose is leaking.	Screw the inlet hose in firmly.
	Drain hose is leaking.	Replace drain hose.
	Drain pump cover is not closed properly.	Close the cover properly.
	Washing was caught in the door.	Load washing carefully for the next wash.
	Emergency drain hose is leaking.	Close off emergency drain hose properly.
Display shows: "Excess Detergent"	Probably too much detergent has been used.	Dose detergent exactly as instructed by manufacturer.
Display shows: – "No drain/Check drain hose/filter" or – "Pump Blocked"	Kink in drain hose.	Remove kink.
	Maximum pumping height of 1 m exceeded.	Please contact your Service Force Centre
	Drain pump is blocked.	Switch off the appliance. Pull out mains plug. Clean the drain pump. Remove foreign bodies from the pump housing.
	For sink spigot connections: spigot is blocked.	Clean out spigot.
Fabric softener not rinsed in, ☼ compartment for additives is filled with water.	Conditioner insert in the compartment for additives is not correctly attached or is blocked.	Clean the detergent dispenser drawer, insert the conditioner insert firmly.

Problem	Possible cause	Remedy
The door cannot be opened when the appliance is switched on.	Door locked.	Wait until the display alternately shows "Door unlocked" and "Cycle ended".
	There has been a power cut. (All displays are off.) For safety reasons, the door will remain locked for between 4 and 10 minutes.	The programme will continue when the power cut is over. To remove washing: If water can be seen in the appliance, before opening the door, first perform an emergency drain.
Washing is heavily creased.	Possibly too much washing was loaded.	Observe maximum loads.

If the wash result is not satisfactory

The washing is grey and there are limescale deposits in the drum

- Too little detergent was used.
- An incorrect detergent was used.
- Individual stains were not pre-treated.
- The programme or temperature was not set properly.

There are grey stains on the washing

- Items that were soiled with ointments, fats or oils were washed using too little detergent.
- The wash temperature used was too low.
- A common cause is that conditioner – in particular the type in concentrated form – has come in contact with the washing. Wash out such marks as soon as possible and exercise care when using the said conditioner.

Foam can still be seen following the final rinse

- Modern detergents can cause foam to be created even during the final rinse. In spite of this, the washing has been sufficiently rinsed.

There are white residues on the washing

- What can be seen here are insoluble substances which modern detergents contain.
They are not the result of insufficient rinsing.
Shake or brush the washing. If possible turn the washing inside out before washing. Check your selection of detergent and perhaps use liquid detergent instead.

Carrying out an emergency drain



Warning! Prior to carrying out an emergency drain, switch off the washing machine and remove the power plug from the power point.

Warning! The water that comes out of the emergency drain hose may be hot. There is a risk of scalding. Let the water cool before performing an emergency drain!

1. Open the plinth flap and remove it.

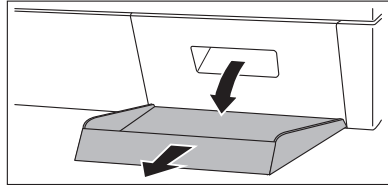

2. Remove the emergency drain hose.

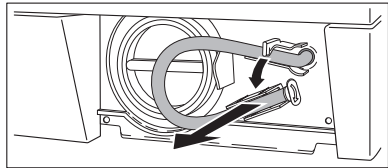

3. Place a shallow container underneath it. Then loosen the drain plug by turning it in an anti-clockwise direction and pull it out.

4. The water will run out. If it is necessary to empty the container more than once, seal up the emergency drain hose with the drain plug while you are doing so.

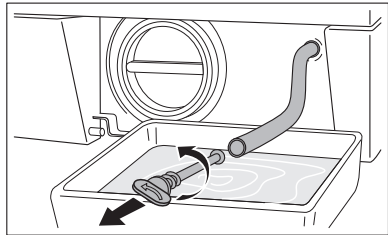

When the water has all drained away:

5. Insert the plug firmly into the emergency drain hose and turn it in a clockwise direction until it is firmly in place.
6. Replace the emergency drain hose into the retainer.
7. Insert the plinth flap into place and close it.

Drain pump

The drain pump is maintenance-free. It is only necessary to open the pump cover if there is a malfunction and water is no longer being pumped out, e.g. if the pump wheel is blocked.

Before loading the machine, please always ensure that there are no foreign bodies present in the pockets or in between the items to be washed. Paper clips, nails, etc. which may find their way into the washing machine along with the washing will remain in the drain pump housing (foreign body trap that protects the pump wheel).



Warning! Before opening the cover of the drain pump, switch off the washing machine and remove the power plug from the power point.

1. First carry out an emergency drain.
2. Place a cloth on the floor in front of the cover of the drain pump. Residual water runs out.
3. Unscrew the pump cover in an anti-clockwise direction and remove it.

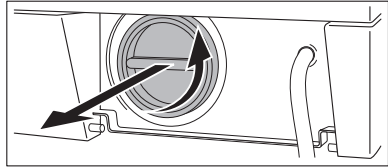

4. Remove foreign bodies and fluff from the pump housing and from the pump wheel.

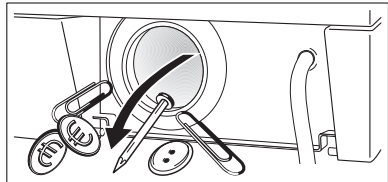

5. Check whether the pump wheel right at the back of the pump housing can turn. (If the wheel rotates with a jerky motion, this is normal.) If the pumping wheel cannot be turned, please contact your local Service Force Centre..

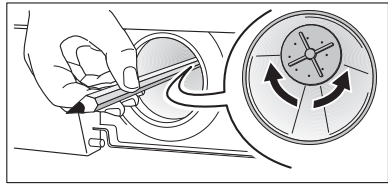

6. Insert the pump cover. Insert the guides at the sides of the cover into the guide slots and tighten the cover by turning in a clockwise direction.
7. Close off the emergency drain hose and place it in the retainer.
8. Close the plinth flap.

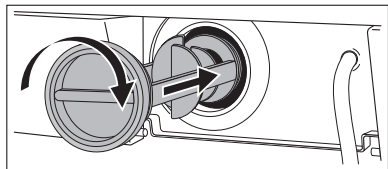

Technical data



This appliance conforms with the following EU Directives:

- 73/23/EEC dated 19.02.1973 Low Voltage Directive
- 89/336/EEC dated 03.05.1989 EMC Directive inclusive of Amending Directive 92/31/EEC
- 93/68/EEC dated 22.07.1993 CE Marking Directive

Height x width x depth	850 x 598 x 640mm
Depth when door is open	1,017 mm
Height adjustability	approx. +10/-5mm
Load (depending on programme)	max. 6kg
Area of use	Household
Drum spin speed	see Rating Plate
Water pressure	1-10 bar (=10-100N/cm ² =0,1-1,0MPa)

Consumption values

The consumption values were obtained under standardised conditions. They may vary when operating in domestic conditions.

Programme knob (Temperature)	Type of material	Load in kg ¹⁾	Water in litres	Energy in kWh
ENERGY SAVING ²⁾	Cotton	6	39	1,02
COTTONS 95	Cotton	6	54	2,10
LINEN/EASY CARES 40 ²⁾	Cotton	6	52	0,75
LINEN/EASY CARES 40; Time Saving: SHORT ²⁾	Synthetics	3	52	0,52
DELICATES 30	Synthetics	3	56	0,40
WOOL  (Handwash) 30	Wool	2	50	0,35

1) The load is determined in accordance with EN 60456 standard loads.

2) **Note:** Programme setting for tests in accordance with or supporting EN 60 456 and IEC 60 456.

Consumption values will vary from the values quoted depending on water pressure, water hardness, water temperature at filling, room temperature, type and quantity of washing, detergent used, variations in mains voltage and any options selected.

Installation and connection instructions



Safety information concerning installation

- This washing machine **cannot be built-in**.
- Before using for the first time, check the appliance for damage sustained while it was being transported. Do not under any circumstances connect an appliance that is damaged to the mains. In the event of damage to the appliance contact your supplier.
- Be sure to remove all the components of the transit packaging before using the appliance for the first time. Otherwise when spinning damage may be caused to the appliance or to neighbouring units or furniture.
- Before using the appliance for the first time, splash protection must be completed. (See "Removing transit packaging").
- Always plug the mains plug into a correctly installed shockproof socket.
- If hard-wired: hard-wiring to the mains may only be carried out by an a qualified electrician.
- Prior to using the appliance for the first time, ensure that the rated voltage and current on the rating plate match the mains voltage and current where the appliance is to be installed. The required fuse protection is also to be found on the rating plate.
- If work on the plumbing is required for the proper connection of the washing machine to the water supply, this must be undertaken by a registered plumber.
- If work on the electricity supply system is required for the proper connection of the washing machine to the electricity supply, this must be undertaken by a registered electrician.
- The washing machine's mains cable must only be replaced by a Service Force Engineer

Installing the appliance

Transporting the appliance



Warning: The washing machine is very heavy. There is a risk of injury. Exercise care when lifting the appliance.

- Do not lay the washing machine on its front nor on its right side (as seen from the front). Electrical components may get wet.
- Never transport the appliance without using the transit packaging. Only remove the transit packaging when the appliance is in its place of installation. Transporting the appliance without the use of the transit packaging can cause damage to the appliance.
- Never lift the appliance by the door when it is open nor by the plinth.

When using a sack trolley to transport the washing machine:

- Only use the sack trolley on the side of the appliance.

Removing the transit packaging

Important! Be sure to remove all the components of the transit packaging prior to using the appliance for the first time. Keep the transit packaging in a safe place, in case it is needed at a later date when the appliance is to be moved (e.g. moving house).

1. Open the two hose retainers located at the rear of the appliance and remove the hoses and electrical cable.
2. Remove the two hose retainers from the appliance with a strong tug.

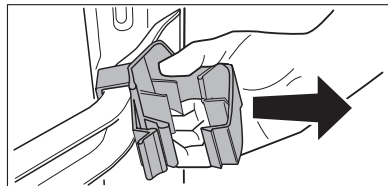
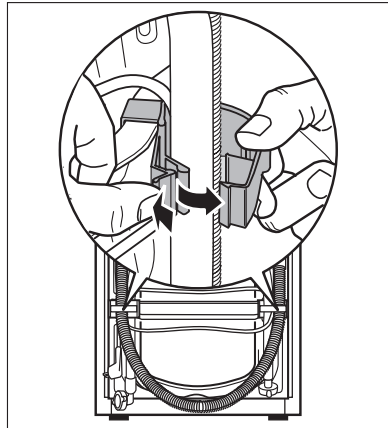

i Special spanner A and sealing caps B (2 units) and C (1 unit) come with the appliance.

3. Use special spanner A to remove screw D and the compression spring.
4. Use sealing cap C to cap the hole.
5. Use special spanner A to remove the two screws E.
6. Use special spanner A to remove the four screws F.
7. Remove transit bar G.
8. Screw in the four screws F again.
9. Use sealing caps B to cap the two large holes.

Important: Press all sealing caps B (2 items) and C (1 item) in firmly so that they snap into the rear wall.

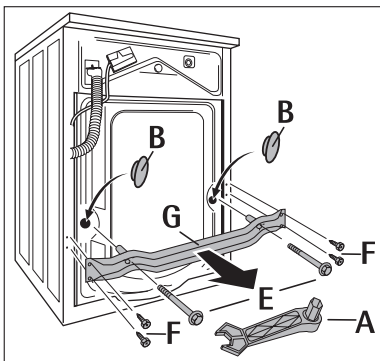
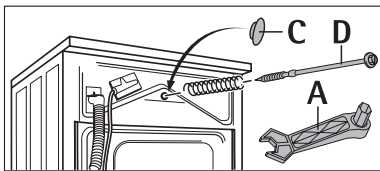

Where to install

Important! The washing machine must not be operated in a room where there is a danger of frost. There is a risk of frost damage or adverse effect on the performance of the machine. Frost damage is not covered under the warranty.

- The surface on which the appliance is to be installed must be firm and level. Do not install the appliance on carpeted floors or soft floor coverings.
- The surface on which the appliance is to be installed must be clean and dry and free from grease, so that the appliance does not slide.
- If the location in which the appliance is to be installed is fitted with small-format tiles, put a rubber mat (available in the shops) under the appliance.

If the appliance is to stand on a floor which moves, e.g. a suspended wooden floor:

Place the appliance in an area as close as possible to a corner of the room.

1. Screw a water-resistant wooden board (at least 15 mm thick) onto at least 2 of the floor joists.

Making the appliance level

The four feet of the appliance are pre-adjusted.

Large degrees of unevenness can be compensated for by adjusting the four feet of the appliance.

Use the special spanner supplied to do this.

Important: Do not use pieces of wood, cardboard or such like to level out small degrees of unevenness in the floor. Adjust the adjustable feet instead.

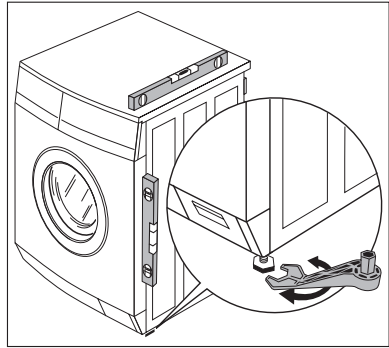

Electrical Connection

Any electrical work required to install this appliance should be carried out by a qualified electrician or competent person.



WARNING – THIS APPLIANCE MUST BE EARTHED.

The manufacturer declines any liability should these safety measures not be observed.

Before switching on, make sure the electricity supply voltage is the same as that indicated on the appliance rating plate.

The appliance is supplied with a 13 amp plug fitted. In the event of having to change the fuse in the plug supplied, a 13 amp ASTA approved (BS 1362) fuse must be used.

Should the plug need to be replaced for any reason, proceed as described below.

The wires in the mains lead are coloured in accordance with the following code:

Green and Yellow:	Earth
Blue:	Neutral
Brown:	Live

- The wire coloured green and yellow must be connected to the terminal marked with the letter "E" or by the earth symbol \oplus or coloured green and yellow.
- The wire coloured blue must be connected to the terminal "N" or coloured black.
- The wire coloured brown must be connected to the terminal marked "L" or coloured red.
- Upon completion there must be no cut, or stray strands of wire present and the cord clamp must be secure over the outer sheath.

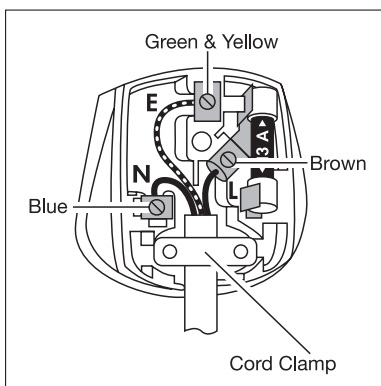

WARNING! A cut off plug inserted into a 13 amp socket is a serious safety (shock) hazard. Ensure that the cut off plug is disposed of safely.

Permanent Connection

In the case of a permanent connection it is necessary that you install a double pole switch between the appliance and the electricity supply (mains), with a minimum gap of 3 mm between the switch contacts and of a type suitable for the required load in compliance with the current electrical regulations.

The switch must not break the yellow and green earth cable at any point.

This appliance complies with the requirements laid out in the EEC Directive 76/899.

Voltage 240 V AC: Fuse rating 13 amps

See rating plate for further information.

This appliance meets VDE requirements.

Particular regulations of local electricity authorities must be observed.

This appliance conforms to EEC Directive No. 82/499/EEG on radio interference.



WARNING! Repairs to electrical appliances must only be carried out by trained personnel. Improper repairs may lead to serious risks for the user.

Connecting the appliance to the water supply

Important:

- This appliance must **not** be connected to the hot water supply.
- When connecting the appliance, use only new hose kits.
- Only connect the appliance to the drinking water supply. Rain water or water for industrial use may only be used if it fulfils the requirements of DIN 1986 and DIN 1988.
- Do not kink or crush the water inlet hose or drain hose.

Permitted water pressure

The water pressure must be at least 1 bar ($= 10\text{N/cm}^2 = 0.1\text{MPa}$), and may be a maximum of 10bar ($= 100\text{N/cm}^2 = 1\text{MPa}$).

– If more than 10bar: Connect a pressure reduction valve.

– If less than 1 bar: Disconnect the appliance end of the inlet hose from the solenoid inlet valve and remove the flow meter. (In addition remove the filter using pointed pliers and take out the rubber gasket behind it.) Replace the filter.

Water inlet

A 1.35m long pressure hose is supplied with the appliance.
If a longer inlet hose is required, only hoses from the manufacturer are to be used. Service Force stocks hose kits of different lengths.



Sealing rings are either inserted in the plastic nuts of the threaded hose fitting or are included as spare parts. Do not use any other sealing rings.

Important! All threaded hose fittings must only be tightened by hand.

1. Connect the hose with the right-angle connector to the machine.

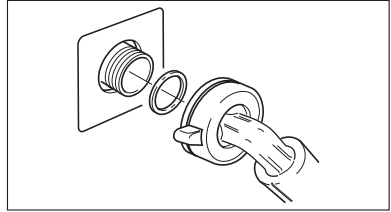

Important! Do not position the inlet hose vertically downwards. Position it to the right or the left as shown in the illustration.

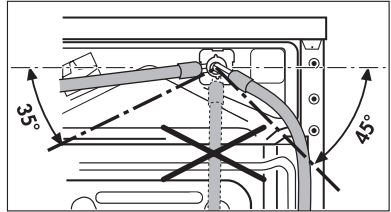

2. Connect the hose with the straight connector to a water tap with an R $\frac{3}{4}$ (inch) screw thread.
3. Slowly turn on the tap and check that all connections are watertight.

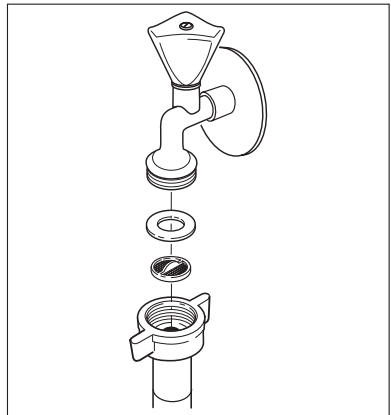

Water Drainage

The appliance drain hose should hook into a standpipe, the hook in the drain hose is formed using the plastic "U-Piece" supplied. The standpipe should have an internal diameter of approximately 38 mm (see diagram) thus ensuring there is an air break between the drain hose and standpipe.

Important! It is essential to lay the drainage hose without kinks.

When discharging into a standpipe ensure that the top of the curve in the hose end is no more than 90 cm (35.4") and no less than 60 cm (23.6") above floor level.

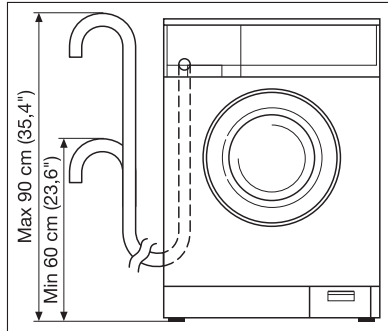

The upright standpipe should have a minimum length of 30 cm (12") from the bottom of the elbow to the top of the pipe (see diagram). Make sure that it is designed in such a way that the end of the drain hose cannot be covered with water.

Longer drain hoses are available in lengths of 2.7 and 4 metres from your Service Force Centre.

For drainage into an outlet spigot: If the outlet spigot has not been used before, remove any blanking plug that may be in place. Push the drain hose onto the spigot and secure with a clip if required. Ensure the drain hose is looped upwards to prevent waste water from the sink entering the washing machine.

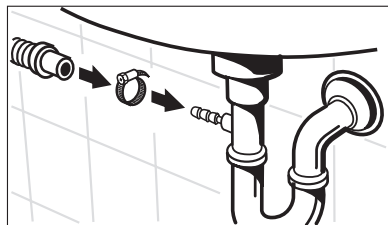
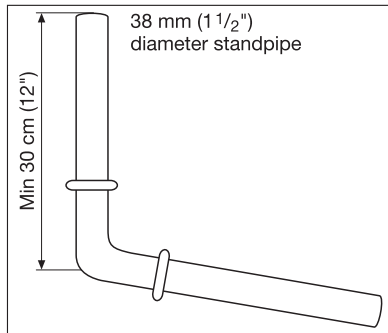

Important! The end of the drainage hose must not be submerged in the pumped-out water. Otherwise, the water could be sucked back into the appliance.

Pumping heights of over 1 metre

The washing machine's drain pump is able to pump water to a height of 1 metre, calculated from the surface on which the appliance is installed.

Important! If pumping height is over 1 metre malfunctions and damage to the appliance may arise.

For pumping heights over 1 metre a conversion kit can be obtained. Please contact Service Force Centre.

Warranty conditions

Great Britain

Standard guarantee conditions

We, AEG, undertake that if within 12 months of the date of the purchase this AEG appliance or any part thereof is proved to be defective by reason only of faulty workmanship or materials, we will, at our discretion repair or replace the same FREE OF CHARGE for labour, materials or carriage on condition that:

- The appliance has been correctly installed and used only on the electricity or gas supply stated on the rating plate.
- The appliance has been used for normal domestic purposes only, and in accordance with the manufacturer's operating and maintenance instructions.
- The appliance has not been serviced, maintained, repaired, taken apart or tampered with by any person not authorised by us.
- All service work under this guarantee must be undertaken by a Service Force Centre. Any appliance or defective part replaced shall become the Company's property.
- This guarantee is in addition to your statutory and other legal rights.
- Home visits are made between 8.30am and 5.30pm Monday to Friday. Visits may be available outside these hours in which case a premium will be charged.

Exclusions

This guarantee does not cover:

- Damage or calls resulting from transportation, improper use or neglect, the replacement of any light bulbs or removable parts of glass or plastic.
- Costs incurred for calls to put right an appliance which is improperly installed or calls to appliances outside the United Kingdom.
- Appliances found to be in use within a commercial environment, plus those which are subject to rental agreements.
- Products of AEG manufacture which are not marketed by AEG.

European Guarantee

If you should move to another country within Europe then your guarantee moves with you to your new home subject to the following qualifications:

- The guarantee starts from the date you first purchased your product.
- The guarantee is for the same period and to the same extent for labour and parts as exists in the new country of use for this brand or range of products.
- This guarantee relates to you and cannot be transferred to another user.
- Your new home is within the European Community (EC) or European Free Trade Area.
- The product is installed and used in accordance with our instructions and is only used domestically, i.e. a normal household.
- The product is installed taking into account regulations in your new country.

Before you move please contact your nearest Customer Care centre, listed below, to give them details of your new home. They will then ensure that the local Service Organisation is aware of your move and able to look after you and your appliances.

France	Senlis	+33 (0) 3 44 62 29 29
Germany	Nürnberg	+49 (0) 800 234 7378
Italy	Pordenone	+39 (0) 800 117511
Sweden	Stockholm	+46 (0) 8 672 5360
UK	Slough	+44 (0) 1753 219899

Service and Spare Parts

If the event of your appliance requiring service, or if you wish to purchase spare parts, please contact Service Force by telephoning:

0870 5 929 929

Your telephone call will be automatically routed to the Service Force Centre covering your post code area.

For the address of your local Service Force Centre and further information about Service Force, please visit the website at

www.serviceforce.co.uk

Before calling out an engineer, please ensure you have read the details under the heading „What to do if...“

When you contact the Service Force Centre you will need to give the following details:

1. Your name, address and post code.
2. Your telephone number.
3. Clear and concise details of the fault.
4. The model and serial number of the appliance (found on the rating plate)
5. The purchase date.

Please note that a valid purchase receipt or guarantee documentation is required for in-guarantee service calls.

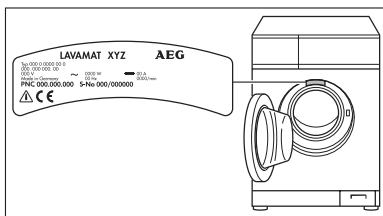

Customer Care

For general enquiries concerning your AEG appliance, or for further information on AEG products please contact our Customer Care Department by letter or telephone at the address below or visit our website at **www.aeg.co.uk**.

Customer Care Department
AEG Domestic Appliances
55-77 High Street
Slough
Berkshire, SL1 1DZ
Tel: 08705 350350 (*)

(*) Calls may be recorded for training purposes

 **From the Electrolux Group. The world's No. 1 choice.**

The Electrolux Group is the world's largest producer of powered appliances for kitchen, cleaning and outdoor use. More than 55 million Electrolux Group products (such as refrigerators, cookers, washing machines, vacuum cleaners, chain saws and lawn mowers) are sold each year to a value of approx. USD 14 billion in more than 150 countries around the world.

AEG Hausgeräte GmbH
Postfach 1036
D-90327 Nürnberg

<http://www.aeg.hausgeraete.de>

© Copyright by AEG

105 176 007-00-280404-01

Subject to change without notice

Free Manuals Download Website

<http://myh66.com>

<http://usermanuals.us>

<http://www.somanuals.com>

<http://www.4manuals.cc>

<http://www.manual-lib.com>

<http://www.404manual.com>

<http://www.luxmanual.com>

<http://aubethermostatmanual.com>

Golf course search by state

<http://golfingnear.com>

Email search by domain

<http://emailbydomain.com>

Auto manuals search

<http://auto.somanuals.com>

TV manuals search

<http://tv.somanuals.com>