



# VivoPC VC60 Series

## User Manual



# E11593

## Revised Edition V3

### May 2016

#### COPYRIGHT INFORMATION

No part of this manual, including the products and software described in it, may be reproduced, transmitted, transcribed, stored in a retrieval system, or translated into any language in any form or by any means, except documentation kept by the purchaser for backup purposes, without the express written permission of ASUSTeK COMPUTER INC. ("ASUS").

ASUS PROVIDES THIS MANUAL "AS IS" WITHOUT WARRANTY OF ANY KIND, EITHER EXPRESS OR IMPLIED, INCLUDING BUT NOT LIMITED TO THE IMPLIED WARRANTIES OR CONDITIONS OF MERCHANTABILITY OR FITNESS FOR A PARTICULAR PURPOSE. IN NO EVENT SHALL ASUS, ITS DIRECTORS, OFFICERS, EMPLOYEES OR AGENTS BE LIABLE FOR ANY INDIRECT, SPECIAL, INCIDENTAL, OR CONSEQUENTIAL DAMAGES (INCLUDING DAMAGES FOR LOSS OF PROFITS, LOSS OF BUSINESS, LOSS OF USE OR DATA, INTERRUPTION OF BUSINESS AND THE LIKE), EVEN IF ASUS HAS BEEN ADVISED OF THE POSSIBILITY OF SUCH DAMAGES ARISING FROM ANY DEFECT OR ERROR IN THIS MANUAL OR PRODUCT.

Products and corporate names appearing in this manual may or may not be registered trademarks or copyrights of their respective companies, and are used only for identification or explanation and to the owners' benefit, without intent to infringe.

SPECIFICATIONS AND INFORMATION CONTAINED IN THIS MANUAL ARE FURNISHED FOR INFORMATIONAL USE ONLY, AND ARE SUBJECT TO CHANGE AT ANY TIME WITHOUT NOTICE, AND SHOULD NOT BE CONSTRUED AS A COMMITMENT BY ASUS. ASUS ASSUMES NO RESPONSIBILITY OR LIABILITY FOR ANY ERRORS OR INACCURACIES THAT MAY APPEAR IN THIS MANUAL, INCLUDING THE PRODUCTS AND SOFTWARE DESCRIBED IN IT.

Copyright © 2016 ASUSTeK COMPUTER INC. All Rights Reserved.

#### LIMITATION OF LIABILITY

Circumstances may arise where because of a default on ASUS' part or other liability, you are entitled to recover damages from ASUS. In each such instance, regardless of the basis on which you are entitled to claim damages from ASUS, ASUS is liable for no more than damages for bodily injury (including death) and damage to real property and tangible personal property; or any other actual and direct damages resulted from omission or failure of performing legal duties under this Warranty Statement, up to the listed contract price of each product.

ASUS will only be responsible for or indemnify you for loss, damages or claims based in contract, tort or infringement under this Warranty Statement.

This limit also applies to ASUS' suppliers and its reseller. It is the maximum for which ASUS, its suppliers, and your reseller are collectively responsible.

UNDER NO CIRCUMSTANCES IS ASUS LIABLE FOR ANY OF THE FOLLOWING: (1) THIRD-PARTY CLAIMS AGAINST YOU FOR DAMAGES; (2) LOSS OF, OR DAMAGE TO, YOUR RECORDS OR DATA; OR (3) SPECIAL, INCIDENTAL, OR INDIRECT DAMAGES OR FOR ANY ECONOMIC CONSEQUENTIAL DAMAGES (INCLUDING LOST PROFITS OR SAVINGS), EVEN IF ASUS, ITS SUPPLIERS OR YOUR RESELLER IS INFORMED OF THEIR POSSIBILITY.

#### SERVICE AND SUPPORT

Visit our multi-language web site at <https://www.asus.com/support>

# Contents

About this manual .....	4
Conventions used in this manual .....	4
Typography.....	4
Package contents.....	5

## Getting to know your VivoPC

Features .....	8
Front .....	8
Left side .....	9
Rear .....	10

## Using your VivoPC

Getting started.....	14
Connect the AC power adapter to your VivoPC .....	14
Connect a display panel to your VivoPC .....	16
Connect the USB cable from keyboard or mouse .....	18
Turn on your Vivo PC.....	19
Turning your VivoPC off .....	20
Putting your VivoPC to sleep .....	20
Entering the BIOS Setup .....	20
Quickly enter the BIOS.....	21

## Mounting your VivoPC

Installing your VivoPC to a VESA mount-compatible device.....	24
---	----

## Appendix

Safety information .....	28
Setting up your system.....	28
Care during use .....	28
Regulatory notices.....	30
ASUS contact information .....	36

# About this manual

This manual provides information about the hardware and software features of your VivoPC, organized through the following chapters:

## Chapter 1: Getting to know your VivoPC

This chapter details the hardware components of your VivoPC.

## Chapter 2: Using your VivoPC

This chapter provides you with information on using your VivoPC.

## Chapter 3: Mounting your VivoPC

This chapter provides you with information on how to mount your VivoPC to a VESA mount-compatible device.

## Appendix

This section includes notices and safety statements for your VivoPC.

# Conventions used in this manual

To highlight key information in this manual, some text are presented as follows:

---

**IMPORTANT!** This message contains vital information that must be followed to complete a task.

---

---

**NOTE:** This message contains additional information and tips that can help complete tasks.

---

---

**WARNING!** This message contains important information that must be followed to keep you safe while performing certain tasks and prevent damage to your PC's data and components.

---

# Typography

## **Bold text**

Indicates a menu or an item to select.

## *Italic*

This indicates sections that you can refer to in this manual.

# Package contents

Your VivoPC package contains the following items:

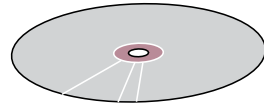
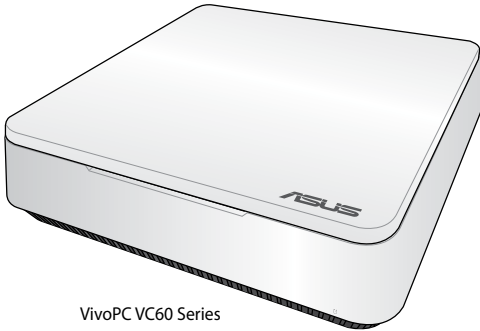

Driver DVD\*

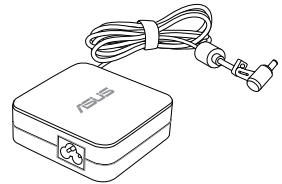

AC power adapter

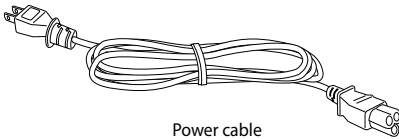

Power cable



4 pcs. 8mm screws for VESA mounting plate

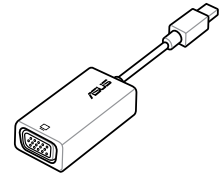

Mini DisplayPort to VGA adapter\*



Technical documentations

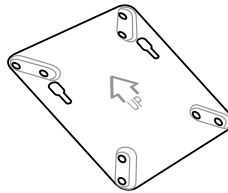

VESA mounting plate



4 pcs. rubber heads for VESA mounting plate



2 pcs. 12mm screws

---

## NOTE:

- Actual product specifications may vary with territories.
  - If the device or its components fail or malfunction during normal and proper use within the warranty period, bring the warranty card to the ASUS Service Center for replacement of the defective components.
  - \*The availability of these items vary with your VivoPC package.
-



*1*

***Getting to know your VivoPC***

# Features

## Front

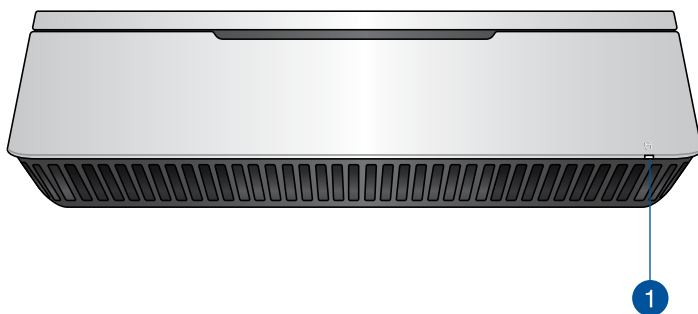

1

### **Drive activity indicator**

This indicator lights up when your VivoPC is accessing the internal storage drive.



## Left side

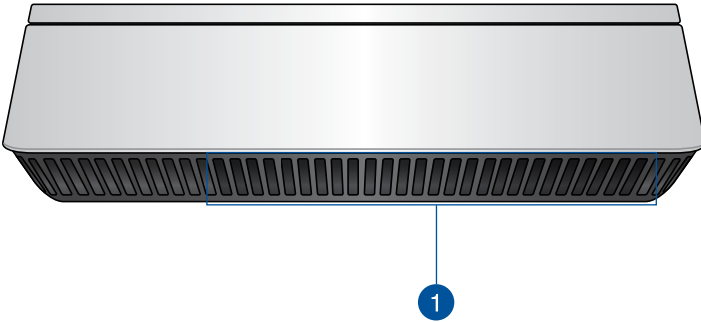

1

### Air vents

The air vents on the left side allows cooler air to enter your VivoPC chassis.





---

**IMPORTANT:** For an optimum heat dissipation and air ventilation, ensure that the air vents are free from obstructions.

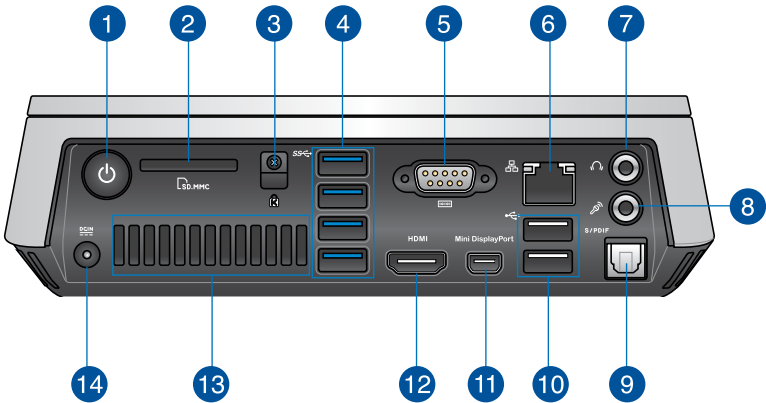
---

# Rear



- 1**  **Power button**  
The power button allows you to turn the VivoPC on or off. You can also use the power button to put your VivoPC to sleep mode.
- 2**  **Memory card slot**  
The built-in memory card reader enables your PC to read and write data to and from MMC/SD cards.
- 3**  **Kensington security slot**  
The Kensington security slot allows you to secure your VivoPC using Kensington® security products.
- 4**  **USB 3.0 ports**  
These USB (Universal Serial Bus) 3.0 ports provide a transfer rate of up to 5Gbit/s and are backward compatible with USB2.0.

5



### **Serial (COM) connector**

The 9-pin serial (COM) connector allows you to connect devices that have serial ports such as mouse, modem, or printers.

6



### **LAN port**

The eight-pin RJ-45 LAN port supports a standard Ethernet cable for connection to a local network.

7



### **Headphone/Audio Out jack**

The stereo headphone jack is used to connect the system's audio out signal to amplified speakers or headphones.

8



### **Microphone jack**

The microphone jack is designed to connect the microphone used for video conferencing, voice narrations, or simple audio recordings.

9



### **Digital audio out port (S/PDIF optical)**

The Sony/Philips Digital Interface (S/PDIF) optical out port allows you to transfer digital audio from your VivoPC into an amplifier or your TV.

10



### **USB 2.0 ports**

The USB (Universal Serial Bus) 2.0 ports are compatible with USB 2.0/1.1 devices such as keyboards, mouse devices, cameras, and hard disk drives. USB allows many devices to run simultaneously on a single computer, with some peripheral acting as additional plug-in sites or hubs.

11

### **Mini DisplayPort**

Use this port to connect your VivoPC to a DisplayPort or VGA external display.

12



### **HDMI port**

The HDMI (High Definition Multimedia Interface) port supports a Full-HD device such as an LCD TV or monitor to allow viewing on a larger external display.

13

### Rear air vents

The air vents on the rear allow warm air to exit the VivoPC.

---

**IMPORTANT:** For an optimum heat dissipation and air ventilation, keep the air vents at least 10cm away from any obstructions.

---

14



### Power input (DC 19V)

The supplied power adapter converts AC power to DC power for use with this jack. Power supplied through this jack supplies power to the PC. To prevent damage to the PC, always use the supplied power adapter.

---

**WARNING!** The power adapter may become warm to hot when in use. Do not cover the adapter and keep it away from your body.

---

***Using your VivoPC***

2

# Getting started

## Connect the AC power adapter to your VivoPC

### To connect the AC power adapter to your VivoPC:

- A. Connect the AC power cord to the AC/DC adapter.
- B. Plug the AC power cord into a 100V~240V power source.
- C. Connect the DC power connector into your VivoPC's power (DC) input port.

---

**NOTE:** The power adapter may vary in appearance, depending on models and your region.

---

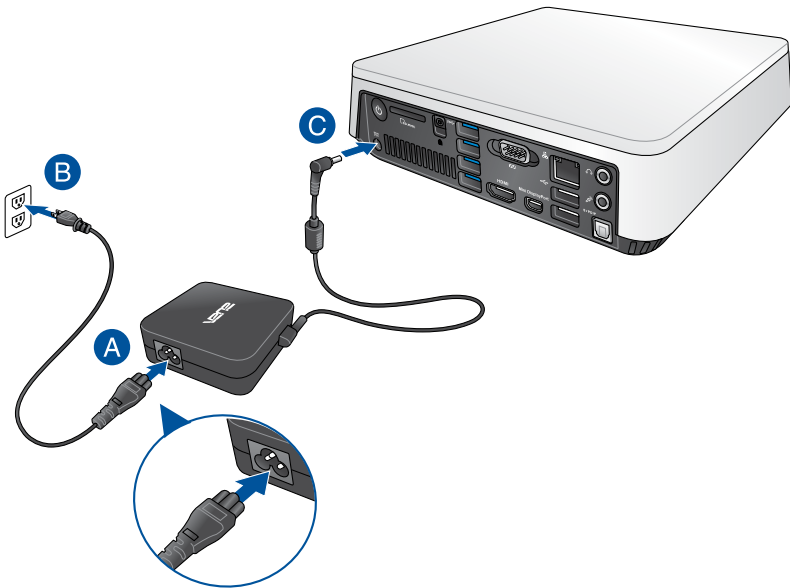

---

**IMPORTANT!**

- We strongly recommend that you use only the AC power adapter and cable that came with your VivoPC.
  - We strongly recommend that you use a grounded wall socket while using your VivoPC.
  - The socket outlet must be easily accessible and near your VivoPC.
  - To disconnect your VivoPC from its main power supply, unplug your VivoPC from the power socket.
- 

**NOTE:**

Power adapter information:

- Input voltage: 100-240Vac
  - Input frequency: 50-60Hz
  - Rating output current: 3.42A (65W)
  - Rating output voltage: 19V
-

## Connect a display panel to your VivoPC

You can connect a display panel or projector to your VivoPC that has the following connectors:

- HDMI connector
- Mini DisplayPort
- VGA connector (use with a mini DisplayPort to VGA adapter)
- DVI connector (use with an HDMI to DVI adapter or VGA to DVI adapter)

---

**NOTE:**

- The HDMI to DVI adapter and VGA to DVI adapter are sold separately.
  - The availability of the mini DisplayPort to VGA adapter varies with your VivoPC package.
-



## To connect a display panel to your VivoPC:

Connect a display cable either to the HDMI port or the mini DisplayPort.

Connect display via HDMI port

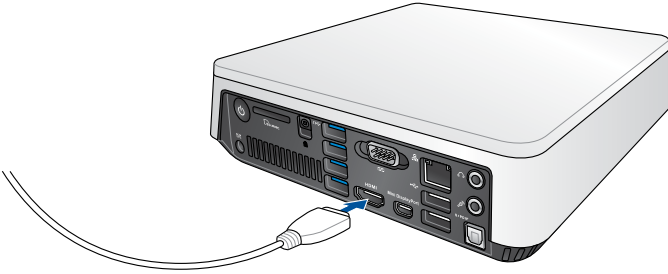

Connect display via mini DisplayPort

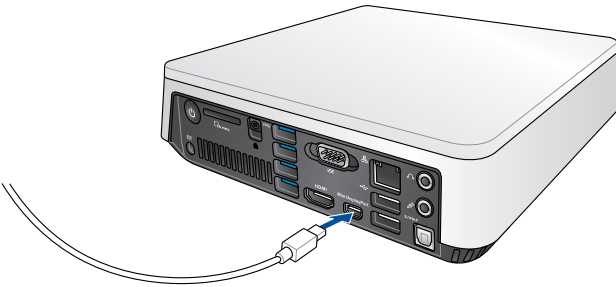

## Connect the USB cable from keyboard or mouse

You can connect generally any USB keyboard and mouse to your VivoPC. You can also connect a USB dongle for a wireless keyboard and mouse set.

### To connect a keyboard and mouse to your VivoPC:

Connect the USB cable from your keyboard and mouse to the USB 2.0 ports of your VivoPC.

Connect keyboard or mouse via USB 2.0 port

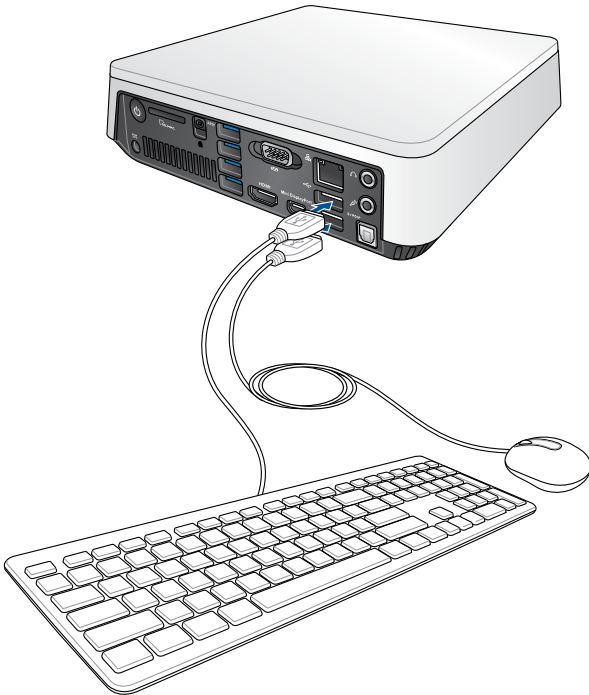

## Turn on your Vivo PC

Press the power button to turn on your VivoPC.

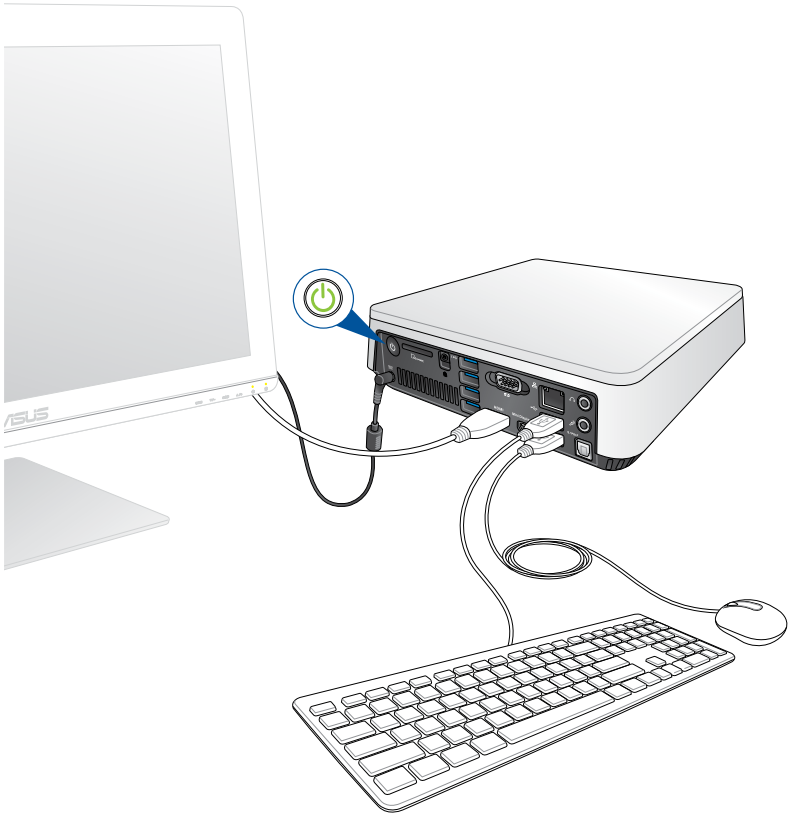

## Turning your VivoPC off

If your VivoPC is unresponsive, press and hold the power button for at least four (4) seconds until your VivoPC turns off.

## Putting your VivoPC to sleep

To put your VivoPC on Sleep mode, press the Power button once.

## Entering the BIOS Setup

BIOS (Basic Input and Output System) stores system hardware settings that are needed for system startup in the VivoPC.

In normal circumstances, the default BIOS settings apply to most conditions to ensure optimal performance. Do not change the default BIOS settings except in the following circumstances:

- An error message appears on the screen during the system bootup and requests you to run the BIOS Setup.
- You have installed a new system component that requires further BIOS settings or update.

---

**WARNING!** Inappropriate BIOS settings may result to instability or boot failure. We strongly recommend that you change the BIOS settings only with the help of a trained service personnel.

---

## Quickly enter the BIOS

To quickly enter the BIOS:

- Press the power button for at least four (4) seconds to shut down your VivoPC, then press the power button again to turn your VivoPC back on, then press <F2> or <Del> during POST.
- When your PC is off, disconnect the power cord from your VivoPC's power connector. Reconnect the power cable and press the power button to turn on your VivoPC. Press <F2> or <Del> during POST.

---

**NOTE:** POST (Power-On Self Test) is a series of software controlled diagnostic tests that run when you turn on your PC.

---



# 3

## ***Mounting your VivoPC***

# Installing your VivoPC to a VESA mount-compatible device

Your VivoPC package has a bundled VESA mounting plate that allows you to install your VivoPC to a VESA mount-compatible device.

## To install your VivoPC to a VESA mount-compatible device:

1. Place your VivoPC upside down on a flat and stable surface.
2. Attach the bundled two (2) 12mm screws into the screw holes at the bottom of your VivoPC.

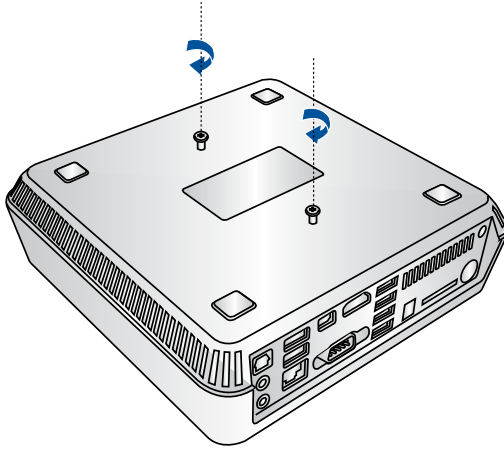

---

**WARNING!** Do not overtighten the screws as it may cause damage to your VivoPC.

---

3. Match and insert the four (4) 8mm screws into the four (4) rubber heads.

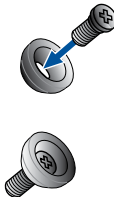



4. Remove the screw hole covers at the back of your VESA mount-compatible device, if any.
5. With the arrow on the VESA mounting plate pointing upward, align its screw holes to the screw holes of the VESA mount-compatible device.
6. Secure the VESA mounting plate to the VESA mount-compatible device using the screws with the rubber heads.

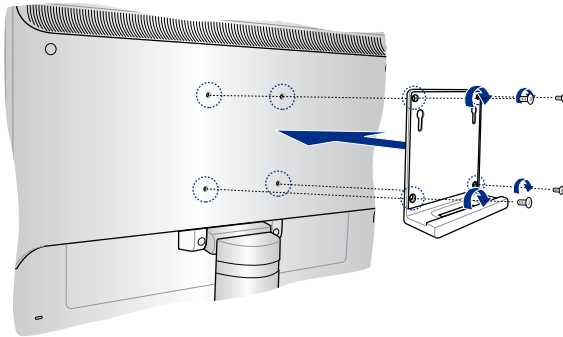

---

**WARNING!** Do not overtighten the screws as it may cause damage to your VESA mount-compatible device.

---

7. Insert the screws attached on the VivoPC to the mounting holes of the VESA mounting plate, then gently push the VivoPC down to secure it in place.

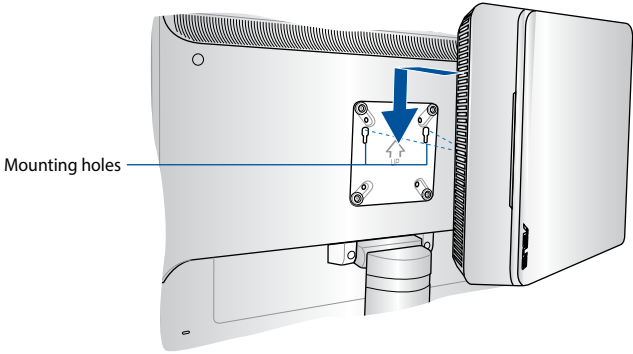

# ***Appendix***

## Safety information

Your VivoPC is designed and tested to meet the latest standards of safety for information technology equipment. However, to ensure your safety, it is important that you read the following safety instructions.

### Setting up your system

- Read and follow all instructions in the documentation before you operate your system.
- Do not use this product near water or a heated source.
- Set up the system on a stable surface.
- Openings on the chassis are for ventilation. Do not block or cover these openings. Make sure you leave plenty of space around the system for ventilation. Never insert objects of any kind into the ventilation openings.
- Use this product in environments with ambient temperatures between 0°C and 35°C.
- If you use an extension cord, make sure that the total ampere rating of the devices plugged into the extension cord does not exceed its ampere rating.

### Care during use

- Do not walk on the power cord or allow anything to rest on it.
- Do not spill water or any other liquids on your system.
- When the system is turned off, a small amount of electrical current still flows. Always unplug the power cord from the power outlets before cleaning the system.
- If you encounter the following technical problems with the product, unplug the power cord and contact a qualified service technician or your retailer.
  - The power cord or plug is damaged.
  - Liquid has been spilled into the system.
  - The system does not function properly even if you follow the operating instructions.
  - The system was dropped or the cabinet is damaged.
  - The system performance changes.

## Lithium-Ion Battery Warning

**CAUTION:** Danger of explosion if battery is incorrectly replaced. Replace only with the same or equivalent type recommended by the manufacturer. Dispose of used batteries according to the manufacturer's instructions.

## NO DISASSEMBLY

**The warranty does not apply to the products that have been disassembled by users**



**DO NOT** throw the VivoPC in municipal waste. This product has been designed to enable proper reuse of parts and recycling. This symbol of the crossed out wheeled bin indicates that the product (electrical, electronic equipment, and mercury-containing button cell battery) should not be placed in municipal waste. Check local technical support services for product recycling.

# Regulatory notices

## REACH

Complying with the REACH (Registration, Evaluation, Authorization, and Restriction of Chemicals) regulatory framework, we publish the chemical substances in our products at ASUS REACH website at <http://csr.asus.com/english/REACH.htm>

## ASUS Recycling/Takeback Services

ASUS recycling and takeback programs come from our commitment to the highest standards for protecting our environment. We believe in providing solutions for you to be able to responsibly recycle our products, batteries, other components, as well as the packaging materials. Please go to <http://csr.asus.com/english/Takeback.htm> for the detailed recycling information in different regions.

## COATING NOTICE

---

**IMPORTANT!** To provide electrical insulation and maintain electrical safety, a coating is applied to insulate the device except on the areas where the I/O ports are located.

---

## Federal Communications Commission Statement

This device complies with Part 15 of the FCC Rules. Operation is subject to the following two conditions:

- This device may not cause harmful interference, and
- This device must accept any interference received including interference that may cause undesired operation.

This equipment has been tested and found to comply with the limits for a Class B digital device, pursuant to Part 15 of the FCC Rules. These limits are designed to provide reasonable protection against harmful interference in a residential installation. This equipment generates, uses and can radiate radio frequency energy and, if not installed and used in accordance with manufacturer's instructions, may cause harmful interference to radio communications. However, there is no guarantee that interference will not occur in a particular installation. If this equipment does cause harmful interference to radio or television reception, which can be determined by turning

the equipment off and on, the user is encouraged to try to correct the interference by one or more of the following measures:

- Reorient or relocate the receiving antenna.
- Increase the separation between the equipment and receiver.
- Connect the equipment to an outlet on a circuit different from that to which the receiver is connected.
- Consult the dealer or an experienced radio/TV technician for help.

---

**CAUTION:** Any changes or modifications not expressly approved by the grantee of this device could void the user's authority to operate the equipment.

---

### **RF exposure warning**

This equipment must be installed and operated in accordance with provided instructions and the antenna(s) used for this transmitter must be installed to provide a separation distance of at least 20 cm from all persons and must not be co-located or operating in conjunction with any other antenna or transmitter. End-users and installers must be provide with antenna installation instructions and transmitter operating conditions for satisfying RF exposure compliance.

### **Declaration of Conformity (R&TTE directive 1999/5/EC)\***

*\* Replaced in 2017 by RED 2014/53/EU*

The following items were completed and are considered relevant and sufficient:

- Essential requirements as in [Article 3]
- Protection requirements for health and safety as in [Article 3.1a]
- Testing for electric safety according to [EN 60950]
- Protection requirements for electromagnetic compatibility in [Article 3.1b]
- Testing for electromagnetic compatibility according to [EN 301 489-1] & [EN 301 489-17]
- Effective use of the radio spectrum as in [Article 3.2]
- Radio test suites according to [EN 300 328-2]

## France Restricted Wireless Frequency Bands

Some areas of France have a restricted frequency band. The worst case maximum authorized power indoors are:

- 10mW for the entire 2.4 GHz band (2400 MHz–2483.5 MHz)
- 100mW for frequencies between 2446.5 MHz and 2483.5 MHz

---

**NOTE:** Channels 10 through 13 inclusive operate in the band 2446.6 MHz to 2483.5 MHz.

---

There are few possibilities for outdoor use: On private property or on the private property of public persons, use is subject to a preliminary authorization procedure by the Ministry of Defense, with maximum authorized power of 100mW in the 2446.5–2483.5 MHz band. Use outdoors on public property is not permitted.

In the departments listed below, for the entire 2.4 GHz band:

- Maximum authorized power indoors is 100mW
- Maximum authorized power outdoors is 10mW

Departments in which the use of the 2400–2483.5 MHz band is permitted with an EIRP of less than 100mW indoors and less than 10mW outdoors:

01	Ain	02	Aisne	03	Allier
05	Hautes Alpes	08	Ardennes	09	Ariège
11	Aude	12	Aveyron	16	Charente
24	Dordogne	25	Doubs	26	Drôme
32	Gers	36	Indre	37	Indre et Loire
41	Loir et Cher	45	Loiret	50	Manche
55	Meuse	58	Nièvre	59	Nord
60	Oise	61	Orne	63	Puy du Dôme
64	Pyrénées Atlantique	66	Pyrénées Orientales	67	Bas Rhin
70	Haute Saône	71	Saône et Loire	75	Paris
82	Tarn et Garonne	84	Vaucluse	88	Vosges
89	Yonne	90	Territoire de Belfort	94	Val de Marne



This requirement is likely to change over time, allowing you to use your wireless LAN card in more areas within France. Please check with ART for the latest information ([www.art-telecom.fr](http://www.art-telecom.fr))

---

**NOTE:** Your WLAN Card transmits less than 100mW, but more than 10mW.

---

### **Canadian Department of Communications Statement**

This digital apparatus does not exceed the Class B limits for radio noise emissions from digital apparatus set out in the Radio Interference Regulations of the Canadian Department of Communications.

This class B digital apparatus complies with Canadian ICES-003.

### **IC Radiation Exposure Statement for Canada**

This equipment complies with IC radiation exposure limits set forth for an uncontrolled environment. To maintain compliance with IC RF exposure compliance requirements, please avoid direct contact to the transmitting antenna during transmitting. End users must follow the specific operating instructions for satisfying RF exposure compliance.

Operation is subject to the following two conditions:

- This device may not cause interference and
- This device must accept any interference, including interference that may cause undesired operation of the device.

## CE Mark Warning



### CE marking for devices without wireless LAN/Bluetooth

The shipped version of this device complies with the requirements of the EMC directives 2004/108/EC (replaced in April 2016 by 2014/30/EU) "Electromagnetic compatibility" and 2006/95/EC (replaced in April 2016 by 2014/35/EU) "Low voltage directive".



### CE marking for devices with wireless LAN/ Bluetooth

This equipment complies with the requirements of Directive 1999/5/EC (replaced in 2017 by RED 2014/53/EU) of the European Parliament and Commission from 9 March, 1999 governing Radio and Telecommunications Equipment and mutual recognition of conformity.

## Wireless Operation Channel for Different Domains

N. America	2.412-2.462 GHz	Ch01 through CH11
Japan	2.412-2.484 GHz	Ch01 through Ch14
Europe ETSI	2.412-2.472 GHz	Ch01 through Ch13

## Regional notice for California

---

**WARNING!** This product may contain chemicals known to the State of California to cause cancer, birth defects or other reproductive harm. Wash hands after handling.

---

## ENERGY STAR complied product



ENERGY STAR is a joint program of the U.S. Environmental Protection Agency and the U.S. Department of Energy helping us all save money and protect the environment through energy efficient products and practices.

All ASUS products with the ENERGY STAR logo comply with the ENERGY STAR standard, and the power management feature is enabled by default. The monitor and computer are automatically set to sleep after 10 and 30 minutes of user inactivity. To wake your computer, click the mouse or press any key on the keyboard.

Please visit <http://www.energystar.gov/powermanagement> for detail information on power management and its benefits to the environment. In addition, please visit <http://www.energystar.gov> for detail information on the ENERGY STAR joint program.

---

**NOTE:** Energy Star is NOT supported on FreeDOS and Linux-based products.

---

# ASUS contact information

## ASUSTeK COMPUTER INC.

Address 4F, No. 150, Li-Te Rd., Peitou, Taipei 112, Taiwan  
Telephone +886-2-2894-3447  
Fax +886-2-2890-7798  
Web site <http://www.asus.com>

### Technical Support

Telephone +86-21-3842-9911  
Fax +86-21-5866-8722, ext. 9101#  
Online support <http://qr.asus.com/techserv>

## ASUS COMPUTER INTERNATIONAL (America)

Address 800 Corporate Way, Fremont, CA 94539, USA  
Telephone +1-510-739-3777  
Fax +1-510-608-4555  
Web site <http://usa.asus.com>

### Technical Support

Support fax +1-812-284-0883  
General support +1-812-282-2787  
Online support <http://qr.asus.com/techserv>

## ASUS COMPUTER GmbH (Germany and Austria)

Address Harkort Str. 21-23, D-40880 Ratingen, Germany  
Fax +49-2102-959931  
Web site <http://www.asus.com/de>  
Online contact <http://eu-rma.asus.com/sales>

### Technical Support

Telephone +49-2102-5789555  
Support Fax +49-2102-959911  
Online support <http://qr.asus.com/techserv>

<b>Manufacturer</b>	ASUSTeK Computer Inc.	
	Tel:	+886-2-2894-3447
	Address:	4F, No. 150, LI-TE RD., PEITOU, TAIPEI 112, TAIWAN
<b>Authorised representative in Europe</b>	ASUSTeK Computer GmbH	
	Address:	HARKORT STR. 21-23, 40880 RATINGEN, GERMANY

# DECLARATION OF CONFORMITY

Per FCC Part 2 Section 2. 1077(a)



**Responsible Party Name:** **Asus Computer International**

**Address:** **800 Corporate Way, Fremont, CA 94539.**

**Phone/Fax No:** **(510)739-3777/(510)608-4555**

hereby declares that the product

**Product Name :** **VivoPC**

**Model Number :** **VC60,VC60V**

Conforms to the following specifications:

FCC Part 15, Subpart B, Unintentional Radiators

## Supplementary Information:

This device complies with part 15 of the FCC Rules. Operation is subject to the following two conditions: (1) This device may not cause harmful interference, and (2) this device must accept any interference received, including interference that may cause undesired operation.

Representative Person's Name : Steve Chang / President

A handwritten signature in blue ink that reads "Steve Chang". The signature is written in a cursive style and is placed over a light blue rectangular background.

Signature :

Date : Aug. 23, 2013

Ver. 120601



## Free Manuals Download Website

<http://myh66.com>

<http://usermanuals.us>

<http://www.somanuals.com>

<http://www.4manuals.cc>

<http://www.manual-lib.com>

<http://www.404manual.com>

<http://www.luxmanual.com>

<http://aubethermostatmanual.com>

Golf course search by state

<http://golfingnear.com>

Email search by domain

<http://emailbydomain.com>

Auto manuals search

<http://auto.somanuals.com>

TV manuals search

<http://tv.somanuals.com>