

brother®

DSmobile 700D



**Scanner
User's Guide**

brother®
at your side

Trademarks

Adobe® and the Adobe logo, Acrobat®, Photoshop® and Reader® are registered trademarks of Adobe Systems Inc.

Brother® is a registered trademark of Brother Industries, Ltd.

Apple®, Macintosh®, Mac®, the Mac logo, Mac OS®, Lion®, Snow Leopard®, Leopard®, Tiger® and Panther® are trademarks of Apple Computer, Inc., registered in the United States and other countries.

PageManager® is a registered trademark of NewSoft America, Inc.

Post-It® is a registered trademark of 3M Company.

Windex® is a registered trademark of S.C. Johnson Company.





Microsoft®, Windows® and the Windows logo are trademarks, or registered trademarks of Microsoft Corporation in the United States and other countries. Windows Vista® is either a registered trademark or trademark of Microsoft Corporation in the United States and/or other countries. The official name for Windows is the Microsoft Windows Operating System.





















Wite-Out® is a registered trademark of Wite-Out Products, Inc.





All other trademarks are either registered trademarks or trademarks of their respective owners in the United States and other countries.





Product Safety Guide

Symbols and conventions used in this documentation

 Warning	WARNING indicates a potentially hazardous situation which, if not avoided, could result in death or serious injuries.
 Caution	CAUTION indicates a potentially hazardous situation which, if not avoided, may result in minor or moderate injuries.
Important	Important indicates a potentially hazardous situation which, if not avoided, may result in damage to property or loss of product functionality.
	Hazard notice: "Be careful."
	Restricted conduct.
	Proper conduct: "What you have to do."

 Warning	
 	■ Store the USB cable bundled out of the reach of children. This may result in injury.
  	■ Do not disassemble or modify the unit. This may result in a fire, electric shock, or device failure. Contact the store where this unit was purchased to inspect, adjust, and repair the internal components of the unit. (There will be a charge for repairs even when conducted within the warranty period if the unit fails due to the disassembly or modifications by the customer.)
  	■ Do not use the device in abnormal conditions, i.e. appearance of smoke, strange smell, odd noise, etc. This may result in a fire, burns, or device failure. Turn the power switch off immediately, remove the USB cable from the outlet. Contact the store where this unit was purchased.
  	■ In the event that foreign material enters the unit, turn the power switch off immediately, remove the USB cable. Contact the store where this unit was purchased. This may result in a fire, electric shock, or device failure.
 	■ Do not spill drinks, i.e. coffee, juice, etc., or water on the device. Do not use the device in places where water may splash the device. This may result in igniting a fire, electric shock, or device failure. In such a event turn the power switch off immediately, remove the USB cable from the outlet. Contact the store where this unit was purchased.
 	■ Keep plastic bags bundled out of the reach of children or throw them away to avoid the danger of suffocation.
 	■ In the event that lightning strikes, do not touch the unit for fear of electric shock.
 	■ Do not place near open flames or heater. This may result in a fire or device failure.

⚠ Caution	
	<ul style="list-style-type: none"> Strong jolts, i.e. drop, being stepped on, etc., may damage the unit. This may result in injury. In the event that the unit is damaged, turn the power switch off immediately, remove the USB cable from the outlet. Contact the store where this unit was purchased.
	<ul style="list-style-type: none"> Do not locate the device on rickety or aslope tables. Do not locate the device on unstable surface. The device may fall down and this may result in injury.
	<ul style="list-style-type: none"> Do not place heavy objects on the unit. It may cause unbalance and the device may fall down. This may result in injury.
	<ul style="list-style-type: none"> Do not use an organic solvent, i.e. flammable gas, alcohol, etc., when cleaning the device. Do not use them near the device. This may result in a fire or device failure.
	<ul style="list-style-type: none"> Be cautious when you handle paper. Edges of paper may cut your hands.

Important	
	<ul style="list-style-type: none"> Do not leave the device at places exposed to direct sunlight and places near open flames or heater with extremely high or low temperature. Do not use and store the device in locations of much humidity and dust.
	<ul style="list-style-type: none"> Do not conduct any operations not instructed in this guide. This may result in injury or device failure.
	<ul style="list-style-type: none"> Do not use an organic solvents, i.e. paint thinner, benzene, alcohol, etc., when cleaning the unit. This may damage the finish on the surface or may peel the paint resulting in damage. Wipe away any dirt on the unit using a soft, dry cloth.
	<ul style="list-style-type: none"> Do not use any USB cables except the USB cable bundled.
	<ul style="list-style-type: none"> Do not use the device in locations where temperature changes are extreme. The resulting condensation may result in device failure or malfunction. In the event of condensation, use only after drying the device naturally.

Product Warranty Information

Brother™ One-Year Limited Warranty and Replacement Service Scanner (USA Only)

Who is covered:

- This limited warranty (“warranty”) is given only to the original end-use/retail purchaser (referred to in this warranty as “Original Purchaser”) of the accompanying Scanner, consumables and accessories (collectively referred to in this warranty as “this Scanner”).
- If you purchased a Scanner from someone other than an authorized Brother reseller in the United States or if the Scanner was used (including but not limited to floor models or refurbished Scanners by someone other than Brother), prior to your purchase you are not the Original Purchaser and the Scanner that you purchased is not covered by this warranty.

What is covered:

- This Scanner includes a Scanner and may include Consumable and Accessory Items. Consumable and Accessory Items may include but are not limited to USB Cable, photo sleeves, calibration sheets and cleaning sheets.
- Except as otherwise provided herein, Brother warrants that the Scanner and the accompanying Consumable and Accessory Items will be free from defects in materials and workmanship, when used under normal conditions.
- This warranty applies only to Scanners purchased and used in the United States. For Scanners purchased in, but used outside, the United States, this warranty covers only warranty service within the United States (and does not include shipping outside the United States).

What is the length of the Warranty Periods:

- Scanner: one year from the original purchase date.
- Accompanying Consumable and Accessory Items: 90 days from the original purchase date or the rated life of consumable, whichever comes first.

What is NOT covered:

This warranty does not cover:

- 1 Physical damage to this Scanner;
- 2 Damage caused by improper installation, improper or abnormal use, misuse, neglect or accident (including but not limited to transporting this Scanner without the proper preparation and/or packaging);
- 3 Damage caused by another device or software used with this Scanner (including but not limited to damage resulting from use of non Brother™-brand parts and Consumable and Accessory Items);
- 4 Consumable and Accessory Items that expired in accordance with a rated life;
- 5 Problems arising from other than defects in materials or workmanship.
- 6 Normal Periodic Maintenance Items beyond the rated life, such as Separation Pad and Pick-up Roller if beyond the rated life.

This limited warranty is VOID if this Scanner has been altered or modified in any way (including but not limited to attempted warranty repair without authorization from Brother and/or alteration/removal of the serial number).

What to do if you think your Scanner is eligible for warranty service:

Report your issue to our Customer Service Hotline at 1-877-BROTHER (1-877-276-8437) **within the applicable warranty period**. Supply Brother with a copy of your dated bill of sale showing that this Scanner was purchased within the U.S.

What Brother will ask you to do:

After contacting Brother you will be required to send the Scanner properly packaged, freight prepaid, to Brother together with a photocopy of your bill of sale. Brother **will provide a Return Authorization Number (i.e RA#) that must be written on the outside of the carton that contains your Scanner and instruction to where you should return your Scanner. You are responsible for the cost of shipping, packing the Scanner, and insurance (if you desire). You are also responsible for loss or damage to this Scanner in shipping.**

What Brother will do:

If the problem reported concerning your Scanner and/or accompanying Consumable and Accessory Items is covered by this warranty and if you first reported the problem to Brother within the applicable warranty period, Brother will repair or replace the Scanner and/or accompanying Consumable and Accessory Items at no charge to you for parts or labor. The decision as to whether to repair or replace the Machine and/or accompanying Consumable and Accessory Items is made by Brother in its sole discretion. Brother reserves the right to supply a refurbished or remanufactured replacement Scanner and/or accompanying Consumable and Accessory Items and use refurbished parts provided such replacement Scanners conform to the manufacturer's specifications for new Scanner/parts. The repaired or replacement Scanner and/or accompanying Consumable and Accessory Items will be returned to you freight prepaid.

If the Scanner and/or accompanying Consumable and Accessory Items are not covered by this warranty (either stage), you will be charged for shipping the Scanner and/or accompanying Consumable and Accessory Items back to you and charged for any service and/or replacement parts/Scanners at Brother's then current rates.

The foregoing are your sole (i.e., only) and exclusive remedies under this warranty.

What happens when Brother elects to replace your Scanner:

Brother will send to you a replacement Scanner shipped for receipt within two business days, with the understanding that you will, after receipt of the replacement Scanner, supply the required proof of purchase information, together with the Scanner that Brother agreed to replace. You are then expected to pack the Scanner that Brother agreed to replace in the package from the replacement Scanner and return it to Brother using the pre-paid freight bill supplied by Brother in accordance with the instructions provided by Brother. The replacement Scanner you receive (even if refurbished or remanufactured) will be covered for the balance of the limited warranty period remaining on the original Scanner, plus an additional thirty (30) days. You will keep the replacement Scanner that is sent to you and your original Scanner shall become the property of Brother. Since you will be in possession of two machines, Brother will require that you provide a valid major credit card number. Brother will issue a hold against the credit card account number that you provide until Brother receives your original Scanner and determines that your original Scanner is entitled to warranty coverage. Your credit card will be charged up to the cost of a new Scanner only if: (i) you do not return your original Scanner to Brother within five (5) business days; (ii) the problems with your original Scanner are not covered by the limited warranty; (iii) the proper packaging instructions are not followed and has caused damage to the Scanner; or (iv) the warranty period on your original Scanner has expired or has not been sufficiently validated with a copy of the proof of purchase (bill of sale). **Retain your original Accessory Items and a copy of the return freight bill, signed by the courier.**

Limitations:

Brother is not responsible for damage to or loss of any equipment, media, programs or data related to the use of this Scanner. Except for the repair or replacement as described above, Brother shall not be liable for any direct, indirect, incidental or consequential damages or specific relief. Because some states do not allow the exclusion or limitation of consequential or incidental damages, the above limitation may not apply to you.

THIS WARRANTY IS GIVEN IN LIEU OF ALL OTHER WARRANTIES, WRITTEN OR ORAL, WHETHER EXPRESSED BY AFFIRMATION, PROMISE, DESCRIPTION, DRAWING, MODEL OR SAMPLE. ANY AND ALL WARRANTIES OTHER THAN THIS ONE, WHETHER EXPRESS OR IMPLIED, INCLUDING IMPLIED WARRANTIES OF MERCHANTABILITY AND FITNESS FOR A PARTICULAR PURPOSE, ARE HEREBY DISCLAIMED.

- This Limited Warranty is the only warranty that Brother is giving for this Scanner. It is the *final expression and the exclusive and only statement* of Brother's obligations to you. It replaces all other agreements and understandings that you may have with Brother or its representatives.
- This warranty gives you certain rights and you may also have other rights that may vary from state to state.
- This Limited Warranty (and Brother's obligation to you) may not be changed in any way unless you and Brother sign the same piece of paper in which we (1) refer to this Scanner and your bill of sale date, (2) describe the change to this warranty and (3) agree to make that change.

Important: *We recommend that you keep all original packing materials, in the event that you ship this Scanner.*

© 2012 Brother International Corporation

Brother Product Registration

First Name Last Name

Company Name

Address

City State Zip Code

Telephone Number Model Number

Fax Number Serial Number

Store Where Purchased Purchase Date (MM - DD - YYYY)

E-Mail Address

1. How did you first become aware of this Brother product?
(Please **Write** in ONE Choice in the box to the left)

- | | |
|-------------------------------|---------------------------|
| A. Magazine Advertisement | F. Friend / Relative |
| B. Newspaper | G. Dealer / Store Display |
| C. TV Advertisement | H. Business Associate |
| D. Radio Advertisement | I. Brochure |
| E. Brother Website / Internet | J. Other |



6. Which best describes your occupation?
(Please **Write** in ONE Choice in the box to the left)

- | | |
|-----------------------------|------------------------|
| A. Business Owner | G. Sales / Marketing |
| B. Clerical / Service | H. Student |
| C. Homemaker | I. Teacher / Professor |
| D. Management | J. Tradesman / Laborer |
| E. Professional / Technical | K. Other |
| F. Retired | |

2. What other Brother products do you own or have you purchased in the past?
(Please **Write** in top 3 choices in the boxes to the left)

- | | |
|-----------------------|-------------------|
| A. Embroidery Machine | F. Printer |
| B. Fax Machine | G. Sewing Machine |
| C. Label Maker | H. Stamp Creator |
| D. Laminator | I. Typewriter |
| E. Multifunction | |

7. Which Hobbies do you enjoy?
(Please **Write** in top 3 choices in the boxes to the left)

- | | | |
|--------------------|------------------|-----------|
| A. Arts / Antiques | F. Gardening | K. Sewing |
| B. Cooking | G. Internet / PC | L. Sports |
| C. Crafts | H. Music | M. Travel |
| D. Decorating | I. Photography | N. Other |
| E. Electronics | J. Reading | |

3. Which of the following factors influenced your decision to buy this product?
(Please **Write** in top 3 choices in the boxes to the left)

- | | |
|-------------------------|--------------------------|
| A. Advertisement | G. Size / Weight |
| B. Brother's Reputation | H. Store Flyer / Display |
| C. Ease of Use | I. Styling / Appearance |
| D. Features | J. Quality / Reliability |
| E. Friend / Relative | K. Warranty |
| F. Price / Value | L. Other |

8. Which of the following magazines / publications do you read regularly?
(Please **Write** in top 3 choices in the boxes to the left)

- | | |
|------------------------|--------------------|
| A. Business Week | F. Newsweek / Time |
| B. Computer Shopper | G. PC Magazine |
| C. Consumer Reports | H. PC World |
| D. Forbes / Fortune | I. C/Net (Online) |
| E. Macworld / Mac Home | J. Other |

4. Please Select the Primary use for this product?
(Please **Write** in ONE Choice in the box to the left)

- | | |
|-----------------------------------|-------------------|
| A. Business Use (1 - 5 Employees) | F. (500 and Over) |
| B. (6 - 19 Employees) | G. Personal Use |
| C. (20 - 49 Employees) | H. Student Use |
| D. (50 - 99 Employees) | I. Other |
| E. (100 - 499 Employees) | |

5. Which of the following best matches your age group?
(Please **Write** in ONE Choice in the box to the left)

- | | |
|------------|----------------|
| A. 18 - 24 | D. 46 - 55 |
| B. 25 - 35 | E. 56 - 64 |
| C. 36 - 45 | F. 65 and over |

Would you like to receive Brother information regarding?

- | | | |
|--|---------------------------|--------------------------|
| Special offers, rebates and discounts? | <input type="radio"/> YES | <input type="radio"/> NO |
| New software, drivers and service related updates? | <input type="radio"/> YES | <input type="radio"/> NO |
| Newsletters and surveys? | <input type="radio"/> YES | <input type="radio"/> NO |
| Website updates and enhancements? | <input type="radio"/> YES | <input type="radio"/> NO |

Please make sure you **FILL** in your choices completely.

To view our privacy policy, go to <http://www.brother.com/registration/>

Register On-Line at: <http://www.brother.com/registration/> Or Fax this side to 1-877-518-5702

Thank you for choosing a Brother product.

Register On-Line: This is the fastest, most efficient way to register your new product.

(USA Customers Only)

While there, click on our contest logo for a chance to win \$1,000!
See web-site for details. U.S.A. customers only.



<http://www.brother.com/registration/>

Register by Fax: Simply fill out the reverse side of this page and fax it to us toll-free at 1-877-518-5702.

Register by Mail: You may also register by mail by completing the back of this form and mailing it to:

**Brother International Corporation
Warranty Claims Department
PO BOX 341332
Bartlett TN 38184-9804**

Why Register?

Purchase Confirmation: Your product will be officially registered with Brother International Corporation.

Proof of Ownership: In case of an insurance loss due to such causes as fire, flood, theft, etc.

Information Response: If you choose, Brother will send you notifications of updates, enhancements and special offers.

For More Information: Should you need additional information regarding your Brother product or if you need to locate your nearest Brother Authorized Service Center, visit our website at: <http://www.brother-usa.com>

For a complete list of supplies and accessories available for your product, visit us online at <http://www.brothermall.com/> or call us toll-free at 1-877-552-MALL (1-877-552-6255).

About Your Warranty: The warranty of your Brother product is a Limited Warranty. Please review your warranty statement for complete details.

Extended Manufacturer's warranty Agreement: To further protect your Brother product after the initial warranty period expires, Brother International Corporation offers a Extended Manufacturer's warranty Agreement. Please visit our website at <http://www.brother-usa.com/ema> for extended warranty purchasing information.

Important Information Sources At-A-Glance:

Customer Service: 1-877-BROTHER (1-877-276-8437)

World Wide Web: <http://www.brother-usa.com>

Supplies and Accessories: <http://www.brothermall.com/>
or 1-877-552-MALL (1-877-552-6255)
1-800-947-1445 (fax)

Register online at: <http://www.brother.com/registration/>

Or fax the reverse side to: 1-877-518-5702

View our privacy policy: <http://www.brother.com/registration/>

brother.
at your side



LD6351001①
Printed in China

BROTHER MOBILE SCANNER LIMITED WARRANTY

Pursuant to the limited warranty of 1 year from the date of purchase for labour and parts, Brother International Corporation (Canada) Ltd. ("Brother") will repair or replace (at Brother's sole discretion) this Mobile scanner machine free of charge if defective in material or workmanship. This warranty applies only to products purchased and used in Canada. This limited Warranty does not include cleaning, consumables (including, without limitation, scanner heads and paper feed rollers) or damage caused by accident, neglect, misuse or improper installation or operation, any damage caused from service, maintenance, modifications, or tampering by anyone other than a Brother Authorized Service Representative, or if shipped out of the country. This limited warranty ceases when this machine is rented, sold, or otherwise disposed of. Operation of the Mobile scanner machine in excess of the specifications or with the Serial Number or Rating Label removed shall be deemed abuse and all repairs thereafter shall be the sole liability of the end-user/purchaser. In order to obtain warranty service please call 1-877-Brother (276-8437).

When shipping or transporting your Mobile scanner machine, please refer to your Operation Manual for the proper packaging procedures.

Improper packaging may cause severe damage to the machine during shipping and will void the warranty.

BROTHER DISCLAIMS ALL OTHER WARRANTIES EXPRESSED OR IMPLIED INCLUDING, WITHOUT LIMITATIONS, ANY IMPLIED WARRANTIES OF MERCHANTABILITY OR FITNESS FOR A PARTICULAR PURPOSE, EXCEPT TO THE EXTENT THAT ANY WARRANTIES IMPLIED BY LAW CANNOT BE VALIDLY WAIVED.

No oral or written information, advice or representation provided by Brother, its Authorized Service Centres, Distributors, Dealers, Agents or employees, shall create another warranty or modify this warranty. The warranty states Brother's entire liability and your exclusive remedy against Brother for any failure of the Mobile scanner machine to operate properly.

Neither Brother nor anyone else involved in the development, production, or delivery of this Mobile scanner machine shall be liable for any indirect, incidental, special, consequential, exemplary, or punitive damages, including lost profits, arising from the use of or inability to use the product, even if advised by the end user/purchaser of the possibility of such damages. Since some Provinces do not allow the above limitation of liability, such limitation, may not apply to you.

This Limited Warranty gives you specific legal rights and you may also have other rights which vary from Province to Province.

brother[®]
at your side

GARANTIE LIMITÉE POUR LE SCANNER PORTABLE DE BROTHER

Dans le cadre de la présente garantie limitée de 1 (un) an à compter de la date d'achat pour la main-d'œuvre et les pièces détachées, La Corporation Internationale Brother (Canada) Ltée (« Brother ») réparera ou remplacera (à la discrétion de Brother) le scanner portable sans frais si elle présente des défauts de matériaux ou de fabrication. Cette garantie s'applique seulement aux produits achetés et utilisés au Canada. Cette garantie limitée exclut le nettoyage, les produits consommables (y compris, mais non de façon limitative les têtes du scanner et les rouleaux d'alimentation du papier) ou les dommages provoqués par suite d'accidents, de négligence, de mauvaise utilisation, d'installation ou de fonctionnement non conforme, ainsi que les dommages résultant de réparations, de l'entretien, de modifications ou de tentatives de réparations effectuées par toute personne non agréée par Brother ou si l'appareil est expédié hors du pays. La garantie s'annule aussitôt que l'appareil est loué, vendu ou mis hors service. L'utilisation du scanner portable de façon non conforme à ses spécifications ou le retrait du numéro de série ou de la fiche signalétique sera considéré comme abusif et la responsabilité de toutes les réparations qui s'ensuivront incombera entièrement à l'acheteur/utilisateur final. Afin d'obtenir le service sur garantie, veuillez téléphoner au 1 877 Brother (276-8437).

Avant d'expédier ou de transporter le scanner portable, veuillez vous référer au Guide de l'utilisateur pour connaître le mode d'emballage approprié.

Les dommages causés à l'appareil attribuables à un mauvais emballage annuleront la garantie.

BROTHER N'ACCORDE AUCUNE AUTRE GARANTIE EXPRESSE OU IMPLICITE Y COMPRIS, MAIS DE FAÇON NON LIMITATIVE, AUCUNE GARANTIE DE QUALITÉ MARCHANDE OU D'ADAPTATION À UN USAGE PARTICULIER, SAUF DANS LES CAS OÙ DE TELLES GARANTIES IMPLICITES NE PEUVENT ÊTRE EXCLUES EN RAISON DE LA LÉGISLATION EN VIGUEUR.

Aucune information, directive ou représentation verbale ou écrite de Brother, ses centres de service autorisés, distributeurs, concessionnaires, agents ou employés ne pourra modifier la présente garantie ou en créer une différente. Dans le cas d'une défaillance quelconque du scanner portable, Brother n'a pas d'autre obligation et le client n'a pas d'autres recours que ceux stipulés dans la présente garantie.

Brother, ni personne d'autre impliqué dans la mise au point, la production ou la livraison du scanner portable ne sera tenue responsable pour dommages directs, indirects, fortuits, particuliers ou exemplaires, y compris tout manque à gagner résultant de l'utilisation ou de l'impossibilité d'utiliser le produit, même si l'acheteur/utilisateur informe Brother de la possibilité de tels dommages. Certaines provinces ne reconnaissant pas l'exclusion de tels dommages, celle-ci pourrait ne pas s'appliquer à votre cas particulier.

La présente garantie limitée vous accorde des droits légaux spécifiques : il se peut que vous jouissiez également d'autres droits qui varient d'une province à l'autre.

brother[®]
at your side

www.brother.ca

ENREGISTREZ VOTRE PRODUIT EN LIGNE FACILEMENT ET RAPIDEMENT!

Veillez compléter et retourner cette carte dans les 10 jours afin de confirmer la date d'achat et l'information sur le modèle de votre nouvel appareil Brother. Vous n'êtes pas tenu de répondre à toutes les questions. La réponse à toutes les questions n'est pas nécessaire pour la validité de la garantie.

Gardez votre coupon de caisse; il sera requis pour fins de réparations sous garantie.

ENREGISTREMENT DU PRODUIT

brother®
at your side

brother®
at your side

PRODUCT REGISTRATION

Please complete and return this card in the next 10 days to confirm the date of purchase and model information for your new Brother product. Please feel free to ignore any questions that you would prefer not to answer – completion is not necessary for your guarantee.

Keep your sales receipt as it is always required to obtain warranty service.

REGISTER YOUR PRODUCT ONLINE QUICKLY AND EASILY!

www.brother.ca



REGISTER ONLINE!
ENREGISTREZ-VOUS EN LIGNE!
www.brother.ca

First Name / Prénom*	
Last Name / Nom*	
Company / Compagnie	
Title / Titre	
Address / Adresse *	
Address #2 / Adresse #2	
City / Ville*	
Postal Code / Code postal*	
Telephone / Téléphone*	
Extension / Poste	
Fax / Télécopieur	
E-mail Address / Courriel	
Date Purchased (MM/DD/YYYY format) / Acheté le* (format JJ/MM/AAAA)	
Purchased From / Acheté chez*	
Product Category / Catégorie de produit*	
Model / Modèle*	
Serial Number / No de série*	

Fields marked with a * are required. / Les champs indiqués * sont requis.

HELP US TO KNOW AND SERVE YOU BETTER! / AIDEZ-NOUS À VOUS CONNAÎTRE ET MIEUX VOUS SERVIR!

- EN Please indicate primary use of this product (select one)**
FR Pourriez-vous nous indiquer l'usage principal de ce produit : (un choix)

<input type="checkbox"/> At home professional use	<input type="checkbox"/> Usage professionnel à la maison
<input type="checkbox"/> Personal use	<input type="checkbox"/> Usage personnel
<input type="checkbox"/> Government / Institutional use	<input type="checkbox"/> Usage gouvernemental/institutionnel
<input type="checkbox"/> Small office (10 employees or less)	<input type="checkbox"/> Petit bureau (moins de 10 employés)
<input type="checkbox"/> Small corporation (11-99 employees)	<input type="checkbox"/> Petite entreprise (11-99 employés)
<input type="checkbox"/> Large corporation (100 employees or more)	<input type="checkbox"/> Grande entreprise (100 employés et plus)
- EN How did you first become aware of this product? (select one)**
FR Comment avez-vous eu connaissance de ce produit ? (un choix)

<input type="checkbox"/> Friend / Relative	<input type="checkbox"/> Ami / parent
<input type="checkbox"/> Direct Mail	<input type="checkbox"/> Message publiposté
<input type="checkbox"/> Trade Magazine	<input type="checkbox"/> Revue commerciale
<input type="checkbox"/> Radio Ad	<input type="checkbox"/> Annonce à la radio
<input type="checkbox"/> Dealer / Salesperson	<input type="checkbox"/> Concessionnaire / Représentant des ventes
<input type="checkbox"/> Newspaper ad	<input type="checkbox"/> Annonce dans le journal
<input type="checkbox"/> Business Magazine	<input type="checkbox"/> Revue d'affaires
<input type="checkbox"/> TV Ad	<input type="checkbox"/> Annonce télévisée
<input type="checkbox"/> Retail Flyer	<input type="checkbox"/> Pamphlet / publicité
<input type="checkbox"/> Consumer Report	<input type="checkbox"/> Rapport destiné aux consommateurs
<input type="checkbox"/> Point of Purchase Display	<input type="checkbox"/> Étalage au point de vente
- EN What products are you planning to purchase in the next 12 months?(select all that apply)**
FR Quels sont les produits que vous prévoyez acheter dans les 12 prochains mois ? (cochez toutes les cases appropriées)

<input type="checkbox"/> Fax	<input type="checkbox"/> Télécopieur
<input type="checkbox"/> All in One Machine	<input type="checkbox"/> Tout-en-un
<input type="checkbox"/> Sewing Machine	<input type="checkbox"/> Machine à coudre
<input type="checkbox"/> Printer	<input type="checkbox"/> Imprimante
<input type="checkbox"/> Labelling Machine	<input type="checkbox"/> Système d'étiquetage
- EN Which of the following factors influenced your decision to purchase this product? (select all that apply)**
FR Quels sont les facteurs de décision qui ont influencé votre achat ? (cochez toutes les cases appropriées)

<input type="checkbox"/> Design / Appearance	<input type="checkbox"/> Style / aspect
<input type="checkbox"/> Quality / Reliability	<input type="checkbox"/> Qualité / fiabilité
<input type="checkbox"/> Size / Weight	<input type="checkbox"/> Taille / poids
<input type="checkbox"/> Price / Value	<input type="checkbox"/> Rapport qualité / prix
<input type="checkbox"/> Features	<input type="checkbox"/> Fonctions spéciales
<input type="checkbox"/> Salesperson's Recommendation	<input type="checkbox"/> Recommandation du vendeur
<input type="checkbox"/> Other Person's Recommendation	<input type="checkbox"/> Autre recommandation
<input type="checkbox"/> In-Store Display	<input type="checkbox"/> Étalage en magasin
<input type="checkbox"/> Brother Advertisement	<input type="checkbox"/> Annonce Brother
<input type="checkbox"/> Product Review	

Please send other correspondence to:
Customer Service

Veillez expédier toute
autre correspondance à :
Service à la clientèle

Brother International Corporation (Canada) Ltd.
1 Rue Hôtel de Ville
Dollard-Des-Ormeaux, QC H9B 3H6

POSTAL STAMP
TIMBRE POSTAL

brother®

**Brother Product Registration
c/o Redemco
P.O. Box 128
Longueuil, QC
Canada J4K 4X8**

brother®

- EN** I wish to receive information from Brother regarding new product introductions, promotions or special announcements.
FR Je souhaite recevoir de l'information concernant Brother et ses lancements de nouveaux produits, promotions ou annonces spéciales.
- EN** I wish to receive information from Brother regarding driver and software updates.
FR Je souhaite recevoir de l'information concernant les mises à jour de pilotes ou de logiciels des produits Brother.
- EN** I wish to be contacted regarding service quality by Brother or any 3rd party.
FR Je souhaite que Brother ou une tierce partie me contacte concernant la qualité de ses services.

**Thank you for registering your Brother product! Any questions?
Please call us at 1-877-BROTHER or go to www.brother.ca**

**Merci d'avoir enregistré votre produit Brother! Avez-vous des questions ?
Appelez-nous au 1-877-BROTHER ou visitez www.brother.ca**

Customer Service (USA only)

FREE INFORMATION BY E-MAIL & WEB

Visit our Web site at <http://www.brother-usa.com>. Search for the “DSmobile 700D” scanners where you can access:

- Features, Specifications, and Compatibility (Windows® & Mac®)
- FAQs
- Warranty information
- Brochures
- Manuals
- Product Software download information.

CUSTOMER SERVICE (USA only)

Brother recommends that you go to <http://www.brother-usa.com>, click on “Support-Contact Customer Service”, and use the web contact form to send your question to Customer Service. Either method will send your request immediately to customer service personnel.

Telephone Contact:	1-877-BROTHER (1-877-276-8437)
World Wide Web:	www.brother-usa.com
Supplies and Accessories:	www.brothermall.com or 1-888-879-3232
Product Registration:	www.registermybrother.com
View Our Privacy Policy:	www.registermybrother.com

What's Included with This Package

User Manual
(Printable from DVD only)



Installation DVD



Soft Carrying Bag



Model DS700D
DSmobile® 700D Scanner



Plastic Feeding Sheets (2)

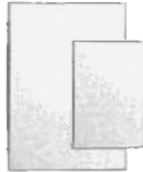

Kit Contents List



USB Cable (6ft.)



Cleaning Sheet

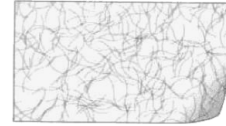

Calibration Sheets (2)

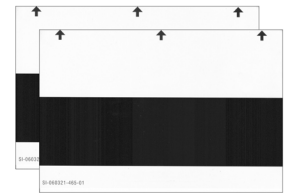

Product Registration Card

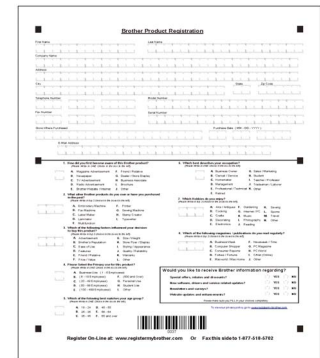

Regulatory Compliance Statement Sheet



Welcome — Introduction to Your DSmobile® Scanner

Congratulations on purchasing a DSmobile 700D document scanner!

We have designed this product to provide you with a simple but effective tool to capture, manage, and archive documents of many types. We encourage you to read this User's Guide carefully.

Your DSmobile 700D scanner Installation DVD comes with WHQL certified and/or tested drivers for Windows® 7, Windows Vista® and Windows® XP operating systems. The Windows® 7 and Windows Vista® drivers work with both 32-bit and 64-bit operating systems. This product features TWAIN 1.9 compatible and Windows® Imaging Acquisition (WIA) drivers that will work with any of your TWAIN/WIA-compliant imaging applications. These TWAIN/WIA drivers are automatically installed for the DSmobile 700D when you load the Windows® drivers. If you experience any difficulty with any of these drivers, please check our website <http://www.brother.com> to verify that you are using the latest version.

For your convenience, a version of PageManager® is included on the Installation DVD. This software program allows you to scan and organize your digital files with the ability to view, edit, send, and save them. It will also output various selectable file formats. Note that DSmobileSCAN II software outputs Adobe® PDF files as well as .JPG and .TIF files. Please follow the on-screen instructions. For help with how to use this software, please use the help facility within PageManager®.

Scanning using Apple® Mac OS® X is supported by a Mac® TWAIN driver using the “Image Capture” software provided on the Macintosh®. This driver is included in the software DVD but must be manually installed. You can also download the DSmobile 700D Mac OS® X driver from <http://www.brother.com>.

In the event that you have previously installed a driver for the DS700D (Windows: Ver B1.0.6 or below, Macintosh: Ver B1.2.4 or below) and DSmobileSCANII (Ver 2.0.12 or below), your new scanner may not be compatible with this driver and software. Brother recommends installing the latest driver and software from the DVD that came with your scanner or download it from the web at <http://solutions.brother.com>.

Removing the holding tape

Remove the holding tape (①).

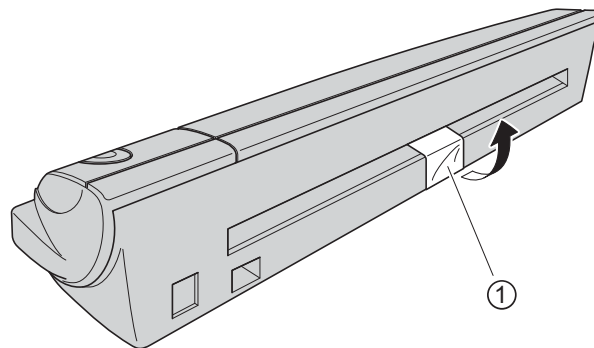

Table of Contents

1	Windows® Operation	1
	INSTALLING SOFTWARE	1
	Driver Installation	1
	DSmobileSCAN II Installation	4
	PageManager® 9 Installation (For Windows®)	5
	BizCard® 6 Installation (For Windows®)	6
	Viewing, Printing, Saving the User's Guide	6
	Adobe® Reader® Installation	6
	UN-INSTALLING SOFTWARE	7
	INSTALLING HARDWARE	8
	CALIBRATION	9
	USING YOUR SCANNER	11
	SETTING A DEFAULT PROGRAM	12
	CHANGING PROGRAMS	13
	CLEANING THE SCANNER	14
2	Mac OS® X Operation	17
	SETTING ADMINISTRATOR PRIVILEGES	17
	INSTALLING SOFTWARE	18
	PageManager® 9 Installation (For Mac OS® X v10.4, v10.5, v10.6 and v10.7)	19
	BizCard® 5 Installation (For Mac OS® X v10.4, v10.5, v10.6 and v10.7)	20
	UN-INSTALLING SOFTWARE	21
	INSTALLING HARDWARE	21
	CALIBRATION	22
	Calibrating your DSmobile 700D Scanner using "Image Capture"	22
	Lion® (Mac OS® X v10.7)	23
	Snow Leopard® (Mac OS® X v10.6)	23
	Leopard® (Mac OS® X v10.5)	23
	Tiger® (Mac OS® X v10.4)	26
3	Using Scanning Software	29
	DSmobileSCAN II (Windows® Only)	29
	Using DSmobileSCAN II as Your Default	29
	A Note about Document Names	30
	Using DSmobileSCAN II Icon on Your Desktop	30
	TWAIN (FOR WINDOWS®)	31
	PageManager® 9 (For Windows®)	33
	Initial Setup with PageManager® 9	33
	Selecting Scanning Source	33
	Performing Scanner Calibration	34
	BizCard® 6 (For Windows®)	35
	Performing Scanner Calibration	35

PageManager® 9 (For Mac OS® X v10.4, v10.5, v10.6 and v10.7)	36
Initial Setup with PageManager® 9	36
Selecting Scanning Source	36
Performing Scanner Calibration	37
BizCard® 5 (For Mac OS® X v10.4, v10.5, v10.6 and v10.7)	39
Performing Scanner Calibration	39
Technical support (For PageManager® and BizCard®)	40

4	Specifications	41
----------	-----------------------	-----------

5	Tips & Cautions	42
----------	----------------------------	-----------

FOR BEST RESULTS, PLEASE INSTALL THE SOFTWARE FROM THE INCLUDED INSTALLATION DVD PROVIDED **BEFORE** PLUGGING IN YOUR SCANNER.

Note

As a precaution, a RED warning label has been placed on the USB cable to remind you to install the Installation DVD first. Please remove this warning label prior to plugging in the scanner cable after you have installed the software.

INSTALLING SOFTWARE

Driver Installation

- 1 Insert the Installation DVD that came with your DSmobile 700D scanner into your computer. The Autoplay window will be displayed, select "Run setup.exe". When the User Account Control window is displayed, choose "Yes".

If the installation does not start automatically, please go to My Computer (Computer), and then double-click the DVD icon.

If this installation program does not begin, then double-click the start.exe icon.

- 2 The installation program should begin automatically. Select your language, then click on "Install Scanner Driver."



The following screen will be displayed. Click “Next”.

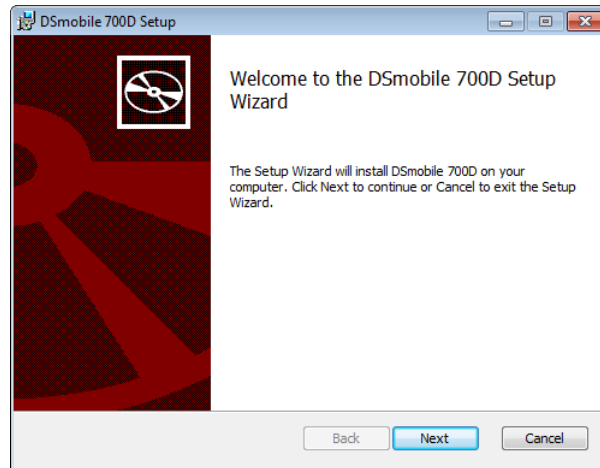

3 Read the End User License Agreement, click the acceptance box, and click “Next”.

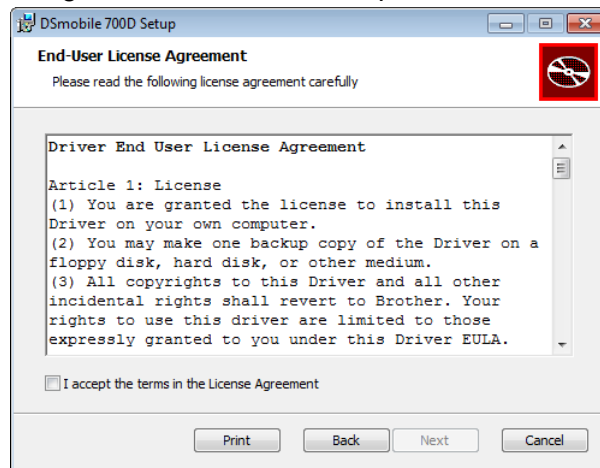

4 Select “Complete” (recommended) or “Custom”.

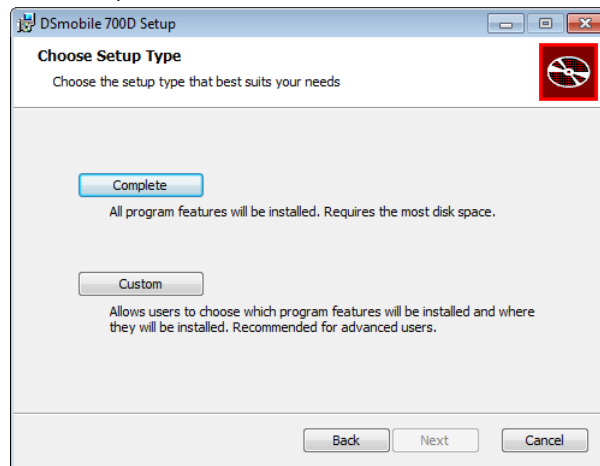

5 The following screen will be displayed. Click “Install”.

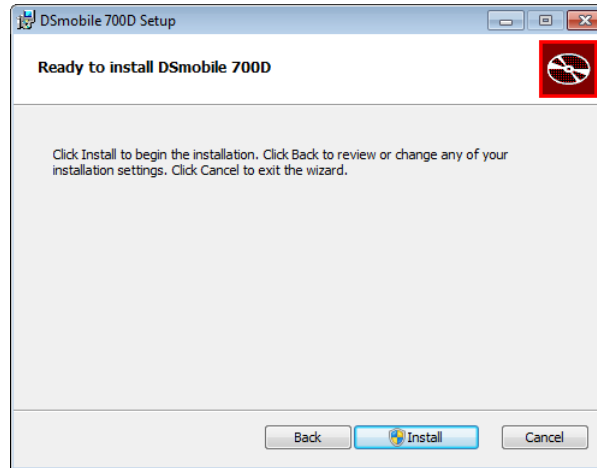

6 When the driver has been installed, the following screen will be displayed. Click “Next”. Follow the recommended choices for the New Hardware Wizard.

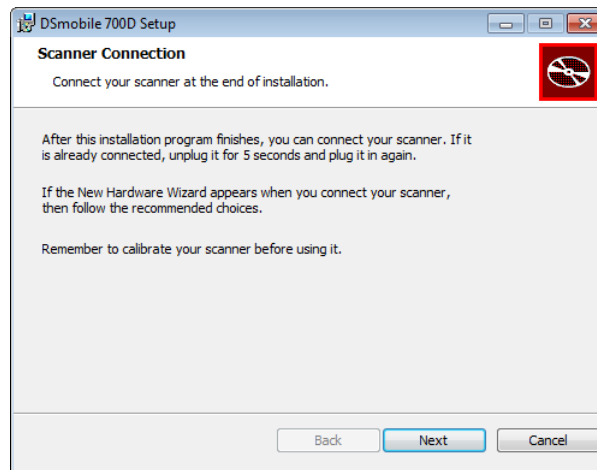

7 Click “Finish”.

8 The installation screen will re-appear and you will now have five choices:

- Install DSmobileSCAN II
- Install PageManager® 9
- Install BizCard® 6
- View/Print the PDF User Guide
- Install the Adobe® Reader®



Note

After you have completed all software installations, we strongly recommend that you remove the DVD and restart your computer even though you are not requested by Windows® to do so.

DScmobileSCAN II Installation

- 1 Click on Install DScmobileSCAN II.
- 2 Click "Next".

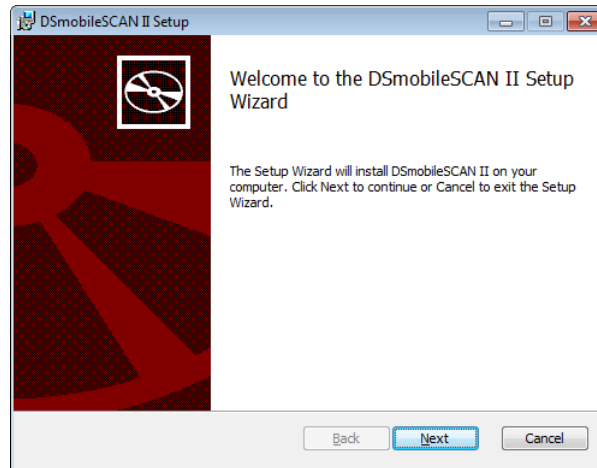

- 3 Select the box labeled, "I accept . . .", and then click "Next".
- 4 Click "Next".

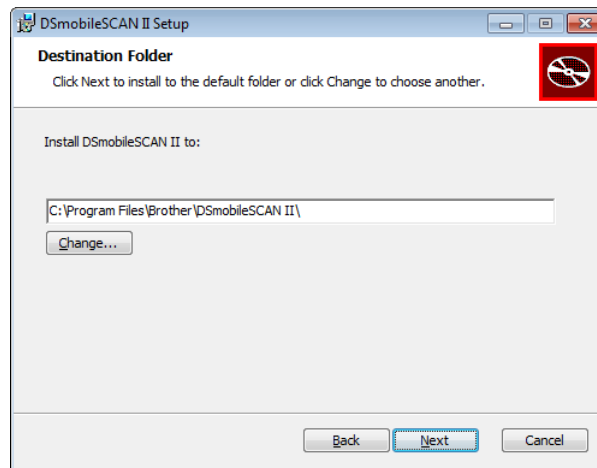

- 5 Click "Install".

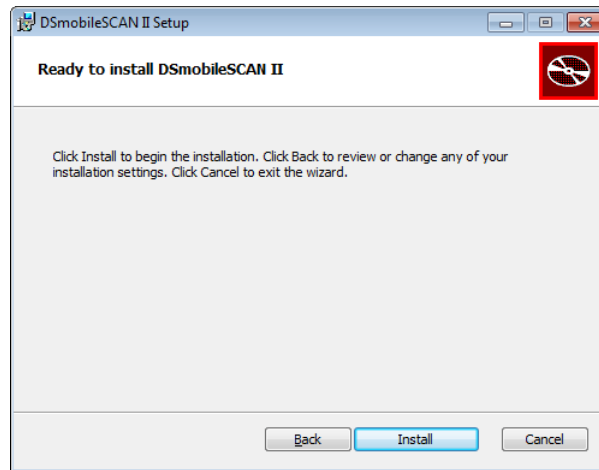

- 6 Click "Finish".
- 7 This installation will place a DSmobileSCAN II icon on your Windows® desktop from which you can launch the application whenever needed.

PageManager® 9 Installation (For Windows®)

At this point you may install the PageManager® 9 software. Follow the on-screen instructions to install PageManager® 9.

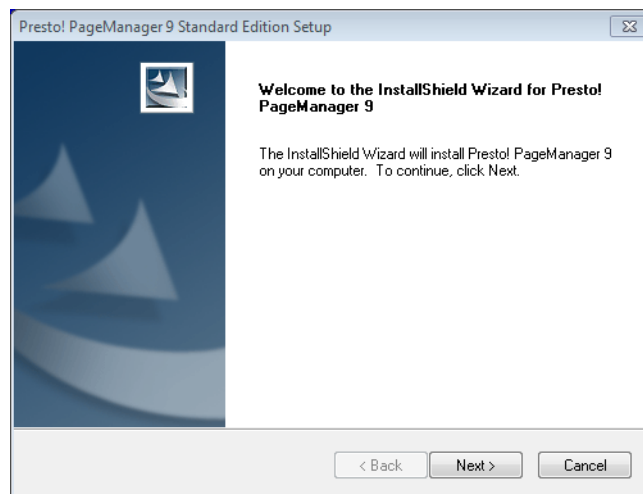

BizCard® 6 Installation (For Windows®)

You may also install the BizCard® 6 software. Follow the on-screen instructions to install BizCard® 6.

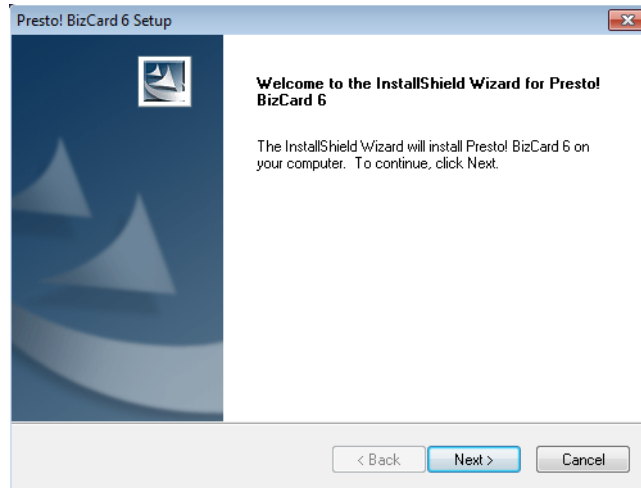

Viewing, Printing, Saving the User's Guide

- 1 Click on Documentation.
- 2 Click on View/Print the PDF User Guide. This will launch Adobe® Reader® and display the first page of the User's Guide. If this does not happen, you must install Adobe® Reader® software as outlined in the next section.
- 3 From the display of the User's Guide, you can view the document, or save or print the document by selecting those options under the File menu.
- 4 Close the Adobe® Reader® window when you are finished.

Adobe® Reader® Installation

If you do not have Adobe® Reader® installed yet, you should click the "Get ADOBE READER" button before you click "View/Print the PDF User Guide." You may then print the User's Guide after installing the Adobe® Reader® for your future reference.

If you choose to install the Adobe® Reader®, your Web browser will start and "Adobe Reader download" website will open. Please follow the instructions to install the software.

UN-INSTALLING SOFTWARE

If you should need to un-install the driver software later, you simply insert the original installation DVD and run the setup again. At this time you will be given three options. Select the REMOVE option, and then click REMOVE. Scanner driver software will be removed from your computer.

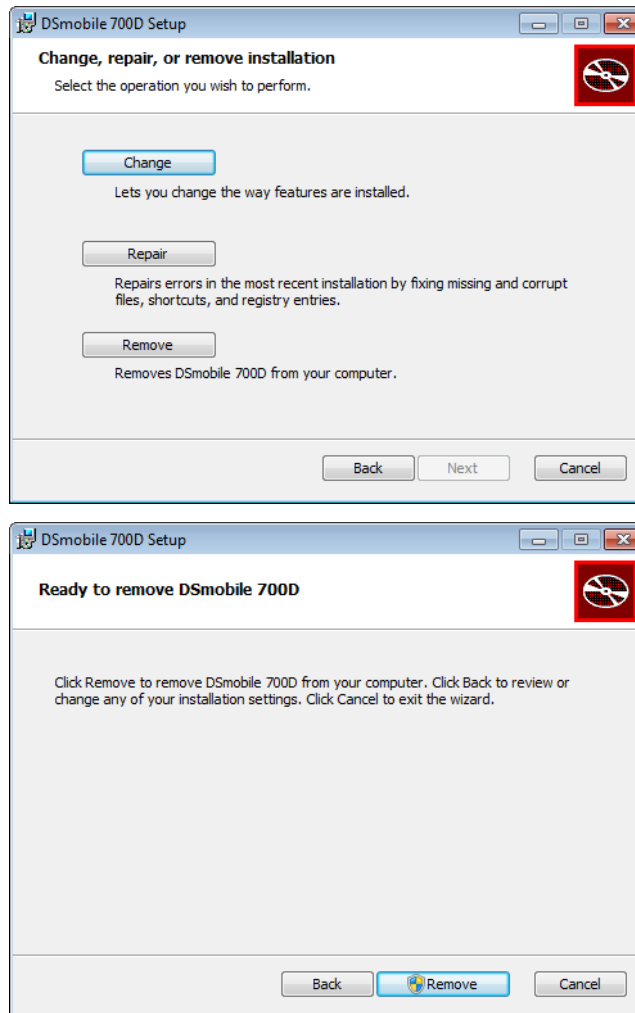

If you should need to un-install Windows® scanning software (DSmobileSCAN II or PageManager®), follow the steps below.

(Windows® 7 and Windows Vista®)

Select Start, Control Panel, and then Programs and features to delete the desired software.

(Windows® XP)

Select Start, Control Panel, and then Add or Remove Programs to delete the desired software.

INSTALLING HARDWARE

Do not connect the scanner to your computer until instructed to do so by the driver installation software. When instructed to do so, connect the scanner cable as shown below and follow the instructions.

After you have installed the software, follow the steps below. Then, proceed to Calibration.

- 1 Connect the USB cable to the scanner and to a USB port on your computer as shown below (either to a desktop or laptop computer). If necessary, please check your computer's user guide to identify the USB ports available and their locations.



- 2 The following message will be displayed, and the computer will automatically detect the new hardware device installed and it will be ready for use.

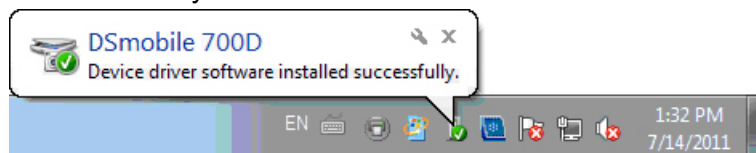

CALIBRATION

 **Note**

- Calibration is critical because it allows the image quality to be “balanced” for your computer and scanner combination. If you switch the computer that you use with your scanner or change scanners, you must calibrate again.
- Calibration can be performed on any TWAIN-compliant application. DSmobileSCAN II is such an application.
- When you intend to scan by WIA compliant scanner driver, please conduct a calibration process by TWAIN compliant scanner driver beforehand.

1 To open DSmobileSCAN II application, you can either double-click DSmobileSCAN II shortcut icon on your desktop  or the “Taskbar tray” icon usually in the lower right-hand corner of the Windows® Desktop.



2 Once you have launched DSmobileSCAN II (or any TWAIN application), select the SCAN button and the step-by-step calibration instructions will appear in a succession of prompts.

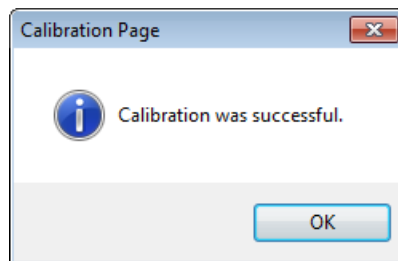
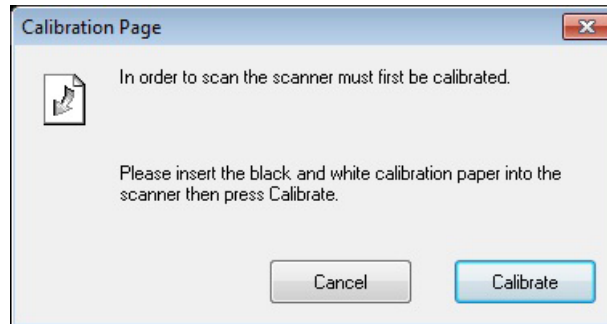

This calibration process uses the special black and white calibration sheet (see picture on page xiv) that was included with your scanner. When calibrating, note the direction of the arrows for proper insertion.

When the calibration process has been completed successfully, you will see the message above; otherwise you will need to clean the scanner and re-calibrate.

- If you switch scanners or your image quality has become unsatisfactory, you can re-calibrate your scanner by choosing the CUSTOM button in DSmobileSCAN II window and select the Calibrate button.

- If you lose the black and white calibration paper that was included with your scanner, you can use any plain “White” (the brighter the “White” the better) piece of letter size (or A4) printer paper to perform the calibration. Simply fold the paper in half and insert the end opposite the fold into the scanner first when calibrating. The following message will be displayed (see below).

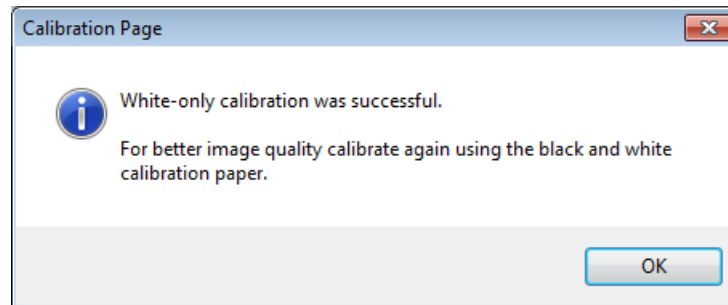

Note

When the image quality has become unsatisfactory, we recommend you clean the scanner with the included cleaning sheet (see Tips & Cautions page) and then recalibrate the scanner.

USING YOUR SCANNER

Please insert documents face down. Both sides can be scanned by one scanning process as duplex scanning function. You can either use your preferred scanning application to initiate a scan or use the button on the scanner to start a scan session. See the next section to configure a default scanning action when the button is pressed.

The following window will appear when you press the button on the top of the scanner. A double click on any of the programs will initiate that program.

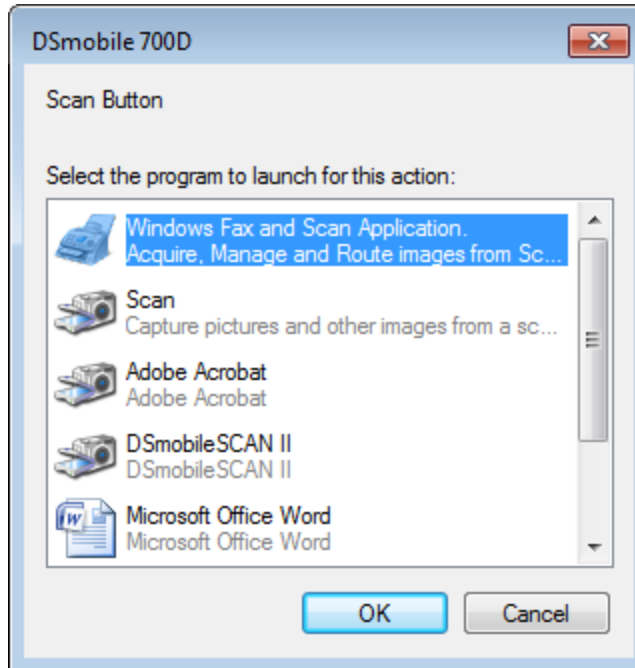

SETTING A DEFAULT PROGRAM

You can select a default scanning program to automatically launch when you press the button on the top of the scanner.

- 1 (Windows® 7 and Windows Vista®)
Select Start: Control Panel: Devices and Printers.
(Windows® XP)
Select Start: Control Panel: Scanners and Cameras.
- 2 Right click on the scanner icon, select Scan properties, and then select Events tab.
- 3 Select "Start this program:" in Actions groupbox.
- 4 Select a program in the combobox.

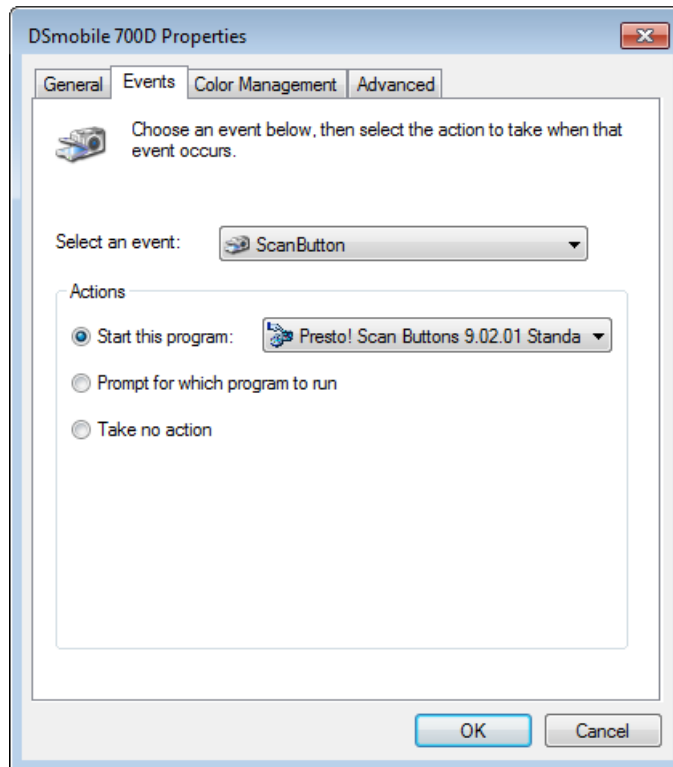

- 5 Click OK, then exit the Control Panel.

CHANGING PROGRAMS

You can set the button operation to force the selection of a scanning application each time the button is pressed.

- 1 (Windows® 7 and Windows Vista®)
Select Start: Control Panel: Devices and Printers.
(Windows® XP)
Select Start: Control Panel: Scanners and Cameras.
- 2 Right click on the scanner icon, select Scan properties, and then select Events tab.
- 3 Select "Prompt for which program to run" in Actions groupbox.

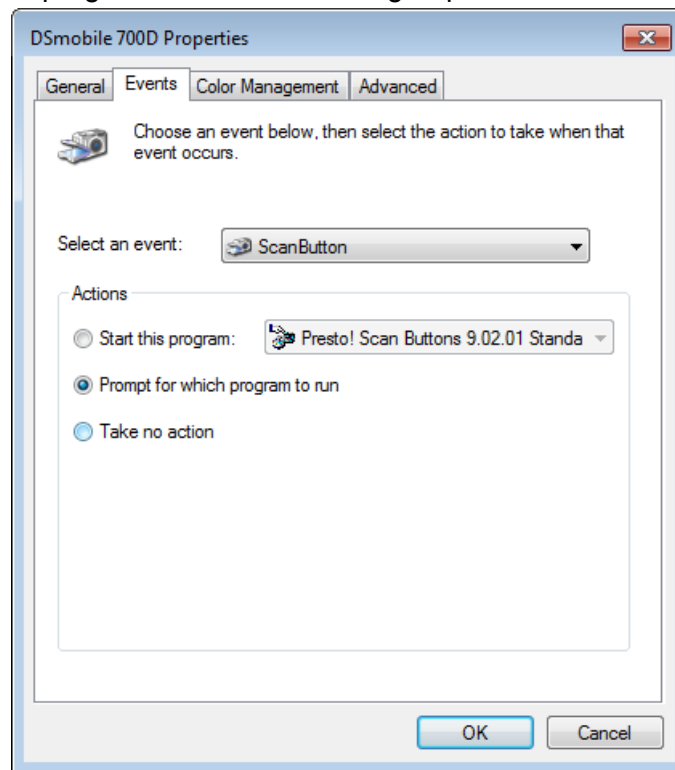

- 4 Click OK, then Exit the Control Panel.

Now the next time you press the button on the top of the scanner, the window for selecting a program will appear.

CLEANING THE SCANNER

 **Note**

The cleaning procedure can be initiated in DSmobileScan II software program. It is recommended to place a few drops of alcohol (70% isopropyl alcohol) in the middle of the cleaning sheet.

 **Note**

Use the cleaning sheet included in the original packaging. If the original cleaning sheet is not available you may order a new cleaning sheet on the Brother Mall, brothermall.com. The cleaning sheet is available in a kit containing one cleaning sheet and two calibration sheets, the kit part number is M1004.

- 1 First plug the scanner into the USB port of your computer. Let a few seconds pass while your PC has recognized the scanner then press the black button on the top of the scanner. From the box select a TWAIN or WIA compliant application, such as DSmobileScan II. The following box should appear.

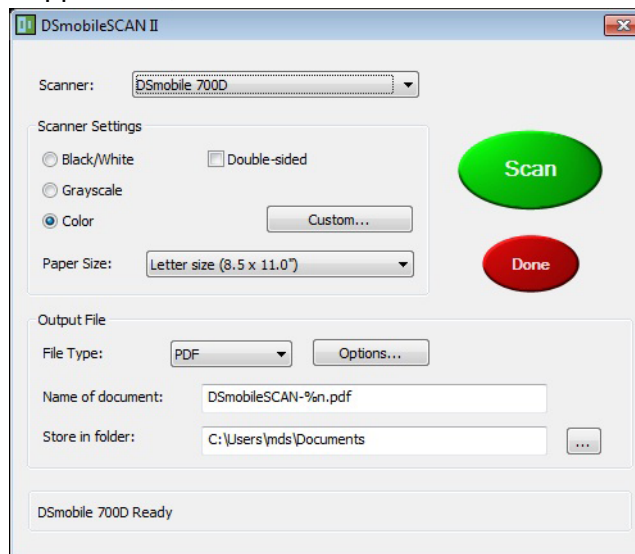

- 2 Click the Custom button and the following will appear.

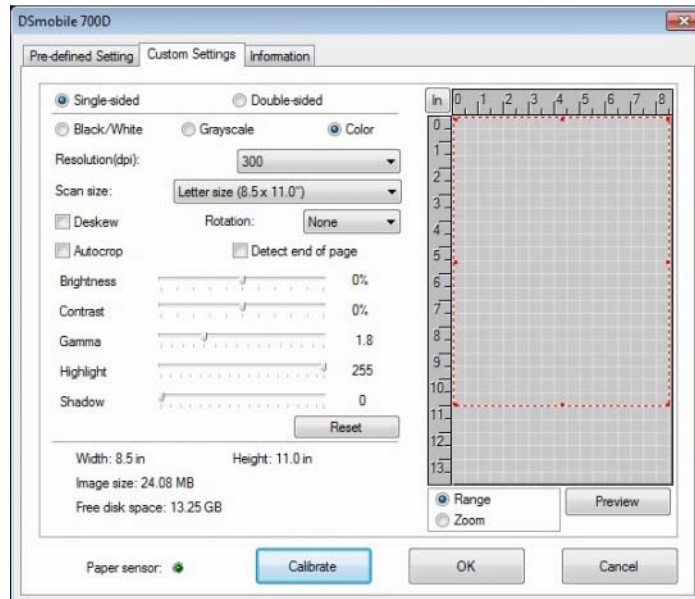

- 3 Click the Calibrate button, and the following will appear.

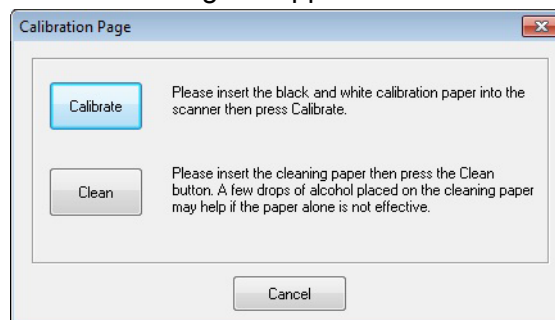

- 4 Click the Clean button, and the following will appear.

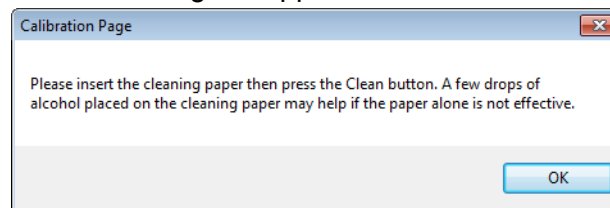

Note

A few drops of alcohol placed on the cleaning paper may help if the paper alone is not effective.

- 5 Insert the cleaning sheet into the machine.

- 6 Click the OK button and this window will reappear.

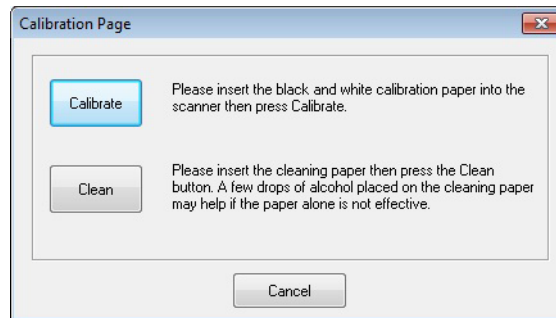

- 7 Click the Clean button the cleaning paper will move back and forth in the scanner, then be ejected and the following window will be displayed.

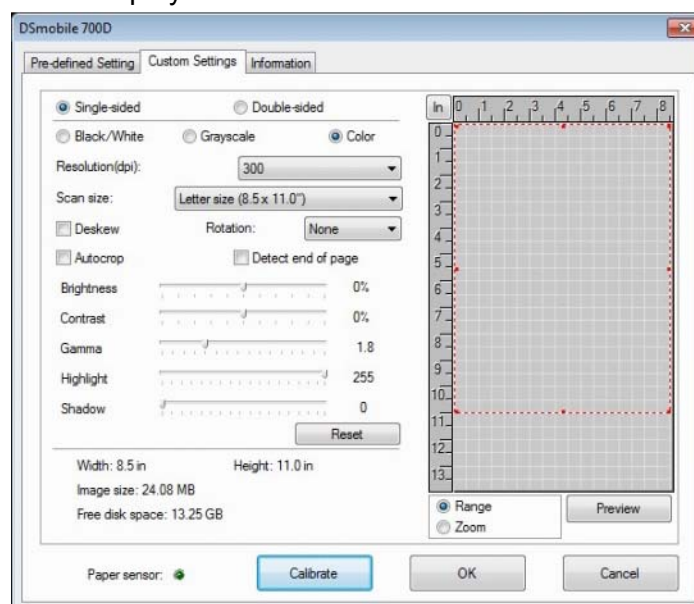

- 8 Click the OK button to finish.

FOR BEST RESULTS, PLEASE INSTALL THE SOFTWARE FROM THE INCLUDED INSTALLATION DVD PROVIDED **BEFORE** PLUGGING IN YOUR SCANNER.



Note

As a precaution, a RED warning label has been placed on the USB cable to remind you to install the Installation DVD first. Please remove this warning label prior to plugging in the scanner cable after you have installed the software.

SETTING ADMINISTRATOR PRIVILEGES

If installation or calibration is not working on your Macintosh[®] system, the solution may be in the privileges. When initially set up, you are given administrator privileges which should allow you to install the DSmobile software and complete the calibration. If, however, your system is set up such that you do not have administrator privileges or the privileges have somehow become corrupt, the installation and calibration may not be possible. To correct this problem, do the following:

- 1 Mouse over the Apple[®] in the upper left corner of the desktop and select System Preferences.
- 2 Select System and then Users & Groups.
- 3 The left pane of the window will list the current accounts, one of which should be your user name with the word “Admin” underneath.
- 4 If this is not the case, contact your system administrator to have the privileges changed so you can install software and calibrate the scanner.

INSTALLING SOFTWARE

Insert the Installation DVD that came with your DSmobile 700D scanner into your Mac® computer and follow the steps below.

2

- 1 Make sure your Macintosh® system software is Mac OS® X v10.4, v10.5, v10.6 or v10.7 and that your application software works native and not in emulation of lower system software versions.
- 2 Do not connect the DSmobile 700D scanner to your Macintosh® until after the driver installation.
- 3 We recommend that the first installation and calibration should be done using an Administrator account. (See *SETTING ADMINISTRATOR PRIVILEGES*)
- 4 Click on the DVD icon, and then open “Macintosh” folder.
- 5 Double click on DSmobile 700D Driver.pkg.
- 6 Click on “Continue”.
- 7 Select the disk for the installation or click “Continue”.
- 8 Click “Install”.
- 9 Close other application software and then click “Continue Installation”.
- 10 When the installation is complete, click “Logout”.
- 11 Connect your DSmobile 700D scanner to a Macintosh® USB port.
- 12 Start your TWAIN-compliant application software. The Macintosh® is supplied with “Image Capture” software but you may use other TWAIN-compliant software. Refer to *Calibrating your DSmobile 700D Scanner using “Image Capture”* >> page 22 for instructions on calibrating with “Image Capture”. (For Mac OS® X v10.6 and v10.7, Refer to *Performing Scanner Calibration* >> page 34 for instructions on calibrating with “PageManager® 9”)
- 13 Select “DSmobile 700D” as scanning device.
- 14 Follow the on-screen instructions for calibration and scanning.
- 15 Note that when using the DSmobile 700D on a Macintosh®, the scan button on the top of the scanner does not start scanning software automatically (available for Windows® OS only).

PageManager® 9 Installation (For Mac OS® X v10.4, v10.5, v10.6 and v10.7)

At this point you may install the PageManager® 9 software.

Insert the Installation DVD that came with your DSmobile 700D scanner into your Mac® computer and follow the steps below.

- 1 Click on the DVD icon.
- 2 Open “Macintosh” folder.
- 3 Open “PageManager 9” folder.
- 4 Double click on PM9Installer.mpkg.
- 5 Follow the on-screen instructions to install PageManager® 9.



BizCard® 5 Installation (For Mac OS® X v10.4, v10.5, v10.6 and v10.7)

You may also install the BizCard® 5 software.

- 1 Click on the DVD icon.
- 2 Open “Macintosh” folder.
- 3 Open “BizCard 5” folder.
- 4 Double click on BCRInstaller.mpkg.
- 5 Follow the on-screen instructions to install BizCard® 5.

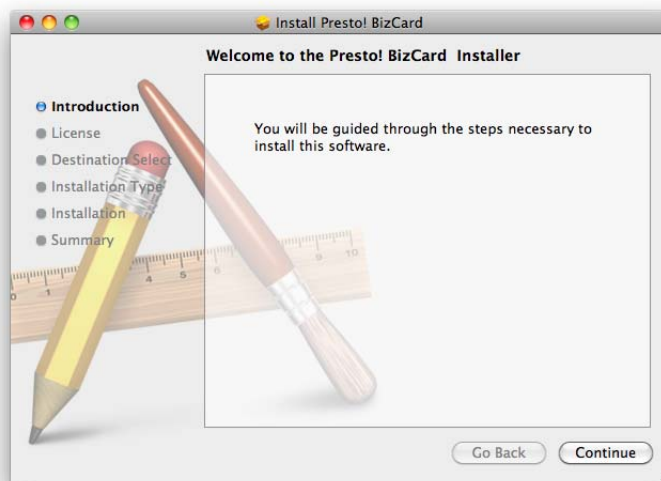

UN-INSTALLING SOFTWARE

If you need to remove any of software from your Macintosh system, you may either use the uninstaller application in the Installation DVD (PageManager® and BizCard® only) or you can drag the software out of the Applications folder to the trash can.

We recommend using the uninstaller application in the Installation DVD.

INSTALLING HARDWARE

Installing hardware is as simple as finding an unused USB port on your Macintosh® and inserting the scanner cable's USB plug into the socket.

CALIBRATION

Calibration is critical because it allows the image quality to be “balanced” for your computer and scanner combination. If you switch the computer that you use with your scanner or change scanners, you must calibrate again.

Note that you must be logged in as an Administrator to calibrate the system. See *SETTING ADMINISTRATOR PRIVILEGES* >> page 17 for further information.

This calibration process uses the special black and white calibration sheet (see picture on page xiv) that was included with your scanner. When calibrating, note the direction of the arrows for proper insertion.

If you lose the black and white calibration paper that was included with your scanner, you can use any plain “White” (the brighter the “White” the better) piece of letter size (or A4) printer paper to perform the calibration. Simply fold the paper in half and insert the end opposite the fold into the scanner first when calibrating. The following message will be displayed (see below).

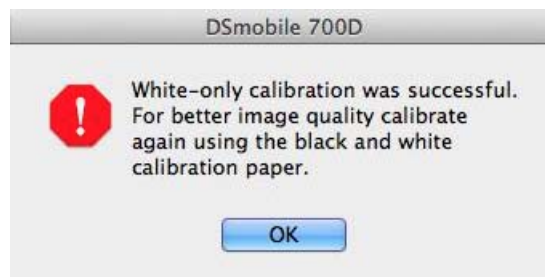

Note

*When the image quality has become unsatisfactory, we recommend you clean the scanner with the included cleaning sheet (see *Tips & Cautions* page) and then recalibrate the scanner.*

Calibrating your DSmobile 700D Scanner using “Image Capture”

Calibration is a critical step in setting up your scanner. It allows the scanned color data to be “calibrated” to your computer and scanner combination for best image quality. If at any time you switch the computer that you use with your scanner or change scanners, you will need to calibrate again.

The following steps guide you through calibration of your DSmobile 700D scanner using the built-in “Image Capture” software on your Mac OS® X along with the Brother driver and GUI. Note that once a calibration is performed, it does not need to be re-done if you use to another application on the same computer.

Lion® (Mac OS® X v10.7)

For Mac OS® X v10.7, calibrate your scanner with PageMager® 9.
See *Performing Scanner Calibration* >> page 34.

Snow Leopard® (Mac OS® X v10.6)

For Mac OS® X v10.6, calibrate your scanner with PageMager® 9.
See *Performing Scanner Calibration* >> page 34.

Leopard® (Mac OS® X v10.5)

- 1 Install the DSmobile 700D scanner driver using the Installation DVD and restart your computer.
- 2 Connect the scanner to your computer's USB port.
- 3 Open the Applications folder and run "Image Capture".

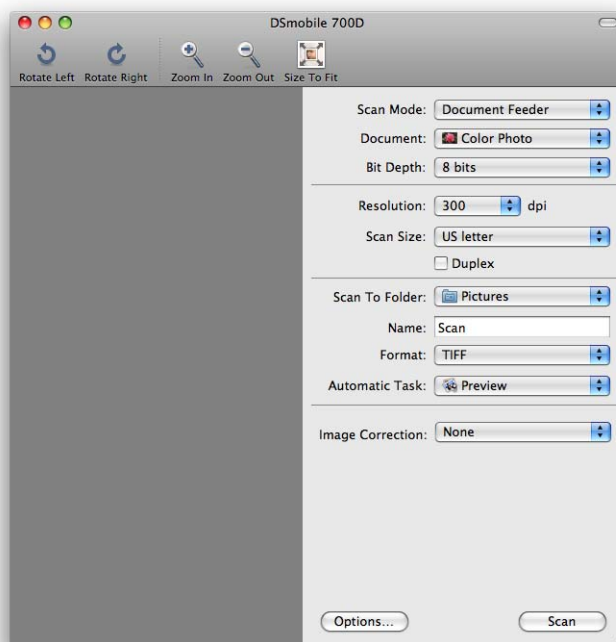

- 4 Close the "DSmobile 700D" window.

- 5 From the “Devices” menu, choose “Browse Devices”.

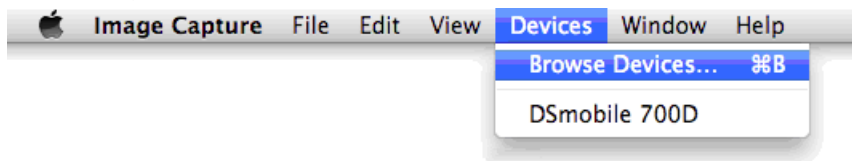

- 6 The “Image Capture Device Browser” window will appear.

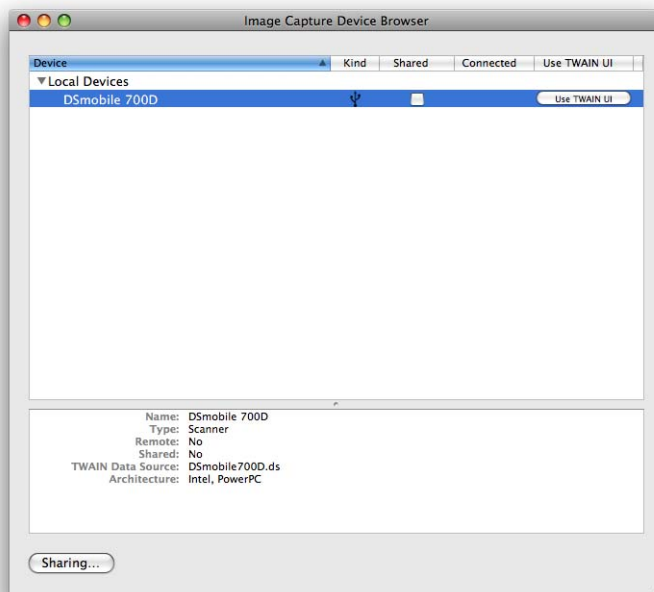

- 7 Click the “Use TWAIN UI” button to the right of “DSmobile 700D”.
- 8 Click the “Scan” button.

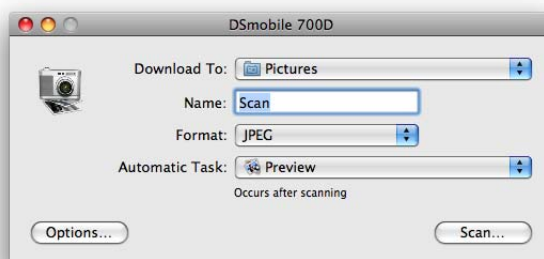

- 9 Click the “Calibrate” button.

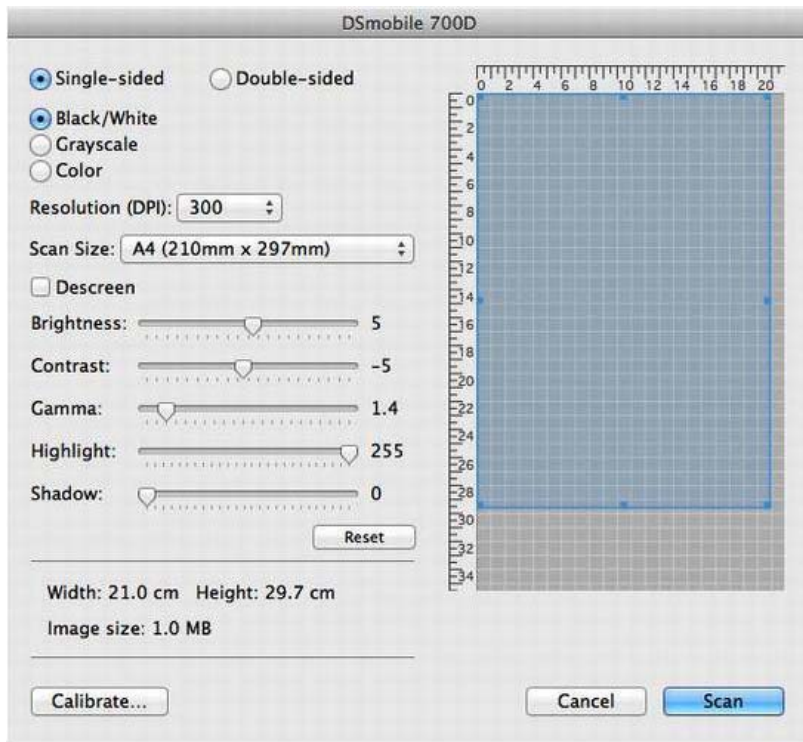

- 10 Insert the black and white calibration sheet with the single arrow on top. Alternatively, you can use a blank sheet of white paper.
- 11 Click the “Calibrate” button again.

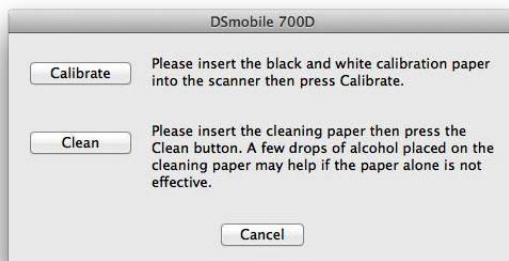

- 12 When the calibration scan is complete, click “OK” and then proceed to scan your documents.

Tiger® (Mac OS® X v10.4)

- 1 Install the DSmobile 700D scanner driver using the Installation DVD and restart your computer.
- 2 Connect the scanner to your computer's USB port.
- 3 Open the Applications folder and run "Image Capture".

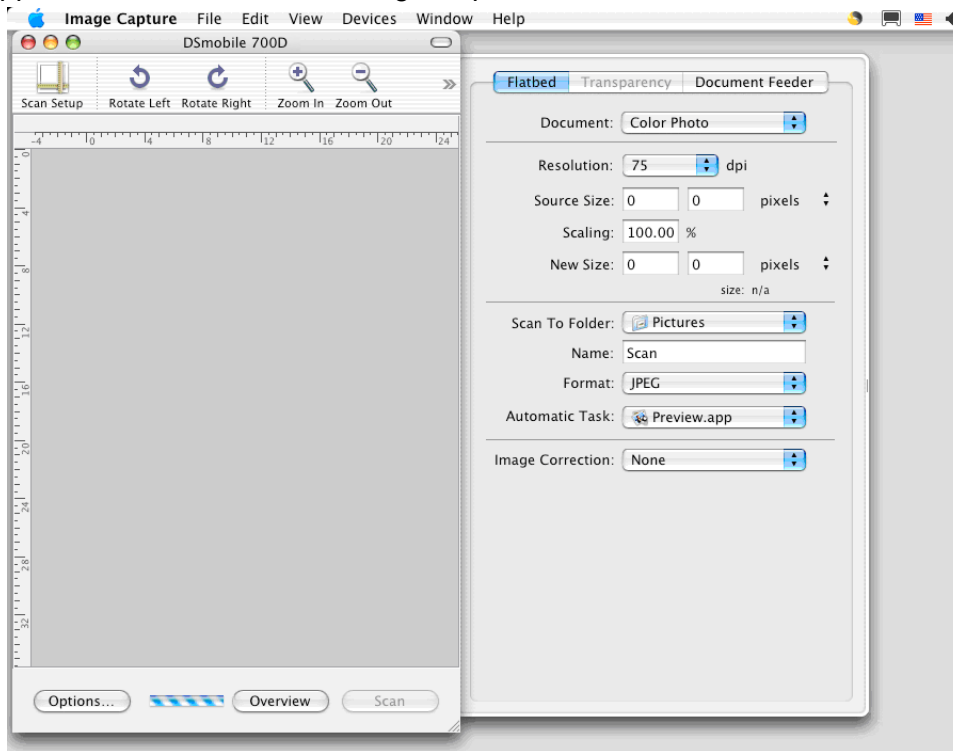

- 4 Close the "DSmobile 700D" window.
- 5 From the "Devices" window, choose "Browse Devices".



6 The “Image Capture Devices” window will appear.

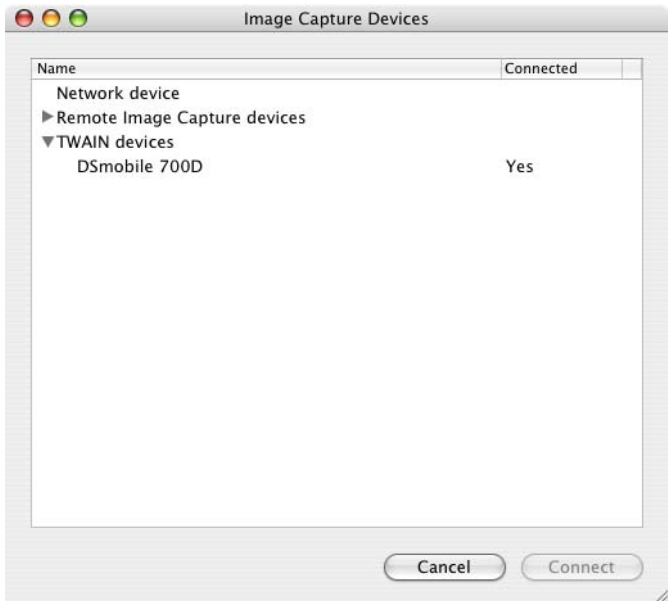

7 Click on “DSmobile 700D”.

8 Click on the “Use TWAIN software” checkbox at the bottom of the window.

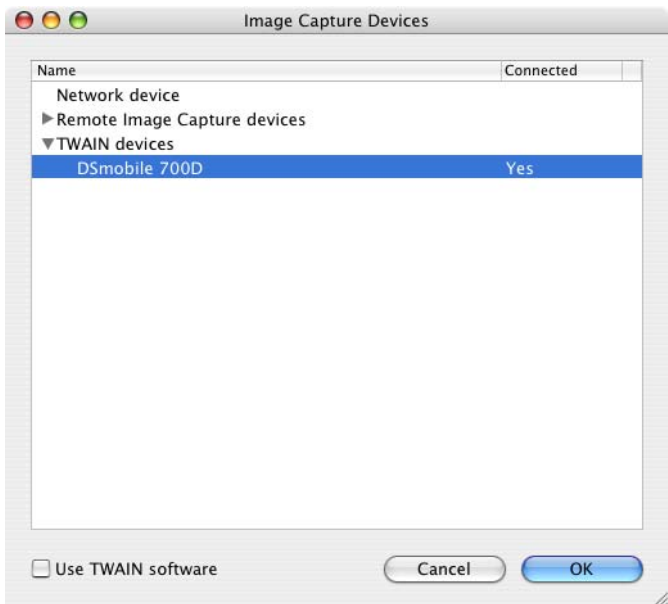

9 Click “OK” in the “Image Capture Devices” window.

10 From the “Devices” menu, choose “DSmobile 700D”.

11 In the “DSmobile 700D” window, click “Scan”.

12 Click the “Calibrate” button.

- 13 Insert the black and white calibration sheet with the single arrow on top and the black strip down. Alternatively, you can use a blank sheet of white paper.
- 14 When the calibration scan is complete, click “OK” and then proceed to scan your documents.

DSmobileSCAN II (Windows® Only)

This software supports Adobe® Acrobat® PDF, JPEG, and TIFF. Note that only PDF format files can be saved as multiple pages. JPEG and TIFF files will be stored as separate files with index numbers added to the filename (except for the first page).

Using DSmobileSCAN II as Your Default

The advantage of using DSmobileSCAN II as your default is that as a default program it provides the ability to scan automatically. Pressing the button on top of the scanner once starts DSmobileSCAN II software and pressing it again starts a document scan.

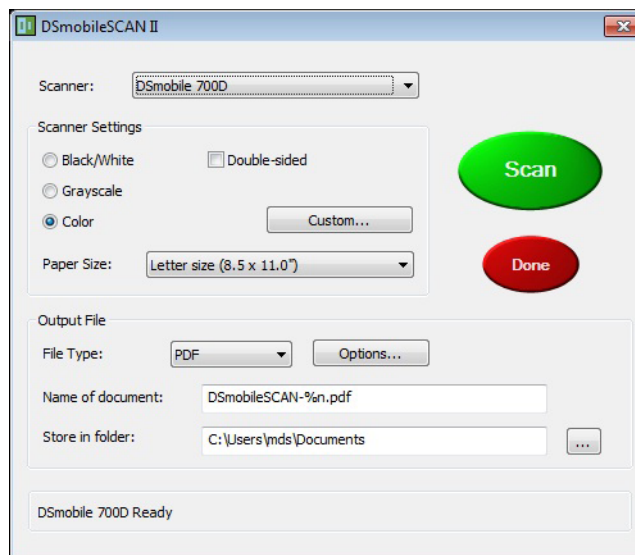

This program gives the user the choice of selecting type of scan and paper size from the main menu (shown above) or pressing the “Custom” button to utilize the document manager control panel for more precise settings. Selecting the custom settings will put the program into a TWAIN driver and takes you out of the actual DSmobileSCAN II software application.

If the Custom button is used, it cancels the automatic scan function. The user must choose the setting they wish to make custom, click on “OK” to put the program back to the scanning page, and then click on the green “Scan” button to scan the page.

If DSmobileSCAN II is not set as the default program, when the button on top of the scanner is pressed, a window will be displayed requiring you to choose a scanning software as shown in *USING YOUR SCANNER* >> page 11. Follow the scanning instructions for the scanning software you have chosen.

A Note about Document Names

You can use a suffix with file names to add either an index number or a date. If you append the filename with a “%n”, the file name is appended with a sequential number beginning with 1 (if a previous file exists, the number is incremented to the next highest number). If you append the file name with a “%d”, the file name is appended with a date in the form YY-MM-DD.

Using DSmobileSCAN II Icon on Your Desktop

An icon () will appear on your desktop after DSmobileSCAN II software installation. Using this icon will initiate the DSmobileSCAN software but unless DSmobileSCAN II is set as your default it will put it in a “manual” mode which requires the user to click on the green “SCAN” button to initiate the scan.

If you have chosen DSmobileSCAN II as your default scanning software, pressing the button on the top of the scanner after DSmobileSCAN II has been launched from the icon will start the scan process.

If you have not chosen DSmobileSCAN II as your default scanning software, pressing the button on the top of the scanner after DSmobileSCAN II has been launched from the icon will display the “select the program to launch for this action” window. You can now choose another program from the menu. Although the DSmobileSCAN window will show in the background, it will not interfere with the other scanning application you choose. To close DSmobileSCAN II window, you must click on the delete “X” at the top of DSmobileSCAN II screen. Closing DSmobileSCAN II window will not interfere with your current software application.

TWAIN (FOR WINDOWS®)

The TWAIN driver for the DSmobile 700D is automatically installed when the Installation DVD installs the Windows® drivers. This TWAIN driver defines communication and data structures between software applications on your PC and the DSmobile 700D.

All software that appears in the “select the program to launch for this action” window (shown below) will be TWAIN and WIA-compliant software that is compatible with the DSmobile 700D scanner and allows scanning from that software program. Each program will initiate scanning differently. Please follow instruction according to the software program you are using.

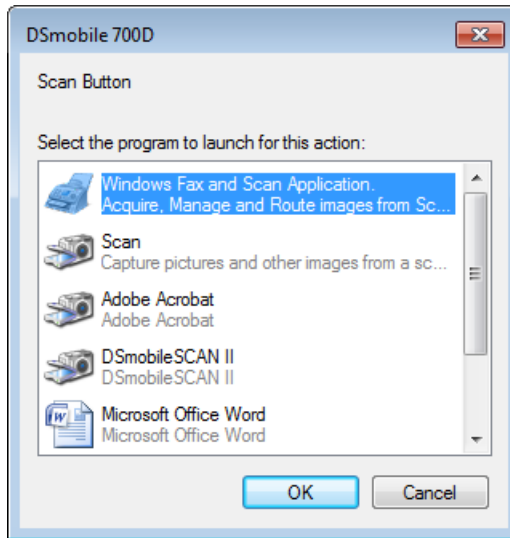

If the software you have chosen uses the TWAIN interface instead of the application software interface, the TWAIN control panel (shown below) will appear. The TWAIN interface will allow you to control all the settings of the scanner. This type of “fine-adjustment” may be required for some of your document scanning needs.

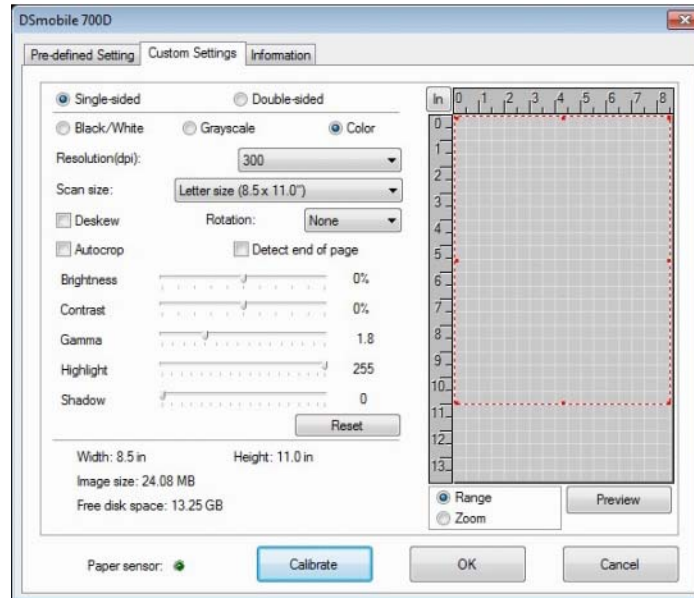

Please notice the Page Tabs at the top of the TWAIN control panel; they are: **Pre-defined Setting, Custom Settings, Information**. Take a moment to explore these Tabs and their functions.

PageManager® 9 (For Windows®)

This program makes it easy to scan, share, and organize your photos and documents. It helps you not only convert piles of paper into organized digitized files, but also lets you view, edit, send, and back-up files in many formats.

To install PageManager®, see *PageManager® 9 Installation (For Windows®)* >> page 5. Refer to the “help” file included with this program for further use instructions.

Initial Setup with PageManager® 9

Note

Calibration is a critical step in setting up your scanner. This process will balance the image quality between your computer and the scanner unit. If at any time you switch the scanner to another computer then you will need to reinstall the scanner driver and recalibrate the scanner.

Selecting Scanning Source

- 1 When using Presto! PageManager® 9 for the first time you will need to define the Scanning Source this application will be using. This also applies when switching to another scanner.
- 2 Run the PageManager® 9 application and select file in the toolbar menu.
- 3 Under file pull-down menu choose the Select Source option, then your model.

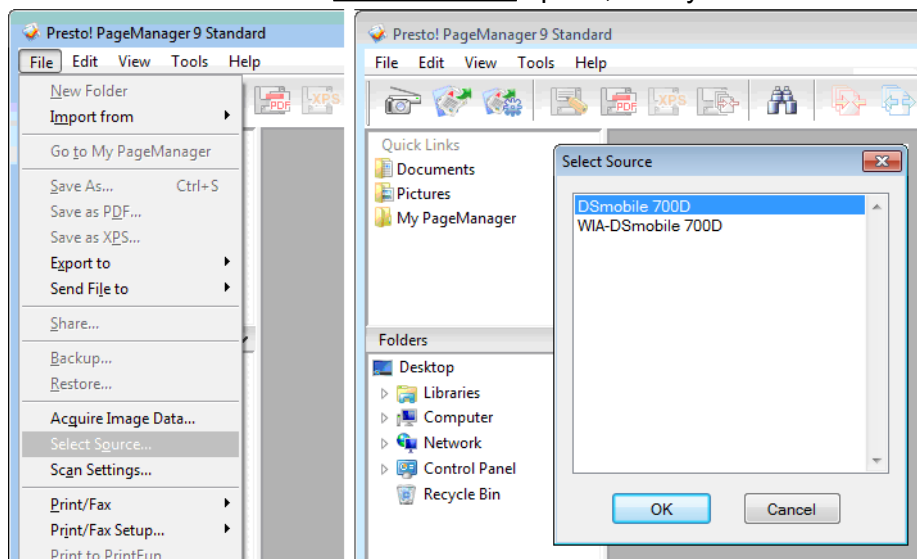

Performing Scanner Calibration

- 1 To calibrate your scanner select the acquire image data icon (scanner and camera icon) under the toolbar menu.

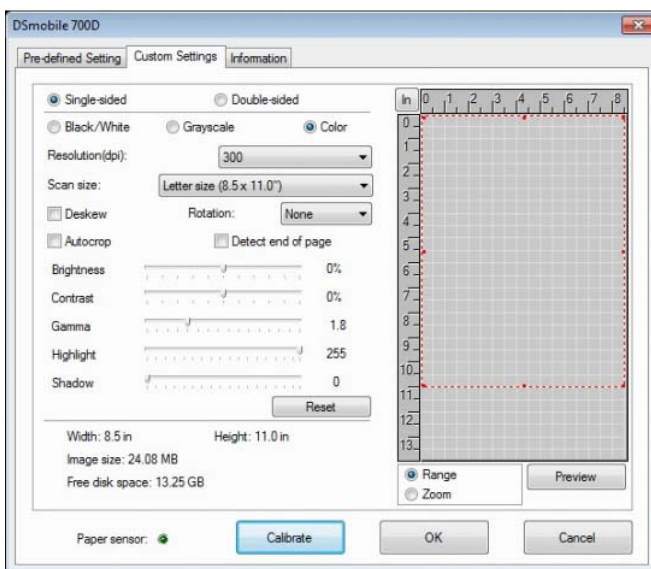
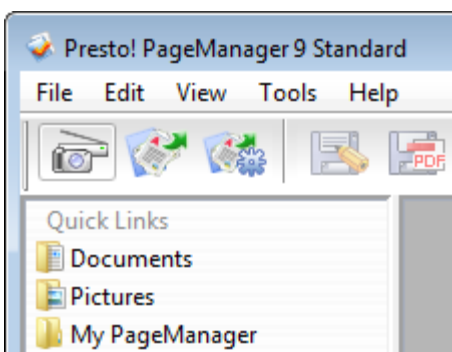

- 2 The TWAIN user interface screen will appear.
- 3 Insert the calibration sheet with the printed arrow end first.
- 4 Select the Calibration button.

BizCard® 6 (For Windows®)

BizCard® 6 keeps track of names, companies, mailing addresses, phone/fax numbers, e-mail addresses, and more. Simply scan or import your business cards and BizCard® 6 automatically saves the data and image for each card. To install BizCard® 6, See *BizCard® 6 Installation (For Windows®)* >> page 6. Refer to the “help” file included with BizCard® 6 for further use instructions.

Performing Scanner Calibration

You can calibrate DSmobile 700D scanner the first time you use it to insure that you get the best image quality.

- 1 Click Select Scanner from the File menu.
- 2 Choose the driver for your scanner from the Select Source dialog box.
- 3 Insert the black and white calibration sheet with the single arrow on top. Alternatively, you can use a blank sheet of white paper.
- 4 Click Scan with TWAIN User Interface from the File menu.
- 5 The dialog box for calibration will appear.



Note

To always get the best results, we suggest that you recalibrate the scanner once a month or so, depending on how often you use it.

PageManager® 9 (For Mac OS® X v10.4, v10.5, v10.6 and v10.7)

This program makes it easy to scan, share, and organize your photos and documents.

It helps you not only convert piles of paper into organized digitized files, but also lets you view, edit, send, and back-up files in many formats.

To install PageManager®, see *PageManager® 9 Installation (For Mac OS® X v10.4, v10.5, v10.6 and v10.7)* >> page 19.

Refer to the “help” file included with this program for further use instructions.

Initial Setup with PageManager® 9

Note

Calibration is a critical step in setting up your scanner. This process will balance the image quality between your computer and the scanner unit. If at any time you switch the scanner to another computer then you will need to reinstall the scanner driver and recalibrate the scanner.

Selecting Scanning Source

When using Presto! PageManager® 9 for the first time you will need to define the Scanning Source this application will be using. This also applies when switching to another scanner.

- 1 Run the PageManager® 9 application and select file in the toolbar menu.
- 2 Under file pull-down menu choose the Select Source option, then your model.

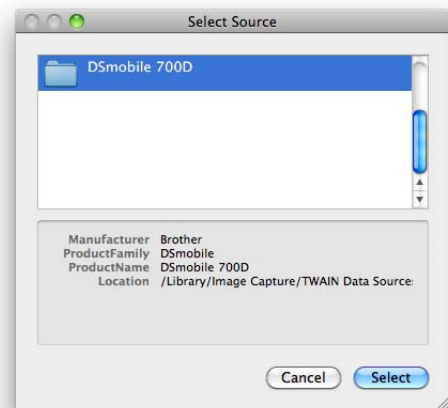
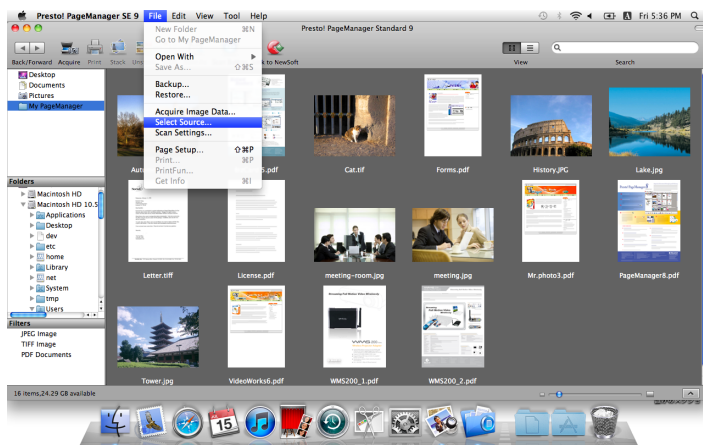

Performing Scanner Calibration

- 1 To calibrate your scanner select the acquire image data icon (scanner and camera icon) under the toolbar menu.

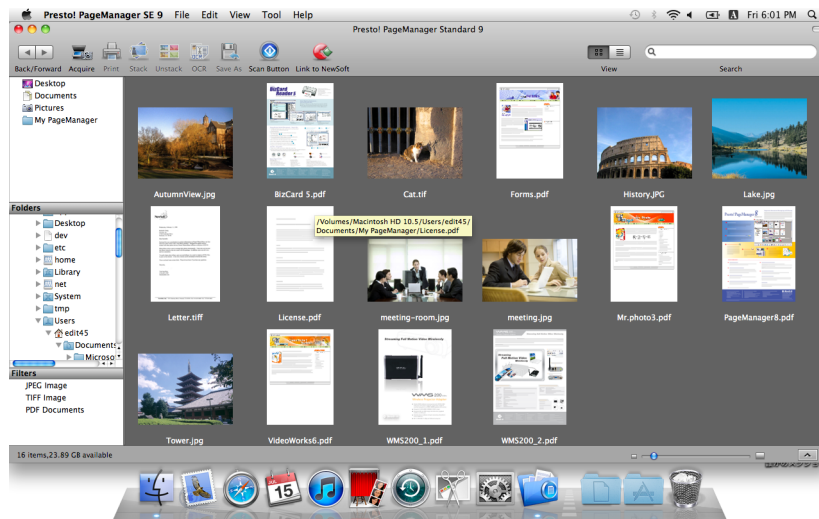

- 2 The TWAIN user interface screen will appear.

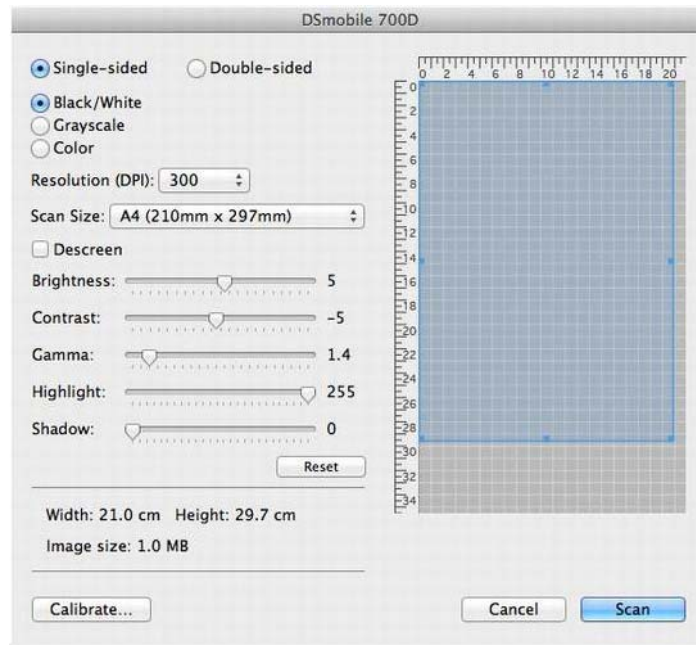

- 3 Insert the calibration sheet with the printed arrow end first.

- 4 Select the Calibration button.
The following message will appear (see below). Select "OK" and proceed to scanning.

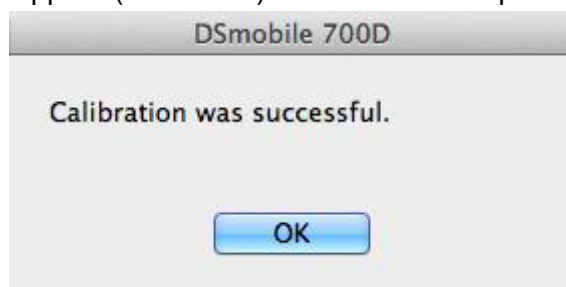

BizCard[®] 5 (For Mac OS[®] X v10.4, v10.5, v10.6 and v10.7)

BizCard[®] 5 keeps track of names, companies, mailing addresses, phone/fax numbers, e-mail addresses, and more. Simply scan or import your business cards and BizCard[®] 5 automatically saves the data and image for each card.

To install BizCard[®] 5, See *BizCard[®] 5 Installation (For Mac OS[®] X v10.4, v10.5, v10.6 and v10.7)* >> page 20. Refer to the “help” file included with BizCard[®] 5 for further use instructions.

Performing Scanner Calibration

Calibrate DSmobile 700D scanner the first time you use it to insure that you get the best image quality.

- 1 Click Select Scanner from the File menu.
- 2 Choose the driver for your scanner.
- 3 Click Scan and Recognition Setting from the File menu.
- 4 Select Scan with TWAIN User Interface, and click OK button.
- 5 Click Scan Card and Recognize from the File menu. DSmobile 700D window will appear.
- 6 Insert the black and white calibration sheet with the single arrow on top. Alternatively, you can use a blank sheet of white paper.
- 7 Click Calibrate button.
- 8 Make sure the black bar side is inserted facing down then select the Calibrate button.



Note

To always get the best results, we suggest that you recalibrate the scanner once a month or so, depending on how often you use it.

Technical support (For PageManager[®] and BizCard[®])

For USA

Company name: NewSoft America Inc.
Postal Address: 47102 Mission Falls Court, Suite 202 Fremont CA 94539
Telephone: 510-770-8900
Fax: 510-770-8980
E-mail Address: contactus@newsoftinc.com
URL: <http://www.newsoftinc.com>

For Canada

E-mail Address: contactus@newsoftinc.com

Other countries

E-mail Address: tech@newsoft.eu.com



Note

For all other issues, please contact your *Customer Service (USA only)* >> page xiii.

4

Specifications

4

Model Name	DSmobile 700D
Scanning Speed (Mono)	10ppm (5.8 seconds (Letter) 200 dpi)
Scanning Speed (Color)	3ppm (17.6 seconds (Letter) 200 dpi)
Duplex Scanning Speed (Mono)	10ipm (11.5 seconds (Letter) 200 dpi)
Duplex Scanning Speed (Color)	3ipm (35.2 seconds (Letter) 200 dpi)
Resolution (Optical)	Max 600 × 600 dpi
Gray Scale	256 levels
Color Depth (Int. / Ext.)	24 bit
Media Weights	65 g/m ² to 120 g/m ² : 18lb to 32lb
Media Sizes	Width: up to 8.5 in (216 mm) Length: up to 14.0 in (356 mm)
Document Scanning Width	LTR : 216 mm, 8.5 inch
Paper Thickness	Maximum Thickness of Media: 1.0 mm ¹ Minimum Thickness of Media: 0.1 mm
Temperature (Operation/Storage)	+5°C to +50°C (+41°F to +122°F) (Operation) -20°C to +60°C (-4°F to +140°F) (Storage)
Relative Humidity (Operation/Storage)	10% to 90% RH, non-condensing (Operation) 10% to 90% RH at 30°C, non-condensing (Storage)
Power Source	USB bus-power 5V DC
Power Consumption (MAX)	2.3W
Power Consumption (Ready)	0.7W
Power Consumption (Deep Sleep)	0.01W
USB	Hi-Speed 2.0
TWAIN Compliant	YES
WIA Compliant	YES
Scanner Driver (Windows)	TWAIN, WIA for XP/Vista/Windows 7
Scanner Driver (Mac)	TWAIN for MacOS X v10.4, v10.5, v10.6, and v10.7
Processor Minimum Speed	Pentium 4 1.3 GHz or later
Minimum RAM	512 MB system memory (except BizCard - requires 768 MB system memory or higher)
Recommended RAM	1GB highly recommended
HDD space to install (For drivers and DSmobileSCAN II)	250 MB disk space

¹ Non-embossed plastic cards up to 1.00 mm.

5

Tips & Cautions

The DSmobile 700D scanner can provide long and productive service. We encourage you to follow the suggestions below to improve the convenience and quality of your scanning and document management experience.

- ✘ Please do not insert stapled items into the DSmobile 700D.
- ✘ Please do not insert documents that have Wite-Out® that is chipped or wet.
- ✘ Please do not insert documents with any type of adhesive material, even POST-IT® notes.



Staples



Wite out

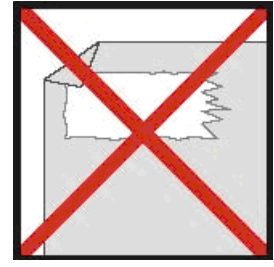

Adhesives

- Make sure the leading edge of your document is very straight (not wrinkled or having folded corners) and is inserted level with the intake slot.
- Clean the scanner with the included cleaning sheet and 70% isopropyl alcohol (not included). Place a few drops of the alcohol in the middle of the cleaning sheet then go to the Calibrate Menu and select “CLEAN.” Your scanner will automatically pass the cleaning sheet over the internal image sensor to clean it.
- Document sleeves can be easily cleaned with a clean cloth and a Windex® type liquid glass cleaner. This will effectively remove finger prints, smudges and roller marks from the sleeve.

Free Manuals Download Website

<http://myh66.com>

<http://usermanuals.us>

<http://www.somanuals.com>

<http://www.4manuals.cc>

<http://www.manual-lib.com>

<http://www.404manual.com>

<http://www.luxmanual.com>

<http://aubethermostatmanual.com>

Golf course search by state

<http://golfingnear.com>

Email search by domain

<http://emailbydomain.com>

Auto manuals search

<http://auto.somanuals.com>

TV manuals search

<http://tv.somanuals.com>