

Dell™ 1909W AIO Flat Panel Monitor For Dell OptiPlex™ USFF Computer

[About Your Monitor](#)

[Setting Up the Monitor](#)

[Operating the Monitor](#)

[Troubleshooting](#)

[Appendix](#)

Notes, Notices, and Cautions



NOTE: A NOTE indicates important information that helps you make better use of your computer.



NOTICE: A NOTICE indicates either potential damage to hardware or loss of data and tells you how to avoid the problem.



CAUTION: A CAUTION indicates a potential for property damage, personal injury, or death.

Information in this document is subject to change without notice.
© 2008 Dell Inc. All rights reserved.

Reproduction of these materials in any manner whatsoever without the written permission of Dell Inc. is strictly forbidden.

Trademarks used in this text: *Dell* and the *DELL* logo are trademarks of Dell Inc; *Microsoft* and *Windows* are either trademarks or registered trademarks of Microsoft Corporation in the United States and/or other countries. ENERGY STAR is a registered trademark of the U.S. Environmental Protection Agency. As an ENERGY STAR partner, Dell Inc. has determined that this product meets the ENERGY STAR guidelines for energy efficiency.

Other trademarks and trade names may be used in this document to refer to either the entities claiming the marks and names or their products. Dell Inc. disclaims any proprietary interest in trademarks and trade names other than its own.

Model 1909Wf

September 2008 Rev. A00

[Back to Contents Page](#)

About Your Monitor

Dell™ 1909W AIO Flat Panel Monitor For Dell OptiPlex™ USFF Computer





- [Package Contents](#)
- [Product Features](#)
- [Identifying Parts and Controls](#)
- [Monitor Specifications](#)
- [Plug and Play Capability](#)
- [Universal Serial Bus \(USB\) Interface](#)
- [LCD Monitor Quality and Pixel Policy](#)
- [Maintenance Guidelines](#)

Package Contents

Your monitor ships with the components shown below. Ensure that you have received all the components and [contact Dell](#) if something is missing.

 **NOTE:** Some items may be optional and may not ship with your Monitor. Some features or media may not be available in certain countries.

	1 Monitor
	1 Stand
	1 Power Cable

	<ul style="list-style-type: none"> 1 DVI Cable
	<ul style="list-style-type: none"> 1 USB up stream cable (enables the USB ports on the monitor)
	<ul style="list-style-type: none"> 1 Cable Cover
	<ul style="list-style-type: none"> 1 <i>Drivers and Documentation</i> media 1 <i>Quick Setup Guide</i> 1 <i>Safety Information</i> 1 <i>Stand Template</i>

Product Features

The **1909W USFF AIO** flat panel display has an active matrix, thin-film transistor (TFT), liquid crystal display (LCD). The monitor features include:

- 19-inch (482.6 mm) viewable area display (Measured diagonally) .
 - 1440x900 resolution, plus full-screen support for lower resolutions.
 - Wide viewing angle to allow viewing from a sitting or standing position, or while moving from side-to-side.
 - Tilt and vertical extension capabilities.
 - Removable pedestal and Video Electronics Standards Association (VESA) 100 mm mounting holes for flexible mounting solutions.
 - Plug and play capability if supported by your system.
 - On-Screen Display (OSD) adjustments for ease of set-up and screen optimization.
 - Software and documentation media which includes an information file (INF), Image color Matching File (ICM), and product documentation.
 - Energy Saver feature for Energy Star compliance.
 - Security lock slot.
 - AIO stand with built-in thumbscrews for toolless computer mounting and a handle for system portability.
 - Dedicated stand integrating the Dell OptiPlex USFF computer and monitor in an All-In-One configuration.
 - Asset management capability.
-

Identifying Parts and Controls

Front View



Front View

Front panel controls

Label	Description
1	Brightness & Contrast
2	Automatic adjust
3	Input source Select
4	Menu
5	Power (with power light indicator)

Back View

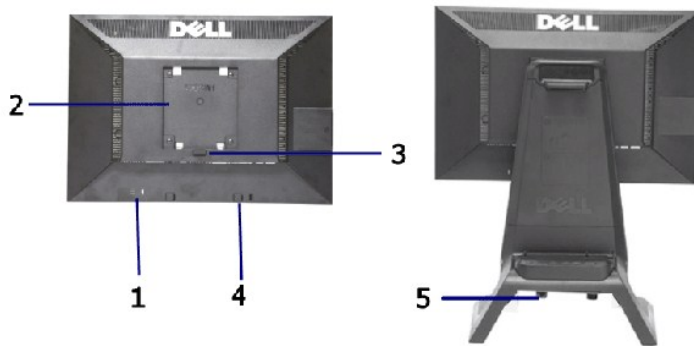

Back view

Back View with monitor stand

Label	Description	Use
1	Security lock slot	To help secure your monitor.
2	VESA mounting holes (100mm) (Behind attached base plate)	To mount the monitor.
3	Stand removal button	Press to release the stand.
4	Dell Soundbar mounting brackets	To attach the optional Dell Soundbar.
5	Thumbscrews	Fasten the chassis to the stand with thumbscrews.

Label View



Monitor front view with label card extended to reveal barcode serial number label.



Monitor rear view with label card extended to reveal regulatory label.

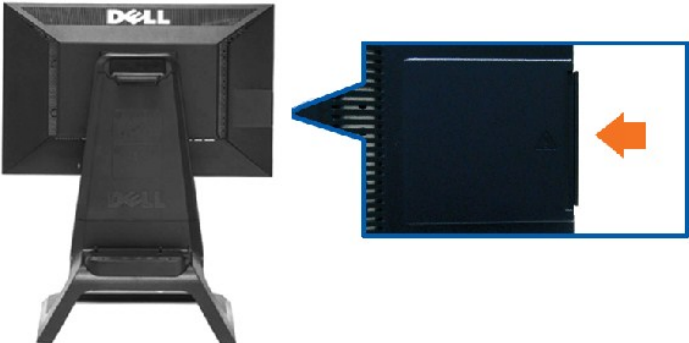

Monitor rear view with label card inserted back to provide a clean back view.

Label	Description	Use
1	Barcode serial number label	To contact Dell for technical support.
2	Regulatory label	Lists the regulatory approvals.

Note: The regulatory rating label and barcode serial number label is revealed when plate is pulled out from USB compartment.

Side View

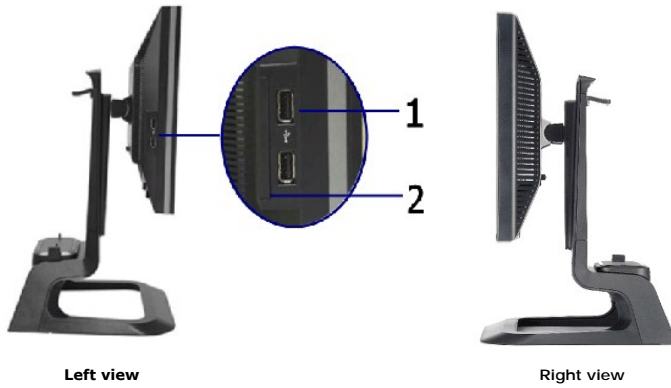

Label	Description
1	USB downstream ports
2	label card

Bottom View

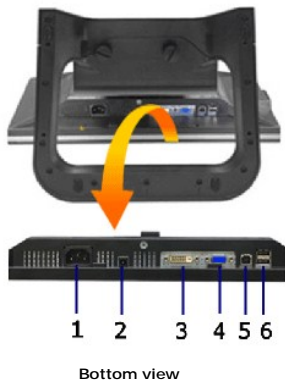

Label	Description
1	AC power cord connector
2	Dell Soundbar power connector
3	DVI connector
4	VGA connector
5	USB upstream port
6	USB downstream ports

Monitor Specifications

Flat Panel Specifications

Screen type	Active matrix - TFT LCD
Screen dimensions	19 inches (19-inch viewable image size)
Preset display area:	408.24(H)X255.15(V)
Horizontal	408.24 mm (16.08 inches)
Vertical	255.15 mm (10.05 inches)

Pixel pitch	0.2835 mm
Viewing angle	160° (vertical) typical, 160° (horizontal) typical
Luminance output	300 CD/m ² (typical)
Contrast ratio	1000 to 1 (typical)
Faceplate coating	Antiglare with hard-coating 3H
Backlight	CCFL (2) edgelight system
Response Time	5 ms typical
Color Gamut	83%*

*[1909W USFF AIO] color gamut (typical) is based on CIE1976 (83%) and CIE1931 (72%) test standards.

[Back to Contents Page](#)

Appendix

Dell™ 1909W AIO Flat Panel Monitor For Dell OptiPlex™ USFF Computer

- [Safety Instructions](#)
- [FCC Notice \(U.S. Only\) and Other Regulatory Information](#)
- [Contacting Dell](#)



CAUTION: Safety Instructions



CAUTION: Use of controls, adjustments, or procedures other than those specified in this documentation may result in exposure to shock, electrical hazards, and/or mechanical hazards.

For information on safety instructions, see the *Product Information Guide*.

FCC Notices (U.S. Only) and Other Regulatory Information

For FCC notices and other regulatory information, see the regulatory compliance website located at www.dell.com/regulatory_compliance.

Contacting Dell

For customers in the United States, call 800-WWW-DELL (800-999-3355).



NOTE: If you do not have an active Internet connection, you can find contact information on your purchase invoice, packing slip, bill, or Dell product catalog.

Dell provides several online and telephone-based support and service options. Availability varies by country and product, and some services may not be available in your area. To contact Dell for sales, technical support, or customer service issues:

1. Visit support.dell.com.
2. Verify your country or region in the **Choose A Country/Region** drop-down menu at the bottom of the page.
3. Click **Contact Us** on the left side of the page.
4. Select the appropriate service or support link based on your need.
5. Choose the method of contacting Dell that is convenient for you.

[Back to Contents Page](#)

[Back to Contents Page](#)

Setting Up Your Monitor

Dell™ 1909W AIO Flat Panel Monitor For Dell OptiPlex™ USFF Computer

If you have a Dell™ desktop or a Dell™ portable computer with internet access

1. Go to <http://support.dell.com>, enter your service tag, and download the latest driver for your graphics card.
2. After installing the drivers for your Graphics Adapter, attempt to set the resolution to **1440x900** again.

 **NOTE:** If you are unable to set the resolution to 1440x900, please contact Dell™ to inquire about a Graphics Adapter that supports these resolutions.

[Back to Contents Page](#)

[Back to Contents Page](#)

Setting Up Your Monitor

Dell™ 1909W AIO Flat Panel Monitor For Dell OptiPlex™ USFF Computer

If you have a non Dell™ desktop, portable computer or graphics card

1. Right-click on the desktop and click **Properties**.
2. Select the **Settings** tab.
3. Select **Advanced**.
4. Identify your graphics controller supplier from the description at the top of the window (e.g. NVIDIA, ATI, Intel etc.).
5. Refer to the graphic card provider website for updated driver (for example, <http://www.ATI.com> OR <http://www.NVIDIA.com>).
6. After installing the drivers for your Graphics Adapter, attempt to set the resolution to **1440X900** again.

 **NOTE:** If you are unable to set the resolution to 1440x900, please contact the manufacturer of your computer or consider purchasing a graphics adapter that will support the video resolution of 1440x900.

[Back to Contents Page](#)

Operating the Monitor





Dell™ 1909W AIO Flat Panel Monitor For Dell OptiPlex™ USFF Computer

- [Using the Front Panel Controls](#)
- [Using the On-Screen Display \(OSD\) Menu](#)
- [Using the Dell Soundbar \(Optional\)](#)
- [Height Adjustment](#)
- [Using the Tilt](#)

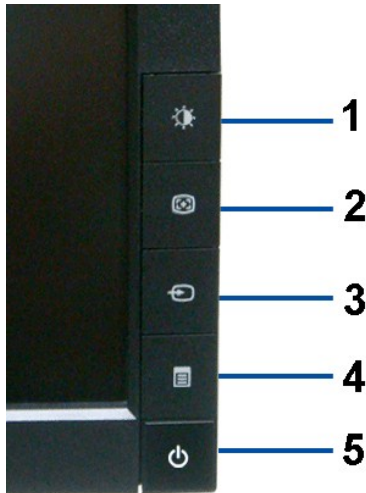
Using the Front Panel

Use the control buttons on the front of the monitor to adjust the characteristics of the image being displayed. As you use these buttons to adjust the controls, an OSD shows the numeric values of the characteristics as they change.



Front panel Button	Description
<p>1</p>  <p>Brightness&Contrast /Adjust UP</p>	<p>Use this button to directly access the "Brightness/Contrast" menu or to increase the values of the selected menu option.</p>
<p>2</p>  <p>Automatic Adjust /Adjust Down</p>	<p>Use Auto Adjust to activate automatic setup/adjustment or to decrease the values of the selected menu option. The following dialog appears on a black screen as the monitor self-adjusts to the current input:</p> <div style="background-color: black; color: white; text-align: center; padding: 10px; margin: 10px 0;"> <p>Auto Adjustment in Progress...</p> </div> <p>Auto Adjustment allows the monitor to self-adjust to the incoming video signal. After using Auto Adjustment, you can further tune your monitor by using the Pixel Clock (Coarse) and Phase (Fine) controls under Image Settings.</p> <p>NOTE: Auto Adjust does not occur if you press the button while there are no active video input signals or attached cables.</p>
<p>3</p>  <p>Input Source Select/Select</p>	<p>Use this button to select the input source or select an OSD menu option. Use the Input source button to select one of the two different video signals that may be connected to your monitor:</p> <ul style="list-style-type: none"> 1 VGA input 1 DVI-D input <div style="display: flex; align-items: center; justify-content: center; margin-top: 10px;"> <div style="background-color: black; color: white; padding: 5px; margin-right: 10px;"> 1: Auto Detect(Analog)  </div> or <div style="background-color: black; color: white; padding: 5px; margin-left: 10px;"> 1: Auto Detect(Digital)  </div> </div>

	<div style="display: flex; justify-content: space-around; align-items: center;"> <div style="background-color: #333; color: white; padding: 5px; border: 1px solid #555;">2: Analog Input </div> or <div style="background-color: #333; color: white; padding: 5px; border: 1px solid #555;">3: Digital Input </div> </div> <p>If either VGA or DVI-D input is selected and both VGA and DVI-D cables are not connected, a floating dialog box as shown below appears.</p> <div style="display: flex; justify-content: space-around; align-items: center;"> <div style="background-color: #333; color: white; padding: 5px; border: 1px solid #555; text-align: center;"> No VGA Cable Dell 1909W </div> or <div style="background-color: #333; color: white; padding: 5px; border: 1px solid #555; text-align: center;"> No DVI-D Cable Dell 1909W </div> </div>
<p>4</p> <div style="text-align: center;"> Menu </div>	<p>Use the MENU button to launch the on-screen display (OSD) and select the OSD Menu. See Accessing the Menu System.</p>
<p>5</p> <div style="text-align: center;"> Power (with power light indicator) </div>	<p>Use the Power button to turn the monitor on and off.</p> <p>The Blue LED indicates the monitor is on and fully functional. An amber LED indicates DPMS power save mode.</p>

Using the On-Screen Display (OSD) Menu

Accessing the Menu System

NOTE: If you change the settings and then either proceed to another menu or exit the OSD menu, the monitor automatically saves those changes. The changes are also saved if you change the settings and then wait for the OSD menu to disappear.

1. Push the MENU button to launch the OSD menu and display the main menu.

Main Menu for Analog (VGA) Input

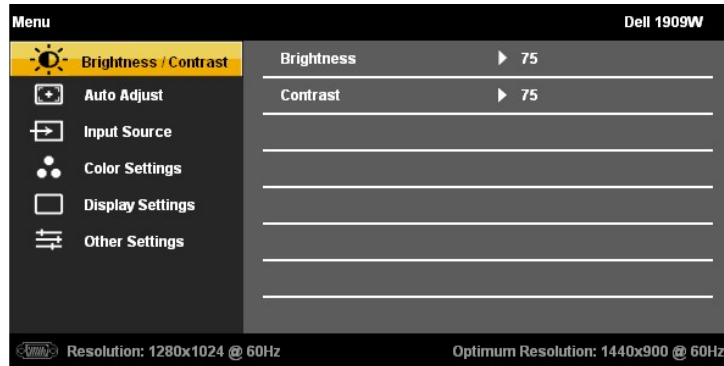

or



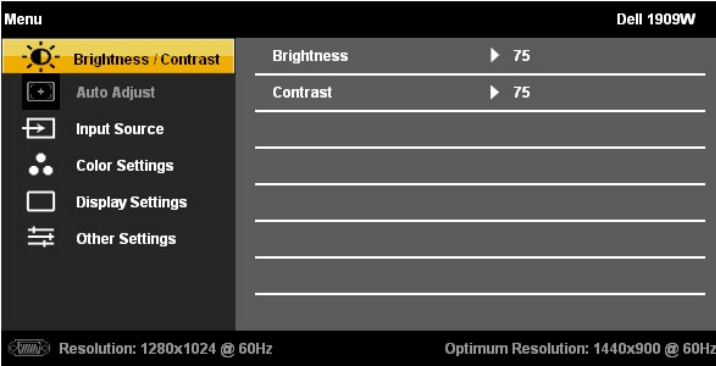

Main Menu for DVI Input

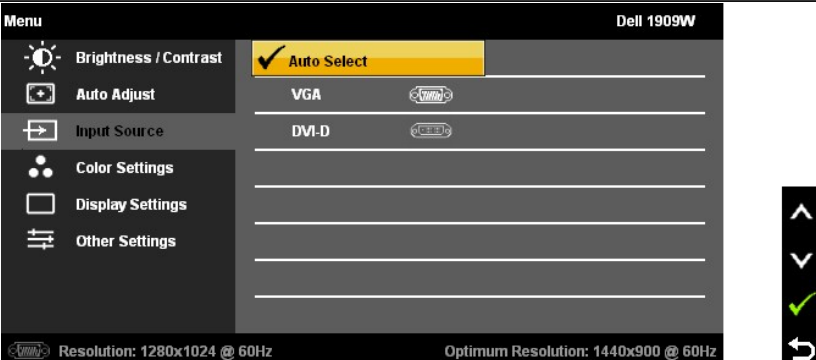

NOTE: AUTO ADJUST is only available when you use the analog (VGA) connector.

2. Push the and buttons to move between the setting options. As you move from one icon to another, the option name is highlighted. See the following table for a complete list of all the options available for the monitor.
3. Push the MENU button once to activate the highlighted option.
4. Push and button to select the desired parameter.
5. Push MENU to enter the slide bar and then use the and buttons, according to the indicators on the menu, to make your changes.
6. Select the "Menu/Exit" option to return to the main menu or exit the OSD menu.

Icon	Menu and Submenus	Description
	BRIGHTNESS & CONTRAST	Use this menu to activate Brightness/Contrast adjustment.
	Brightness	Brightness adjusts the luminance of the backlight. Push the button to increase brightness and push the button to decrease brightness (min 0 – max 100).
	Contrast	Adjust Brightness first, and then adjust Contrast only if further adjustment is necessary. Push the button to increase contrast and push the button to decrease contrast (min 0 ~ max 100). The Contrast function adjusts the degree of difference between darkness and lightness on the monitor screen.
	AUTO ADJUST	Even though your computer recognizes your monitor on startup, the Auto Adjustment function optimizes the display settings for use with your particular setup.

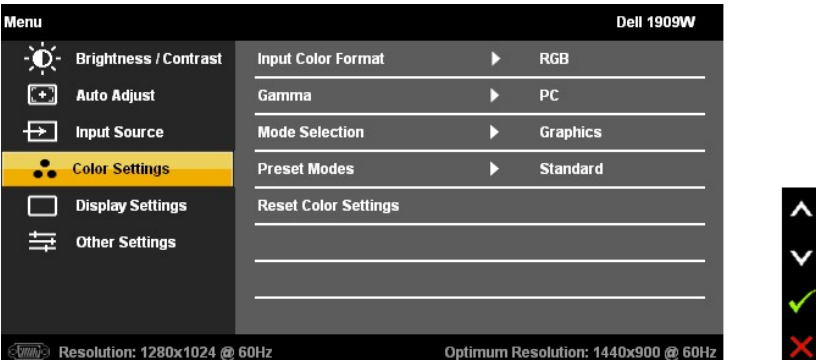

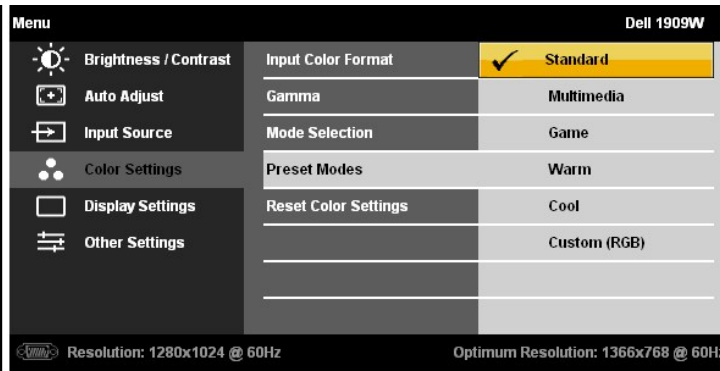



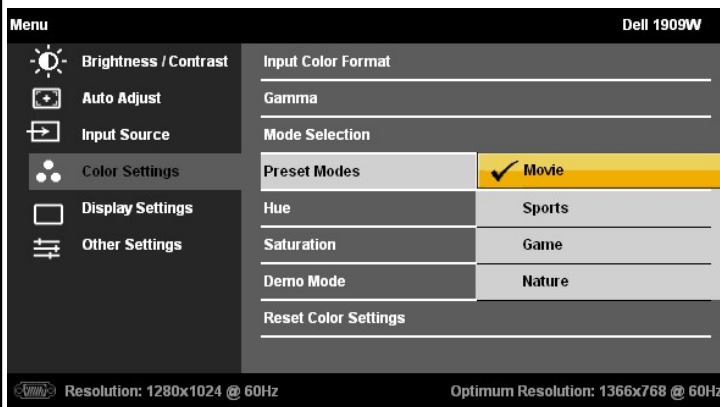

		<div style="background-color: black; color: white; text-align: center; padding: 10px; font-weight: bold;">Auto Adjustment in Progress...</div> <p>NOTE: In most cases, Auto Adjust produces the best image for your configuration.</p> <p>NOTE: AUTO ADJUST option is only available when you are using the analog (VGA) connector.</p>
	INPUT SOURCE	<p>Use the INPUT SOURCE menu to select between different video signals that may be connected to your monitor.</p> 
	VGA	Select VGA input when you are using the analog (VGA) connector. Push  to select the VGA input source.
	DVI-D	Select DVI-D input when you are using the Digital (DVI) connector. Push  to select the DVI input source.
	COLOR SETTINGS	<p>Use the Color Settings to adjust the color setting mode and color temperature. There are different color setting sub-menus for VGA/DVI-D and Video input.</p> 
	Input Color Format	Choose the RGB option if monitor is connected to a PC or a DVD using a VGA or DVI cable. Choose the YPbPr option if monitor is connected to a DVD by a YPbPr to VGA or YPbPr to DVI cable or if the DVD color output setting is not RGB.
	Mode Selection	You can choose Graphics or Video according to the input signal. Select Graphics if connecting a PC to your monitor; for connecting DVD, STB or VCR to your monitor, Video is recommended.
	Presets Modes	<p>When you select Graphics, you can choose Standard, Multimedia, Game, Warm, Cool, or Custom (R,G,B):</p> <ul style="list-style-type: none"> 1 If you view media application like photo, clip etc via PC, choose "Multimedia" preset; 1 If you play a game in PC, choose "Gaming" preset; 1 If you prefer a lower color temperature (5700K), choose "Warm" preset; 1 If you prefer a higher color temperature, choose "Cool" preset; 1 Custom (R, G, B) Preset offers a range of 6500K colors; 1 Choose "Standard" to utilize the panel native color format; 1 Select Warm preset for a reddish tint. This color setting is used for color-intensive applications (photograph image editing, multimedia, movies, etc.) 1 Select Cool preset for a bluish tint. This color setting is used for text based applications (spreadsheets, programming, text editors, etc.) 1 Select Custom preset to increase or decrease each of the three colors (R, G, B) independently, in single digit increments, from 0 to 100.



When you select Video, you can choose Movie, Game, Sports, or Nature preset:

- 1 For playing a movie, choose "Movie" preset;
- 1 For playing a sport program, choose "Sports" preset;
- 1 For playing a game, choose "Game" preset;
- 1 For general picture or web or watch TV, choose Nature preset. You can adjust the Hue(Tint)/Saturation based on your preference. If you want to restore default color settings, choose Color Reset;
- 1 Select Color Reset preset to restore default (factory) Color settings. This setting is also the "sRGB" standard default color space.



<p>Hue</p>	<p>This feature can shift color of video image to green or purple. This is used to adjust the desired flesh tone color. Use  or  to adjust the hue from '0' to '100'.</p> <p>Push  to increase the green shade of the video image</p> <p>Push  to decrease the purple shade of the video image</p> <p>NOTE: Hue adjustment is available only for video input.</p>
<p>Saturation</p>	<p>This feature can adjust the color saturation of the video image. Use  or  to adjust the saturation from '0' to '100'.</p> <p>Push  to increase the monochrome appearance of the video image</p> <p>Push  to decrease the colorful appearance of the video image</p> <p>NOTE: Saturation adjustment is available only for video input.</p>
<p>Demo Mode</p>	<p>To show side-by-side the effect of color enhancement</p>
<p>Reset Color Settings</p>	<p>Reset your monitor color settings to the factory settings.</p>
<p> DISPLAY SETTINGS</p>	<p>Use the Display Settings to adjust image.</p>

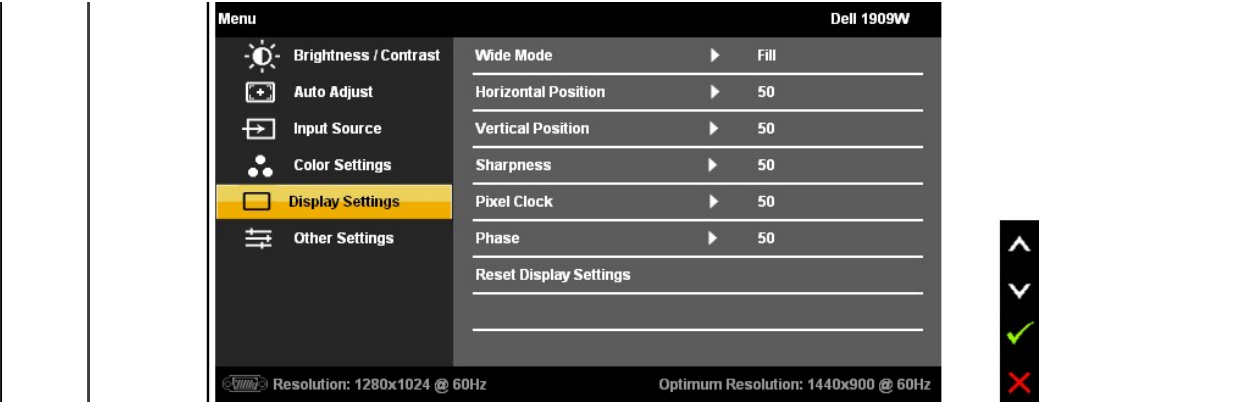

Wide Mode	Adjust the image ratio as 4: 3 or full screen.
Horizontal Position	Use the or buttons to adjust image left and right. Minimum is '0' (-). Maximum is '100' (+).
Vertical Position	Use the or buttons to adjust image up and down. Minimum is '0' (-). Maximum is '100' (+).
Sharpness	This feature can make the image look sharper or softer. Use or to adjust the sharpness from '0' to '100'.
Pixel Clock	The Phase and Pixel Clock adjustments allow you to adjust your monitor to your preference. These settings are accessed through the main OSD menu, by selecting 'Image Settings'. Use the or buttons to adjust for best image quality.
Phase	If satisfactory results are not obtained using the Phase adjustment, use the Pixel Clock (coarse) adjustment and then use Phase (fine), again. NOTE: Pixel Clock and Phase Adjustments are only available for "VGA" input.
Reset Display Settings	Select this option to restore default display settings.

OTHER SETTINGS Select this option to adjust the settings of the OSD, such as, the languages of the OSD, the amount of time the menu remains on screen, and so on.

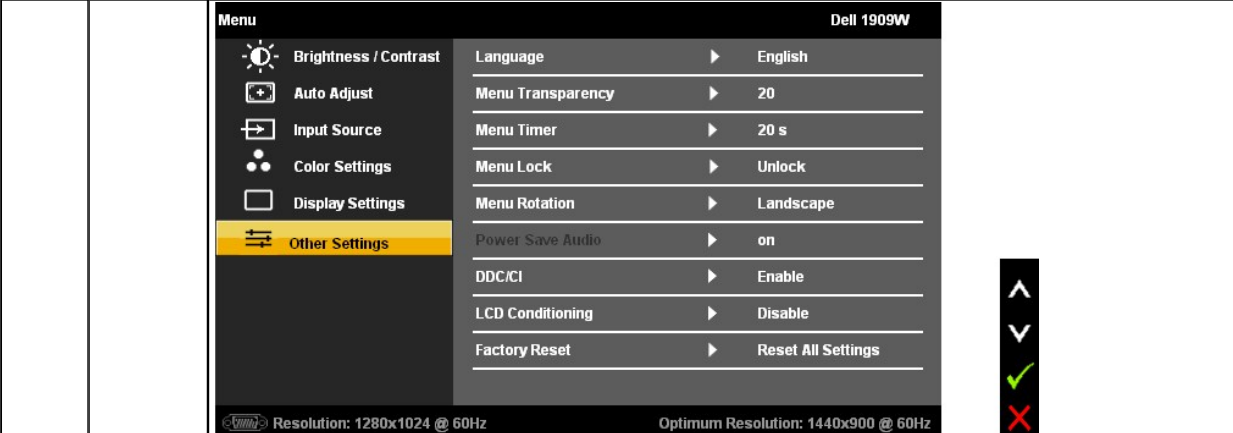

Language	Language option to set the OSD display to one of seven languages (English, Espanol, Francais, Deutsch, Russian ,Simplified chinese or Japanese).
Menu Transparency	Select this option to change the menu transparency by pressing or (Minimum: 0 ~ Maximum: 100).
Menu Timer	OSD Hold Time: Sets the length of time the OSD will remain active after the last time you pressed a button. Use the or buttons to adjust the slider in 5 second increments, from 5 to 60 seconds.
Menu Lock	Controls user access to adjustments. When 'Lock' is selected, no user adjustments are allowed. All buttons are locked except the menu button. NOTE: When the OSD is locked, pressing the menu button takes the user directly to the OSD settings menu, with OSD Lock selected. Select "Unlock" to unlock and allow user access to all applicable settings.
Menu Rotation	Rotates the OSD by 90 degrees counter-clockwise.
Power Save Audio	To turn on or off Audio Power during Power Save mode.
DDC/CI	DDC/CI (Display Data Channel/Command Interface) allows your monitor parameters (brightness, color balance etc) to be adjustable

via software on your PC. You can disable this feature by selecting "Disable". Enable this feature for best user experience and optimum performance of your monitor.

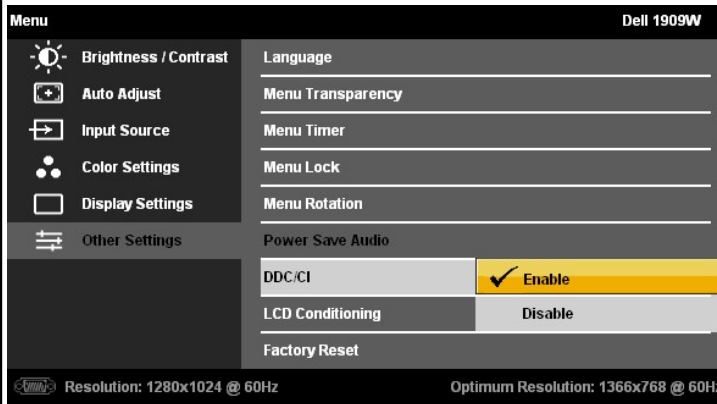

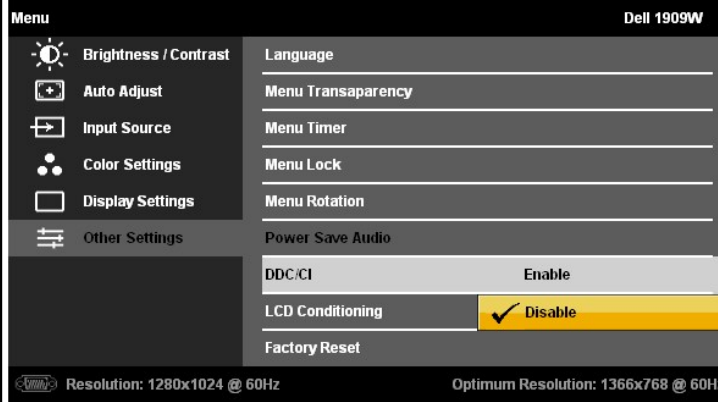
<p>LCD Conditioning</p>	<p>Helps reduce minor cases of image retention. Depending on the degree of image retention, the program may take some time to run. You can enable this feature by selecting "Enable".</p>  <p>The screenshot shows the OSD menu with 'LCD Conditioning' highlighted in yellow with a checkmark and the word 'Disable'. The 'DDC/CI' setting is now 'Enable'. The rest of the menu structure is the same as in the previous screenshot.</p>
<p>Factory Reset</p>	<p>Reset all OSD settings to the factory preset values.</p>



Note: This monitor has a build-in feature to automatically calibrate the brightness to compensate for CCFL aging.

OSD Warning Messages

When the monitor does not support a particular resolution mode you will see the following message:

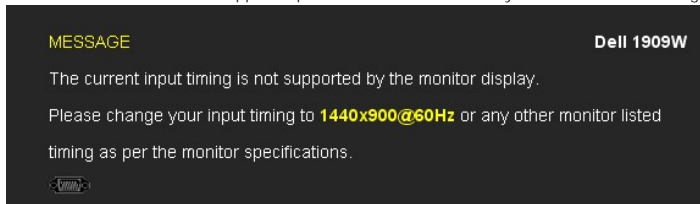

This means that the monitor cannot synchronize with the signal that it is receiving from the computer. See [Monitor Specifications](#) for the Horizontal and Vertical frequency ranges addressable by this monitor. Recommended mode is 1440 x 900.

You will see the following message before the DDC/CI function is disabled.

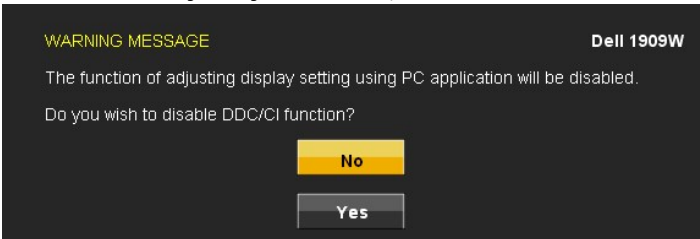

When monitor enters Power Save mode, the following message appears:

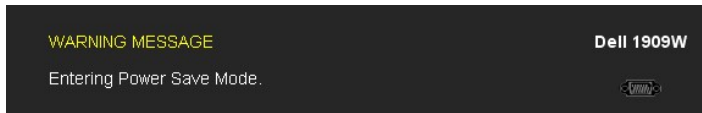

Activate the computer and wake up the monitor to gain access to the [OSD](#)

If you press any button other than the power button one of the following messages will appear depending on the selected input:
VGA/DVI-D input

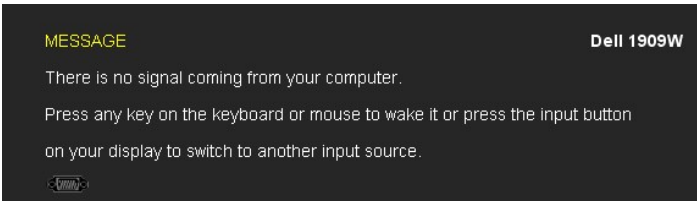

If either VGA or DVI-D input is selected and both VGA and DVI-D cables are not connected, a floating dialog box as shown below appears.

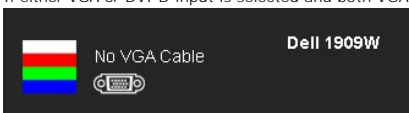

or

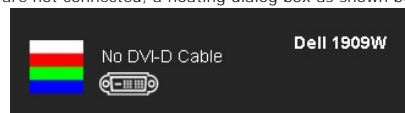

See [Solving Problems](#) for more information.

Using the Dell Soundbar (Optional)



1. Attach mechanism
2. Power/volume control
3. Power indicator
4. Headphone connectors

Height Adjustment

Stand extends vertically 90mm for viewing comfort.



Using the Tilt

With the built-in pedestal, you can tilt the monitor for the most comfortable viewing angle.



 **NOTE:** The stand is detached when the monitor is shipped from the factory.

[Back to Contents Page](#)

[Back to Contents Page](#)

Setting Up Your Monitor

Dell™ 1909W AIO Flat Panel Monitor For Dell OptiPlex™ USFF Computer

Setting the display resolution to 1440X900 (Optimal)

For optimal display performance while using the Microsoft Windows operating systems, set the display resolution to 1440 x 900 pixels by performing the following steps:

1. Right-click on the desktop and click **Properties**.
2. Select the **Settings** tab.
3. Move the slider-bar to the right by pressing and holding left-mouse button and adjust the screen resolution to **1440 X900**.
4. Click **OK**.

If you do not see **1440X900** as an option, you may need to update your graphics driver. Please choose the scenario below that best describes the computer system you are using, and follow the provided directions:

1: [If you have a Dell™ desktop or a Dell™ portable computer with internet access.](#)

2: [If you have a non Dell™ desktop, portable computer, or graphics card.](#)

[Back to Contents Page](#)

Dell™ 1909W AIO Flat Panel Monitor For Dell OptiPlex™ USFF Computer

[User Guide](#)

[Setting the display resolution to 1440x900\(Optimal\)](#)

Information in this document is subject to change without notice.
© 2008 Dell Inc. All rights reserved

Reproduction of these materials in any manner whatsoever without the written permission of Dell Inc. is strictly forbidden.

Trademarks used in this text: *Dell* and the *DELL* logo are trademarks of Dell Inc; *Microsoft* and *Windows* are either trademarks or registered trademarks of Microsoft Corporation in the United States and/or other countries. ENERGY STAR is a registered trademark of the U.S. Environmental Protection Agency. As an ENERGY STAR partner, Dell Inc. has determined that this product meets the ENERGY STAR guidelines for energy efficiency.

Other trademarks and trade names may be used in this document to refer to either the entities claiming the marks and names or their products. Dell Inc. disclaims any proprietary interest in trademarks and trade names other than its own.

Model 1909Wf

September 2008 Rev. A00

Setting Up the Monitor

Dell™ 1909W AIO Flat Panel Monitor For Dell OptiPlex™ USFF Computer

- [Attaching the Stand](#)
 - [Cable Connections on the Back of the Monitor and the Computer](#)
 - [Detaching the Monitor from the Stand](#)
 - [Attaching the Soundbar \(optional\)](#)
-

Attaching the Stand

Attach the monitor to the stand:

1. Place the stand on a flat surface
2. Fit the groove on the back of the monitor onto the two metal tabs on stand.
3. Lower the monitor until it locked into place on the stand.

 **NOTE:** The stand is detached when the monitor is shipped from the factory.

 **NOTE:** If you want to mount your AIO stand to a desktop, see the [AIO Stand Template Sheet \(*.pdf\)](#)



Cable Connections on the Back of the Monitor and the Computer

1. Slide the computer onto the stand. Push it in until the computer touches the locating tab in the stand.



2. Tighten the thumbscrews underneath the stand.



3. Connect the DVI cable to the computer. Route DVI cable as shown.

 **NOTE:** This cable is shipped attached to the monitor.



4. Route the monitor power cable through the opening in the bottom of Cable Cover and connect it to the power cord receptacle on the back of the monitor.

 **NOTE:** The monitor power cable and the cable cover are shipped with the monitor.



5. Route the computer power adaptor cable (shipped with the computer) through the opening in the bottom of Cable Cover and connect it to the computer. Push in until it clicks.



6. Connect the USB, keyboard and mouse cables to the computer as shown.

- a. Connect the short USB cable (shipped with monitor) to the upstream port of the monitor. Route this cable through the opening on the side of the cable cover. Connect the other end of USB cable to any computer USB downstream port.
- b. Route the mouse and keyboard cables through the opening in the bottom of Cable Cover and connect to two USB ports on the computer.

NOTE: There are four USB ports available on the back of the computer.

- c. Route any other cables that connect to the computer (network, printer, external audio, etc.) through the opening in the bottom of Cable Cover before connecting them to the computer. Connect all the cables before installing the cable cover.

Route all the cables that connect to the monitor (video, optional audio, power for monitor, power for optional audio) through the opening on the side of the



cable cover

7. Connect the power cables to an outlet. Install the cable cover.

- a. Install the Cable Cover, being careful not to disconnect any of the cables.
- b. Connect the computer power cable to the computer power adaptor.
- c. Plug the power cables of the computer and the monitor into a nearby outlet.



8. (Optional) Install security lock to the cable cover

Power on both monitor and computer. If your monitor displays an image, installation is complete. If it does not display an image, see [Troubleshooting](#).



Removing the Cable Cover and Cables from the Computer

1. Remove the optional security lock (if used).
2. Lift the unlock button in the cable cover, and lift the cable cover to remove it.



3. Push in the release button on the power cable before removing it from the computer.



Detaching the Monitor from the Stand

This monitor is VESA compliant for wall mounting, and detaching the monitor from the stand is necessary.

Steps for removing the monitor from the stand:

1. Press the stand removal button to release the stand.



2. Pick up the bottom of the stand. There are two metal tabs at the top of the VESA plate that insert into the monitor. Pull the bottom of the monitor away from the stand, being careful not to scratch the monitor with the stand.



Attaching the Dell Soundbar



- ➡ **NOTICE: Do not use the soundbar power connector with any other device.**
1. Attach the Soundbar by aligning the two slots on the Soundbar with the two tabs on the bottom of the monitor.
 2. Slide the Soundbar to the left until it snaps in to place.
 3. Plug in the power cord from the Soundbar in to the connector on the back of the monitor.
 4. Insert the green stereo plug from the Soundbar in to your computer's audio output connector.
- 📌 **NOTE:** Soundbar Power Connector +12V DC output is for optional only.
 - ➡ **NOTICE: Do not use with any device other than Dell Soundbar .**
-

[Back to Contents Page](#)

Troubleshooting

Dell™ 1909W AIO Flat Panel Monitor For Dell OptiPlex™ USFF Computer

- [Self-Test](#)
- [Common Problems](#)
- [Product Specific Problems](#)
- [Universal Serial Bus Specific Problems](#)
- [Dell Soundbar Problems](#)

CAUTION: Before you begin any of the procedures in this section, follow the [Safety Instructions](#).

Self-Test

Your monitor provides a self-test feature that allows you to check whether your monitor is functioning properly. If your monitor and computer are properly connected but the monitor screen remains dark, run the monitor self-test by performing the following steps:

1. Turn off both your computer and the monitor.
2. Unplug the video cable from the back of the computer. To ensure proper Self-Test operation, remove both Digital (white connector) and the Analog (blue connector) cables from the back of computer.
3. Turn on the monitor.

The floating dialog box should appear on-screen (against a black background) if the monitor cannot sense a video signal and is working correctly. While in self-test mode, the power LED remains green. Also, depending upon the selected input, one of the dialogs shown below will continuously scroll through the screen.



4. This box also appears during normal system operation, if the video cable becomes disconnected or damaged.
5. Turn off your monitor and reconnect the video cable; then turn on both your computer and the monitor.

If your monitor screen remains blank after you use the previous procedure, check your video controller and computer, because your monitor is functioning properly.



NOTE: Self test feature check is not available for S-Video, Composite, and Component video modes.

Built-in Diagnostics

Your monitor has a built-in diagnostic tool that helps you determine if the screen abnormality you are experiencing is an inherent problem with your monitor, or with your computer and video card.

NOTE: You can run the built-in diagnostics only when the video cable is unplugged and the monitor is in *self-test mode*.

To run the built-in diagnostics:

1. Ensure that the screen is clean (no dust particles on the surface of the screen).
2. Unplug the video cable(s) from the back of the computer or monitor. The monitor then goes into the self-test mode.
3. Press and hold the  and  buttons on the front panel, simultaneously for 2 seconds. A gray screen appears.
4. Carefully inspect the screen for abnormalities.
5. Press the  button on the front panel again. The color of the screen changes to red.
6. Inspect the display for any abnormalities.
7. Repeat steps 5 and 6 to inspect the display in green, blue, and white colored screens.

The test is complete when the white screen appears. To exit, press the  button again.

If you do not detect any screen abnormalities upon using the built-in diagnostic tool, the monitor is functioning properly. Check the video card and computer.

Common Problems

The following table contains general information about common monitor problems you might encounter and the possible solutions.

Common Symptoms	What You Experience	Possible Solutions
No Video/Power LED off	No picture	<ul style="list-style-type: none"> 1 Ensure that the video cable connecting the monitor and the computer is properly connected and secure. 1 Verify that the power outlet is functioning properly using any other electrical equipment. 1 Ensure that the power button is depressed fully.
No Video/Power LED on	No picture or no brightness	<ul style="list-style-type: none"> 1 Increase brightness & contrast controls via OSD. 1 Perform monitor self-test feature check. 1 Check for bent or broken pins in the video cable connector. 1 Run the built-in diagnostics.
Poor Focus	Picture is fuzzy, blurry, or ghosting	<ul style="list-style-type: none"> 1 Perform Auto Adjust via OSD. 1 Adjust the Phase and Pixel Clock controls via OSD. 1 Eliminate video extension cables. 1 Reset the monitor to Factory Settings. 1 Change the video resolution to the correct aspect ratio (16:10).
Shaky/Jittery Video	Wavy picture or fine movement	<ul style="list-style-type: none"> 1 Perform Auto Adjust via OSD. 1 Adjust the Phase and Pixel Clock controls via OSD. 1 Reset the monitor to Factory Settings. 1 Check environmental factors. 1 Relocate the monitor and test in another room.
Missing Pixels	LCD screen has spots	<ul style="list-style-type: none"> 1 Cycle power on-off. 1 Pixel that is permanently off is a natural defect that can occur in LCD technology. 1 Run the built-in diagnostics.
Stuck-on Pixels	LCD screen has bright spots	<ul style="list-style-type: none"> 1 Cycle power on-off. 1 Pixel that is permanently off is a natural defect that can occur in LCD technology. 1 Run the built-in diagnostics.
Brightness Problems	Picture too dim or too bright	<ul style="list-style-type: none"> 1 Reset the monitor to Factory Settings. 1 Auto Adjust via OSD. 1 Adjust brightness & contrast controls via OSD.
Geometric Distortion	Screen not centered correctly	<ul style="list-style-type: none"> 1 Reset the monitor to Factory Settings. 1 Auto Adjust via OSD. 1 Adjust brightness & contrast controls via OSD. <p>NOTE: When using '2: DVI-D', the positioning adjustments are not available.</p>
Horizontal/Vertical Lines	Screen has one or more lines	<ul style="list-style-type: none"> 1 Reset the monitor to Factory Settings. 1 Perform Auto Adjust via OSD. 1 Adjust Phase and Pixel Clock controls via OSD. 1 Perform monitor self-test feature check and determine if these lines are also in self-test mode. 1 Check for bent or broken pins in the video cable connector. 1 Run the built-in diagnostics. <p>NOTE: When using '2: DVI-D', the Pixel Clock and Phase adjustments are not available.</p>
Synchronization Problems	Screen is scrambled or appears torn	<ul style="list-style-type: none"> 1 Reset the monitor to Factory Settings. 1 Perform Auto Adjust via OSD. 1 Adjust Phase and Pixel Clock controls via OSD. 1 Perform monitor self-test feature check to determine if the scrambled screen appears in self-test mode. 1 Check for bent or broken pins in the video cable connector. 1 Restart the computer in the <i>safe mode</i>.
Safety Related Issues	Visible signs of smoke or sparks	<ul style="list-style-type: none"> 1 Do not perform any troubleshooting steps. 1 Contact Dell immediately.
Intermittent Problems	Monitor malfunctions on & off	<ul style="list-style-type: none"> 1 Ensure that the video cable connecting the monitor to the computer is connected properly and is secure. 1 Reset the monitor to Factory Settings. 1 Perform monitor self-test feature check to determine if the intermittent problem occurs in self-test mode.
Missing Color	Picture missing color	<ul style="list-style-type: none"> 1 Perform monitor self-test feature check. 1 Ensure that the video cable connecting the monitor to the computer is connected properly and is secure. 1 Check for bent or broken pins in the video cable connector.
Wrong Color	Picture color not good	<ul style="list-style-type: none"> 1 Change the Color Setting Mode in the Color Settings OSD to Graphics or Video depending on the application. 1 Try different Color Preset Settings in Color Settings OSD. Adjust R/G/B value in Color Settings OSD if the Color Management is turned off. 1 Change the Input Color Format to PC RGB or YPbPr in the Advance Setting OSD. 1 Run the built-in diagnostics.
Image retention from a static image left on the monitor for a long period of time	Faint shadow from the static image displayed appears on the screen	<ul style="list-style-type: none"> 1 Use the Power Management feature to turn off the monitor at all times when not in use (for more information, see Power Management Modes). 1 Alternatively, use a dynamically changing screensaver.

Product Specific Problems

Specific Symptoms	What You Experience	Possible Solutions
Screen image is too small	Image is centered on screen,	<ul style="list-style-type: none"> 1 Check the Scaling Ratio setting in Image Setting OSD

	but does not fill entire viewing area	<ul style="list-style-type: none"> 1 Reset the monitor to Factory Settings.
Cannot adjust the monitor with the buttons on the front panel	OSD does not appear on the screen	<ul style="list-style-type: none"> 1 Turn off the monitor, unplug the power cord, plug back, and then turn on the monitor.
No Input Signal when user controls are pressed	No picture, the LED light is green. When you press "+", "-", or "Menu" key, the message "No S-Video input signal", or "No Composite input signal", or "No Component input signal" appears	<ul style="list-style-type: none"> 1 Check the signal source. Ensure the Computer is not in the power saving mode by moving the mouse or pressing any key on the keyboard. 1 Check to make sure Video Source to S-Video, Composite or Component is powered and playing video media. 1 Check whether the signal cable is plugged in properly. Re-plug the signal cable if necessary. 1 Reset the computer or video player.
The picture does not fill the entire screen.	The picture cannot fill the height or width of the screen	<ul style="list-style-type: none"> 1 Due to different video formats (aspect ratio) of DVDs, the monitor may display in full screen. 1 Run the built-in diagnostics.

 **NOTE:** When choosing DVI-D mode, the **Auto Adjust** function is not available.

Universal Serial Bus (USB) Specific Problems

Specific Symptoms	What You Experience	Possible Solutions
USB interface is not working	USB peripherals are not working	<ul style="list-style-type: none"> 1 Check that your monitor is turned ON. 1 Reconnect the upstream cable to your computer. 1 Reconnect the USB peripherals (downstream connector). 1 Switch off and then turn on the monitor again. 1 Reboot the computer. 1 Some USB devices like external portable HDD require higher electric current; connect the device directly to the computer system.
High Speed USB 2.0 interface is slow.	High Speed USB 2.0 peripherals working slowly or not working at all	<ul style="list-style-type: none"> 1 Check that your computer is USB 2.0-capable. 1 Some computers have both USB 2.0 and USB 1.1 ports. Ensure that the correct USB port is used. 1 Reconnect the upstream cable to your computer. 1 Reconnect the USB peripherals (downstream connector). 1 Reboot the computer.

Dell™ Soundbar Problems

Common Symptoms	What You Experience	Possible Solutions
No Sound	No power to Soundbar - the power indicator is off	<ul style="list-style-type: none"> 1 Turn the Power/Volume knob on the Soundbar clockwise to the middle position; check if the power indicator (green LED) on the front of the Soundbar is illuminated. 1 Confirm that the power cable from the Soundbar is plugged into the adaptor.
No Sound	Soundbar has power - power indicator is on	<ul style="list-style-type: none"> 1 Plug the audio line-in cable into the computer's audio out jack. 1 Set all Windows volume controls to their maximum 1 Play some audio content on the computer (i.e. audio CD, or MP3). 1 Turn the Power/Volume knob on the Soundbar clockwise to a higher volume setting. 1 Clean and reseal the audio line-in plug. 1 Test the Soundbar using another audio source (i.e. portable CD player).
Distorted Sound	Computer's sound card is used as the audio source	<ul style="list-style-type: none"> 1 Clear any obstructions between the Soundbar and the user. 1 Confirm that the audio line-in plug is completely inserted into the jack of the sound card. 1 Set all Windows volume controls to their midpoints. 1 Decrease the volume of the audio application. 1 Turn the Power/Volume knob on the Soundbar counter-clockwise to a lower volume setting. 1 Clean and reseal the audio line-in plug. 1 Troubleshoot the computer's sound card. 1 Test the Soundbar using another audio source (i.e. portable CD player, MP3 player).
Distorted Sound	Other audio source is used	<ul style="list-style-type: none"> 1 Clear any obstructions between the Soundbar and the user. 1 Confirm that the audio line-in plug is completely inserted into the jack of the audio source. 1 Decrease the volume of the audio source. 1 Turn the Power/Volume knob on the Soundbar counter-clockwise to a lower volume setting. 1 Clean and reseal the audio line-in plug.
Unbalanced Sound Output	Sound from only one side of Soundbar	<ul style="list-style-type: none"> 1 Clear any obstructions between the Soundbar and the user. 1 Confirm that the audio line-in plug is completely inserted into the jack of the sound card or audio source. 1 Set all Windows audio balance controls (L-R) to their midpoints. 1 Clean and reseal the audio line-in plug. 1 Troubleshoot the computer's sound card. 1 Test the Soundbar using another audio source (i.e. portable CD player).
Low Volume	Volume is too low	<ul style="list-style-type: none"> 1 Clear any obstructions between the Soundbar and the user. 1 Turn the Power/Volume knob on the Soundbar clockwise to the maximum volume setting. 1 Set all Windows volume controls to their maximum. 1 Increase the volume of the audio application. 1 Test the Soundbar using another audio source (i.e. portable CD player, MP3 player).

[Back to Contents Page](#)

Free Manuals Download Website

<http://myh66.com>

<http://usermanuals.us>

<http://www.somanuals.com>

<http://www.4manuals.cc>

<http://www.manual-lib.com>

<http://www.404manual.com>

<http://www.luxmanual.com>

<http://aubethermostatmanual.com>

Golf course search by state

<http://golfingnear.com>

Email search by domain

<http://emailbydomain.com>

Auto manuals search

<http://auto.somanuals.com>

TV manuals search

<http://tv.somanuals.com>