



Dell E2016 Monitor User's Guide

Model: E2016
Regulatory model: E2016t



-  **NOTE:** A NOTE indicates important information that helps you make better use of your computer.
-  **CAUTION:** A CAUTION indicates potential damage to hardware or loss of data if instructions are not followed.
-  **WARNING:** A WARNING indicates a potential for property damage, personal injury, or death.

Copyright © 2015 Dell Inc. All rights reserved. This product is protected by U.S. and international copyright and intellectual property laws.

Dell™ and the Dell logo are trademarks of Dell Inc. in the United States and/or other jurisdictions. All other marks and names mentioned herein may be trademarks of their respective companies.

Contents

| | |
|--|-----------|
| About Your Monitor | 5 |
| Package Contents | 5 |
| Product Features | 6 |
| Identifying Parts and Controls | 7 |
| Monitor Specifications | 8 |
| Plug-and-Play | 14 |
| LCD Monitor Quality and Pixel Policy | 14 |
| Setting Up the Monitor | 15 |
| Attaching the Stand | 15 |
| Attaching the Vesa Cover | 17 |
| Connecting Your Monitor | 17 |
| Organizing Your Cables | 18 |
| Removing the Vesa Cover | 18 |
| Removing the Monitor Stand | 19 |
| Wall Mounting (Optional) | 20 |
| Operating the Monitor | 21 |
| Turning on the Monitor | 21 |
| Using the Front Panel Controls | 21 |
| Using the On-Screen Display (OSD) Menu | 23 |
| Using Tilt | 34 |

| | |
|--|-----------|
| Troubleshooting | 35 |
| Self-Test | 35 |
| Built-in Diagnostics | 36 |
| Common Problems. | 37 |
| Product Specific Problems | 39 |
| Appendix | 40 |
| Safety Instructions | 40 |
| FCC Notices (U.S. only) and Other Regulatory Information | 40 |
| Contacting Dell | 40 |
| Setting Up Your Monitor | 41 |
| Maintenance Guidelines. | 43 |

About Your Monitor

Package Contents

Your monitor ships with the components shown below. Make sure that you have received all the components and [contact Dell](#) if something is missing.

 **NOTE:** Some items may be optional and may not ship with your monitor. Some features or media may not be available in certain countries.



Monitor



Stand riser



Stand base

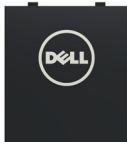

Vesa cover



Power cable (varies by country)



VGA Cable

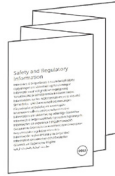

- Drivers and documentation media
- Quick Setup Guide
- Safety and Regulatory Information

Product Features

The **Dell E2016** flat panel display has an active matrix, thin-film transistor (TFT), liquid crystal display (LCD), and LED backlight. The monitor features include:

- 49.40 cm (19.45 inch) active area display (Measured diagonally) 1440 x 900 resolution, plus full-screen support for lower resolutions.
- Tilt capability.
- Removable pedestal and Video Electronics Standards Association (VESA™) 100 mm mounting holes for flexible mounting solutions.
- Plug and play capability if supported by your system.
- On-Screen Display (OSD) adjustments for ease of set-up and screen optimization.
- Software and documentation media includes an information file (INF), Image color Matching File (ICM), Dell Display Manager software application and product documentation. Dell Display Manager included (comes in the CD attached with the monitor).
- Security lock slot.
- Asset Management Capability.
- Energy Star Compliant.
- EPEAT Silver Compliant.
- RoHS compliant.
- BFR/PVC- reduced.
- Arsenic-Free glass and Mercury Free for Panel only.
- Energy Gauge shows the energy level being consumed by the monitor in real time.
- TCO Certified Displays.
- Analog backlight dimming control for flicker free display.
- CECP (for China only).

Identifying Parts and Controls

Front view



| Label | Description |
|-------|---|
| 1 | Function buttons (For more information, see Operating the Monitor) |
| 2 | Power on/off button (with LED indicator) |

Back View



| Label | Description | Use |
|-------|--|---|
| 1 | VESA mounting holes (100 mm x 100 mm - behind attached VESA cover) | Wall mount monitor using VESA-compatible wall mount kit (100 mm x 100 mm). |
| 2 | Regulatory label | Lists the regulatory approvals. |
| 3 | Security-lock slot | Secures monitor with security lock (sold separately). |
| 4 | Barcode serial number label | Refer to this label if you need to contact Dell for technical support. NOTE: Service tag printing (EMEA region only). |
| 5 | Dell Soundbar mounting slots | Attaches the optional Dell Soundbar. |
| 6 | Cable-management slot | Use to organize cables by placing them through the slot. |

Bottom View

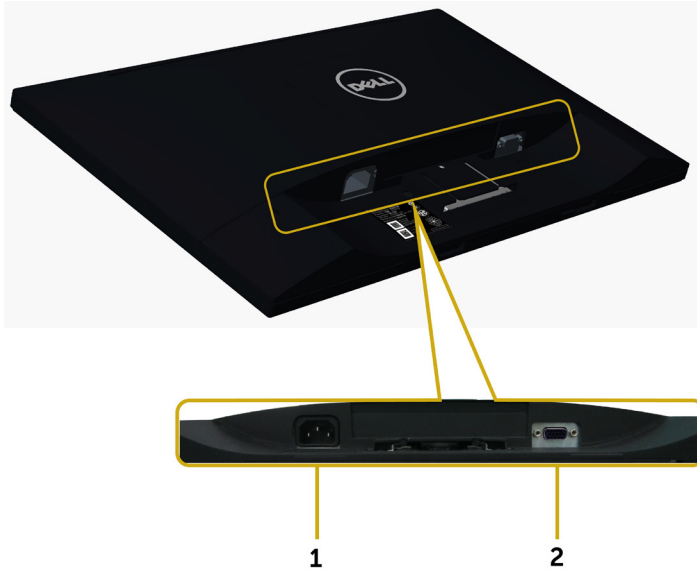

| Label | Description | Use |
|-------|--------------------|---------------------------------------|
| 1 | AC power connector | To connect the monitor power cable. |
| 2 | VGA port | Connect your computer with VGA cable. |

Monitor Specifications

Flat Panel Specifications

| | |
|------------------|---|
| Screen type | Active matrix - TFT LCD |
| Panel type | In-plane switching type |
| Viewable image: | |
| Diagonal | 49.40 cm (19.45 inches) |
| Active Area: | |
| Horizontal | 418.61 mm (16.48 inches) |
| Vertical | 262.35 mm (10.33 inches) |
| Area | 109821.81 mm ² (170.22 inch ²) |
| Pixel pitch | 0.2915 mm x 0.2915 mm |
| Viewing angle: | |
| Horizontal | 178° (typical) |
| Vertical | 178° (typical) |
| Luminance output | 250 cd/m ² (typical) |
| Contrast ratio | 1000:1 (typical) |

| | |
|-----------------------|-------------------------------------|
| Faceplate coating | AG type, hard-coating 3H |
| Backlight | LED |
| Response time | 6ms Typ. g-to-g with OD (Fast mode) |
| Color depth | 16.7 million colors |
| Color gamut (typical) | 72%* (CIE1931) |

*Color gamut (typical) is based on CIE1976 (85%) and CIE1931 (72%) test standards.

Resolution Specifications

| | |
|----------------------------|------------------------------|
| Horizontal scan range | 30 kHz to 83 kHz (automatic) |
| Vertical scan range | 56 Hz to 76 Hz (automatic) |
| Maximum preset resolution | 1440 x 900 at 60 Hz |
| Video display capabilities | 480i, 576i, 480p, 576p, 720p |

Preset Display Modes

| Display Mode | Horizontal Frequency (kHz) | Vertical Frequency (Hz) | Pixel Clock (MHz) | Sync Polarity (Horizontal/Vertical) |
|--------------|----------------------------|-------------------------|-------------------|-------------------------------------|
| 720 x 400 | 31.47 | 70 | 28.32 | -/+ |
| 640 x 480 | 31.47 | 60 | 25.18 | -/- |
| 640 x 480 | 37.50 | 75 | 31.50 | -/- |
| 800 x 600 | 37.88 | 60 | 40 | +/+ |
| 800 x 600 | 46.88 | 75 | 49.50 | +/+ |
| 1024 x 768 | 48.36 | 60 | 65 | -/- |
| 1024 x 768 | 60.02 | 75 | 78.75 | +/+ |
| 1152 x 864 | 67.50 | 75 | 108 | +/+ |
| 1280 x 1024 | 64 | 60 | 108 | +/+ |
| 1280 x 1024 | 80 | 75 | 135 | +/+ |
| 1280 x 800 | 49.70 | 60 | 83.50 | -/+ |
| 1440 x 900 | 55.94 | 60 | 106.50 | -/+ |
| 1440 x 900 | 70.60 | 75 | 136.75 | -/+ |

Electrical Specifications

| | |
|--|--|
| Video input signals | Analog RGB, 0.7 Volts +/-5%, positive polarity at 75 ohm input impedance |
| Synchronization input signals | Separate horizontal and vertical synchronization, polarity-free TTL level, SOG (Composite SYNC on green) |
| AC input voltage/ frequency/current | 100 VAC to 240 VAC/ 50 Hz or 60 Hz + 3 Hz/1.5 A (Max.) |
| Inrush current | 120 V:30 A (Max.) 240 V:60 A (Max.) |

Physical Characteristics

| | |
|---|--|
| Connector type | 15-pin D-subminiature (black connector). |
| Signal cable type | Analog: Detachable, D-Sub, 15 pins. |
| Dimensions (with stand): | |
| Height | 390.95 mm (15.39 inches) |
| Width | 454.21 mm (17.88 inches) |
| Depth | 180 mm (7.09 inches) |
| Dimensions (without stand): | |
| Height | 297.95 mm (11.73 inches) |
| Width | 454.21 mm (17.88 inches) |
| Depth | 50.99 mm (2 inches) |
| Stand dimensions: | |
| Height | 176.80 mm (6.96 inches) |
| Width | 250 mm (9.84 inches) |
| Depth | 180 mm (7.09 inches) |
| Weight: | |
| With packaging | 4.18 kg (9.22 lb) |
| With stand assembly and cables | 3.05 kg (6.72 lb) |
| Without stand assembly (for wall mount or VESA mount considerations - no cables) | 2.29 kg (5.05 lb) |
| Stand assembly | 0.52 kg (1.15 lb) |

Environmental Characteristics

| | |
|---------------------|--|
| Temperature: | |
| Operating | 0°C to 40°C (32°F to 104°F) |
| Non-operating | -20°C to 60°C (-4°F to 140°F) |
| Humidity: | |
| Operating | 10% to 80% (non-condensing) |
| Non-operating | 5% to 90% (non-condensing) |
| Altitude: | |
| Operating | 5,000 m (16,404 ft) (maximum) |
| Non-operating | 12,192 m (40,000 ft) (maximum) |
| Thermal dissipation | <ul style="list-style-type: none"> • 68.24 BTU/hour (maximum) • 54.59 BTU/hour (typical) |

Power Management Modes

If you have VESA's DPM-compliant video card or software installed in your PC, the monitor can automatically reduce its power consumption when not in use. This is referred to as power save mode*. If the computer detects input from the keyboard, mouse, or other input devices, the monitor automatically resumes functioning. The following table shows the power consumption and signaling of this automatic power saving feature.

| VESA Modes | Horizontal Sync | Vertical Sync | Video | Power Indicator | Power Consumption |
|------------------|-----------------|---------------|--------|-----------------------------------|----------------------------------|
| Normal operation | Active | Active | Active | White | 20W (maximum)** 16W (typical) |
| Active-off mode | Inactive | Inactive | Off | Breathing White (blinking slowly) | Less than 0.3 W |
| Switch off | - | - | - | Off | Less than 0.3 W |

| Energy Star | Power Consumption |
|-------------|-------------------|
| On Mode | 13.44 W*** |

The OSD operates only in the normal operation mode. If you press any button in the active-off mode, the following message is displayed:

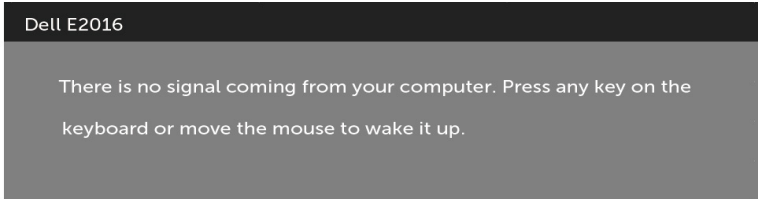

*Zero power consumption in OFF mode can only be achieved by disconnecting the power adapter from the monitor.

**Maximum power consumption with maximum luminance.

***Energy consumption (On Mode) is tested at 230 Volts / 50 Hz.

This document is informational only and reflects laboratory performance. Your product may perform differently, depending on the software, components and peripherals you ordered and shall have no obligation to update such information. Accordingly, the customer should not rely upon this information in making decisions about electrical tolerances or otherwise. No warranty as to accuracy or completeness is expressed or implied.

Activate the computer and the monitor to gain access to the OSD.

 **NOTE:** This monitor is **ENERGY STAR** -compliant.



Pin Assignments

VGA port

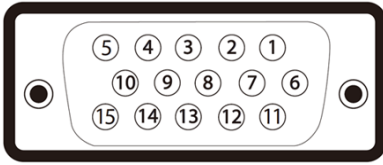

| Pin number | 15-pin side of the connected signal cable |
|------------|---|
| 1 | Video-Red |
| 2 | Video-Green |
| 3 | Video-Blue |
| 4 | GND |
| 5 | Self-test |
| 6 | GND-R |
| 7 | GND-G |
| 8 | GND-B |
| 9 | Computer 5 V / 3.3 V |
| 10 | GND-sync |
| 11 | GND |
| 12 | DDC data |
| 13 | H-sync |
| 14 | V-sync |
| 15 | DDC clock |

Plug-and-Play

You can install the monitor in any Plug-and-Play-compatible system. The monitor automatically provides the computer system with its extended display identification data (EDID) using display data channel (DDC) protocols so the computer can configure itself and optimize the monitor settings. Most monitor installations are automatic; you can select different settings if desired. For more information about changing the monitor settings, see [Operating the Monitor](#).

LCD Monitor Quality and Pixel Policy

During the LCD monitor manufacturing process, it is not uncommon for one or more pixels to become fixed in an unchanging state which are hard to see and do not affect the display quality or usability. For more information on LCD Monitor Pixel Policy, see Dell support site at: <http://www.dell.com/support/monitors>.

Setting Up the Monitor

Attaching the Stand

 **NOTE:** The stand riser and stand base are detached when the monitor is shipped from the factory.

 **NOTE:** The procedure below is applicable for the default stand. If you purchased any other stand, see the documentation shipped with the stand to set it up.

 **CAUTION:** Do not remove the monitor from the packaging box before attaching the stand.

Attach the stand assembly to the monitor.

- 1 Follow the instructions on the flaps of carton to remove the stand from the top cushion that secures it.
- 2 Connect the stand riser to stand base.



- 3 Lift the cover, as shown.

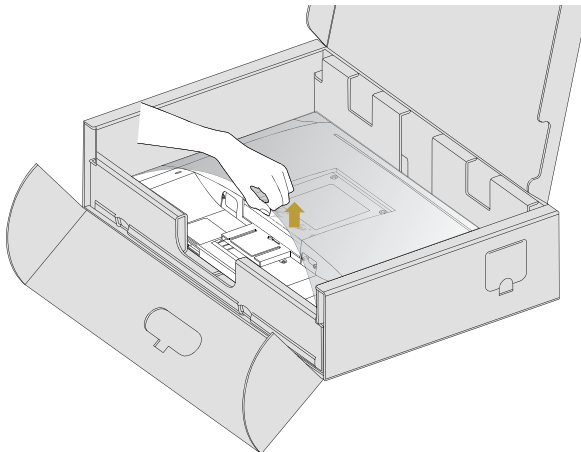

- 4 Insert the two tabs on the upper part of the stand in the slots on the back of the monitor till it snaps into its place.

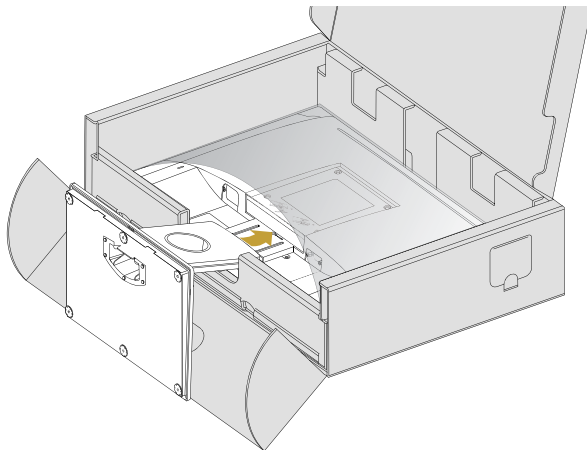

Place the monitor upright.

- 1 Slide one hand in the cutout area on the bottom cushion and use the other hand to hold the stand.
- 2 Lift the monitor carefully to prevent it from slipping or falling.
- 3 Remove the cover from the monitor.



CAUTION: Do not press on the panel screen when lifting the monitor.

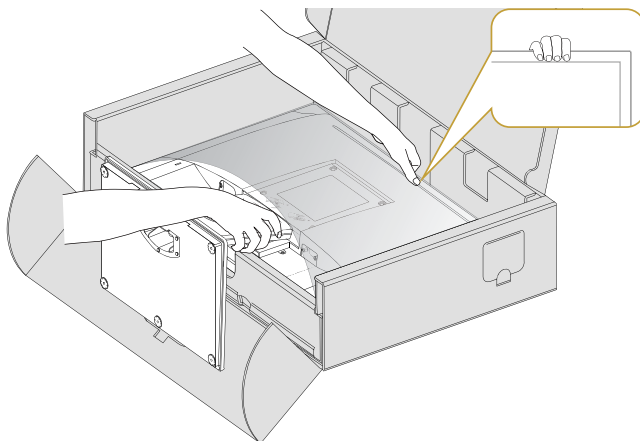

Attaching the Vesa Cover

 **NOTE:** The vesa cover is detached when the monitor is shipped from the factory.

- 1 Insert the two tabs on the upper part of the vesa cover in the slots on the back of the monitor.
- 2 Press the vesa cover till it snaps into place.



Connecting Your Monitor

 **WARNING:** Before you begin any of the procedures in this section, follow the [Safety Instructions](#).

To connect your monitor to the computer:

- 1 Turn off your computer.
- 2 Connect the VGA cable from your monitor to the computer.
- 3 Switch on your monitor.

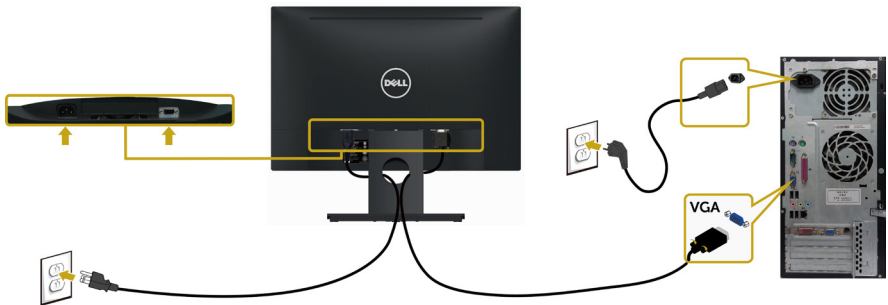

Organizing Your Cables



After attaching all necessary cables to your monitor and computer, (see [Connecting Your Monitor](#) for cable attachment) organize all cables as shown above.

Removing the Vesa Cover

Lift from both side simultaneously, remove the VESA Cover away from the monitor.



Removing the Monitor Stand



CAUTION: To prevent scratches on the LCD screen while removing the stand, make sure that the monitor is placed on a soft, clean surface.



NOTE: The procedure below is applicable for the default stand. If you purchased any other stand, see the documentation shipped with the stand to set it up.

To remove the stand:

- 1 Place the monitor on a flat surface.
- 2 Use a pen hold the release button.
- 3 Pull the stand neck in the arrow direction to detach the stand.

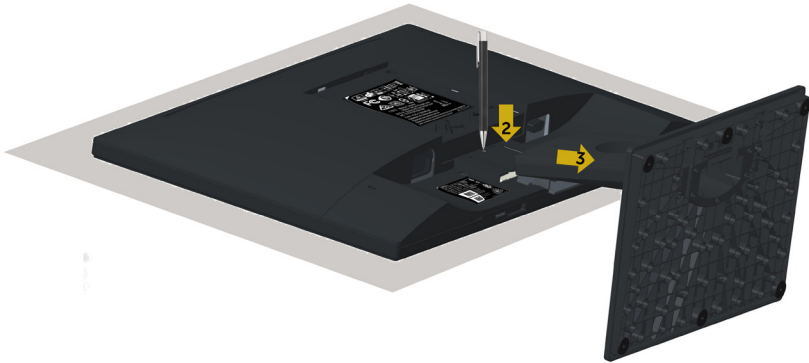

Wall Mounting (Optional)



 **NOTE:** Use M4 x 10 mm screws to connect the monitor to the wall-mounting kit.

Refer to the instructions that come with the VESA-compatible wall mounting kit.

- 1 Place the monitor on a soft cloth or cushion on a stable, flat table.
- 2 Remove the stand.
- 3 Use a Phillips crosshead screwdriver to remove the four screws securing the plastic cover.
- 4 Attach the mounting bracket from the wall mounting kit to the monitor.
- 5 Mount the monitor on the wall by following the instructions that comes with the wall mounting kit.

 **NOTE:** For use only with UL or CSA or GS-listed wall mount bracket with minimum weight/load bearing capacity of 2.29 kg (5.05 lb).

Operating the Monitor

Turning on the Monitor

Press the  button to turn on the monitor.

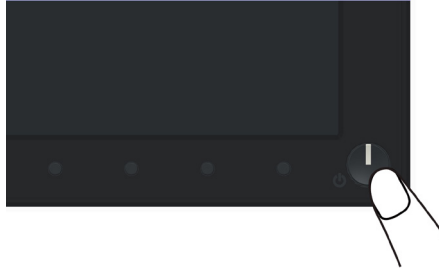



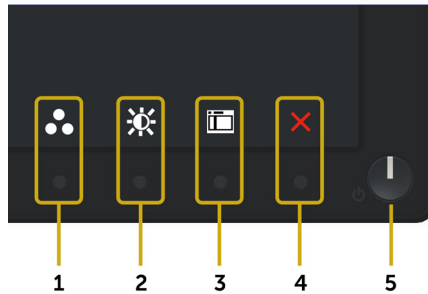

Using the Front Panel Controls

Use the control buttons on the front of the monitor to adjust the characteristics of the image being displayed. As you use these buttons to adjust the controls, an OSD shows the numeric values of the characteristics as they change.







The following table describes the front panel buttons:

| Front-Panel Button | Description |
|--|--|
| <p>1</p>  <p>Shortcut key: Preset Modes</p> | Use this button to choose from a list of preset color modes. |
| <p>2</p>  <p>Shortcut key : Brightness/Contrast</p> | Use this button to directly access the "Brightness/Contrast" menu. |
| <p>3</p>  <p>Menu</p> | Use this menu button to launch the on-screen display (OSD) and select the OSD menu. See Accessing the Menu System . |
| <p>4</p>  <p>Exit</p> | Use this button to go back to the main menu or exit the OSD main menu. |
| <p>5</p>  <p>Power (with power light indicator)</p> | Use the Power button to turn the monitor on and off. The White LED indicates the monitor is on and fully functional. A blinking white LED indicates DPMS power save mode. |

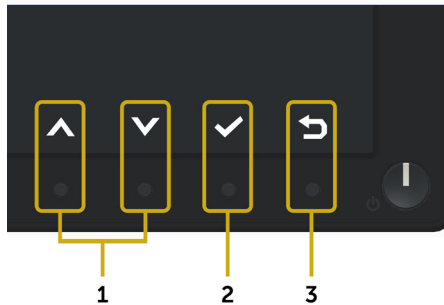
Front-Panel Button

Use the buttons on the front of the monitor to adjust the image settings.



| Front Panel Button | Description |
|--|---|
| <p>1</p>  <p>Up</p>  <p>Down</p> | Use the Up (increase) and Down (decrease) keys to adjust items in the OSD menu. |
| <p>2</p>  <p>OK</p> | Use the OK button to confirm your selection. |
| <p>3</p>  <p>Back</p> | Use the Back button to go back to the previous menu. |









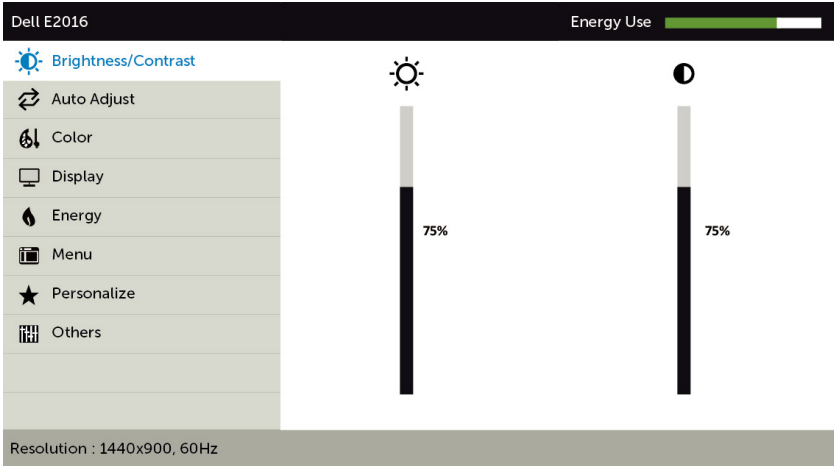

Using the On-Screen Display (OSD) Menu





Accessing the Menu System

 **NOTE:** Any changes you make using the OSD menu are automatically saved if you move to another OSD menu, exit the OSD menu, or wait for the OSD menu to disappear.

- 1 Press the  button to launch the OSD menu and display the main menu.

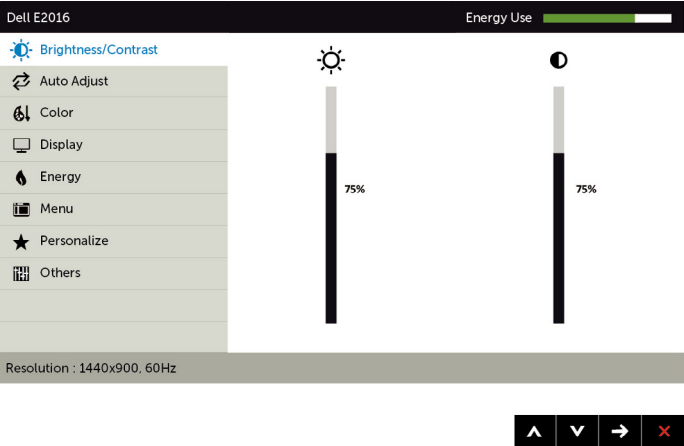

- 2 Press the  and  buttons to move between options. As you move from one icon to another, the option name is highlighted.
- 3 Press the  or  button once to activate the highlighted option.
- 4 Press the  and  buttons to select the desired parameter.
- 5 Press  to enter the slide bar and then use the  or  button, according to the indicators on the menu, to make your changes.
- 6 Press the  button once to return to the main menu to select another option or press the  button two or three times to exit from the OSD menu.

| Icon | Menu and Submenus | Description |
|--|---|--|
|  | Brightness/Contrast | Use this menu to activate Brightness/Contrast adjustment. |
|  | | |
| Brightness | <p>Brightness adjusts the luminance of the backlight (minimum 0; maximum 100). Press the  button to increase brightness. Press the  button to decrease brightness.</p> | |
| Contrast | <p>Adjust the Brightness first, and then adjust Contrast only if further adjustment is necessary. Press the  button to increase contrast and press the  button to decrease contrast (between 0 and 100). Contrast adjusts the difference between darkness and lightness on the monitor.</p> | |

| Icon | Menu and Submenus | Description |
|------|-------------------|-------------|
|------|-------------------|-------------|



Auto Adjust

Even though your computer recognizes your monitor on startup, the **Auto Adjustment** function optimizes the display settings for use with your particular setup.

Auto Adjustment allows the monitor to self-adjust to the incoming video signal. After using **Auto Adjustment**, you can further tune your monitor by using the **Pixel Clock** (Coarse) and **Phase** (Fine) controls under **Display** menu.



The following dialog appears on a black screen as the monitor automatically adjusts to the current input:



NOTE: In most cases, **Auto Adjust** produces the best image for your configuration.

Icon Menu and Submenus

Description



Color

Use the **Color** menu to adjust the color setting mode.

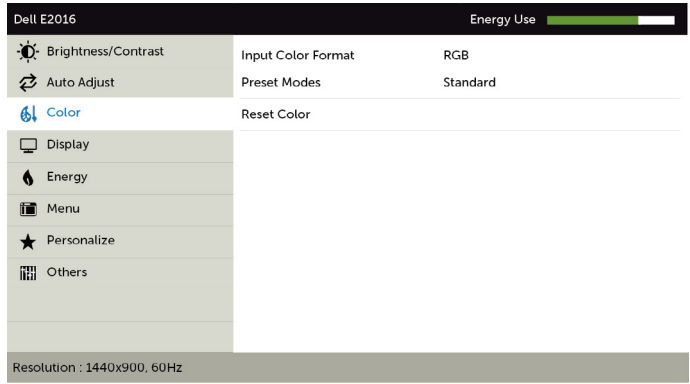

Input Color Format

Allows you to set the video input mode to:

RGB: Select this option if your monitor is connected to a computer (or DVD player) using the VGA cable.

YPbPr: Select this option if your DVD player supports only YPbPr output.

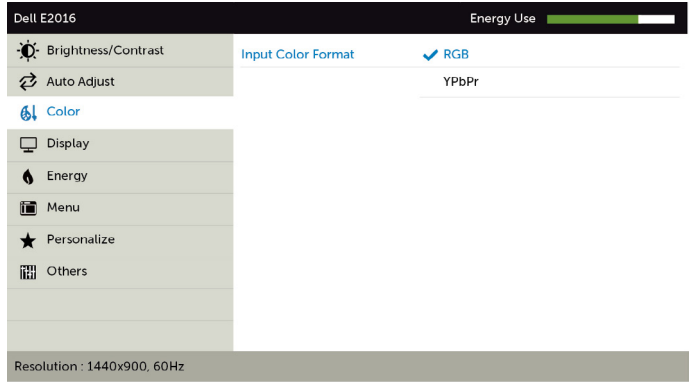



| Icon | Menu and Submenus | Description |
|------|-------------------|-------------|
|------|-------------------|-------------|

Preset Mode

When you select **Preset Modes**, you can choose **Standard, Multimedia, Paper, Warm, Cool, or Custom Color** from the list.

- **Standard:** Default color settings. This is the default preset mode.
- **Multimedia:** Ideal for multimedia applications.
- **Paper:** Loads brightness and sharpness settings ideal for viewing text. Blend the text background to simulate paper media without affecting color images.
- **Warm:** Increases the color temperature. The screen appears warmer with a red/yellow tint.
- **Cool:** Decreases the color temperature. The screen appears cooler with a blue tint.
- **Custom Color:** Allows you to manually adjust the color settings.

Press the  and  buttons to adjust the Red, Green, and Blue values and create your own preset color mode.

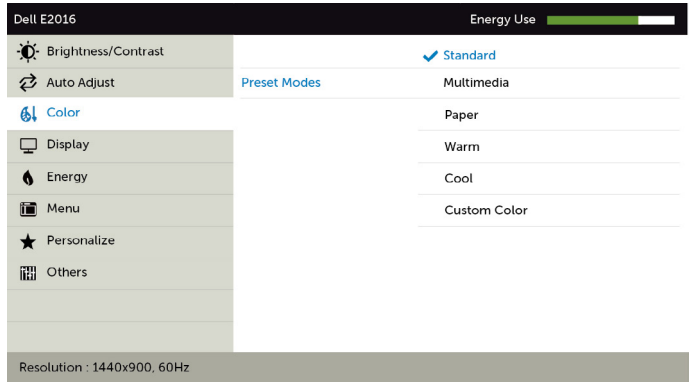



Reset Color

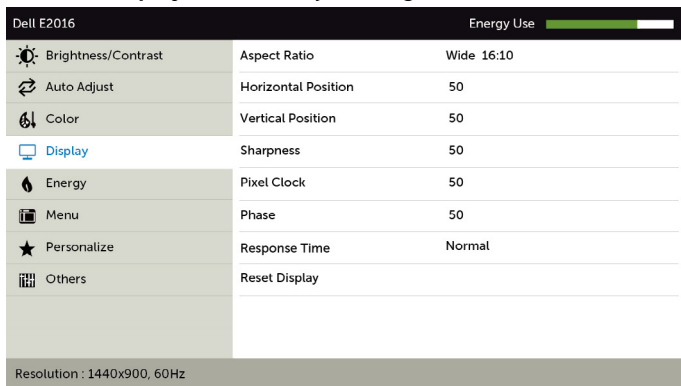

Resets your monitor's color settings to the factory defaults.



| Icon | Menu and Submenus | Description |
|--|-------------------|--|
|  | Display | Use the Display menu to adjust image. |





Aspect Ratio Adjust the image ratio to **Wide 16:10**, **4:3**, or **5:4**.

Horizontal Position Use  or  to adjust the image left or right. Minimum is '0' (-). Maximum is '100' (+).

Vertical Position Use  or  to adjust the image up or down. Minimum is '0' (-). Maximum is '100' (+).

Sharpness Makes the image look sharper or softer. Use  or  to adjust the sharpness from '0' to '100'.

Pixel Clock The **Phase** and **Pixel Clock** adjustments allow you to adjust your monitor to your preference. Use the  or  buttons to adjust for best image quality.

Phase If satisfactory results are not obtained using the **Phase** adjustment, use the **Pixel Clock** (coarse) adjustment and then use **Phase** (fine) again.



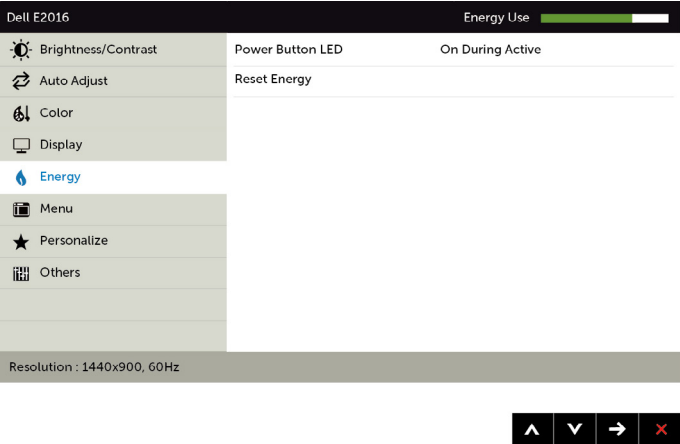

Response Time Allows you to set the **Response Time** to **Normal** or **Fast**.

Reset Display Restores the display settings to factory defaults.

| Icon | Menu and Submenus | Description |
|--|-------------------|--|
|  | Energy |  |

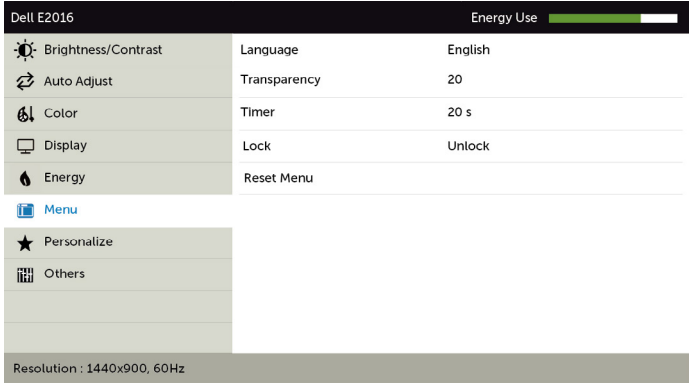
Power Button LED Allows you to set the state of the power light to save energy.

Reset Energy Select this option to restore default **Energy** settings.

| Icon | Menu and Submenus | Description |
|--|---------------------|--|
|  | Menu | <p>Select this option to adjust the settings of the OSD, such as, the languages of the OSD, the amount of time the menu remains on screen, and so on.</p>  |
| | Language | <p>Set the OSD display to one of eight languages. (English, Spanish, French, German, Brazilian Portuguese, Russian, Simplified Chinese, or Japanese).</p> |
| | Transparency | <p>Select this option to change the menu transparency by using  and  (min. 0 / max. 100).</p> |
| | Timer | <p>OSD Hold Time: Sets the length of time the OSD remains active after you press a button. Use the  and  buttons to adjust the slider in 1-second increments, from 5 to 60 seconds.</p> |
| | Lock | <p>Controls user access to adjustments. When Lock is selected, no user adjustments are allowed. All buttons are locked.</p> <p>NOTE:</p> <p>Lock function – Either soft lock (through OSD menu) or hard lock (Press and hold the button left power button for 6 sec)</p> <p>Unlock function – Only hard unlock (Press and hold the button left power button for 6 sec)</p> |
| | Reset Menu | <p>Restore the menu settings to factory defaults.</p> |

| Icon | Menu and Submenus | Description |
|------|-------------------|-------------|
|------|-------------------|-------------|

| | | |
|--|--------------------|--|
|  | Personalize | Select from Preset Modes , Brightness/Contrast , Auto Adjust and Aspect Ratio set as shortcut key. |
|--|--------------------|--|

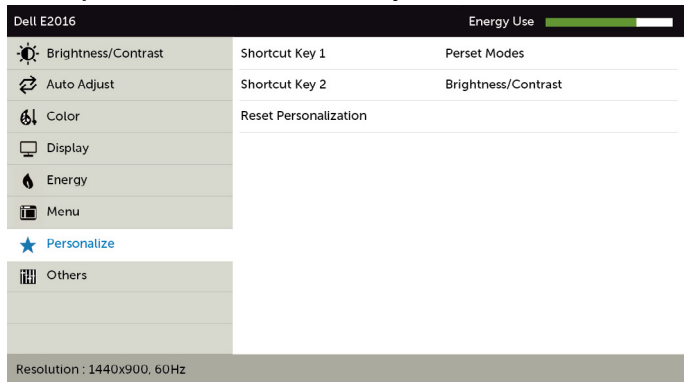

| | |
|------------------------------|---|
| Reset Personalization | Restores shortcut keys to factory defaults. |
|------------------------------|---|

| | |
|--|--------------|
|  | Other |
|--|--------------|

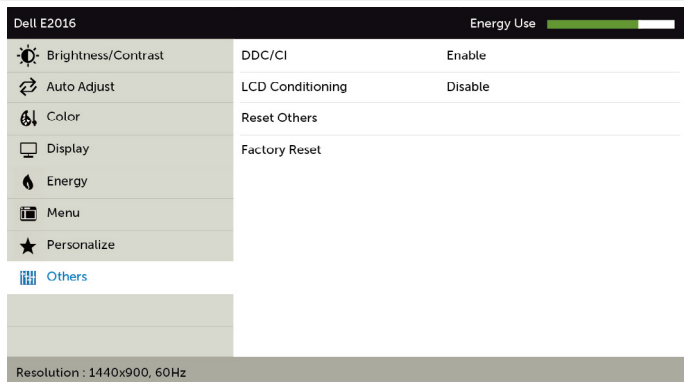

Select this option to adjust the OSD settings, such as the **DDC/CI**, **LCD conditioning**, and so on.

| Icon | Menu and Submenus | Description |
|------|-------------------|-------------|
|------|-------------------|-------------|

DDC/CI

DDC/CI (Display Data Channel/Command Interface) allows you to adjust the monitor settings using software on your computer.

Select **Disable** to turn off this feature.

Enable this feature for best user experience and optimum performance of your monitor.

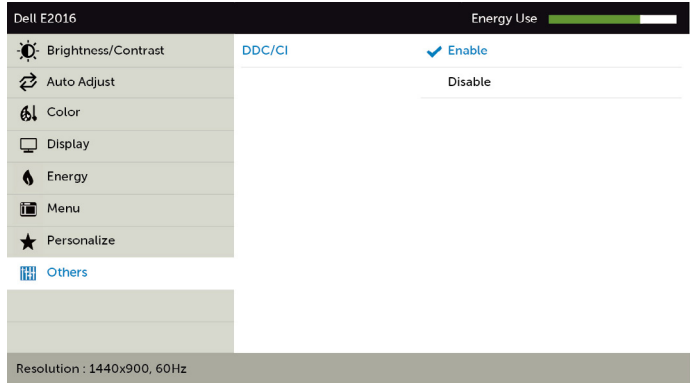

LCD Conditioning

Helps reduce minor cases of image retention. Depending on the degree of image retention, the program may take some time to run. Select **Enable** to start the process.

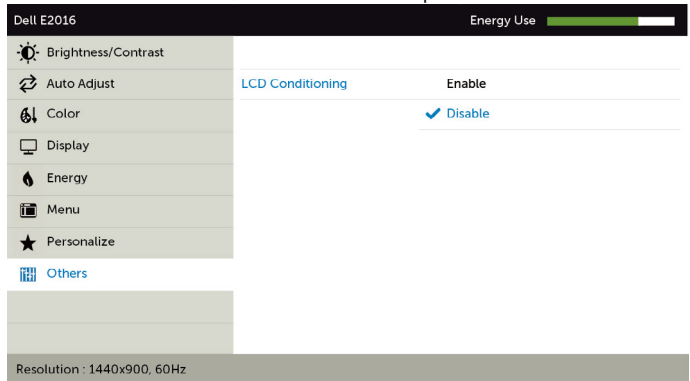

Reset Others

Restores other settings, such as **DDC/CI** to factory defaults.

Factory Reset

Restores all OSD settings to the factory defaults.

OSD Warning Messages

When the monitor does not support a particular resolution mode, you can see the following message:

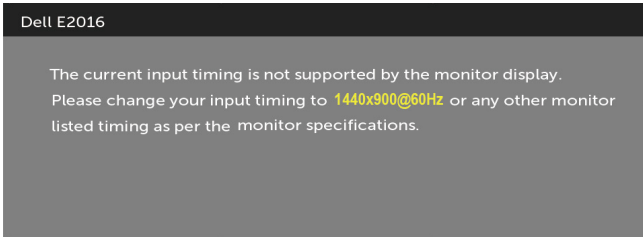

This means that the monitor cannot synchronize with the signal that it is receiving from the computer. See [Monitor Specifications](#) for the Horizontal and Vertical frequency ranges addressable by this monitor. Recommended mode is 1440 x 900.

You can see the following message before the DDC/CI function is disabled:

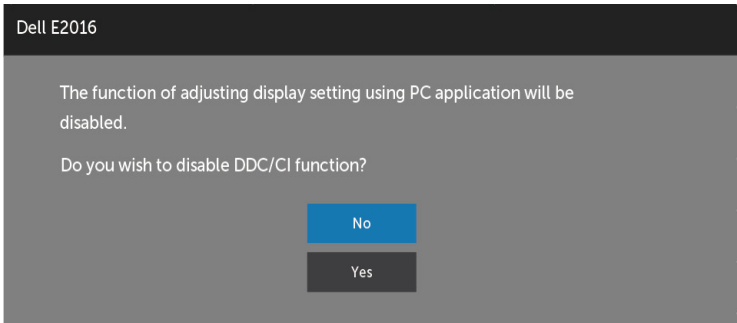

When the monitor enters the **Power Save** mode, the following message appears:

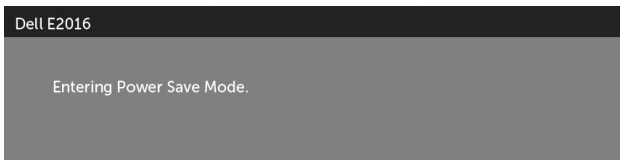

Activate the computer and wake up the monitor to gain access to the [OSD](#).
If you press any button other than the power button, one of the following messages will appear depending on the selected input:

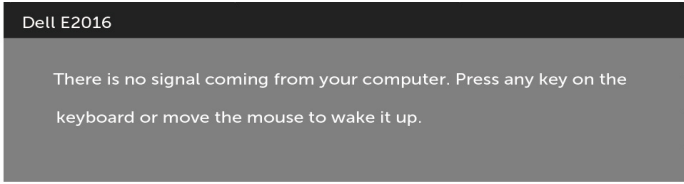

If VGA cable is not connected, a floating dialog box as shown below appears.

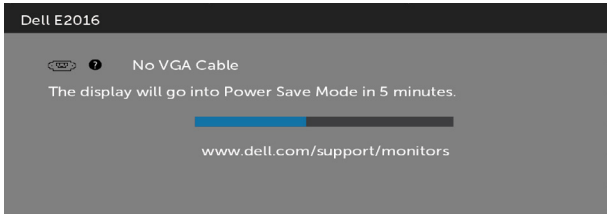

See [Troubleshooting](#) for more information.

Using Tilt

 **NOTE:** This is applicable for a monitor with a stand. If you purchased any other stand, refer to the respective stand setup guide for set up instructions.

Tilt

With the stand attached to the monitor, you can tilt the monitor for the most comfortable viewing angle.



 **NOTE:** The stand is detached when the monitor is shipped from the factory.

Troubleshooting

⚠ WARNING: Before you begin any of the procedures in this section, follow the [Safety Instructions](#).

Self-Test

Your monitor provides a self-test feature that allows you to check whether your monitor is functioning properly. If your monitor and computer are properly connected but the monitor screen remains dark, run the monitor self-test by performing the following steps:

- 1 Turn off both your computer and the monitor.
- 2 Unplug the video cable from the back of the computer.
- 3 Turn on the monitor.

The floating dialog box should appear on-screen (against a black background), if the monitor cannot sense a video signal and is working correctly. While in self-test mode, the power LED remains white also, depending upon the selected input, one of the dialogs shown below will continuously scroll through the screen.

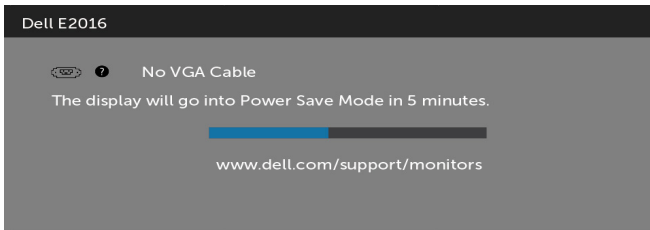

- 4 This box also appears during normal system operation, if the video cable becomes disconnected or damaged.
- 5 Turn off your monitor and reconnect the video cable; then turn on both your computer and the monitor.

If your monitor screen remains blank after you use the previous procedure, check your video controller and computer, because your monitor is functioning properly.

Built-in Diagnostics

Your monitor has a built-in diagnostic tool that helps you determine if the screen abnormality you are experiencing is an inherent problem with your monitor, or with your computer and video card.

 **NOTE:** You can run the built-in diagnostics only when the video cable is unplugged and the monitor is in self-test mode.

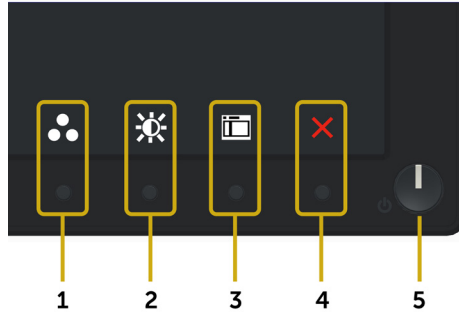

To run the built-in diagnostics:

- 1 Make sure that the screen is clean (no dust particles on the surface of the screen).
- 2 Unplug the video cable(s) from the back of the computer or monitor. The monitor then goes into the self-test mode.
- 3 Press and hold **Button 1** and **Button 4** on the front panel simultaneously for 2 seconds. A gray screen appears.
- 4 Carefully inspect the screen for abnormalities.
- 5 Press **Button 4** on the front panel again. The color of the screen changes to red.
- 6 Inspect the display for any abnormalities.
- 7 Repeat steps 5 and 6 to inspect the display in green, blue, black, white, and text screens.

The test is complete when the text screen appears. To exit, press **Button 4** again. If you do not detect any screen abnormalities upon using the built-in diagnostic tool, the monitor is functioning properly. Check the video card and computer.

Common Problems

The following table contains general information about common monitor problems you might encounter and the possible solutions:

| Common Symptoms | What You Experience | Possible Solutions |
|-----------------------|---------------------------------------|---|
| No Video/Power LED on | No picture | <ul style="list-style-type: none"> • Ensure that the video cable connecting the monitor and the computer is properly connected and secure. • Verify that the power outlet is functioning properly using any other electrical equipment. • Ensure that the power button is depressed fully. |
| No Video/Power LED on | No picture or no brightness | <ul style="list-style-type: none"> • Increase brightness & contrast controls via OSD. • Perform monitor self-test feature check. • Check for bent or broken pins in the video cable connector. • Run the built-in diagnostics. |
| Poor Focus | Picture is fuzzy, blurry, or ghosting | <ul style="list-style-type: none"> • Perform Auto Adjust via OSD. • Adjust the Phase and Pixel Clock controls via OSD. • Eliminate video extension cables. • Reset the monitor to factory settings. • Change the video resolution to the correct aspect ratio. |
| Shaky/Jittery Video | Wavy picture or fine movement | <ul style="list-style-type: none"> • Perform Auto Adjust via OSD. • Adjust the Phase and Pixel Clock controls via OSD. • Reset the monitor to factory settings. • Check environmental factors. • Relocate the monitor and test in another room. |
| Missing Pixels | LCD screen has spots | <ul style="list-style-type: none"> • Cycle power on-off. • Pixel that is permanently off is a natural defect that can occur in LCD technology. • For more information on Dell Monitor Quality and Pixel Policy, see Dell Support site at: http://www.dell.com/support/monitors. |
| Stuck-on Pixels | LCD screen has bright spots | <ul style="list-style-type: none"> • Cycle power On-Off. • Pixel that is permanently off is a natural defect that can occur in LCD technology. • For more information on Dell Monitor Quality and Pixel Policy, see Dell Support site at: http://www.dell.com/support/monitors. |
| Brightness Problems | Picture too dim or too bright | <ul style="list-style-type: none"> • Reset the monitor to factory settings. • Auto Adjust via OSD. • Adjust brightness & contrast controls via OSD. |
| Geometric Distortion | Screen not centered correctly | <ul style="list-style-type: none"> • Reset the monitor to factory settings. • Auto Adjust via OSD. • Adjust horizontal & vertical controls via OSD. |

| Common Symptoms | What You Experience | Possible Solutions |
|---|--|---|
| Horizontal/ Vertical Lines | Screen has one or more lines | <ul style="list-style-type: none"> • Reset the monitor to factory settings. • Perform Auto Adjust via OSD. • Adjust Phase and Pixel Clock controls via OSD. • Perform monitor self-test feature check and determine if these lines are also in self-test mode. • Check for bent or broken pins in the video cable connector. • Run the built-in diagnostics. |
| Synchronization Problems | Screen is scrambled or appears torn | <ul style="list-style-type: none"> • Reset the monitor to factory settings. • Perform Auto Adjust via OSD. • Adjust Phase and Pixel Clock controls via OSD. • Perform monitor self-test feature check to determine if the scrambled screen appears in self-test mode. • Check for bent or broken pins in the video cable connector. • Restart the computer in safe mode. |
| Safety Related Issues | Visible signs of smoke or sparks | <ul style="list-style-type: none"> • Do not perform any troubleshooting steps. • Contact Dell immediately. |
| Intermittent Problems | Monitor malfunctions on & off | <ul style="list-style-type: none"> • Ensure that the video cable connecting the monitor to the computer is connected properly and is secure. • Reset the monitor to factory settings. • Perform monitor self-test feature check to determine if the intermittent problem occurs in self-test mode. |
| Missing Color | Picture missing color | <ul style="list-style-type: none"> • Perform monitor self-test. • Ensure that the video cable connecting the monitor to the computer is connected properly and is secure. • Check for bent or broken pins in the video cable connector. |
| Wrong Color | Picture color not good | <ul style="list-style-type: none"> • Change the settings of the Preset Modes in the Color menu OSD depending on the application. • Adjust R/G/B value under Custom. Color in Color menu OSD. • Change the Input Color Format to PC RGB or YPbPr in the Color menu OSD. • Run the built-in diagnostics. |
| Image retention from a static image left on the monitor for a long period of time | Faint shadow from the static image displayed appears on the screen | <ul style="list-style-type: none"> • Use the Power Management feature to turn off the monitor at all times when not in use (for more information, see Power Management Modes). • Alternatively, use a dynamically changing screensaver. |

Product Specific Problems

| Specific Symptoms | What You Experience | Possible Solutions |
|---|--|---|
| Screen image is too small | Image is centered on screen, but does not fill entire viewing area | <ul style="list-style-type: none">• Check the Aspect Ratio setting in the Display menu OSD.• Reset the monitor to factory settings. |
| Cannot adjust the monitor with the buttons on the front panel | OSD does not appear on the screen | <ul style="list-style-type: none">• Turn off the monitor, unplug the monitor power cable, plug it back, and then turn on the monitor.• Check whether the OSD menu is locked. If yes, press and hold the button beside the power button for 6 seconds to unlock (for more information, see Lock). |
| No Input Signal when user controls are pressed | No picture, the LED light is white | <ul style="list-style-type: none">• Check the signal source. Ensure the computer is not in the power saving mode by moving the mouse or pressing any key on the keyboard.• Check whether the signal cable is plugged in properly. Re-plug the signal cable if necessary.• Reset the computer or video player. |
| The picture does not fill the entire screen | The picture cannot fill the height or width of the screen | <ul style="list-style-type: none">• Due to different video formats (aspect ratio) of DVDs, the monitor may display in full screen.• Run the built-in diagnostics. |

Appendix

Safety Instructions

 **WARNING:** Use of controls, adjustments, or procedures other than those specified in this documentation may result in exposure to shock, electrical hazards, and/or mechanical hazards.

For information on safety instructions, see the Safety, Environmental, and Regulatory Information (SERI).

FCC Notices (U.S. only) and Other Regulatory Information

For FCC notices and other regulatory information, see the regulatory compliance website located at www.dell.com/regulatory_compliance.

Contacting Dell

 **NOTE:** If you do not have an active Internet connection, you can find contact information on your purchase invoice, packing slip, bill, or Dell product catalog.

Dell provides several online and telephone-based support and service options. Availability varies by country and product, and some services may not be available in your area.

To get online Monitor support content:

See www.dell.com/support/monitors.

To contact Dell for sales, technical support, or customer service issues:

- 1 Go to www.dell.com/support.
- 2 Verify your country or region in the Choose A Country/Region drop-down menu at the top-left corner of the page.
- 3 Click **Contact Us** next to the country dropdown.
- 4 Select the appropriate service or support link based on your need.
- 5 Choose the method of contacting Dell that is convenient for you.

Setting Up Your Monitor

Setting Display Resolution to 1440 x 900 (maximum)

For best performance, set the display resolution to 1440 x 900 pixels by performing the following steps:

In Windows Vista, Windows 7, Windows 8 or Windows 8.1:

- 1 For Windows 8 or Windows 8.1 only, select the Desktop tile to switch to classic desktop.
- 2 Right-click on the desktop and click **Screen Resolution**.
- 3 Click the Dropdown list of the Screen Resolution and select **1440 x 900**.
- 4 Click **OK**.

In Windows 10:

- 1 Right-click on the desktop and click **Display Settings**.
- 2 Click **Advanced display settings**.
- 3 Click the dropdown list of **Resolution** and select 1440 x 900.
- 4 Click **Apply**.

If you do not see the recommended resolution as an option, you may need to update your graphics driver. Please choose the scenario below that best describes the computer system you are using, and follow the given steps.

Dell computer

- 1 Go to www.dell.com/support, enter your service tag, and download the latest driver for your graphics card.
- 2 After installing the drivers for your graphics adapter, attempt to set the resolution to 1440 x 900 again.



NOTE: If you are unable to set the resolution to 1440 x 900, please contact Dell to inquire about a graphics adapter that supports these resolutions.

Non-Dell computer

In Windows Vista, Windows 7, Windows 8 or Windows 8.1:

- 1 For Windows 8 or Windows 8.1 only, select the Desktop tile to switch to classic desktop.
- 2 Right-click on the desktop and click **Personalization**.
- 3 Click **Change Display Settings**.
- 4 Click **Advanced Settings**.
- 5 Identify your graphics controller supplier from the description at the top of the window (e.g. NVIDIA, ATI, Intel etc.).
- 6 Refer to the graphic card provider website for updated driver (for example, <http://www.ATI.com> or <http://www.NVIDIA.com>).
- 7 After installing the drivers for your graphics adapter, attempt to set the resolution to **1440 x 900** again.

In Windows 10:

- 1 Right-click on the desktop and click **Display Settings**.
- 2 Click **Advanced display settings**.
- 3 Click **Display adapter properties**.
- 4 Identify your graphics controller supplier from the description at the top of the window (e.g. NVIDIA, ATI, Intel etc.).
- 5 Refer to the graphic card provider website for updated driver (for example, <http://www.ATI.com> or <http://www.NVIDIA.com>).
- 6 After installing the drivers for your graphics adapter, attempt to set the resolution to **1440 x 900** again.



NOTE: If you are unable to set the recommended resolution, please contact the manufacturer of your computer or consider purchasing a graphics adapter that supports the video resolution.

Maintenance Guidelines

Cleaning Your Monitor



WARNING: Before cleaning the monitor, unplug the monitor power cable from the electrical outlet.



CAUTION: Read and follow the [Safety Instructions](#) before cleaning the monitor.

For best practices, follow these instructions in the list below while unpacking, cleaning, or handling your monitor:

- To clean your anti-static screen, lightly dampen a soft, clean cloth with water. If possible, use a special screen-cleaning tissue or solution suitable for the anti-static coating. Do not use benzene, thinner, ammonia, abrasive cleaners, or compressed air.
- Use a lightly-dampened, soft cloth to clean the monitor. Avoid using detergent of any kind as some detergents leave a milky film on the monitor.
- If you notice white powder when you unpack your monitor, wipe it off with a cloth.
- Handle your monitor with care as a darker-colored monitor may get scratched and show white scuff marks more than a lighter-colored monitor.
- To help maintain the best image quality on your monitor, use a dynamically changing screen saver and turn off your monitor when not in use.

Free Manuals Download Website

<http://myh66.com>

<http://usermanuals.us>

<http://www.somanuals.com>

<http://www.4manuals.cc>

<http://www.manual-lib.com>

<http://www.404manual.com>

<http://www.luxmanual.com>

<http://aubethermostatmanual.com>

Golf course search by state

<http://golfingnear.com>

Email search by domain

<http://emailbydomain.com>

Auto manuals search

<http://auto.somanuals.com>

TV manuals search

<http://tv.somanuals.com>