



Latitude 5175/5179

User's Guide

Regulatory Model: T04E
Regulatory Type: T04E001



Notes, cautions, and warnings

-  **NOTE:** A NOTE indicates important information that helps you make better use of your tablet.
-  **CAUTION:** A CAUTION indicates either potential damage to hardware or loss of data and tells you how to avoid the problem.
-  **WARNING:** A WARNING indicates a potential for property damage, personal injury, or death.

Copyright © 2015 Dell Inc. All rights reserved. This product is protected by U.S. and international copyright and intellectual property laws. Dell™ and the Dell logo are trademarks of Dell Inc. in the United States and/or other jurisdictions. All other marks and names mentioned herein may be trademarks of their respective companies.

Updated - 2015 - 11

Rev. A00

Contents

1 Tablet features.....	6
2 Setting up your tablet.....	10
Charging your tablet.....	10
Turning on your tablet.....	11
Inserting the micro-SIM card.....	11
Removing the micro-SIM card.....	12
Inserting the microSD card.....	13
Removing the microSD card.....	14
Using the headset.....	14
3 Using your tablet.....	16
Turning off your tablet.....	16
Using the power button on the Start screen.....	16
Using the power button.....	16
Turning off the screen.....	17
Using the power button on the Start screen.....	17
Using the power button.....	17
Start screen.....	17
Wi-Fi.....	18
Turning Wi-Fi on or off.....	18
Connecting to a network.....	18
Mobile broadband setting.....	18
Bluetooth.....	18
Turning Bluetooth on or off	18
Pairing with Bluetooth-enabled devices.....	19
Screen orientation.....	19
Locking or unlocking the screen orientation.....	19
Adjusting screen brightness.....	19
Auto adjust.....	20
Synchronizing your tablet.....	20

Restoring your operating system.....	20
Resetting your tablet.....	21
Gestures.....	21
4 Keyboards and Pens.....	24
Latitude 11 Slim Keyboard.....	24
Connecting your tablet.....	24
Disconnecting your tablet.....	26
Tilt.....	27
Dell Active Pen holder.....	27
Latitude 11 Keyboard.....	28
Features.....	28
Connecting your tablet.....	29
Disconnecting your tablet.....	31
Charging the keyboard.....	31
Using the mini Active Pen.....	33
Charging the mini Active Pen.....	34
5 Entering BIOS setup program.....	36
With keyboard.....	36
Without keyboard.....	36
6 Specifications.....	37
7 Troubleshooting.....	41
Battery.....	41
Network.....	42
Touchscreen.....	43
Tablet.....	43
Pen.....	44
8 Getting help	45
Self-help resources.....	45

9 Contacting Dell..... 46

10 Locating your Service Tag and Express Service Code..... 47

Tablet features

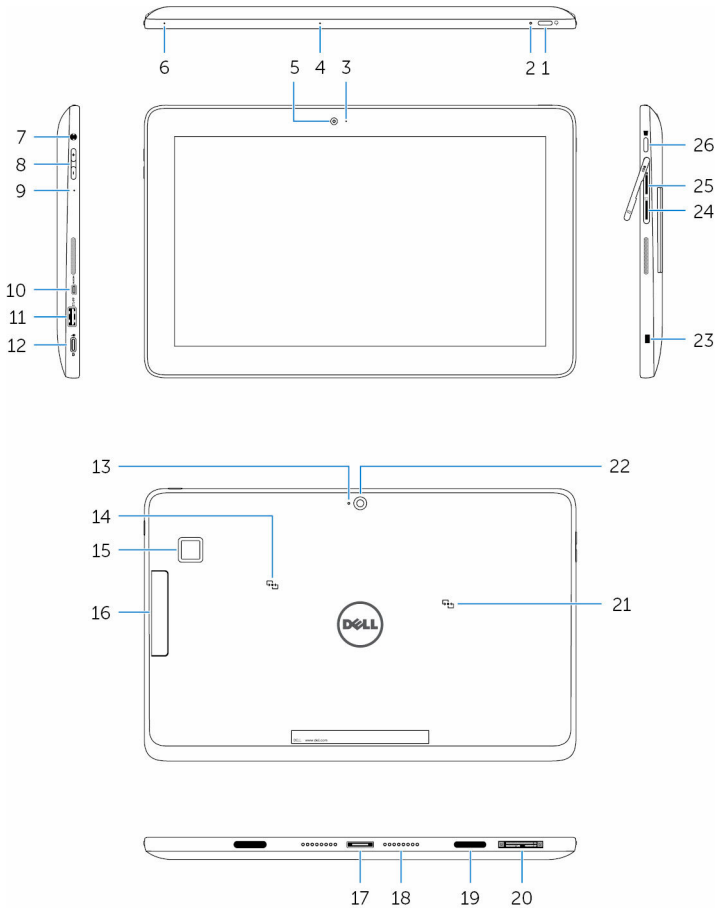

Feature

1. Power button

- Press and hold for 2 seconds to turn on the tablet if it is turned off.
- Press to turn on if it is in a sleep state.

- Press to turn off the screen.

NOTE: Press the Power button and Windows button together to access the lock/logout menu.

NOTE: The tablet can be configured to enable beep sound during start up. To enable this feature, enter the BIOS setup program, and under **Post Behavior** select **Enable Sign of Life Indication**. For more information, see [Entering BIOS setup program](#).

2. Power and battery-charge status light	Solid white	Power adapter is connected and the tablet is charging.
	Amber	Tablet is running on battery and the battery has less than 10% charge.
		<p>NOTE: If you try turning on the tablet when the battery charge is critically low, the status light blinks amber in sequence of three on/off cycles indicating that the tablet cannot be turned on with this charge level.</p>
	Off	<ul style="list-style-type: none"> • Power adapter is connected and the battery is fully charged. • Tablet is running on battery and the battery has more than 5% charge. • Tablet is in standby or turned off.
3. Camera-status light		Turns on when the camera is in use.
4. Microphone		Provides sound input for audio recording, voice calls, and so on.
5. Front camera		Allows you to video chat, capture photos, and record videos.
6. Microphone		Provides sound input for audio recording, voice calls, and so on.

Feature

- | | |
|---------------------------------------------|-------------------------------------------------------------------------------------------------------------------------------------------------------------------------------------------------------------------------------------------------------------------------------------------------------------------------------------------------------------------------------|
| 7. Headset port | Connect a headphone, a microphone, or a headphone and microphone combo (headset). |
| 8. Volume-control buttons (2) | Press to increase or decrease the volume. |
| 9. Microphone | Provides sound input for audio recording, voice calls, and so on. |
| 10. Micro-HDMI port | Connect a TV or another HDMI-in enabled device. Provides video and audio output. |
| 11. USB 3.0 port | Connect peripherals such as storage devices, printers, and so on. |
| 12. USB 3.0 and power-adaptor port (USB-C) | Connect a power adapter to provide power to your tablet and charge the battery. Connect peripherals such as storage devices, printers, displays and so on.

 NOTE: Appropriate converters (sold separately) are required to connect standard USB, HDMI and DisplayPort devices. |
| 13. Microphone | Provides sound input for audio recording, voice calls, and so on. |
| 14. NFC-sensor area | Allows NFC-enabled devices to communicate with your tablet. <ul style="list-style-type: none">• Latitude 5175 - optional• Latitude 5179 - shipped with the system |
| 15. Fingerprint reader (Latitude 5179 only) | Press your finger on the fingerprint reader to log in to your tablet. The fingerprint reader allows your tablet to recognize your fingerprints as a passcode.

 NOTE: You must configure the fingerprint reader to register your finger print and enable access. |
| 16. Smart-card reader (Latitude 5179 only) | Insert your smart card into the reader to log in to your tablet. The smart-card reader is used for user authentication. |
| 17. Docking connector | Allows docking to the docking station. |

Feature

- | | |
|------------------------------------------|-----------------------------------------------------------------------------------------------------------------------------------------------------------------------------------------------------------------------------------------------------------------------------------|
| 18. Docking pins | Allows docking to the keyboard dock. |
| 19. Docking slots (2) | Allows docking to the keyboard dock. |
| 20. Service Tag label | Provides the Service Tag and Express Service Code needed for contacting Dell. |
| 21. NFC-sensor area (Latitude 5179 only) | Allows NFC-enabled devices to communicate with your tablet. |
| 22. Rear camera | Allows you to video chat, capture photos, and record videos. |
| 23. Security-cable slot | Connects a security cable to prevent unauthorized movement of your tablet. |
| 24. Micro-SIM card slot | Insert a micro-SIM card to connect to a mobile broadband network. |
| 25. microSD-card slot | Insert a microSD card to expand the storage capacity. Your tablet supports a microSD card with capacity up to 128 GB. |
| 26. Windows button | <ul style="list-style-type: none">• Press to open the Windows Start menu or the Start screen.• Press for quick access to the most recently used app or most recently used screen.• Press Windows + Power button to enable Ctrl +Alt+Del function. |

Setting up your tablet

⚠ WARNING: Before you begin any of the procedures in this section, read the safety information that shipped with your tablet. For additional best practices information, go to www.dell.com/regulatory_compliance.

Topics:

- Charging your tablet
- Turning on your tablet
- Inserting the micro-SIM card
- Removing the micro-SIM card
- Inserting the microSD card
- Removing the microSD card
- Using the headset

Charging your tablet

⚠ CAUTION: Charge the battery in an ambient temperature of 0°C to 35°C (32°F to 95°F).

⚠ CAUTION: Use only the supplied power adapter to charge your tablet. Using unauthorized power adapters or cables may severely damage your tablet.

ⓘ NOTE: The battery may not be fully charged when you unpack your tablet.

- 1 Connect the power cable into the power adapter.
- 2 Connect the power adapter to the power-adapter port on the tablet.
- 3 Connect the power adapter to an electrical outlet and charge the tablet until the battery is fully charged.

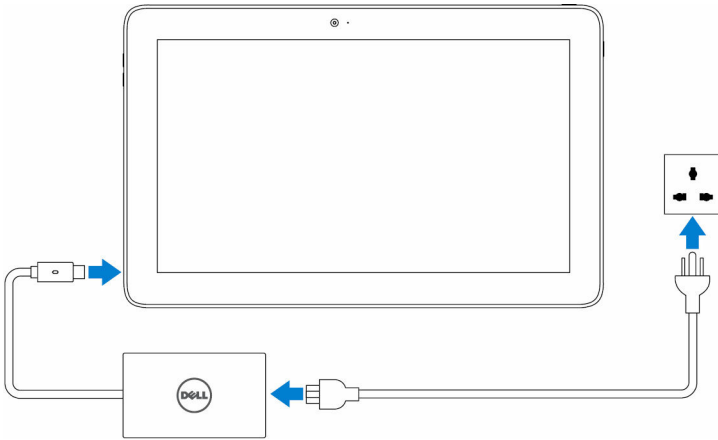

NOTE: A fully discharged battery takes up to 3 hours to fully charge when your tablet is not in use.

Turning on your tablet

When you turn on the tablet for the first time, you must finish Windows setup to start using your tablet. For more information, see the Quick Start Guide that shipped with your tablet.

- 1 Press and hold the power button for 2 seconds to turn on your tablet. The lock screen is displayed.
- 2 Swipe up from the bottom of the display to switch to the login screen.
- 3 Enter password to log in to Windows.

NOTE: If the login screen is not enabled, the Start screen is displayed after the lock screen.

The tablet is ready for use when the Windows Start screen is displayed.

Inserting the micro-SIM card

- 1 Open the slot cover and locate the micro-SIM card slot.

CAUTION: Ensure that the micro-SIM card is aligned as shown in the image.

- 2 Insert the micro-SIM card into the card slot until it locks into place.
- 3 Close the slot cover.

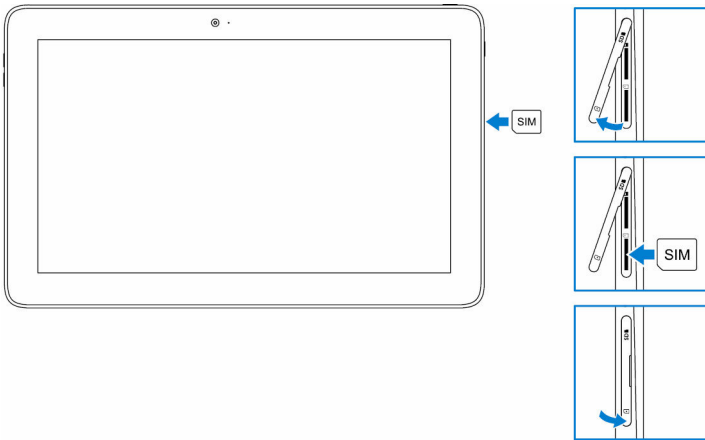

Removing the micro-SIM card

CAUTION: Removing the micro-SIM card while it is in use may cause data loss or result in application errors.

- 1 Open the slot cover.
- 2 Press the micro-SIM card inward and release it.
The micro-SIM card pops out.
- 3 Slide the micro-SIM card out of the slot.
- 4 Close the slot cover.

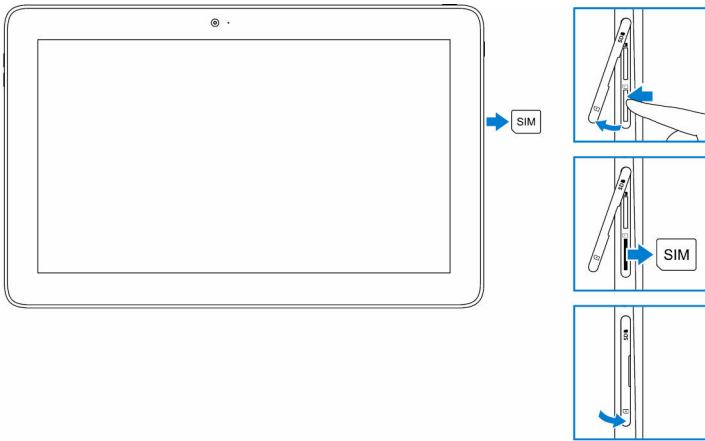

Inserting the microSD card

- 1 Open the slot cover and locate the microSD card slot.

CAUTION: Ensure that the microSD card is aligned as shown in the image.

- 2 Insert the microSD card into the card slot until it locks into place.
- 3 Close the slot cover.

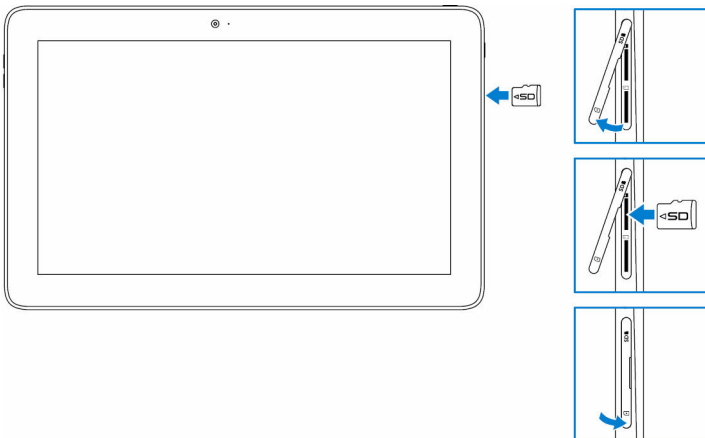

Removing the microSD card

CAUTION: Removing the microSD card while it is in use may cause data loss or result in application errors.

- 1 Tap **All Settings**  → **Devices** → **Connected devices**.
- 2 Under **Connected devices**, tap the **SD Card** and then tap **Remove device**.

NOTE: If a warning message appears stating the microSD card cannot be removed, ensure all data transfers involving the microSD card are complete.

A message appears that the microSD card can be safely removed.

- 3 Open the slot cover.
- 4 Press the microSD card inward and release it.
The microSD card pops out.
- 5 Slide the microSD card out of the slot.
- 6 Close the slot cover.

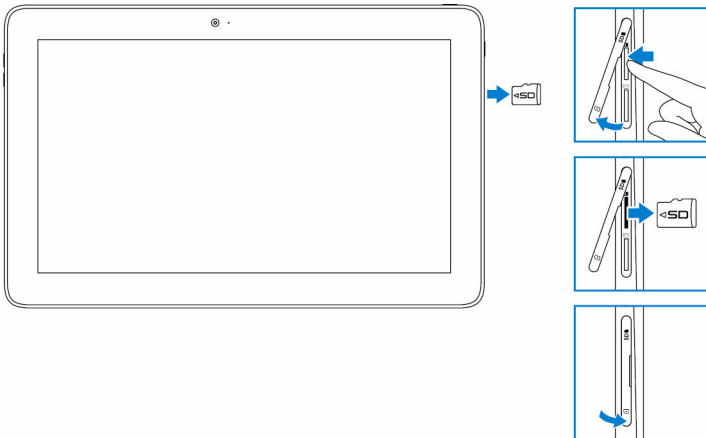

Using the headset

WARNING: Listening to loud music for an extended period of time can lead to hearing loss.

Connect a headset, headphones, microphone, or other audio equipment to the headset port of your tablet.

- 1 Connect headset to the headset port on the tablet.
- 2 Wear the headset and adjust the volume to a comfortable level. Adjust the microphone to an optimal level when using voice-enabled applications.

i **NOTE:** When you connect an audio device to the headset port, the integrated speaker on your tablet is muted automatically.

Δ **CAUTION:** To prevent damaging your headset when disconnecting it from the tablet, pull the connector and not the cable.

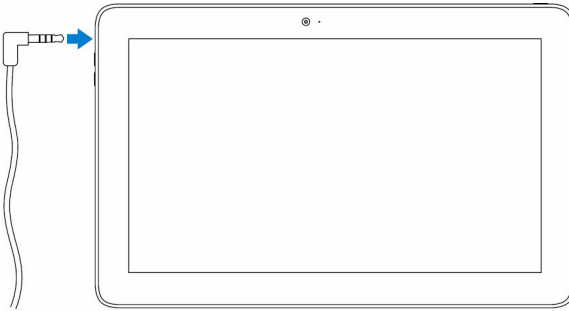

Using your tablet

 **NOTE:** For detailed information on using Windows, see [Getting help](#).

Topics:

- Turning off your tablet
- Turning off the screen
- Start screen
- Wi-Fi
- Mobile broadband setting
- Bluetooth
- Screen orientation
- Adjusting screen brightness
- Synchronizing your tablet
- Restoring your operating system
- Gestures

Turning off your tablet

Using the power button on the Start screen

- 1 Tap **Start**.
- 2 Tap the power button  → **Shut down** to turn off the tablet.

Using the power button

- 1 Press and hold the power button for at least 4 seconds.
- 2 Swipe down the shut-down confirmation screen to turn off the tablet.

Turning off the screen

Using the power button on the Start screen

- 1 Tap **Start**.
- 2 Tap the power button  → **Sleep** to turn off the screen.

 **NOTE:** If your tablet is in a standby state, press the power button or Windows button to turn on the screen.

Using the power button

Press the power button to turn off the screen.

Start screen

The Start screen displays tiles that act as shortcuts to installed apps.

 **NOTE:** You can disable or enable tablet mode using the icon in the Action center. You can also choose to automatically switch to PC mode when the tablet is docked. When in PC mode, the Start screen is replaced by the Start menu. To learn more about using Windows, see [Getting help](#).

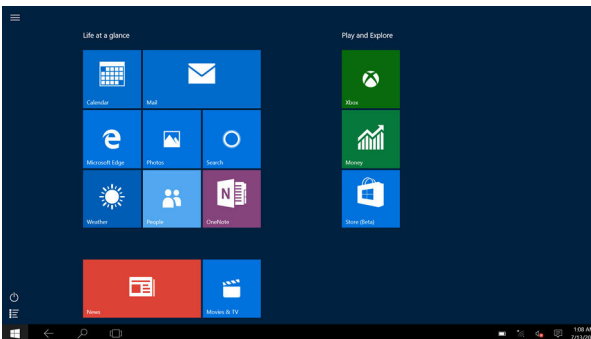

Tiles on your Start screen change and update in real time to show news and sports updates, weather updates, social-networking feeds, and so on.

You also can customize the Start screen by pinning your favorite apps as tiles, setting your favorite picture as a wallpaper, and so on.

Wi-Fi

Turning Wi-Fi on or off

- 1 Swipe-in from the right edge of the display to access the Action Center.
- 2 Tap  to turn Wi-Fi on or off.

Connecting to a network

- 1 Tap Wi-Fi icon  in the bottom-right corner of the screen.
- 2 In the list of available networks, tap the network you want to connect to, and then tap **Connect**.

Mobile broadband setting

- 1 Tap **Network**  in the bottom-right corner of the screen.
- 2 Under **Cellular** tap your mobile broadband carrier and then tap **Connect**.
- 3 In the advanced options tap **Connect**.

Bluetooth

Turning Bluetooth on or off

- 1 Swipe-in from the right edge of the display to access the Action Center.
- 2 Tap **Bluetooth**  to turn Bluetooth off or on.

Pairing with Bluetooth-enabled devices

 **NOTE:** Bluetooth connection between your tablet and Apple devices are not supported.

- 1 Turn on Bluetooth. For more information, see [Turning on/off Bluetooth](#).
- 2 Swipe-in from the right edge of the display to access the Action Center.
- 3 Press and hold **Bluetooth**  and then tap **Go to settings**.
- 4 From the list of devices, tap the device you want to pair with and tap **Pair**.
- 5 If needed, verify that the Bluetooth passcode that appears on both the tablet and the Bluetooth-enabled device are the same.
- 6 Confirm the pairing process on both the tablet and device.

 **NOTE:** After a device is successfully paired with the tablet, it automatically connects with the tablet when Bluetooth is enabled on both tablet and device and they are in Bluetooth range.

Screen orientation

For optimal viewing experience, the screen orientation changes automatically to portrait or landscape depending on how you hold the tablet. You can disable automatic screen rotation and lock the screen in portrait or landscape mode.

 **NOTE:** Some apps may not support automatic screen rotation and are designed to work only in one orientation.

Locking or unlocking the screen orientation

- 1 Swipe-in from the right edge of the display to access the Action Center.
- 2 Tap  to lock or unlock the screen orientation.

Adjusting screen brightness

- 1 Swipe-in from the right edge of the display to access the Action Center.
- 2 Tap the brightness icon  to adjust the screen brightness.

Auto adjust

To enable or disable automatic screen brightness adjustment:

- 1 Swipe-in from the right edge of the display to access the Action Center.
- 2 Tap **All Settings**  → **System** → **Display**.
- 3 Use the **Adjust my screen brightness automatically** slider to enable or disable automatic-brightness adjustment.

 **NOTE:** You can also use the **Brightness level** slider to adjust the brightness manually.

Synchronizing your tablet

When you use your Microsoft account to sign in to devices, the settings such as Windows and app settings and personal files are automatically synchronized.

 **NOTE:** To synchronize, the devices must be connected to the internet. If you are using a local account, switch to a Microsoft account to enable synchronization.

On the **Settings** screen, tap **Accounts** . On the **Accounts** screen, tap **Manage my Microsoft Account** to switch to your Microsoft account.

To customize the synchronizing settings:

- 1 Swipe-in from the right edge of the display to access the Action Center.
- 2 Tap **All settings** .
- 3 On the **Accounts** screen, tap **Sync your settings** to see the options for synchronizing your data and settings.

Restoring your operating system

 **CAUTION:** Restoring the operating system deletes all data on the hard drive and removes any programs or drivers installed after you received your tablet. If possible, back up the data before using this option.

This option restores the operating system on your tablet to the operating state it was in when you purchased the tablet. Use this option only if it is not responding, behaving unexpectedly, or has other software-related issues.

Resetting your tablet

⚠ CAUTION: Back up all the required data before you proceed.

You can either reset your tablet to restore it to the state you received it or you can choose to retain your files.

- 1 Swipe-in from the right edge of the display to access the Action Center.
- 2 Tap **All Settings**  → **Update and Security** → **Recovery**.
- 3 Under **Reset this PC**, tap **Get started**.
- 4 Choose either **Keep my files** or **Remove everything**.

i NOTE: The option **Keep my files** removes apps and settings, but keeps your personal files. The option **Remove everything** removes all of your personal files, apps, and settings.

- 5 Follow the instructions on the screen.

Gestures

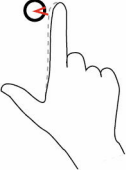
Gestures	Functions
<p>Touch Tap gently on the display with your fingertip.</p> 	<ul style="list-style-type: none">• Select items on the screen including options, entries, images, and icons.• Start applications.• Touch buttons on the screen.• Input text using the on-screen keyboard.
<p>Touch and hold Touch and hold your finger on the display.</p>	<ul style="list-style-type: none">• Display detailed information about an item.• Open the context menu of an item to perform further actions.



Drag

- 1 Touch and hold your finger on an item on the screen.
- 2 Keeping your finger in contact with the display, move your fingertip to the desired location.
- 3 Take your finger off the display to drop the item in the desired location.

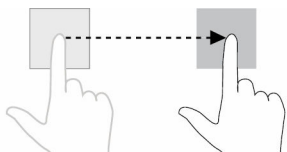

Swipe or slide

Move your finger in a vertical or horizontal direction on the display.

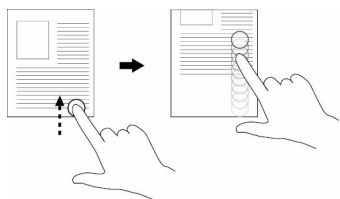

Zoom in

Touch the display with two fingers and then move the fingers apart.

Move items such as images and icons on the screen.

- Scroll through the Start screen, web pages, lists, entries, photos, contacts, and so on.
- Close an application (Swipe the application to the bottom of the display).

Enlarge the view of an image or web page.

Gestures

Functions

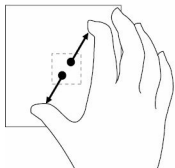

Zoom out

Touch the display with two fingers and then move the fingers closer.

Reduce the view of an image or web page.

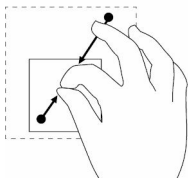

Rotate

Touch the display with two or more fingers and then move the fingers in a clockwise or counter-clockwise arc.

Rotate an object by 90 degrees.

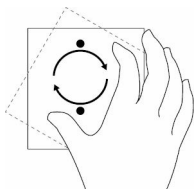

Keyboards and Pens

Your tablet supports the following accessories that are sold separately:

- Latitude 11 Slim Keyboard
- Latitude 11 Keyboard with mini Active Pen

Topics:

- [Latitude 11 Slim Keyboard](#)
- [Latitude 11 Keyboard](#)

Latitude 11 Slim Keyboard

Connecting your tablet

- 1 Open the flap on the keyboard and set to a desired angle.

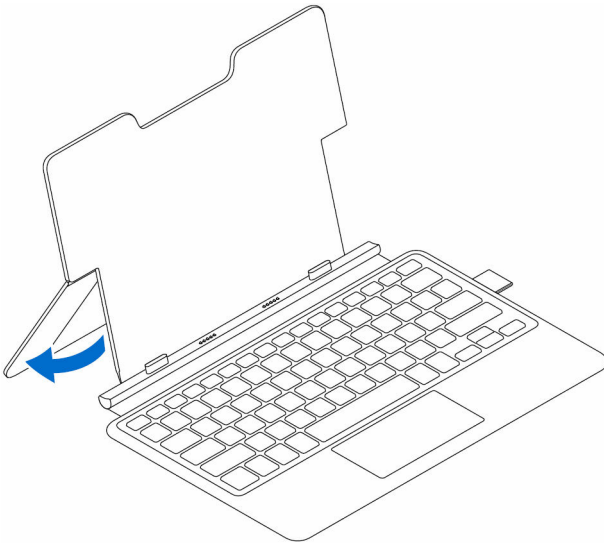

- 2 Align the tabs on the keyboard dock to the slots on the tablet and dock the tablet to the keyboard dock.

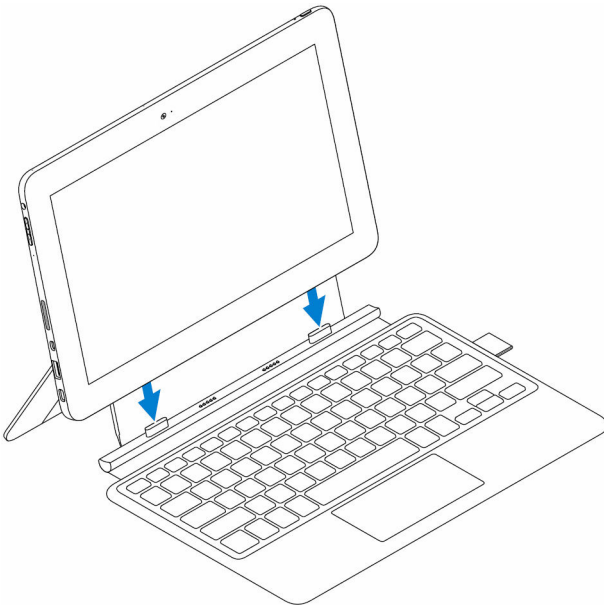

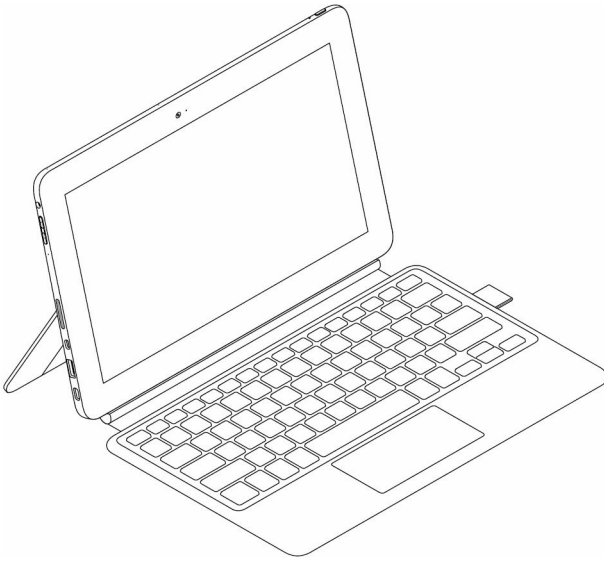

Disconnecting your tablet

Hold the keyboard, lift and release the tablet away from the keyboard.

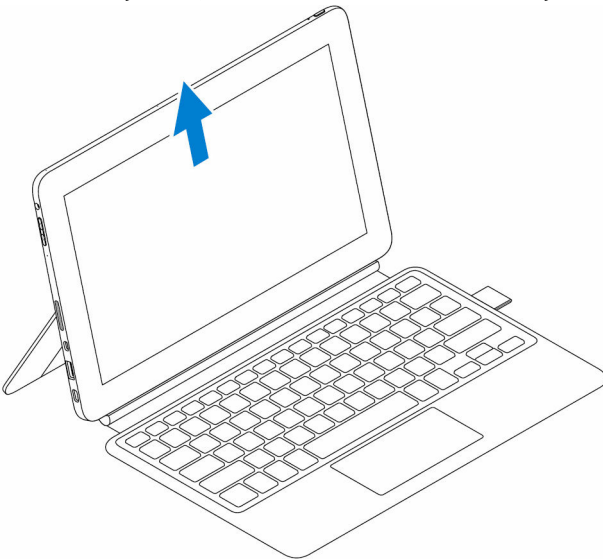

Tilt

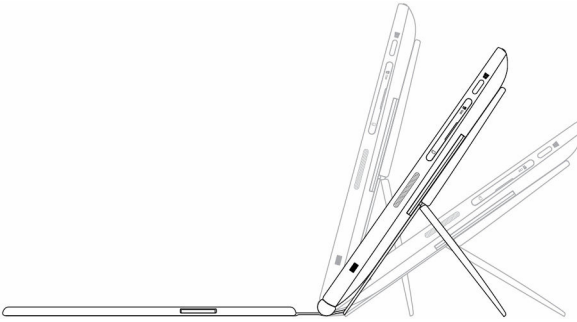

Dell Active Pen holder

NOTE: The Pen holder accommodates the Dell Active Pen which is sold separately. Store the Dell Active Pen here after use.

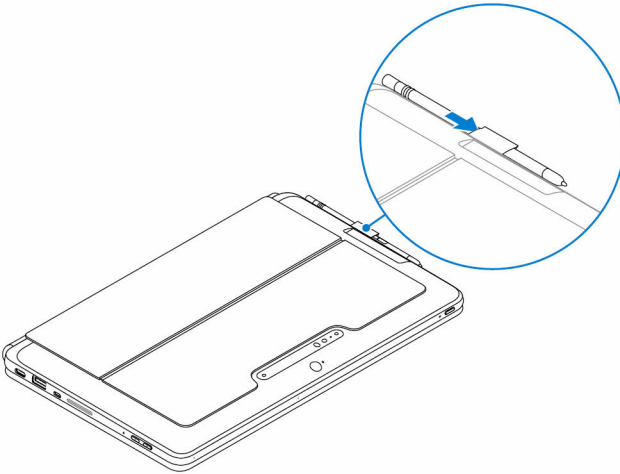

Latitude 11 Keyboard

Features

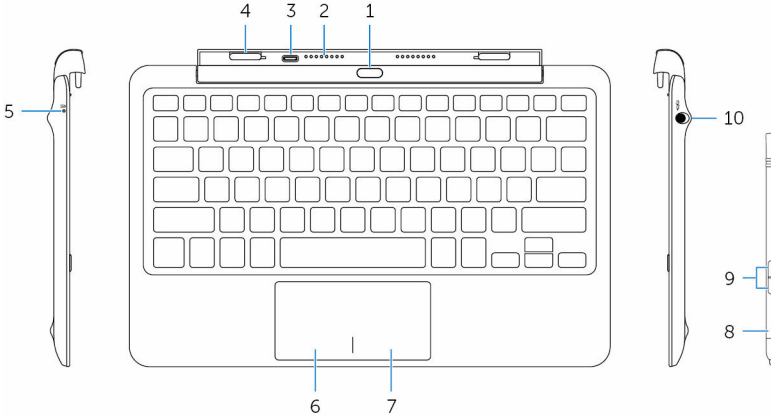

Feature

- | | | |
|----|------------------------------|------------------------------------------------------------------------------------------------------------------------------------------------------------------------------------------------------------------------------------------------------------------------------------------------------------------------------------------------------|
| 1. | Undock button | Press to undock the tablet. |
| 2. | Docking pins | Allows the tablet to communicate with the keyboard when docked. |
| 3. | Power-adaptor port (USB-C) | Allows you to connect a power adapter to charge the keyboard when the tablet is not docked. |
| 4. | Docking slots (2) | Allows docking to the tablet. |
| 5. | Keyboard-charge status light | Indicates the charge status of the keyboard.

NOTE: The keyboard-charge status light turns on for 2 seconds when the power adapter is connected to the keyboard.

Solid white Power adapter is connected and keyboard is getting charged.
Off Keyboard is fully charged or power adapter is not connected. |
| 6. | Left-click area | Press to left-click. |

Feature

- | | | |
|-----|------------------|------------------------------------------------------------------------------------------------------------------|
| 7. | Right-click area | Press to right-click. |
| 8. | mini Active Pen | Allows you to draw, write text, and perform basic mouse functions. |
| 9. | Pen buttons (2) | Customize these buttons to perform functions such as right-click, draw, highlight, write text, erase, and so on. |
| 10. | Pen garage | Allows you to charge the mini Active Pen. Store the mini Active Pen here after use. |

Connecting your tablet

- 1 Open the hinge on the keyboard dock.

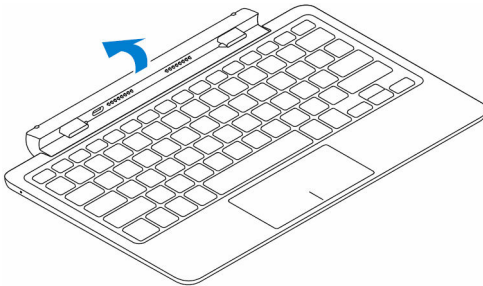

- 2 Connect the tablet to the keyboard dock.

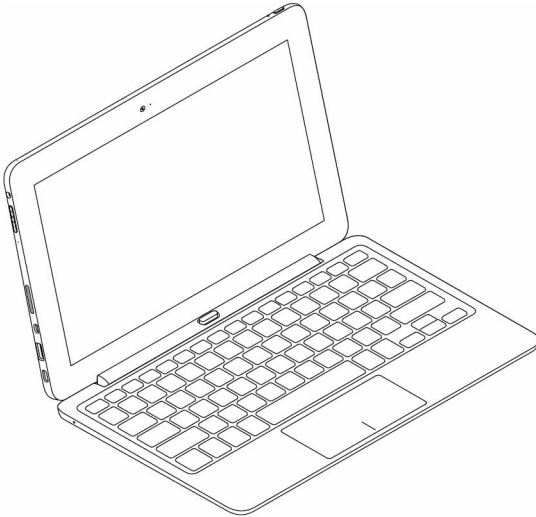
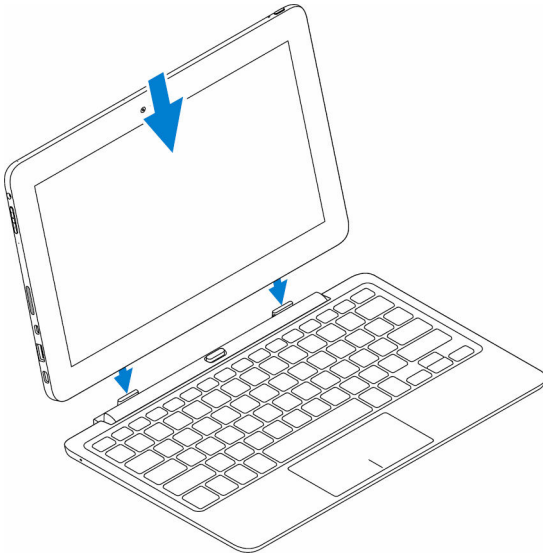

Disconnecting your tablet

Press and hold the undock button to release the tablet and lift the tablet away from the keyboard.

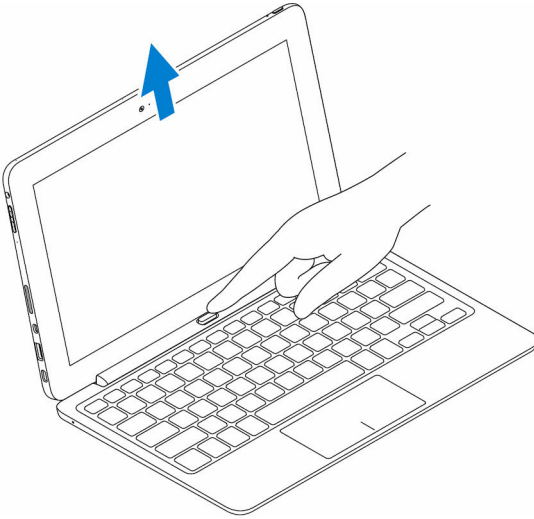

Charging the keyboard

To charge the keyboard connect the power adapter to the charging port on the tablet or the charging port on the keyboard dock.

NOTE: If the keyboard has not been charged for a long period of time, it is recommended to charge the keyboard directly by connecting the power adapter to the keyboard dock.

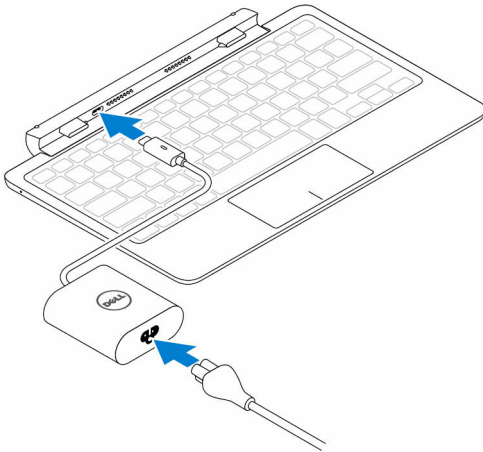
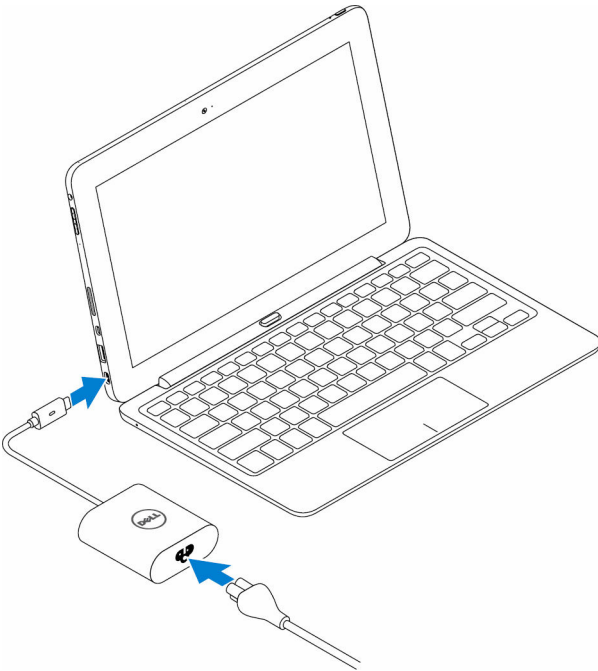

Using the mini Active Pen

The mini Active Pen supports features such as hovering and pressure sensing. You can use the mini Active Pen to draw shapes, select text, turn a page, and so on. You can also press the buttons on the side of the mini Active Pen to perform various tasks.

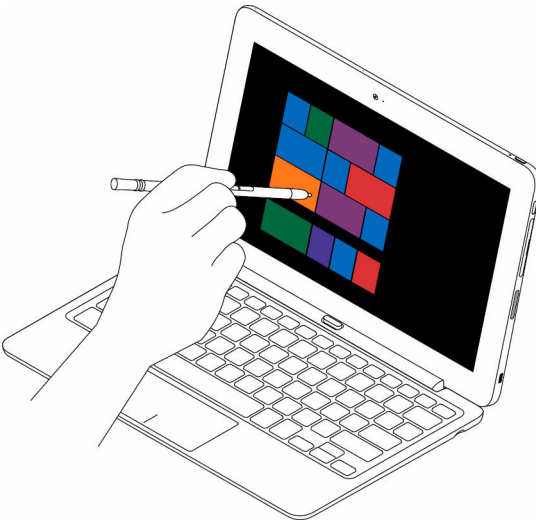
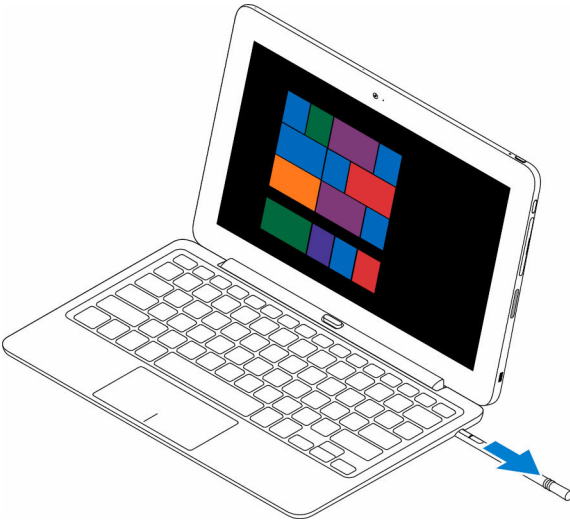

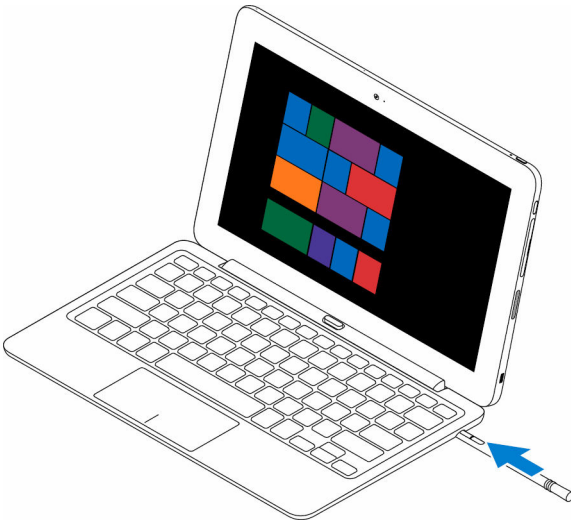

NOTE: A fully charged mini Active Pen can be used for at least 40 minutes.

The buttons on the mini Active Pen can be customized with functions such as:

- Barrel button (default function)
- Erase (default function)
- Page up
- Page down
- Copy
- Paste
- Undo
- Redo
- Disable

NOTE: To customize the buttons, download and install the **active pen control panel** driver from support website. For more information, see www.dell.com/support/drivers.

Charging the mini Active Pen

Insert the mini Active Pen into the Pen garage to charge the mini Active Pen. The mini Active Pen gets charged to 90% in 4 seconds and 100% in 25 seconds.

NOTE: For charging the mini Active Pen, the tablet must be docked and turned on.

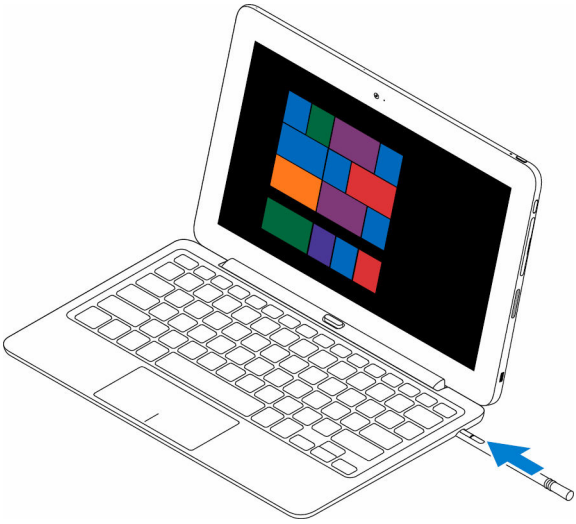

Entering BIOS setup program

With keyboard

- 1 Connect your tablet to the keyboard dock or connect a USB-enabled keyboard to your tablet.
- 2 Press the power button to turn on your tablet.
- 3 When the Dell logo is displayed, press F2.

Without keyboard

- 1 Press the power button to turn on your tablet.
- 2 Press and hold the Volume Up button when the Dell logo is displayed on the screen.
- 3 When the F12 boot selection menu is displayed, select **BIOS Setup** using the Volume Up button.
- 4 Press the Volume Down button to enter BIOS setup program.

Specifications

Dimensions and weight:

	Latitude 5175	Latitude 5179
Thickness	10.78 mm (0.42 in.)	14.32 mm (0.56 in.)
Width	279.78 mm (11.01 in.)	279.76 mm (11.01 in.)
Height	176.80 mm (6.96 in.)	176.83 mm (6.96 in.)
Weight (minimum)	0.71 kg (1.56 lb)	0.76 kg (1.67 lb)

System information:

Processor	6th Generation Intel Core m Processor
Operating system	<ul style="list-style-type: none"> Windows 8.1 Windows 10
RAM	LPDDR3

Storage:

Type	<ul style="list-style-type: none"> 128 GB solid-state drive 256 GB solid-state drive 512 GB solid-state drive 256 GB self-encrypting drive
------	--------------------------------------------------------------------------------------------------------------------------------------------------------------------------------------

Memory:

Type	LPDDR3
Speed	1600 MHz
Configurations supported	4 GB and 8 GB

Ports and connectors:

Audio	One headset port (headphone and microphone combo)
HDMI	One micro-HDMI port
microSD card	One microSD-card slot
Micro-SIM card	One micro-SIM card slot (optional)
USB 3.0 port	One USB 3.0 port
USB-C port	One USB-C port that supports power delivery and USB 3.0

Communications:

Wi-Fi	Dual-band 802.11ac
Bluetooth	Bluetooth 4.1 LE
Intel WiDi	Supported
NFC	<ul style="list-style-type: none">• Latitude 5175 - optional• Latitude 5179 - shipped with the system

Video controller:

Type	Intel HD graphics 515
------	-----------------------

Display:

Type	10.8-inch Full HD
Resolution	1920 x 1080
Aspect ratio	16:9
Brightness	360 nits
Viewing angle	80 degrees
Contrast ratio	<ul style="list-style-type: none">• 800:1 (minimum)• 1000:1 (typical)

Display:

Color depth 8 bits

Security:

Fingerprint reader Supported on Latitude 5179 only

Smart card reader Supported on Latitude 5179 only

Camera:

	Front-facing camera	Rear-facing camera
Type	5 MP fixed focus	8 MP auto focus
Resolution		
Still image	Up to 5 MP	Up to 8 MP
Video	Up to FHD (1920x1080) pixels	Up to FHD (1920x1080) pixels
Viewing angle	63 to 66 degrees	63 to 66 degrees

Power adapter:

Input voltage 100 VAC-240 VAC

Input frequency 50 Hz-60 Hz

Input current 1.30 A

Output current 2.0 A/1.5 A

Rated output voltage 5 VDC/20 VDC

Temperature range:

 Operating 0 °C to 40 °C (32 °F to 104 °F)

 Storage -40 °C to 70 °C (-40 °F to 158 °F)

Environmental requirements:

Temperature range:

 Operating 0 °C to 35 °C (32 °F to 95 °F)

Environmental requirements:

Non-operating -40°C to 65 °C (-40°F to 149 °F)

Relative humidity (maximum):

Operating 10% to 90% (non-condensing)

Non-operating 5% to 95% (non-condensing)

Altitude (maximum, unpressurized):

Operating -15.20 m to 3048 m (-50 ft to 10,000 ft)

Storage -15.20 m to 10,668 m (-50 ft to 35,000 ft)

Keyboard:	Latitude 11 Slim Keyboard	Latitude 11 Keyboard
-----------	---------------------------	----------------------

Dimensions:

Width	357.70 mm (14.08 in.)	279.20 mm (10.99 in.)
-------	-----------------------	-----------------------

Depth	277.90 mm (10.94 in.)	174.62 mm (6.87 in.)
-------	-----------------------	----------------------

Thickness	5.40 mm (0.21 in.)	9.70 mm (0.38 in.)
-----------	--------------------	--------------------

Weight	0.498 kg (1.10 lb)	0.73 kg (1.61 lb)
--------	--------------------	-------------------

Features

- | | |
|--------------------------------------------------------------------------------------------------------------------------|--------------------------------------------------------------------------------------------------------------------------|
| <ul style="list-style-type: none">• Backlit• Tactile keys• Touch pad• Palm rest | <ul style="list-style-type: none">• Backlit• Tactile keys• Touch pad• Palm rest |
|--------------------------------------------------------------------------------------------------------------------------|--------------------------------------------------------------------------------------------------------------------------|

Troubleshooting

Battery

Problems	Possible causes	Possible solutions
Battery does not charge	The cable connections may be loose.	<ol style="list-style-type: none"> 1 Check the cable connectors and power adapter to ensure proper connectivity. 2 Verify that the wall outlet is functioning by connecting another device. 3 Check the light on the power-adapter cable. 4 Ensure that you are using the power adapter that shipped with the tablet. 5 Disconnect the power adapter and connect after approximately 10 seconds.
	The tablet's temperature is below 0°C (32°F) or higher than 35°C (95°F).	Charge the battery in an ambient temperature between 0°C to 35°C (32°F to 95°F).
	The battery or power adapter is damaged.	Contact Dell. See Contacting Dell .
Battery does not charge when the battery charge is at 95% to 99%	The battery is in maintenance mode to prolong battery life.	<ul style="list-style-type: none"> • Let the battery drain until the battery charge drops below 95%. • Restart the tablet. See Turning off your tablet

Battery drains quickly even when the tablet is in standby mode

If the tablet is not in the range of a network it can connect to, the tablet continues to try to locate a base station and drains the battery.

and
[Turning on your tablet.](#)

- Temporarily turn off the tablet.
- Move the tablet in range of a network it can connect to or temporarily turn off the wireless connection on your tablet.
- Disable Wi-Fi or mobile broadband when not in range of any wireless networks.
- Enable airplane mode.

Battery charge values are not accurate

Battery is fully charged (battery charge is at 100%) but the battery-charging status light is on

Charge the tablet until the battery is fully charged and then use the tablet until the battery drains completely and the tablet turns off. This recalibrates the battery charge value.

Network

Problems

Possible causes

Possible solutions

No wireless connection

The wireless connection is not enabled.

Check if the wireless radio is on. See [Turning Wi-Fi on or off.](#)

The wireless connection is out of range.

Try to get closer to the wireless access point.

Slow internet connections

The signal strength is not strong enough.

Contact your internet service provider (ISP).

Unable to pair with a Bluetooth device

- Ensure Bluetooth is enabled on both the tablet and the device you are trying to pair with.

- Ensure they are within Bluetooth range.

Touchscreen

Problems

Touchscreen responds slowly or improperly

Possible causes

- The screen is dirty.
- A protective cover may prevent the tablet from recognizing your inputs.

Possible solutions

Moisten a soft, lint-free cloth with either water or a display cleaner, and wipe the surface of the tablet until it is clean. Do not allow water from the cloth to seep down to the tablet ports or buttons.

Tablet

Problems

Tablet does not turn on

Possible causes

The battery is completely discharged.

Possible solutions

- Charge the tablet for at least 4 hours.
- Press and hold the power button for 2 seconds and wait for 8 seconds to see whether the Dell logo is displayed.
- Press and hold the power button for 15 seconds to hard reset the tablet.

Tablet does not turn off

Press and hold the power button for 15 seconds to forcefully turn off the tablet.

Tablet locks up

Press and hold the power button for 25 seconds to unlock the tablet. Press the power button for 2 seconds and wait for 1

Tablet is not responding or behaving unexpectedly

Tablet cannot boot into Windows

Software or feature is not working as expected

minute for the Dell logo to be displayed.

- Restart the tablet. See [Turning off your tablet and Turning on your tablet.](#)
- Refresh the tablet. See [Restoring your operating system](#).

Contact Dell's support service. Go to www.dell.com/support.

Software updates may have been downloaded in the background. Restart your tablet.

Pen

Problems

Pen does not work

Possible causes

The pen is not charged

Possible solutions

- Charge the Dell mini Active Pen by inserting it into the Pen garage for 10 seconds with the tablet docked and in use.
- Replace the battery on the Dell Active Pen.

Getting help

Self-help resources

You can get information and help on Dell products and services using these self-help resources:

Information about Dell products and services

www.dell.com

Dell Help & Support app



Get started app



Help + Tips app



Accessing help

In Windows search, type **Help and Support**, and tap **Enter**.

Online help for operating system

www.dell.com/support/windows

Troubleshooting information, user manuals, setup instructions, product specifications, technical help blogs, drivers, software updates, and so on

www.dell.com/support

Learn about your operating system, setting up and using your tablet, data backup, diagnostics, and so on.

See *Me and My Dell* at www.dell.com/support/manuals.

Contacting Dell

To contact Dell for sales, technical assistance, or customer service issues:

- 1 Go to www.dell.com/contactdell.
- 2 Verify your country or region in the **Choose a Country/Region** drop-down list at the bottom of the page.
- 3 Select the appropriate service or support link based on your requirement or choose the method of contacting Dell that is convenient for you.

Dell provides several online and telephone-based support and service options. Availability varies by country and product, and some services may not be available in your area.

 **NOTE:** If you do not have an active internet connection, you can find contact information on your purchase invoice, packing slip, bill, or Dell product catalog.

Locating your Service Tag and Express Service Code

You must provide the Service Tag and Express Service Code of your tablet when contacting Dell for customer service or technical assistance.

NOTE: The telephone systems prompts you to enter the Express Service Code that helps in routing your call efficiently.

The Service Tag and Express Service Code for your tablet are located on a label at the bottom of the tablet.

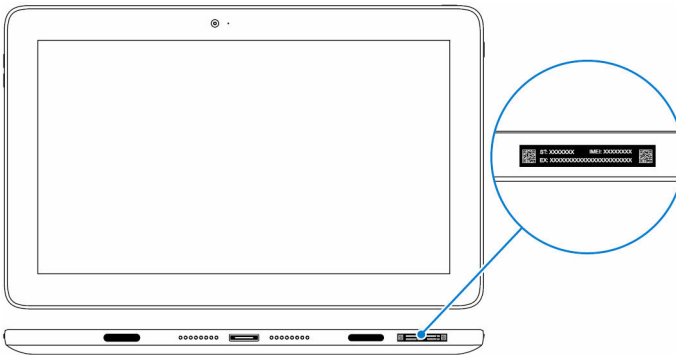

Free Manuals Download Website

<http://myh66.com>

<http://usermanuals.us>

<http://www.somanuals.com>

<http://www.4manuals.cc>

<http://www.manual-lib.com>

<http://www.404manual.com>

<http://www.luxmanual.com>

<http://aubethermostatmanual.com>

Golf course search by state

<http://golfingnear.com>

Email search by domain

<http://emailbydomain.com>

Auto manuals search

<http://auto.somanuals.com>

TV manuals search

<http://tv.somanuals.com>