

Dell™ XPS™ M1330

# Owner's Manual

**Model PP25L**

# Notes, Notices, and Cautions



**NOTE:** A NOTE indicates important information that helps you make better use of your computer.



**NOTICE:** A NOTICE indicates either potential damage to hardware or loss of data and tells you how to avoid the problem.



**CAUTION:** A CAUTION indicates a potential for property damage, personal injury, or death.

---

**Information in this document is subject to change without notice.**

© 2007-2008 Dell Inc. All rights reserved.

Reproduction in any manner whatsoever without the written permission of Dell Inc. is strictly forbidden.

Trademarks used in this text: *Dell*, the *DELL* logo, *XPS*, *Wi-Fi Catcher*, and *Dell MediaDirect* are trademarks of Dell Inc.; *Intel* is a registered trademark and *Core* is a trademark of Intel Corporation in the U.S. and other countries; *Microsoft*, *Windows*, and *Windows Vista* are either trademarks or registered trademarks of Microsoft Corporation in the United States and/or other countries; *Bluetooth* is a registered trademark owned by Bluetooth SIG, Inc. and is used by Dell under license.

Other trademarks and trade names may be used in this document to refer to either the entities claiming the marks and names or their products. Dell Inc. disclaims any proprietary interest in trademarks and trade names other than its own.

Model PP25L

September 2008

P/N RW491

Rev. A03

# Contents

	<b>Finding Information</b> . . . . .	<b>13</b>
<b>1</b>	<b>About Your Computer</b> . . . . .	<b>19</b>
	<b>Determining Your Computer's Configuration</b> . . . . .	<b>19</b>
	<b>Front View</b> . . . . .	<b>20</b>
	<b>Left Side View</b> . . . . .	<b>24</b>
	<b>Right Side View</b> . . . . .	<b>26</b>
	<b>Back View</b> . . . . .	<b>28</b>
	<b>Bottom View</b> . . . . .	<b>29</b>
<b>2</b>	<b>Setting Up Your Computer</b> . . . . .	<b>31</b>
	<b>Connecting to the Internet</b> . . . . .	<b>31</b>
	Setting Up Your Internet Connection . . . . .	32
	<b>Transferring Information to a New Computer</b> . . . . .	<b>33</b>
	Microsoft Windows Easy Transfer . . . . .	33
	<b>Setting Up a Printer</b> . . . . .	<b>33</b>
	Printer Cable . . . . .	34
	Connecting a USB Printer . . . . .	34

<b>Power Protection Devices</b> . . . . .	<b>35</b>
Surge Protectors . . . . .	35
Line Conditioners . . . . .	36
Uninterruptible Power Supplies (UPS) . . . . .	36
<b>3 Using the System Setup Program</b> . . . . .	<b>37</b>
Viewing the System Setup Screen . . . . .	38
System Setup Screen . . . . .	38
Commonly Used Options . . . . .	38
<b>Cleaning Your Computer</b> . . . . .	<b>40</b>
Computer, Keyboard, and Display . . . . .	40
Touch Pad . . . . .	41
Mouse . . . . .	41
Media . . . . .	42
<b>4 Using the Keyboard and Touch Pad</b> . . . . .	<b>43</b>
<b>Numeric Keypad</b> . . . . .	<b>43</b>
<b>Key Combinations</b> . . . . .	<b>43</b>
System Functions . . . . .	43
Display Functions . . . . .	43
Battery . . . . .	43
Power Management . . . . .	44
Microsoft® Windows® Logo Key Functions . . . . .	44
Dell™ QuickSet Key Combinations . . . . .	44
Adjusting Keyboard Settings . . . . .	44
<b>Touch Pad</b> . . . . .	<b>45</b>
Customizing the Touch Pad . . . . .	46

5	Using the Display . . . . .	47
	<b>Adjusting Brightness</b> . . . . .	47
	<b>Switching the Video Image From Your Computer Display To a Projector</b> . . . . .	47
	<b>Setting Display Resolution and Refresh Rate</b> . . . . .	47
6	Using a Battery . . . . .	49
	<b>Battery Performance</b> . . . . .	49
	<b>Checking the Battery Charge</b> . . . . .	50
	Dell QuickSet Battery Meter . . . . .	50
	Microsoft® Windows® Battery Meter . . . . .	51
	Charge Gauge . . . . .	51
	Low-Battery Warning . . . . .	52
	<b>Conserving Battery Power</b> . . . . .	52
	Configuring Power Management Settings . . . . .	52
	Using the Sleep Power State . . . . .	53
	<b>Charging the Battery</b> . . . . .	53
	<b>Replacing the Battery</b> . . . . .	54
	<b>Storing a Battery</b> . . . . .	55
7	Using Multimedia . . . . .	57
	<b>Playing Media</b> . . . . .	57
	<b>Playing Media Using Dell Travel Remote (Optional)</b> . . . . .	58

	<b>Copying CDs and DVDs</b> . . . . .	<b>60</b>
	How to Copy a CD or DVD . . . . .	60
	Using Blank CDs and DVDs . . . . .	60
	Helpful Tips . . . . .	61
	<b>Adjusting the Volume</b> . . . . .	<b>62</b>
	<b>Adjusting the Picture</b> . . . . .	<b>62</b>
	<b>Using Dell MediaDirect™</b> . . . . .	<b>63</b>
	<b>Connecting Your Computer to a TV Using the HDMI Connector</b> . . . . .	<b>64</b>
	Enabling the Display Settings for a TV . . . . .	64
	Enabling the Audio Settings for a TV . . . . .	65
<b>8</b>	<b>Using ExpressCards</b> . . . . .	<b>67</b>
	<b>ExpressCard Blanks</b> . . . . .	<b>67</b>
	<b>Installing an ExpressCard</b> . . . . .	<b>68</b>
	<b>Removing an ExpressCard or Blank</b> . . . . .	<b>69</b>
<b>9</b>	<b>Using the Memory Card Reader</b> . . . . .	<b>71</b>
	<b>Memory Card Blanks</b> . . . . .	<b>71</b>
	<b>Installing a Memory Card</b> . . . . .	<b>71</b>
	<b>Removing a Memory Card or Blank</b> . . . . .	<b>72</b>

10	Setting Up and Using Networks . . . . .	73
	<b>Connecting a Network or Broadband</b>	
	<b>Modem Cable . . . . .</b>	<b>73</b>
	<b>Setting Up a Network . . . . .</b>	<b>74</b>
	<b>Wireless Local Area Network (WLAN) . . . . .</b>	<b>74</b>
	What You Need to Establish a WLAN	
	Connection . . . . .	74
	Checking Your Wireless Network Card . . . . .	74
	Setting Up a New WLAN Using a Wireless	
	Router and a Broadband Modem . . . . .	75
	Connecting to a WLAN . . . . .	77
	<b>Mobile Broadband (or Wireless Wide</b>	
	<b>Area Network) . . . . .</b>	<b>78</b>
	What You Need to Establish a Mobile	
	Broadband Network Connection . . . . .	78
	Checking Your Dell Mobile Broadband Card . . . . .	79
	Connecting to a Mobile Broadband Network . . . . .	80
	Enabling/Disabling the Dell Mobile	
	Broadband Card . . . . .	80
	<b>Dell Wi-Fi Catcher™ Network Locator . . . . .</b>	<b>81</b>
11	Securing Your Computer . . . . .	83
	<b>Security Cable Lock . . . . .</b>	<b>83</b>
	<b>Passwords . . . . .</b>	<b>83</b>
	<b>Fingerprint Reader (Optional) . . . . .</b>	<b>84</b>
	<b>If Your Computer Is Lost or Stolen . . . . .</b>	<b>85</b>

<b>12 Troubleshooting</b> . . . . .	<b>87</b>
<b>Dell Technical Update Service</b> . . . . .	<b>87</b>
<b>Dell Diagnostics</b> . . . . .	<b>87</b>
<b>Dell Support Center</b> . . . . .	<b>91</b>
Dell Support 3 . . . . .	92
Dell PC Tune-Up . . . . .	93
Dell PC CheckUp . . . . .	93
Dell Network Assistant . . . . .	94
DellConnect . . . . .	94
<b>Drive Problems</b> . . . . .	<b>94</b>
Optical drive problems . . . . .	95
Hard drive problems . . . . .	96
<b>E-Mail, Modem, and Internet Problems</b> . . . . .	<b>96</b>
<b>Error Messages</b> . . . . .	<b>98</b>
<b>ExpressCard Problems</b> . . . . .	<b>103</b>
<b>IEEE 1394 Device Problems</b> . . . . .	<b>103</b>
<b>Keyboard Problems</b> . . . . .	<b>104</b>
External Keyboard problems . . . . .	104
Unexpected characters . . . . .	105
<b>Lockups and Software Problems</b> . . . . .	<b>105</b>
The computer does not start . . . . .	105
The computer stops responding . . . . .	105
A program stops responding or crashes repeatedly . . . . .	106
A program is designed for an earlier Microsoft Windows operating system . . . . .	106
A solid blue screen appears . . . . .	106



Dell MediaDirect problems . . . . .	106
Other software problems . . . . .	107
<b>Memory Problems . . . . .</b>	<b>108</b>
<b>Network Problems . . . . .</b>	<b>108</b>
Mobile Broadband (Wireless Wide Area Network [WWAN]) . . . . .	109
<b>Power Problems . . . . .</b>	<b>110</b>
<b>Printer Problems . . . . .</b>	<b>111</b>
<b>Scanner Problems . . . . .</b>	<b>112</b>
<b>Sound and Speaker Problems . . . . .</b>	<b>112</b>
No sound from integrated speakers . . . . .	112
No sound from external speakers . . . . .	113
No sound from headphones . . . . .	113
<b>Touch Pad or Mouse Problems . . . . .</b>	<b>113</b>
<b>Video and Display Problems . . . . .</b>	<b>114</b>
If the display is blank . . . . .	114
If the display is difficult to read . . . . .	115
If only part of the display is readable . . . . .	116
<b>Drivers . . . . .</b>	<b>116</b>
What Is a Driver? . . . . .	116
Identifying Drivers . . . . .	117
Reinstalling Drivers and Utilities . . . . .	117
<b>Troubleshooting Software and Hardware Problems in the Windows Vista® Operating System . . . . .</b>	<b>119</b>
<b>Restoring Your Microsoft® Windows Vista® Operating System . . . . .</b>	<b>120</b>
Using Windows Vista System Restore . . . . .	121
Using the Operating System Media . . . . .	124

<b>13 Adding and Replacing Parts</b>	<b>127</b>
<b>Before You Begin</b>	<b>127</b>
Recommended Tools	127
Turning Off Your Computer	127
Before Working Inside Your Computer	128
<b>Hard Drive</b>	<b>129</b>
Removing the Hard Drive	130
Replacing the Hard Drive	131
Returning a Hard Drive to Dell	131
<b>Hinge Covers and Center Control Cover</b>	<b>132</b>
Removing the Hinge Covers and Center Control Cover	132
Replacing the Hinge Covers and Center Control Cover	134
<b>Keyboard</b>	<b>135</b>
Removing the Keyboard	135
Replacing the Keyboard	136
<b>Memory</b>	<b>137</b>
Removing the DIMM 1 Memory Module	137
Replacing the DIMM 1 Memory Module	139
Removing the DIMM 2 Memory Module	140
Replacing the DIMM 2 Memory Module	142
<b>Subscriber Identity Module</b>	<b>144</b>
<b>Wireless Mini-Cards</b>	<b>144</b>
Removing a WLAN Card	145
Replacing a WLAN Card	147
Removing a Mobile Broadband or WWAN Card	147
Replacing a WWAN Card	149

<b>Flash Cache Module (FCM)</b> . . . . .	<b>150</b>
Removing the FCM . . . . .	150
Replacing the FCM . . . . .	151
<b>Internal Card With Bluetooth® Wireless Technology</b> . . . . .	<b>151</b>
Removing the Card . . . . .	151
Replacing the Card . . . . .	152
<b>Coin-Cell Battery</b> . . . . .	<b>152</b>
Removing the Coin-Cell Battery . . . . .	153
Replacing the Coin-Cell Battery . . . . .	153
<b>14 Dell™ QuickSet</b> . . . . .	<b>155</b>
<b>15 Traveling With Your Computer</b> . . . . .	<b>157</b>
<b>Identifying Your Computer</b> . . . . .	<b>157</b>
<b>Packing the Computer</b> . . . . .	<b>157</b>
<b>Travel Tips</b> . . . . .	<b>158</b>
Traveling by Air . . . . .	158
<b>16 Getting Help</b> . . . . .	<b>159</b>
<b>Obtaining Assistance</b> . . . . .	<b>159</b>
Technical Support and Customer Service . . . . .	160
DellConnect . . . . .	160
Online Services . . . . .	160
AutoTech Service . . . . .	161
Automated Order-Status Service . . . . .	161
<b>Problems With Your Order</b> . . . . .	<b>161</b>

<b>Product Information</b> . . . . .	161
<b>Returning Items for Warranty Repair or Credit</b> . . . . .	162
<b>Before You Call</b> . . . . .	162
<b>Contacting Dell</b> . . . . .	164
17 Specifications . . . . .	165
A Appendix . . . . .	173
<b>Dell Technical Support Policy (U.S. Only)</b> . . . . .	173
Definition of "Dell-Installed" Software and Peripherals . . . . .	173
Definition of "Third-Party" Software and Peripherals . . . . .	174
<b>FCC Notice (U.S. Only)</b> . . . . .	174
FCC Class B . . . . .	174
<b>Macrovision Product Notice</b> . . . . .	175
Glossary . . . . .	177
Index . . . . .	195

# Finding Information

 **NOTE:** Some features or media may be optional and may not ship with your computer. Some features or media may not be available in certain countries.

 **NOTE:** Additional information may ship with your computer.

---

## What Are You Looking For?

- A diagnostic program for my computer
- Drivers for my computer
- Device documentation
- Notebook System Software (NSS)

## Find It Here

### Drivers and Utilities Media

Documentation and drivers are already installed on your computer. You can use the *Drivers and Utilities* media to reinstall drivers (see "Reinstalling Drivers and Utilities" on page 117) or run the Dell Diagnostics (see "Dell Diagnostics" on page 87).

Readme files may be included on your *Drivers and Utilities* media to provide last-minute updates about technical changes to your computer or advanced technical-reference material for technicians or experienced users.



**NOTE:** Drivers and documentation updates can be found at [support.dell.com](http://support.dell.com).

---

**What Are You Looking For?**

- Warranty information
- Terms and Conditions (U.S. only)
- Safety instructions
- Regulatory information
- Ergonomics information
- End User License Agreement

**Find It Here****Dell™ Product Information Guide**

- 
- How to set up my computer

**Setup Diagram**

**NOTE:** The appearance of your setup diagram may vary.



---

**What Are You Looking For?**

- Service Tag and Express Service Code
- Microsoft® Windows® License Label

**Find It Here****Service Tag and Microsoft Windows Product Key**

These labels are located on your computer.

- Use the Service Tag to identify your computer when you use [support.dell.com](http://support.dell.com) or contact support.
- Enter the Express Service Code to direct your call when contacting support.



**NOTE:** As an increased security measure, the newly designed Microsoft Windows license label incorporates a missing portion or "hole" to discourage removal of the label.

---

**What Are You Looking For?****Find It Here**

- Solutions — Troubleshooting hints and tips, articles from technicians, online courses, and frequently asked questions
- Community — Online discussion with other Dell customers
- Upgrades — Upgrade information for components, such as the memory, hard drive, and operating system
- Customer Care — Contact information, service call and order status, and warranty and repair information
- Service and support — Service call status, support history, service contract, and online discussions with support
- Dell Technical Update Service — Proactive e-mail notification of software and hardware updates for your computer
- Reference — Computer documentation, details on my computer configuration, product specifications, and white papers
- Downloads — Certified drivers, patches, and software updates
- Notebook System Software (NSS) — If you reinstall the operating system on your computer, you should also reinstall the NSS utility. NSS automatically detects your computer and operating system, and installs the updates appropriate for your configuration, providing critical updates for your operating system and support for Dell 3.5-inch USB floppy drives, Intel® processors, optical drives, and USB devices. NSS is necessary for correct operation of your Dell computer.

**Dell Support Website** — [support.dell.com](http://support.dell.com)

**NOTE:** Select your region or business segment to view the appropriate support site.

To download Notebook System Software:

- 1** Go to [support.dell.com](http://support.dell.com), select your country/region, and then click **Drivers & Downloads**.
- 2** Enter your Service Tag or product model, and then click **Go**.
- 3** Select your operating system and language, and then click **Find Downloads**, or under **Downloads Search**, search for the keyword *Notebook System Software*.

**NOTE:** The [support.dell.com](http://support.dell.com) user interface may vary depending on your selections.



---

**What Are You Looking For?****Find It Here**

---

- Software upgrades and troubleshooting hints — Frequently asked questions, hot topics, and general health of your computing environment

**Dell Support Utility**

The Dell Support Utility is an automated upgrade and notification system installed on your computer. This support provides real-time health scans of your computing environment, software updates, and relevant self-support information. Access the Dell Support Utility from the  icon on the taskbar. For more information, see "Dell Support 3" on page 92.

- 
- How to use Windows Vista™
  - How to work with programs and files
  - How to personalize my desktop

**Windows Help and Support**

- 1** Click the Windows Vista Start button , and then click **Help and Support**.
- 2** In *Search Help*, type a word or phrase that describes your problem, and then press <Enter> or click the magnifying glass.
- 3** Click the topic that describes your problem.
- 4** Follow the instructions on the screen.

- 
- Information on network activity, the Power Management Wizard, hotkeys, and other items controlled by Dell QuickSet.

**Dell QuickSet Help**

To view *Dell QuickSet Help*, right-click the Dell QuickSet icon in the Windows notification area.

For more information on Dell QuickSet, see "Dell™ QuickSet" on page 155.

---

## What Are You Looking For?

- How to reinstall my operating system

## Find It Here

### Operating System Media

The operating system is already installed on your computer. To reinstall your operating system, use one of the following methods:

- Microsoft Windows System Restore — Microsoft Windows System Restore returns your computer to an earlier operating state without affecting data files.
- Dell PC Restore — Dell PC Restore returns your computer to its original operating state. Dell PC Restore may not ship with your computer.
- Operating System Installation Media — If you received operating system media with your computer, you can use it to restore your operating system.

For more information, see "Restoring Your Microsoft® Windows Vista® Operating System" on page 120.

After you reinstall your operating system, use the *Drivers and Utilities* media to reinstall drivers for the devices that came with your computer.



Your operating system product key label is located on your computer.

**NOTE:** The color of your CD varies based on the operating system you ordered.

---

# About Your Computer

## Determining Your Computer's Configuration

Based on selections that you made when purchasing your computer, your computer has one of several different video controller configurations. To determine your computer's video controller configuration:

- 1 Click **Start** , and then click **Help and Support**.
- 2 Under **Pick a Task**, click **Use Tools to view your computer information and diagnose problems**.
- 3 Under **My Computer Information**, select **Hardware**.

From the **My Computer Information - Hardware** screen, you can view the type of video controller installed in your computer, as well as the other hardware components.

# Front View



- |    |                      |    |                                     |
|----|----------------------|----|-------------------------------------|
| 1  | camera indicator     | 2  | camera (optional)                   |
| 3  | display              | 4  | media control buttons               |
| 5  | keyboard             | 6  | fingerprint reader (optional)       |
| 7  | 8-in-1 memory reader | 8  | microphone connector                |
| 9  | audio connectors     | 10 | touch pad buttons                   |
| 11 | touch pad            | 12 | media direct button                 |
| 13 | power button         | 14 | dual digital microphones (optional) |

**CAMERA INDICATOR** — Indicates that the camera is turned on. Based on configuration selections that you made when ordering your computer, your computer may not include a camera.









**CAMERA (OPTIONAL)** — Built-in camera for video capture, conferencing, and chat. Based on configuration selections that you made when ordering your computer, your computer may not include a camera.

**DISPLAY** — For more information about your display, see "Using the Display" on page 47.

**MEDIA CONTROL BUTTONS** — Control CD, DVD, and Media Player playback.



---

	Eject.		Play the next track.
	Play the previous track.		Mute the sound.
	Stop.		Turn the volume down.
	Play or pause.		Turn the volume up.

---

**KEYBOARD** — For more information about the keyboard, see "Using the Keyboard and Touch Pad" on page 43.

**FINGERPRINT READER (OPTIONAL)** — Helps to keep your Dell™ computer secure. When you slide your finger over the reader, it uses your unique fingerprint to authenticate your user identity. For information on how to activate and use the security management software that controls the biometric reader, see "Fingerprint Reader (Optional)" on page 84.

**8-IN-1 MEMORY CARD READER** — Provides a fast and convenient way to view and share digital photos, music, and videos stored on a memory card. The computer ships with a plastic *blank* installed in the slot. The 8-in-1 memory card reader reads the following digital memory cards:

- Secure Digital (SD) memory card
- SDIO card
- MultiMediaCard (MMC)
- Memory Stick
- Memory Stick PRO
- xD-Picture Card
- Hi Speed-SD
- Hi Density-SD

#### **MICROPHONE AND AUDIO CONNECTORS**

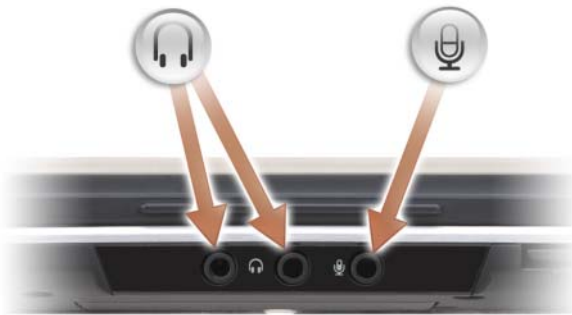

---

Attach headphones to either  connector.

---

Attach a microphone to the  connector.

---

**TOUCH PAD BUTTONS** — Use these buttons much like the buttons on a mouse when you use the touch pad to move the cursor on the display. (For more information about using the touch pad, see "Touch Pad" on page 45.)

**TOUCH PAD** — Provides the functionality of a mouse (see "Touch Pad" on page 45).

**DELL™ MEDIADIRECT™ BUTTON** — Press the Dell MediaDirect button to launch Dell MediaDirect. For more information, see "Using Dell MediaDirect™" on page 63.

**POWER BUTTON** — Press the power button to turn on the computer or exit a power management mode (see "Configuring Power Management Settings" on page 52).

**➡ NOTICE:** To avoid losing data, turn off your computer by performing a Microsoft® Windows® operating system shutdown rather than by pressing the power button.

If the computer stops responding, press and hold the power button until the computer turns off completely (may take several seconds).

**DUAL DIGITAL MICROPHONES** — Built-in microphone for conferencing and chat.

#### DEVICE STATUS LIGHTS



The blue lights located above the keyboard indicate the following:

- 
-  Turns on when the numeric keypad (Num Lock) is enabled.

---

  -  Turns on when the uppercase letter (Caps Lock) function is enabled.

---

  -  Turns on when the scroll lock function is enabled.



Turns on when wireless networking is enabled. To enable or disable wireless networking, use the wireless switch. For details, see "Right Side View" on page 26.



Turns on when Bluetooth® Wireless Technology is enabled.

**NOTE:** The  light turns on only if you ordered Bluetooth Wireless Technology with your computer. For more information, see the documentation that came with your Bluetooth Wireless Technology.

To turn off only the Bluetooth wireless technology functionality, right-click the  icon in the notification area, and then click **Disable Bluetooth Radio**.

To quickly enable or disable all wireless devices, use the wireless switch (see "Right Side View" on page 26).

If the computer is connected to an electrical outlet, the  light operates as follows:

- Solid blue: The battery is charging.
- Flashing blue: The battery is almost fully charged.
- Off: The battery is adequately charged.

If the computer is running on a battery, the  light operates as follows:

- Off: The battery is adequately charged (or the computer is turned off).
- Flashing amber: The battery charge is low.
- Solid amber: The battery charge is critically low.

## Left Side View



- |   |                           |   |                     |
|---|---------------------------|---|---------------------|
| 1 | AC adapter connector      | 2 | video connector     |
| 3 | network connector (RJ-45) | 4 | USB connector       |
| 5 | HDMI connector            | 6 | IEEE 1394 connector |
| 7 | hard drive                |   |                     |



**AC ADAPTER CONNECTOR** — Attaches an AC adapter to the computer. The AC adapter converts AC power to the DC power required by the computer. You can connect the AC adapter with your computer turned on or off.



1 AC adapter port      2 AC adapter connector

**⚠ CAUTION:** The AC adapter works with electrical outlets worldwide. However, power connectors and power strips vary among countries. Using an incompatible cable or improperly connecting the cable to the power strip or electrical outlet may cause fire or equipment damage.

**➡ NOTICE:** When you disconnect the AC adapter cable from the computer, grasp the connector, not the cable itself, and pull firmly, but gently to help prevent damage to the cable.

**VIDEO CONNECTOR**



Connects video devices, such as a monitor.

## NETWORK CONNECTOR (RJ-45)

**NOTICE:** The network connector is slightly larger than the modem connector. To avoid damaging the computer, do not plug a telephone line into the network connector.

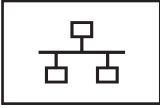

Connects the computer to a network. The two lights next to the connector indicate status and activity for wired network connections.

For information on using the network adapter, see the device user's guide supplied with your computer.

## USB CONNECTOR

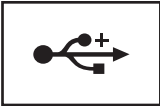

Connects USB devices, such as a mouse, keyboard, or printer.

**HDMI CONNECTOR** — High-Definition Multimedia Interface connector carries an uncompressed all digital signal to produce hi-definition video and audio.

**IEEE 1394 CONNECTOR** — Connects devices supporting IEEE 1394 high-speed transfer rates, such as some digital video cameras.

**HARD DRIVE** — Stores software and data.

## Right Side View

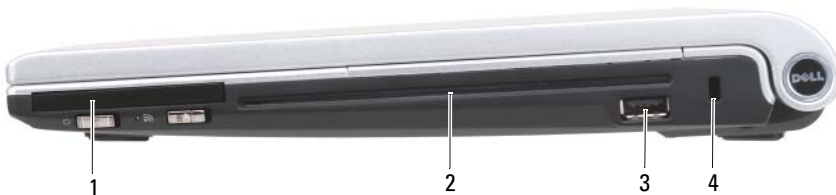

- 1 ExpressCard slot
- 3 USB connector

- 2 optical drive
- 4 security cable slot

**EXPRESSCARD SLOT** — Supports one ExpressCard. The computer ships with a plastic *blank* installed in the slot. For more information, see "Using ExpressCards" on page 67.

**OPTICAL DRIVE** — For more information about the optical drive, see "Using Multimedia" on page 57.

## USB CONNECTOR

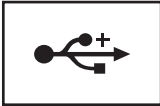

Connects USB devices, such as a mouse, keyboard, or printer.

**SECURITY CABLE SLOT** — Lets you attach a commercially available antitheft device to the computer (see "Security Cable Lock" on page 83).



- |   |                                      |   |               |
|---|--------------------------------------|---|---------------|
| 1 | Wireless On/Off Switch               | 2 | LED indicator |
| 3 | Dell™ Wi-Fi Catcher™ Network Locator |   |               |

**WIRELESS ON/OFF SWITCH** — When enabled through Dell QuickSet, this switch can scan for a wireless LAN (WLAN) in your vicinity. You can also use it to rapidly turn off or on any wireless devices such as WLAN cards and internal cards with Bluetooth Wireless Technology. For information about Dell QuickSet, see "Dell™ QuickSet" on page 155. For information on how to scan for wireless networks in your vicinity, see "Dell Wi-Fi Catcher™ Network Locator" on page 81.

**LED INDICATOR** — Lights up when you are connected to a WLAN.

**WI-FI CATCHER™ NETWORK LOCATOR SWITCH** — When enabled through Dell QuickSet, this switch can scan for a wireless local area network (WLAN) in your vicinity. For more information, see "Dell Wi-Fi Catcher™ Network Locator" on page 81.

## Back View



1 battery      2 air vents

**AIR VENTS** — The computer uses an internal fan to create airflow through the vents, which prevents the computer from overheating.

 **NOTE:** The computer turns the fan on when the computer gets hot. Fan noise is normal and does not indicate a problem with the fan or the computer.

 **CAUTION:** Do not block, push objects into, or allow dust to accumulate in the air vents. Do not store your computer in a low-airflow environment, such as a closed briefcase, while it is running. Restricting the airflow can damage the computer or cause a fire.

## Bottom View

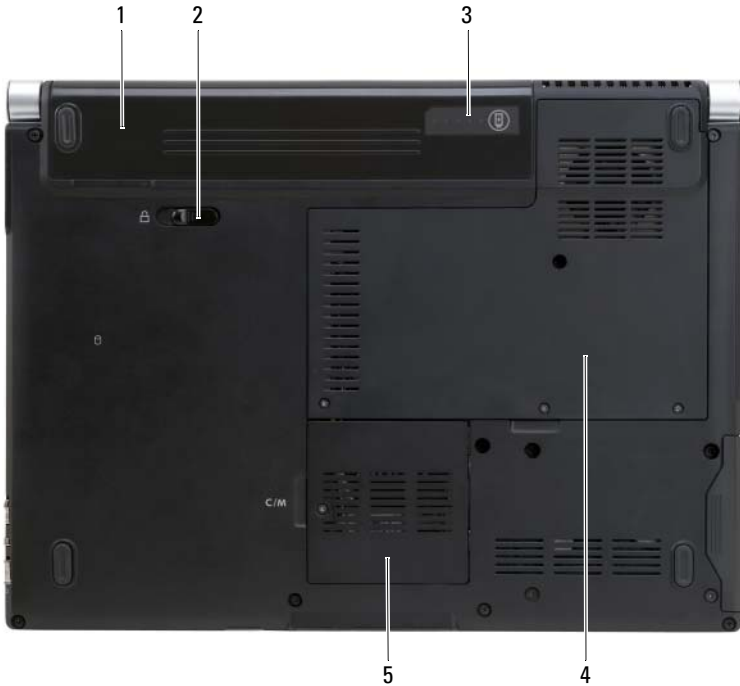

- |                                  |   |
|----------------------------------|---|
| 1 battery                        | 2 battery release latch                       |
| 3 battery charge/health gauge    | 4 memory module/coin-cell battery compartment |
| 5 wireless mini-card compartment |   |

**BATTERY** — When a battery is installed, you can use the computer without connecting the computer to an electrical outlet (see "Using a Battery" on page 49).

**BATTERY RELEASE LATCH** — Releases the battery (see "Replacing the Battery" on page 54 for instructions).

**BATTERY CHARGE/HEALTH GAUGE** — Provides information on the battery charge (see "Checking the Battery Charge" on page 50).

**MEMORY MODULE/COIN-CELL BATTERY COMPARTMENT** — Covers the compartment that contains the DIMM 1 and DIMM 2 memory modules and the coin-cell battery. For additional information, see "Adding and Replacing Parts" on page 127.

**WIRELESS MINI-CARD COMPARTMENT** — Compartment for WLAN, WWAN, or FCM Mini-Cards (see "Wireless Mini-Cards" on page 144).

# Setting Up Your Computer

## Connecting to the Internet

 **NOTE:** ISPs and ISP offerings vary by country.

To connect to the Internet, you need a modem or network connection and an Internet service provider (ISP). Your ISP will offer one or more of the following Internet connection options:

- DSL connections that provide high-speed Internet access through your existing telephone line or cellular telephone service. With a DSL connection, you can access the Internet and use your telephone on the same line simultaneously.
- Cable modem connections that provide high-speed Internet access through your local cable TV line.
- Satellite modem connections that provide high-speed Internet access through a satellite television system.
- Dial-up connections that provide Internet access through a telephone line. Dial-up connections are considerably slower than DSL, cable, and satellite modem connections.
- Wireless Wide Area Network (WWAN) or Mobile Broadband technology provides a connection to the Internet using cellular technology at broadband rates.
- Wireless Local Area Network (WLAN) connections that provide Internet access using Bluetooth<sup>®</sup> wireless technology. WLAN connections use high-frequency radio waves to communicate. Typically, a wireless router is connected to the broadband cable or DSL modem that broadcasts the Internet signal to your computer.

If you are using a dial-up connection, connect a telephone line to the modem connector on your computer and to the telephone wall jack before you set up your Internet connection. If you are using a DSL, cable, or satellite modem connection, contact your ISP or cellular telephone service for setup instructions.

## Setting Up Your Internet Connection

To set up an Internet connection with a provided ISP desktop shortcut:

- 1 Save and close any open files, and exit any open programs.
- 2 Double-click the ISP icon on the Microsoft® Windows® desktop.
- 3 Follow the instructions on the screen to complete the setup.



**NOTE:** If you are having problems connecting to the Internet, see "E-Mail, Modem, and Internet Problems" on page 96. If you cannot connect to the Internet, but have successfully connected in the past, the ISP may have a service outage. Contact your ISP to check the service status, or try connecting again later.



**NOTE:** Have your ISP information ready. If you do not have an ISP, the **Connect to the Internet** wizard can help you obtain one.

If you do not have an ISP icon on your desktop or if you want to set up an Internet connection with a different ISP:

- 1 Save and close any open files, and exit any open programs.
- 2 Click **Start** , and then click **Control Panel**.
- 3 Under **Network and Internet**, click **Connect to the Internet**.

The **Connect to the Internet** window appears.

- 4 Click **Broadband (PPPoE)**, **Wireless**, or **Dial-up**, depending on how you want to connect:
  - Choose **Broadband** if you will use a DSL modem, cable TV modem, or satellite modem.
  - Choose **Wireless** if you will use a wireless connection through a WLAN card.
  - Choose **Dial-up** if you will use a dial-up modem or ISDN.



**NOTE:** If you do not know which type of connection to select, click **Help me choose** or contact your ISP.

- 5 Follow the instructions on the screen and use the setup information provided by your ISP to complete the setup.



## Transferring Information to a New Computer

You can transfer the following types of data from one computer to another:

- E-mail messages
- Toolbar settings
- Window sizes
- Internet bookmarks

Use one of the following methods for transferring data:

- Microsoft® Windows® Easy Transfer wizard, an Easy Transfer Cable, and a USB port
- Over a network
- Removable media, such as a writable CD

### Microsoft Windows Easy Transfer

- 1 Click **Start**  → **All Programs** → **Accessories** → **System Tools** → **Windows Easy Transfer**.
- 2 In the **User Account Control** dialog box, click **Continue**.
- 3 Click **Next**.
- 4 Click **Start a new transfer** or **Continue a transfer in progress**.
- 5 Follow the instructions in the Windows Easy Transfer wizard.

## Setting Up a Printer

 **NOTICE:** Complete the operating system setup before you connect a printer to the computer.

See the documentation that came with the printer for setup information, including how to:

- Obtain and install updated drivers
- Connect the printer to the computer
- Load paper and install the toner or ink cartridge

For technical assistance, refer to the printer owner's manual or contact the printer manufacturer.

## Printer Cable

Your printer connects to your computer using a USB cable. Your printer may not come with a printer cable, so if you purchase a cable separately, ensure that it is compatible with your printer and computer. If you purchased a printer cable at the same time you purchased your computer, the cable may arrive in the computer's shipping box.

### Connecting a USB Printer



**NOTE:** You can connect USB devices while the computer is turned on.

- 1 Complete the operating system setup if you have not already done so.
- 2 Attach the USB printer cable to the USB connectors on the computer and the printer. The USB connectors fit only one way.

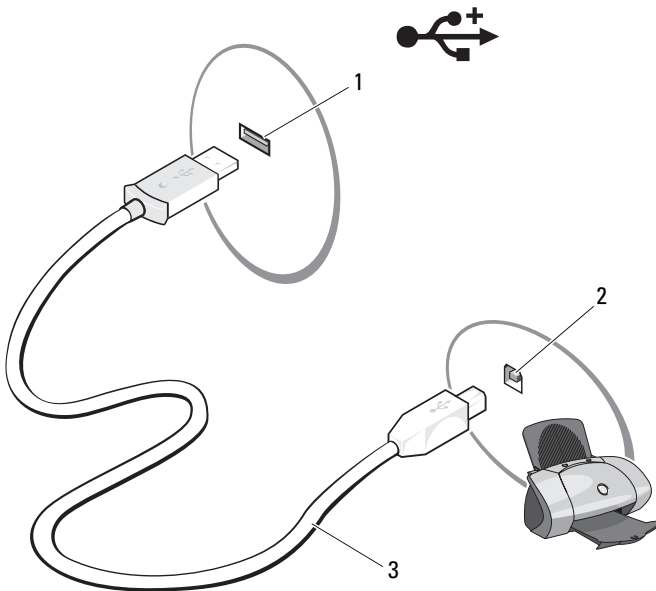

- 1 USB connector on computer
- 2 USB connector on printer
- 3 USB printer cable

3 Turn the printer on, and then turn the computer on.

If the Add New **Hardware Wizard** window appears, click **Cancel**.

4 Click **Start** , and then click **Network**.

5 Click **Add a printer** to start the Add Printer Wizard.



**NOTE:** To install the printer driver, see "Reinstalling Drivers and Utilities" on page 117 and the documentation that came with your printer.

6 Click **Add a local printer** or **Add a network, wireless, or Bluetooth printer**.

7 Follow the instructions in the Add Printer Wizard.

## Power Protection Devices

Several devices are available to protect against power fluctuations and failures:

- Surge protectors
- Line conditioners
- Uninterruptible power supplies (UPSs)

### Surge Protectors

Surge protectors and power strips equipped with surge protection help prevent damage to your computer from voltage spikes that can occur during electrical storms or after power interruptions. Some surge protector manufacturers include warranty coverage for certain types of damage. Carefully read the device warranty when choosing a surge protector. A device with a higher joule rating offers more protection. Compare joule ratings to determine the relative effectiveness of different devices.



**NOTICE:** Most surge protectors do not protect against power fluctuations or power interruptions caused by nearby lightning strikes. When lightning occurs in your area, disconnect the telephone line from the telephone wall jack and disconnect your computer from the electrical outlet.

Many surge protectors have a telephone jack for modem protection. See the surge protector documentation for modem connection instructions.



**NOTICE:** Not all surge protectors offer network adapter protection. Disconnect the network cable from the network wall jack during electrical storms.

## Line Conditioners

 **NOTICE:** Line conditioners do not protect against power interruptions.

Line conditioners are designed to maintain AC voltage at a fairly constant level.

## Uninterruptible Power Supplies (UPS)

 **NOTICE:** Loss of power while data is being saved to the hard drive may result in data loss or file damage.

 **NOTE:** To ensure maximum battery operating time, connect only your computer to a UPS. Connect other devices, such as a printer, to a separate power strip that provides surge protection.

A UPS protects against power fluctuations and interruptions. UPS devices contain a battery that provides temporary power to connected devices when AC power is interrupted. The battery charges while AC power is available. See the UPS manufacturer documentation for information on battery operating time and to ensure that the device is approved by Underwriters Laboratories (UL).

# Using the System Setup Program



**NOTE:** Your operating system may automatically configure most of the options available in system setup, thus overriding options that you set through system setup. An exception is the **External Hot Key** option, which you can disable or enable only through system setup. For more information on configuring features for your operating system, see Windows Help and Support (click **Start** , and then click **Help and Support**).

You can use system setup as follows:

- To set or change user-selectable features such as your computer password
- To verify information about the computer's current configuration such as the amount of system memory

After you set up the computer, run system setup to familiarize yourself with your system configuration information and optional settings. You may want to write down the information for future reference.

The system setup screens display the current setup information and settings for your computer, such as:

- System configuration
- Boot order
- Boot (start-up) configuration
- Basic device configuration settings
- System security and hard drive password settings



**NOTE:** Unless you are an expert computer user or are directed to do so by Dell technical support, do not change the system setup settings. Certain changes might make your computer work incorrectly.

## Viewing the System Setup Screen

- 1 Turn on (or restart) your computer.
- 2 When the DELL logo appears, press <F2> immediately.  
If you wait too long and the Microsoft Windows logo appears, continue to wait until you see the Windows desktop, then shut down your computer and try again.

## System Setup Screen



**NOTE:** For information about a specific item on a system setup screen, highlight the item and see the **Help** area on the screen.

On each screen, the system setup options are listed at the left. To the right of each option is the setting or value for that option. You can change settings that appear as white type on the screen. Options or values that you cannot change (because they are determined by the computer) appear less bright.

The upper-right corner of the screen displays help information for the currently highlighted option; the lower-right corner displays information about the computer. System setup key functions are listed across the bottom of the screen.

## Commonly Used Options

Certain options require that you reboot the computer for new settings to take effect.

### Changing the Boot Sequence

The *boot sequence*, or *boot order*, tells the computer where to look to find the software needed to start the operating system. You can control the boot sequence and enable/disable devices using the **Boot Order** page of the system setup program.



**NOTE:** To change the boot sequence on a one-time-only basis, see "Performing a One-Time Boot" on page 39.

The **Boot Order** page displays a general list of the bootable devices that may be installed in your computer, including but not limited to the following:

- Diskette Drive
- Internal HDD

- USB Storage Device
- CD/DVD/CD-RW drive
- Modular bay HDD



**NOTE:** Only devices that are preceded by a number are bootable.

During the boot routine, the computer starts at the top of the list and scans each enabled device for the operating system start-up files. When the computer finds the files, it stops searching and starts the operating system.

To control the boot devices, select (highlight) a device by pressing the down-arrow or up-arrow key, and then enable or disable the device or change its order in the list.

- To enable or disable a device, highlight the item and press the space bar. Enabled items are preceded by a number; disabled items are not preceded by a number.
- To reorder a device in the list, highlight the device and press <u> to move the device up the list or <d> to move a device down the list.

Boot sequence changes take effect as soon as you save the changes and exit the system setup program.

### ***Performing a One-Time Boot***

You can set a one-time-only boot sequence without entering the system setup program (you can also use this procedure to boot the Dell Diagnostics on the diagnostics utility partition on your hard drive).

- 1 Shut down the computer through the **Start** menu.
- 2 Connect the computer to an electrical outlet.
- 3 Turn on the computer. When the DELL logo appears, press <F12> immediately.

If you wait too long and the Windows logo appears, continue to wait until you see the Windows desktop, then shut down your computer and try again.

- 4 When the boot device list appears, highlight the device from which you want to boot and press <Enter>.

The computer boots to the selected device.

The next time you reboot the computer, the previous boot order is restored.

# Cleaning Your Computer

 **CAUTION:** Before you begin any of the procedures in this section, follow the safety instructions located in the *Product Information Guide*.

## Computer, Keyboard, and Display

 **CAUTION:** Before you clean your computer, disconnect the computer from the electrical outlet and remove any installed batteries. Clean your computer with a soft cloth dampened with water. Do not use liquid or aerosol cleaners, which may contain flammable substances.

- Use a can of compressed air to remove dust from between the keys on the keyboard and to remove any dirt or lint from the display.

 **NOTICE:** To help prevent damage to the computer or display, do not spray cleaning solution directly onto the display. Only use products specifically designed for cleaning displays, and follow the instructions that are included with the product.

- Moisten a soft, lint-free cloth with either water or a display cleaner. Do not use alcohol or an ammonia-based cleaner. Wipe the display gently working from the center to the edges until it is clean and any fingerprints are removed. Do not use excessive pressure.

 **NOTICE:** To prevent damage to the antiglare coating, do not wipe the display with soap or alcohol.

- Moisten a soft, lint-free cloth with water and wipe the computer and keyboard. Do not allow water from the cloth to seep between the touch pad and the surrounding palm rest.
- To clean your monitor screen, lightly dampen a soft, clean cloth with water. You can also use a special screen-cleaning tissue or solution suitable for the monitor's antistatic coating.
- Wipe the keyboard, computer, and monitor plastics with a soft cleaning cloth moistened with a solution of three parts water and one part dishwashing detergent.

Do not soak the cloth or let water drip inside your computer or keyboard.



## Touch Pad

- 1 Shut down and turn off your computer (see "Turning Off Your Computer" on page 127).
- 2 Disconnect any attached devices from the computer and from their electrical outlets.
- 3 Remove any installed batteries (see "Battery Performance" on page 49).
- 4 Moisten a soft, lint-free cloth with water, and wipe it gently across the surface of the touch pad. Do not allow water from the cloth to seep between the touch pad and the surrounding palm rest.

## Mouse



**NOTICE:** Disconnect the mouse from the computer before cleaning the mouse. If your screen cursor skips or moves abnormally, clean the mouse.

### Cleaning a Non-Optical Mouse

- 1 Clean the outside casing of the mouse with a cloth moistened with a mild cleaning solution.
- 2 Turn the retainer ring on the underside of your mouse counterclockwise, and then remove the ball.
- 3 Wipe the ball with a clean, lint-free cloth.
- 4 Blow carefully into the ball cage or use a can of compressed air to dislodge dust and lint.
- 5 If the rollers inside the ball cage are dirty, clean the rollers with a cotton swab moistened lightly with isopropyl alcohol.
- 6 Recenter the rollers in their channels if they are misaligned. Ensure that fluff from the swab is not left on the rollers.
- 7 Replace the ball and retainer ring, and turn the retainer ring clockwise until it clicks into place.

## Cleaning an Optical Mouse

Clean the outside casing of the mouse with a cloth moistened with a mild cleaning solution.

## Media

 **NOTICE:** Always use compressed air to clean the lens in the optical drive, and follow the instructions that come with the compressed air product. Never touch the lens in the drive.

If you notice problems, such as skipping, with the playback quality of your media, try cleaning the discs.

- 1 Hold the disc by its outer edge. You can also touch the inside edge of the center hole.

 **NOTICE:** To help prevent damage to the surface, do not wipe in a circular motion around the disc.

- 2 With a soft, lint-free cloth, gently wipe the bottom of the disc (the unlabeled side) in a straight line from the center to the outer edge of the disc.

For stubborn dirt, try using water or a diluted solution of water and mild soap. You can also purchase commercial products that clean discs and provide some protection from dust, fingerprints, and scratches. Cleaning products for CDs are also safe to use on DVDs.

# Using the Keyboard and Touch Pad

## Numeric Keypad

The numeric keypad functions like the numeric keypad on an external keyboard.

- To enable the keypad, press <Num Lk>. The  light indicates that the keypad is active.
- To disable the keypad, press <Num Lk> again.

## Key Combinations

### System Functions

---

<Ctrl><Shift><Esc>	Opens the <b>Task Manager</b> window.
--------------------	---------------------------------------

---

### Display Functions

---

<Fn><F8>	Displays icons representing all currently available display options (display only, external monitor or projector only, both display and projector, etc.). Highlight the desired icon to switch the display to that option.
----------	--

---

<Fn> and up-arrow key	Increases brightness on the integrated display only (not on an external monitor).
-----------------------	---

---

<Fn> and down-arrow key	Decreases brightness on the integrated display only (not on an external monitor).
-------------------------	---

---

### Battery

---

<Fn><F3>	Displays the Dell™ <u>QuickSet Battery Meter</u> (see "Dell <u>QuickSet Battery Meter</u> " on page 50).
----------	--

---

## Power Management

---

<Fn> <Esc>	Activates a power management mode. You can reprogram this keyboard shortcut to activate a different power management mode using the <b>Advanced</b> tab in the <b>Power Options Properties</b> window (see "Configuring Power Management Settings" on page 52).
------------	---

---

## Microsoft® Windows® Logo Key Functions

---

Windows logo key and <m>	Minimizes all open windows.
Windows logo key and <Shift> <m>	Restores all minimized windows. This key combination functions as a toggle to restore minimized windows following the use of the Windows logo key and <m> key combination.
Windows logo key and <e>	Runs Windows Explorer.
Windows logo key and <r>	Opens the <b>Run</b> dialog box.
Windows logo key and <f>	Opens the <b>Search Results</b> dialog box.
Windows logo key and <Ctrl> <f>	Opens the <b>Search Results-Computer</b> dialog box (if the computer is connected to a network).
Windows logo key and <Pause>	Opens the <b>System Properties</b> dialog box.

---

## Dell™ QuickSet Key Combinations

If Dell QuickSet is installed, you can use other shortcut keys for functions such as the Battery Meter or activating power management modes. For more information about Dell QuickSet key combinations, right-click the QuickSet icon in the notification area, and then click **Help**.

## Adjusting Keyboard Settings

To adjust keyboard operation, such as the character repeat rate:

- 1 Click **Start** , and then click **Control Panel**.
- 2 Click **Hardware and Sound**.
- 3 Click **Keyboard**.

## Touch Pad

The touch pad detects the pressure and movement of your finger to allow you to move the cursor on the display. Use the touch pad and touch pad buttons as you would use a mouse.

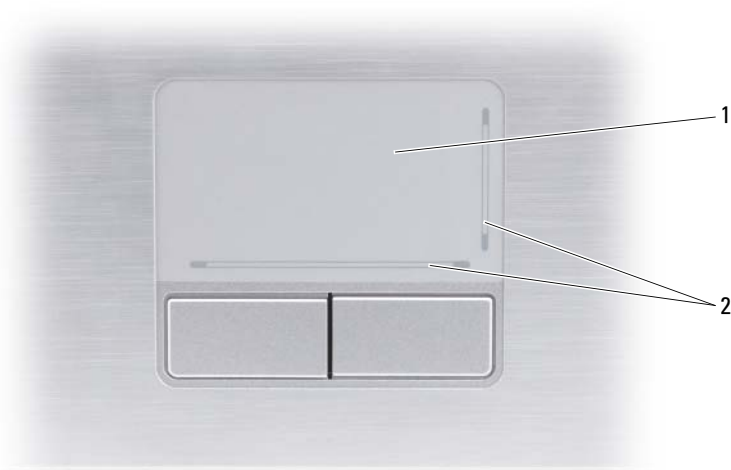

1 touch pad      2 silk screen depicting scrolling capabilities

- To move the cursor, lightly slide your finger over the touch pad.
- To select an object, lightly tap once on the surface of the touch pad or use your thumb to press the left touch pad button.
- To select and move (or drag) an object, position the cursor on the object and tap twice on the touch pad. On the second tap, leave your finger on the touch pad and move the selected object by sliding your finger over the surface.
- To double-click an object, position the cursor on the object and tap twice on the touch pad or use your thumb to press the left touch pad button twice.

## Customizing the Touch Pad

You can use the **Mouse Properties** window to disable the touch pad or adjust the touch pad settings.

- 1 Click **Start** , and then click **Control Panel**.
- 2 Click **Hardware and Sound**.
- 3 Click **Mouse**.
- 4 In the **Mouse Properties** window:
  - Click the **Device Select** tab to disable the touch pad.
  - Click the **Touch Pad** tab to adjust touch pad settings.
- 5 Click **OK** to save the settings and close the window.

# Using the Display

## Adjusting Brightness

When a Dell™ computer is running on battery power, you can conserve power by setting the display brightness to the lowest comfortable level.

- Press <Fn> and the up-arrow key to increase brightness on the integrated display only (not on an external monitor).
- Press <Fn> and the down-arrow key to decrease brightness on the integrated display only (not on an external monitor).



**NOTE:** Brightness key combinations only affect the display on your portable computer, not monitors or projectors that you attach to your portable computer or docking device. If your computer is connected to an external monitor and you try to change the brightness level, the Brightness Meter may appear, but the brightness level on the external device does not change.

## Switching the Video Image From Your Computer Display To a Projector

When you start the computer with an external device (such as an external monitor or projector) attached and turned on, the image may appear on either the computer display or the external device.

Press <Fn><F8> to switch the video image between the display only, the external device only, or the display and the external device simultaneously.

## Setting Display Resolution and Refresh Rate



**NOTE:** If you change the display resolution from the current settings, the image may appear blurry or text may be hard to read if you change the resolution to one not supported by your computer and display. Before you change any of the display settings, make a note of the current settings so you can change back to the previous settings if you need to.

You can enhance the legibility of text and change the appearance of images on the screen by adjusting display resolution. As you increase resolution, items appear smaller on the screen. In contrast, lower resolution causes text and images to appear larger and can benefit people with vision impairments. To display a program at a specific resolution, both the video card and the display must support the program, and the necessary video drivers must be installed.



**NOTE:** Use only the Dell-provided video drivers, which are designed to offer the best performance with your Dell-installed operating system. These drivers are available on the Drivers and Utilities CD (optional) or via the web at [support.dell.com](http://support.dell.com).

If you choose a resolution or color palette that is higher than the display supports, the settings adjust automatically to the closest supported values.

To set the display resolution and refresh rate for your display:

- 1 Click **Start**  → **Control Panel**.
- 2 Under **Appearance and Personalization**, click **Adjust screen resolution**.
- 3 In the **Display Settings** window, under **Resolution**, move the slide bar to the left or right to decrease or increase the screen resolution.



**NOTE:** For additional instructions, click **How do I get the best display?**





# Using a Battery

## Battery Performance

 **NOTE:** For information about the Dell™ warranty for your computer, see the *Product Information Guide* or separate paper warranty document that shipped with your computer.

For optimal computer performance and to help preserve BIOS settings, operate your Dell portable computer with the main battery installed at all times. One battery is supplied as standard equipment in the battery bay.

 **NOTE:** Because the battery may not be fully charged, use the AC adapter to connect your new computer to an electrical outlet the first time you use the computer. For best results, operate the computer with the AC adapter until the battery is fully charged. To view battery charge status, place the mouse cursor over the battery icon in the Windows notification area.

 **NOTE:** Battery operating time (the time the battery can hold a charge) decreases over time. Depending on how often the battery is used and the conditions under which it is used, you may need to purchase a new battery during the life of your computer.

 **NOTE:** It is recommended that you connect your computer to an electrical outlet when writing to media.

Battery operating time varies depending on operating conditions. Operating time is significantly reduced when you perform operations including, but not limited to, the following:

- Using optical drives.
- Using wireless communications devices, ExpressCards, memory cards, or USB devices.
- Using high-brightness display settings, 3D screen savers, or other power-intensive programs such as complex 3D graphics applications.
- Running the computer in maximum performance mode. (You can use Windows Power Options Properties or Dell QuickSet to configure power management settings. For details, see "Configuring Power Management Settings" on page 52 or "Dell™ QuickSet" on page 155.)

You can check the battery charge before you insert the battery into the computer. You can also set power management options to alert you when the battery charge is low.

 **CAUTION: Using an incompatible battery may increase the risk of fire or explosion. Replace the battery only with a compatible battery purchased from Dell. The battery is designed to work with your Dell computer. Do not use batteries from other computers with your computer.**

 **CAUTION: Do not dispose of batteries with household waste. When your battery no longer holds a charge, call your local waste disposal or environmental agency for advice on disposing of a lithium-ion battery (see "Battery Disposal" in the *Product Information Guide*).**

 **CAUTION: Misuse of the battery may increase the risk of fire or chemical burn. Do not puncture, incinerate, disassemble, or expose the battery to temperatures above 65°C (149°F). Keep the battery away from children. Handle damaged or leaking batteries with extreme care. Damaged batteries may leak and cause personal injury or equipment damage.**

## Checking the Battery Charge

You can check the battery charge on your computer using any one of the following methods:

- Dell QuickSet Battery Meter
- Microsoft Windows battery meter icon  located in the notification area
- Battery charge/health gauge located on the battery
- Low-battery warning pop-up window

### Dell QuickSet Battery Meter

To view the Dell QuickSet Battery Meter:

- Double-click the Dell QuickSet icon in the taskbar, and then click **Battery Meter**
- or
- Press <Fn><F3>

The Battery Meter displays the status, battery health, charge level, and charge completion time for the battery in your computer.

For more information about QuickSet, right-click the QuickSet icon, and then click **Help**.

## **Microsoft® Windows® Battery Meter**

The battery meter indicates the remaining battery charge. To check the battery meter, double-click the  icon in the notification area.

### **Charge Gauge**

By either pressing once or pressing and holding the status button on the battery charge gauge, you can check:

- Battery charge (check by pressing and releasing the status button)
- Battery health (check by pressing and holding the status button)

The battery operating time is largely determined by the number of times it is charged. After hundreds of charge and discharge cycles, batteries lose some charge capacity—or battery health. Therefore, a battery can show a status of "charged," but maintain a reduced charge capacity (health).

### **Check the Battery Charge**

To check the battery charge, press and release the status button on the battery charge gauge to illuminate the charge-indicator lights. Each light represents approximately 20 percent of the total battery charge. For example, if the battery has 80 percent of its charge remaining, four of the lights are on. If no lights are on, the battery has no charge.

### **Check the Battery Health**



**NOTE:** You can check battery health in one of two ways: by using the charge gauge on the battery, as described below, and by using the Battery Meter in Dell QuickSet. For information about QuickSet, right-click the QuickSet icon in the notification area, and then click **Help**.

To check the battery health using the charge gauge, press and hold the status button on the battery charge gauge for at least 3 seconds to illuminate the health indicator lights. Each light represents incremental degradation. If no lights appear, the battery is in good condition, and more than 80 percent of its original charge capacity remains. If five lights appear, less than 60 percent of the charge capacity remains, and you should consider replacing the battery (see "Battery" on page 170 for more information about the battery operating time).

## Low-Battery Warning

- ➔ **NOTICE:** To avoid losing or corrupting data, save your work immediately after a low-battery warning, then connect the computer to an electrical outlet. If the battery runs completely out of power, Sleep state begins automatically.

A pop-up window warns you when the battery charge is approximately 90 percent depleted. The computer enters Sleep state when the battery charge is at a critically low level.

You can change the settings for the battery alarms in Dell QuickSet or the Power Options window. For more information, see "Configuring Power Management Settings" on page 52 or "Dell™ QuickSet" on page 155.



## Conserving Battery Power

To conserve battery power on your portable computer, do any of the following:

- Connect the computer to an electrical outlet when possible; battery life is largely determined by the number of times the battery is used and recharged.
- Configure the power management settings using either Dell QuickSet or Microsoft Windows Power Options to optimize your computer's power usage (see "Configuring Power Management Settings" on page 52).
- Use the Sleep power state when you leave the computer unattended for long periods of time (see "Using the Sleep Power State" on page 53).

## Configuring Power Management Settings

You can use Dell QuickSet or Windows Power Options to configure the power management settings on your computer.



- For information on how to use the Dell QuickSet Power Management wizard, right-click the QuickSet icon in the notification area, click **Help**, and then select **Power Management**.
- To use Windows Power Options, do one of the following:
  - Click **Start**  → **Control Panel** → **Hardware and Sound** → **Power Options**, and then select a power plan in the **Select a power plan** window.
  - or
  - Click the  icon in the notification area, click **Power Options**, and then select a plan in the **Select a power plan** window.

## Using the Sleep Power State

Rather than shutting down your portable computer, use the Sleep power state to conserve power. Sleep automatically saves your work to your hard drive, and then returns you to your previous work session without restarting your computer.

 **NOTICE:** If your computer loses AC and battery power while in Sleep state, it may lose data.

To enter Sleep state:

- Click **Start** , click , and then click **Sleep**.
- or
- Depending on how you set the power management options in the Windows **Power Options** or Dell **QuickSet**, use one of the following methods:
  - Press the power button.
  - Close the display.
  - Press <Fn><Esc>.

To exit Sleep state, press the power button.

## Charging the Battery

 **NOTE:** Charge time is longer with the computer turned on. You can leave the battery in the computer for as long as you like. The battery's internal circuitry prevents the battery from overcharging.

When you connect the computer to an electrical outlet or install a battery while the computer is connected to an electrical outlet, the computer checks the battery charge and temperature. If necessary, the AC adapter then charges the battery and maintains the battery charge.

If the battery is hot from being used in your computer or being in a hot environment, the battery may not charge when you connect the computer to an electrical outlet.

The battery is too hot to start charging if the battery light  flashes alternately blue and amber. Disconnect the computer from the electrical outlet and allow the computer and the battery to cool to room temperature, then connect the computer to an electrical outlet to continue charging the battery.

For more information about resolving problems with a battery, see "Power Problems" on page 110.

# Replacing the Battery

**⚠ CAUTION:** Using an incompatible battery may increase the risk of fire or explosion. Replace the battery only with a compatible battery purchased from Dell. The battery is designed to work with your Dell computer. Do not use batteries from other computers with your computer.

**⚠ CAUTION:** Before performing these procedures, turn off the computer, disconnect the AC adapter from the electrical outlet and the computer, disconnect the modem from the wall connector and the computer, and remove any other external cables from the computer.

**➡ NOTICE:** You must remove all external cables from the computer to avoid possible connector damage.

**➡ NOTICE:** If you choose to replace the battery with the computer in Sleep state, you have up to 1 minute to complete the battery replacement before the computer shuts down and loses any unsaved data.

To remove the battery:

- 1 If the computer is connected to a docking device (docked), undock it. See the documentation that came with your docking device for instructions.
- 2 Ensure that the computer is turned off.
- 3 Turn the computer over.
- 4 Slide and click the battery release latch to keep it open.
- 5 Slide the battery out of the bay.



1 battery      2 battery release latch

To replace the battery, follow the removal procedure in reverse order.

## Storing a Battery

Remove the battery when you store your computer for an extended period of time. A battery discharges during prolonged storage. After a long storage period, recharge the battery fully (see "Charging the Battery" on page 53) before you use it.





# Using Multimedia

## Playing Media

➔ **NOTICE:** Do not move the computer while playing media.

- 1 Press the eject button located above the keyboard on the center-control cover.
- 2 Slide the disc, label side up, in the drive opening.

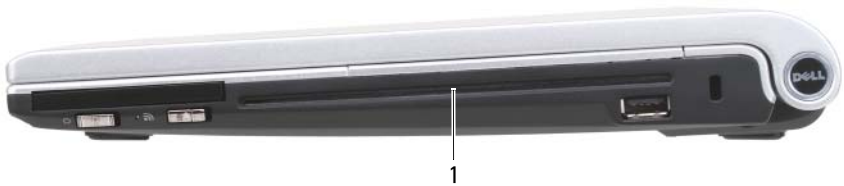









1 drive opening

To format media for storing or copying data, see the media software that came with your computer.

 **NOTE:** Ensure that you follow all copyright laws when copying media.

A CD drive includes the following basic buttons:











---

	Play
	Move backward within the current track
	Pause
	Move forward within the current track
	Stop
	Go to the previous track
	Eject
	Go to the next track

---

A DVD drive includes the following basic buttons:

---

	Stop
	Restart the current chapter
	Play
	Fast forward
	Pause
	Fast reverse
	Advance a single frame while in pause mode
	Go to the next title or chapter
	Continuously play the current title or chapter
	Go to the previous title or chapter
	Eject

---

For more information on playing media, click **Help** on the media player (if available).

## Playing Media Using Dell Travel Remote (Optional)

The Dell Travel Remote is designed to control Dell Media Direct and Windows Vista Media Center. It can work only with specified computers. For more details, refer to the Dell Support website at [support.dell.com](http://support.dell.com).

To play media using Dell Travel Remote:

- 1 Install a coin-cell battery into your remote control.
- 2 Launch Windows Vista<sup>®</sup> Media Center from **Start**  → **Programs**.
- 3 Use the remote control buttons to play media.



- |    |                      |    |              |
|----|----------------------|----|--------------|
| 1  | Infrared Transmitter | 2  | Arrow Up     |
| 3  | OK/Enter/Select      | 4  | Arrow Right  |
| 5  | Arrow Down           | 6  | Play/Pause   |
| 7  | Forward              | 8  | Skip Forward |
| 9  | Stop                 | 10 | Skip Back    |
| 11 | Reverse              | 12 | Back         |
| 13 | Arrow Left           | 14 | Mute         |
| 15 | Volume Down          | 16 | Page Down    |
| 17 | Volume Up            | 18 | Page Up      |

## Copying CDs and DVDs

This section applies only to computers that have a DVD+/-RW drive.



**NOTE:** Ensure that you observe all copyright laws when copying media.



**NOTE:** The types of optical drives offered by Dell may vary by country.

The following instructions explain how to make an exact copy of a CD or DVD. You can also use Roxio Creator for other purposes, such as creating music CDs from audio files stored on your computer or backing up important data. For help, open Roxio Creator, and then press <F1>.

The DVD drives installed in Dell computers do not support HD-DVD media. For a list of supported media formats, see "Using Blank CDs and DVDs" on page 60.

### How to Copy a CD or DVD



**NOTE:** Most commercial DVDs have copyright protection and cannot be copied using Roxio Creator.

- 1 Click **Start**  → **All Programs** → **Roxio Creator** → **Projects** → **Copy**.
- 2 Under the **Copy** tab, click **Copy Disc**.
- 3 To copy a CD or DVD:
  - *If you have one optical drive*, insert the source disc into the drive, ensure that the settings are correct, and then click the **Copy Disc** button to continue. The computer reads your source disc and copies the data to a temporary folder on your computer hard drive.  
When prompted, insert a blank disc into the drive and click **OK**.
  - *If you have two optical drives*, select the drive into which you have inserted your source disc and click the **Copy Disc** button to continue. The computer copies the data from the source disc to the blank disc.

Once you have finished copying the source disc, the disc that you have created automatically ejects.

### Using Blank CDs and DVDs

DVD-writable drives can write to both CD and DVD recording media.

Use blank CD-Rs to record music or permanently store data files. After creating a CD-R, you cannot write to that CD-R again (see the Sonic documentation for more information). Use a blank CD-RW if you plan to erase, rewrite, or update information on that disc later.

Blank DVD+/-R media can be used to permanently store large amounts of information. After you create a DVD+/-R, you may not be able to write to that disc again if the disc is finalized or closed during the final stage of the disc creation process. Use blank DVD+/-RW media if you plan to erase, rewrite, or update information on that disc later.

### CD-Writable/DVD-ROM Drives

Media Type	Read	Write	Rewritable
CD-R	Yes	Yes	No
CD-RW	Yes	Yes	Yes

### DVD-Writable Drives

Media Type	Read	Write	Rewritable
CD-R	Yes	Yes	No
CD-RW	Yes	Yes	Yes
DVD+R	Yes	Yes	No
DVD-R	Yes	Yes	No
DVD+RW	Yes	Yes	Yes
DVD-RW	Yes	Yes	Yes
DVD+R DL	Yes	Yes	No
DVD-R DL	Yes	No	No

### Helpful Tips

- Use CD-Rs to burn music CDs that you want to play in regular stereos. CD-RWs do not play in most home or car stereos.
- Music MP3 files can be played only on MP3 players or on computers that have MP3 software installed.

- Use a blank CD-RW to practice CD recording until you are familiar with CD recording techniques. If you make a mistake, you can erase the data on the CD-RW and try again. You can also use blank CD-RWs to test music file projects before you record the project permanently to a blank CD-R.
- Commercially available DVD drives used in home theater systems may not support all available DVD formats. For a list of formats supported by your DVD drive, see the documentation provided with your DVD drive or contact the manufacturer.

## Adjusting the Volume



**NOTE:** When the speakers are muted, you do not hear the media playing.

- 1 Right-click the volume icon in the notification area.
- 2 Click **Open Volume Mixer**.
- 3 Click and drag the bar to slide it up or down to increase or decrease the volume.

For more information on volume control options, click **Help** in the **Volume Mixer** window.

The Volume Meter displays the current volume level, including mute, on your computer. Either click the **QuickSet** icon in the notification area and select or deselect **Disable On Screen Volume Meter**, or press the volume control buttons to enable or disable the Volume Meter on the screen.

## Adjusting the Picture

If an error message notifies you that the current resolution and color depth are using too much memory and preventing media playback, adjust the display properties:

- 1 Click **Start**  → **Control Panel** → **Appearance and Personalization**.
- 2 Under **Personalization**, click **Adjust screen resolution**.
- 3 On **Display Settings**, click and drag the bar to reduce the resolution setting.
- 4 In the drop-down menu under **Color quality**, click **Medium (16 bit)**.
- 5 Click **OK**.

## Using Dell MediaDirect™

Dell MediaDirect is an instant-on multimedia playback mode for digital media. Press the Dell MediaDirect button, located on the hinge cover, to launch Dell MediaDirect. When your computer is turned off or in Sleep state, you can press the Dell MediaDirect button to start the computer and automatically launch the Dell MediaDirect application.



1 Dell MediaDirect button

**➡ NOTE:** You cannot reinstall Dell MediaDirect if you voluntarily reformat the hard drive. You need the installation software to reinstall Dell MediaDirect. Contact Dell for assistance (see "Contacting Dell" on page 164).

For more information on using Dell MediaDirect, use the **Help** menu in the Dell MediaDirect application.

# Connecting Your Computer to a TV Using the HDMI Connector

Your computer features a high-definition multimedia interface (HDMI) connector, which allows you to connect the computer to a high-definition TV. To use the HDMI interface, connect your computer to the HDMI TV, then enable your computer's display and audio settings to TV.



**NOTE:** The HDMI cable may not ship with your computer. The cable can be purchased from Dell.



- 1 Plug one end of the HDMI cable into the HDMI-output connector on your computer. See your *Owners Manual* for the location of the HDMI connector.
- 2 Plug the other end of the HDMI cable into the HDMI-input connector on your HDMI TV.

## Enabling the Display Settings for a TV

- 1 Click **Start** , click **Control Panel**, and then click **Appearance and Personalization**.
- 2 Under **Personalization**, click **Adjust Screen Resolution**.  
The **Display Properties** window appears.
- 3 Click **Advanced**.



- 4 Click the tab for your video card.



**NOTE:** To determine the type of video card installed in your computer, see Windows Help and Support. To access Help and Support, click **Start**  → **Help and Support**. Under **Pick a Task**, click **Use Tools to view your computer information and diagnose problems**. Then, under **My Computer Information**, select **Hardware**.

- 5 In the display devices section, select the appropriate option for using either a single display or multiple displays, ensuring that the display settings are correct for your selection.

### Enabling the Audio Settings for a TV

- 1 Click **Start** , click **Control Panel**, and then click **Sound**.
- 2 Under **Sound**, click the **Playback** tab.



**NOTE:** The default playback device is indicated with a green check mark.

- 3 If the HDMI device is not the default device, select it, click the **Set Default** button, and then click **OK**.



**CAUTION:** When you have finished using your computer with the HDMI-panel TV, repeat steps 1 and 2, and then set the default playback device back to **Speakers/Headphones**. If you leave the default playback device set to **HDMI**, your computer's speakers and headphone jack will not function.



## Using ExpressCards

ExpressCards provide additional memory, multimedia, wired and wireless communications, and security features. For example, you can add an ExpressCard to make wireless wide area network (WWAN) connectivity available on your computer.

ExpressCards support two form factors:

- ExpressCard/34 (34 mm wide)
- ExpressCard/54 (54 mm wide in an L-shape with a 34 mm connector)

The 34 mm card fits into both the 34 mm and 54 mm card slots. The 54 mm card only fits into a 54 mm card slot.

See "Specifications" on page 165 for information on supported ExpressCards.



**NOTE:** An ExpressCard is not a bootable device.

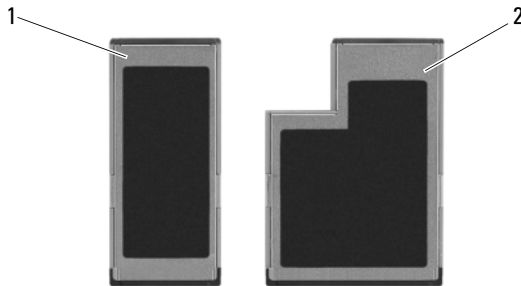

1 ExpressCard/34

2 ExpressCard/54

## ExpressCard Blanks

Your computer shipped with a plastic blank installed in the ExpressCard slot. Blanks protect unused slots from dust and other particles. Save the blank for use when no ExpressCard is installed in the slot; blanks from other computers may not fit your computer.

Remove the blank before installing an ExpressCard. To remove the blank, see "Removing an ExpressCard or Blank" on page 69.

## Installing an ExpressCard

You can install an ExpressCard while the computer is running. The computer automatically detects the card.

ExpressCards are generally marked with a symbol (such as a triangle or an arrow) or a label to indicate which end to insert into the slot. The cards are keyed to prevent incorrect insertion. If card orientation is not clear, see the documentation that came with the card.

**⚠ CAUTION:** Before you begin any of the procedures in this section, follow the safety instructions in the *Product Information Guide*.

**➡ NOTICE:** When installing or removing an express card, please do not push express card and latch simultaneously. This action will damage express card reader.

To install an ExpressCard:

- 1 Hold the card with the top side of the card facing up.
- 2 Slide the card into the slot until the card is completely seated in its connector.  
If you encounter too much resistance, do not force the card. Check the card orientation and try again.



The computer recognizes the ExpressCard and automatically loads the appropriate device driver. If the configuration program tells you to load the manufacturer's drivers, use the media that came with the ExpressCard.

## Removing an ExpressCard or Blank



**CAUTION:** Before you begin any of the procedures in this section, follow the safety instructions in the *Product Information Guide*.



**NOTICE:** When installing or removing an express card, please do not push express card and latch simultaneously. This action will damage express card reader.

Press the card or blank into the slot to release it.

Save a blank to use when no ExpressCard is installed in a slot. Blanks protect unused slots from dust and other particles.





## Using the Memory Card Reader

The memory card reader provides a fast and convenient way to view and share digital photos, music, and videos stored on a memory card.



**NOTE:** A memory card reader is not a bootable device.

The 8-in-1 memory card reader reads the following memory cards:

- Secure Digital (SD)
- SDIO
- MultiMediaCard (MMC)
- Memory Stick
- Memory Stick PRO
- xD-Picture Card
- Hi Speed-SD
- Hi Density-SD

### Memory Card Blanks

Your computer shipped with a plastic blank installed in the 8-in-1 memory card reader. Blanks protect unused slots from dust and other particles. Save the blank for use when no memory card is installed in the slot; blanks from other computers may not fit your computer.

Remove the blank before installing a memory card. To remove the blank, see "Removing a Memory Card or Blank" on page 72.

### Installing a Memory Card

You can install a memory card in the computer while the computer is running. The computer automatically detects the card.

Memory cards are generally marked with a symbol (such as a triangle or an arrow) or a label to indicate which end to insert into the slot. The cards are keyed to prevent incorrect insertion. If card orientation is not clear, see the documentation that came with the card.

**⚠ CAUTION:** Before you begin any of the procedures in this section, follow the safety instructions in the *Product Information Guide*.

To install a memory card:

- 1 Hold the card with the top side of the card facing up.
- 2 Slide the card into the slot until the card is completely seated in its connector.

**📌 NOTE:** If you encounter too much resistance, do not force the card. Check the card orientation and try again.



The computer recognizes the memory card and automatically loads the appropriate device driver. If the configuration program tells you to load the manufacturer's drivers, use the media that came with the memory card, if applicable.

## Removing a Memory Card or Blank

**⚠ CAUTION:** Before you begin any of the procedures in this section, follow the safety instructions in the *Product Information Guide*.

Press the card into the slot to release it from the memory card reader. When it is partially ejected, remove the card.



# Setting Up and Using Networks

Setting up a computer network provides connectivity between your computer and the Internet, another computer, or a network. For example, with a network set up in a home or small office you can print to a shared printer, access drives and files on another computer, browse other networks, or access the Internet. You can set up a local area network (LAN) using a network or broadband modem cable or set up a wireless LAN (WLAN).

The Microsoft® Windows Vista™ operating system provides a wizard to help guide you through the process of networking computers. For more information about networking, access Windows Help and Support (click **Start** , and then click **Help and Support**).

## Connecting a Network or Broadband Modem Cable

Before you connect your computer to a network, the computer must have a network adapter installed and a network cable connected to it.

- 1 Connect the network cable to the network adapter connector on the back of your computer.

 **NOTE:** Insert the cable connector until it clicks into place, and then gently pull on the cable to ensure that it is securely attached.

- 2 Connect the other end of the network cable to a network connection device or a network wall connector.

 **NOTE:** Do not use a network cable with a telephone wall connector.



## Setting Up a Network

- 1 Click **Start** , and then click **Connect To**.
- 2 Click **Set up a connection or network**.
- 3 Select an option under **Choose a connection option**.
- 4 Click **Next**, and then follow the instructions in the wizard.

## Wireless Local Area Network (WLAN)

A WLAN is a series of interconnected computers that communicate with each other over the air waves rather than through a network cable connected to each computer. In a WLAN, a radio communications device called an access point or wireless router connects network computers and provides Internet, or network access. The access point or wireless router and the wireless network card in the computer communicate by broadcasting data from their antennas over the air waves.

### What You Need to Establish a WLAN Connection

Before you can set up a WLAN, you need:



- High-speed (broadband) Internet access (such as cable or DSL)
- A broadband modem that is connected and working
- A wireless router or access point
- A wireless network card for each computer that you want to connect to your WLAN
- A network cable with a network (RJ-45) connector

### Checking Your Wireless Network Card

Depending on what you selected when you purchased your computer, the computer has a variety of configurations. To confirm that your computer has a wireless network card and to determine the type of card:

- Use the **Device Manager**
- Check the order confirmation for your computer

## Device Manager

- 1 Click **Start** , and then click **Control Panel**.
- 2 Click **Classic View** on the menu on the left side of the **Control Panel**.
- 3 Double-click **Device Manager**.  
 **NOTE:** The **User Account Control** window may open.
- 4 Click **Continue** on the **User Account Control** window if it opens.
- 5 Click the + next to **Network adapters** to list the utility that manages your wireless network card.

If a network adapter is not listed, you may not have a wireless network card.

If a network adapter is listed, you have a wireless network card. To view detailed information about the wireless network card:

- 1 Right-click the name of the network adapter.
- 2 Click **Properties**.

## The Order Confirmation for Your Computer

The order confirmation that you received when you ordered your computer lists the hardware and software that shipped with your computer.

## Setting Up a New WLAN Using a Wireless Router and a Broadband Modem

- 1 Contact your Internet service provider (ISP) to obtain specific information about the connection requirements for your broadband modem.
- 2 Ensure that you have wired Internet access through your broadband modem before you attempt to set up a wireless Internet connection (see "Connecting a Network or Broadband Modem Cable" on page 73).
- 3 Install any software required for your wireless router. Your wireless router may have been shipped with installation media. Installation media usually contains installation and troubleshooting information. Install the required software according to the instructions provided by the router manufacturer.
- 4 Shut down your computer and any other wireless-enabled computers in the vicinity through the Windows Vista Start button .
- 5 Disconnect your broadband modem power cable from the electrical outlet.
- 6 Disconnect the network cable from the computer and the modem.

- 7 Disconnect the AC adapter cable from your wireless router to ensure that there is no power connected to the router.



**NOTE:** Wait for a minimum of 5 minutes after disconnecting your broadband modem before continuing with the network setup.

- 8 Insert a network cable into the network (RJ-45) connector on the unpowered broadband modem.
- 9 Connect the other end of the network cable into the Internet network (RJ-45) connector on the unpowered wireless router.
- 10 Ensure that no network or USB cables, other than the network cable connecting the modem and the wireless router, are connected to the broadband modem.



**NOTE:** Restart your wireless equipment in the order described below to prevent a potential connection failure

- 11 Turn on *only* your broadband modem and wait for at least 2 minutes for the broadband modem to stabilize. After 2 minutes, proceed to step 12.
- 12 Turn on your wireless router and wait for at least 2 minutes for the wireless router to stabilize. After 2 minutes, proceed to the step 13.
- 13 Start your computer and wait until the boot process completes.
- 14 See the documentation that came with your wireless router to do the following in order to set up the wireless router:
  - Establish communication between your computer and your wireless router.
  - Configure your wireless router to communicate with your broadband router.
  - Find out your wireless router's broadcast name. The technical term for the name of your router's broadcast name is Service Set Identifier (SSID) or network name.
- 15 If necessary, configure your wireless network card to connect to the wireless network (see "Connecting to a WLAN" on page 77).

## Connecting to a WLAN



**NOTE:** Before you connect to a WLAN, ensure that you have followed the instructions in "Wireless Local Area Network (WLAN)" on page 74.



**NOTE:** The following networking instructions do not apply to internal cards with Bluetooth® wireless technology or cellular products.

This section provides general procedures for connecting to a network using wireless technology. Specific network names and configuration details vary. See "Wireless Local Area Network (WLAN)" on page 74 for more information about how to prepare for connecting your computer to a WLAN.

Your wireless network card requires specific software and drivers for connecting to a network. The software is already installed.



**NOTE:** If the software is removed or corrupted, follow the instructions in the user documentation for your wireless network card. Verify the type of wireless network card installed in your computer and then search for that name on the Dell™ Support website at [support.dell.com](http://support.dell.com). For information on the type of wireless network card that is installed in your computer, see "Checking Your Wireless Network Card" on page 74.

When you turn on your computer and a network (for which your computer is not configured) is detected in the area, a pop-up appears near the network icon in the Windows notification area.

To connect to the network:

- 1 Click **Start** , and then click **Network**.
- 2 Click **Network and Sharing** on the navigation bar at the top of the Network folder.
- 3 Click **Connect to a network** under **Tasks**.
- 4 Select your network from the list and click **Connect**.

Once you have configured your computer for a wireless network, another pop-up notifies you that your computer is connected to that network.

Thereafter, whenever you log on to your computer within the range of the wireless network that you selected, the same pop-up notifies you of the wireless network connection.



**NOTE:** If you select a secure network, you must enter a WEP or WPA key when prompted. Network security settings are unique to your network. Dell cannot provide this information.



**NOTE:** Your computer can take up to 1 minute to connect to the network.

## Monitoring the Status of the Wireless Network Card Through Dell QuickSet

The wireless activity indicator provides you with an easy way to monitor the status of your computer's wireless devices. To turn the wireless activity indicator on or off, click the QuickSet icon in the taskbar and select **Hotkey Popups**.

If **Wireless Activity Indicator Off** is not checked, the indicator is on.

If **Wireless Activity Indicator Off** is checked, the indicator is off.

The wireless activity indicator displays whether your computer's integrated wireless devices are enabled or disabled. When you turn the wireless networking function on or off, the wireless activity indicator changes to display the status.

For more information about the Dell QuickSet wireless activity indicator, right-click the QuickSet icon in the taskbar, and then select **Help**.

## Mobile Broadband (or Wireless Wide Area Network)

A Mobile Broadband network, also known as a Wireless Wide Area Network (WWAN), is a high-speed digital cellular network that provides Internet access over a much wider geographical area than a WLAN, which typically covers only from 100 to 1000 feet. Your computer can maintain Mobile Broadband network access as long as the computer is within a cellular-data coverage zone. Contact your service provider for coverage of a high-speed digital cellular network.



**NOTE:** Even if you are able to make a call from your cellular phone in a specific geographical location, that location may not necessarily be within a cellular-data coverage zone.

## What You Need to Establish a Mobile Broadband Network Connection



**NOTE:** Depending on your computer, you can use either a Mobile Broadband ExpressCard or Mini-Card, but not both, to establish a Mobile Broadband network connection.

To set up a Mobile Broadband network connection, you need:

- A Mobile Broadband ExpressCard or mini-card (depending on your computer's configuration)



**NOTE:** For instructions on using ExpressCards, see "Using ExpressCards" on page 67.

- An activated Mobile Broadband ExpressCard or activated Subscriber Identity Module (SIM) for your service provider
- The Dell Mobile Broadband Card Utility (already installed on your computer if you purchased the card when you purchased your computer, or on the media that accompanied your card if purchased separately from your computer)

If the utility is corrupted or deleted from your computer, see the Dell Mobile Broadband Card Utility user's guide in Windows Help and Support (click **Start** , and then click **Help and Support**) or on the media that accompanied your card if you purchased it separately from your computer.

## Checking Your Dell Mobile Broadband Card

Depending on what you selected when you purchased your computer, the computer has a variety of configurations. To determine your computer configuration, see one of the following:

- Your order confirmation
- Microsoft Windows Help and Support

To check your Mobile Broadband card in Windows Help and Support:

- 1 Click **Start**  → **Help and Support** → **Use Tools to view your computer information and diagnose problems.**
- 2 Under **Tools**, click **My Computer Information** → **Find information about the hardware installed on this computer.**



On the **My Computer Information - Hardware** screen, you can view the type of Mobile Broadband card installed in your computer as well as other hardware components.



**NOTE:** The Mobile Broadband card is listed under **Modems**.

## Connecting to a Mobile Broadband Network

 **NOTE:** These instructions only apply to Mobile Broadband ExpressCards or Mini-Cards. They do not apply to internal cards with wireless technology.

 **NOTE:** Before you connect to the Internet, you must activate Mobile Broadband service through your cellular service provider. For instructions and for additional information about using the Dell Mobile Broadband Card Utility, see the user's guide available through Windows Help and Support (click **Start** , and then click **Help and Support**). The user's guide is also available on the Dell Support website at [support.dell.com](http://support.dell.com) and on the media included with your Mobile Broadband card if you purchased the card separately from your computer.

Use the Dell Mobile Broadband Card Utility to establish and manage a Mobile Broadband network connection to the Internet:

- 1 Click the Dell Mobile Broadband Card Utility icon  in the Windows notification area to run the utility.

- 2 Click **Connect**.

 **NOTE:** The **Connect** button changes to the **Disconnect** button.

- 3 Follow the instructions on the screen to manage the network connection with the utility.

Or

- 1 Click **Start**  → **All Programs** → **Dell Wireless**.

- 2 Click **Dell Wireless Broadband** and follow the instructions on the screen.

## Enabling/Disabling the Dell Mobile Broadband Card

 **NOTE:** If you are unable to connect to a Mobile Broadband network, ensure that you have all the components for establishing a Mobile Broadband connection (see "What You Need to Establish a Mobile Broadband Network Connection" on page 78), and then verify that your Mobile Broadband card is enabled by verifying the setting of the wireless switch.

You can turn your Mobile Broadband card on and off using the wireless switch on your computer.

You can turn your computer's wireless devices on and off with the wireless switch on the left side of the computer (see "Left Side View" on page 24).



If the switch is in the "on" position, move the switch to the "off" position to disable the switch and the Mobile Broadband card. If the switch is in the "off" position, move the switch to the "on" position to enable the switch and the Dell Mobile Broadband card. For information about the wireless switch positions, see "Dell Wi-Fi Catcher™ Network Locator" on page 81.

To monitor the status of your wireless device, see "Monitoring the Status of the Wireless Network Card Through Dell QuickSet" on page 78.

## **Dell Wi-Fi Catcher™ Network Locator**

The wireless switch on your Dell computer uses the Dell Wi-Fi Catcher Network Locator to scan for wireless networks in your vicinity.

To scan for a wireless network, press and hold the Wi-Fi Catcher Network Locator Switch (see "Right Side View" on page 26) for a few seconds. The Wi-Fi Catcher Network Locator functions regardless of whether your computer is turned on or off, or in Sleep state, as long as the switch is configured through Dell QuickSet or the BIOS (system setup program) to control Wi-Fi network connections.

Because the Wi-Fi Catcher Network Locator is disabled and not configured for use when your computer is shipped to you, you must first use Dell QuickSet to enable and configure the switch to control WiFi network connections. For more information on the Wi-Fi Catcher Network Locator and to enable the feature through Dell QuickSet, right-click the QuickSet icon in the notification area, and then select **Help**.



# Securing Your Computer

## Security Cable Lock

 **NOTE:** Your computer does not ship with a security cable lock.

A security cable lock is a commercially available antitheft device. To use the lock, attach it to the security cable slot on your Dell™ computer. For more information, see the instructions included with the device.

 **NOTICE:** Before you buy an antitheft device, ensure that it will work with the security cable slot on your computer.



## Passwords

Passwords prevent unauthorized access to your computer. When you first start your computer, you must assign a primary password at the prompt. If you do not enter a password within 2 minutes, the computer returns to its previous operating state.

When using passwords, observe the following guidelines:

- Choose a password that you can remember, but not one that is easy to guess. For example, do not use the names of family members or pets for passwords.
- It is recommended that you do not write down your password. If you do write it down, however, ensure that the password is stored in a secure location.
- Do not share your password with other people.
- Ensure that people are not watching you when you type your password.



**NOTICE:** Passwords provide a high level of security for data in your computer or hard drive. However, they are not foolproof. If you require more security, obtain and use additional forms of protection such as data encryption programs.

Use the **User Accounts** option in the Control Panel in the Microsoft® Windows® operating system to create user accounts or to change passwords. Once you create a user password, you must enter it each time you turn on or unlock your computer. If you do not enter a password within 2 minutes, the computer returns to its previous operating state. For more information, see your Windows documentation.

If you forget any of your passwords, contact Dell (see "Contacting Dell" on page 164). For your protection, Dell technical support staff will ask you for proof of your identity to ensure that only an authorized person can use the computer.

## Fingerprint Reader (Optional)

If your computer has the optional fingerprint reader, you can use the Fingerprint Reader Suite to add biometric security to your computer. The Fingerprint Reader Suite gives you the ability to enhance your security in the following ways:

- Associate digitized images of your fingerprints with your user name, password, and generated security keys in your own secure *passport*
- Use the fingerprint reader to manage OS-level authentication
- Register applications and web pages in a password bank so that you can use the fingerprint reader to enter your password
- Launch a favorite application by swiping your finger over the fingerprint reader

Store confidential information in an encrypted folder

## If Your Computer Is Lost or Stolen

- Call a law enforcement agency to report the lost or stolen computer. Include the Service Tag in your description of the computer. Ask that a case number be assigned and write down the number, along with the name, address, and phone number of the law enforcement agency. If possible, obtain the name of the investigating officer.



**NOTE:** If you know where the computer was lost or stolen, call a law enforcement agency in that area. If you do not know, call a law enforcement agency where you live.

- If the computer belongs to a company, notify the security office of the company.
- Contact Dell customer service to report the missing computer. Provide the computer Service Tag, the case number, and the name, address, and phone number of the law enforcement agency to which you reported the missing computer. If possible, give the name of the investigating officer.

The Dell customer service representative will log your report under the computer Service Tag and record the computer as missing or stolen. If someone calls Dell for technical assistance and gives your Service Tag, the computer is identified automatically as missing or stolen. The representative will attempt to get the phone number and address of the caller. Dell will then contact the law enforcement agency to which you reported the missing computer.



# Troubleshooting

## Dell Technical Update Service

The Dell Technical Update service provides proactive e-mail notification of software and hardware updates for your computer. The service is free and can be customized for content, format, and how frequently you receive notifications.

To enroll for the Dell Technical Update service, go to [support.dell.com/technicalupdate](http://support.dell.com/technicalupdate).

## Dell Diagnostics



**CAUTION:** Before you begin any of the procedures in this section, follow the safety instructions in the *Product Information Guide*.

### When to Use the Dell Diagnostics

If you experience a problem with your computer, perform the checks in "Lockups and Software Problems" on page 105 and run the Dell Diagnostics before you contact Dell for technical assistance.

It is recommended that you print these procedures before you begin.



**NOTE:** The Dell Diagnostics only operate on Dell computers.

Enter system setup program, review your computer's configuration information, and ensure that the device you want to test displays in the system setup program and is active (see "Dell Technical Support Policy (U.S. Only)" on page 173).

Start the Dell Diagnostics from your hard drive or from your *Drivers and Utilities* media (see "Drivers and Utilities Media" on page 13).

## Starting the Dell Diagnostics From Your Hard Drive

The Dell Diagnostics is located on a hidden diagnostic utility partition on your hard drive.



**NOTE:** If your computer cannot display a screen image, contact Dell (see "Contacting Dell" on page 164).



**NOTE:** If the computer is connected to a docking device (docked), undock it. See the documentation that came with your docking device for instructions.

- 1 Ensure that the computer is connected to an electrical outlet that is known to be working properly.
- 2 Turn on (or restart) your computer.
- 3 Start the Dell Diagnostics in one of the following two ways.



**NOTE:** If you wait too long and the operating system logo appears, continue to wait until you see the Microsoft® Windows® desktop; then, shut down your computer and try again.

- When the DELL™ logo appears, press <F12> immediately. Select **Diagnostics** from the boot menu and press <Enter>.



**NOTE:** Before attempting the following option, the computer must be powered down completely.

- Press and hold the <Fn> key while powering the computer on.



**NOTE:** If you see a message stating that no diagnostics utility partition has been found, run the Dell Diagnostics from the *Drivers and Utilities* media.

The computer runs the Pre-boot System Assessment (PSA), a series of initial tests of your system board, keyboard, display, memory, hard drive, etc.

- During the assessment, answer any questions that appear.
- If a failure is detected, the computer stops and beeps. To stop the assessment and restart the computer, press <n>; to continue to the next test, press <y>; to retest the component that failed, press <r>.
- If failures are detected during the Pre-boot System Assessment, write down the error code(s) and contact Dell (see "Contacting Dell" on page 164).

If the Pre-boot System Assessment completes successfully, you receive the message **Booting Dell Diagnostic Utility Partition**. Press any key to continue.

- 4 Press any key to start the Dell Diagnostics from the diagnostics utility partition on your hard drive.



## Starting the Dell Diagnostics From the Drivers and Utilities Media

- 1 Insert your *Drivers and Utilities* media.
- 2 Shut down and restart the computer.

When the DELL logo appears, press <F12> immediately.



**NOTE:** If you wait too long and the operating system logo appears, continue to wait until you see the Microsoft® Windows® desktop; then, shut down your computer and try again.



**NOTE:** The next steps change the boot sequence for one time only. On the next start-up, the computer boots according to the devices specified in the system setup program.



**NOTE:** Keyboard failure may result when a key on the keyboard is held down for extended periods of time. To avoid possible keyboard failure, press and release the <F12> key in even intervals until the boot device menu appears.

- 3 At the boot device menu, use the up- and down-arrow keys to highlight CD/DVD/CD-RW, and then press <Enter>.



**NOTE:** The Quickboot feature changes the boot sequence for the current boot only. Upon restart, the computer boots according to the boot sequence specified in the system setup program.

- 4 Select the **Boot from CD-ROM** option from the menu that appears, and then press <Enter>.
- 5 Type 1 to start the *Drivers and Utilities* menu, and then press <Enter>.
- 6 Select **Run the 32 Bit Dell Diagnostics** from the numbered list. If multiple versions are listed, select the version appropriate for your computer.
- 7 At the Dell Diagnostics **Main Menu**, select the test you want to run.



**NOTE:** Write down any error codes and problem descriptions exactly as they appear and follow the instructions on the screen.

- 8 After all tests have completed, close the test window to return to the Dell Diagnostics **Main Menu**.
- 9 Remove your *Drivers and Utilities* media, and then close the **Main Menu** window to exit the Dell Diagnostics and restart the computer.

## Dell Diagnostics Main Menu

After the Dell Diagnostics loads and the **Main Menu** screen appears, click the button for the option you want.

 **NOTE:** It is recommended that you select **Test System** to run a complete test on your computer.

Option	Function
Test Memory	Run the stand-alone memory test
Test System	Run System Diagnostics
Exit	Exit the Diagnostics

After you have selected the **Test System** option from the main menu, the following menu appears.

 **NOTE:** It is recommended that you select **Extended Test** from the menu below to run a more thorough check of the devices in the computer.

Option	Function
Express Test	Performs a quick test of system devices. The test typically takes 10 to 20 minutes and requires no interaction on your part. Run Express Test first to increase the possibility of tracing the problem quickly.
Extended Test	Performs a thorough check of system devices. The test typically takes an hour or more and periodically requires your input to answer specific questions.
Custom Test	Tests a specific device in the system and can be used to customize the tests you want to run.
Symptom Tree	Lists a number of common symptoms and allows you to select a test based on the symptom of the problem you are having.

For any problem encountered during a test, a message appears with an error code and a description of the problem. Write down the error code and problem description exactly as it appears and follow the instructions on the screen. If you cannot resolve the problem, contact Dell (see "Contacting Dell" on page 164).

 **NOTE:** The Service Tag for your computer is located at the top of each test screen. When contacting Dell support, have your Service Tag ready.

The following tabs provide additional information for tests run from the **Custom Test** or **Symptom Tree** option:

<b>Tab</b>	<b>Function</b>
Results	Displays the results of the test and any error conditions encountered.
Errors	Displays error conditions encountered, error codes, and the problem description.
Help	Describes the test and any requirements for running the test.
Configuration	Displays your hardware configuration for the selected device. The Dell Diagnostics obtains configuration information for all devices from system setup, memory, and various internal tests, and it displays the information in the device list in the left pane of the screen. The device list may not display the names of all the components installed on your computer or all devices attached to your computer.
Parameters	Allows you to customize the test by changing the test settings.

## Dell Support Center

The Dell Support Center helps you find the service, support and system-specific information you need. For more information about Dell Support Center and available support tools, click the **Services** tab at [support.dell.com](http://support.dell.com).

Systems purchased on June 26, 2007 and later are pre-installed with **Dell Support Center**. Click on the desktop icon  and select the area of assistance you require.

For computers purchased prior to June 26, 2007, you can download Dell Support Center from the **Services** page at [support.dell.com](http://support.dell.com).

Click the Dell Support Center icon  on your computer's desktop to run the application and to access the following features:

- Self-help tools such as, Dell Support 3, Dell PC Tune-Up, Dell PC CheckUp, and Network Assistant
- DellConnect for remote, real-time, technical support
- Dell support contact information including e-mail and online chat addresses as well as telephone numbers
- Resources specific to your computer are available under **Drivers & Downloads, Upgrades and System Information**

The top of the Dell Support Center home page displays your computer's model number along with its Service Tag, Express Service code, and warranty expiration details. When permissions are given to Dell to use your Service Tag, additional details about your computer, such as available memory, disk space, installed hardware, network addresses, modem specifications, installed security software, and much more are provided. In addition, using your Service Tag, Dell can link you to the most relevant [www.dell.com](http://www.dell.com) web pages for information about your warranty, ordering accessories and details about installing recommended drivers and downloads.

### **Dell Support 3**

The Dell Support 3 is customized for your computing environment. This utility provides self-support information, software updates, and health scans for your computer. Use this utility for the following functions:

- Check your computing environment
- View the Dell Support 3 settings
- Access the Dell Support 3 help file
- View frequently asked questions
- Learn more about Dell Support 3
- Turn Dell Support 3 off

For more information about Dell Support 3, click the question mark (?) at the top of the Dell Support 3 window.

To access Dell Support 3:

- Click the Dell Support 3 icon  in the notification area of your Windows desktop.



**NOTE:** The  icon functions vary depending on whether you click, double-click, or right-click the icon.

or

- Click the Microsoft® Windows Vista® Start button  → **All Programs** → **Dell Support 3** → **Dell Support Settings**. Ensure that the **Show icon on the taskbar** option is checked.



**NOTE:** If Dell Support 3 is not available from the **Start** menu, go to [support.dell.com](http://support.dell.com) and download the software.

## Dell PC Tune-Up

The automated or monthly version of Dell PC Tune-Up allows you to choose the day and time of the month you want your computer "tuned up". A typical tune-up includes hard drive defragmentation, removal of unwanted and temporary files, updated security settings, verification of "good" restore points, and other maintenance activities designed to improve computer performance and security. The monthly version is available as an annual subscription and is a feature of Dell Support 3, a complimentary application that provides real-time health scans and information on how to maintain your computer (see "Dell Support 3" on page 92).

Both versions of PC Tune-Up are available to customers in the U.S. and Canada. For the latest updates and to learn how to keep your computer running at peak performance, search for the keyword **PC TuneUp** on [support.dell.com](http://support.dell.com).

## Dell PC CheckUp

Dell PC CheckUp is a troubleshooting and diagnostic tool that provides customized scanning and testing of your Dell computer. PC CheckUp verifies whether your hardware is working properly and provides automated fixes for common configuration concerns. It is recommended that you run PC CheckUp on a regular basis or before contacting Dell for assistance. The application creates a detailed report that Dell technicians can use to resolve your issue quickly.

## Dell Network Assistant

Designed specifically for users of Dell™ computers, the Dell Network Assistant helps simplify the setup, monitoring, troubleshooting, and repair of your network.

The Dell Network Assistant provides the following features:

- Consolidated setup, alerting, and device status
- Simplified tracking of networked devices through a visual display of network status
- Proactive troubleshooting and repair of network problems
- Tutorials, setup wizards, and frequently asked questions (FAQs) to enhance understanding of networking principles

To access Dell Network Assistant:

- 1 Click the Dell Support Center icon  on your computer's desktop.
- 2 Click **Self Help**→ **Network / Internet**→ **Network Management**.

## DellConnect

DellConnect is a simple online access tool that allows a Dell service and support associate to access your computer through an Internet connection, diagnose the problem and repair it. The associate works with your permission under your supervision, and you can work with Dell's associate during the troubleshooting session.

To use this service, you must have an Internet connection and your Dell computer must be under warranty. DellConnect is also available for a fee through "Dell On Call."

To begin a live session with a Dell associate:

- 1 Click the Dell Support Center icon  on your computer's desktop.
- 2 Click **Assistance From Dell**→ **Technical Support**→ **DellConnect**→ **Phone** and follow the instructions.

## Drive Problems

 **CAUTION: Before you begin any of the procedures in this section, follow the safety instructions in the *Product Information Guide*.**

Fill out the "Diagnostics Checklist" on page 163 as you complete these checks.

#### **ENSURE THAT MICROSOFT WINDOWS RECOGNIZES THE DRIVE —**

- Click Start  → Computer.

If the drive is not listed, perform a full scan with your antivirus software to check for and remove viruses. Viruses can sometimes prevent Windows from recognizing the drive.

#### **TEST THE DRIVE —**

- Insert another floppy disk, CD, or DVD to eliminate the possibility that the original media is defective.
- Insert a bootable floppy disk and restart the computer.

**CLEAN THE DRIVE OR DISK —** See "Cleaning Your Computer" on page 40.

#### **ENSURE THAT THE CD OR DVD MEDIA IS SNAPPED ONTO THE SPINDLE**

#### **CHECK THE CABLE CONNECTIONS**

**CHECK FOR HARDWARE INCOMPATIBILITIES —** See "Troubleshooting Software and Hardware Problems in the Windows Vista® Operating System" on page 119.

**RUN THE DELL DIAGNOSTICS —** See "Dell Diagnostics" on page 87.

### **Optical drive problems**



**NOTE:** High-speed optical drive vibration is normal and may cause noise, which does not indicate a defect in the drive or the media.



**NOTE:** Because of different regions worldwide and different disc formats, not all DVD titles work in all DVD drives.

#### **Problems writing to a CD-RW or DVD+/-RW drive**

**CLOSE OTHER PROGRAMS —** CD-RW and DVD+/-RW drives must receive a steady stream of data when writing. If the stream is interrupted, an error occurs. Try closing all programs before you write to the drive.

**TURN OFF SLEEP STATE IN WINDOWS BEFORE WRITING TO A CD/DVD —** See "Using the Sleep Power State" on page 53 for information on Sleep state.

**CHANGE THE WRITE SPEED TO A SLOWER RATE —** See the help files for your CD or DVD creation software.

## The drive makes an unfamiliar scraping or grinding sound

- Ensure that the sound is not caused by the program that is running.
- Ensure that the disc is inserted properly.

## Hard drive problems

**ALLOW THE COMPUTER TO COOL BEFORE TURNING IT ON** — A hot hard drive may prevent the operating system from starting. Try allowing the computer to return to room temperature before turning it on.

### **RUN CHECK DISK** —

- 1 Click **Start**  → **Computer**.
- 2 Right-click **Local Disk (C:)**.
- 3 Click **Properties** → **Tools** → **Check Now**.



**NOTE:** The **User Account Control** window may appear. If you are an administrator on the computer, click **Continue**; otherwise, contact your administrator to continue the desired action.

- 4 Click to check **Scan for and attempt recovery of bad sectors**, and then click **Start**.

## E-Mail, Modem, and Internet Problems



**CAUTION:** Before you begin any of the procedures in this section, follow the safety instructions in the *Product Information Guide*.



**NOTE:** The modem is an optional feature on this computer. You can purchase an external modem through Dell. Therefore, the steps in this section only apply if you have purchased an external modem.

**CHECK THE MICROSOFT WINDOWS MAIL SECURITY SETTINGS** — If you cannot open your e-mail attachments:

- 1 In **Windows Mail**, click **Tools**, click **Options**, and then click **Security**.
- 2 Click **Do not allow attachments** to remove the check mark.

### **CHECK THE TELEPHONE LINE CONNECTION**

### **CHECK THE TELEPHONE JACK**

### **CONNECT THE MODEM DIRECTLY TO THE TELEPHONE WALL JACK**



### USE A DIFFERENT TELEPHONE LINE

- Verify that the telephone line is connected to the jack on the modem (the jack has either a green label or a connector-shaped icon next to it).
- Ensure that you hear a click when you insert the telephone line connector into the modem.
- Disconnect the telephone line from the modem and connect it to a telephone, then listen for a dial tone.
- If you have other telephone devices sharing the line, such as an answering machine, fax machine, surge protector, or line splitter, then bypass them and connect the modem directly to the telephone wall jack. If you are using a line that is 3 m (10 ft) or more in length, try a shorter one.

**RUN THE MODEM HELPER DIAGNOSTICS** — Click the **Start**  → **Programs** → **Modem Diagnostic Tool** → **Modem Diagnostic Tool**. Follow the instructions on the screen to identify and resolve modem problems (Modem Helper is not available on certain computers).

### VERIFY THAT THE MODEM IS COMMUNICATING WITH WINDOWS —

- 1 Click the **Start** , and then click **Control Panel**.
- 2 Click **Hardware and Sound**.
- 3 Click **Phone and Modem Options**.
- 4 Click the **Modems** tab.
- 5 Click the COM port for your modem.
- 6 Click **Properties**, click the **Diagnostics** tab, and then click **Query Modem** to verify that the modem is communicating with Windows.

If all commands receive responses, the modem is operating properly.

**ENSURE THAT YOU ARE CONNECTED TO THE INTERNET** — Ensure that you have subscribed to an Internet service provider. With the Windows Mail e-mail program open, click **File**. If **Work Offline** has a checkmark next to it, click the checkmark to remove it, and then connect to the Internet. For help, contact your Internet service provider.

**SCAN THE COMPUTER FOR SPYWARE** — If you are experiencing slow computer performance, you frequently receive pop-up advertisements, or you are having problems connecting to the Internet, your computer might be infected with spyware. Use an anti-virus program that includes anti-spyware protection (your program may require an upgrade) to scan the computer and remove spyware. For more information, go to [support.dell.com](http://support.dell.com) and search for the keyword *spyware*.

## Error Messages

Fill out the "Diagnostics Checklist" on page 163 as you complete these checks.

 **CAUTION:** Before you begin any of the procedures in this section, follow the safety instructions in the *Product Information Guide*.

If the message is not listed, see the documentation for the operating system or the program that was running when the message appeared.

**AUXILIARY DEVICE FAILURE** — The touch pad or external mouse may be faulty. For an external mouse, check the cable connection. Enable the **Pointing Device** option in the system setup program (see "Dell Technical Support Policy (U.S. Only)" on page 173). If the problem persists, contact Dell (see "Contacting Dell" on page 164).

**BAD COMMAND OR FILE NAME** — Ensure that you have spelled the command correctly, put spaces in the proper place, and used the correct pathname.

**CACHE DISABLED DUE TO FAILURE** — The primary cache internal to the microprocessor has failed. Contact Dell (see "Contacting Dell" on page 164).

**CD DRIVE CONTROLLER FAILURE** — The CD drive does not respond to commands from the computer (see "Drive Problems" on page 94).

**DATA ERROR** — The hard drive cannot read the data (see "Drive Problems" on page 94).

**DECREASING AVAILABLE MEMORY** — One or more memory modules may be faulty or improperly seated. Reinstall the memory modules and, if necessary, replace them (see "Memory" on page 137).

**DISK C: FAILED INITIALIZATION** — The hard drive failed initialization. Run the hard drive tests in the Dell Diagnostics (see "Dell Diagnostics" on page 87).

**DRIVE NOT READY** — The operation requires a hard drive in the bay before it can continue. Install a hard drive in the hard drive bay (see "Hard Drive" on page 129).

**ERROR READING PCMCIA CARD** — The computer cannot identify the ExpressCard. Reinsert the card or try another card (see "Using ExpressCards" on page 67).

**EXTENDED MEMORY SIZE HAS CHANGED** — The amount of memory recorded in NVRAM does not match the memory installed in the computer. Restart the computer. If the error appears again, contact Dell (see "Contacting Dell" on page 164).

**THE FILE BEING COPIED IS TOO LARGE FOR THE DESTINATION DRIVE** — The file that you are trying to copy is too large to fit on the disk, or the disk is full. Try copying the file to a different disk or use a larger capacity disk.

**A FILENAME CANNOT CONTAIN ANY OF THE FOLLOWING CHARACTERS: \ / : \* ? " < > | —** Do not use these characters in filenames.

**GATE A20 FAILURE** — A memory module may be loose. Reinstall the memory modules and, if necessary, replace them (see "Memory" on page 137).

**GENERAL FAILURE** — The operating system is unable to carry out the command. The message is usually followed by specific information—for example, `Printer out of paper`. Take the appropriate action.

**HARD-DISK DRIVE CONFIGURATION ERROR** — The computer cannot identify the drive type. Shut down the computer, remove the hard drive (see "Hard Drive" on page 129), and boot the computer from a CD. Then, shut down the computer, reinstall the hard drive, and restart the computer. Run the Hard Disk Drive tests in the Dell Diagnostics (see "Dell Diagnostics" on page 87).

**HARD-DISK DRIVE CONTROLLER FAILURE 0** — The hard drive does not respond to commands from the computer. Shut down the computer, remove the hard drive (see "Hard Drive" on page 129), and boot the computer from a CD. Then, shut down the computer, reinstall the hard drive, and restart the computer. If the problem persists, try another drive. Run the Hard Disk Drive tests in the Dell Diagnostics (see "Dell Diagnostics" on page 87).

**HARD-DISK DRIVE FAILURE** — The hard drive does not respond to commands from the computer. Shut down the computer, remove the hard drive (see "Hard Drive" on page 129), and boot the computer from a CD. Then, shut down the computer, reinstall the hard drive, and restart the computer. If the problem persists, try another drive. Run the Hard Disk Drive tests in the Dell Diagnostics (see "Dell Diagnostics" on page 87).

**HARD-DISK DRIVE READ FAILURE** — The hard drive may be defective. Shut down the computer, remove the hard drive (see "Hard Drive" on page 129), and boot the computer from a CD. Then, shut down the computer, reinstall the hard drive, and restart the computer. If the problem persists, try another drive. Run the Hard-Disk Drive tests in the Dell Diagnostics (see "Dell Diagnostics" on page 87).

**INSERT BOOTABLE MEDIA** — The operating system is trying to boot to nonbootable media, such as a floppy disk or CD. Insert bootable media.

**INVALID CONFIGURATION INFORMATION-PLEASE RUN SYSTEM SETUP**

**PROGRAM** — The system configuration information does not match the hardware configuration. The message is most likely to occur after a memory module is installed. Correct the appropriate options in the system setup program (see "Dell Technical Support Policy (U.S. Only)" on page 173).

**KEYBOARD CLOCK LINE FAILURE** — For external keyboards, check the cable connection. Run the Keyboard Controller test in the Dell Diagnostics (see "Dell Diagnostics" on page 87).

**KEYBOARD CONTROLLER FAILURE** — For external keyboards, check the cable connection. Restart the computer, and avoid touching the keyboard or the mouse during the boot routine. Run the Keyboard Controller test in the Dell Diagnostics (see "Dell Diagnostics" on page 87).

**KEYBOARD DATA LINE FAILURE** — For external keyboards, check the cable connection. Run the Keyboard Controller test in the Dell Diagnostics (see "Dell Diagnostics" on page 87).

**KEYBOARD STUCK KEY FAILURE** — For external keyboards or keypads, check the cable connection. Restart the computer, and avoid touching the keyboard or keys during the boot routine. Run the Stuck Key test in the Dell Diagnostics (see "Dell Diagnostics" on page 87).

**LICENSED CONTENT IS NOT ACCESSIBLE IN MEDIADIRECT** — Dell MediaDirect™ cannot verify the Digital Rights Management (DRM) restrictions on the file, so the file cannot be played (see "Dell MediaDirect problems" on page 106).

**MEMORY ADDRESS LINE FAILURE AT ADDRESS, READ VALUE EXPECTING VALUE** — A memory module may be faulty or improperly seated. Reinstall the memory modules and, if necessary, replace them (see "Memory" on page 137).

**MEMORY ALLOCATION ERROR** — The software you are attempting to run is conflicting with the operating system, another program, or a utility. Shut down the computer, wait 30 seconds, and then restart it. Try to run the program again. If the error message still appears, see the software documentation.

**MEMORY DATA LINE FAILURE AT ADDRESS, READ VALUE EXPECTING VALUE** — A memory module may be faulty or improperly seated. Reinstall the memory modules and, if necessary, replace them (see "Memory" on page 137).

**MEMORY DOUBLE WORD LOGIC FAILURE AT ADDRESS, READ VALUE EXPECTING VALUE** — A memory module may be faulty or improperly seated. Reinstall the memory modules and, if necessary, replace them (see "Memory" on page 137).

**MEMORY ODD/EVEN LOGIC FAILURE AT ADDRESS, READ VALUE EXPECTING**

**VALUE** — A memory module may be faulty or improperly seated. Reinstall the memory modules and, if necessary, replace them (see "Memory" on page 137).

**MEMORY WRITE/READ FAILURE AT ADDRESS, READ VALUE EXPECTING VALUE** — A memory module may be faulty or improperly seated. Reinstall the memory modules and, if necessary, replace them (see "Memory" on page 137).

**NO BOOT DEVICE AVAILABLE** — The computer cannot find the hard drive. If the hard drive is your boot device, ensure that the drive is installed, properly seated, and partitioned as a boot device.

**NO BOOT SECTOR ON HARD DRIVE** — The operating system may be corrupted. Contact Dell (see "Contacting Dell" on page 164).

**NO TIMER TICK INTERRUPT** — A chip on the system board may be malfunctioning. Run the System Set tests in the Dell Diagnostics (see "Dell Diagnostics" on page 87).

**NOT ENOUGH MEMORY OR RESOURCES. EXIT SOME PROGRAMS AND TRY AGAIN** — You have too many programs open. Close all windows and open the program that you want to use.

**OPERATING SYSTEM NOT FOUND** — Reinstall the hard drive (see "Hard Drive" on page 129). If the problem persists, contact Dell (see "Contacting Dell" on page 164).

**OPTIONAL ROM BAD CHECKSUM** — The optional ROM has failed. Contact Dell (see "Contacting Dell" on page 164).

**A REQUIRED .DLL FILE WAS NOT FOUND** — The program that you are trying to open is missing an essential file. Remove and then reinstall the program.

- 1 Click **Start**  → **Control Panel**.
- 2 Under **Programs**, click **Uninstall a Program**.
- 3 Select the program you want to remove.
- 4 Click **Uninstall** and follow the prompts on the screen.
- 5 See the program documentation for installation instructions.

**SECTOR NOT FOUND** — The operating system cannot locate a sector on the hard drive. You may have a defective sector or corrupted FAT on the hard drive. Run the Windows error-checking utility to check the file structure on the hard drive. See Windows Help and Support for instructions (click **Start**  → **Help and Support**). If a large number of sectors are defective, back up the data (if possible), and then reformat the hard drive.

**SEEK ERROR** — The operating system cannot find a specific track on the hard drive.

**SHUTDOWN FAILURE** — A chip on the system board may be malfunctioning. Run the System Set tests in the Dell Diagnostics (see "Dell Diagnostics" on page 87).

**TIME-OF-DAY CLOCK LOST POWER** — System configuration settings are corrupted. Connect your computer to an electrical outlet to charge the battery. If the problem persists, try to restore the data by entering the system setup program, then immediately exit the program (see "Dell Technical Support Policy (U.S. Only)" on page 173). If the message reappears, contact Dell (see "Contacting Dell" on page 164).

**TIME-OF-DAY CLOCK STOPPED** — The reserve battery that supports the system configuration settings may require recharging. Connect your computer to an electrical outlet to charge the battery. If the problem persists, contact Dell (see "Contacting Dell" on page 164).

**TIME-OF-DAY NOT SET-PLEASE RUN THE SYSTEM SETUP PROGRAM** — The time or date stored in the system setup program does not match the system clock. Correct the settings for the **Date** and **Time** options (see "Dell Technical Support Policy (U.S. Only)" on page 173).

**TIMER CHIP COUNTER 2 FAILED** — A chip on the system board may be malfunctioning. Run the System Set tests in the Dell Diagnostics (see "Dell Diagnostics" on page 87).

**UNEXPECTED INTERRUPT IN PROTECTED MODE** — The keyboard controller may be malfunctioning, or a memory module may be loose. Run the System Memory tests and the Keyboard Controller test in the Dell Diagnostics (see "Dell Diagnostics" on page 87).

**X:\ IS NOT ACCESSIBLE. THE DEVICE IS NOT READY** — Insert a disk into the drive and try again.

**WARNING: BATTERY IS CRITICALLY LOW** — The battery is running out of charge. Replace the battery, or connect the computer to an electrical outlet; otherwise, activate hibernate mode or shut down the computer.

## ExpressCard Problems

 **CAUTION:** Before you begin any of the procedures in this section, follow the safety instructions in the *Product Information Guide*.

**CHECK THE EXPRESSCARD** — Ensure that the ExpressCard is properly inserted into the connector.

**CHECK THAT THE CARD IS RECOGNIZED BY WINDOWS** — Double-click the **Safely Remove Hardware** icon in the Windows taskbar. Some cards do not support this feature. If the card supports this Windows feature, the card will be listed.

**IF YOU HAVE PROBLEMS WITH A DELL-PROVIDED EXPRESSCARD** — Contact Dell (see "Contacting Dell" on page 164). Also, for Mobile Broadband (WWAN) ExpressCards, see "Mobile Broadband (Wireless Wide Area Network [WWAN])" on page 109.

**IF YOU HAVE PROBLEMS WITH AN EXPRESSCARD NOT PROVIDED BY DELL** — Contact the ExpressCard manufacturer.

## IEEE 1394 Device Problems

 **CAUTION:** Before you begin any of the procedures in this section, follow the safety instructions in the *Product Information Guide*.

**ENSURE THAT THE IEEE 1394 DEVICE IS RECOGNIZED BY WINDOWS** —

- 1 Click Start  → Control Panel → System and Maintenance → Device Manager.

 **NOTE:** The User Account Control window may appear. If you are an administrator on the computer, click **Continue**; otherwise, contact your administrator to continue the desired action.

If your IEEE 1394 device is listed, Windows recognizes the device.

**IF YOU HAVE PROBLEMS WITH A DELL-PROVIDED IEEE 1394 DEVICE** — Contact Dell or the IEEE 1394 device manufacturer (see "Contacting Dell" on page 164).

**IF YOU HAVE PROBLEMS WITH AN IEEE 1394 DEVICE NOT PROVIDED BY DELL** — Contact Dell or the IEEE 1394 device manufacturer (see "Contacting Dell" on page 164).

Ensure that the IEEE 1394 device is properly inserted into the connector.

# Keyboard Problems

 **CAUTION:** Before you begin any of the procedures in this section, follow the safety instructions in the *Product Information Guide*.

Fill out the "Diagnostics Checklist" on page 163 as you perform the various checks.

 **NOTE:** Use the integrated keyboard when running the Dell Diagnostics or the system setup program. When you attach an external keyboard, the integrated keyboard remains fully functional.

## External Keyboard problems

 **NOTE:** When you attach an external keyboard, the integrated keyboard remains fully functional.

**CHECK THE KEYBOARD CABLE** — Shut down the computer, disconnect the keyboard cable and check it for damage, and then firmly reconnect the cable.

If you are using a keyboard extension cable, disconnect it and connect the keyboard directly to the computer.

### **CHECK THE EXTERNAL KEYBOARD** —

- 1 Shut down the computer, wait 1 minute, and then turn it on again.
- 2 Verify that the numbers, capitals, and scroll lock lights on the keyboard blink during the boot routine.
- 3 From the Windows desktop, click **Start**  → **All Programs** → **Accessories** → **Notepad**.
- 4 Type some characters on the external keyboard and verify that they appear on the display.

If you cannot verify these steps, you may have a defective external keyboard.

### **TO VERIFY THAT THE PROBLEM IS WITH THE EXTERNAL KEYBOARD, CHECK THE INTEGRATED KEYBOARD** —

- 1 Shut down the computer.
- 2 Disconnect the external keyboard.
- 3 Turn on the computer.



- 4 From the Windows desktop, click **Start**  → **All Programs** → **Accessories** → **Notepad**.
- 5 Type some characters on the internal keyboard and verify that they appear on the display.

If the characters appear now, but did not with the external keyboard, you may have a defective external keyboard. Contact Dell (see "Contacting Dell" on page 164).

**RUN THE KEYBOARD DIAGNOSTICS TESTS** — Run the PC-AT Compatible Keyboards tests in the Dell Diagnostics (see "Dell Diagnostics" on page 87). If the tests indicate a defective external keyboard, contact Dell (see "Contacting Dell" on page 164).

### Unexpected characters

**DISABLE THE NUMERIC KEYPAD** — Press <Num Lk> to disable the numeric keypad if numbers are displayed instead of letters. Verify that the numbers lock light is not lit.

## Lockups and Software Problems



**CAUTION:** Before you begin any of the procedures in this section, follow the safety instructions in the *Product Information Guide*.

### The computer does not start

**CHECK THE AC ADAPTER** — Ensure that the AC adapter is firmly connected to the computer and to the electrical outlet.

### The computer stops responding



**NOTICE:** You might lose data if you are unable to perform an operating system shutdown.

**TURN THE COMPUTER OFF** — If you are unable to get a response by pressing a key on your keyboard or moving your mouse, press and hold the power button for at least 8 to 10 seconds until the computer turns off, then restart your computer.

## A program stops responding or crashes repeatedly

### END THE PROGRAM —

- 1 Press <Ctrl><Shift><Esc> simultaneously.
- 2 Click the **Applications** tab and select the program that is no longer responding.
- 3 Click **End Task**.



**NOTE:** The `chkdsk` program may run when you restart the computer. Follow the instructions on the screen.

**CHECK THE SOFTWARE DOCUMENTATION** — If necessary, uninstall and then reinstall the program. Software usually includes installation instructions in its documentation or on a CD or DVD.

## A program is designed for an earlier Microsoft Windows operating system

**RUN THE PROGRAM COMPATIBILITY WIZARD** — Program compatibility is a mode in Windows that lets you run programs written for earlier versions of Windows. For more information, search for the keyword *program compatibility wizard* in Windows Help and Support.

## A solid blue screen appears

**TURN THE COMPUTER OFF** — If you are unable to get a response by pressing a key on your keyboard or moving your mouse, press and hold the power button for at least 8 to 10 seconds until the computer turns off, then restart your computer.

## Dell MediaDirect problems

**CHECK THE DELL MEDIADIRECT HELP FILE FOR INFORMATION** — Use the **Help** menu to access Dell MediaDirect Help.

**TO PLAY MOVIES WITH DELL MEDIADIRECT, YOU MUST HAVE A DVD DRIVE AND THE DELL DVD PLAYER** — If you purchased a DVD drive with your computer, this software should already be installed.

**VIDEO QUALITY PROBLEMS** — Turn off the **Use Hardware Acceleration** option. This feature takes advantage of the special processing in some graphics cards to reduce processor requirements when playing DVDs and certain types of video files.

**CANNOT PLAY SOME MEDIA FILES** — Because Dell MediaDirect provides access to media files outside the Windows operating system environment, access to licensed content is restricted. Licensed content is digital content that has Digital Rights Management (DRM) applied to it. The Dell MediaDirect environment cannot verify the DRM restrictions, so the licensed files cannot be played. Licensed music and video files have a lock icon next to them. You can access licensed files in the Windows operating system environment.

**ADJUSTING THE COLOR SETTINGS FOR MOVIES THAT CONTAIN SCENES THAT ARE TOO DARK OR TOO BRIGHT** — Click **EagleVision** to use a video enhancement technology that detects video content and dynamically adjusts the brightness/contrast/saturation ratios.



**NOTICE:** You cannot reinstall the Dell MediaDirect feature if you voluntarily reformat the hard drive. Contact Dell for assistance (see "Contacting Dell" on page 164).

## Other software problems

### **CHECK THE SOFTWARE DOCUMENTATION OR CONTACT THE SOFTWARE MANUFACTURER FOR TROUBLESHOOTING INFORMATION** —

- Ensure that the program is compatible with the operating system installed on your computer.
- Ensure that your computer meets the minimum hardware requirements needed to run the software. See the software documentation for information.
- Ensure that the program is installed and configured properly.
- Verify that the device drivers do not conflict with the program.
- If necessary, uninstall and then reinstall the program.

### **BACK UP YOUR FILES IMMEDIATELY**

### **USE A VIRUS-SCANNING PROGRAM TO CHECK THE HARD DRIVE, FLOPPY DISKS, OR CDS**

### **SAVE AND CLOSE ANY OPEN FILES OR PROGRAMS AND SHUT DOWN YOUR COMPUTER THROUGH THE START MENU**

**SCAN THE COMPUTER FOR SPYWARE** — If you are experiencing slow computer performance, you frequently receive pop-up advertisements, or you are having problems connecting to the Internet, your computer might be infected with spyware. Use an anti-virus program that includes anti-spyware protection (your program may require an upgrade) to scan the computer and remove spyware. For more information, go to [support.dell.com](http://support.dell.com) and search for the keyword *spyware*.

**RUN THE DELL DIAGNOSTICS** — If all tests run successfully, the error condition is related to a software problem (see "Dell Diagnostics" on page 87).

## Memory Problems

Fill out the "Diagnostics Checklist" on page 163 as you complete these checks.

 **CAUTION:** Before you begin any of the procedures in this section, follow the safety instructions in the *Product Information Guide*.

### IF YOU RECEIVE AN INSUFFICIENT MEMORY MESSAGE —

- Save and close any open files and exit any open programs you are not using to see if that resolves the problem.
- See the software documentation for minimum memory requirements. If necessary, install additional memory (see "Memory" on page 137).
- Reseat the memory modules to ensure that your computer is successfully communicating with the memory (see "Memory" on page 137).
- Run the Dell Diagnostics (see "Dell Diagnostics" on page 87).

### IF YOU EXPERIENCE OTHER MEMORY PROBLEMS —

- Reseat the memory modules to ensure that your computer is successfully communicating with the memory (see "Memory" on page 137).
- Ensure that you are following the memory installation guidelines (see "Memory" on page 137).
- Run the Dell Diagnostics (see "Dell Diagnostics" on page 87).

## Network Problems

Fill out the "Diagnostics Checklist" on page 163 as you complete these checks.

 **CAUTION:** Before you begin any of the procedures in this section, follow the safety instructions in the *Product Information Guide*.

**CHECK THE NETWORK CABLE CONNECTOR** — Ensure that the network cable is firmly inserted into both the network connector on the back of the computer and the network jack.

**CHECK THE NETWORK LIGHTS ON THE NETWORK CONNECTOR** — No light indicates that no network communication exists. Replace the network cable.

## RESTART THE COMPUTER AND LOG ON TO THE NETWORK AGAIN

**CHECK YOUR NETWORK SETTINGS** — Contact your network administrator or the person who set up your network to verify that your network settings are correct and that the network is functioning.



## Mobile Broadband (Wireless Wide Area Network [WWAN])



**NOTE:** The Dell Mobile Broadband Card Utility user's guide and the Mobile Broadband ExpressCard user's guide are available through Windows Help and Support (click **Start**  → **Help and Support**). You can also download the Dell Mobile Broadband Card Utility user's guide from [support.dell.com](http://support.dell.com).



**NOTE:** The  icon appears in the notification area if the computer has a Dell WWAN device installed. Double-click the icon to launch the utility.

**ACTIVATE THE MOBILE BROADBAND EXPRESSCARD** — You must activate the Mobile Broadband ExpressCard before you can connect to the network. Position the mouse over the  icon in the notification area to verify the status of the connection. If the card is not activated, follow the card activation instructions located within the Dell Mobile Broadband Card Utility. To access the utility, double-click the  icon located in the taskbar, at the lower-right corner of your screen. If your ExpressCard is not a Dell-branded card, see the manufacturer's instructions for your card.

**CHECK NETWORK CONNECTION STATUS IN THE DELL MOBILE BROADBAND CARD UTILITY** — Double-click the  icon to launch the Dell Mobile Broadband Card Utility. Check the status in the main window:

- **No card detected** — Restart the computer, and launch the Dell Mobile Broadband Card Utility again.
- **Check your WWAN service** — Contact your cellular service provider to verify your plan coverage and supported services.

# Power Problems

Fill out the "Diagnostics Checklist" on page 163 as you complete these checks.

 **CAUTION:** Before you begin any of the procedures in this section, follow the safety instructions in the *Product Information Guide*.

**CHECK THE POWER LIGHT** — When the power light is lit or blinking, the computer has power. If the power light is blinking, the computer is in Sleep state—press the power button to exit Sleep state. If the light is off, press the power button to turn on the computer.

 **NOTE:** For information on Sleep power state, see "Using the Sleep Power State" on page 53.

**CHARGE THE BATTERY** — The battery charge may be depleted.

- 1 Reinstall the battery.
- 2 Use the AC adapter to connect the computer to an electrical outlet.
- 3 Turn on the computer.

 **NOTE:** Battery operating time (the time the battery can hold a charge) decreases over time. Depending on how often the battery is used and the conditions under which it is used, you may need to purchase a new battery during the life of your computer.

**CHECK THE BATTERY STATUS LIGHT** — If the battery status light flashes amber or is a steady amber, the battery charge is low or depleted. Connect the computer to an electrical outlet.

If the battery status light flashes blue and amber, the battery is too hot to charge. Shut down the computer, disconnect the computer from the electrical outlet, and then let the battery and computer cool to room temperature.

If the battery status light rapidly flashes amber, the battery may be defective. Contact Dell (see "Contacting Dell" on page 164).

**CHECK THE BATTERY TEMPERATURE** — If the battery temperature is below 0°C (32°F), the computer will not start.

**TEST THE ELECTRICAL OUTLET** — Ensure that the electrical outlet is working by testing it with another device, such as a lamp.

**CHECK THE AC ADAPTER** — Check the AC adapter cable connections. If the AC adapter has a light, ensure that the light is on.

**CONNECT THE COMPUTER DIRECTLY TO AN ELECTRICAL OUTLET** — Bypass power protection devices, power strips, and extension cables to verify that the computer turns on.

**ELIMINATE POSSIBLE INTERFERENCE** — Turn off nearby fans, fluorescent lights, halogen lamps, or other appliances.

**ADJUST THE POWER PROPERTIES** — See "Configuring Power Management Settings" on page 52.

**RESEAT THE MEMORY MODULES** — If the computer power light turns on, but the display remains blank, reinstall the memory modules (see "Memory" on page 137).

## Printer Problems

Fill out the "Diagnostics Checklist" on page 163 as you complete these checks.

 **CAUTION:** Before you begin any of the procedures in this section, follow the safety instructions in the *Product Information Guide*.



**NOTE:** If you need technical assistance for your printer, contact the printer's manufacturer.

**CHECK THE PRINTER DOCUMENTATION** — See the printer documentation for setup and troubleshooting information.

**ENSURE THAT THE PRINTER IS TURNED ON**

**CHECK THE PRINTER CABLE CONNECTIONS** —

- See the printer documentation for cable connection information.
- Ensure that the printer cables are securely connected to the printer and the computer.

**TEST THE ELECTRICAL OUTLET** — Ensure that the electrical outlet is working by testing it with another device, such as a lamp.

**VERIFY THAT THE PRINTER IS RECOGNIZED BY WINDOWS** —

- 1 Click Start  → Control Panel → Hardware and Sound → Printers.
- 2 Right-click the printer icon.
- 3 Click **Properties**, and then click the **Ports** tab. For a parallel printer, ensure that the **Print to the following port(s):** setting is **LPT1 (Printer Port)**. For a USB printer, ensure that the **Print to the following port(s):** setting is **USB**.

**REINSTALL THE PRINTER DRIVER** — See the printer documentation for instructions.

## Scanner Problems

 **CAUTION:** Before you begin any of the procedures in this section, follow the safety instructions in the *Product Information Guide*.

 **NOTE:** If you need technical assistance for your scanner, contact the scanner's manufacturer.

**CHECK THE SCANNER DOCUMENTATION** — See the scanner documentation for setup and troubleshooting information.

**UNLOCK THE SCANNER** — Ensure that your scanner is unlocked.

**RESTART THE COMPUTER AND TRY THE SCANNER AGAIN**

**CHECK THE CABLE CONNECTIONS** —

- See the scanner documentation for cable connection information.
- Ensure that the scanner cables are securely connected to the scanner and the computer.

**VERIFY THAT THE SCANNER IS RECOGNIZED BY MICROSOFT WINDOWS** —

Click Start  → Control Panel → Hardware and Sound → Scanners and Cameras. If your scanner is listed, Windows recognizes the scanner.

**REINSTALL THE SCANNER DRIVER** — See the scanner documentation for instructions.

## Sound and Speaker Problems

Fill out the "Diagnostics Checklist" on page 163 as you complete these checks.

 **CAUTION:** Before you begin any of the procedures in this section, follow the safety instructions in the *Product Information Guide*.

### No sound from integrated speakers

**ADJUST THE WINDOWS VOLUME CONTROL** — Double-click the speaker icon in the lower-right corner of your screen. Ensure that the volume is turned up and that the sound is not muted. Adjust the volume, bass, or treble controls to eliminate distortion.

**ADJUST THE VOLUME USING KEYBOARD SHORTCUTS** — Press <Fn><End> to disable (mute) or re-enable the integrated speakers.

**REINSTALL THE SOUND (AUDIO) DRIVER** — See "Reinstalling Drivers and Utilities" on page 117.



## No sound from external speakers

**ENSURE THAT THE SUBWOOFER AND THE SPEAKERS ARE TURNED ON** — See the setup diagram supplied with the speakers. If your speakers have volume controls, adjust the volume, bass, or treble to eliminate distortion.

**ADJUST THE WINDOWS VOLUME CONTROL** — Click or double-click the speaker icon in the lower-right corner of your screen. Ensure that the volume is turned up and that the sound is not muted.

**DISCONNECT HEADPHONES FROM THE HEADPHONE CONNECTOR** — Sound from the speakers is automatically disabled when headphones are connected to the headphone connector.

**TEST THE ELECTRICAL OUTLET** — Ensure that the electrical outlet is working by testing it with another device, such as a lamp.

**ELIMINATE POSSIBLE INTERFERENCE** — Turn off nearby fans, fluorescent lights, or halogen lamps to check for interference.

**REINSTALL THE AUDIO DRIVER** — See "Reinstalling Drivers and Utilities" on page 117.

**RUN THE DELL DIAGNOSTICS** — See "Dell Diagnostics" on page 87.



**NOTE:** The volume control in some MP3 players overrides the Windows volume setting. If you have been listening to MP3 songs, ensure that you did not turn the player volume down or off.

## No sound from headphones

**CHECK THE HEADPHONE CABLE CONNECTION** — Ensure that the headphone cable is securely inserted into the headphone connector (see "microphone and audio connectors" on page 22).

**ADJUST THE WINDOWS VOLUME CONTROL** — Click or double-click the speaker icon in the lower-right corner of your screen. Ensure that the volume is turned up and that the sound is not muted.

## Touch Pad or Mouse Problems

**CHECK THE TOUCH PAD SETTINGS** —

- 1 Click Start  → Control Panel → Hardware and Sound → Mouse.
- 2 Adjust the settings, as needed.

**CHECK THE MOUSE CABLE** — Shut down the computer, disconnect the mouse cable and check it for damage, then firmly reconnect the cable.

If you are using a mouse extension cable, disconnect it and connect the mouse directly to the computer.

**TO VERIFY THAT THE PROBLEM IS WITH THE MOUSE, CHECK THE TOUCH PAD** —

- 1 Shut down the computer.
- 2 Disconnect the mouse.
- 3 Turn on the computer.
- 4 At the Windows desktop, use the touch pad to move the cursor around, select an icon, and open it.

If the touch pad operates correctly, the mouse may be defective.

**CHECK THE SYSTEM SETUP PROGRAM SETTINGS** — Verify that the system setup program lists the correct device for the pointing device option (the computer automatically recognizes a USB mouse without making any setting adjustments).

**TEST THE MOUSE CONTROLLER** — To test the mouse controller (which affects pointer movement) and the operation of the touch pad or mouse buttons, run the Mouse test in the **Pointing Devices** test group in the "Dell Diagnostics" on page 87.

**REINSTALL THE TOUCH PAD DRIVER** — See "Reinstalling Drivers and Utilities" on page 117.

## Video and Display Problems

Fill out the "Diagnostics Checklist" on page 163 as you complete these checks.



**CAUTION:** Before you begin any of the procedures in this section, follow the safety instructions in the *Product Information Guide*.

### If the display is blank



**NOTE:** If you are using a program that requires a higher resolution than your computer supports, it is recommended that you attach an external monitor to your computer.

**CHECK THE BATTERY** — If you are using a battery to power your computer, the battery charge may be depleted. Connect the computer to an electrical outlet using the AC adapter, and then turn on the computer.

**TEST THE ELECTRICAL OUTLET** — Ensure that the electrical outlet is working by testing it with another device, such as a lamp.

**CHECK THE AC ADAPTER** — Check the AC adapter cable connections. If the AC adapter has a light, ensure that the light is on.

**CONNECT THE COMPUTER DIRECTLY TO AN ELECTRICAL OUTLET** — Bypass power protection devices, power strips, and extension cables to verify that the computer turns on.

**ADJUST THE POWER PROPERTIES** — Search for the keyword *sleep* in Windows Help and Support.

**SWITCH THE VIDEO IMAGE** — If your computer is attached to an external monitor, press <Fn><F8> to switch the video image to the display.

### **If the display is difficult to read**

**ADJUST THE BRIGHTNESS** — Press <Fn> and the up- or down-arrow key.

**MOVE THE EXTERNAL SUBWOOFER AWAY FROM THE COMPUTER OR MONITOR** — If your external speaker system includes a subwoofer, ensure that the subwoofer is at least 60 cm (2 ft) away from the computer or external monitor.

**ELIMINATE POSSIBLE INTERFERENCE** — Turn off nearby fans, fluorescent lights, halogen lamps, or other appliances.

**ROTATE THE COMPUTER TO FACE A DIFFERENT DIRECTION** — Eliminate sunlight glare, which can cause poor picture quality.

#### **ADJUST THE WINDOWS DISPLAY SETTINGS** —

- 1 Click Start  → Control Panel → Appearance and Personalization → Personalization → Display Settings.
- 2 Click the area you want to change or click the **Display** icon.

Try different settings for **Resolution** and **Colors**.

**RUN THE VIDEO DIAGNOSTICS TESTS** — If no error message appears and you still have a display problem, but the display is not completely blank, run the **Video** device group in the "Dell Diagnostics" on page 87, then contact Dell (see "Contacting Dell" on page 164).

**SEE "ERROR MESSAGES"** — If an error message appears, see "Error Messages" on page 98.

## If only part of the display is readable

### CONNECT AN EXTERNAL MONITOR —

- 1 Shut down your computer and connect an external monitor to the computer.
- 2 Turn on the computer and the monitor, and then adjust the monitor brightness and contrast controls.

If the external monitor works, the computer display or video controller may be defective. Contact Dell (see "Contacting Dell" on page 164).

## Drivers

### What Is a Driver?

A driver is a program that controls a device such as a printer, mouse, or keyboard. All devices require a driver program.

A driver acts like a translator between the device and any other programs that use the device. Each device has its own set of specialized commands that only its driver recognizes.

Dell ships your computer to you with required drivers already installed—no further installation or configuration is needed.



**NOTICE:** Your *Drivers and Utilities* media may contain drivers for operating systems that are not on your computer. Ensure that you are installing software appropriate for your operating system.

Many drivers, such as the keyboard driver, come with your Microsoft Windows operating system. You may need to install drivers if you:

- Upgrade your operating system.
- Reinstall your operating system.
- Connect or install a new device.

## Identifying Drivers

If you experience a problem with any device, identify whether the driver is the source of your problem and, if necessary, update the driver.

- 1 Click **Start** , and then right-click **Computer**.
- 2 Click **Properties**, and then click **Device Manager**.



**NOTE:** The **User Account Control** window may appear. If you are an administrator on the computer, click **Continue**; otherwise, contact your administrator to continue.

Scroll down the list of devices and check for an exclamation point (a circle with a [!]) next to the device name. If an exclamation point is next to the device name, you may need to reinstall the driver or install a new driver (see "Reinstalling Drivers and Utilities" on page 117).

## Reinstalling Drivers and Utilities



**NOTICE:** The Dell Support website at [support.dell.com](http://support.dell.com) and your *Drivers and Utilities* media provide approved drivers for Dell computers. If you install drivers obtained from other sources, your computer might not work correctly.

## Using Windows Device Driver Rollback

If a problem occurs on your computer after you install or update a driver, use Windows Device Driver Rollback to replace the driver with the previously installed version.

- 1 Click **Start** , and then right-click **Computer**.
- 2 Click **Properties**, and then click **Device Manager**.



**NOTE:** The **User Account Control** window may appear. If you are an administrator on the computer, click **Continue**; otherwise, contact your administrator to enter the **Device Manager**.

- 3 Right-click the device for which the new driver was installed and click **Properties**.
- 4 Click the **Drivers** tab, and then click **Roll Back Driver**.

If Device Driver Rollback does not resolve the problem, use System Restore (see "Restoring Your Microsoft® Windows Vista® Operating System" on page 120) to return your computer to the operating state that existed before you installed the new driver.

## Using the Drivers and Utilities Media

If using Device Driver Rollback or System Restore (see "Restoring Your Microsoft® Windows Vista® Operating System" on page 120) does not resolve the problem, reinstall the driver from your *Drivers and Utilities* media.

- 1 With the Windows desktop displayed, insert your *Drivers and Utilities* media. If this is your first time to use your *Drivers and Utilities* media, continue to step 2. If not, proceed to step 5.

- 2 When the *Drivers and Utilities* installation program starts, follow the prompts on the screen.



**NOTE:** In most cases, the *Drivers and Utilities* program starts running automatically. If it does not, start Windows Explorer, click your media drive directory to display the media contents, and then double-click the **autorcd.exe** file.

- 3 When the **InstallShield Wizard Complete** window appears, remove the *Drivers and Utilities* disc and click **Finish** to restart the computer.
- 4 When you see the Windows desktop, reinsert the *Drivers and Utilities* disc.
- 5 At the **Welcome Dell System Owner** screen, click **Next**.



**NOTE:** The *Drivers and Utilities* program displays drivers only for hardware that came installed in your computer. If you installed additional hardware, the drivers for the new hardware might not be displayed. If those drivers are not displayed, exit the *Drivers and Utilities* program. For drivers information, see the documentation that came with the device.

A message stating that the *Drivers and Utilities* program is detecting hardware in your computer appears.

The drivers that are used by your computer are automatically displayed in the **My Drivers—The ResourceCD has identified these components in your system** window.

- 6 Click the driver that you want to reinstall and follow the instructions on the screen.

If a particular driver is not listed, then that driver is not required by your operating system.

## Manually Reinstalling Drivers



**NOTE:** If your computer has a Consumer IR port and you are reinstalling a Consumer IR driver, you must first enable the Consumer IR port in the system setup program (see "Dell Technical Support Policy (U.S. Only)" on page 173) before continuing with the driver installation (see "Reinstalling Drivers and Utilities" on page 117). For information about components installed on your computer, see "Determining Your Computer's Configuration" on page 19.

- 1 After extracting the driver files to your hard drive, as described in the previous section, click **Start** , and then right-click **Computer**.
- 2 Click **Properties**, and then click **Device Manager**.
- 3 Double-click the type of device for which you are installing the driver (for example, **Modems** or **Infrared devices**).
- 4 Double-click the name of the device for which you are installing the driver.
- 5 Click **Driver** tab, and then click **Update Driver**.
- 6 Click **Install from a list or specific location (Advanced)**, and then click **Next**.
- 7 Click **Browse** and browse to the location to which you previously copied the driver files.
- 8 When the name of the appropriate driver appears, click **Next**.
- 9 Click **Finish**, and then restart your computer.

## Troubleshooting Software and Hardware Problems in the Windows Vista® Operating System

If a device is either not detected during the operating system setup or is detected but incorrectly configured, use Windows Vista Help and Support to resolve the incompatibility.



**NOTE:** Windows Vista® is a new operating system, so drivers or applications that support certain devices may not yet be available. Check with your hardware manufacturer for information on Windows Vista support for your device.

To start the Hardware Troubleshooter:

- 1 Click **Start**  and click **Help and Support**.
- 2 In the **Find an answer** section, click **Troubleshooting**.

OR

Type `hardware troubleshooter` in the search field, then press <Enter>.

- 3 In the search results, select the option that best describes the problem and follow the troubleshooting steps.



**NOTE:** If you do not find the answer in the items categorized in **Troubleshooting**, you can get online help by typing in your question in the **Search Help** field at the top of the window.

## Restoring Your Microsoft® Windows Vista® Operating System

You can restore your Windows Vista operating system in the following ways:

- Windows Vista includes the Backup and Restore Center to create backups of important files on your computer or to back up the entire hard drive. You can then restore your operating system or files if needed.
- Microsoft Windows System Restore returns your hard drive to an earlier operating state without affecting data files. Use System Restore as the first solution for restoring your operating system and preserving data files. For instructions, see "Using Windows Vista System Restore" on page 121.
- Dell Factory Image Restore restores your hard drive to the operating state it was in when you purchased the computer. Dell Factory Image Restore permanently deletes all data on the hard drive and removes any applications installed after you received the computer. Use Factory Image Restore only if System Restore did not resolve your operating system problem.
- If you received an *Operating System* disc with your computer, you can use it to restore your operating system. However, using the *Operating System* disc also deletes all data on the hard drive. Use the disc *only* if System Restore did not resolve your operating system problem.



## Using Windows Vista System Restore

The Windows operating system provides System Restore to allow you to return your computer to an earlier operating state (without affecting data files) if changes to the hardware, software, or other system settings have left the computer in an undesirable operating state. See the Windows Help and Support Center for information on using System Restore.

To access the Windows Help and Support Center, click **Start**  → **Help and Support**.



**NOTICE:** Make regular backups of your data files. System Restore does not monitor your data files or recover them.



**NOTE:** The procedures in this document were written for the Windows default view, so they may not apply if you set your Dell computer to the Windows Classic view.

## Creating a Restore Point

You can either automatically or manually create a restore point from the Windows Vista Back Up and Restore Center. To access the Windows Vista Back up and Restore Center:

- Click **Start**  → **Welcome Center**. In the **Get started with Windows** section, click **Show all 14 items...** → **Back Up and Restore Center**.

OR

- Click **Start**  → **All Programs** → **Maintenance** → **Back Up and Restore Center**. Under **Tasks**, click **Create a restore point or change settings**.

For more information:

- 1 Click **Start**  → **Help and Support**.
- 2 Type **System Restore** in the search field and press <Enter>.

## Restoring the Computer to an Earlier Operating State

If problems occur after you install a device driver, use Device Driver Rollback (see "Using Windows Device Driver Rollback" on page 117) to resolve the problem. If Device Driver Rollback does not resolve the problem, then use System Restore.

 **NOTICE:** Before you restore the computer to an earlier operating state, save and close all open files and exit any open programs. Do not alter, open, or delete any files or programs until the system restoration is complete.

- 1 Click **Start**  → **Control Panel** → **System and Maintenance** → **Back Up and Restore Center**.
- 2 In the **Tasks** list, click **Repair Windows using System Restore**.
- 3 Click **Continue** in the **User Account Control (UAC)** dialog box asking for permission to run the application.
- 4 Click **Next** in the **System Restore** window to view the most recent restore points in chronological order.
- 5 Select the **Show restore points older than 5 days** checkbox to view the complete list of restore points.
- 6 Select a restore point. Try to restore from the most recent restore point. If this restore point fails to correct the problem, try the next oldest restore point until the issue is resolved. Any software installed after the selected restore point will need to be reinstalled.
- 7 Click **Next** → **Finish**.
- 8 When prompted, click **Yes**.
- 9 After System Restore finishes collecting data, the computer restarts.
- 10 After the computer restarts, click **OK**.

To change the restore point, you can either repeat the steps using a different restore point, or you can undo the restoration.

If you encounter any error messages during the restore process, follow the prompts on the screen to correct the error.

### Undoing the Last System Restore

 **NOTICE:** Before you undo the last system restore, save and close all open files and exit any open programs. Do not alter, open, or delete any files or programs until the system restoration is complete.



- 1 Click **Start**  → **Help and Support**.
- 2 Type **System Restore** in the search field and press <Enter>.
- 3 Click **Undo my last restoration**, and then click **Next**.

## Restoring the Computer to the Default Factory Configuration

The **Dell Factory Image Restore** option allows you to restore your hard drive back to its original factory configuration as when you first purchased it from Dell. This option appears on Dell computers that were originally pre-installed with Windows Vista<sup>®</sup> operating system and does not include computers purchased through the Express Upgrade promotion or computers that were upgraded to Windows Vista from a previous version of the Windows<sup>®</sup> operating systems.



**NOTICE:** When you restore the computer to the default factory configuration, all data on the hard drive is deleted. Before performing this procedure, back up personal files. If you do not back up personal files, the data is lost.

- 1 Restart the computer. To do this, click **Start**  →  → **Restart**.
- 2 As the computer restarts, press <F8> until the **Advanced Boot Options** menu appears on the screen.



**NOTE:** You must press the <F8> key before the Windows logo appears on the screen. If you press <F8> after the Windows logo appears on the screen, the **Advanced Boot Options** menu will not appear on the screen. If you do not see the **Advanced Boot Options** menu, restart the computer, and then repeat this step until you see the menu on the screen.

- 3 Press <Down Arrow> to select **Repair Your Computer** on the **Advanced Boot Options** menu, and then press <Enter>.
- 4 Specify the language settings that you want, and then click **Next**.
- 5 Log in as a user who has administrative credentials, and then click **OK**.
- 6 Click **Dell Factory Image Restore**.
- 7 In the **Dell Factory Image Restore** window, click **Next**.
- 8 Select the **Yes, reformat hard drive and restore system software to factory condition** checkbox.
- 9 Click **Next**. The computer is restored to the default factory configuration.
- 10 When the restore operation is completed, click **Finish** to restart the computer.

## Using the Operating System Media

### Before You Begin

If you are considering reinstalling the Windows operating system to correct a problem with a newly installed driver, first try using Windows Device Driver Rollback (see "Using Windows Device Driver Rollback" on page 117). If Device Driver Rollback does not resolve the problem, then use System Restore to return your operating system to the operating state it was in before you installed the new device driver (see "Using Windows Vista System Restore" on page 121).

 **NOTICE:** Before performing the installation, back up all data files on your primary hard drive. For conventional hard drive configurations, the primary hard drive is the first drive detected by the computer.

To reinstall Windows, you need the following items:

- Dell *Operating System* media
- Dell *Drivers and Utilities* media

 **NOTE:** Your *Drivers and Utilities* media contains drivers that were installed during assembly of the computer. Use your *Drivers and Utilities* media to load any required drivers, including the drivers required if your computer has a RAID controller.

### Reinstalling Windows Vista

The reinstallation process can take 1 to 2 hours to complete. After you reinstall the operating system, you must also reinstall the device drivers, virus protection program, and other software.

 **NOTICE:** The *Operating System* media provides options for reinstalling Windows. The options can overwrite files and possibly affect programs that are installed on your hard drive. Therefore, do not reinstall Windows unless a Dell technical support representative instructs you to do so.

- 1 Save and close any open files and exit any open programs.
- 2 Insert the *Operating System* media.
- 3 Click **Exit** if the **Install Windows** message appears.

- 4 Restart the computer.

When the DELL logo appears, press <F12> immediately.



**NOTE:** If you wait too long and the operating system logo appears, continue to wait until you see the Microsoft Windows desktop, then shut down your computer and try again.



**NOTE:** The next steps change the boot sequence for one time only. On the next start-up, the computer boots according to the devices specified in the system setup program.

- 5 When the boot device list appears, highlight **CD/DVD/CD-RW Drive**, and then press <Enter>.
- 6 Press any key to **Boot from CD-ROM**.
- 7 Follow the instructions on the screen to complete the installation.



# Adding and Replacing Parts

## Before You Begin

This chapter provides procedures for removing and installing the components in your computer. Unless otherwise noted, each procedure assumes that the following conditions exist:

- You have performed the steps in "Turning Off Your Computer" on page 127 and "Before Working Inside Your Computer" on page 128.
- You have read the safety information in your *Dell Product Information Guide*.
- A component can be replaced—or if purchased separately—installed by performing the removal procedure in reverse order.

## Recommended Tools

The procedures in this document may require the following tools:

- Small flat-blade screwdriver
- Phillips screwdriver
- Small plastic scribe
- Flash BIOS update (see the Dell Support website at [support.dell.com](http://support.dell.com))

## Turning Off Your Computer



**NOTICE:** To avoid losing data, save and close any open files and exit any open programs before you turn off your computer.









- 1 Save and close any open files and exit any open programs.
- 2 Click **Start** , click the arrow , and then click **Shut Down**.

The computer turns off after the operating system shutdown process finishes.

- 3 Ensure that the computer and any attached devices are turned off. If your computer and attached devices did not automatically turn off when you shut down your operating system, press and hold the power button for at least 8 to 10 seconds until the computer turns off.

## Before Working Inside Your Computer

Use the following safety guidelines to help protect your computer from potential damage and to help ensure your own personal safety.

-  **CAUTION:** Before you begin any of the procedures in this section, follow the safety instructions in the *Product Information Guide*.
-  **CAUTION:** Handle components and cards with care. Do not touch the components or contacts on a card. Hold a card by its edges or by its metal mounting bracket. Hold a component such as a processor by its edges, not by its pins.
-  **NOTICE:** Only a certified service technician should perform repairs on your computer. Damage due to servicing that is not authorized by Dell is not covered by your warranty.
-  **NOTICE:** When you disconnect a cable, pull on its connector or on its strain-relief loop, not on the cable itself. Some cables have a connector with locking tabs; if you are disconnecting this type of cable, press in on the locking tabs before you disconnect the cable. As you pull connectors apart, keep them evenly aligned to avoid bending any connector pins. Also, before you connect a cable, ensure that both connectors are correctly oriented and aligned.
-  **NOTICE:** To avoid electrostatic discharge, ground yourself by using a wrist grounding strap or by periodically touching an unpainted metal surface (such as a connector on the back of the computer).
-  **NOTICE:** To help prevent damage to the computer, perform the following steps before you begin working inside the computer.
  - 1 Ensure that the work surface is flat and clean to prevent the computer cover from being scratched.
  - 2 Turn off your computer (see "Turning Off Your Computer" on page 127).
-  **NOTICE:** To disconnect a network cable, first unplug the cable from your computer, and then unplug it from the network wall jack.
  - 3 Disconnect any telephone or network cables from the computer.
  - 4 Disconnect your computer and all attached devices from their electrical outlets.
-  **NOTICE:** To help prevent damage to the system board, you must remove the battery from the battery bay before you service the computer.
-  **NOTICE:** To avoid damage to the computer, use only the battery designed for this particular Dell computer. Do not use batteries designed for other Dell computers.



- 5 Close the cover, turn the computer over, and place the computer on a flat surface.
- 6 Slide and click the battery release latch.
- 7 Slide the battery out of the battery bay.

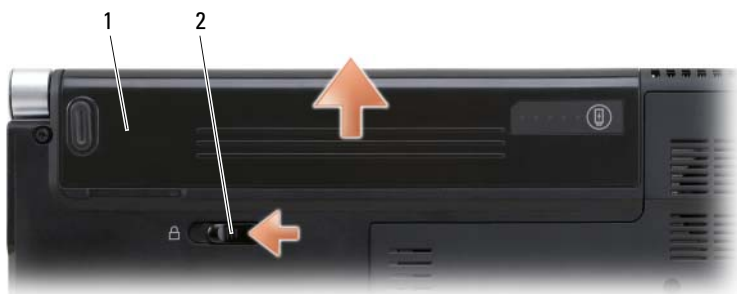



1 battery      2 battery release latch

- 8 Turn the computer top-side up, open the display, and press the power button to ground the system board.
- 9 Remove any installed cards from the ExpressCard slot (see "Removing an ExpressCard or Blank" on page 69) and the 8-in-1 memory card reader (see "Removing a Memory Card or Blank" on page 72).

## Hard Drive

- CAUTION:** If you remove the hard drive from the computer when the drive is hot, *do not touch* the metal housing of the hard drive.
- CAUTION:** Before you begin any of the procedures in this section, follow the safety instructions in the *Product Information Guide*.
- NOTICE:** To prevent data loss, turn off your computer (see "Turning Off Your Computer" on page 127) before removing the hard drive. Do not remove the hard drive while the computer is on or in Sleep state.
- NOTICE:** Hard drives are extremely fragile. Exercise care when handling the hard drive.

 **NOTE:** Dell does not guarantee compatibility or provide support for hard drives from sources other than Dell.

 **NOTE:** If you are installing a hard drive from a source other than Dell, you need to install an operating system, drivers, and utilities on the new hard drive (see "Restoring Your Microsoft® Windows Vista® Operating System" on page 120 and "Reinstalling Drivers and Utilities" on page 117).

## Removing the Hard Drive

- 1 Follow the procedures in "Before You Begin" on page 127.
- 2 Turn the computer over.
- 3 Remove the four M3 x 3-mm screws and slide the hard drive away from the bay.



 **NOTICE:** When the hard drive is not in the computer, store it in protective antistatic packaging (see "Protecting Against Electrostatic Discharge" in the *Product Information Guide*).

## Replacing the Hard Drive

- 1 Remove the new drive from its packaging.  
Save the original packaging for storing or shipping the hard drive.
-  **NOTICE:** Use firm and even pressure to slide the drive into place. If you use excessive force, you may damage the connector.
- 2 Slide the hard drive into the bay.
- 3 Replace and tighten the four screws on the hard drive.
- 4 Install the operating system for your computer, as needed (see "Restoring Your Microsoft® Windows Vista® Operating System" on page 120).
- 5 Install the drivers and utilities for your computer, as needed (see "Reinstalling Drivers and Utilities" on page 117).

## Returning a Hard Drive to Dell

Return your old hard drive to Dell in its original, or comparable, foam packaging. Otherwise, the hard drive may be damaged in transit.

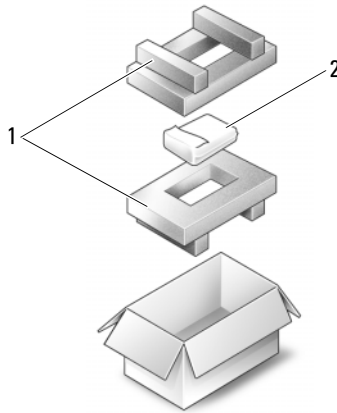



1 foam packaging

2 hard drive

## Hinge Covers and Center Control Cover

 **CAUTION:** Before you begin any of the procedures in this section, follow the safety instructions in the *Product Information Guide*.

 **NOTICE:** To avoid electrostatic discharge, ground yourself by using a wrist grounding strap or by periodically touching an unpainted metal surface (such as a connector on the back of the computer).

 **NOTICE:** To help prevent damage to the system board, you must remove the battery from the battery bay before you begin working inside the computer.

### Removing the Hinge Covers and Center Control Cover

- 1 Follow the procedures in "Before You Begin" on page 127.
- 2 Turn the computer over and remove the two M2 x 3-mm screws that secure the center control cover.



- 3 Turn the computer top side up, and open the display as far as it will open.
- 4 Remove the hinge covers from each side of the computer.



1 center control cover      2 hinge cover (2)

- 5 Ease the center control cover up, and remove the cable that attaches it to the system board.

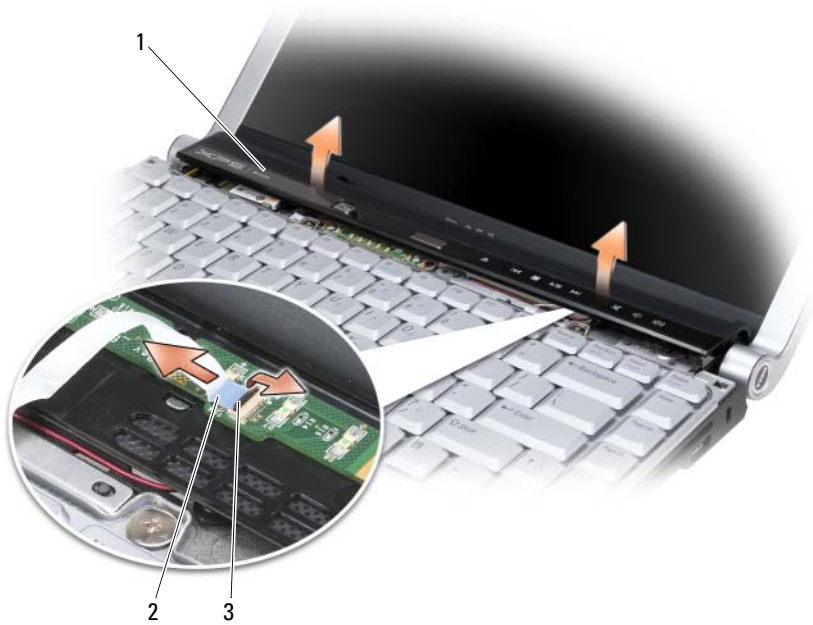

1 center control cover    2 center control cover cable    3 securing lever

## Replacing the Hinge Covers and Center Control Cover

- 1 Reconnect the cable that attaches the center control cover to the system board, and snap the center control cover in place.
- 2 Replace the hinge covers.
- 3 Turn the computer over and replace the two M2 x 3-mm screws that secure the center control cover to the computer base.

# Keyboard

For more information about the keyboard, see "Using the Keyboard and Touch Pad" on page 43.



**CAUTION:** Before you begin any of the procedures in this section, follow the safety instructions in the *Product Information Guide*.



**NOTICE:** To avoid electrostatic discharge, ground yourself by using a wrist grounding strap or by periodically touching an unpainted metal surface (such as a connector on the back of the computer).



**NOTICE:** To help prevent damage to the system board, you must remove the battery from the battery bay before you begin working inside the computer.

## Removing the Keyboard

- 1 Follow the procedures in "Before You Begin" on page 127.
- 2 Remove the Hinge Covers and Center Control Cover (see "Hinge Covers and Center Control Cover" on page 132).
- 3 Remove the two M2 x 2-mm screws at the top of the keyboard.



**NOTICE:** The keycaps on the keyboard are fragile, easily dislodged, and time-consuming to replace. Be careful when removing and handling the keyboard.

- 4 Carefully slide the keyboard toward the back of the computer.



**NOTICE:** Be extremely careful when removing and handling the keyboard. Failure to do so could result in scratching the display panel.

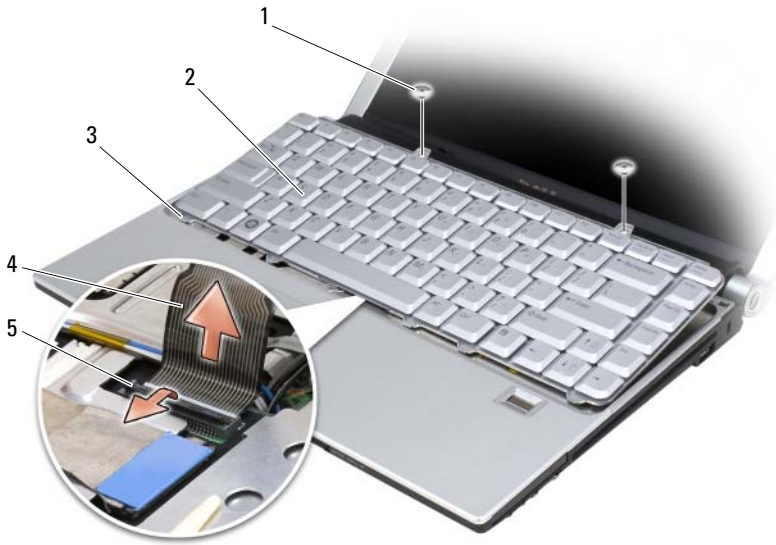

- |   |                      |   |                |
|---|----------------------|---|----------------|
| 1 | M2 x 2-mm screw (2)  | 2 | keyboard       |
| 3 | keyboard tabs (5)    | 4 | keyboard cable |
| 5 | plastic securing bar |   |                |

- 5 Pull up on the plastic bar that secures the keyboard cable to the system board and remove the keyboard

## Replacing the Keyboard

- 1 Slide the keyboard connector into the slot until it clicks and pull down on the plastic bar that secures the keyboard connector to the system board.
  - 2 Align the five tabs along the bottom of the keyboard and slide them under the palm rest.
- ➔ NOTICE:** The keycaps on the keyboard are fragile, easily dislodged, and time-consuming to replace. Be careful when removing and handling the keyboard.
- 3 Replace the two M2 x 2-mm screws along the top of the keyboard.



# Memory



**CAUTION:** Before you begin any of the procedures in this section, follow the safety instructions in the *Product Information Guide*.

You can increase your computer memory by installing memory modules on the system board. See "Specifications" on page 165 for information on the memory supported by your computer. Install only memory modules that are intended for your computer.



**NOTE:** Memory modules purchased from Dell are covered under your computer warranty.

Your computer has two user-accessible SODIMM sockets that can be accessed from the bottom of the computer.



**NOTICE:** If you need to install memory modules in two connectors, install a memory module in the connector labeled "DIMM1" before you install a module in the connector labeled "DIMM2."

## Removing the DIMM 1 Memory Module



**NOTICE:** To avoid electrostatic discharge, ground yourself by using a wrist grounding strap or by periodically touching an unpainted metal surface (such as a connector on the back of the computer).



**NOTICE:** If there is a memory module in DIMM 2, remove it prior to removing the memory module from DIMM 1. Failure to do so could result in damage to both memory modules.

- 1 Follow the procedures in "Before You Begin" on page 127.
- 2 Turn the computer over and loosen the three captive screws and the M2.5 x 5-mm screw. Remove the module cover.



1 M2.5 x 5-mm screw      2 captive screws (3)

- ➔ **NOTICE:** To prevent damage to the memory module connector, do not use tools to spread the memory module securing clips.
- 3 Use your fingertips to carefully spread apart the securing clips on each end of the memory module connector until the module pops up.
  - 4 Remove the module from the connector.

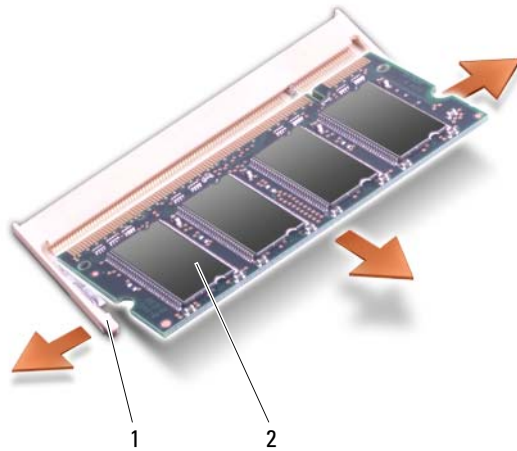

1 securing clips (2)      2 memory module (DIMM 1)

## Replacing the DIMM 1 Memory Module

 **NOTICE:** To avoid electrostatic discharge, ground yourself by using a wrist grounding strap or by periodically touching an unpainted metal surface (such as a connector on the back of the computer).

- 1 Align the notch in the module edge connector with the tab in the connector slot.
- 2 Slide the module firmly into the slot at a 45-degree angle, and rotate the module down until it clicks into place. If you do not feel the click, remove the module and reinstall it.

 **NOTE:** If the memory module is not installed properly, the computer may not boot. No error message indicates this failure.

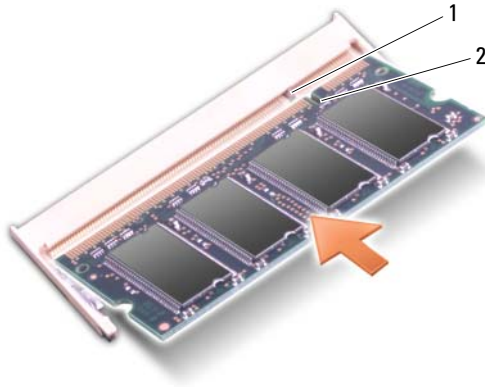

1 tab 2 notch

- 3 Replace the module cover.
- 4 Insert the battery into the battery bay, or connect the AC adapter to your computer and an electrical outlet.
- 5 Turn on the computer.

As the computer boots, it detects the additional memory and automatically updates the system configuration information.

To confirm the amount of memory installed in the computer, click **Start**  → **Help and Support** → **Dell System Information**.

### **Removing the DIMM 2 Memory Module**

The DIMM 2 memory module is located directly above the DIMM 1 memory module on the bottom of the computer.

- 1 Follow the procedures in "Before You Begin" on page 127.
- 2 Turn the computer over and loosen the three captive screws and the M2.5 x 5-mm screw. Remove the module cover.



1 M2.5 x 5-mm screw      2 captive screws (3)

- ➔ **NOTICE:** To prevent damage to the memory module connector, do not use tools to spread the memory module securing clips.
- ➔ **NOTICE:** To avoid electrostatic discharge, ground yourself by using a wrist grounding strap or by periodically touching an unpainted metal surface (such as a connector on the back of the computer).
- 3 Use your fingertips to carefully spread apart the securing clips on each end of the memory module connector until the module pops up.

- 4 Remove the module from the connector.

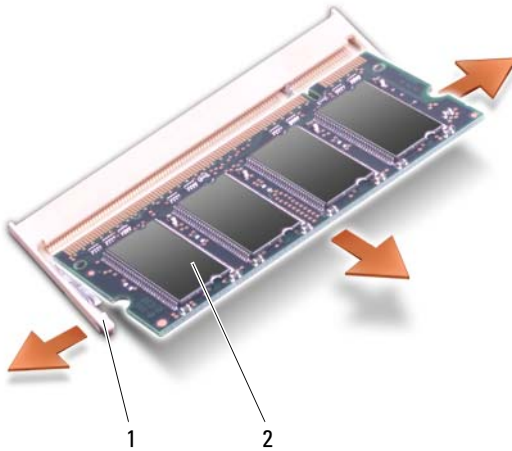

- 1    securing clips (2)      2    memory module (DIMM 1)

## Replacing the DIMM 2 Memory Module

**➔ NOTICE:** To avoid electrostatic discharge, ground yourself by using a wrist grounding strap or by periodically touching an unpainted metal surface (such as a connector on the back of the computer).

- 1 Align the notch in the module edge connector with the tab in the connector slot.
- 2 Slide the module firmly into the slot at a 45-degree angle, and rotate the module down until it clicks into place. If you do not feel the click, remove the module and reinstall it.

**🔧 NOTE:** If the memory module is not installed properly, the computer may not boot. No error message indicates this failure.

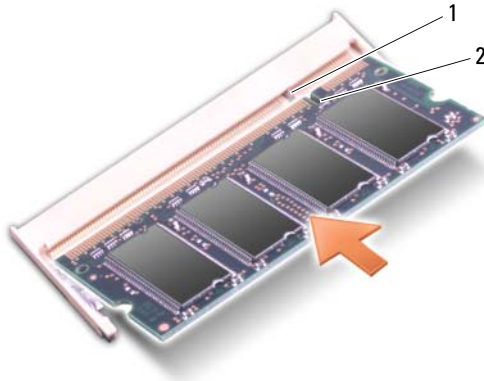

1 tab 2 notch

**➡ NOTICE:** If the cover is difficult to close, remove the module and reinstall it. Forcing the cover to close may damage your computer.

- 3 Replace the module cover.
- 4 Insert the battery into the battery bay, or connect the AC adapter to your computer and an electrical outlet.
- 5 Turn on the computer.

As the computer boots, it detects the additional memory and automatically updates the system configuration information.

To confirm the amount of memory installed in the computer, click **Start**  → **Help and Support** → **Dell System Information**.

# Subscriber Identity Module

Subscriber Identity Modules (SIM) identify users uniquely through an International Mobile Subscriber Identity.

**⚠ CAUTION:** Before you begin any of the procedures in this section, follow the safety instructions in the *Product Information Guide*.

**🔧 NOTE:** Only Cingular and Vodafone need a SIM. Verizon, Sprint, and Telus do not use SIMs.

- 1 Follow the procedures in "Before You Begin" on page 127.
- 2 In the battery bay, slide the SIM into the compartment with the cut-off corner of the SIM facing away from the compartment.

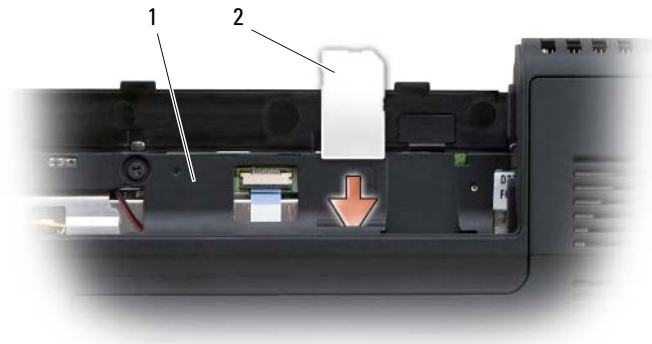

1 battery bay      2 SIM

# Wireless Mini-Cards

**⚠ CAUTION:** Before you begin any of the procedures in this section, follow the safety instructions in the *Product Information Guide*.

**➡ NOTICE:** To help prevent damage to the system board, you must remove the battery from the battery bay before you begin working inside the computer.

If you ordered a wireless mini-card with your computer, the card is already installed. Your computer supports three types of wireless mini-cards:

- Wireless Local Area Network (WLAN)
- Mobile Broadband or Wireless Wide Area Network (WWAN)
- Flash Cache Module (FCM)



## Removing a WLAN Card

- 1 Follow the procedures in "Before You Begin" on page 127.
- 2 Turn the computer over.
- 3 Loosen the captive screw on the cover of the mini-card compartment and remove the cover.



1 captive screw

- 4 Disconnect the antenna cables from the WLAN card.

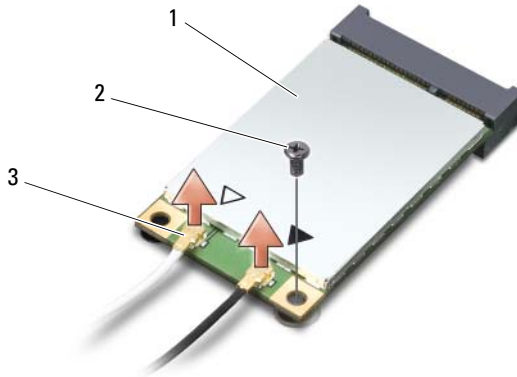

- 1 WLAN Card    2 M2 x 3-mm screw    3 antenna cable connectors (2)

- 5 Release the WLAN card by removing the screw.
- 6 Lift the WLAN card out of its system board connector.

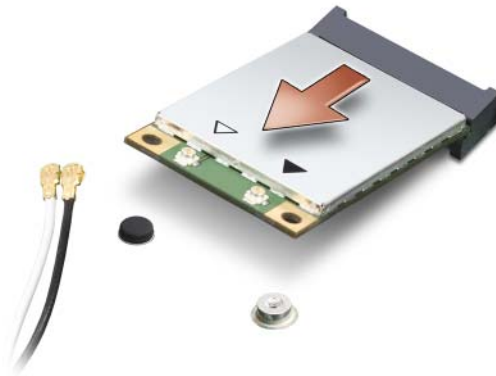

## Replacing a WLAN Card



**NOTICE:** The connectors are keyed to ensure correct insertion. If you feel resistance, check the connectors on the card and on the system board, and realign the card.



**NOTICE:** To avoid damage to the WLAN card, never place cables under the card.

- 1 Insert the WLAN card connector at a 45-degree angle into the system board connector labeled "WLAN".
- 2 Press the other end of the WLAN card down into the slot on the system board until the card clicks into place.
- 3 Replace the M2 x 3-mm screw.
- 4 Connect the appropriate antenna cables to the WLAN card you are installing:

If the WLAN card has two triangles on the label (white and black), connect the white antenna cable to the connector labeled "main" (white triangle), and connect the black antenna cable to the connector labeled "aux" (black triangle).

If the WLAN card has three triangles on the label (white, black, and gray), connect the white antenna cable to the white triangle, connect the black antenna cable to the black triangle, and connect the gray antenna cable to the gray triangle.



**NOTE:** The gray antenna cable may not be available in all computers. The presence of the gray antenna cable in your Mini-Card compartment depends on the type of display.

- 5 Secure unused antenna cables in the protective mylar sleeve.
- 6 Replace the cover and tighten the captive screws.

## Removing a Mobile Broadband or WWAN Card



**NOTE:** WWAN is also available on an ExpressCard (see "Using ExpressCards" on page 67).

- 1 Follow the procedures in "Before You Begin" on page 127.
- 2 Turn the computer over.

- 3 Loosen the captive screw on the cover of the mini-card compartment and remove the cover.



1 captive screw

- 4 Disconnect the two antenna cables from the WWAN card.

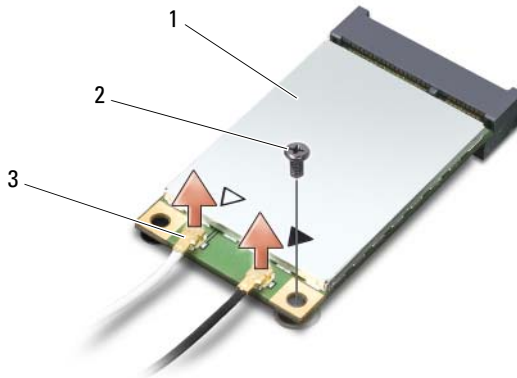

1 WWAN Card    2 M2 x 3-mm screw    3 antenna cable connectors (2)

- 5 Release the WWAN card by removing the screw.
- 6 Lift the WWAN card out of its system board connector.

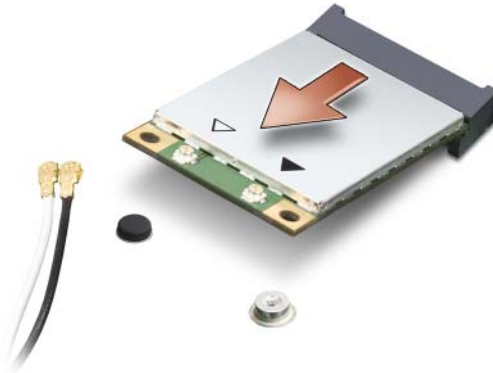

## Replacing a WWAN Card

- ➡ **NOTICE:** The connectors are keyed to ensure correct insertion. If you feel resistance, check the connectors on the card and on the system board, and realign the card.
- ➡ **NOTICE:** To avoid damage to the WWAN card, never place cables under the card.
- 1 Insert the WWAN card connector at a 45-degree angle into the system board connector labeled "WWAN".
  - 2 Press the other end of the WWAN card down into the slot on the system board until the card clicks into place.
  - 3 Replace the M2 x 3-mm securing screw.
  - 4 Connect the black antenna cable with a gray stripe to the connector labeled "aux" (black triangle) and connect the white antenna cable with a gray stripe to the connector labeled "main" (white triangle).
  - 5 Secure unused antenna cables in the protective mylar sleeve.
  - 6 Replace the cover and tighten the captive screw.

## Flash Cache Module (FCM)

The FCM is an internal memory card that helps improve the performance of your computer. The FCM card is also known as Intel Turbo Memory and the Intel Flash Cache Logic Chip Mini-card.

 **NOTE:** This card is only compatible with the Microsoft Windows Vista™ operating system.

If you ordered an FCM card with your computer, the card is already installed.

### Removing the FCM

- 1 Follow the procedures in "Before You Begin" on page 127.
- 2 Turn the computer over and remove the cover on the mini-card compartment.
- 3 Ground yourself by touching one of the metal connectors on the back of the computer.

 **NOTE:** If you leave the area, ground yourself again when you return to the computer.

- 4 Remove the M2 x 3-mm screw.
- 5 Remove the FCM.

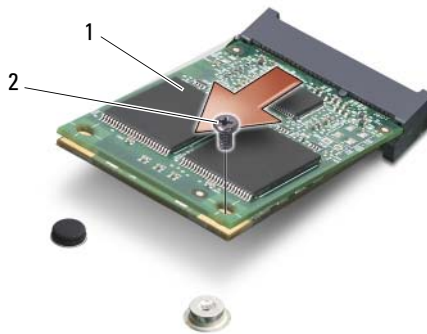

1 FCM Card

2 M2 x 3-mm securing screw

## Replacing the FCM

 **NOTICE:** Install the FCM in the WWAN or WPAN slot. Do not install an FCM in the WLAN card slot. Doing so may cause damage to your computer.

- 1 Insert the FCM connector at a 45-degree angle into the system board connector labeled "FCM".
- 2 Press the other end of the FCM down into the slot on the system board until the card clicks into place.
- 3 Replace the M2 x 3-mm screw.

## Internal Card With Bluetooth<sup>®</sup> Wireless Technology

 **CAUTION:** Before you begin any of the procedures in this section, follow the safety instructions in the *Product Information Guide*.

 **NOTICE:** To avoid electrostatic discharge, ground yourself by using a wrist grounding strap or by periodically touching an unpainted metal surface (such as a connector on the back of the computer).

 **NOTICE:** To help prevent damage to the system board, you must remove the battery from the battery bay before you begin working inside the computer.

If you ordered a card with Bluetooth Wireless Technology with your computer, it is already installed.

## Removing the Card

- 1 Follow the procedures in "Before You Begin" on page 127.
- 2 Remove the hinge covers and center control cover (see "Hinge Covers and Center Control Cover" on page 132).
- 3 Disconnect the cable on the card to remove the card from the computer.

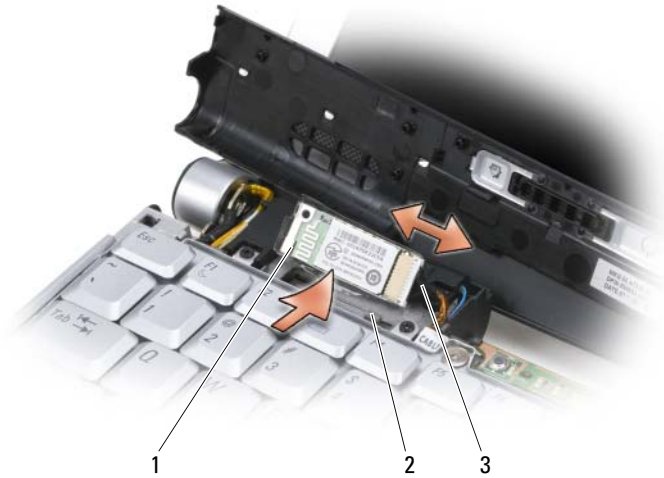



- |   |       |   |                   |
|---|-------|---|-------------------|
| 1 | card  | 2 | securing tabs (2) |
| 3 | cable |   |                   |

## Replacing the Card

- 1 Replace the card at an angle to slide it under the securing tabs in the card compartment.
- 2 Connect the cable to the card.

## Coin-Cell Battery

-  **CAUTION:** Before you begin any of the procedures in this section, follow the safety instructions in the *Product Information Guide*.
-  **NOTICE:** To avoid electrostatic discharge, ground yourself by using a wrist grounding strap or by periodically touching an unpainted metal surface (such as a connector on the back of the computer).
-  **NOTICE:** To help prevent damage to the system board, you must remove the battery from the battery bay before you begin working inside the computer.



## Removing the Coin-Cell Battery

- 1 Follow the procedures in "Before You Begin" on page 127.
- 2 Turn the computer over and loosen the three captive screws along with the M2.5 x 5-mm screw. Remove the module cover.
- 3 Disconnect the coin-cell battery cable from the system board.

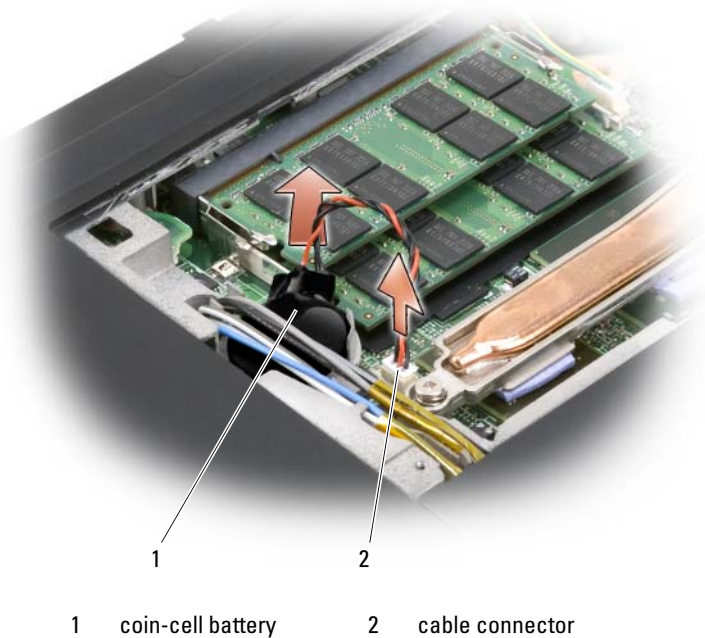

- 4 Slide the coin-cell battery from under the antenna cables and remove the battery from the computer.

## Replacing the Coin-Cell Battery

- 1 Connect the coin-cell battery cable to the system board.
- 2 Slide the coin-cell battery into its storage location under the antenna cables.
- 3 Replace the module cover.



## Dell™ QuickSet



**NOTE:** This feature may not be available on your computer.

Dell QuickSet provides you with easy access to configure or view the following types of settings:

- Network connectivity
- Power management
- Display
- System information

Depending on what you want to do in Dell QuickSet, you can start it by either *clicking*, *double-clicking*, or *right-clicking* the QuickSet icon in the Microsoft® Windows® notification area. The notification area is located in the lower-right corner of your screen.

For more information about QuickSet, right-click the QuickSet icon and select **Help**.



# Traveling With Your Computer

## Identifying Your Computer

- Attach a name tag or business card to the computer.
- Write down your Service Tag and store it in a safe place away from the computer or carrying case. Use the Service Tag if you need to report a loss or theft to law enforcement officials and to Dell.
- Create a file on the Microsoft® Windows® desktop called **if\_found**. Place information such as your name, address, and phone number in this file.
- Contact your credit card company and ask if it offers coded identification tags.

## Packing the Computer

- Remove any external devices attached to the computer and store them in a safe place.
- Fully charge the main battery and any spare batteries that you plan to carry with you.
- Shut down the computer.
- Disconnect the AC adapter.
- ➡ **NOTICE:** When the display is closed, extraneous items on the keyboard or palm rest could damage the display.
- Remove any extraneous items, such as paper clips, pens, and paper, from the keyboard and palm rest and close the display.
- Use the optional Dell carrying case to pack the computer and its accessories together safely.
- Avoid packing the computer with items such as shaving cream, colognes, perfumes, or food.
- ➡ **NOTICE:** If the computer has been exposed to extreme temperatures, allow it to acclimate to room temperature for 1 hour before turning it on.

- Protect the computer, the batteries, and the hard drive from hazards such as extreme temperatures and overexposure to sunlight, dirt, dust, or liquids.
- Pack the computer so that it does not slide around in the trunk of your car or in an overhead storage compartment.

## Travel Tips

 **NOTICE:** Do not move the computer while using the optical drive to prevent loss of data.

 **NOTICE:** Do not check the computer as baggage.

- Consider disabling wireless activity on your computer to maximize battery operating time. To disable wireless activity, use the wireless switch (see "Dell Wi-Fi Catcher™ Network Locator" on page 81).
- Consider changing your power management options to maximize battery operating time (see "Configuring Power Management Settings" on page 52).
- If you are traveling internationally, carry proof of ownership—or of your right to use the computer if it is company-owned—to speed your passage through customs. Investigate the customs regulations of the countries you plan to visit, and consider acquiring an international carnet (also known as a *merchandise passport*) from your government.
- Find out what type of electrical outlets are used in the countries you will visit, and have appropriate power adapters.
- Check with your credit card company for information about the kinds of emergency travel assistance it offers to users of portable computers.

## Traveling by Air

 **NOTICE:** Do not walk the computer through a metal detector. Send the computer through an X-ray machine or have it hand-inspected.

- Ensure that you have a charged battery available in case you are asked to turn on the computer.
- Prior to entering the airplane, verify that using a computer is permitted. Some airlines forbid the use of electronic devices during flight. All airlines forbid the use of electronic devices during takeoff and landing.

# Getting Help

## Obtaining Assistance

 **CAUTION:** If you need to remove the computer cover, first disconnect the computer power and modem cables from all electrical outlets.

If you experience a problem with your computer, you can complete the following steps to diagnose and troubleshoot the problem:

- 1 See "Troubleshooting" on page 87 for information and procedures that pertain to the problem your computer is experiencing.
- 2 See "Dell Diagnostics" on page 87 for procedures on how to run Dell Diagnostics.
- 3 Fill out the "Diagnostics Checklist" on page 163.
- 4 Use Dell's extensive suite of online services available at Dell Support ([support.dell.com](http://support.dell.com)) for help with installation and troubleshooting procedures. See "Online Services" on page 160 for a more extensive list of Dell Support online.
- 5 If the preceding steps have not resolved the problem, see "Contacting Dell" on page 164.

 **NOTE:** Call Dell Support from a telephone near or at the computer so that the support staff can assist you with any necessary procedures.

 **NOTE:** Dell's Express Service Code system may not be available in all countries.

When prompted by Dell's automated telephone system, enter your Express Service Code to route the call directly to the proper support personnel. If you do not have an Express Service Code, open the **Dell Accessories** folder, double-click the **Express Service Code** icon, and follow the directions.

For instructions on using the Dell Support, see "Technical Support and Customer Service" on page 160.

 **NOTE:** Some of the following services are not always available in all locations outside the continental U.S. Call your local Dell representative for information on availability.

## Technical Support and Customer Service

Dell's support service is available to answer your questions about Dell™ hardware. Our support staff uses computer-based diagnostics to provide fast, accurate answers.

To contact Dell's support service, see "Before You Call" on page 162, and then see "Contacting Dell" on page 164.

### DellConnect

DellConnect is a simple online access tool that allows a Dell service and support associate to access your computer through a broadband connection, diagnose your problem and repair it all under your supervision. For more information, go to [support.dell.com](http://support.dell.com) and click DellConnect.

### Online Services

You can learn about Dell products and services on the following websites:

[www.dell.com](http://www.dell.com)

[www.dell.com/ap](http://www.dell.com/ap) (Asian/Pacific countries only)

[www.dell.com/jp](http://www.dell.com/jp) (Japan only)

[www.euro.dell.com](http://www.euro.dell.com) (Europe only)

[www.dell.com/la](http://www.dell.com/la) (Latin American and Caribbean countries)

[www.dell.ca](http://www.dell.ca) (Canada only)

You can access Dell Support through the following websites and e-mail addresses:

- Dell Support websites

[support.dell.com](http://support.dell.com)

[support.jp.dell.com](http://support.jp.dell.com) (Japan only)

[support.euro.dell.com](http://support.euro.dell.com) (Europe only)

- Dell Support e-mail addresses

[mobile\\_support@us.dell.com](mailto:mobile_support@us.dell.com)

[support@us.dell.com](mailto:support@us.dell.com)

[la-techsupport@dell.com](mailto:la-techsupport@dell.com) (Latin America and Caribbean countries only)

[apsupport@dell.com](mailto:apsupport@dell.com) (Asian/Pacific countries only)



- Dell Marketing and Sales e-mail addresses  
apmarketing@dell.com (Asian/Pacific countries only)  
sales\_canada@dell.com (Canada only)
- Anonymous file transfer protocol (FTP)  
ftp.dell.com  
Log in as user: `anonymous`, and use your e-mail address as your password.

## **AutoTech Service**

Dell's automated support service—AutoTech—provides recorded answers to the questions most frequently asked by Dell customers about their portable and desktop computers.

When you call AutoTech, use your touch-tone telephone to select the subjects that correspond to your questions. For the telephone number to call for your region, see "Contacting Dell" on page 164.

## **Automated Order-Status Service**

To check on the status of any Dell products that you have ordered, you can go to [support.dell.com](http://support.dell.com), or you can call the automated order-status service. A recording prompts you for the information needed to locate and report on your order. For the telephone number to call for your region, see "Contacting Dell" on page 164.

## **Problems With Your Order**

If you have a problem with your order, such as missing parts, wrong parts, or incorrect billing, contact Dell for customer assistance. Have your invoice or packing slip handy when you call. For the telephone number to call for your region, see "Contacting Dell" on page 164.

## **Product Information**

If you need information about additional products available from Dell, or if you would like to place an order, visit the Dell website at [www.dell.com](http://www.dell.com). For the telephone number to call for your region or to speak to a sales specialist, see "Contacting Dell" on page 164.

## Returning Items for Warranty Repair or Credit

Prepare all items being returned, whether for repair or credit, as follows:

- 1 Call Dell to obtain a Return Material Authorization Number, and write it clearly and prominently on the outside of the box.  
For the telephone number to call for your region, see "Contacting Dell" on page 164.
- 2 Include a copy of the invoice and a letter describing the reason for the return.
- 3 Include a copy of the Diagnostics Checklist (see "Diagnostics Checklist" on page 163), indicating the tests that you have run and any error messages reported by the Dell Diagnostics (see "Dell Diagnostics" on page 87).
- 4 Include any accessories that belong with the item(s) being returned (power cables, software floppy disks, guides, and so on) if the return is for credit.
- 5 Pack the equipment to be returned in the original (or equivalent) packing materials.

You are responsible for paying shipping expenses. You are also responsible for insuring any product returned, and you assume the risk of loss during shipment to Dell. Collect On Delivery (C.O.D.) packages are not accepted.

Returns that are missing any of the preceding requirements will be refused at Dell's receiving dock and returned to you.

## Before You Call



**NOTE:** Have your Express Service Code ready when you call. The code helps Dell's automated-support telephone system direct your call more efficiently. You may also be asked for your Service Tag (located on the back or bottom of your computer).

Remember to fill out the Diagnostics Checklist (see "Diagnostics Checklist" on page 163). If possible, turn on your computer before you call Dell for assistance and call from a telephone at or near the computer. You may be asked to type some commands at the keyboard, relay detailed information during operations, or try other troubleshooting steps possible only at the computer itself. Ensure that the computer documentation is available.



**CAUTION:** Before working inside your computer, follow the safety instructions in your *Product Information Guide*.

## **Diagnostics Checklist**

Name:

Date:

Address:

Phone number:

Service Tag (bar code on the back or bottom of the computer):

Express Service Code:

Return Material Authorization Number (if provided by Dell support technician):

Operating system and version:

Devices:

Expansion cards:

Are you connected to a network? Yes No

Network, version, and network adapter:

Programs and versions:

See your operating system documentation to determine the contents of the system's start-up files. If the computer is connected to a printer, print each file. Otherwise, record the contents of each file before calling Dell.

Error message, beep code, or diagnostic code:

Description of problem and troubleshooting procedures you performed:

## Contacting Dell

 **NOTE:** If you do not have an active Internet connection, you can find contact information on your purchase invoice, packing slip, bill, or Dell product catalog.

Dell provides several online and telephone-based support and service options. Availability varies by country and product, and some services may not be available in your area. To contact Dell for sales, technical support, or customer service issues:

- 1 Visit [support.dell.com](http://support.dell.com).
- 2 Verify your country or region in the **Choose A Country/Region** drop-down menu at the bottom of the page.
- 3 Click **Contact Us** on the left side of the page.
- 4 Select the appropriate service or support link based on your need.
- 5 Choose the method of contacting Dell that is convenient for you.

# Specifications



**NOTE:** Offerings may vary by region. For more information regarding the configuration of your computer, click **Start** , click **Help and Support**, and then select the option to view information about your computer.

---

## Processor

---

Processor type	Intel® Core™2 Duo Celeron®
L1 cache	32 KB per instruction, 32 KB data cache per core
L2 cache	2 MB or 4 MB per core depending on model
External bus frequency	667 MHz and 800 MHz

---

## System Information

---

System chipset	Mobile Intel Express (GM 965 or PM 965)
Data bus width	64 bits
DRAM bus width	dual-channel (2) 64-bit buses
Processor address bus width	32 bits
Flash EPROM	2 MB
Graphics bus	PCI-E X16
PCI bus (PCI-Express used for video controllers)	32 bits x16

---

## ExpressCard

---

**NOTE:** The ExpressCard slot is designed only for ExpressCards. It does NOT support PC Cards.

**NOTE:** PCMCIA may not be available in some regions.

ExpressCard controller	Intel ICH8M
ExpressCard connector	one ExpressCard slot (54 mm)

---

**ExpressCard (continued)**

---

Cards supported	ExpressCard/34 (34 mm) ExpressCard/54 (54 mm) 1.5 V and 3.3 V
ExpressCard connector size	26 pins

---

**8-in-1 Memory Card Reader**

---

8-in-1 memory card controller	Ricoh R5C833
8-in-1 memory card connector	8-in-1 combo card connector
Cards supported	<ul style="list-style-type: none"><li>• Secure Digital (SD)</li><li>• SDIO</li><li>• MultiMediaCard (MMC)</li><li>• Memory Stick</li><li>• Memory Stick PRO</li><li>• xD-Picture Card</li><li>• Hi Speed-SD</li><li>• Hi Density-SD</li></ul>

---

**Memory**

---

Memory module connector	two user-accessible SODIMM connectors
Memory module capacities	512 MB, 1 GB, 2 GB, 4GB
Memory type	667 MHz SoDIMM DDR2
Minimum memory	1 GB
Maximum memory	8 GB

**NOTE:** In order to take advantage of the dual channel bandwidth capability, both memory slots must be populated and must match in size.

**NOTE:** The available memory displayed does not reflect the complete maximum memory installed because some memory is reserved for system files.

---

**Ports and Connectors**

---

Audio	microphone connector, stereo headphone/speakers connector
IEEE 1394	4-pin serial connector
Consumer IR	sensor compatible with Philips RC6 (receive only)
Mini-card	three Type IIIA mini-card slots
HDMI connector	19-pin
Network adapter	RJ-45 port
USB	two 4-pin USB 2.0-compliant connector
Video	15-hole connector

---

**Communications**

---

## Modem:

Type	External V.92 56K USB Modem
Controller	Hardware modem
Interface	Universal Serial Bus
Network adapter	10/100 Ethernet LAN on system board
Wireless	internal WLAN, WWAN, mini-cards WWAN ExpressCard Bluetooth® Wireless Technology

---

**Video**

---

**NOTE:** Optional video controller upgrades are available for your computer subject to availability at the time of purchase. To determine the configuration of your computer, see "Determining Your Computer's Configuration" on page 19.

Video type:	integrated on system board
Video controller	Intel 965 GM
Video memory	up to 384 MB of shared memory
LCD interface	LVDS
TV support	NTSC or PAL in HDMI modes

---

**Video (continued)**

---

Video type:	discrete video card
Data bus	PCI Express X16
Video controller	nVIDIA GeForce 8400M GS
Video memory	128 MB GeForce 8400M GS
LCD interface	LVDS
TV support	HDMI mode

---

**Audio**

---

Audio type	5.1 channel High Definition Audio
Audio controller	Sigmatel STAC9228
Stereo conversion	24-bit (analog-to-digital and digital-to-analog)
Interfaces:	
Internal	Intel High Definition Audio
External	microphone in/line in connector, two stereo headphones/speakers connector
Speaker	two 4-ohm speakers
Internal speaker amplifier	2 Watts per channel into 4 ohms
Volume controls	program menus, media control buttons

---

**Display**

---

Type (TrueLife)	13.3-inch WXGA TrueLife
Dimensions:	
Height	286.08 mm (11.26 in)
Width	178.8 mm (7.03 in)
Diagonal	337.8 mm (13.29 in)
Maximum resolutions:	
WXGA	1280 x 800 at 262 K colors
Refresh rate	60 Hz



---

**Display (continued)**

---

Operating angle	0° (closed) to 140°
Luminance	250 min. 300 typ. cd/m <sup>2</sup> (LED 5 point avg) 200 min. 220 typ. cd/m <sup>2</sup> (CCFL 5 point avg)
Viewing angles:	
Horizontal	±40° (CCFL) min. ±50° (LED) min.
Vertical	+15°/-30° (CCFL) min. +40°/-50° (LED) min.
Pixel pitch:	
WXGA	0.2235 mm
Controls	brightness can be controlled through keyboard shortcuts (see "Adjusting Brightness" on page 47)

---

**Keyboard**

---

Number of keys	86/103 (U.S. and Canada); 87/104 (Europe); 90/107 (Japan)
Layout	QWERTY/AZERTY/Kanji

---

**Touch Pad**

---

XY position resolution (graphics table mode)	240 cpi
Size:	
Width	71.7-mm (2.8-in) sensor-active area
Height	34.0-mm (1.3-in) rectangle

---

**Battery**

---

Type	9-cell "smart" lithium ion 6-cell "smart" lithium ion
Dimensions:	
Depth	67.6 mm (2.66 inches) (9 cell) 47.5 mm (1.87 inches) (6 cell)
Height	20.4 mm (0.8 inch)
Width	209.9 mm (8.26 inches)
Weight	0.48 kg (1.06 lb) (9 cell) 0.33 kg (0.7 lb) (6 cell)
Voltage	11.1 VDC
Charge time (approximate):	
Computer off	4 hours
Operating time	Battery operating time varies depending on operating conditions and can be significantly reduced under certain power-intensive conditions (see "Power Problems" on page 110). See "Using a Battery" on page 49 for more information on battery life.
Life span (approximate)	300 discharge/charge cycles
Temperature range:	
Operating	0° to 35°C (32° to 95°F)
Storage	-40° to 65°C (-40° to 149°F)
Coin-cell battery	CR-2032

---

**AC Adapter**

---

Types	65W (D-Series) 90W (D-Series and E-Series)
Input voltage	100–240 VAC
Input current (maximum)	1.5 A/1.6 A
Input frequency	50–60 Hz
Output current	
65W	3.9 A (maximum at 4-second pulse) 3.34 A (continuous)
90W	5.62 A (maximum at 4-second pulse) 4.62 A (continuous)
Output power	65W or 90W
Rated output voltage	19.5 +/- 1 VDC
Dimensions:	
65W	
Height	29.0 mm (1.14 in) (D-Series)
Width	46.2 mm (1.83 in) (D-Series)
Depth	107.0 mm (4.21 in) (D-Series)
90W	
Height	34.2 mm (1.35 in) (D-Series) 16 mm (0.63 in) (E-Series)
Width	60.9 mm (2.39 in) (D-Series) 70 mm (2.76 in) (E-Series)
Depth	153.42 mm (6.04 in) (D-Series) 147mm (5.79 in) (E-Series)
Weight (with cables)	
65W	0.25 kg (.55 lb) (D-Series)
90W	0.46 kg (1.01 lb) (D-Series) 0.345 kg (0.76 lb) (E-Series)

---

**AC Adapter (continued)**

---

## Temperature range:

Operating	0° to 35°C (32° to 95°F)
Storage	-40° to 65°C (-40° to 149°F)

---

**Physical**

---

Height	44 mm (1.7 in)
Width	394 mm (15.5 in)
Depth	293 mm (11.3 in)
Weight (with 6-cell battery):	
Configurable to less than	3.6 kg (8.0 lb)

---

**Environmental**

---

## Temperature range:

Operating	0° to 35°C (32° to 95°F)
Storage	-40° to 65°C (-40° to 149°F)

## Relative humidity (maximum):

Operating	10% to 90% (noncondensing)
Storage	5% to 95% (noncondensing)

Maximum vibration:<sup>1</sup>

Operating	0.66 GRMS
Storage	1.3 GRMS

Maximum shock:<sup>2</sup>

Operating	142 G
Storage	163 G

## Altitude (maximum):

Operating	-15.2 to 3048 m (-50 to 10,000 ft)
Storage	-15.2 to 10,668 m (-50 to 35,000 ft)

<sup>1</sup> Using a random vibration spectrum that simulates user environment.

<sup>2</sup> Measured with hard drive in operating status and a 2-ms half-sine pulse for operating. Also measured with hard drive in head-parked position and a 2-ms halfsine pluse for storage.

# Appendix

## Dell Technical Support Policy (U.S. Only)

Technician assisted technical support requires the cooperation and participation of the customer in the troubleshooting process and provides for restoration of the operating system, software programs, and hardware drivers to the original default configuration as shipped from Dell, as well as the verification of appropriate functionality of the computer and all Dell-installed hardware. In addition to this technician assisted technical support, online technical support is available at [support.dell.com](http://support.dell.com). Additional technical support options may be available for purchase.

Dell provides limited technical support for the computer and any "Dell-installed" software and peripherals<sup>1</sup>. Support for third-party software and peripherals is provided by the original manufacturer, including those purchased and/or installed through Dell Software and Peripherals, Readyware, and Custom Factory Integration<sup>2</sup>.

- <sup>1</sup> Repair services are provided pursuant to the terms and conditions of your limited warranty and any optional support service contract purchased with the computer.
- <sup>2</sup> All Dell-standard components included in a Custom Factory Integration (CFI) project are covered by the standard Dell limited warranty for your computer. However, Dell also extends a parts replacement program to cover all nonstandard, third-party hardware components integrated through CFI for the duration of the computer's service contract.

### Definition of "Dell-Installed" Software and Peripherals

Dell-installed software includes the operating system and some of the software programs that are installed on the computer during the manufacturing process (Microsoft Office, Norton Antivirus, etc).

Dell-installed peripherals include any internal expansion cards, or Dell-branded module bay or ExpressCard accessories. In addition, any Dell-branded monitors, keyboards, mice, speakers, microphones for telephonic modems, docking stations/port replicators, networking products, and all associated cabling are included.

## Definition of "Third-Party" Software and Peripherals

Third-party software and peripherals include any peripheral, accessory, or software program sold by Dell not under the Dell brand (printers, scanners, cameras, games, etc). Support for all third-party software and peripherals is provided by the original manufacturer of the product.

## FCC Notice (U.S. Only)

### FCC Class B

This equipment generates, uses, and can radiate radio frequency energy and, if not installed and used in accordance with the manufacturer's instruction manual, may cause interference with radio and television reception. This equipment has been tested and found to comply with the limits for a Class B digital device pursuant to Part 15 of the FCC Rules.

This device complies with Part 15 of the FCC Rules. Operation is subject to the following two conditions:

- This device may not cause harmful interference.
- This device must accept any interference received, including interference that may cause undesired operation.



**NOTICE:** The FCC regulations provide that changes or modifications not expressly approved by Dell Inc. could void your authority to operate this equipment.

These limits are designed to provide reasonable protection against harmful interference in a residential installation. However, there is no guarantee that interference will not occur in a particular installation. If this equipment does cause harmful interference with radio or television reception, which can be determined by turning the equipment off and on, you are encouraged to try to correct the interference by one or more of the following measures:

- Reorient the receiving antenna.
- Relocate the system with respect to the receiver.
- Move the system away from the receiver.
- Plug the system into a different outlet so that the system and the receiver are on different branch circuits.

If necessary, consult a representative of Dell Inc. or an experienced radio/television technician for additional suggestions.

The following information is provided on the device or devices covered in this document in compliance with the FCC regulations:

Product name:	Dell™ XPS™ M1330
Model number:	PP25L
Company name:	Dell Inc. Worldwide Regulatory Compliance & Environmental Affairs One Dell Way Round Rock, TX 78682 USA 512-338-4400

## **Macrovision Product Notice**

This product incorporates copy protection technology that is protected by U.S. and foreign patents, including patent numbers 5,315,448 and 6,836,549, and other intellectual property rights. The use of Macrovision's copy protection technology in the product must be authorized by Macrovision. Reverse engineering or disassembly is prohibited.





# Glossary

Terms in this Glossary are provided for informational purposes only and may or may not describe features included with your particular computer.

## A

**AC** — alternating current — The form of electricity that powers your computer when you plug the AC adapter power cable in to an electrical outlet.

**ACPI** — advanced configuration and power interface — A power management specification that enables Microsoft® Windows® operating systems to put a computer in standby or hibernate mode to conserve the amount of electrical power allocated to each device attached to the computer.

**AGP** — accelerated graphics port — A dedicated graphics port that allows system memory to be used for video-related tasks. AGP delivers a smooth, true-color video image because of the faster interface between the video circuitry and the computer memory.

**AHCI** — Advanced Host Controller Interface — An interface for a SATA hard drive Host Controller which allows the storage driver to enable technologies such as Native Command Queuing (NCQ) and hot plug.

**ALS** — ambient light sensor — A feature that helps to control display brightness.

**antivirus software** — A program designed to identify, quarantine, and/or delete viruses from your computer.

**ASF** — alert standards format — A standard to define a mechanism for reporting hardware and software alerts to a management console. ASF is designed to be platform- and operating system-independent.

## B

**battery life span** — The length of time (years) during which a portable computer battery is able to be depleted and recharged.

**battery operating time** — The length of time (minutes or hours) that a portable computer battery powers the computer.

**BIOS** — basic input/output system — A program (or utility) that serves as an interface between the computer hardware and the operating system. Unless you understand what effect these settings have on the computer, do not change them. Also referred to as *system setup*.

**bit** — The smallest unit of data interpreted by your computer.

**Bluetooth® wireless technology** — A wireless technology standard for short-range (9 m [29 feet]) networking devices that allows for enabled devices to automatically recognize each other.

**boot sequence** — Specifies the order of the devices from which the computer attempts to boot.

**bootable CD** — A CD that you can use to start your computer. In case your hard drive is damaged or your computer has a virus, ensure that you always have a bootable CD or floppy disk available. Your *Drivers and Utilities* media is a bootable CD.

**bootable disk** — A disk that you can use to start your computer. In case your hard drive is damaged or your computer has a virus, ensure that you always have a bootable CD or floppy disk available.

**bps** — bits per second — The standard unit for measuring data transmission speed.

**BTU** — British thermal unit — A measurement of heat output.

**bus** — A communication pathway between the components in your computer.

**bus speed** — The speed, given in MHz, that indicates how fast a bus can transfer information.

**byte** — The basic data unit used by your computer. A byte is usually equal to 8 bits.

## C

**C** — Celsius — A temperature measurement scale where 0° is the freezing point and 100° is the boiling point of water.

**cache** — A special high-speed storage mechanism which can be either a reserved section of main memory or an independent high-speed storage device. The cache enhances the efficiency of many processor operations.

**L1 cache** — Primary cache stored inside the processor.

**L2 cache** — Secondary cache which can either be external to the processor or incorporated into the processor architecture.

**carnet** — An international customs document that facilitates temporary imports into foreign countries. Also known as a *merchandise passport*.

**CD-R** — CD recordable — A recordable version of a CD. Data can be recorded only once onto a CD-R. Once recorded, the data cannot be erased or written over.

**CD-RW** — CD rewritable — A rewritable version of a CD. Data can be written to a CD-RW disc, and then erased and written over (rewritten).

**CD-RW drive** — A drive that can read CDs and write to CD-RW (rewritable CDs) and CD-R (recordable CDs) discs. You can write to CD-RW discs multiple times, but you can write to CD-R discs only once.

**CD-RW/DVD drive** — A drive, sometimes referred to as a combo drive, that can read CDs and DVDs and write to CD-RW (rewritable CDs) and CD-R (recordable CDs) discs. You can write to CD-RW discs multiple times, but you can write to CD-R discs only once.

**clock speed** — The speed, given in MHz, that indicates how fast computer components that are connected to the system bus operate.

**CMOS** — A type of electronic circuit. Computers use a small amount of battery-powered CMOS memory to hold date, time, and system setup options.

**COA** — Certificate of Authenticity — The Windows alpha-numeric code located on a sticker on your computer. Also referred to as the *Product Key* or *Product ID*.

**Consumer IR**— infrared sensor for Dell Travel Remote.

**Control Panel** — A Windows utility that allows you to modify operating system and hardware settings, such as display settings.

**controller** — A chip that controls the transfer of data between the processor and memory or between the processor and devices.

**CRIMM** — continuity rambus in-line memory module — A special module that has no memory chips and is used to fill unused RIMM slots.

**cursor** — The marker on a display or screen that shows where the next keyboard, touch pad, or mouse action will occur. It often is a blinking solid line, an underline character, or a small arrow.

## D

**DDR SDRAM** — double-data-rate SDRAM — A type of SDRAM that doubles the data burst cycle, improving system performance.

**DDR2 SDRAM** — double-data-rate 2 SDRAM — A type of DDR SDRAM that uses a 4-bit prefetch and other architectural changes to boost memory speed to over 400 MHz.

**device** — Hardware such as a disk drive, printer, or keyboard that is installed in or connected to your computer.

**device driver** — See *driver*.

**DIMM** — dual in-line memory module — A circuit board with memory chips that connects to a memory module on the system board.

**DIN connector** — A round, six-pin connector that conforms to DIN (Deutsche Industrie-Norm) standards; it is typically used to connect PS/2 keyboard or mouse cable connectors.

**disk striping** — A technique for spreading data over multiple disk drives. Disk striping can speed up operations that retrieve data from disk storage. Computers that use disk striping generally allow the user to select the data unit size or stripe width.

**DMA** — direct memory access — A channel that allows certain types of data transfer between RAM and a device to bypass the processor.

**docking device** — See *APR*.

**DMTF** — Distributed Management Task Force — A consortium of hardware and software companies who develop management standards for distributed desktop, network, enterprise, and Internet environments.

**domain** — A group of computers, programs, and devices on a network that are administered as a unit with common rules and procedures for use by a specific group of users. A user logs on to the domain to gain access to the resources.

**DRAM** — dynamic random-access memory — Memory that stores information in integrated circuits containing capacitors.

**driver** — Software that allows the operating system to control a device such as a printer. Many devices do not work properly if the correct driver is not installed in the computer.

**DSL** — Digital Subscriber Line — A technology that provides a constant, high-speed Internet connection through an analog telephone line.

**dual-core** — An Intel® technology in which two physical computational units exist inside a single processor package, thereby increasing computing efficiency and multi-tasking ability.

**dual display mode** — A display setting that allows you to use a second monitor as an extension of your display. Also referred to as *extended display mode*.

**DVD-R** — DVD recordable — A recordable version of a DVD. Data can be recorded only once onto a DVD-R. Once recorded, the data cannot be erased or written over.

**DVD+RW** — DVD rewritable — A rewritable version of a DVD. Data can be written to a DVD+RW disc, and then erased and written over (rewritten). (DVD+RW technology is different from DVD-RW technology.)

**DVD+RW drive** — drive that can read DVDs and most CD media and write to DVD+RW (rewritable DVDs) discs.

**DVI** — digital video interface — A standard for digital transmission between a computer and a digital video display.

## E

**ECC** — error checking and correction — A type of memory that includes special circuitry for testing the accuracy of data as it passes in and out of memory.

**ECP** — extended capabilities port — A parallel connector design that provides improved bidirectional data transmission. Similar to EPP, ECP uses direct memory access to transfer data and often improves performance.

**EIDE** — enhanced integrated device electronics — An improved version of the IDE interface for hard drives and CD drives.

**EMI** — electromagnetic interference — Electrical interference caused by electromagnetic radiation.

**ENERGY STAR®** — Environmental Protection Agency requirements that decrease the overall consumption of electricity.

**EPP** — enhanced parallel port — A parallel connector design that provides bidirectional data transmission.

**ESD** — electrostatic discharge — A rapid discharge of static electricity. ESD can damage integrated circuits found in computer and communications equipment.

**expansion card** — A circuit board that installs in an expansion slot on the system board in some computers, expanding the capabilities of the computer. Examples include video, modem, and sound cards.

**expansion slot** — A connector on the system board (in some computers) where you insert an expansion card, connecting it to the system bus.

**ExpressCard** — A removable I/O card adhering to the PCMCIA standard. Modems and network adapters are common types of ExpressCards. ExpressCards support both the PCI Express and USB 2.0 standard.

**Express Service Code** — A numeric code located on a sticker on your Dell™ computer. Use the Express Service Code when contacting Dell for assistance. Express Service Code service may not be available in some countries.

**extended display mode** — A display setting that allows you to use a second monitor as an extension of your display. Also referred to as *dual display mode*.

**extended PC Card** — A PC Card that extends beyond the edge of the PC Card slot when installed.

## F

**Fahrenheit** — A temperature measurement scale where 32° is the freezing point and 212° is the boiling point of water.

**FBD** — fully-buffered DIMM — A DIMM with DDR2 DRAM chips and an Advanced Memory Buffer (AMB) that speeds communication between the DDR2 SDRAM chips and the system.

**FCC** — Federal Communications Commission — A U.S. agency responsible for enforcing communications-related regulations that state how much radiation computers and other electronic equipment can emit.

**fingerprint reader** — A strip sensor that uses your unique fingerprint to authenticate your user identity to help secure your computer.

**folder** — A term used to describe space on a disk or drive where files are organized and grouped. Files in a folder can be viewed and ordered in various ways, such as alphabetically, by date, and by size.

**format** — The process that prepares a drive or disk for file storage. When a drive or disk is formatted, the existing information on it is lost.

**FSB** — front side bus — The data path and physical interface between the processor and RAM.

**FTP** — file transfer protocol — A standard Internet protocol used to exchange files between computers connected to the Internet.

## G

**G** — gravity — A measurement of weight and force.

**GB** — gigabyte — A measurement of data storage that equals 1024 MB (1,073,741,824 bytes). When used to refer to hard drive storage, the term is often rounded to 1,000,000,000 bytes.

**GHz** — gigahertz — A measurement of frequency that equals one thousand million Hz, or one thousand MHz. The speeds for computer processors, buses, and interfaces are often measured in GHz.

**graphics mode** — A video mode that can be defined as  $x$  horizontal pixels by  $y$  vertical pixels by  $z$  colors. Graphics modes can display an unlimited variety of shapes and fonts.

**GUI** — graphical user interface — Software that interacts with the user by means of menus, windows, and icons. Most programs that operate on the Windows operating systems are GUIs.

## H

**hard drive** — A drive that reads and writes data on a hard disk. The terms hard drive and hard disk are often used interchangeably.

**heat sink** — A metal plate on some processors that helps dissipate heat.

**hibernate mode** — A power management mode that saves everything in memory to a reserved space on the hard drive and then turns off the computer. When you restart the computer, the memory information that was saved to the hard drive is automatically restored.

**HDMI** — The High-Definition Multimedia Interface (HDMI) is an all-digital audio/video interface capable of transmitting uncompressed streams.

**HTTP** — hypertext transfer protocol — A protocol for exchanging files between computers connected to the Internet.

**Hyper-Threading** — Hyper-Threading is an Intel technology that can enhance overall computer performance by allowing one physical processor to function as two logical processors, capable of performing certain tasks simultaneously.

**Hz** — hertz — A unit of frequency measurement that equals 1 cycle per second. Computers and electronic devices are often measured in kilohertz (kHz), megahertz (MHz), gigahertz (GHz), or terahertz (THz).

## I

**IC** — integrated circuit — A semiconductor wafer, or chip, on which thousands or millions of tiny electronic components are fabricated for use in computer, audio, and video equipment.

**IDE** — integrated device electronics — An interface for mass storage devices in which the controller is integrated into the hard drive or CD drive.

**IEEE 1394** — Institute of Electrical and Electronics Engineers, Inc. — A high-performance serial bus used to connect IEEE 1394-compatible devices, such as digital cameras and DVD drives, to the computer.

**infrared sensor** — A port that allows you to transfer data between the computer and infrared-compatible devices without using a cable connection.

**integrated** — Usually refers to components that are physically located on the computer's system board. Also referred to as *built-in*.

**I/O** — input/output — An operation or device that enters and extracts data from your computer. Keyboards and printers are I/O devices.

**I/O address** — An address in RAM that is associated with a specific device (such as a serial connector, parallel connector, or expansion slot) and allows the processor to communicate with that device.

**IrDA** — Infrared Data Association — The organization that creates international standards for infrared communications.

**IRQ** — interrupt request — An electronic pathway assigned to a specific device so that the device can communicate with the processor. Each device connection must be assigned an IRQ. Although two devices can share the same IRQ assignment, you cannot operate both devices simultaneously.

**ISP** — Internet service provider — A company that allows you to access its host server to connect directly to the Internet, send and receive e-mail, and access websites. The ISP typically provides you with a software package, user name, and access phone numbers for a fee.

## K

**Kb** — kilobit — A unit of data that equals 1024 bits. A measurement of the capacity of memory integrated circuits.

**KB** — kilobyte — A unit of data that equals 1024 bytes but is often referred to as 1000 bytes.

**key combination** — A command requiring you to press multiple keys at the same time.

**kHz** — kilohertz — A measurement of frequency that equals 1000 Hz.

## L

**LAN** — local area network — A computer network covering a small area. A LAN usually is confined to a building or a few nearby buildings. A LAN can be connected to another LAN over any distance through telephone lines and radio waves to form a wide area network (WAN).

**LCD** — liquid crystal display — The technology used by portable computer and flat-panel displays.

**LED** — light-emitting diode — An electronic component that emits light to indicate the status of the computer.

**local bus** — A data bus that provides a fast throughput for devices to the processor.

**LPT** — line print terminal — The designation for a parallel connection to a printer or other parallel device.



## M

**Mb** — megabit — A measurement of memory chip capacity that equals 1024 Kb.

**Mbps** — megabits per second — One million bits per second. This measurement is typically used for transmission speeds for networks and modems.

**MB** — megabyte — A measurement of data storage that equals 1,048,576 bytes. 1 MB equals 1024 KB. When used to refer to hard drive storage, the term is often rounded to 1,000,000 bytes.

**MB/sec** — megabytes per second — One million bytes per second. This measurement is typically used for data transfer ratings.

**media bay** — A bay that supports devices such as optical drives, a second battery, or a Dell TravelLite™ module.

**memory** — A temporary data storage area inside your computer. Because the data in memory is not permanent, it is recommended that you frequently save your files while you are working on them, and always save your files before you shut down the computer. Your computer can contain several different forms of memory, such as RAM, ROM, and video memory. Frequently, the word memory is used as a synonym for RAM.

**memory address** — A specific location where data is temporarily stored in RAM.

**memory mapping** — The process by which the computer assigns memory addresses to physical locations at start-up. Devices and software can then identify information that the processor can access.

**memory module** — A small circuit board containing memory chips, which connects to the system board.

**MHz** — megahertz — A measure of frequency that equals 1 million cycles per second. The speeds for computer processors, buses, and interfaces are often measured in MHz.

**Mini PCI** — A standard for integrated peripheral devices with an emphasis on communications such as modems and NICs. A Mini PCI card is a small external card that is functionally equivalent to a standard PCI expansion card.

**Mini-card** — A small card designed for integrated peripherals, such as communication NICs. The mini-card is functionally equivalent to a standard PCI expansion card.

**Mobile Broadband network** — (also known as a WWAN) is a series of interconnected computers that communicate with each other through wireless cellular technology and provides Internet access in the same varied locations from which cellular telephone service is available. Your computer can maintain the Mobile Broadband network connection regardless of its physical location, as long as the computer remains in the service area of your cellular service provider.

**modem** — A device that allows your computer to communicate with other computers over analog telephone lines. Three types of modems include: external, PC Card, and internal. You typically use your modem to connect to the Internet and exchange e-mail.

**module bay** — See *media bay*.

**MP** — megapixel — A measure of image resolution used for digital cameras.

**ms** — millisecond — A measure of time that equals one thousandth of a second. Access times of storage devices are often measured in ms.

## N

**network adapter** — A chip that provides network capabilities. A computer may include a network adapter on its system board, or it may contain a PC Card with an adapter on it. A network adapter is also referred to as a *NIC* (network interface controller).

**NIC** — See *network adapter*.

**notification area** — The section of the Windows taskbar that contains icons for providing quick access to programs and computer functions, such as the clock, volume control, and print status. Also referred to as *system tray*.

**ns** — nanosecond — A measure of time that equals one billionth of a second.

**NVRAM** — nonvolatile random access memory — A type of memory that stores data when the computer is turned off or loses its external power source. NVRAM is used for maintaining computer configuration information such as date, time, and other system setup options that you can set.

## O

**optical drive** — A drive that uses optical technology to read or write data from CDs, DVDs, or DVD+RWs. Example of optical drives include CD drives, DVD drives, CD-RW drives, and CD-RW/DVD combo drives.

## P

**parallel connector** — An I/O port often used to connect a parallel printer to your computer. Also referred to as an *LPT port*.

**partition** — A physical storage area on a hard drive that is assigned to one or more logical storage areas known as logical drives. Each partition can contain multiple logical drives.

**PC Card** — A removable I/O card adhering to the PCMCIA standard. Modems and network adapters are common types of PC Cards.

**PCI** — peripheral component interconnect — PCI is a local bus that supports 32- and 64-bit data paths, providing a high-speed data path between the processor and devices such as video, drives, and networks.

**PCI Express** — A modification to the PCI interface that boosts the data transfer rate between the processor and the devices attached to it. PCI Express can transfer data at speeds from 250 MB/sec to 4 GB/sec. If the PCI Express chip set and the device are capable of different speeds, they will operate at the slower speed.

**PCMCIA** — Personal Computer Memory Card International Association — The organization that establishes standards for PC Cards.

**PIO** — programmed input/output — A method of transferring data between two devices through the processor as part of the data path.

**pixel** — A single point on a display screen. Pixels are arranged in rows and columns to create an image. A video resolution, such as 800 x 600, is expressed as the number of pixels across by the number of pixels up and down.

**Plug-and-Play** — The ability of the computer to automatically configure devices. Plug and Play provides automatic installation, configuration, and compatibility with existing hardware if the BIOS, operating system, and all devices are Plug and Play compliant.

**POST** — power-on self-test — Diagnostics programs, loaded automatically by the BIOS, that perform basic tests on the major computer components, such as memory, hard drives, and video. If no problems are detected during POST, the computer continues the start-up.

**processor** — A computer chip that interprets and executes program instructions. Sometimes the processor is referred to as the CPU (central processing unit).

**PS/2** — personal system/2 — A type of connector for attaching a PS/2-compatible keyboard, mouse, or keypad.

**PXE** — pre-boot execution environment — A WfM (Wired for Management) standard that allows networked computers that do not have an operating system to be configured and started remotely.

## R

**RAID** — redundant array of independent disks — A method of providing data redundancy. Some common implementations of RAID include RAID 0, RAID 1, RAID 5, RAID 10, and RAID 50.

**RAM** — random-access memory — The primary temporary storage area for program instructions and data. Any information stored in RAM is lost when you shut down your computer.

**readme file** — A text file included with a software package or hardware product. Typically, readme files provide installation information and describe new product enhancements or corrections that have not yet been documented.

**read-only** — Data and/or files you can view but cannot edit or delete. A file can have read-only status if:

- It resides on a physically write-protected floppy disk, CD, or DVD.
- It is located on a network in a directory and the system administrator has assigned rights only to specific individuals.

**refresh rate** — The frequency, measured in Hz, at which your screen's horizontal lines are recharged (sometimes also referred to as its *vertical frequency*). The higher the refresh rate, the less video flicker can be seen by the human eye.

**resolution** — The sharpness and clarity of an image produced by a printer or displayed on a monitor. The higher the resolution, the sharper the image.

**RFI** — radio frequency interference — Interference that is generated at typical radio frequencies, in the range of 10 kHz to 100,000 MHz. Radio frequencies are at the lower end of the electromagnetic frequency spectrum and are more likely to have interference than the higher frequency radiations, such as infrared and light.

**ROM** — read-only memory — Memory that stores data and programs that cannot be deleted or written to by the computer. ROM, unlike RAM, retains its contents after you shut down your computer. Some programs essential to the operation of your computer reside in ROM.

**RPM** — revolutions per minute — The number of rotations that occur per minute. Hard drive speed is often measured in rpm.

**RTC** — real time clock — Battery-powered clock on the system board that keeps the date and time after you shut down the computer.

**RTCST** — real-time clock reset — A jumper on the system board of some computers that can often be used for troubleshooting problems.

## S

**SAS** — serial attached SCSI — A faster, serial version of the SCSI interface (as opposed to the original SCSI parallel architecture).

**SATA** — serial ATA — A faster, serial version of the ATA (IDE) interface.

**ScanDisk** — A Microsoft utility that checks files, folders, and the hard disk's surface for errors. ScanDisk often runs when you restart the computer after it has stopped responding.

**SCSI** — small computer system interface — A high-speed interface used to connect devices to a computer, such as hard drives, CD drives, printers, and scanners. The SCSI can connect many devices using a single controller. Each device is accessed by an individual identification number on the SCSI controller bus.

**SDRAM** — synchronous dynamic random-access memory — A type of DRAM that is synchronized with the optimal clock speed of the processor.

**serial connector** — An I/O port often used to connect devices such as a handheld digital device or digital camera to your computer.

**Service Tag** — A bar code label on your computer that identifies your computer when you access Dell Support at [support.dell.com](http://support.dell.com) or when you call Dell for customer service or technical support.

**setup program** — A program that is used to install and configure hardware and software. The **setup.exe** or **install.exe** program comes with most Windows software packages. *Setup program* differs from *system setup*.

**shortcut** — An icon that provides quick access to frequently used programs, files, folders, and drives. When you place a shortcut on your Windows desktop and double-click the icon, you can open its corresponding folder or file without having to find it first. Shortcut icons do not change the location of files. If you delete a shortcut, the original file is not affected. Also, you can rename a shortcut icon.

**SIM** — Subscriber Identity Module — A SIM card contains a microchip that encrypts voice and data transmissions. SIM cards can be used in phones or portable computers.

**smart card** — A card that is embedded with a processor and a memory chip. Smart cards can be used to authenticate a user on computers equipped for smart cards.

**S/PDIF** — Sony/Philips Digital Interface — An audio transfer file format that allows the transfer of audio from one file to another without converting it to and from an analog format, which could degrade the quality of the file.

**standby mode** — A power management mode that shuts down all unnecessary computer operations to save energy.

**Strike Zone™** — Reinforced area of the platform base that protects the hard drive by acting as a dampening device when a computer experiences resonating shock or is dropped (whether the computer is on or off).

**surge protectors** — Prevent voltage spikes, such as those that may occur during an electrical storm, from entering the computer through the electrical outlet. Surge protectors do not protect against lightning strikes or against brownouts, which occur when the voltage drops more than 20 percent below the normal AC-line voltage level.

Network connections cannot be protected by surge protectors. Always disconnect the network cable from the network connector during electrical storms.

**SVGA** — super-video graphics array — A video standard for video cards and controllers. Typical SVGA resolutions are 800 x 600 and 1024 x 768.

The number of colors and resolution that a program displays depends on the capabilities of the monitor, the video controller and its drivers, and the amount of video memory installed in the computer.

**S-video TV-out** — A connector used to attach a TV or digital audio device to the computer.

**SXGA** — super-extended graphics array — A video standard for video cards and controllers that supports resolutions up to 1280 x 1024.

**SXGA+** — super-extended graphics array plus — A video standard for video cards and controllers that supports resolutions up to 1400 x 1050.

**system board** — The main circuit board in your computer. Also known as the *motherboard*.

**system setup** — A utility that serves as an interface between the computer hardware and the operating system. System setup allows you to configure user-selectable options in the BIOS, such as date and time or system password. Unless you understand what effect the settings have on the computer, do not change the settings for this program.

## T

**TAPI** — telephony application programming interface — Enables Windows programs to operate with a wide variety of telephony devices, including voice, data, fax, and video.

**text editor** — A program used to create and edit files that contain only text; for example, Windows Notepad uses a text editor. Text editors do not usually provide word wrap or formatting functionality (the option to underline, change fonts, and so on).

**TPM** — trusted platform module — A hardware-based security feature that when combined with security software enhances network and computer security by enabling features such as file and e-mail protection.

**travel module** — A plastic device designed to fit inside the module bay of a portable computer to reduce the weight of the computer.

## U

**UAC** — user account control— Microsoft Windows® Vista™ security feature that, when enabled, provides an added layer of security between user accounts and access to operating system settings.

**UMA** — unified memory allocation — System memory dynamically allocated to video.

**UPS** — uninterruptible power supply — A backup power source used when the electrical power fails or drops to an unacceptable voltage level. A UPS keeps a computer running for a limited amount of time when there is no electrical power. UPS systems typically provide surge suppression and may also provide voltage regulation. Small UPS systems provide battery power for a few minutes to enable you to shut down your computer.

**USB** — universal serial bus — A hardware interface for a low-speed device such as a USB-compatible keyboard, mouse, joystick, scanner, set of speakers, printer, broadband devices (DSL and cable modems), imaging devices, or storage devices. Devices are plugged directly in to a 4-pin socket on your computer or in to a multi-port hub that plugs in to your computer. USB devices can be connected and disconnected while the computer is turned on, and they can also be daisy-chained together.

**UTP** — unshielded twisted pair — Describes a type of cable used in most telephone networks and some computer networks. Pairs of unshielded wires are twisted to protect against electromagnetic interference, rather than relying on a metal sheath around each pair of wires to protect against interference.

**UXGA** — ultra extended graphics array — A video standard for video cards and controllers that supports resolutions up to 1600 x 1200.

## V

**video controller** — The circuitry on a video card or on the system board (in computers with an integrated video controller) that provides the video capabilities—in combination with the monitor—for your computer.

**video memory** — Memory that consists of memory chips dedicated to video functions. Video memory is usually faster than system memory. The amount of video memory installed primarily influences the number of colors that a program can display.

**video mode** — A mode that describes how text and graphics are displayed on a monitor. Graphics-based software, such as Windows operating systems, displays in video modes that can be defined as  $x$  horizontal pixels by  $y$  vertical pixels by  $z$  colors. Character-based software, such as text editors, displays in video modes that can be defined as  $x$  columns by  $y$  rows of characters.

**video resolution** — See *resolution*.

**virus** — A program that is designed to inconvenience you or to destroy data stored on your computer. A virus program moves from one computer to another through an infected disk, software downloaded from the Internet, or e-mail attachments. When an infected program starts, its embedded virus also starts.

A common type of virus is a boot virus, which is stored in the boot sectors of a floppy disk. If the floppy disk is left in the drive when the computer is shut down and then turned on, the computer is infected when it reads the boot sectors of the floppy disk expecting to find the operating system. If the computer is infected, the boot virus may replicate itself onto all the floppy disks that are read or written in that computer until the virus is eradicated.

**V** — volt — The measurement of electric potential or electromotive force. One V appears across a resistance of 1 ohm when a current of 1 ampere flows through that resistance.

## W

**W** — watt — The measurement of electrical power. One W is 1 ampere of current flowing at 1 volt.

**Whr** — watt-hour — A unit of measure commonly used to indicate the approximate capacity of a battery. For example, a 66-Whr battery can supply 66 W of power for 1 hour or 33 W for 2 hours.

**wallpaper** — The background pattern or picture on the Windows desktop. Change your wallpaper through the Windows Control Panel. You can also scan in your favorite picture and make it wallpaper.

**WLAN** — wireless local area network. A series of interconnected computers that communicate with each other over the air waves using access points or wireless routers to provide Internet access.

**write-protected** — Files or media that cannot be changed. Use write-protection when you want to protect data from being changed or destroyed. To write-protect a 3.5-inch floppy disk, slide its write-protect tab to the open position.

**WPAN** — wireless personal area network. A computer network used for communication among computer devices (including telephones and personal digital assistants) close to one person.

**WWAN** — wireless wide area network. A wireless high-speed data network using cellular technology and covering a much larger geographic area than WLAN. Also known as Mobile Broadband network.

**WXGA** — wide-aspect extended graphics array — A video standard for video cards and controllers that supports resolutions up to 1280 x 800.



## X

**XGA** — extended graphics array — A video standard for video cards and controllers that supports resolutions up to 1024 x 768.

## Z

**ZIF** — zero insertion force — A type of socket or connector that allows a computer chip to be installed or removed with no stress applied to either the chip or its socket.

**Zip** — A popular data compression format. Files that have been compressed with the Zip format are called Zip files and usually have a filename extension of **.zip**. A special kind of zipped file is a self-extracting file, which has a filename extension of **.exe**. You can unzip a self-extracting file by double-clicking it.

**Zip drive** — A high-capacity floppy drive developed by Iomega Corporation that uses 3.5-inch removable disks called Zip disks. Zip disks are slightly larger than regular floppy disks, about twice as thick, and hold up to 100 MB of data.



# Index

## Numerics

8-in-1 memory card reader, 71

## A

audio. *See sound*

## B

battery

- charge gauge, 51
- charging, 53
- checking the charge, 50
- performance, 49
- power meter, 51
- removing, 54
- replacing coin-cell battery, 152
- storing, 55

blanks

- ExpressCards, 67, 71
- removing, 69, 72

Bluetooth wireless technology  
card

- device status light, 24
- installing, 151

boot sequence, 38

brightness

- adjusting, 47

## C

carnet, 158

CD

- about, 60
- CD-RW drive problems, 95
- drive problems, 95

Check Disk, 96

cleaning

- display, 40
- keyboard, 40
- media, 42
- mouse, 41
- touch pad, 41

coin-cell battery

- replacing, 152

computer

- crashes, 105-106
- restore to previous operating state, 121
- slow performance, 97, 107
- specifications, 165
- stops responding, 105

connecting

- Mobile Broadband network, 78

contacting Dell, 164

copying CDs

- general information, 60
- helpful tips, 61
- how to, 60

- copying DVDs
  - general information, 60
  - helpful tips, 61
  - how to, 60

## D

- Dell
  - contacting, 164
- Dell Diagnostics
  - about, 87
  - starting from the Drivers and Utilities media, 89
  - starting from your hard drive, 88
- Dell MediaDirect
  - about, 23
  - problems, 106
- Dell support site, 16
- DellConnect, 160
- Device Driver Rollback, 117
- device latch release
  - description, 29
- device status lights
  - description, 23
- diagnostics
  - Dell, 87
- display
  - adjusting brightness, 47
  - adjusting the size of icons, 155
  - adjusting the size of toolbars, 155
  - description, 21
  - resolution, 47
  - switching the video image, 47

- documentation
  - End User License Agreement, 14
  - ergonomics, 14
  - online, 16
  - Product Information Guide, 14
  - regulatory, 14
  - safety, 14
  - warranty, 14

- drivers
  - about, 116
  - identifying, 117
  - reinstalling, 117

- Drivers and Utilities media, 13
  - about, 118
  - Dell Diagnostics, 87

- drives
  - problems, 94
  - See also *hard drive*
  - See also *optical drive*

- DVD
  - about, 60
  - drive problems, 95

## E

- End User License Agreement, 14
- ergonomics information, 14
- error messages, 98
- ExpressCard slot
  - description, 27

ExpressCards, 67  
  blanks, 67, 69, 71  
  installing, 68  
  removing, 69

## F

FCM. See *Flash Cache Module*  
Flash Cache Module, 150

## H

hard drive  
  problems, 96  
  replacing, 129  
  returning to Dell, 131

hardware  
  Dell Diagnostics, 87

Hardware Troubleshooter, 119

hinge cover  
  removing, 132

## I

icons  
  adjusting the size, 155

IEEE 1394 connector  
  description, 26  
  problems, 103

installing, 145

Internet connection  
  about, 31  
  options, 31  
  setting up, 32

## K

keyboard  
  numeric keypad, 43  
  problems, 104  
  removing, 135  
  shortcuts, 43

keypad  
  numeric, 43

## L

labels  
  Microsoft Windows, 15  
  Service Tag, 15

lost computer, 85

## M

media  
  playing, 57  
media control buttons  
  Dell MediaDirect button, 63  
  description, 21

memory  
  DIMM A, 139  
  DIMM B, 140  
  installing, 137  
  removing, 138

memory card, 71  
  blanks, 72  
  installing, 71  
  reader, 22  
  removing, 72  
  types, 71

memory card reader, 71

memory module cover  
description, 30

messages  
error, 98

Mini-Card  
installing, 144

Mobile Broadband  
network connections, 78  
problems, 108  
See also *wireless switch*

modem connector  
description, 29

monitor. See *display*

## N

network  
installing WLAN Mini-Card, 144  
Mobile Broadband  
(WWAN), 108  
problems, 108  
QuickSet, 155

network connector  
description, 26

## O

operating system  
reinstalling Windows Vista, 121

## P

phone numbers, 164

power  
line conditioners, 35  
problems, 110  
protection devices, 35  
surge protectors, 35  
UPS, 35

power button  
description, 23

power light  
conditions, 110

power management  
adjusting settings, 155  
QuickSet, 155

printer  
cable, 34  
connecting, 33  
problems, 111  
setting up, 33  
USB, 34

problems  
blue screen, 106  
CD drive, 95  
CD-RW drive, 95  
computer crashes, 105-106  
computer does not start up, 105  
computer stops responding, 105  
Dell Diagnostics, 87  
Dell MediaDirect, 106  
drives, 94  
DVD drive, 95  
error messages, 98

- hard drive, 96
- IEEE 1394 connector, 103
- keyboard, 104
- lockups, 105
- network, 108
- power, 110
- power light conditions, 110
- printer, 111
- program crashes repeatedly, 106
- program stops responding, 106
- programs and Windows compatibility, 106
- restore computer to previous operating state, 121
- restore operating system to previous state, 120
- scanner, 112
- slow computer performance, 97, 107
- software, 105-107
- sound and speakers, 112
- speakers, 112
- spyware, 97, 107
- video and monitor

Product Information Guide, 14

## **Q**

- QuickSet, 155
- QuickSet Help, 17

## **R**

- RAM. See *memory*
- regulatory information, 14

- reinstalling
  - Windows Vista, 121
- resolution
  - setting, 47

## **S**

- safety instructions, 14
- scanner
  - problems, 112
- screen. See *display*
- security cable slot
  - description, 27
- Service Tag, 15
- SIM. See *Subscriber Identity Module*
- software
  - problems, 106-107
- software and hardware incompatibilities, 119
- sound
  - problems, 112
  - volume, 112
- speakers
  - problems, 112
  - volume, 112
- specifications, 165
- spyware, 97, 107
- stolen computer, 85
- Subscriber Identity Module, 144

- support
  - contacting Dell, 164
- support website, 16
- System Restore, 120-121
- system setup program
  - commonly used options, 38
  - screens, 38
  - viewing, 38

## T

- taskbar
  - QuickSet icon, 155
- telephone numbers, 164
- toolbars
  - adjusting the size, 155
- touch pad, 45
  - cleaning, 41
  - customizing, 46
- touch pad buttons
  - description, 22
- track stick/touch pad buttons
  - description, 23
- transferring information to a new computer, 33
- traveling with the computer
  - by air, 158
  - identification tag, 157
  - packing, 157
  - tips, 158

- troubleshooting
  - Dell Diagnostics, 87
  - Hardware Troubleshooter, 119
  - restore computer to previous operating state, 120-121

## U

- uninterruptible power supply.  
See *UPS*
- UPS, 35

## V

- video
  - problems, 114
- video controller
  - determining configuration, 19
- video controller configuration
  - determining what controller is installed, 19
- volume
  - adjusting, 113

## W

- warranty information, 14
- Windows
  - Device Driver Rollback, 117
- Windows Easy Transfer wizard, 33



- Windows Vista
  - Program Compatibility wizard, 106
  - reinstalling, 121
  - System Restore, 120-121
  - Windows Easy Transfer wizard, 33
- wireless
  - turning activity on and off, 155
- wizards
  - Program Compatibility wizard, 106
  - Windows Easy Transfer, 33
- WLAN, 145
  - installing Mini-Card, 144
- WWAN
  - installing, 147
  - See *Mobile Broadband*



## Free Manuals Download Website

<http://myh66.com>

<http://usermanuals.us>

<http://www.somanuals.com>

<http://www.4manuals.cc>

<http://www.manual-lib.com>

<http://www.404manual.com>

<http://www.luxmanual.com>

<http://aubethermostatmanual.com>

Golf course search by state

<http://golfingnear.com>

Email search by domain

<http://emailbydomain.com>

Auto manuals search

<http://auto.somanuals.com>

TV manuals search

<http://tv.somanuals.com>