

Kodak EasyShare CX6330 zoom digital camera



User's Guide

www.kodak.com

For interactive tutorials, www.kodak.com/go/howto

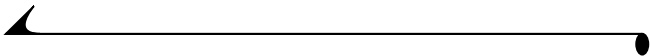

Eastman Kodak Company
343 State Street
Rochester, New York 14650
© Eastman Kodak Company, 2003
Kodak and EasyShare are trademarks of Eastman Kodak Company.
P/N 6B8451



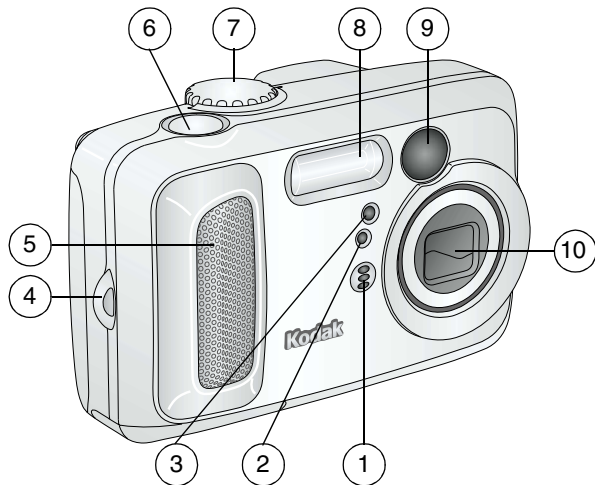

Front View

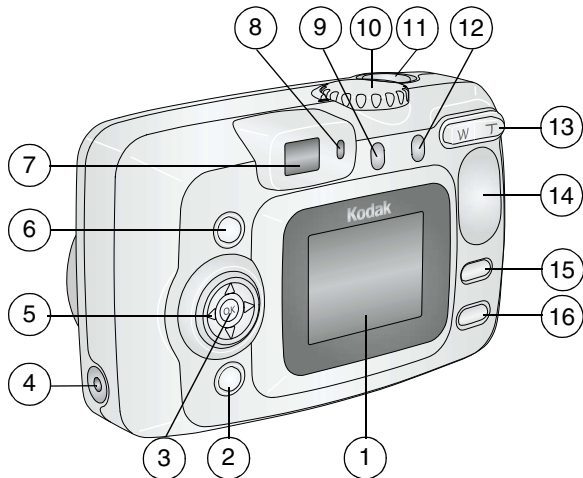

- | | | | |
|---|------------------------|----|----------------|
| 1 | Microphone | 6 | Shutter button |
| 2 | Light sensor | 7 | Mode dial |
| 3 | Self Timer/Video light | 8 | Flash unit |
| 4 | Wrist strap post | 9 | Viewfinder |
| 5 | Grip | 10 | Lens |

Back View



- | | | | |
|---|--|----|---|
| 1 | Camera screen (LCD) | 9 | Self Timer/Burst button  |
| 2 | Share button (page 47) | 10 | Mode dial/Off (page 13 , page 6) |
| 3 | OK button (press) | 11 | Shutter button |
| 4 | DC-In (3V)  , for optional AC adapter | 12 | Flash button  |
| 5 | 4-way controller  | 13 | Zoom (Wide Angle/Telephoto) |
| 6 | Delete button | 14 | Grip |
| 7 | Viewfinder | 15 | Menu button |
| 8 | Ready light | 16 | Review button |

Side Views

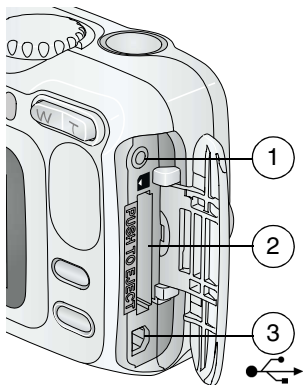

Left Side

- 1 A/V Out, for television viewing
- 2 Slot for **optional** MMC/SD card
- 3 USB Port 

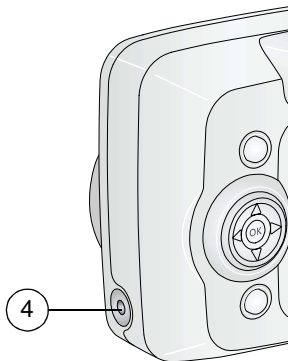

Right Side

- 4 DC-In (3V) ,
for **optional** AC adapter

Top and Bottom Views

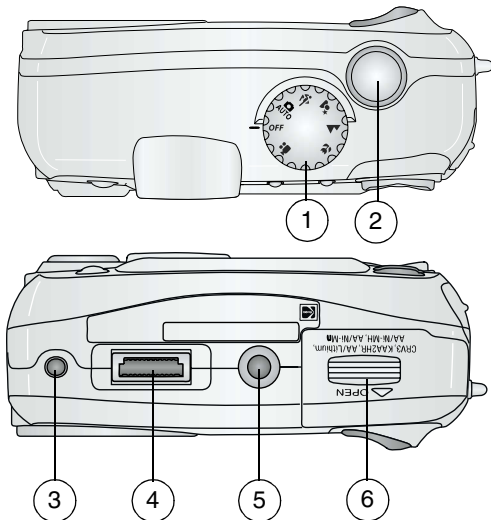

Top

- 1 Mode dial
- 2 Shutter button

Bottom

- 3 Locator, dock 6000
- 4 Dock connector
- 5 Tripod socket/locator, dock 6000
- 6 Battery door

Table of Contents

1	Getting Started	1
	Install Software First.....	1
	Need This User Guide in Larger Print?	1
	What Can I Do With My Camera?.....	2
	What Can I Do With My Pictures and Videos?.....	2
	Package Contents.....	3
	Loading the Batteries	4
	Attaching the Wrist Strap	5
	Turning On the Camera.....	6
	Setting the Date and Time	7
	Checking Camera Status.....	8
	Camera Screen Icons	9
	Inserting an MMC/SD Card	10
	Choosing Internal Memory or MMC/SD Card.....	11
2	Taking Pictures	13
	Take a Picture	13
	Picture-Taking Modes	14
	Liveview—Framing with the Camera Screen.....	15
	Quickview—Reviewing the Picture Just Taken	17
	Using the Optical Zoom	18
	Using the Advanced Digital Zoom.....	18
	Using the Flash.....	19
	Putting Yourself in the Picture.....	21

Taking a Burst Series of Pictures	22
Changing Optional Settings	23
Setting Exposure Compensation	24
Setting Picture Quality.....	25
Setting Color Mode	26
Pre-tagging for Album Names	27
Placing the Date on Pictures	28
Setting the Orientation Sensor.....	29
3 Taking Videos	31
Taking a Video.....	31
Quickview—Reviewing the Video Just Taken.....	32
Using the Optical Zoom.....	33
Changing Optional Video Settings	33
Pre-tagging for Album Names	34
Putting Yourself in the Video	35
4 Reviewing Pictures and Videos	37
Viewing Single Pictures and Videos	37
Viewing Multiple Pictures and Videos.....	38
Playing a Video	38
Deleting Pictures and Videos	39
Changing Optional Review Settings.....	40
Magnifying Pictures	40
Protecting Pictures and Videos From Deletion	41
Tagging Pictures/Videos for Albums	41
Running a Slide Show.....	43

Copying Pictures and Videos.....	45
Displaying Video Date.....	46
Viewing Picture/Video Information.....	46
5 Sharing Pictures and Videos	47
When Can I Tag My Pictures and Videos?.....	47
Tagging Pictures for Printing.....	48
Tagging Pictures and Videos for Emailing.....	49
Tagging Pictures and Videos as Favorites	50
Need Help?	50
6 Customizing Your Camera Settings	51
To Access Setup Mode/Menus	51
Setup Menus.....	51
Changing the Default Print Quantity	52
Turning Off Quickview.....	52
Turning On Liveview in Still Modes	53
Changing Advanced Digital Zoom	54
Setting Video Out.....	55
Selecting a Language.....	55
Formatting Internal Memory or MMC/SD Card	56
Viewing Camera Information.....	56
7 Installing the Software	57
Windows System Requirements	57
Mac OS X System Requirements	58
Mac OS 8.6 and 9.x System Requirements.....	58

Install the Software.....	59
8 Connecting Camera to Computer	61
Transferring Pictures With the USB Cable	61
Printing Pictures From Your Computer	62
Printing From an Optional MMC/SD Card	62
Print With or Without a Computer.....	62
9 Using the Camera Dock 6000	63
Camera Dock 6000 Package Contents	63
Installing the Custom Camera Insert.....	64
Connecting the Camera Dock 6000.....	65
Installing the Rechargeable Battery.....	66
Docking the Camera	67
Charging the Battery	68
Transferring Pictures With the Dock	69
Reviewing Pictures and Videos.....	70
Camera Dock 6000 Specifications	70
Troubleshooting—Camera Dock 6000	71
Earlier Cameras and Docks	71
10 Troubleshooting	73
Camera Problems	73
Camera/Computer Communications	78
MMC/SD Cards and Internal Memory	79
Camera Screen Messages	80
Camera Ready Light Status	84

11	Getting Help	87
	Helpful Links	87
	Help in this Manual	87
	Software Help	88
	Telephone Customer Support	88
12	Appendix	91
	Camera Specifications.....	91
	Original Factory Settings	93
	Upgrading Your Software and Firmware	94
	Tips, Safety, Maintenance	94
	Storage Capacities.....	95
	Locating Pictures and Videos on a Card.....	96
	Picture Naming Conventions	96
	Using the Batteries	97
	Power-Saving Features.....	99
	Optional AC Adapter	99
	FCC Compliance and Advisory.....	100

1 Getting Started

Install Software First

Install the software from the Kodak EasyShare software CD **before** connecting the camera (or camera dock) to the computer. Failure to do so may cause the software to load incorrectly.

See the Quick Start Guide or [Installing the Software, page 57](#).

Need This User Guide in Larger Print?

- 1 Go to www.kodak.com/go/cx6330support.
- 2 Choose your language.
- 3 Navigate to the *CX6330 - Manuals* section.
- 4 Click *View as PDF* to open the User's Guide.
- 5 On a Windows-based computer or Mac OS 8.6 or 9.x:
 - From the File menu, select Print.
 - In the Print window, select Fit to Page.
- 6 On Mac OS X:
 - From the File menu, select Page Setup.
 - Change Scale to 200%.
- 7 Print as usual.

What Can I Do With My Camera?

Capture Still Pictures —Use Auto mode to enjoy point-and-shoot operation. Use Sport, Night, Landscape, and Close-up modes to expand your capabilities.

Capture Videos with Sound —Capture videos as QuickTime movies.

Review —Display, protect, and delete pictures and videos; tag for albums.

Share —Share pictures (print, email, save as Favorites) and videos (email, save as Favorites).

Set Up —Customize your camera functions (see [page 51](#)).

What Can I Do With My Pictures and Videos?

Install the software from the Kodak EasyShare software CD, then:

Transfer—Transfer pictures and videos to your computer.

Share—Print pictures, order prints online, email pictures and videos.

Print—(see [page 62](#)) Print pictures directly to your home printer or Kodak EasyShare printer dock 6000. Order prints online from Ofoto, a Kodak Company (www.ofoto.com). Or purchase an optional Kodak multimedia card (MMC) or a secure digital (SD) card and:

- Automatically print to any printer with an MMC/SD slot
- Make prints at an MMC/SD-capable Kodak picture maker kiosk www.kodak.com/go/picturemaker
- Take the card to your local photo retailer for professional printing

Organize—Use Favorites to organize and retrieve pictures on a computer.

Edit—Add special effects to your pictures, make a custom slide show, fix red-eye, crop, rotate, and much more.

For details, click the Help button in the Kodak EasyShare software. Some Mac operating systems may support limited Kodak EasyShare software features.

Package Contents

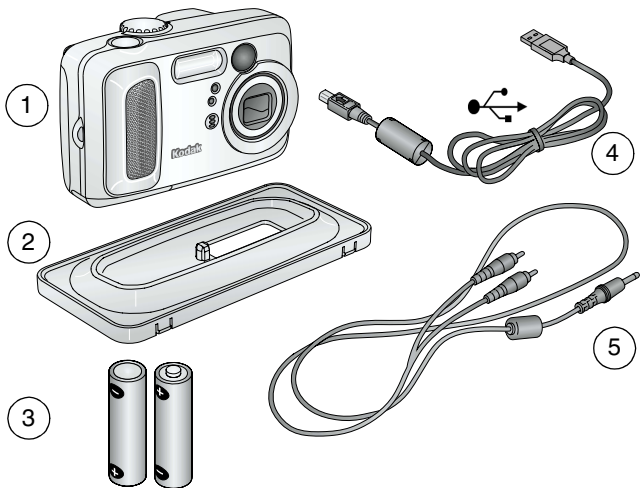

- 1 Camera
- 2 Custom dock insert (for camera dock 6000 or printer dock 6000)
- 3 Kodak Max digital camera batteries (2 AA, non-rechargeable)
- 4 USB cable
- 5 Audio/Video cable (for viewing pictures and videos on television)

Not shown: User's Guide, Quick Start Guide, wrist strap, Kodak EasyShare software CD. (In some countries, the User's Guide is provided on a CD. Contents may change without notice.)

Loading the Batteries

Two AA batteries (non-rechargeable) are included with your camera.

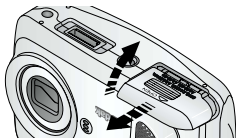

- 1 Turn the Mode dial to Off.
- 2 On the bottom of the camera, slide the battery door and lift to open.

AA

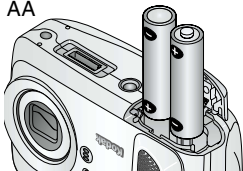

- 3 Insert the AA batteries as shown.
- 4 Close the battery door.

IMPORTANT BATTERY INFORMATION

For acceptable battery life and to make sure your camera operates dependably, do not use alkaline batteries.

If you purchased an optional Kodak CRV3 lithium battery, insert it as shown.

CRV3
(optional)

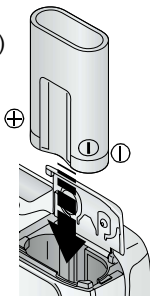

If you purchased the Kodak EasyShare camera dock 6000, see [page 66](#) for details on installing the included Kodak EasyShare Ni-MH rechargeable battery.

See [page 97](#) for the other types of batteries you can use in your camera.

Attaching the Wrist Strap

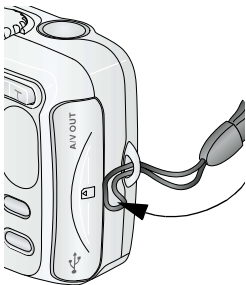

- 1 Thread the short loop of the wrist strap through the wrist strap post.
- 2 Thread the long loop through the short loop.



- 3 Pull until secure.

Turning On the Camera

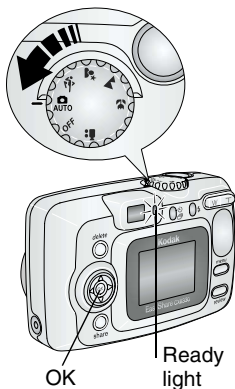

Turn the Mode dial from Off to any other position.

The ready light blinks green while the camera performs a self-check, then glows green when the camera is ready to take pictures (or videos, if the mode dial is set to ).

In Still and Video modes, status icons appear on the camera screen. See [Checking Camera Status, page 8](#).

Changing the Display

If you want to	Then do this
Turn the camera screen on (enter Liveview) or off.	Press the OK button.
Change the Liveview setting so that it is on whenever the camera is on.	See Turning On Liveview in Still Modes, page 53 .
Redisplay the status icons.	Press  .
Turn off the camera.	Turn the Mode dial to Off. <i>The camera completes operations that are in process.</i>

Setting the Date and Time

Setting the Date & Time, First Time

The *Date and Time have been reset* message appears the first time you turn on the camera or if the battery is removed for an extended time.



OK

- 1 SET DATE & TIME is highlighted. Press the OK button.

(Select Cancel to set the date and time at a later time.)

The Date & Time screen appears.

- 2 Go to step 4 below, [Setting the Date & Time, Anytime](#).

Setting the Date & Time, Anytime



▲/▼ OK

Menu

- 1 Turn on the camera. Press the Menu button.
- 2 Press ▲/▼ to highlight Setup Menu, then press the OK button.
- 3 Press ▲/▼ to highlight Date & Time, then press the OK button.

The date format is YYYY/MM/DD. The time is displayed in a 24-hour format.

- 4 Press ▲/▼ to adjust the date and time. Press ◀/▶ to advance to the next setting.
- 5 When finished, press the OK button.
- 6 Press the Menu button to exit the menu.

The setting remains until you change it.

NOTE: Depending on your computer operating system, Kodak EasyShare software may let your computer update the camera clock when you connect the camera. See the EasyShare software Help for details.

Checking Camera Status





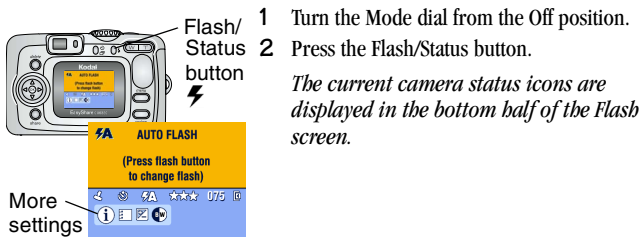
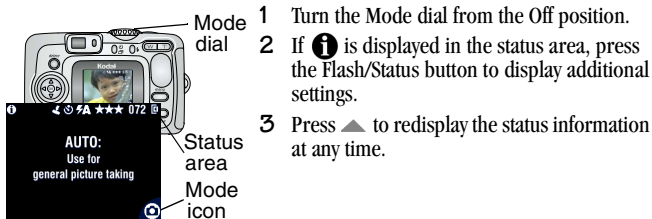



















The icons that appear on the camera screen indicate the active camera and picture settings. See [page 9](#) for a list of the icons.

To check the current camera settings:



Camera Screen Icons

These icons appear on your camera screen when the settings are active.

Capture Modes (found on Mode dial*)		Camera/Picture Status	
 Video	 Print	Quality Icons ★★★ Best ★★★ Best (3:2) ★★ Better ★ Good	
 Auto	 Email  Favorite		
 Sport	 Self Timer		
 Night	 Burst	Storage/Picture location  Internal memory  Memory Card	
 Landscape	 Flash (see page 19)	Battery power  Low  Exhausted	
 Close-up	ALBUM+ Album name	 072 Pictures remaining	
	 Date stamp	 Digital zoom	
	 Protect		
 Custom (You changed Exposure Compensation, Color Mode, or assigned an Album. Press  to see which setting you changed.)			
 Exposure Compensation	 Album	 Color mode	

* For Capture mode descriptions, see [page 14](#).

Inserting an MMC/SD Card

Your camera has 16 MB of internal memory. However, optional MMC/SD cards provide removable, reusable storage for pictures and videos.



CAUTION:

The card can only be inserted one way; forcing it may damage the camera or card.

Do not insert or remove a card when the green ready light is blinking; doing so may damage your pictures, card, or camera.

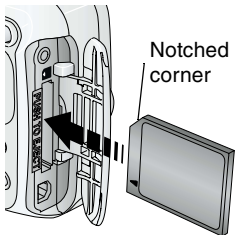

To insert an MMC/SD card:

- 1 Turn off the camera.
- 2 Open the card door until it clicks.
- 3 Orient the card as shown on the card door.
- 4 Push the card into the slot to seat the connector.
- 5 Close the door.

To remove the card, push it in, then release it. When the card is partially ejected, pull it out.

See [page 95](#) for storage capacities. Purchase MMC/SD cards at a dealer of Kodak products or www.kodak.com/go/cx6330accessories.

Choosing Internal Memory or MMC/SD Card

The camera offers two options for storing pictures and videos:



Internal Memory  —Store pictures and videos in 16 MB internal memory.

MMC/SD Card  —Store pictures and videos on a card. The number/length of pictures/videos depends on the size of the card. Purchase accessories at a dealer of Kodak products or www.kodak.com/go/cx6330accessories. For storage capacities, see [page 95](#).

Managing Your Storage Location Setting

- 1 Turn on the camera.
- 2 Press the Menu button.
- 3 Press / to highlight Image Storage , then press the OK button.



- 4 Press / to highlight an option, then press the OK button:

AUTO (default)—the camera uses the card if one is in the camera. If not, the camera uses internal memory.

INTERNAL MEMORY—the camera always uses internal memory, even if a card is installed.

- 5 Highlight Continue, then press the OK button again.

The setting remains until you change it and applies to all camera functions.



- 6 Press the Menu button to exit the menu.

Checking Your Storage Setting

In **Still and Video modes**, the storage location icon that appears in the status area indicates the camera's storage location. To check the location, either:

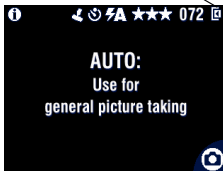
Storage location



- Turn the Mode dial from the Off position, or
- In any capture mode, press ▲ .
 -  —Memory Card
 -  —Internal Memory



Checking a Picture or Video's Location

In **Review mode**, the storage location icon that appears with a picture indicates the location of the picture or video.

Picture/video location



Press the Review button.

-  —Picture or video is stored on a card
-  —Picture or video is stored in internal memory

2 Taking Pictures

The camera is ready to take pictures anytime it is on—even if you are in Review, Share, or Setup. (In Video mode, the camera captures video.) Before you take a picture, make sure the storage location is set the way you want it (see [page 11](#)).

Take a Picture

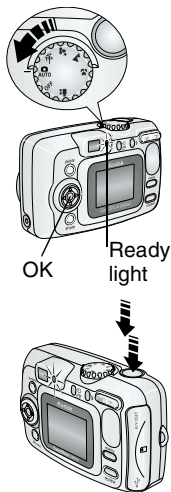

- 1 Turn the Mode dial to the mode you want to use. See [page 14](#) for a description of the picture-taking modes.

The camera screen displays the mode name and description. To interrupt the description, press any button.

- 2 Use the viewfinder or camera screen to frame your subject. (Press the OK button to turn Liveview on. See [page 15](#).)
- 3 Press the Shutter button **half-way** to set the exposure and focus.
- 4 When the ready light glows green, continue pressing the Shutter button **completely down** to take the picture.

When the ready light blinks green, the picture is being saved; you can still take pictures. If the ready light is red, wait until it turns green.





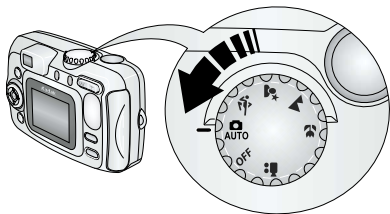

See [Flash Settings in Each Mode, page 20](#).

See [Changing Optional Settings, page 23](#).

Picture-Taking Modes

For the best possible pictures, choose the mode that suits your conditions.



Use this mode	For
 Auto	General picture-taking. Automatically sets exposure, focus, and flash.
 Sport	Subjects that are in motion. Shutter speed is fast.
 Night	Night scenes or low-light conditions. Place the camera on a flat, steady surface or use a tripod. Due to slow shutter speeds, advise people to stay still for a few seconds after flash fires.
 Landscape	Distant subjects. Flash does not fire unless you turn it on. Auto focus framing marks (page 16) are not available in Landscape.
 Close-up	Close subjects 5.1-27.6 in. (13-70 cm) from the lens in Wide Angle; 8.7-27.6 in. (22-70 cm) in Telephoto. Use available light instead of flash if possible. Use the camera screen to frame the subject.
 Video	Capture video with sound. See Taking Videos, page 31 .

Liveview—Framing with the Camera Screen

When you turn on Liveview, the camera screen displays a live image of what the lens sees. Use the camera screen to frame your subject.

IMPORTANT: *Liveview quickly depletes battery power; use it sparingly.*

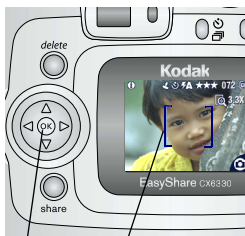

OK

Framing marks

- 1 Turn the Mode dial to any On position.
- 2 Press the OK button to turn on Liveview.
- 3 Frame your subject in the camera screen.
To use the auto focus framing marks, see [page 16](#).
- 4 Press the Shutter button **half-way and bold** to set the exposure and focus, then press **the rest of the way down** to take the picture.
- 5 To turn off Liveview, press the OK button.



NOTE: If Quality is set to Best (3:2), the Liveview image is displayed at a 3:2 aspect ratio, as shown, with a black bar at the top of the screen.







To change the Liveview setting so that it is on whenever the camera is on, see [page 53](#).

Using the Auto Focus Framing Marks

In Liveview, the framing marks indicate the area of your scene that the camera is focusing on. For the best possible pictures, the camera attempts to focus on foreground subjects, even if the subjects are not centered in the scene.

- 1 Press the OK button to turn on Liveview.
- 2 Press the Shutter button *half-way and bold*.
- 3 The framing marks are displayed. When they turn red, focus is accomplished.

While the Shutter Button is Pressed Half-way:

	 Center focus
<p>Framing marks</p>	 Center wide focus
	 Side focus
	 Center and side focus
	 Left and right focus

- 4 Press the Shutter button *the rest of the way down* to take the picture.
- 5 If the camera is not focusing on the desired subject (or if the framing marks disappear), release your finger, recompose the scene, and repeat Steps 2 and 3.

NOTE: Framing marks appear only when Liveview is on.
Framing marks do not appear in Landscape mode.

Quickview—Reviewing the Picture Just Taken

After you take a picture, the camera screen displays a Quickview of that picture for approximately 5 seconds. While the picture is displayed, you can:



- **Review it:** If you take no action, the picture is saved.
- **Share it:** Press the Share button to tag the picture for print, email, or as a Favorite (see [page 47](#)).
- **Delete it:** Press the Delete button while the picture and  are displayed. Follow the prompts to delete the picture.

NOTE: Only the final picture of a burst series (see [page 22](#)) is displayed during Quickview. If you select Delete, all pictures in the burst series are deleted. To delete selectively, do so in Review (see [page 39](#)).

You can turn the Quickview feature on or off (see [page 52](#)).

Using the Optical Zoom

Use Optical Zoom to get up to 3X closer to your subject. Optical zoom is effective when the lens is no closer than 23.6 in. (60 cm) to the subject. When you turn on the camera, the lens extends to the Wide Angle position.

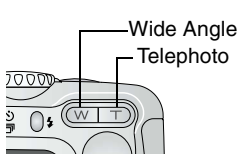

- 1 Use the viewfinder or camera screen to frame your subject.
- 2 Press Telephoto (T) to zoom in. Press Wide Angle (W) to zoom out.

The lens extends or retracts. The viewfinder or camera screen displays the zoomed image.

- 3 Press the Shutter button **half-way and hold** to set the exposure and focus, then press **the rest of the way down** to take the picture.

NOTE: The lens retracts when the camera is turned off.

Using the Advanced Digital Zoom

Use Advanced Digital Zoom to get an additional 3.3X magnification beyond Optical Zoom. Combined zoom settings are from 3.3X to 10X in 0.3 increments. You must turn Liveview on to activate Advanced Digital Zoom.

IMPORTANT: *You may notice a decrease in printed image quality when using Digital Zoom.*

- 1 Press the OK button to turn on Liveview.
- 2 Press the Telephoto (T) button to the Optical Zoom limit. Release the button, then press it again.

The camera screen displays the zoomed image and the magnification

 10.0X.

- 3 Press the Shutter button **half-way and hold** to set the exposure and focus, then **the rest of the way down** to take the picture.

NOTE: You can change the way the digital zoom is turned on. See [page 54](#).

Using the Flash

Use the flash when you take pictures at night, indoors, or outdoors in heavy shadows. You can change the flash setting in any Still mode; the default flash setting is restored when you exit the mode or turn off the camera.

	Flash Range
Wide Angle	2-11.8 ft (0.6-3.6 m)
Telephoto	2-6.9 ft (0.6-2.1 m)

Turning On the Flash

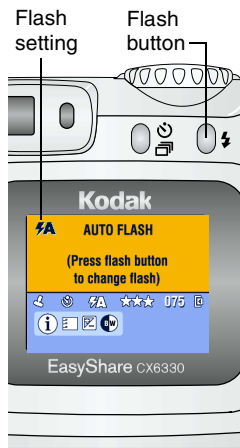

Press the  button repeatedly to scroll through the flash options.

The active flash icon is displayed in the camera screen status area (page 8).



Auto Flash—flash fires when the lighting conditions require it.



Off—flash never fires.









Fill—flash fires every time you take a picture, regardless of the lighting conditions.



Red-eye—flash fires once so the subject's eyes become accustomed to the flash, then fires again when the picture is taken. (If the lighting conditions require flash but do not require Red-eye reduction, the flash may fire only once.)

Flash Settings in Each Mode

For the best possible pictures, flash settings are pre-set for each capture mode.

Icon	Capture Mode	Default Flash Setting	Available Flash Settings (press the Flash button to change)	To Return to the Default Flash Setting:
	Auto	Auto*	Auto, Flash Off, Fill Flash, Red-eye	Exit the mode or turn off the camera.
	Sport	Auto		
	Night	Auto*		
	Landscape	Off		
	Close-up	Off		
	Video	Off	None	Flash cannot be turned on.
	Burst	Off		

* When you change to Red-eye in these modes, it remains until you change it or turn off the camera.

Putting Yourself in the Picture

The Self Timer creates a 10-second delay between the time you press the Shutter button and the time the picture is taken.

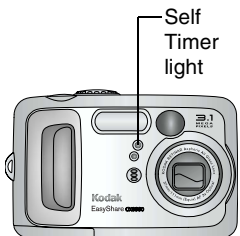
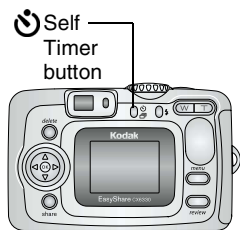

- 1 Place the camera on a flat surface or use a tripod.
- 2 In any Still mode, press the Self Timer button.

The Self Timer icon  appears in the status area.

- 3 Compose the scene. Then press the Shutter button **half-way and bold** to set the exposure and focus, then press **the rest of the way down**. Move so that you are in the scene.

The Self Timer light blinks slowly for 8 seconds (then quickly for 2 seconds) before the picture is taken.

The Self Timer turns off after you take the picture or if you change modes.

To cancel the Self Timer before the picture is taken, press the Self Timer button. (The Self Timer setting remains active.)

To turn off the Self Timer, press the Self Timer button twice.

Taking a Burst Series of Pictures

Burst lets you to take up to 4 pictures in quick succession (approximately 3 frames per second). Burst is ideal for capturing sporting events or objects in motion. Flash and Self Timer are disabled when you use Burst.

Turn On Burst



In any Still mode, press the Self Timer/Burst button **twice**.

The Burst icon  appears in the status area.

NOTE: The setting remains until you change it or turn off the camera.

Take the Pictures

- 1 Press the Shutter button **half-way and hold** to set the auto-focus and exposure for all the pictures in the sequence.
- 2 Press the Shutter button **the rest of the way down and hold it** to take the pictures.







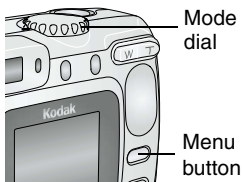







The camera takes up to 4 pictures in quick succession. It stops taking pictures when the Shutter button is released, when 4 pictures are taken, or when there is no more storage space.

Exposure, focus, white balance, and orientation are set for the first picture and applied to all 4 pictures.

Changing Optional Settings



Press the Menu button to access optional picture-taking settings. Not all menu options are available in all modes.

Menu Options Available	Picture Taking Modes			
	Video 	Auto  Sport  Night 	Landscape 	Close-up 
 Image Storage (page 11)	●	●	●	●
 Exposure Comp. (page 24)		●	●	●
 Picture Quality (page 25)		●	●	●
 Color Mode (page 26)		●	●	●
 Album (page 27)	●	●	●	●
 Date Stamp (page 28)		●	●	●
 Orientation Sensor (page 29)		●	●	●
 Setup Menu (page 51)	●	●	●	●

Setting Exposure Compensation

Use Exposure Compensation to control how much light enters the camera. This setting is useful for taking pictures in high-contrast scenes, or for retaking pictures when you are not satisfied with the brightness.

Adjust the exposure by plus or minus 2 steps in 1/2-step increments.

- 1 In any Still mode, press the Menu button.
- 2 Press $\blacktriangle/\blacktriangledown$ to highlight Exposure Compensation , then press the OK button.

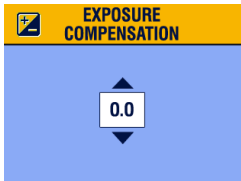

- 3 Press $\blacktriangle/\blacktriangledown$ to select the Exposure Compensation setting.
 - If pictures are too light, decrease the value.
 - If pictures are too dark, increase the value.
- 4 Press the OK button to accept the change.
- 5 Press the Menu button to exit the menu.
- 6 Use the camera screen to frame your subject. Press the Shutter button **half-way and hold** to set the focus, then **press the rest of the way down** to take the picture.

This setting remains until you change the Mode dial or turn off the camera.

Setting Picture Quality

Use the Quality setting to select a picture resolution.

1 In any Still mode, press the Menu button.



2 Press \blacktriangle / \blacktriangledown to highlight Quality \star , then press the OK button.

3 Highlight an option:

Best $\star\star\star$ (3.1 MP)—for printing up to 11 x 14 in. (28 x 36 cm); pictures are highest resolution and largest file size.

$\star\star\star$ *appears in the status area.*

Best (3:2) $\star\star\star$ (2.8 MP)—for printing up to 11 x 14 in. (28 x 36 cm); ideal for printing to the Kodak EasyShare printer dock 6000 and other printing solutions (see [page 62](#)); optimal setting for 4 x 6 in. (10 x 15 cm) prints.

$\star\star\star$ *appears in the status area.*

Better $\star\star$ (2.1 MP)—for printing up to 8 x 10 in. (20 x 25 cm); pictures are medium resolution with smaller file size.

$\star\star$ *appears in the status area.*

Good \star (1.1 MP)—for emailing, Internet, or screen display; pictures are lowest resolution and smallest file size.

\star *appears in the status area.*

4 Press the OK button.

5 Press the Menu button to exit the menu.

This setting remains until you change it.

Setting Color Mode

Use Color Mode to choose color tones.

NOTE: Once a picture is taken, its color mode cannot be changed on the camera.

- 1 In any Still mode, press the Menu button.
- 2 Press $\blacktriangle/\blacktriangledown$ to highlight Color Mode , then press the OK button.



- 3 Press $\blacktriangle/\blacktriangledown$ to highlight an option, then press the OK button.

Color (default)—for color pictures.

Black & White—for black and white pictures.

Sepia—for pictures with a reddish-brown, antique look.

- 4 Press the Menu button to exit the menu.

This setting remains until you change the Mode dial or turn off the camera.

Pre-tagging for Album Names

Use the Set Album (Still) feature to pre-select album names before you take pictures. Then, all the pictures you take are tagged with those album names.

First—On Your Computer

Use Kodak EasyShare software, V 3.0 or higher, to create album names on your computer. Then copy up to 32 album names to the camera's address book the next time you connect the camera to the computer. See Kodak EasyShare software Help for details.

Second—On Your Camera



- 1 In any Still mode, press the Menu button.
- 2 Press $\blacktriangle/\blacktriangledown$ to highlight Album , then press the OK button.
- 3 Press $\blacktriangle/\blacktriangledown$ to highlight an album name, then press the OK button. Repeat to add pictures to more than one album.

Selected albums are noted with a check mark.



- 4 To remove a selection, highlight an album name and press the OK button. To remove all album selections, select Clear All.
- 5 Highlight Exit, then press the OK button.
Your selections are saved. If you turn on Liveview, your album selection is displayed on the screen. A plus (+) after the album name means more than one album is selected.
- 6 Press the Menu button to exit the menu.

Third—Transfer to Your Computer

When you transfer the tagged pictures to your computer, the Kodak EasyShare software opens and categorizes your pictures in the appropriate album folder. See the Kodak EasyShare software Help for details.

Placing the Date on Pictures

Use the Date Stamp setting to imprint the date on your pictures.

- 1 Make sure the camera clock is set to the correct date ([page 7](#)).
- 2 In any Still mode, press the Menu button.
- 3 Press $\blacktriangle/\blacktriangledown$ to highlight Date Stamp , then press the OK button.
- 4 Press $\blacktriangle/\blacktriangledown$ to highlight an option, then press the OK button.
- 5 Press the Menu button to exit the menu.

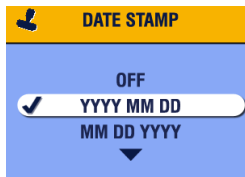

The current date is printed in the bottom right corner of new pictures. This setting remains until you change it.

Setting the Orientation Sensor

If you rotate the camera to take a picture (for example, a portrait shot), the Orientation Sensor reorients the picture so that it is displayed correct side up. The Orientation Sensor is turned on as the default. You can turn it off so that pictures are not rotated.

NOTE: When your subject is above or below you (such as pictures of an object in the sky, on the ground, or when pointing down at small objects on a table), **turn off the Orientation Sensor** so that pictures are not rotated unnecessarily.

- 1 In any Still mode, press the Menu button.
- 2 Press $\blacktriangle/\blacktriangledown$ to highlight Orientation Sensor , then press the OK button.

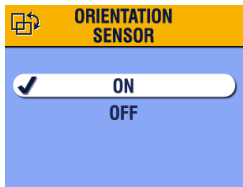

- 3 Press $\blacktriangle/\blacktriangledown$ to highlight On or Off, then press the OK button.
- 4 Press the Menu button to exit the menu.

This setting remains until you change it.

3 Taking Videos

Use Video mode  to take videos or to customize video-taking settings. Before taking a video, make sure your storage location is set the way you want it (see [page 11](#)).

NOTE: Flash is not available in Video mode. Change Optical Zoom before (but not during) video recording. Sound is captured by the microphone, but is played back only when the video is transferred to a computer or when the camera is connected to a television (see [page 44](#)).

Taking a Video

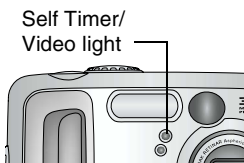

- 1 Turn the Mode dial to Video .
A live image, camera status, and the recording time available appear on the camera screen.
- 2 Use the viewfinder or camera screen to frame your subject.
- 3 To begin recording, press the Shutter button completely down and release within 2 seconds.

The Ready light blinks green, REC appears on the camera screen, and the Self Timer/Video light stays on.

- 4 To stop recording, press the Shutter button again.

Recording stops if storage is full. See [page 95](#) for storage capacities.

NOTE: If you prefer, press the Shutter button completely down **and bold it** for more than 2 seconds to begin recording. To stop recording, release the Shutter button.

Quickview—Reviewing the Video Just Taken

After you take a video, the camera screen displays the first frame of the video for approximately 5 seconds. While the frame is displayed, you can:



OK

- **Play it:** Press the OK button. Press OK again to pause the video. If the camera is connected to a television (see page 55), press ▲/▼ to adjust the volume.
- **Share it:** Press the Share button to tag the video for email or as a Favorite (see page 47).
- **Delete it:** Press the Delete button while the video and  are displayed. Follow the prompts to delete the video.

You can turn off the Quickview feature (see page 52). When Quickview is turned off, the video is not displayed on the camera screen after you take it.

Using the Optical Zoom

Use Optical Zoom to get up to 3X closer to your subject. Optical zoom is effective when the lens is no closer than 23.6 in. (60 cm) to the subject. When you turn on the camera, the lens extends to the Wide Angle position.

NOTE: You can change Optical Zoom before (but not during) video recording.

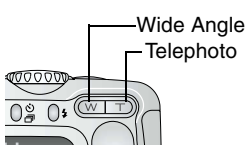



- 1 Use the viewfinder or camera screen to frame your subject.
- 2 Press Telephoto (T) to zoom in. Press Wide Angle (W) to zoom out.

The lens extends or retracts. The viewfinder or camera screen displays the zoomed image.

- 3 Press the Shutter button to take the video.

Changing Optional Video Settings

In Video mode, press the Menu button to access optional video-taking settings.

	Image Storage (page 11)
	Album (page 34)
	Setup Menu (page 51)

Pre-tagging for Album Names



Use the Set Album (Video) feature to pre-select album names before you take videos. Then, all the videos you take are tagged with those album names.

First—On Your Computer

Use Kodak EasyShare software, V 3.0 or higher, to create album names on your computer. Then copy up to 32 album names to the camera's address book the next time you connect the camera to the computer. See Kodak EasyShare software Help for details.

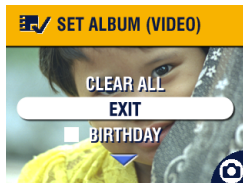
Second—On Your Camera



- 1 In Video mode, press the Menu button.
- 2 Highlight Album , then press the OK button.
- 3 Press / to highlight an album name, then press the OK button. Repeat to add videos to more than one album.

Selected albums are noted with a check mark.

- 4 To remove a selection, highlight an album name and press the OK button. To remove all album selections, select Clear All.
- 5 Highlight Exit, then press the OK button.

Your selections are saved. If you turn on Liveview, your album selection is displayed on the screen. A plus (+) after the album name means more than one album is selected.

- 6 Press the Menu button to exit the menu.

Third—Transfer to Your Computer

When you transfer the tagged videos to your computer, the Kodak EasyShare software opens and categorizes your videos in the appropriate album folder. See the Kodak EasyShare software Help for details.

Putting Yourself in the Video

The Self Timer creates a 10-second delay between the time you press the Shutter button and the time video recording begins.

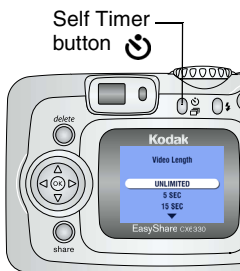

- 1 Place the camera on a flat surface or use a tripod.
- 2 Turn the Mode dial to Video , then press the Self Timer button.
- 3 Press \blacktriangle / \blacktriangledown to highlight a Video Length option, then press the OK button:

Unlimited—records until you stop recording or until storage is full.

Seconds—records for the specified time or until storage is full.

NOTE: If the current storage location does not have adequate space, some video length options are not displayed. (See [page 95](#) for video storage capacities.)

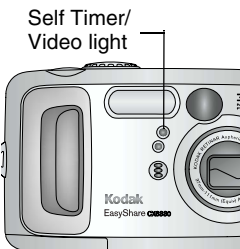

- 4 Compose the scene, then press the Shutter button completely down. Move so that you are in the scene.

The Self Timer/Video light blinks slowly for 8 seconds (then quickly for 2 seconds) before the video begins recording. It then stays on while recording.

To cancel the Self Timer before the video is taken, press the Self Timer button. (The Self Timer setting remains active.)

To turn off the Self Timer, press the Self Timer button twice.

4 Reviewing Pictures and Videos

Press the Review button to view and work with your pictures and videos. To save battery power, place your camera in the optional Kodak EasyShare camera dock 6000 to review pictures and videos (see [page 63](#)).

Remember, press the Shutter button to take a picture anytime—even in Review.

Viewing Single Pictures and Videos



- 1 Press the Review button.

The camera screen displays the last picture or video taken.

The icons displayed with each picture indicate the applied features. See [Camera Screen Icons, page 9](#).

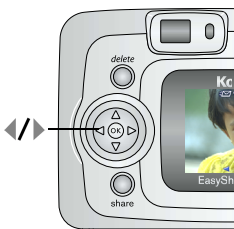

- 2 Press $\blacktriangleleft/\blacktriangleright$ to scroll backward or forward through pictures and videos. (For fast scrolling, press and hold $\blacktriangleleft/\blacktriangleright$. Fast-scrolling images appear in the center of the screen.)

- 3 Press the Review button to exit Review.

NOTE: Pictures taken at the Best (3:2) quality setting are displayed at a 3:2 aspect ratio, as shown, with a black bar at the top of the screen.

Viewing Multiple Pictures and Videos

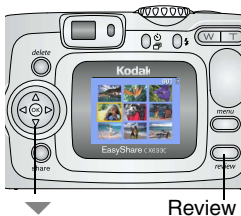

- 1 Press the Review button.
- 2 Press \blacktriangledown .

NOTE: You can also press the Menu button, highlight , then press the OK button.

Thumbnails of nine pictures and videos are displayed at once.

- 3 Press $\blacktriangle/\blacktriangledown$ to display the previous or next row of thumbnails.
- 4 Press $\blacktriangleleft/\blacktriangleright$ to scroll through the thumbnails one at a time.
The selected picture is highlighted in yellow.
- 5 Press the OK button to display a single view of the selected picture.

Playing a Video



- 1 Press the Review button.
- 2 Press $\blacktriangleleft/\blacktriangleright$ to locate a video (or highlight one in multiple view).
- 3 To play or pause a video, press the OK button.

NOTE: You can also press the Menu button, highlight , then press the OK button.

- 4 If the camera is connected to a television (see [page 55](#)), press $\blacktriangle/\blacktriangledown$ to adjust the volume.
- 5 To rewind a video, press \blacktriangleleft during playback. To replay the video, press the OK button.
- 6 To go to the previous or next picture or video, press $\blacktriangleleft/\blacktriangleright$.

Deleting Pictures and Videos

- 1 Press the Review button.
- 2 Press ◀/▶ to locate a picture or video (or highlight one in multiple view), then press the Delete button.

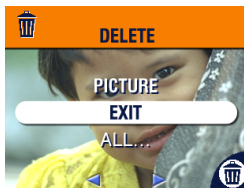











- 3 Press ▲/▼ to highlight an option, then press the OK button:
 - PICTURE or VIDEO**—deletes the displayed picture or video.
 - EXIT**—exits the Delete screen.
 - ALL**—deletes all pictures and videos from your current storage location.

- 4 To delete other pictures and videos, press ◀/▶ .
- 5 To exit delete, highlight Exit then press the OK button; or just press the Delete button again.

NOTE: You cannot delete protected pictures and videos in this manner. Remove protection before deleting (see [page 41](#)).

Changing Optional Review Settings

In Review mode, press the Menu button to access optional review settings.

	Magnify (pictures) (page 40) Play (videos) (page 38)		Copy (page 45)
	Share (page 47)		Video Date Display (page 46)
	Image Storage (page 11)		Multi-up (page 38)
	Protect (page 41)		Picture/Video Information (page 46)
	Album (page 41)		Setup Menu (page 51)
	Slide Show (page 43)		

Magnifying Pictures





1 Press the Review button, then locate a picture.





2 To magnify at 2X, press the OK button. To magnify at 4X, press the OK button again.

NOTE: You can also press the Menu button, highlight , then press the OK button.

The picture is magnified. The magnification value is displayed.

3 Press     to see different parts of the picture.

4 Press the OK button to redisplay the picture at the 1X (original) size.

5 Press   to locate a different picture, or press the Review button to exit Review mode.

Protecting Pictures and Videos From Deletion

- 1 Press the Review button, then locate the picture or video to protect.
- 2 Press the Menu button.

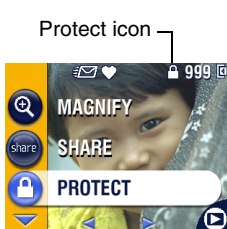

- 3 Press $\blacktriangle/\blacktriangledown$ to highlight Protect , then press the OK button.

The picture or video is protected and cannot be deleted. The Protect icon  appears with the protected picture or video.

- 4 To remove protection, press the OK button again.
- 5 Press the Menu button to exit the menu.



CAUTION:

Formatting internal memory or MMC/SD card deletes all (including protected) pictures, videos, and email addresses.

Tagging Pictures/Videos for Albums

Use the Album feature in Review mode to tag the pictures and videos in your camera with album names.

First—On Your Computer

Use Kodak EasyShare software, V 3.0 or higher, to create album names on your computer, then copy up to 32 album names to the camera's internal memory. See Kodak EasyShare software Help for details.

Second—On Your Camera



- 1 Press the Review button.
- 2 Locate a picture, then press the Menu button.
- 3 Press $\blacktriangle/\blacktriangledown$ to highlight Album , then press the OK button.
- 4 Press $\blacktriangle/\blacktriangledown$ to highlight an album folder, then press the OK button.

To add other pictures to the same album, press $\blacktriangle/\blacktriangledown$ to scroll through the pictures. When the picture you want is displayed, press the OK button.

To add the pictures to more than one album, repeat step 4 for each album.

The album name appears with the picture. A plus (+) after the album name means the picture was added to more than one album.

- 5 To remove a selection, highlight an album name and press the OK button.
To remove all album selections, select Clear All.
- 6 Press $\blacktriangle/\blacktriangledown$ to highlight Exit, then press the OK button.
Your selections are saved.
- 7 Press the Menu button to return to Review mode.

Third—Transfer to Your Computer

When you transfer the tagged pictures and videos to your computer, the Kodak EasyShare software opens and categorizes your pictures and videos in the appropriate album folder. See Kodak EasyShare software Help for details.

Running a Slide Show

Use the Slide Show to display your pictures and videos on the camera screen. To run a slide show on a television or on any external device, see [page 44](#). To save battery power, use an optional Kodak AC adapter, 3-volt (see [page 99](#)).

Starting the Slide Show

- 1 Press the Review button, then press the Menu button.
- 2 Press $\blacktriangle/\blacktriangledown$ to highlight Slide Show , then press the OK button.
- 3 Press $\blacktriangle/\blacktriangledown$ to highlight Begin Show, then press the OK button.

Each picture and video is displayed once, in the order in which you took them. Then the camera returns to the Menu screen.
- 4 To cancel the Slide Show, press the OK button.



Changing the Slide Show Display Interval

The default interval setting displays each picture for 5 seconds. You can increase the display interval to up to 60 seconds.

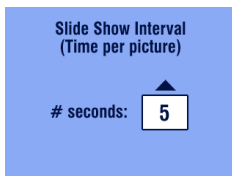

- 1 On the Slide Show menu, press $\blacktriangle/\blacktriangledown$ to highlight Interval, then press the OK button.
- 2 Select a display interval.

To scroll through the seconds quickly, press and hold $\blacktriangle/\blacktriangledown$.
- 3 Press the OK button.

The interval setting remains until you change it.

Running a Continuous Slide Show Loop

When you turn on Loop, the slide show is continuously repeated.

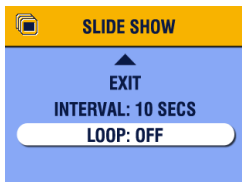

- 1 On the Slide Show menu, press ▲/▼ to highlight Loop, then press the OK button.
- 2 Press ▲/▼ to highlight On, then press the OK button.

When you start a slide show, it repeats until you cancel it by pressing the OK button or until battery power is exhausted. The Loop setting remains until you change it.

Displaying Pictures and Videos on a Television

You can display pictures and videos on a television, computer monitor, or any device equipped with a video input. (Image quality on a television screen may not be as good as on a computer monitor or when printed.)

NOTE: Ensure that the Video Out setting (NTSC or PAL) is correct (see [page 55](#)).

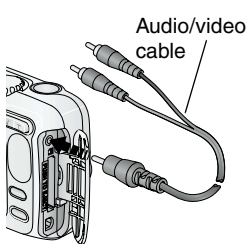

- 1 Connect the audio/video cable (included) from the camera video-out port to the television video-in port (yellow) and audio-in port (white). (Refer to your television user's guide for details.)
The camera screen turns off; the television screen acts as the camera display.
- 2 Review pictures and videos on the television screen.

NOTE: The slide show stops if you connect or disconnect the cable while the slide show is running.

Copying Pictures and Videos

You can copy pictures and videos from a card to internal memory or from internal memory to a card.

Before you copy, make sure that:

- A card is inserted in the camera.
- The camera's picture storage location is set to the location **from** which you are copying. See [Choosing Internal Memory or MMC/SD Card](#), page 11.

Copy pictures or videos:

- 1 Press the Review button, then press the Menu button.
- 2 Press $\blacktriangle/\blacktriangledown$ to highlight Copy \blacktriangleright , then press the OK button.



- 3 Press $\blacktriangle/\blacktriangledown$ to highlight an option:
 - PICTURE or VIDEO**—copies the current picture or video.
 - EXIT**—returns to the Review menu.
 - ALL**—copies all pictures and videos from your selected storage location to the other location.

- 4 Press the OK button.

A progress bar monitors the copy process until complete. (For information on picture numbering, see [page 96](#).)

NOTE:

- Pictures and videos are copied, not moved. To remove pictures and videos from the original location after they are copied, delete them (see [page 39](#)).
- Tags that you applied for print, email, and Favorites are not copied. Protection settings are not copied. To apply protection to a picture or video, see [page 41](#).

Displaying Video Date

To display the capture date and time before the video starts:

- 1 Press the Review button, then press the Menu button.
- 2 Press $\blacktriangle/\blacktriangledown$ to highlight Video Date Display , then press the OK button.

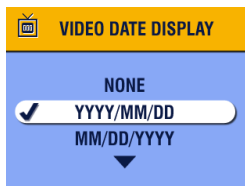

- 3 Press $\blacktriangle/\blacktriangledown$ to highlight an option, then press the OK button.
- 4 Press the Menu button to exit the menu.

The capture date and time appear during video playback on the camera. This setting remains until you change it.

Viewing Picture/Video Information

- 1 Press the Review button, then press the Menu button.



- 2 Press $\blacktriangle/\blacktriangledown$ to highlight Picture Info or Video Info, then press the OK button.

Information about the picture or video is displayed.

- 3 To view information on the next or previous picture or video, press $\blacktriangle/\blacktriangleright$. Press the Menu button to exit the menu.

5 Sharing Pictures and Videos

The Share button lets you “tag” your pictures and videos. When they are transferred to your computer, you can share:

Tagged Pictures

- By print
- By email
- As Favorites, for easy organization on your computer

Tagged Videos

- By email
- As Favorites

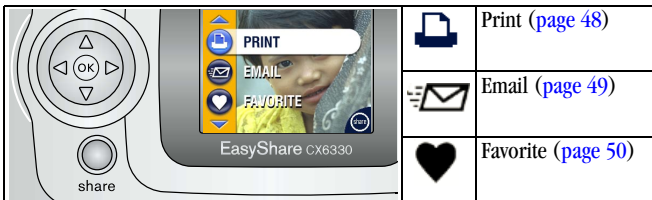

When Can I Tag My Pictures and Videos?

Press the Share button to tag pictures and videos:

- Any time (the last picture taken and the Share menu are displayed).
- Just after you take them, during Quickview (see [page 17](#) and [page 32](#)).
- After pressing the Review button (see [page 41](#)).

NOTE: Tags remain until removed. If a tagged picture or video is copied, the tag is **not** copied. In a burst series, only the last picture is tagged during Quickview.

Tagging Pictures for Printing



- 1 Press the Share button. Press ◀/▶ to locate a picture.
- 2 Press ▲/▼ to highlight Print , then press the OK button.*
- 3 Press ▲/▼ to select the number of copies (0-99). Zero removes the tag for that picture.

The Print icon  appears in the status area. The default quantity is one. (To change the default, see [page 52](#).)

- 4 **Optional:** You can apply a print quantity to other pictures. Press ◀/▶ to locate a picture. Keep the print quantity as is, or press ▲/▼ to change it. Repeat this step until the desired print quantity is applied to the pictures.
- 5 Press the OK button. Then press the Share button to exit the menu.

* To tag all pictures in the storage location, highlight Print All , press the OK button, then indicate the number of copies as described above. Print All is not available in Quickview.

To remove the print tagging for all pictures in the storage location, highlight Cancel Prints, then press the OK button. Cancel Prints is not available in Quickview.

Printing Tagged Pictures

When you transfer the tagged pictures to your computer, the Kodak EasyShare software print screen opens. For details on printing, click the Help button in the Kodak EasyShare software.

For more information on printing from your computer or card, see [page 62](#).

NOTE: For the best 4 x 6 prints, set the camera to the Best (3:2) print quality setting. See [page 25](#).

Tagging Pictures and Videos for Emailing

First—On Your Computer

Use Kodak EasyShare software to create an email address book on your computer. Then, copy up to 32 email addresses to the camera's internal memory.

Second—Tag On Your Camera

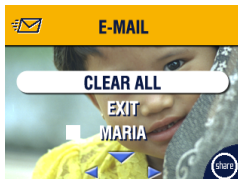

- 1 Press the Share button. Press ◀/▶ to locate a picture.
- 2 Press ▲/▼ to highlight Email , then press the OK button.
- 3 Press ▲/▼ to highlight an email address, then press the OK button.

To tag other pictures with the same address, press ◀/▶ to scroll through the pictures. When the picture you want is displayed, press OK.

To send the pictures to more than one address, repeat step 3 for each address.

Selected addresses are checked.

- 4 To remove a selection, highlight a checked address and press the OK button. To remove all email selections, highlight Clear All.
- 5 Press ▲/▼ to highlight Exit, then press the OK button.

Your selections are saved. The email icon  appears in the status area.

- 6 Press the Share button to exit the menu.

Third—Transfer and Email

When you transfer the tagged pictures and videos to your computer, the email screen opens and lets you send the pictures and videos to the addresses you specified. For details, click the Help button in the Kodak EasyShare software.

Tagging Pictures and Videos as Favorites

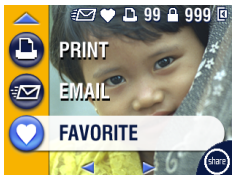

- 1 Press the Share button. Press ◀/▶ to locate a picture.
- 2 Press ▲/▼ to highlight Favorite ♥ , then press the OK button.

The Favorite icon ♥ appears in the status area.

- 3 To remove the tag, press the OK button again.
- 4 Press the Share button to exit the menu.

Using Favorites On Your Computer

When you transfer Favorite pictures and videos to your computer, you can use Kodak EasyShare software to retrieve, organize, and label them by subject, date, event, or any category you choose.

For details, click the Help button in the Kodak EasyShare software.

Need Help?

Click the Help button in the Kodak EasyShare software for details on creating address books, and printing, emailing, and organizing tagged pictures on your computer.

6 Customizing Your Camera Settings

Use Setup to customize camera settings according to your preferences.

To Access Setup Mode/Menus



- 1 In any Capture mode (or in Review), press the Menu button.
- 2 Press / to highlight Setup Menu , then press the OK button.

Setup Menus

	Return to previous menu		Date & Time Set (page 7)
	Default Print Quantity (page 52)		Video Out (page 55)
	Quickview (page 52)		Language (page 55)
	Liveview (page 53)		Format (page 56)
	Advanced Digital Zoom (page 54)		About (page 56)

Changing the Default Print Quantity

The Default Print Quantity setting determines the value that is displayed on the Share Print screen (page 48). The default value is 1.

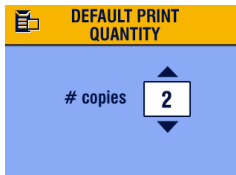

- 1 Press the Menu button.
- 2 Press $\blacktriangle/\blacktriangledown$ to highlight Setup Menu , then press the OK button.
- 3 Press $\blacktriangle/\blacktriangledown$ to highlight Default Print Quantity , then press the OK button.
- 4 Press $\blacktriangle/\blacktriangledown$ to select the new default quantity, then press the OK button.
- 5 Press the Menu button to exit the menu.



This setting remains until you change it.

Turning Off Quickview

After you take a picture or video, Quickview displays it on the camera screen for approximately 5 seconds (see page 17 and page 32). To save battery power, turn off Quickview.

- 1 Press the Menu button.
- 2 Press $\blacktriangle/\blacktriangledown$ to highlight Setup Menu , then press the OK button.
- 3 Press $\blacktriangle/\blacktriangledown$ to highlight Quickview , then press the OK button.

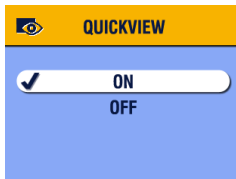

- 4 Press $\blacktriangle/\blacktriangledown$ to highlight Off, then press the OK button.
- 5 Press the Menu button to exit the menu.

*The picture is not displayed on the camera screen after you take it. To see the picture or video, press the Review button.
This setting remains until you change it.*

Turning On Liveview in Still Modes

The Liveview feature lets you use the camera screen as a viewfinder (see [page 15](#)). The default setting is Liveview Off.

IMPORTANT: *Liveview quickly depletes battery power; use it sparingly.*

To change the Liveview default to On:

- 1 Press the Menu button.
- 2 Press $\blacktriangle/\blacktriangledown$ to highlight Setup Menu ☰ , then press the OK button.
- 3 Press $\blacktriangle/\blacktriangledown$ to highlight Liveview 📷 , then press the OK button.

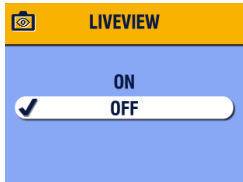

- 4 Press $\blacktriangle/\blacktriangledown$ to highlight On, then press the OK button.

Liveview is now On by default. The camera screen is on whenever the camera is on (in Still or Video mode). You can still press the OK button to turn Liveview off and on.

- 5 Press the Menu button to exit the menu.

This setting remains until you change it.

Changing Advanced Digital Zoom

You can customize the way the Advanced Digital Zoom turns on.

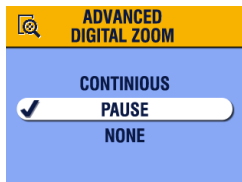

- 1 Press the Menu button.
- 2 Press $\blacktriangle/\blacktriangledown$ to highlight Setup Menu \equiv , then press the OK button.
- 3 Press $\blacktriangle/\blacktriangledown$ to highlight Advanced Digital Zoom 🔍 , then press the OK button.
- 4 Press $\blacktriangle/\blacktriangledown$ to highlight an option:
 - Continuous**—digital zoom automatically turns on after the Telephoto button is pressed to the optical zoom limit and held.
 - Pause (default)**—digital zoom turns on after the Telephoto button is pressed to the optical zoom limit, released, then is pressed again.
 - None**—disables digital zoom.
- 5 Press the Menu button to exit the menu.

NOTE: Advanced Digital Zoom cannot be activated unless Liveview is on.



Setting Video Out

Video Out is a regional setting that lets you connect to a television or other external device (see [page 55](#)).



- 1 Press the Menu button.
- 2 Press $\blacktriangle/\blacktriangledown$ to highlight Setup Menu , then press the OK button.
- 3 Press $\blacktriangle/\blacktriangledown$ to highlight Video Out , then press the OK button.
- 4 Press $\blacktriangle/\blacktriangledown$ to highlight an option:
 - NTSC (default)**—used in most countries except those in Europe and China. North America and Japan use NTSC.
 - PAL**—used in Europe and China.
- 5 Press the OK button to accept the change.
- 6 Press the Menu button to exit the menu.



This setting remains until you change it.

Selecting a Language

You can display menus and screen messages in different languages.

- 1 Press the Menu button.
- 2 Press $\blacktriangle/\blacktriangledown$ to highlight Setup Menu , then press the OK button.
- 3 Press $\blacktriangle/\blacktriangledown$ to highlight Language , then press the OK button.
- 4 Highlight an option, then press the OK button.
- 5 Press the Menu button to exit the menu.

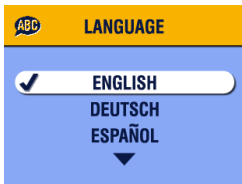

*Text is displayed in the selected language.
This setting remains until you change it.*

Formatting Internal Memory or MMC/SD Card



CAUTION:

Formatting erases all pictures and videos, including those that are protected. Removing a card during formatting may damage the card.

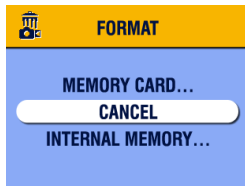

- 1 Press the Menu button.
- 2 Press $\blacktriangle/\blacktriangledown$ to highlight Setup Menu , then press the OK button.
- 3 Press $\blacktriangle/\blacktriangledown$ to highlight Format , then press the OK button.



- 4 Press $\blacktriangle/\blacktriangledown$ to highlight an option:
 - MEMORY CARD**—deletes everything on the card; formats the card.
 - CANCEL**—exits without making a change.
 - INTERNAL MEMORY**—deletes everything in internal memory including email addresses and album names; formats the internal memory.

- 5 Press the OK button.
- 6 Highlight Continue Format, then press the OK button.
When the formatting is complete, the Setup menu appears.

Viewing Camera Information

- 1 Press the Menu button.
- 2 Press $\blacktriangle/\blacktriangledown$ to highlight Setup Menu , then press the OK button.
- 3 Press $\blacktriangle/\blacktriangledown$ to highlight About , then press the OK button.
The camera model and the current firmware version appear.
- 4 Press the Menu button to exit the menu.

7 Installing the Software

NOTE: To install software on computers running Windows 2000, Windows XP Pro, or Mac OS X, you need administrator privileges. See your computer user's guide.

Windows System Requirements

- Personal computer running Windows 98, 98SE, ME, 2000, or XP OS
- 233 MHz processor or greater (300 MHz recommended for Windows 2000 and XP)
- 64 MB of available RAM (128 MB recommended)
- 100 MB of available hard disk space
- CD-ROM drive
- Built-in USB port
- Color monitor with a minimum resolution of 800 x 600 pixels; High Color (16-bit) or True Color (24-bit) recommended
- Internet access for online printing and emailing

Mac OS X System Requirements

- Macintosh computer with a G3 or G4 processor
- Mac OS 10.1.2, minimum
- 128 MB of available RAM
- 200 MB of available hard disk space
- CD-ROM drive
- Built-in USB port
- Color monitor with a minimum resolution of 800 x 600 pixels; thousands or millions of colors recommended
- Internet access for online printing and emailing

Mac OS 8.6 and 9.x System Requirements

- PowerPC-based Macintosh computer
- Mac OS 8.6 or 9.x
- 64 MB of available RAM
- 200 MB of available hard disk space
- CD-ROM drive
- Built-in USB port
- Color monitor with a minimum resolution of 800 x 600 pixels; thousands or millions of colors recommended
- Internet access for online printing and emailing

NOTE: Mac OS 8.6 and 9.x do not support the Share button functions.
Mac OS X is recommended for full functionality.

Install the Software

For information on the software applications included on the Kodak EasyShare software CD, click the Help button in the Kodak EasyShare software.

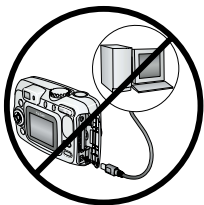

CAUTION:

Install Kodak EasyShare software *before* connecting the camera or optional dock to the computer. Failure to do so may cause the software to load incorrectly.



- 1 Before you begin, close all software applications that are open on your computer (including anti-virus software).
- 2 Place the Kodak EasyShare software CD into the CD-ROM drive.
- 3 Load the software:

Windows-based computer—if the install window does not appear, choose Run from the Start menu and type **d:\setup.exe** where **d** is the drive letter that contains the CD.

Mac OS 8.6 or 9.x—on the install window, click Continue.

Mac OS X—double-click the CD icon on the desktop, then click the Install icon.

- 4 Follow the on-screen instructions to install the software.
 - **Windows-based computers**—select Typical to automatically install the most commonly used applications. Select Custom to choose the applications you wish to install.
 - **Mac OS 8.6 or 9.x**—select Easy to automatically install the most commonly used applications.
 - **Mac OS X**—follow the on-screen instructions.

NOTE: When prompted, take a few minutes to electronically register your camera and software. This lets you receive information regarding software updates and registers some of the products included with the camera. You must be connected to your Internet service provider to register electronically.

To register later, see www.kodak.com/go/register.

- 5 If prompted, restart the computer. If you turned off anti-virus software, turn it back on. See the anti-virus software manual for details.

8 Connecting Camera to Computer



CAUTION:

Install Kodak EasyShare software *before* connecting the camera or optional dock to the computer. Failure to do so may cause the software to load incorrectly.

You can transfer pictures and videos from the camera to the computer using:

- The (included) USB cable.
- The (optional) Kodak EasyShare camera dock 6000. See [page 63](#) for connecting with the camera dock.
- The (optional) Kodak EasyShare printer dock 6000. Purchase these and other accessories at a dealer of Kodak products or www.kodak.com/go/cx6330accessories.

Transferring Pictures With the USB Cable

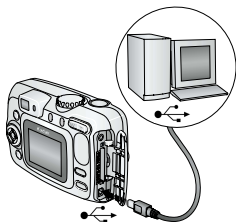

- 1 Turn off the camera.
- 2 Plug the labeled  end of the USB cable into the labeled USB port on your computer. See your computer user's guide for details.
- 3 Plug the other end of the USB cable into the labeled USB port on the camera.
- 4 Turn on the camera.

Kodak EasyShare software opens on your computer. The software prompts you through the transfer process.

NOTE: Visit www.kodak.com/go/howto for an online tutorial on connecting. You can also use a Kodak multi-card reader or Kodak SD multimedia card reader-writer to transfer your pictures.

Printing Pictures From Your Computer

For details on printing pictures from your computer, click the Help button in the Kodak EasyShare software.

Ordering Prints Online

Kodak EasyShare print service (provided by Ofoto www.ofoto.com) is one of the many online print services offered in the Kodak EasyShare software. You can easily:

- Upload your pictures.
- Edit, enhance, and add borders to your pictures.
- Store pictures, and share them with family and friends.
- Order high-quality prints, photo greeting cards, frames, and albums—and have them delivered to your door.

Printing From an Optional MMC/SD Card

- Automatically print tagged pictures when you insert your card into a printer with an MMC/SD slot. See your printer user's guide for details.
- Make prints at an MMC/SD-capable Kodak picture maker. (Contact a location prior to visiting. See www.kodak.com/go/picturemaker.)
- Take the card to your local photo retailer for professional printing.

Print With or Without a Computer

Dock your camera to the Kodak EasyShare printer dock 6000 and print directly—with or without a computer. Purchase this and other accessories at a dealer of Kodak products or www.kodak.com/go/cx6330accessories.

9 Using the Camera Dock 6000

The Kodak EasyShare camera dock 6000:

- Makes it easy to transfer pictures and videos to the computer.
- Charges the included Kodak EasyShare Ni-MH rechargeable battery pack. (Install the battery pack in the camera for charging.)
- Supplies power to the camera.

You can purchase a camera dock at a dealer of Kodak products or at www.kodak.com/go/cx6330accessories.

Camera Dock 6000 Package Contents

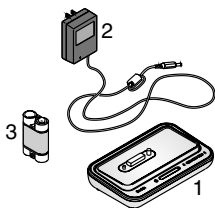

- 1 Camera dock 6000 (with universal insert installed)
- 2 5-volt AC power adapter
Your AC adapter may differ from the one pictured.
- 3 Kodak EasyShare Ni-MH rechargeable battery pack
- 4 Quick Start Guide (not shown)



CAUTION:

Do not use the 5-volt AC power adapter to power your camera without the dock. It is not compatible with your camera alone.

Installing the Custom Camera Insert

A **universal insert** is pre-installed in the camera dock. It allows all Kodak EasyShare CX/DX6000 series and LS600 series cameras to use the camera dock.

A **custom insert** is included with your camera. It provides a perfect fit for the Kodak EasyShare CX6330 zoom digital camera.

Remove the Universal Insert

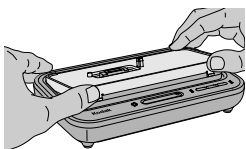

- 1 Place your thumbs against the front of the universal insert. Press in and lift.

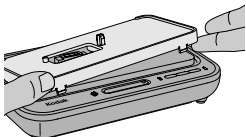

- 2 Lift the side edge of the insert, then remove the insert from the dock.
- 3 Save the universal insert as a spare.

Install the Custom Insert

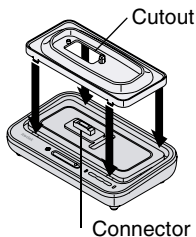

- 1 Position the custom insert so that the cutout lines up with the camera dock connector.
- 2 Fit the insert into the groove in the dock. Snap it into place.

To order a custom insert, visit
www.kodak.com/go/cx6330accessories.

Connecting the Camera Dock 6000

After the Kodak EasyShare software is loaded (see [page 57](#)), connect the camera dock to your computer and to a power outlet. You need:

- The USB cable included with your camera
- The 5-volt AC adapter included with the camera dock

IMPORTANT: *Make sure your camera is NOT in the camera dock when you are connecting to power and the computer.*

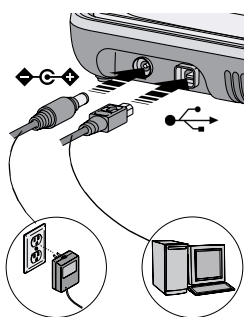

- 1 Plug the labeled  end of the USB cable into the labeled USB port on your computer. See your computer user's guide for details.
- 2 Plug the other end of the USB cable into the square USB connector on the back of the camera dock.
- 3 Plug the AC adapter into the round power connector on the back of the camera dock and into a power outlet.

Your AC adapter may differ from the one pictured or may have additional plugs. Use the plug that accommodates your type of power outlet.



CAUTION:

Use only the 5-volt AC adapter included with the camera dock 6000. Other adapters may cause damage to your camera, camera dock, or AC adapter.

Leave the camera dock connected so it's always ready to transfer pictures and videos.

Installing the Rechargeable Battery

You received (2) Kodak Max digital camera batteries (AA) with your camera. To take full advantage of your camera dock 6000, replace the AA batteries with the Kodak EasyShare Ni-MH rechargeable battery pack that is packaged with the camera dock.

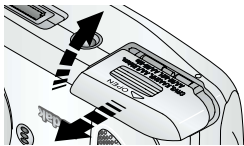

- 1 Open the battery door on the bottom of the camera.
- 2 Install the Ni-MH rechargeable battery pack as illustrated.



CAUTION:

The battery pack can only be inserted into the camera in the orientation shown. If the Battery Pack does not easily install, reposition it and try again. **DO NOT FORCE IT.** Doing so can damage your camera.

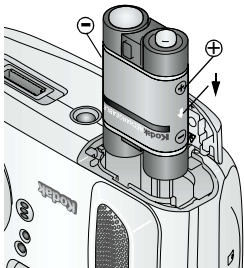

- 3 Close the battery door.

IMPORTANT: *The battery pack is not charged when you receive it. See [page 68](#) for charging instructions.*

Docking the Camera

To charge the battery or to transfer pictures and videos from the camera to the computer:

Alignment

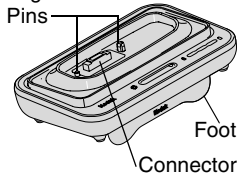

- 1 Flip down the camera dock foot.

The camera dock now sits at the proper angle for viewing the camera screen.

- 2 Turn off the camera.

NOTE: If a USB cable is plugged into the camera itself, unplug it.

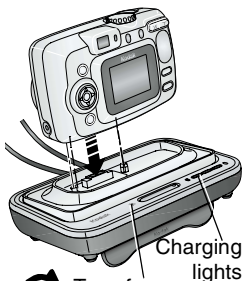

Transfer light

- 3 Match the connector and alignment pins on the camera dock to the camera. Push down until the camera is securely seated.

The Transfer light glows green when the camera is seated.

If a rechargeable battery is in the camera, the first battery charging light glows green.

The camera is now powered by the camera dock instead of the camera batteries.

NOTE: If the Kodak EasyShare Ni-MH rechargeable battery pack requires charging, charging begins (see [page 68](#)).

Charging the Battery

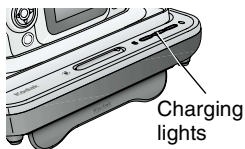





- 1 Make sure the Kodak EasyShare Ni-MH rechargeable battery pack is installed in the camera (see [page 66](#)).
- 2 Turn off the camera and place it in the camera dock (see [page 67](#)).

If the battery requires charging, charging begins after a brief battery check.

- Full charging takes about 2.5 hours.
- Charging stops if you turn on the camera. If the camera is left in the camera dock with the power on, charging resumes when the camera enters auto power-off (see [page 99](#)).
- Charging is suspended during picture transfer.

Charging Lights Status

Charging Lights	Cause
Green lights   	Camera is properly docked. Battery is either being checked or is less than half charged. Battery is more than half charged. Battery is fully charged.
Red light (blinking) 	Battery is not properly installed (see page 66). Battery or connector pin is damaged. Camera and battery have been exposed to extreme temperatures. Slowly return to room temperature.
No lights	Camera is not properly seated in the camera dock. AC adapter is not connected. Correct battery is not installed (see page 66).

Transferring Pictures With the Dock

After the Kodak EasyShare software is loaded on your computer (see [page 57](#)), you can transfer pictures and videos from your camera to your computer.

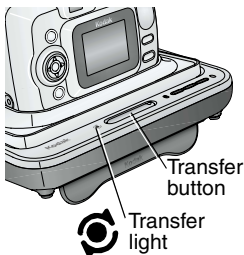

- 1 Turn off the camera and place it in the camera dock.
- 2 Push the Transfer button.

The Transfer light blinks green while the pictures and videos are transferring.

Messages about the transfer status appear on the camera screen. Kodak EasyShare software automatically opens on your computer.

NOTE: After transferring, the camera dock resumes charging as necessary.

Transfer Light Status

Light	Cause
Steady	The camera is properly seated in the camera dock. The camera dock is connected to AC power and to a computer via the USB cable.
Blinking	Pictures are being transferred to the computer.
Off	The camera is not seated in the camera dock (page 67). The camera dock is not plugged into AC power (page 65). The USB cable is not connected (page 65).

Need Help Using the Software?

For details on transferring, organizing, printing, emailing, and editing your pictures, click the Help button in the Kodak EasyShare software.

Reviewing Pictures and Videos

When the camera is in the dock, the camera is powered by the dock, not the camera batteries. Save battery power by using the dock to review pictures and videos on the camera screen.



- 1 Turn on the camera and place it in the camera dock.
- 2 Press the Review button to display the last picture or video taken. See [Chapter 4, Reviewing Pictures and Videos](#), for details.

You can perform any camera function with the camera in the dock (ex., taking pictures, checking or changing settings).

Camera Dock 6000 Specifications

Specifications—Kodak EasyShare camera dock 6000		
Communication with computer	USB	Cable (included with Kodak EasyShare cameras)
Dimensions (without insert)	Width	6.1 in. (155 mm)
	Depth	3.7 in. (94.5 mm)
	Height	1.2 in. (31 mm)
	Weight	6.0 oz (170 g)
Transfer light (page 69)		Indicates connection/transfer
Charging lights (page 68)		Indicate charging status and error conditions
Input voltage		5 ±0.25 V DC
Power	DC input	AC adapter (included with camera dock)

Troubleshooting—Camera Dock 6000

Problem	Cause	Solution
Pictures are not transferred to the computer	AC adapter or USB cable is not securely connected.	Check the connections (page 65).
	Software is not installed.	Install the software (page 57).
	Too many applications running on computer.	Close all software applications and try again.
	Camera was removed from the camera dock during picture transfer.	Replace the camera on the camera dock and press the Transfer button.
	Transfer button was not pressed.	Press the Transfer button.

Earlier Cameras and Docks

Your Kodak EasyShare camera dock 6000 requires a Kodak EasyShare CX/DX6000 or LS600 series digital camera.

Earlier camera models (Kodak EasyShare 4000 series and previous) require the original Kodak EasyShare camera dock or camera dock II.

10 Troubleshooting

When you have questions about your camera or camera dock 6000, start here. Additional technical information is available in the ReadMe file located on the Kodak EasyShare software CD. For updates to Troubleshooting information, see www.kodak.com/go/cx6330support.

Camera Problems

Problem	Cause	Solution
Camera does not turn on.	Batteries are not properly installed.	Reinstall the batteries (page 4).
	Battery is not charged.	Recharge the battery (page 68).
Camera does not turn off; lens does not retract.	A non-approved battery may be in the camera.	Use the batteries that came with your camera, or an approved replacement battery (page 97).
Pictures remaining number does not decrease after taking a picture.	Picture does not take up enough space to decrease the number.	The camera is operating normally. Continue taking pictures.
	You did not take a picture.	Use Review (page 37) or Quickview (page 17) to make sure a picture was taken.
Picture orientation is not accurate.	The camera was rotated or tilted while the picture was taken.	Set the Orientation Sensor (page 29).
Stored pictures are corrupted.	The card was removed or the batteries expired while the ready light was blinking.	Retake picture. Do not remove card while the ready light is blinking. Keep battery charged.

Problem	Cause	Solution
Short battery life with Kodak EasyShare Ni-MH rechargeable battery pack.	Dirt or oxidation on the battery contacts.	Wipe the contacts with a clean, dry cloth (page 97) before loading batteries in the camera.
Shutter button does not work.	Camera is not turned on.	Turn on the camera (page 6).
	The camera is processing a picture; the ready light (near the viewfinder) is blinking red.	Wait until the ready light stops blinking red before attempting to take another picture. You can take a picture when the ready light is blinking green.
	The card or internal memory is full.	Transfer pictures to the computer (page 61 or page 69), delete pictures from the camera (page 39), switch storage locations (page 11), or insert a card with available memory (page 10).
	The Shutter button was not pressed.	For best pictures, see page 13 .
Part of the picture is missing. (Also see Stored pictures are corrupted.)	Something was blocking the lens when the picture was taken.	Keep hands, fingers, or other objects away from the lens when taking pictures.
	Your eye or the picture was not centered correctly in the viewfinder or camera screen.	Leave space around subject when centering picture in viewfinder or camera screen.

Problem	Cause	Solution
In Review mode, you do not see a picture (or the expected picture) on the camera screen.	The camera may not be accessing the correct storage location.	Check the picture storage location setting (page 11).
In Review mode, a blue screen is displayed instead of a picture.	The picture has no thumbnail or an unrecognized thumbnail.	Transfer the picture to the computer (page 61 or page 69), or delete the picture (page 39).
Picture is too dark.	Flash is not on.	Turn on the flash (page 19).
	The subject is too far away for the flash to have an effect.	Move so there is no more than 11.8 ft (3.6 m) between the camera and the subject; 6.9 ft (2.1 m) in Telephoto.
	The subject is in front of a bright light (backlit).	Use Fill flash (page 19) or change your position so light is not behind the subject.
	Auto exposure was not achieved.	To take the best possible pictures, press the Shutter button half-way and bold . When the ready light glows green, press the Shutter button the rest of the way down to take the picture.
	Not enough light.	Increase Exposure Compensation (page 24).

Problem	Cause	Solution
Picture is too light.	The flash is not needed.	Change to Auto flash or Flash Off (page 19).
	The subject was too close for flash.	Move so there is at least 2 ft (0.6 m) between camera and subject.
	The light sensor is covered.	Hold the camera so your hands or other objects do not cover the light sensor (page i).
	Too much light.	Decrease Exposure Compensation (page 24).
	Auto exposure was not achieved.	To take the best possible pictures, press the Shutter button half-way and hold . When the ready light glows green, press the Shutter button the rest of the way down to take the picture.
Camera freezes up when a card is inserted or removed.	Camera detected an error when the card was inserted or removed.	Turn the camera off, then back on. Make sure the camera is turned off before inserting or removing a card.
Kodak CRV3 lithium battery does not fit in the camera.	Battery is not oriented correctly.	See page 4 .

Problem	Cause	Solution
Picture is not clear.	The lens is dirty.	Clean the lens (page 94).
	Subject too close when taking picture.	Move so there is at least 23.6 in. (60 cm) between the camera and the subject, or at least 5.1 in. (13 cm) at Wide in Close-up mode.
	Subject or the camera moved while the picture was taken.	Place the camera on a flat, steady surface or use a tripod.
	The subject is too far away for the flash to be effective.	Move so there is no more than 11.8 ft (3.6 m) between the camera and the subject; 6.9 ft (2.1 m) in Telephoto.
	Auto focus was not achieved.	To take the best possible pictures, press the Shutter button half-way and hold . When the ready light glows green, press the Shutter button the rest of the way down to take the picture. (If the yellow light blinks, release the Shutter button and recompose picture.)
	Camera is in Close-up mode.	Use Close-up mode when subject is 5.1-27.6 in. (13-70 cm) from the lens in Wide Angle; 8.7-27.6 in. (22-70 cm) in Telephoto.
Slide show does not run on external video device.	Video Out setting is incorrect.	Adjust the camera Video Out setting (NTSC or PAL, page 55).
	External device is set incorrectly.	See the external device's user's guide.

Camera/Computer Communications

Problem	Cause	Solution
The computer cannot communicate with the camera.	There is a problem with the configuration of the USB port on the computer.	See this file on the EasyShare software CD: USB.html Or, go to: www.kodak.com/go/camerasupport
	Camera power is off.	Turn on the camera (page 6).
	Battery is not charged.	Recharge the battery (page 68).
	Some Advanced Power Management utilities on laptops turn off ports to save battery life.	See the Power Management section of the laptop user's guide to disable this feature.
	USB cable is not securely connected.	Connect cable to camera and computer port (page 61).
	Software is not installed.	Install the software (page 57).
	Software is installed incorrectly.	Disconnect the USB cable. Close all open applications. Uninstall, then re-install the software (page 57). To uninstall, go to Start/Settings/Control Panel/Add/Remove Programs.
	Too many applications are running on the computer.	Disconnect camera from the computer. Close all software applications, reconnect camera.
The Battery Monitor or similar software runs constantly.	Close that software before starting the Kodak software.	

Problem	Cause	Solution
Cannot transfer pictures. (The Add New Hardware Wizard cannot locate drivers.)	Software is not installed.	Disconnect USB cable. (If using camera dock, disconnect cable and remove camera from dock). Install EasyShare software (page 57).
	Software is installed incorrectly.	Disconnect the USB cable. Close all open applications. Uninstall, then re-install the software (page 57). To uninstall, go to Start/Settings/Control Panel/Add/Remove Programs.

MMC/SD Cards and Internal Memory

Problem	Cause	Solution
The camera does not recognize MMC/SD card.	The card may not be MMC/SD certified.	Purchase a certified MMC/SD card.
	The card may be corrupt.	Reformat the card (page 56). Caution: Formatting erases all pictures and videos, including protected files.
	Card is not properly inserted in camera.	Insert a card into the slot, then push to seat (page 10).
Camera freezes up when a card is inserted or removed.	Camera detects an error when the card is inserted or removed.	Turn the camera off, then back on. Make sure the camera is off when inserting or removing a card.

Problem	Cause	Solution
Memory card full	Storage is full.	Transfer pictures and videos to the computer (page 61 or page 69), then delete them from the camera.
	The maximum number of files or folders is reached (or other directory concern).	Transfer pictures and videos to the computer, then format the card or internal memory (page 56). Caution: Formatting a card erases all pictures and videos, including protected files. (Formatting internal memory also erases email addresses and album names. To restore addresses and albums, see Kodak EasyShare software Help.)

Camera Screen Messages

Message	Cause	Solution
No images to display	There are no pictures in the current storage location.	Change picture storage location setting (page 11).
Memory card requires formatting	The card is corrupted or formatted for another digital camera.	Insert a new card or format the card (page 56). Caution: Formatting erases all pictures and videos, including protected files.
Memory card cannot be read (Please format memory card or insert another memory card)		
Remove USB cable in camera Restart computer if needed	USB cable is connected to camera.	Unplug the USB cable from the camera.

Message	Cause	Solution
Internal memory requires formatting	The camera internal memory is corrupted.	Format the internal memory (page 56).
Internal memory cannot be read (Please format internal memory)		Caution: Formatting erases all pictures and videos, including protected files. (Formatting internal memory also erases email addresses and album names. To restore them, see Kodak EasyShare software Help.)
No memory card (Files not copied)	There is no card in the camera. Pictures were not copied.	Insert a card (page 10).
Not enough space to copy files (Files not copied)	There is not enough space in the location you are copying to (internal memory or the card).	Delete pictures from the location you are copying to (page 39), or insert a new card.
Read-only card, change to internal memory to capture	The card in the camera is write-protected.	To take a picture, insert a new card or change storage location to internal memory (page 11).
Memory card is protected (Reset switch on memory card) Card is locked	Switch on card is in write-protect position.	Reset the switch as shown on camera screen.
Memory card is locked (Insert a new memory card)	The card is write-protected.	To take a picture, insert a new card or change storage location to internal memory (page 11).

Message	Cause	Solution
Memory card is unusable (Insert a new memory card)	The card is slow, corrupted, or unreadable.	Insert a new card (page 10).
Recording stopped. Record in internal memory (Memory card speed is slow)	Card cannot be used to take videos.	Change storage location to internal memory (page 11). Use this card to take pictures only.
Memory card is full (Cannot save album tagging)	There is no space remaining.	Insert a new card (page 10), transfer pictures (page 61 or page 69), or delete pictures (page 39).
Internal memory is full (Cannot save album tagging)		
Memory card is full (Cannot save share tagging)		
Internal memory is full (Cannot save share tagging)		
Date and time have been reset	This is the first time you turned on the camera; or you removed the batteries for an extended time; or the batteries are exhausted.	Reset the clock (page 7).
No address book on camera (Connect with computer to import address book)	No email addresses appear because there is no address book.	Create and copy address book from computer. See EasyShare software Help.

Message	Cause	Solution
No album names on camera (Connect with computer to import album names)	Album names have not been copied to the camera from the computer.	Create and copy album names from computer. See EasyShare software Help.
High camera temperature (Camera will be turned off)	The internal temperature of the camera is too high for the camera to operate. The viewfinder light glows red and the camera turns off.	Leave the camera off for several minutes, then turn it back on. If the message reappears, contact Customer Support (page 88).
Memory card is full	There is no more space on the card.	Delete pictures from the card (page 39), insert a new card, or change storage location to internal memory (page 11).
Internal memory is full	There is no more space in the camera's internal memory.	Delete pictures from the internal memory (page 39) or change storage location to Auto (page 11) and insert card (page 10).
Unrecognized file format	The camera cannot read the picture format.	Transfer the unreadable picture to the computer (page 61 or page 69), or delete it (page 39).
Camera error # See user's guide	An error is detected.	Turn the camera off, then back on. If error reappears, contact Customer Support (page 88).

Camera Ready Light Status

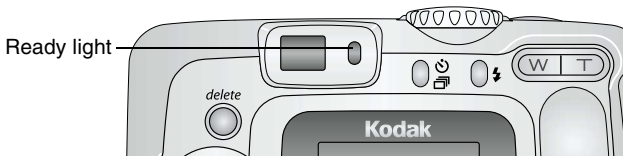

Status	Cause	Solution
Ready light does not turn on and the camera does not work.	Camera is not turned on.	Turn on the camera (page 6).
	Batteries are exhausted.	Recharge the battery (page 68) or install new ones (page 97).
	Mode dial was on when batteries were reloaded.	Turn Mode dial off, then back on.
Ready light glows steady green.	Camera is on; ready to take a picture or video.	Camera is operating normally.
	Shutter button is pressed halfway down. Focus and exposure are set.	Camera is operating normally.
Ready light blinks green.	Picture is being processed and saved to the camera.	Camera is operating normally.

Status	Cause	Solution
Ready light blinks yellow.	Flash is not charged.	Wait. Resume picture taking when the light stops blinking and turns green.
	Auto exposure or auto focus are not locked.	Release the Shutter button and recompose the picture.
Ready light blinks red.	Batteries are low or exhausted.	Recharge the battery (page 68) or install new ones (page 97).
Ready light glows steady red.	Camera's internal memory or card is full.	Transfer pictures to the computer (page 61 or page 69), delete pictures from the camera (page 39), switch storage locations (page 11), or insert a card with available memory (page 10).
	Camera processing memory is full.	Wait. Resume picture taking when the light turns green.
	Card is read-only.	Change storage location to internal memory (page 11), or use a different card.

11 Getting Help

Helpful Links

Help with your camera	www.kodak.com/go/cx6330support
Help with Windows operating system and working with digital pictures	www.kodak.com/go/pcbasics
Download the latest camera software and firmware	www.kodak.com/go/cx6330downloads
Optimize your printer for truer, more vibrant colors	www.kodak.com/go/onetouch
Get support for cameras, software, accessories, more	www.kodak.com/go/support
Purchase camera accessories	www.kodak.com/go/cx6330accessories
Register your camera	www.kodak.com/go/register
View online tutorials	www.kodak.com/go/howto

Help in this Manual

See [Troubleshooting, page 73](#) for help with problems you may have with your camera, camera/computer connections, or MMC/SD cards. See [page 71](#) for help with EasyShare camera dock 6000.

Software Help

Click the Help button in the Kodak EasyShare software.

Telephone Customer Support

If you have questions concerning the operation of the software or camera, you may speak with a customer support representative.

Before You Call

- Have the camera or camera dock connected to your computer.
- Be at your computer.
- Have the following information available:

Operating system _____

Processor speed (MHz) _____

Computer model _____

Amount of memory (MB) _____

Exact error message you received _____

Version of Kodak EasyShare software CD _____

Camera serial number _____

Telephone Numbers

Australia	1800 147 701
Austria/Osterreich	0179 567 357
Belgium/Belgique	02 713 14 45
Brazil	0800 150000
Canada	1 800 465 6325
China	800 820 6027
Denmark/Danmark	3 848 71 30
Ireland/Eire	01 407 3054
Finland/Suomi	0800 1 17056
France	01 55 1740 77
Germany/Deutschland	069 5007 0035
Greece	00800 441 25605
Hong Kong	800 901 514
India	91 22 617 5823
Italy/Italia	02 696 33452
Japan	03 5644 5050
Korea	00798 631 0024
Netherlands/Nederland	020 346 9372
New Zealand	0800 440 786
Norway/Norge	23 16 21 33
Philippines	1 800 1 888 9600
Portugal	021 415 4125
Singapore	800 6363 036

Spain/Espana	91 749 76 53
Sweden/Sverige	08 587 704 21
Switzerland/Schweiz/Suisse	01 838 53 51
Taiwan	0 080 861 008
Thailand	001 800 631 0017
UK	0870 243 0270
United States	1 800 235 6325
Outside the United States	585 726 7260
International Toll Line	+44 131 458 6714
International Toll Fax	+44 131 458 6962

For the most up-to-date listings, visit:

<http://www.kodak.com/US/en/digital/contacts/DAIInternationalContacts.shtml>

12 Appendix

Camera Specifications

For more specifications, visit www.kodak.com/go/cx6330support.

Kodak EasyShare CX6330 zoom digital camera		
Color		24-bit, millions of colors
Color modes		Color, black & white, sepia
Communication with computer		USB, via: USB cable, EasyShare camera dock 6000, or printer dock 6000
Dimensions	Width	4.0 in. (102.5 mm)
	Depth	1.5 in. (38 mm)
	Height	2.6 in. (65 mm)
	Weight	6.2 oz (175 g) without batteries or card
Exposure control		Multi-pattern TTL-AE
File format	Still	JPEG/EXIF v2.2 Exif Print
	Video	QuickTime (CODEC H.263)
	Audio	G.711
Flash	Modes	Auto, Fill, Red-eye, Off
	Range	Wide: 2-11.8 ft (0.6-3.6 m) Tele: 2-6.9 ft (0.6-2.1 m)
	Charging Time	7 seconds with charged battery
Image sensor	1/2.7 in. interline transfer CCD, 4:3 aspect ratio, RGB Bayer CFA, 3.1 M pixels (effective)	

Kodak EasyShare CX6330 zoom digital camera		
ISO speed	Automatic	100-200
Lens	Type	Optical quality glass, 6 groups/7 elements (2 aspherical lenses)
	Aperture	Wide: f/2.7-f/5.2; Tele: f/4.6-f/8.7
	Focal Length	37 - 111 mm (35 mm equivalent)
	Focus Distance	Wide: 23.6 in. (.6 m) to infinity Close-up: Less than 5.1 in. (13 cm)
Liquid Crystal Display, LCD (Camera screen)		1.6 in. (4 cm), color, 312 x 230 (72K) pixels. Preview rate: 24 fps
Operating Temperature		32 to 104 ^o F (0 to 40 ^o C)
Picture/Video storage		16 MB internal; optional SD Card or MMC
Pixel resolution	Best ★★★	2032 x 1524 (3.1 M) pixels
	Best (3:2) ★★★★	2032 x 1354 (2.8 M) pixels
	Better ★★	1656 x 1242 (2.1 M) pixels
	Good ★	1200 x 900 (1.1 M) pixels
Power	Batteries	Kodak Max digital camera batteries 2-AA, 2-AA lithium, 2-AA Ni-MH, CRV3, Ni-MH rechargeable battery pack
	AC adapter	3V DC (purchase separately)
Self Timer		10 seconds
Tripod socket		Yes
Video Out format		NTSC or PAL selectable
Video resolution (on camera)		320 x 240 pixels, 15 fps
Viewfinder		Optical
White balance		Auto

Kodak EasyShare CX6330 zoom digital camera

Zoom (still capture)	3X optical, 3.3X digital
----------------------	--------------------------

Original Factory Settings

Feature	Factory Setting
Date/Time	2003/01/01; 12:00
Date/Time Stamp	Off
Default Print Quantity	1
Digital Zoom initiation	Pause
Exposure Compensation	0.0
Flash	Auto, Night: Auto flash Sport: Auto flash Landscape, Close-up, Video: Flash Off
Image Storage	Auto
Language	English
Liveview	Off
Orientation Sensor	On
Picture Quality	Best
Quickview	On
Slide Show Interval	5 seconds
Slide Show Loop	Off
Video Date Display	None
Video Out	NTSC

Upgrading Your Software and Firmware

Download the latest versions of the software included on the Kodak EasyShare software CD and the camera firmware (the software that runs on the camera). See www.kodak.com/go/cx6330downloads.

Tips, Safety, Maintenance

- Always follow basic safety precautions. Refer to the “Important Safety Instructions” booklet packed with your camera.
- Do not allow chemicals, such as suntan lotion, to come into contact with the painted surface of the camera.
- If the camera has been subjected to inclement weather or you suspect water has gotten inside the camera, turn off the camera and remove the batteries and card. Allow all components to air-dry for at least 24 hours before using the camera again. If this does not resolve the problem, contact customer support ([page 88](#)).
- Blow gently on the lens or camera screen to remove dust and dirt. Wipe gently with a soft, lint-free cloth or an untreated lens-cleaning tissue. Do not use cleaning solutions unless they are designed specifically for camera lenses. Do not wipe the camera lens or camera screen with chemically treated eyeglass lens tissue. It may scratch the lens.
- Wipe the outside of the camera with a clean, dry cloth. Never use harsh or abrasive cleaners or organic solvents on the camera or any of its parts.
- Service agreements are available in some countries. Contact a dealer of Kodak products for more information.
- For rechargeable battery disposal information, visit the Rechargeable Battery Recycling Corporation Web site at www.rbc.com.
- For digital camera disposal or recycling information, contact your local authorities. In the US, visit the Electronics Industry Alliance Web site at www.eiae.org or the Kodak Web site at www.kodak.com/go/cx6330support.

Storage Capacities

File sizes can vary. You may be able to store more or fewer pictures and videos.

Video Storage Capacity

	Minutes/seconds of video
16 MB internal memory	1 min.
16 MB MMC/SD	1 min.
32 MB MMC/SD	2 min., 15 sec.
64 MB MMC/SD	4 min., 30 sec.
128 MB MMC/SD	9 min.,

Picture Storage Capacity

	Number of pictures			
	Best ★★★	Best (3:2) ★★★	Better ★★	Good ★
16 MB internal memory	17	19	25	45
16 MB MMC/SD	16	18	24	43
32 MB MMC/SD	32	36	48	87
64 MB MMC/SD	65	73	97	175
128 MB MMC/SD	131	147	194	350

Locating Pictures and Videos on a Card

Pictures stored on MMC/SD Cards use a standard (DCF-Digital Camera Format) agreed upon by many camera manufacturers. This lets you use the cards in different cameras. If you use a card reader to retrieve your files, the following description of the card file structure may be helpful.

MISC folder—contains the order files created when you use the Share feature to tag files for printing, emailing, and as favorites; also contains the address book and album names copied from computer.

SYSTEM folder—created and used while updating camera firmware.

DCIM folder—root level folder, contains the 100K6330 folder. Each time you turn on the camera or insert a different card, any empty folders within the DCIM folder are removed.

100K6330 subfolder—initially contains all pictures and videos on the card.

Picture Naming Conventions

- Pictures are named 100_nnnn.JPG, and are numbered in the order in which they are taken. The first picture is named 100_0001.JPG; the highest number allowed is 100_9999.JPG.
- When a card contains a picture named 100_9999.JPG in the \DCIM\100K6330 folder, subsequent pictures appear in a new folder (\DCIM\101K6330), beginning with picture 101_0001.JPG.
- Even if you transfer pictures to the computer or delete pictures from the camera, the camera continues to use consecutive numbers for all subsequent pictures. For example, if the last picture taken was 100_0007.JPG and you delete it, the next picture you take is named 100_0008.JPG.
- When you insert a different card into your camera, the next picture number is defined by incrementing the higher of the last picture taken by the camera, or the highest existing picture number in the folder.

- If you use the card in a camera other than the Kodak EasyShare CX6330 zoom digital camera, and that camera manufacturer adheres to this file structure standard, the \DCIM folder contains a folder named by that camera. For more information, refer to the documentation that accompanied that camera.

Burst Pictures

When a burst series is initiated, a letter “B” replaces the underscore in the file name. When a burst series is initiated or ended, the second digit to the left of the decimal is incremented by 1.

Image	Mode	File name	Image	Mode	File name
1	Still	100_0001.JPG	4	Burst (1/2)	100B0020.JPG
2	Burst (1/2)	100B0010.JPG	5	Burst (2/2)	100B0021.JPG
3	Burst (2/2)	100B0011.JPG	6	Still	100_0030.JPG

Using the Batteries

- **Replacement Types**—your camera can use the following battery types:
 - 1, Kodak CRV3 lithium battery *
 - 1, Kodak EasyShare Ni-MH rechargeable battery pack* (rechargeable in the Kodak EasyShare camera dock 6000 and printer dock 6000)
 - 2, Kodak Max digital camera batteries (AA)*
 - 2, 1.2 volt AA nickel metal hydride (Ni-MH) batteries, rechargeable *
 - 2, 1.5 volt AA lithium batteries

* Purchase these batteries on our Web site at www.kodak.com/go/cx6330accessories.
- For acceptable battery life, and to make sure your camera operates dependably, **we do not recommend or support alkaline batteries.**

- **To lengthen battery life**, limit the following activities:
 - Using Liveview (using the camera screen as the viewfinder, see [page 15](#))
 - Reviewing your pictures on the camera screen (see [page 37](#))
 - Excessive use of the flash
- Dirt on the battery contacts can affect battery life. Wipe the contacts with a clean, dry cloth before loading batteries in the camera.
- Battery life depends significantly on battery age, usage conditions, and type. Digital cameras are demanding on batteries. Not all batteries perform well under these challenging conditions.
- Battery performance is reduced at temperatures below 41° F (5° C). Carry spare batteries when using your camera in cold weather, and keep them warm. Do not discard cold batteries that do not work; when they return to room temperature, they may be usable.
- Do not allow batteries to touch metal objects, including coins. Otherwise, a battery may short circuit, discharge energy, become hot, or leak.

Expected Battery Life

Battery Type	Pictures per Set of Batteries (approximate)*
2 Kodak Max digital camera batteries (AA)	120
Kodak CRV3 lithium battery	410
Kodak EasyShare Ni-MH rechargeable battery pack	180 (per charge)
2 Kodak Ni-MH rechargeable batteries (AA)	

* Actual battery life may vary based on usage.

Power-Saving Features

If No Activity For	The Camera	To Turn It Back On
1 minute	Screen turns off.	Press the OK button.
8 minutes	Enters auto power off.	Press any button (or insert or remove a card).
3 hours	Turns off.	Turn Mode dial Off, then back on.

Optional AC Adapter

You can purchase an optional Kodak 3-volt AC adapter to power your camera. Use it to save battery power when reviewing and transferring pictures.

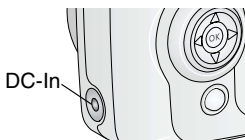

- 1 Connect the AC adapter to the DC-In port.
- 2 Connect the other end of the AC adapter to an electrical outlet.

Purchase batteries and AC adapters at www.kodak.com/go/cx6330accessories.



CAUTION:

Do not use the optional 3-volt AC adapter with the Kodak EasyShare camera dock 6000. It is NOT compatible.

FCC Compliance and Advisory

Kodak EasyShare CX6330 zoom digital camera Tested to comply with FCC Standards. FOR HOME OR OFFICE USE
--

This equipment has been tested and found to comply with the limits for a Class B digital device, pursuant to Part 15 of the FCC Rules. These limits are designed to provide reasonable protection against harmful interference in a residential installation.

This equipment generates, uses, and can radiate radio frequency energy and, if not installed or used in accordance with the instructions, may cause harmful interference to radio communications. However, there is no guarantee that interference will not occur in a particular installation.

If this equipment does cause harmful interference to radio or television reception, which can be determined by turning the equipment off and on, the user is encouraged to try to correct the interference by one or more of the following measures: 1) reorient or relocate the receiving antenna; 2) increase the separation between the equipment and the receiver; 3) connect the equipment to an outlet on a circuit different from that to which the receiver is connected; 4) consult the dealer or an experienced radio/TV technician for additional suggestions.

Any changes or modifications not expressly approved by the party responsible for compliance could void the user's authority to operate the equipment. Where shielded interface cables have been provided with the product or specified additional components or accessories elsewhere defined to be used with the installation of the product, they must be used in order to ensure compliance with FCC regulation.

Canadian DOC Statement

DOC Class B Compliance—This Class B digital apparatus complies with Canadian ICES-003.

Observation des normes-Class B—Cet appareil numérique de la classe B est conforme à la norme NMB-003 du Canada.

Index

Numerics

4-way controller, ii

A

A/V out, iii, 44, 55

AA battery, installing, 4

about

 camera information, 56

 picture, video, 46

AC adapter, 99

accessories

 battery, 97

 buying, 87

 camera dock, 63

 MMC/SD card, 10

 printer dock, 62

advanced digital zoom

 changing, 54

 using, 18

albums, tagging pictures

 for, 27, 34, 41

alkaline batteries, warning, 4

auto

 flash, 19

 focus framing marks, 16

 power-down, 99

B

batteries

 loading, 4

 replacement types, 97

battery

 charge via camera dock, 68

 door location, iv

 extending life, 98

burst, ii, 22

button

 delete, ii, 17

 flash/status, 19

 menu, ii, 11

 OK, 6

 on/off, ii

 review, ii, 37

 self timer/burst, iv, 22

 share, ii, 47

 shutter, i, iv

 zoom, ii, 18

C

cable

 audio/video, 3, 44

 power, camera dock, 65

 USB, 3, 61

- camera dock, 71
 - charging battery, 68
 - connection, 65
 - connector on camera, iv
 - docking camera, 67
 - lights status, 69
 - package contents, 63
 - specifications, 70
 - camera screen
 - picture location icon, 8
 - reviewing pictures, 37
 - reviewing videos, 37
 - status area, 8
 - turning off liveview, 53
 - turning off quickview, 52
 - using as viewfinder, 15
 - Canadian compliance, 100
 - card, memory, 96
 - caring for your camera, 94
 - changing storage location, 11
 - charging battery
 - via camera dock, 68
 - charging lights
 - camera dock, 68
 - checking storage setting, 12
 - cleaning camera, lens, 94
 - clock, setting, 7
 - computer
 - connecting camera, 61
 - connecting camera dock, 65
 - system requirements, 57
 - transfer to, 61, 69
 - connecting
 - camera dock, 65
 - camera to camera dock, 67
 - connector
 - for camera dock, iv
 - contents
 - camera, 3
 - camera dock, 63
 - copy pictures
 - card to memory, 45
 - memory to card, 45
 - to computer via camera dock, 69
 - to computer via USB cable, 61
 - CRV3, 4
 - customer support, 88
 - customizing camera settings, 51
- D**
- date
 - imprinting on pictures, 28
 - setting, 7
 - DCIM folder, card, 96
 - DC-in, ii, iii, 99
 - default settings, 93

- delete button, ii
- deleting
 - by formatting, 56
 - during quickview, 17, 32
 - from internal memory, 39
 - from MMC/SD Card, 39
 - protecting pictures, videos, 41
- digital zoom
 - changing, 54
 - using, 18
- displaying slide show, 43
- disposal, recycling, 94
- dock
 - camera, 63
 - printer, 62
- downloading pictures, 61, 69
- E**
- EasyShare software, 57
- emailing pictures, videos, 49
- error code, 83
- exposure
 - compensation, 24
- external video device
 - setting video out, 55
 - viewing pictures, videos, 44
- F**
- favorites, tagging, 50
- FCC compliance, 100
- file names, card, 96
- firmware
 - upgrading, 94
 - version, 56
- flash
 - settings, 19
 - unit, i
- focus
 - framing marks, 16
- folders, card, 96
- formatting
 - internal memory, 56
 - MMC/SD card, 56
- G**
- guidelines, battery, 97
- H**
- help
 - camera dock, 71
 - software, 88
 - support, 87
 - web links, 87
- I**
- icons

- camera status, 8
- mode dial, 14
- image storage menu, 11
- information
 - about camera, 56
 - about pictures, videos, 46
- installing
 - batteries, 4
 - MMC/SD card, 10
 - software, 59
- internal memory
 - formatting, 56
 - setting storage location, 11
 - storage capacity, 95

K

- Kodak digital camera batteries, 4
- Kodak EasyShare software
 - getting help, 88
 - installing, 59
 - upgrading, 94
- Kodak web sites, 87

L

- language, setting, 55
- LCD (liquid crystal display). *See*
 - camera screen
- lens, i
 - cleaning, 94

light

- camera dock, 68
- ready, ii
- self timer, 21, 35
- sensor, i
- liveview
 - camera screen as
 - viewfinder, 15
 - changing default, 53
- loading
 - batteries, 4
 - MMC/SD card, 10
 - software, 59
- locating holes for dock, iv

M

- Macintosh
 - installing software on, 59
 - system requirements, 58
- magnify picture, 40
- maintenance, camera, 94
- memory
 - inserting card, 10
 - storage capacities, 95
 - storage location setting, 11
- menu
 - button, ii
- menu button, 11
- microphone, i

- MISC folder, card, 96
- MMC/SD card
 - file names, 96
 - formatting, 56
 - inserting, 10
 - printing from, 62
 - setting storage location, 11
 - slot location, iii
 - storage capacities, 95
- mode dial, ii, 14
- monitor, requirements, 57

- N**
- NTSC, video out setting, 55

- O**
- OK button, 6
- online prints, ordering, 62
- optical zoom, 18, 33
- orientation sensor, 29
- overview
 - camera, ii
 - camera modes, 14

- P**
- package contents
 - camera, 3
 - camera dock, 63
- PAL, video out setting, 55

- pictures
 - checking location, 12
 - copying, 45
 - date imprint, 28
 - deleting, 39
 - emailing tagged, 49
 - file naming, 96
 - locating on card, 96
 - magnifying, 40
 - printing, 62
 - printing tagged, 48
 - protecting, 41
 - quality, setting, 25
 - reviewing, 37
 - storage capacity, 95
 - tagging, 27, 34, 41
 - taking, modes, 14
 - transfer via camera dock, 69
 - transfer via USB cable, 61

- power
 - auto off, 99
 - camera, 6
 - camera dock, 65
 - switch, ii

- printer dock, 62
- printing
 - changing default quantity, 52
 - from a card, 62
 - optimizing printer, 87

- order online, 62
- pictures, 62
- tagged pictures, 62
- this user guide, 1
- without computer, 62

product overview, ii

protecting pictures, videos, 41

Q

quality setting, 25

quickview

- turning off, 52
- using, 17, 32

R

ReadMe file, 73

ready light, ii

recycling, disposal, 94

red-eye, flash, 19

regulatory information, 100

replacement batteries, types, 97

requirements

- Macintosh, 58
- Windows-based, 57

resolution, setting, 25

review button, ii, 37

reviewing pictures

- as you take them, 17
- camera screen, 37

- deleting, 39
- magnifying, 40
- protecting, 41
- slide show, 43

reviewing videos

- as you take them, 32
- camera screen, 37
- deleting, 39
- protecting, 41
- slide show, 43

running slide show, 43

S

safety, 94

SD card, inserting, 10

self timer

- button, ii
- light, i
- with pictures, 21
- with videos, 35

sensor, light, i

service and support

- telephone numbers, 88

setting

- date and time, 7
- flash, 19
- language, 55
- picture quality, 25
- picture taking mode, 14

- resolution, 25
 - self timer, 21, 35
 - storage location, 11
 - video out, 55
 - setup mode, using, 51
 - share button, ii, 47
 - shutoff, auto, 99
 - shutter
 - problems, 74
 - self timer delay, 21, 35
 - sleep mode, 99
 - slide show
 - continuous loop, 44
 - problems, 77
 - running, 43
 - software
 - getting help, 88
 - installing, 59
 - upgrading, 94
 - specifications
 - camera, 91
 - camera dock, 70
 - status
 - area, 8
 - screen icons, 8
 - storage location, 12
 - storage capacity, 95
 - strap, wrist, 5
 - support, technical, 88
 - system folder, card, 96
 - system requirements
 - Macintosh, 58
 - Windows, 57
- T**
- tagging
 - favorites, 50
 - for email, 49
 - for print, 48
 - when to tag, 47
 - tagging pictures
 - for albums, 27, 34, 41
 - taking videos, 31
 - telephone support, 88
 - telephoto button, ii
 - television, slide show, 44
 - time, setting, 7
 - timer, shutter delay, 21, 35
 - tips
 - battery guidelines, 97
 - maintenance, 94
 - ReadMe file, 73
 - safety, 94
 - transfer
 - via camera dock, 69
 - via USB cable, 61
 - trash can, deleting, 17, 32
 - tripod socket, iv

- troubleshooting
 - camera dock, 71
- turning camera on and off, 6
- U**
- upgrading software,
 - firmware, 94
- URLs, Kodak web sites, 87
- USB (universal serial bus)
 - connection location, iii
 - transferring pictures, 61
- V**
- video
 - setting video out, 55
- videos
 - checking location, 12
 - copying, 45
 - date display, 46
 - deleting, 39
 - emailing tagged, 49
 - file naming, 96
 - protecting, 41
 - reviewing, 37
 - storage capacities, 95
 - taking, 31
 - transfer to computer, 61, 69
 - viewing, 37
- viewfinder, i, ii
 - using camera screen, 15
- viewing
 - camera information, 56
 - picture, video
 - information, 46
 - viewing picture
 - after taking, 17, 37
 - magnified, 40
 - viewing video, after taking, 32
- W**
- white balance, 92
- wide angle button, ii
- Windows
 - installing software, 59
 - system requirements, 57
- wrist strap, 5
- wrist strap post, i
- Z**
- zoom
 - button, ii
 - changing digital, 54
 - digital, 18
 - optical, 18

Free Manuals Download Website

<http://myh66.com>

<http://usermanuals.us>

<http://www.somanuals.com>

<http://www.4manuals.cc>

<http://www.manual-lib.com>

<http://www.404manual.com>

<http://www.luxmanual.com>

<http://aubethermostatmanual.com>

Golf course search by state

<http://golfingnear.com>

Email search by domain

<http://emailbydomain.com>

Auto manuals search

<http://auto.somanuals.com>

TV manuals search

<http://tv.somanuals.com>