

# JVC

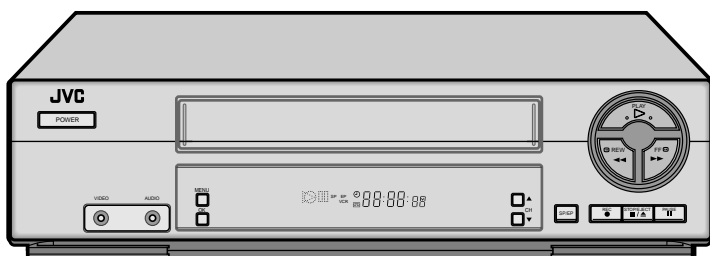

## VIDEO CASSETTE RECORDER

# HR-A47U



**VHS**  
**SQP/B**

## ***INSTRUCTIONS***

**For Customer Use:**

Enter below the Model No. and Serial No. which are located on the rear of cabinet. Retain this information for future reference.

Model No. \_\_\_\_\_



Serial No. \_\_\_\_\_

LPT0414-001B

**Dear Customer,**

Thank you for purchasing the JVC VHS video cassette recorder. Before use, please read the safety information and precautions contained in the following pages to ensure safe use of your new VCR.

**CAUTIONS**

	<b>CAUTION</b> RISK OF ELECTRIC SHOCK DO NOT OPEN	
<p><b>CAUTION:</b> TO REDUCE THE RISK OF ELECTRIC SHOCK. DO NOT REMOVE COVER (OR BACK). NO USER-SERVICEABLE PARTS INSIDE. REFER SERVICING TO QUALIFIED SERVICE PERSONNEL.</p>		



The lightning flash with arrowhead symbol, within an equilateral triangle, is intended to alert the user to the presence of uninsulated "dangerous voltage" within the product's enclosure that may be of sufficient magnitude to constitute a risk of electric shock to persons.



The exclamation point within an equilateral triangle is intended to alert the user to the presence of important operating and maintenance (servicing) instructions in the literature accompanying the appliance.

**WARNING:**  
**TO PREVENT FIRE OR SHOCK HAZARD, DO NOT EXPOSE THIS UNIT TO RAIN OR MOISTURE.**

**CAUTION:**

This video cassette recorder should be used with AC 120V~, 60Hz only.  
To prevent electric shocks and fire hazards, DO NOT use any other power source.

**CAUTION:**

TO PREVENT ELECTRIC SHOCK, MATCH WIDE BLADE OF PLUG TO WIDE SLOT, FULLY INSERT.

**ATTENTION:**

POUR ÉVITER LES CHOCS ÉLECTRIQUES, INTRODUIRE LA LAME LA PLUS LARGE DE LA FICHE DANS LA BORNE CORRESPONDANTE DE LA PRISE ET POUSSER JUSQU'AU FOND.

**Note to CATV system installer:**

This reminder is provided to call the CATV system installer's attention to Article 820-40 of the NEC that provides guidelines for proper grounding and, in particular, specifies that the cable ground shall be connected to the grounding system of the building, as close to the point of cable entry as practical.

**CAUTION:**

Changes or modifications not approved by JVC could void user's authority to operate the equipment.

**Declaration of Conformity**

**Model Number** :HR-A47U  
**Trade Name** :JVC  
**Responsible Party** :JVC Americas Corp.  
**Address** :1700 Valley Road Wayne,  
N.J. 07470  
**Telephone Number** :973-315-5000

This device complies with Part 15 of FCC Rules. Operation is subject to the following two conditions:  
(1) This device may not cause harmful interference, and (2) this device must accept any interference received, including interference that may cause undesired operation.

**Failure to heed the following precautions may result in damage to the VCR, Remote or video cassette.**

1. **DO NOT** place the VCR . . .
  - ... in an environment prone to extreme temperatures or humidity.
  - ... in direct sunlight.
  - ... in a dusty environment.
  - ... in an environment where strong magnetic fields are generated.
  - ... on a surface that is unstable or subject to vibration.
2. **DO NOT** block the VCR's ventilation openings.
3. **DO NOT** place heavy objects on the VCR or on the Remote.
4. **DO NOT** place anything which might spill on the top of the VCR or on the Remote.
5. **AVOID** violent shocks to the VCR during transport.



- Cassettes marked "VHS" (or "S-VHS") can be used with this video cassette recorder. However, S-VHS recording is not possible with this model.
- This model is equipped with SQPB (S-VHS QUASI PLAYBACK) that makes it possible to play back S-VHS recordings with regular VHS resolution.
- HQ VHS is compatible with existing VHS equipment.
- As an ENERGY STAR® Partner, JVC has determined that this product or product model meets the ENERGY STAR® guidelines for energy efficiency.

# IMPORTANT PRODUCT SAFETY INSTRUCTIONS

Electrical energy can perform many useful functions. But improper use can result in potential electrical shock or fire hazards. This product has been engineered and manufactured to assure your personal safety. In order not to defeat the built-in safeguards, observe the following basic rules for its installation, use and servicing.

## ATTENTION:

Follow and obey all warnings and instructions marked on your product and its operating instructions. For your safety, please read all the safety and operating instructions before you operate this product and keep this booklet for future reference.

## INSTALLATION

### 1. Grounding or Polarization

(A) Your product may be equipped with a polarized alternating-current line plug (a plug having one blade wider than the other). This plug will fit into the power outlet only one way. This is a safety feature.

If you are unable to insert the plug fully into the outlet, try reversing the plug. If the plug should still fail to fit, contact your electrician to replace your obsolete outlet. Do not defeat the safety purpose of the polarized plug.

(B) Your product may be equipped with a 3-wire grounding-type plug, a plug having a third (grounding) pin. This plug will only fit into a grounding-type power outlet. This is a safety feature.

If you are unable to insert the plug into the outlet, contact your electrician to replace your obsolete outlet. Do not defeat the safety purpose of the grounding-type plug.

### 2. Power Sources

Operate your product only from the type of power source indicated on the marking label. If you are not sure of the type of power supply to your home, consult your product dealer or local power company. If your product is intended to operate from battery power, or other sources, refer to the operating instructions.

### 3. Overloading

Do not overload wall outlets, extension cords, or integral convenience receptacles as this can result in a risk of fire or electric shock.

### 4. Power Cord Protection

Power supply cords should be routed so that they are not likely to be walked on or pinched by items placed upon or against them, paying particular attention to cords at plugs, convenience receptacles, and the point where they exit from the product.

### 5. Ventilation

Slots and openings in the cabinet are provided for ventilation. To ensure reliable operation of the product and to protect it from overheating, these openings must not be blocked or covered.

- Do not block the openings by placing the product on a bed, sofa, rug or other similar surface.
- Do not place the product in a built-in installation such as a bookcase or rack unless proper ventilation is provided or the manufacturer's instructions have been adhered to.

### 6. Wall or Ceiling Mounting

The product should be mounted to a wall or ceiling only as recommended by the manufacturer.

## ANTENNA INSTALLATION INSTRUCTIONS

### 1. Outdoor Antenna Grounding

If an outside antenna or cable system is connected to the product, be sure the antenna or cable system is grounded so as to provide some protection against voltage surges and built-up static charges. Article 810 of the National Electrical Code, ANSI/NFPA 70, provides information with regard to proper grounding of the mast and supporting structure, grounding of the lead-in wire to an antenna discharge unit, size of grounding connectors, location of antenna discharge unit, connection to grounding electrodes, and requirements for the grounding electrode.

### 2. Lightning

For added protection for this product during a lightning storm, or when it is left unattended and unused for long periods of time, unplug it from the wall outlet and disconnect the antenna or cable system. This will prevent damage to the product due to lightning and power-line surges.

### 3. Power Lines

An outside antenna system should not be located in the vicinity of overhead power lines or other electric light or power circuits, or where it can fall into such power lines or circuits. When installing an outside antenna system, extreme care should be taken to keep from touching such power lines or circuits as contact with them might be fatal.

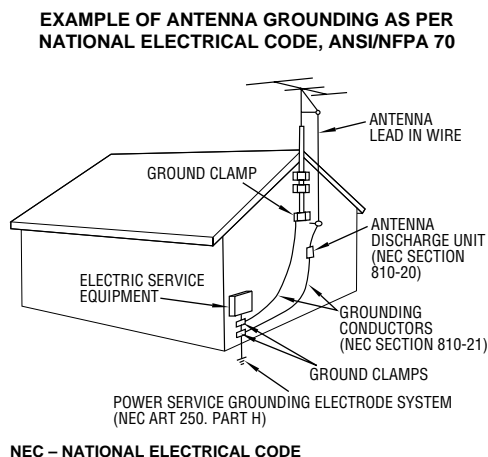

## USE

### 1. Accessories

To avoid personal injury:

- Do not place this product on an unstable cart, stand, tripod, bracket, or table. It may fall, causing serious injury to a child or adult, and serious damage to the product.
- Use only with a cart, stand, tripod, bracket, or table recommended by the manufacturer or sold with the product.
- Use a mounting accessory recommended by the manufacturer and follow the manufacturer's instructions for any mounting of the product.
- Do not try to roll a cart with small casters across thresholds or deep-pile carpets.

### 2. Product and Cart Combination

A product and cart combination should be moved with care. Quick stops, excessive force, and uneven surfaces may cause the product and cart combination to overturn.

PORTABLE CART WARNING  
(Symbol provided by RETAC)



### 3. Water and Moisture

Do not use this product near water—for example, near a bath tub, wash bowl, kitchen sink or laundry tub, in a wet basement, or near a swimming pool and the like.

### 4. Object and Liquid Entry

Never push objects of any kind into this product through openings as they may touch dangerous voltage points or short-out parts that could result in a fire or electric shock. Never spill liquid of any kind on the product.

### 5. Attachments

Do not use attachments not recommended by the manufacturer of this product as they may cause hazards.

### 6. Cleaning

Unplug this product from the wall outlet before cleaning. Do not use liquid cleaners or aerosol cleaners. Use a damp cloth for cleaning.

### 7. Heat

The product should be situated away from heat sources such as radiators, heat registers, stoves, or other products (including amplifiers) that produce heat.

## SERVICING

### 1. Servicing

If your product is not operating correctly or exhibits a marked change in performance and you are unable to restore normal operation by following the detailed procedure in its operating instructions, do not attempt to service it yourself as opening or removing covers may expose you to dangerous voltage or other hazards. Refer all servicing to qualified service personnel.

### 2. Damage Requiring Service

Unplug this product from the wall outlet and refer servicing to qualified service personnel under the following conditions:

- a. When the power supply cord or plug is damaged.
- b. If liquid has been spilled, or objects have fallen into the product.
- c. If the product has been exposed to rain or water.
- d. If the product does not operate normally by following the operating instructions. Adjust only those controls that are covered by the operating instructions as an improper adjustment of other controls may result in damage and will often require extensive work by a qualified technician to restore the product to its normal operation.
- e. If the product has been dropped or damaged in any way.
- f. When the product exhibits a distinct change in performance—this indicates a need for service.

### 3. Replacement Parts

When replacement parts are required, be sure the service technician has used replacement parts specified by the manufacturer or which have the same characteristics as the original part. Unauthorized substitutions may result in fire, electric shock or other hazards.

### 4. Safety Check

Upon completion of any service or repairs to this product, ask the service technician to perform safety checks to determine that the product is in safe operating condition.

## HOW TO USE THIS INSTRUCTION MANUAL

- The Index on pages 35 – 38 lists frequently-used terms, and the number of the page on which they are used or explained in the manual. This section also illustrates the controls and connections on the front and rear panel, the front display panel and the Remote.
- The  mark signals a reference to another page for instructions or related information.
- Operation buttons necessary for the various procedures are clearly indicated through the use of illustrations at the beginning of each major section.

## BEFORE YOU INSTALL YOUR NEW VCR . . .

. . . please read the sections/literature listed below.

- "CAUTIONS" on page 2.
- "IMPORTANT PRODUCT SAFETY INSTRUCTIONS" on the previous page.

<b>I</b>	<b>NSSTALLING YOUR NEW VCR</b>	<b>6</b>
	<b>Basic Connections</b> .....	<b>6</b>
<b>I</b>	<b>NITIAL SETTINGS</b>	<b>8</b>
	<b>Plug &amp; Play Setting</b> .....	<b>8</b>
	<b>Language Setting</b> .....	<b>9</b>
	<b>Clock Setting</b> .....	<b>10</b>
	Preparations .....	10
	Setting clock semiautomatically	
	— Semiauto Clock Set .....	11
	Setting clock manually — Manual Clock Set .....	12
	<b>Tuner Setting</b> .....	<b>13</b>
	Setting channels automatically	
	— Auto Channel Set .....	13
	Setting channels manually	
	— Manual Channel Set .....	14
<b>B</b>	<b>ASIC PLAYBACK AND RECORDING</b>	<b>15</b>
	<b>Basic Playback</b> .....	<b>15</b>
	<b>Basic Playback Features</b> .....	<b>16</b>
	Changing display information .....	16
	Checking tape position .....	16
	Playing back tape repeatedly — Repeat Play .....	16
	Adjusting tracking condition	
	— Tracking Adjustments .....	17
	Automatic operations after rewinding	
	— Next Function Memory .....	17
	Locating beginning of recordings — Index Search ...	18
	Locating beginning of timer recordings	
	— Instant Review .....	18
	<b>Basic Recording</b> .....	<b>19</b>
	<b>Basic Recording Features</b> .....	<b>20</b>
	Changing display information .....	20
	Specifying recording length	
	— Instant Timer Recording (ITR) .....	20
	Watching one program while recording another .....	20
	Showing on-screen display .....	21
<b>S</b>	<b>SPECIAL EFFECT PLAYBACK</b>	<b>22</b>
	<b>Special Effect Playback</b> .....	<b>22</b>
	Locating particular scene rapidly — Picture Search ....	22
	■ High-Speed Picture Search .....	22
	■ Variable-Speed Picture Search .....	22
	Viewing still picture — Still Picture Playback .....	23
	Skipping unwanted portions — Skip Search .....	23
	Viewing still picture frame by frame	
	— Frame-by-Frame Playback .....	23
	Viewing slow motion picture	
	— Slow Motion Playback .....	23
<b>T</b>	<b>IMER RECORDING</b>	<b>24</b>
	<b>Express Timer Programing</b> .....	<b>24</b>
	Checking program settings .....	26
	Canceling or changing program settings .....	26
	When programs overlap each other .....	27
<b>O</b>	<b>THER USEFUL FUNCTIONS</b>	<b>28</b>
	<b>Useful Function Settings</b> .....	<b>28</b>
	■ AUTO PICTURE .....	29
	■ PICTURE CONTROL .....	29
	■ AUTO TIMER .....	29
	■ SUPERIMPOSE .....	29
	■ AUTO SP→EP TIMER .....	30
	■ VIDEO STABILIZER .....	30
	■ BLUE BACK .....	30
<b>E</b>	<b>DITING</b>	<b>31</b>
	<b>Edit To Or From Another VCR</b> .....	<b>31</b>
<b>T</b>	<b>ROUBLESHOOTING</b>	<b>32</b>
	Questions and answers .....	34
<b>I</b>	<b>NDIX</b>	<b>35</b>
	List of terms .....	35
	Front panel .....	36
	Front display panel .....	36
	Rear panel .....	37
	On-screen display .....	37
	Remote .....	38
<b>S</b>	<b>PECIFICATIONS</b>	<b>39</b>
<b>F</b>	<b>OR SERVICING (Only in U.S.A.)</b>	<b>40</b>
<b>W</b>	<b>ARRANTY (Only in U.S.A.)</b>	<b>41</b>

# Basic Connections

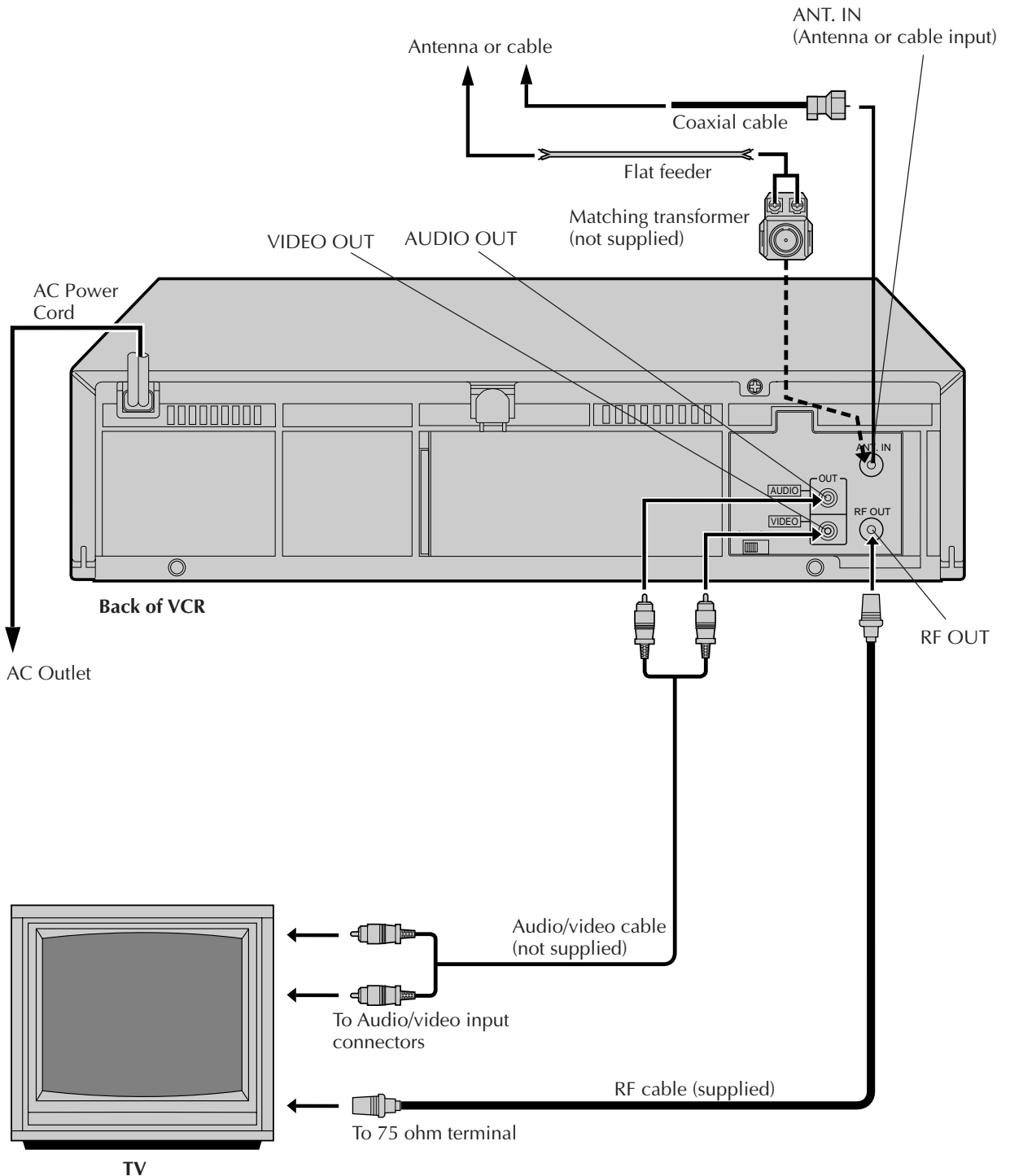

## Check contents

Make sure the package contains all of the accessories listed in "SPECIFICATIONS" (☞ pg. 39).

## Situate VCR

Place the VCR on a stable, horizontal surface.

## Connect VCR to TV

The following connections are required.

### RF Connection

- ❶ Disconnect the TV antenna from the TV.
- ❷ Connect the TV antenna cable to the ANT. IN terminal on the rear of the VCR.
- ❸ Connect the supplied RF cable between the RF OUT terminal on the rear of the VCR and the TV's antenna input terminal.

**AV Connection** (improves picture quality during tape playback.)

*If your TV is equipped with audio/video input connectors*

- ❶ Connect the antenna, VCR and TV as shown in the illustration.
- ❷ Connect an audio/video cable between the AUDIO/VIDEO OUT connectors on the rear of the VCR and the audio/video input connectors on the TV.

## Connect VCR to power source

Connect the AC power plug to an AC outlet.

- The clock and tuner channels will automatically be set when the antenna is connected and when the AC power cord is first connected to an AC power outlet (☞ pg. 8). (If "Auto" or "CH" is displayed on the front display panel before the VCR is turned on, the clock and tuner channels are being set automatically. Wait until the clock time is displayed on the front display panel before turning on the VCR.)

## Final preparation for use

Turn on the VCR and set the CH3-CH4 switch on the rear (shown below) to either CH3 or CH4 correctly.

- The CH3-CH4 switch is preset to the CH3 position.  
Set to CH4 if CH3 is used for broadcasting in your area. (To view the picture from this VCR through this channel, select the same channel on the TV with the CH3-CH4 switch setting on the VCR.)
- You can now perform basic playback (☞ pg. 15) or basic recording (☞ pg. 19).

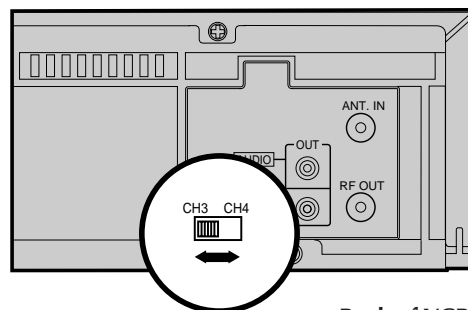

Back of VCR

## NOTES:

- The VCR channel is the channel on which you can watch the picture from the VCR on the TV when only using the RF connection. The VCR's CH3-CH4 switch, on the back of the VCR, sets the VCR channel to CH3 or CH4.
- Even if you are using audio/video cables to connect your VCR to your TV, you must also connect it using the RF cable. This will ensure that you can record one show while watching another (☞ pg. 20).
- For full identification of the VCR's rear panel, refer to the Index (☞ pg. 37).

# Plug & Play Setting

## Auto Clock Set/Auto Tuner Set

### ATTENTION

- If you use a cable box, Plug & Play will not function; set the clock and tuner channels separately. (☞ pg.10 – 14)
- It takes several minutes for the VCR to complete the Plug & Play setting.
- Do not press any buttons on the front panel or on the Remote while Plug & Play is in progress.



This VCR sets the clock and tuner channels automatically when AC power cord is first connected to an AC outlet. The antenna cable must be connected for the Plug & Play setting.

The time and date can be set automatically by the clock setting data transmitted from one of the regular TV broadcast channels. We call this TV channel the “host channel” and it is a PBS channel in your area.

### Perform Plug & Play setup

**Connect the antenna cable to the VCR (☞ pg. 6). Then connect the AC power cord to an AC outlet. Do not turn on the VCR.**

The clock and tuner channels will be set automatically.

### NOTES:

- Auto Clock Set is performed first. “Auto” blinks on the front display panel during Auto Clock Set.
- Auto Channel Set is performed next. Auto Channel Set scans all the channels that are receivable by your VCR. During Auto Channel Set, the channel numbers are displayed as they are scanned and set.
- When Plug & Play setting has been complete successfully, the correct clock time is displayed. If you perform Plug & Play setting successfully, there is no need to perform the clock (☞ pg. 10) and tuner (☞ pg. 13) settings. If, however, you want to add or delete channels, refer to Manual Channel Set on page 14.

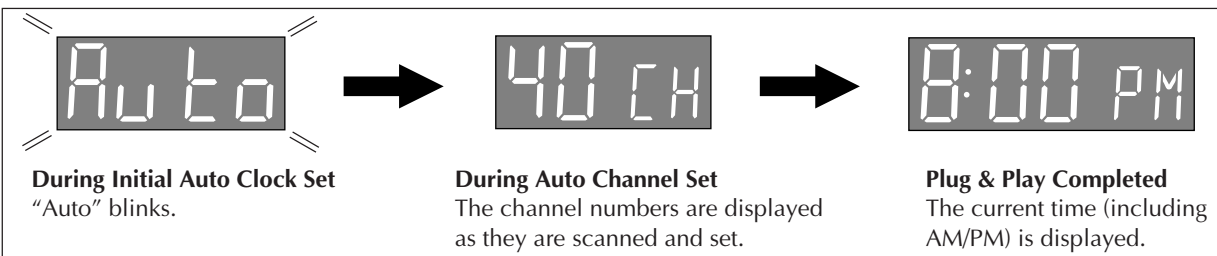

\* If an incorrect clock time or “-:-” appears on the display panel, see “What to do if Plug & Play setting failed” below.

### INFORMATION

- If “AUTO CLOCK” is set to “ON” on the Clock Set screen on page 11, the clock will be adjusted automatically by the host channel every hour (except 11:00 PM, midnight, 1:00 AM and 2:00 AM) using the incoming PBS channel clock setting data. (This automatic clock adjustment can only be performed when the VCR is turned off. The clock will be adjusted just on these hours — on the time displayed on the front panel display, not on the actual real time.) The default setting of “AUTO CLOCK” is “ON”.
- If the memory backup fails, because a power outage occurs or because the AC power cord is unplugged, Plug & Play will be performed when power is restored to the VCR.
- Poor antenna or cable signal may prevent the VCR from receiving the Auto clock setting data from the PBS channel. If this function is taking a considerable amount of time, it may be necessary to perform the Semiauto or Manual Clock Set procedure.

### What to do if Plug & Play setting failed

- If an incorrect time is displayed on the front display panel, you may be receiving the clock setting data of a PBS channel from an adjacent time zone, or an incorrect PBS channel from a cable TV system. In this case, perform the Semiauto (☞ pg. 11) or Manual Clock Set (☞ pg. 12) procedure.
- If “-:-” appears on the front display panel, your antenna cable may not be connected to the VCR or there may not be a Host PBS signal available in your area. Ensure that the antenna cable is connected correctly. Then turn on and off the VCR; the Plug & Play setting will be automatically reactivated. If Plug & Play setting is not performed though the antenna cable is connected correctly, perform Manual Clock Set (☞ pg. 12) and Auto Channel Set or Manual Channel Set (☞ pg. 13 or 14).



# Language Setting

Turn on the VCR and the TV, and select the VCR channel 3 or 4 (or AV mode) on the TV.

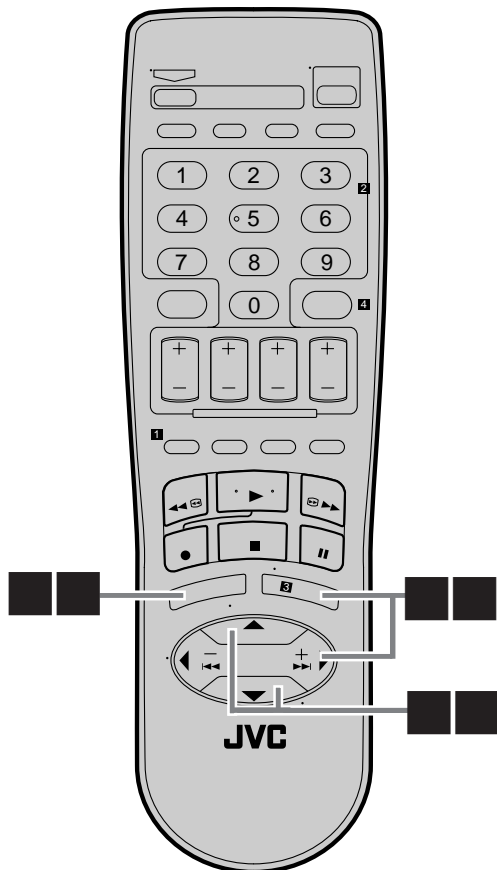
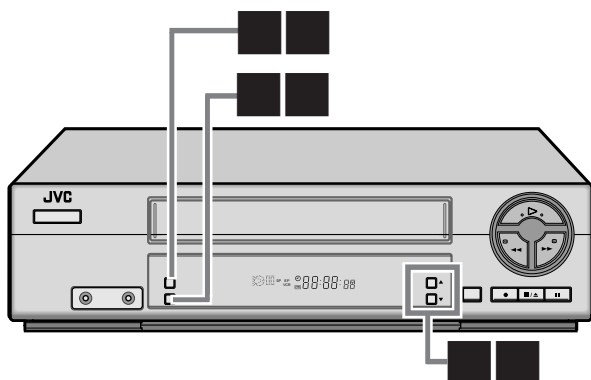

This VCR offers you the language choice to view menus and some messages (excluding the on-screen display superimposed on the TV screen) — in English, Spanish or French.

Select the desired language using the following procedure. The default setting is “ENGLISH”.

## Access Main Menu screen

Press **MENU**.

## Access Initial Set screen

### On the front panel:

Press **CH▲▼** to move the highlight bar (arrow) to “INITIAL SET”, then press **OK**.

### On the Remote:

Press **SHUTTLE PLUS**

**▲▼** to move the highlight bar (arrow) to “INITIAL SET”, then press **OK** or **SHUTTLE PLUS ▶**.

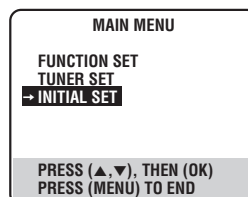

## Select language

### On the front panel:

Press **CH▲▼** to move the highlight bar (arrow) to “LANGUAGE”, then press **OK** repeatedly until the desired language is selected.

### On the Remote:

Press **SHUTTLE PLUS ▲▼** to move the highlight bar (arrow) to “LANGUAGE”, then press **OK** or **SHUTTLE PLUS ▶** repeatedly until the desired language is selected.

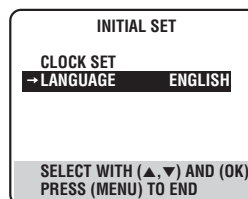

## Return to normal screen

Press **MENU**.

# Clock Setting

Turn on the VCR and the TV, and select the VCR channel 3 or 4 (or AV mode) on the TV.

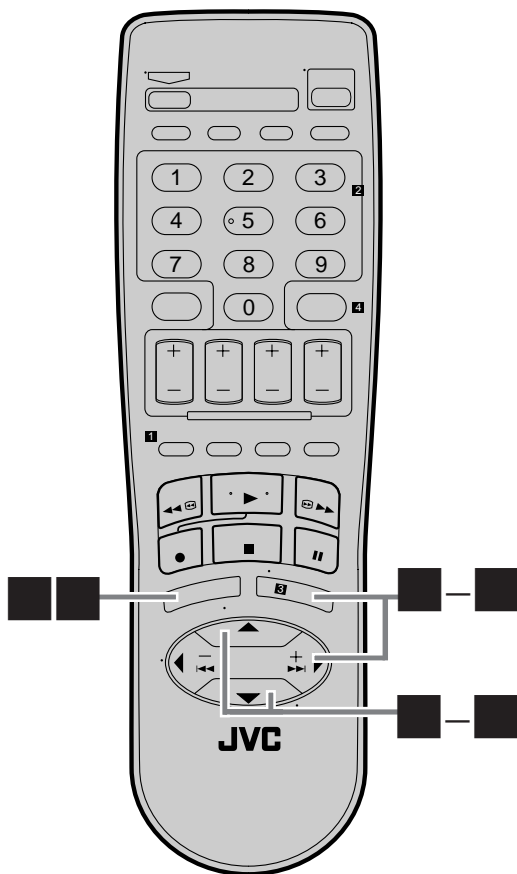
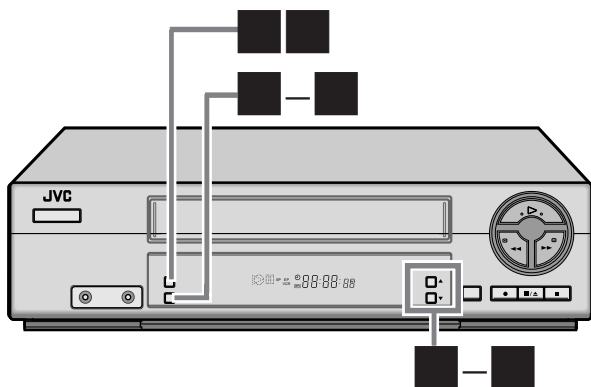

Perform clock setting only if the clock has not been set correctly by the Plug & Play setting or if you use a cable box.

Access the Clock Set screen to perform the Semiauto or Manual Clock Set. Each procedure starts from step ■ after preparation steps below are finished.

If you use a cable box, set the clock manually. (pg. 12)

## Preparations

### Access Main Menu screen

Press **MENU**.

### Access Initial Set screen

#### On the front panel:

Press **CH▲▼** to move the highlight bar (arrow) to "INITIAL SET", then press **OK**.

#### On the Remote:

Press **SHUTTLE PLUS**

▲▼ to move the highlight bar (arrow) to "INITIAL SET", then press **OK** or **SHUTTLE PLUS ▶**.

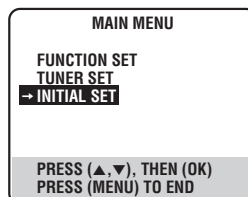

### Select clock set

#### On the front panel:

Press **CH▲▼** to move the highlight bar (arrow) to "CLOCK SET", then press **OK**.

#### On the Remote:

Press **SHUTTLE PLUS**

▲▼ to move the highlight bar (arrow) to "CLOCK SET", then press **OK** or **SHUTTLE PLUS ▶**.

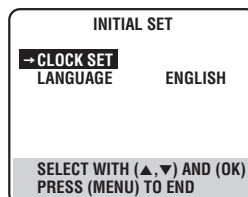

## Setting clock semiautomatically

### — Semiauto Clock Set

You can change the host channel/D.S.T./time zone setting manually.

First follow steps ■ to ■ on page 10, then go to the following steps.

### Set Auto Clock to ON

#### On the front panel:

Press **OK** to move the highlight bar to "AUTO CLOCK", then press

**CH▲▼** so that "ON" is selected.

#### On the Remote:

Press **SHUTTLE PLUS ►** to move the highlight bar to "AUTO CLOCK", then press **SHUTTLE PLUS ▲▼** so that "ON" is selected.

Then;

To select the host channel — go to step ■.

To select the D.S.T. mode — go to step ■.

To select the time zone — go to step ■.

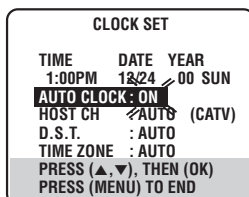

### NOTE:

The time that has been set previously will be erased when "AUTO CLOCK", "HOST CH", "D.S.T." or "TIME ZONE" setting is changed.

### Select host channel

You can either select "AUTO" or enter a PBS channel number.

#### On the front panel:

Press **OK** to move the highlight bar to "HOST CH", then press **CH▲▼** repeatedly until "AUTO" or the desired PBS channel number is selected.

#### On the Remote:

Press **SHUTTLE PLUS ►** to move the highlight bar to "HOST CH", then press **SHUTTLE PLUS ▲▼** until "AUTO" or the desired PBS channel number is selected.

### NOTE:

Some PBS channels do not transmit clock setting data.

### Select D.S.T. mode

You have three choices:

**AUTO**— Select if you want to adjust your VCR's clock automatically by the incoming signal from the host channel. (Auto Daylight Saving Time\*)

**ON**— Adjustment will be made by the clock itself.

**OFF**— Select when Daylight Saving Time does not apply to you.

#### On the front panel:

Press **OK** to move the highlight bar to "D.S.T.", then press **CH▲▼** repeatedly until the desired setting is selected.

#### On the Remote:

Press **SHUTTLE PLUS ►** to move the highlight bar to "D.S.T.", then press **SHUTTLE PLUS ▲▼** repeatedly until the desired setting is selected.

### Select time zone

You can select the time zone automatically or manually.

#### On the front panel:

Press **OK** to move the highlight bar to "TIME ZONE", then press **CH▲▼** repeatedly until "AUTO" or the desired time zone is selected.

Each time you press the button, the time zone changes as follows:

→ AUTO → ATLANTIC → EASTERN → CENTRAL  
→ MOUNTAIN → PACIFIC → ALASKA  
→ HAWAII → (back to the beginning)

#### On the Remote:

Press **SHUTTLE PLUS ►** to move the highlight bar to "TIME ZONE", press **SHUTTLE PLUS ▲▼** repeatedly until "AUTO" or the desired time zone is selected (see above).

### NOTE:

If an incorrect clock time is displayed by the Plug & Play setting, you may be receiving the clock setting data of a PBS channel from an adjacent time zone or from an incorrect PBS channel from a cable TV system. If you selected "AUTO" for the host channel in step ■, be sure to select the correct time zone manually.

### Return to normal screen

Press **MENU**.

#### \* Auto Daylight Saving Time

This function enables automatic adjustment of the VCR's clock at the start and end of Daylight Saving Time.

With Auto DST activated, . . .

. . . on the first Sunday of April at 2:00 AM, the clock is adjusted to 3:00 AM.

. . . on the last Sunday of October at 2:00 AM, the clock is adjusted to 1:00 AM.

#### IMPORTANT

Turn off the VCR after performing Semiauto Clock Set. "Auto" will appear on the front display panel while the clock is being set. The current clock time will appear automatically when the clock setting is complete.

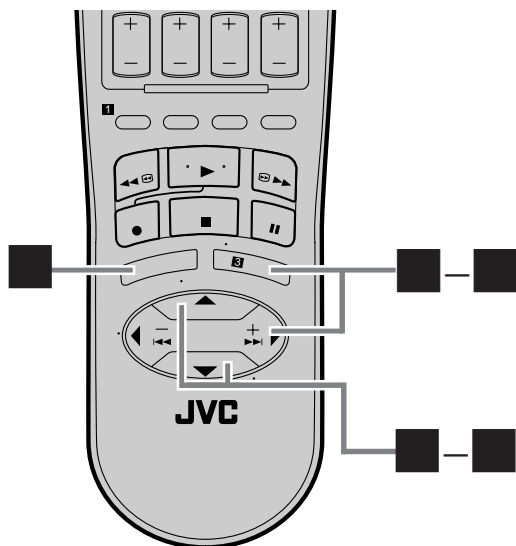
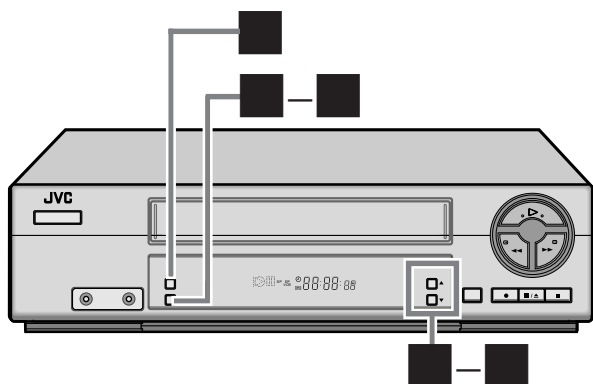

## Setting clock manually

### — Manual Clock Set

First follow steps ■ to ■ on page 10, then go to the following steps.

#### Set time

**On the front panel:**  
Press **CH▲▼** until the desired time appears, then press **OK**.

**On the Remote:**  
Press **SHUTTLE PLUS ▲▼** until the desired time appears, then press **OK** or **SHUTTLE PLUS ►**.

- Holding **CH ▲▼** or **SHUTTLE PLUS ▲▼** changes the time in 30-minute intervals.
- When the time is entered manually, "AUTO CLOCK" is automatically set to "OFF", and "HOST CH" and "TIME ZONE" disappear.

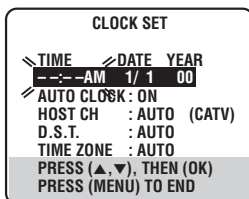

#### Set date

**On the front panel:**  
Press **CH▲▼** until the desired date appears, then press **OK**.

**On the Remote:**  
Press **SHUTTLE PLUS ▲▼** until the desired date appears, then press **OK** or **SHUTTLE PLUS ►**.

- Holding **CH ▲▼** or **SHUTTLE PLUS ▲▼** changes the date in 15-day intervals.

#### Set year

**On the front panel:**  
Press **CH▲▼** until the desired year appears, then press **OK** twice.

**On the Remote:**  
Press **SHUTTLE PLUS ▲▼** until the desired year appears, then press **OK** or **SHUTTLE PLUS ►** twice.

#### Select D.S.T. mode

You can select either "ON" or "OFF".

- ON**— Adjustment will be made by the built-in clock itself.
- OFF**— Select when Daylight Saving Time does not apply to you.

**On the front panel:**  
Press **CH▲▼** to select the desired setting.

**On the Remote:**  
Press **SHUTTLE PLUS ▲▼** to select the desired setting.

#### Start clock

Press **MENU** and normal screen appears.

#### To make corrections any time during the process

Press **OK** or **SHUTTLE PLUS ►** repeatedly until the item you want to change blinks, then press **CH ▲▼** or **SHUTTLE PLUS ▲▼**.

# Tuner Setting

Turn on the VCR and the TV, and select the VCR channel 3 or 4 (or AV mode) on the TV.

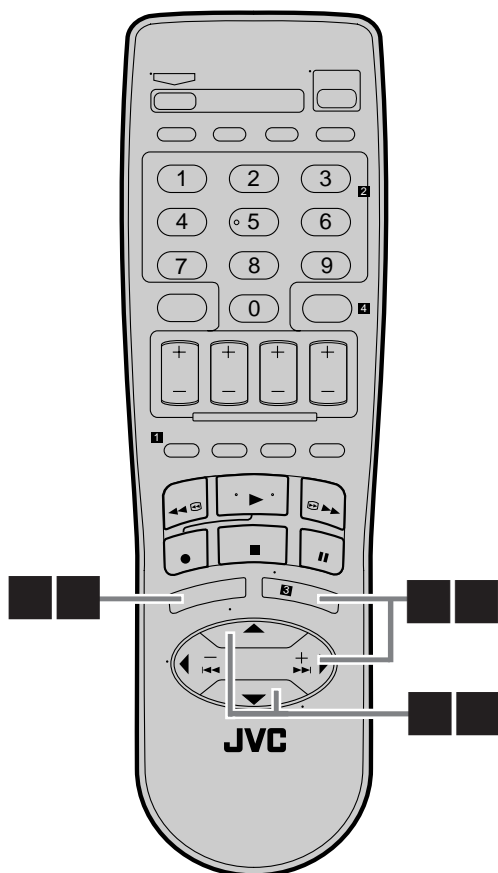
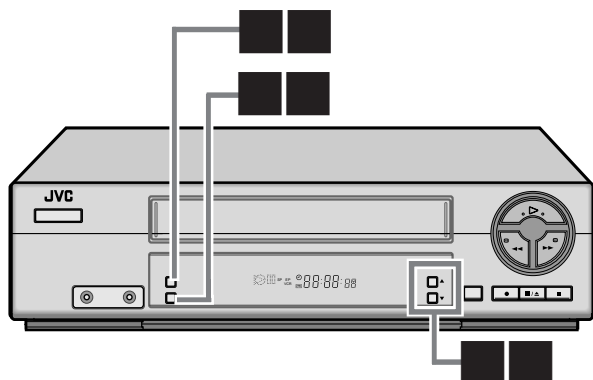

## Setting channels automatically — Auto Channel Set

Use Auto Channel Set only if channels have not been set correctly by the Plug & Play setting. If you want to add or delete channels, use Manual Channel Set (pg. 14).

### Access Main Menu screen

Press **MENU**.

### Access Tuner Set screen

#### On the front panel:

Press **CH▲▼** to move the highlight bar (arrow) to "TUNER SET", then press **OK**.

#### On the Remote:

Press **SHUTTLE PLUS**

**▲▼** to move the highlight bar (arrow) to "TUNER SET", then press **OK** or **SHUTTLE PLUS ►**.

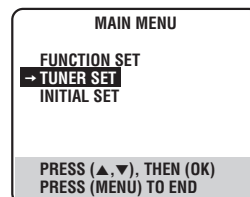

### Perform Auto Channel Set

You can automatically set the receivable channels in your area in the order of their frequencies.

#### On the front panel:

Press **CH▲▼** to move the highlight bar (arrow) to "AUTO CHANNEL SET", then press **OK**.

#### On the Remote:

Press **SHUTTLE PLUS**

**▲▼** to move the highlight bar (arrow) to "AUTO CHANNEL SET", then press **OK** or **SHUTTLE PLUS ►**.

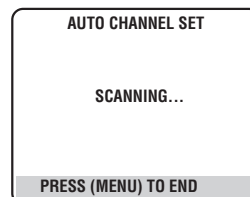
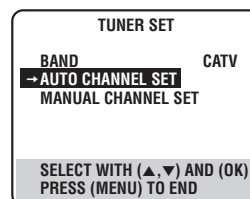

### NOTES:

- When Auto Channel Set is complete, "SCAN COMPLETED" appears on screen.
- If the scan was unsuccessful, "SCAN COMPLETED-NO SIGNAL" appears on screen. Check the connections and start again.

### Return to normal screen

Press **MENU**.

### INFORMATION

The VCR selects the correct band (TV or CATV) automatically during Auto Channel Set. The selected band will be displayed on the right side of "BAND" on the Tuner Set screen.

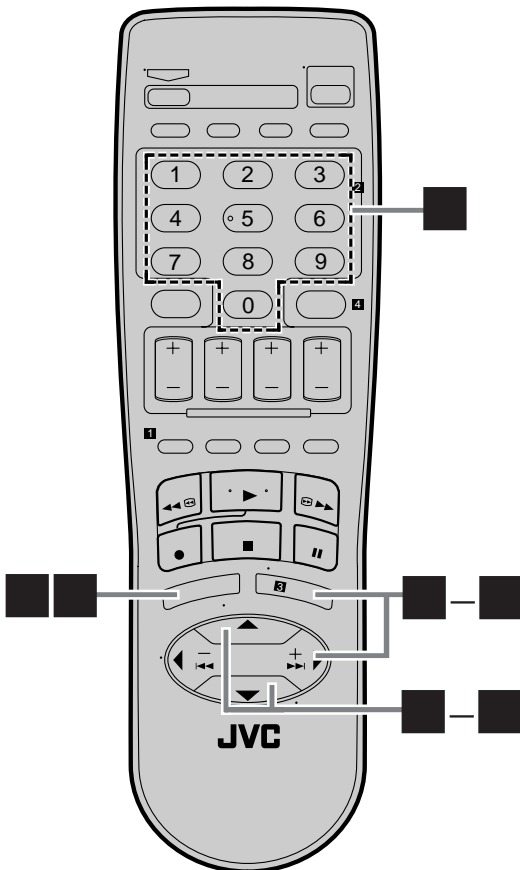
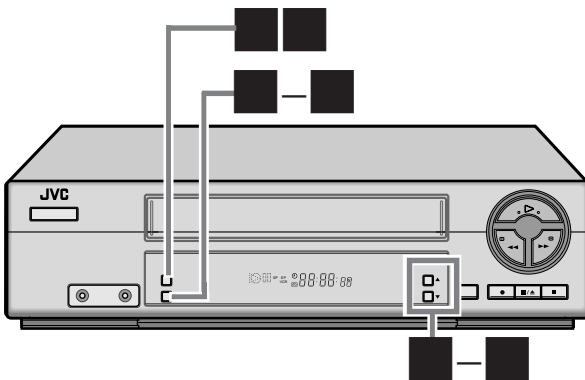

## Access Tuner Set screen

### On the front panel:

Press **CH▲▼** to move the highlight bar (arrow) to "TUNER SET", then press **OK**.

### On the Remote:

Press **SHUTTLE PLUS ▲▼** to move the highlight bar (arrow) to "TUNER SET", then press **OK** or **SHUTTLE PLUS ▶**.

## Access Manual Channel Set screen

### On the front panel:

Press **CH▲▼** to move the highlight bar (arrow) to "MANUAL CHANNEL SET", then press **OK**.

### On the Remote:

Press **SHUTTLE PLUS ▲▼** to move the highlight bar (arrow) to "MANUAL CHANNEL SET", then press **OK** or **SHUTTLE PLUS ▶**.

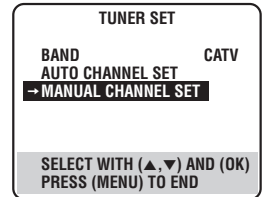

## Add or skip desired channels

### To add channels

#### On the Remote ONLY:

- 1 Press the **Number** keys to input a channel number you want to add.
- 2 Press **OK** or **SHUTTLE PLUS ▶** to set to "ADD".
- 3 Repeat **1** and **2** to add other channels.

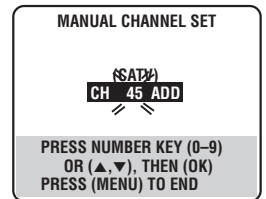

### To skip channels

#### On the front panel:

- 1 Press **CH▲▼** to select a channel number you want to skip.
- 2 Press **OK** to set to "SKIP".
- 3 Repeat **1** and **2** to skip other channels.

#### On the Remote:

- 1 Press the **Number** keys or **SHUTTLE PLUS ▲▼** to input a channel number you want to skip.
- 2 Press **OK** or **SHUTTLE PLUS ▶** to set to "SKIP".
- 3 Repeat **1** and **2** to skip other channels.

## Return to normal screen

Press **MENU**.

## Setting channels manually

### — Manual Channel Set

You can add the channels you want or delete the channels you do not want manually.

## Access Main Menu screen

Press **MENU**.

# Basic Playback

Turn on the VCR and the TV, and select the VCR channel 3 or 4 (or AV mode) on the TV.

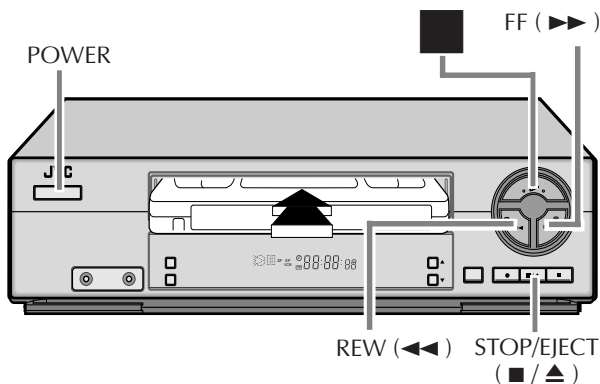

## Load a cassette

Make sure the window side is up, the rear label side is facing you and the arrow on the front of the cassette is pointing towards the VCR. Do not apply too much pressure when inserting.

- The VCR turns on automatically.
- The counter is automatically reset to "0:00:00".
- If the cassette's record safety tab has been removed, playback begins automatically.

## Start playback

Press **PLAY** (▶).

- Tape speed (SP or EP) is automatically detected.

## To stop playback

Press **STOP** (■) on the Remote or **STOP/EJECT** (■/▲) on the front panel.

## To rewind the tape

Press **REW** (◀◀) – when the tape is not running.

## To fast-forward the tape

Press **FF** (▶▶) – when the tape is not running.

## To eject the tape

Press **STOP/EJECT** (■/▲) on the front panel when the tape is not running.

- You can also eject the cassette with the VCR turned off.

## To turn off the VCR

Press **POWER**.

## INFORMATION

This VCR is equipped with SQPB (S-VHS QUASI PLAYBACK) that lets you watch tapes recorded in the S-VHS format with regular VHS resolution.

- SQPB does not deliver Super VHS resolution.
- S-VHS recording is not possible with this VCR.

## Usable cassettes

- Full-Size VHS
- T-30 (ST-30\*\*)
  - T-60 (ST-60\*\*)
  - T-90
  - T-120 (ST-120\*\*)
  - T-160 (ST-160\*\*)
  - ST-210\*\*

- Compact VHS\*
- TC-20 (ST-C20\*\*)
  - TC-30 (ST-C30\*\*)
  - TC-40 (ST-C40\*\*)

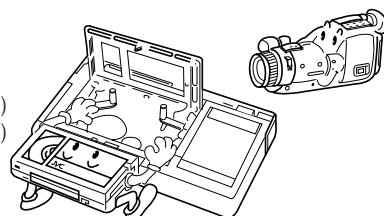

\* Compact VHS camcorder recordings can be played on this VCR. Simply place the recorded cassette into a VHS Cassette Adapter and it can be used just like any full-sized VHS cassette.

\*\* This VCR can record on regular VHS and Super VHS cassettes. However, it will record regular VHS signals only.

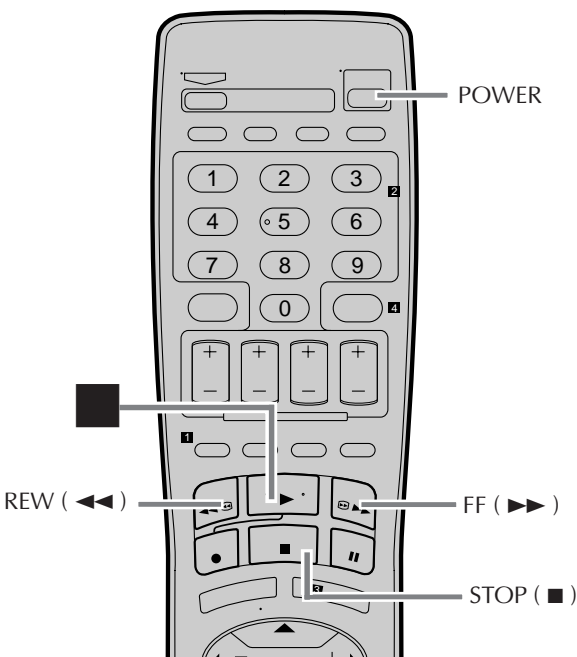

*Clean the video heads using a dry cleaning cassette — TCL-2UX — when:*

- Rough, poor picture appears while a tape is played back.
- The picture is unclear or no picture appears.
- "USE CLEANING CASSETTE" appears on the screen (only with "SUPERIMPOSE" set to "ON": pg. 28, 29)

# Basic Playback Features

## A Changing display information

Press **DISPLAY** during playback.

Each time you press the button, the front panel display shows the time counter and the clock time alternately.

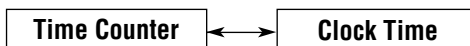

- To display the VCR status including the time counter and the clock time on the TV screen, see "Showing on-screen display" (pg. 21).

To reset the time counter, press **C. RESET** on the Remote. The counter reading becomes "0:00:00". It is also reset when a tape is inserted.

## B Checking tape position

The tape position indicator appears on screen in the following cases:

- When you change the VCR operation mode from the stop mode to fast forward or rewind mode.
- When you perform an Index Search (pg. 18) or Instant Review (pg. 18).

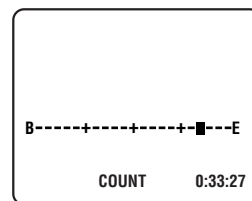

The position of "■" in relation to "B" (Beginning) or "E" (End) shows you where you are on the tape.

### NOTES:

- "SUPERIMPOSE" must be set to "ON", or the indicator will not appear (pg. 28, 29).
- It may take a few seconds for the tape position indicator to be displayed.

## C Playing back tape repeatedly

### Repeat Play

You can play back a tape repeatedly (100 times).

While playing back a tape, press and hold **PLAY (▶)** for more than 5 seconds.

The play indicator (▷) on the front display panel starts flashing slowly, and a tape will be played back 100 times.

To stop playback, press **STOP (■)** on the Remote or **STOP/EJECT (■/▲)** on the front panel.

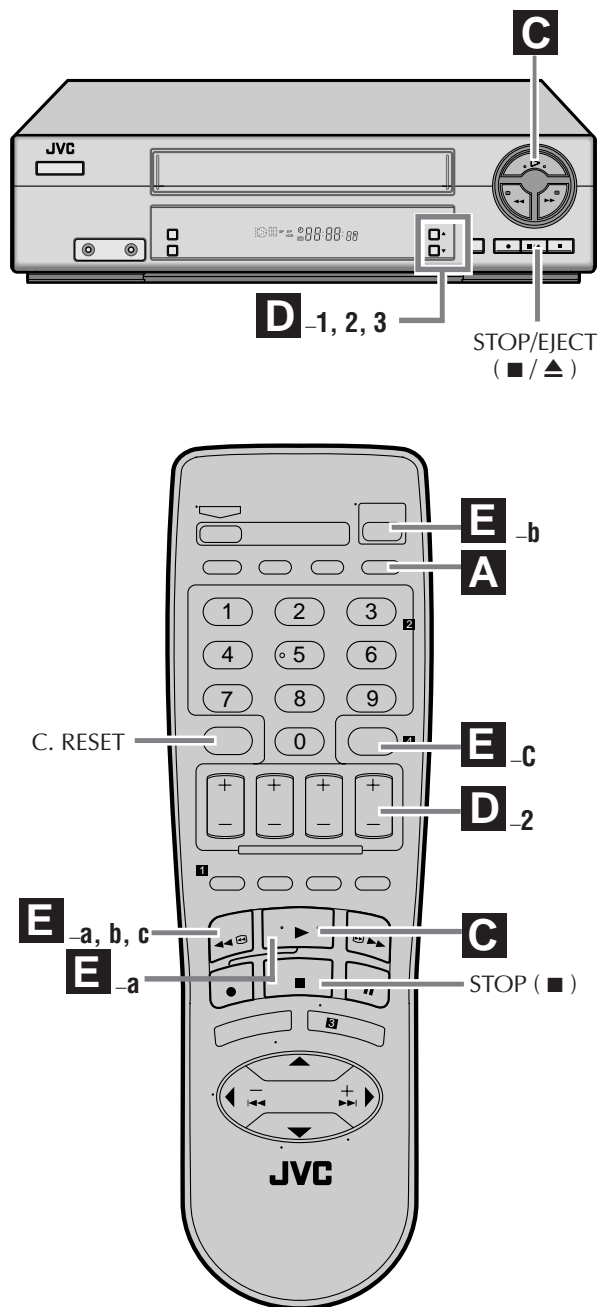



## D Adjusting tracking condition

### — Tracking Adjustments

#### Automatic tracking adjustment

This VCR automatically adjusts the tracking condition. Whenever you insert a tape and start playback, automatic tracking starts working and continuously analyzes the signal to enable optimum picture quality during playback.

#### Manual tracking adjustment

If automatic tracking cannot eliminate noises well during playback, use the manual tracking following the procedures below.

- You can also use the manual tracking during slow motion playback (☞ pg. 23).

### 1 Activate manual tracking

Press **CH ▲** and **▼** on the front panel at the same time during playback.

### 2 Eliminate the noises on the TV screen.

Press **CH ▲** and **▼** (or **CH +** and **-** on the Remote).

- Press it briefly for a fine adjustment, or press and hold for coarse adjustment. Watch the screen and continue adjustment until optimum picture and sound quality are achieved.

### 3 Reactivate automatic tracking

Press **CH ▲** and **▼** on the front panel at the same time. The automatic tracking becomes active again. "AUTO PICTURE" will momentarily flash on the TV.

## E Automatic operations after rewinding — Next Function Memory

The Next Function Memory "tells" the VCR what to do after rewinding is complete.

- Ensure that the VCR is in stop mode.

#### a- For Automatic Playback Start

Press **REW (◀◀)**, then press **PLAY (▶)** within 2 seconds.

#### b- For Automatic Power Off

Press **REW (◀◀)**, then press **POWER** within 2 seconds.

#### c- For Automatic Timer Standby

Press **REW (◀◀)**, then press **TIMER** within 2 seconds.

#### NOTE:

*It is not possible to select the Automatic Timer Standby function if the cassette's record safety tab is removed.*

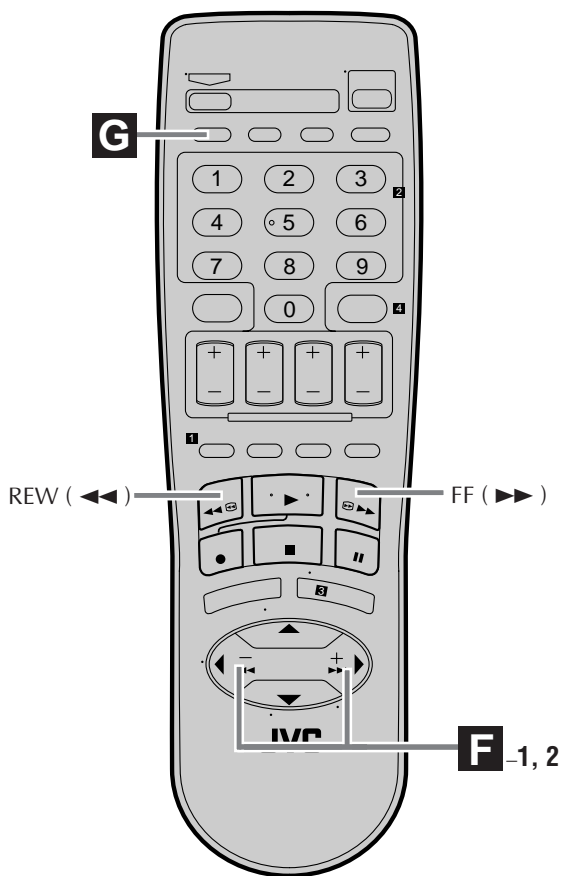

## F Locating beginning of recordings — Index Search

Index codes are placed on the tape at the beginning of each recording when recording on this VCR. You can find and automatically play back from the beginning of any recording using the Index Search function.

### 1 Start search

While the tape is not running, press **SHUTTLE PLUS**  $\lll$  or  $\ggg$  on the Remote.

### 2 Access distant code

To access a recording of 2 to 9 index codes away, press **SHUTTLE PLUS**  $\lll$  or  $\ggg$  repeatedly until the correct number is displayed on screen (only if "SUPERIMPOSE" is set to "ON";  $\lll$  pg. 28, 29). Playback begins automatically when the desired recording is located.

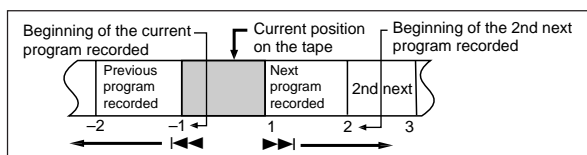

- If you want to find the very beginning of the desired program, press **REW** ( $\lll$ ) or **FF** ( $\ggg$ ) after playback starts.

### NOTE:

An index code is not placed on the tape when recording is resumed from recording pause.

## G Locating beginning of timer recordings — Instant Review

At the press of a button, you can turn on the VCR, rewind the tape and begin to view the most recent timer-recorded program.

**Press REVIEW on the Remote after ensuring that the VCR is in the timer recording standby mode.**

- The VCR turns on, and rewinds to the index code indicating the beginning of the last timer-recorded program, then begins playback automatically.
- You can access a program of 2 to 9 index codes away from the current position on the tape. If, for example, you have 5 programs recorded and you want to watch the third one, press **REVIEW** three times.
- If you want to find the very beginning of the desired program, press **REW** ( $\lll$ ) or **FF** ( $\ggg$ ) after playback starts.
- If the tape is already rewound when **REVIEW** is pressed, it will play the tape from the beginning. It will not fast-forward to an index code.
- The Instant Review function will also operate if the VCR is turned on.

### Other Useful functions for playback

You can also use the following functions for recording.

#### • Auto Picture ( $\lll$ pg. 29)

When this function is set to "ON", this VCR checks the condition of the tape in use during playback, and compensates to provide the highest-possible playback pictures.

#### • Picture Control ( $\lll$ pg. 29)

This function helps you to adjust the playback picture quality according to your preference.

#### • Video Stabilizer ( $\lll$ pg. 30)

You can automatically correct vertical vibrations in the picture when playing back unstable recordings made on another VCR.

#### • Blue Back ( $\lll$ pg. 30)

When this function is set to "ON", the TV screen becomes all blue in the following cases:

- When receiving a channel not in use.
- When stopping playback.

# Basic Recording

Turn on the VCR and the TV, and select the VCR channel 3 or 4 (or AV mode) on the TV.

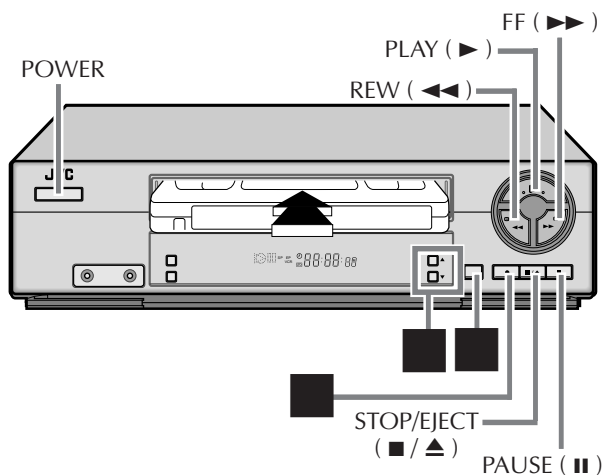

## Load a cassette

Make sure the record safety tab is intact. If not, cover the hole with adhesive tape before inserting the cassette.

## Select recording channel

### On the front panel:

Press **CH▲▼**.

### On the Remote:

a- Press **CH +** or **-**,  
or

b- Press the **Number** keys.

- If you connect the TV and the VCR only using the RF connection, press **TV/VCR** on the Remote so that the VCR mode indicator lights on the front display panel, to view the program to be recorded.

## Set tape speed

Press **SP/EP** to set the recording speed.

## Start recording

### On the front panel:

Press **REC (●)**.

### On the Remote:

While holding **REC (●)**, press **PLAY (▶)**.

## To pause recording

Press **PAUSE (||)**. To resume recording, press **PLAY (▶)**.

## To stop recording

Press **STOP (■)** on the Remote or **STOP/EJECT (■/▲)** on the front panel.

**To rewind the tape** – when the tape is not running.

Press **REW (◀)**.

**To fast-forward the tape** – when the tape is not running.

Press **FF (▶▶)**.

## To eject the tape

Press **STOP/EJECT (■/▲)** on the front panel when the tape is not running.

- You can also eject the cassette with the VCR turned off.

## To turn off the VCR

Press **POWER**.

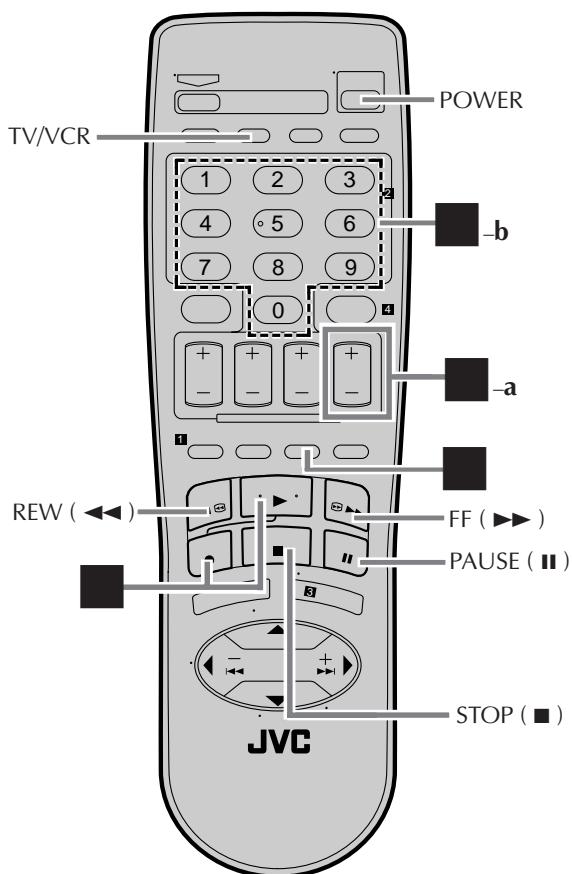

## Accidental erasure prevention

To prevent accidental recording on a recorded cassette, remove its record safety tab. To record on it later, cover the hole with adhesive tape.



# Basic Recording Features

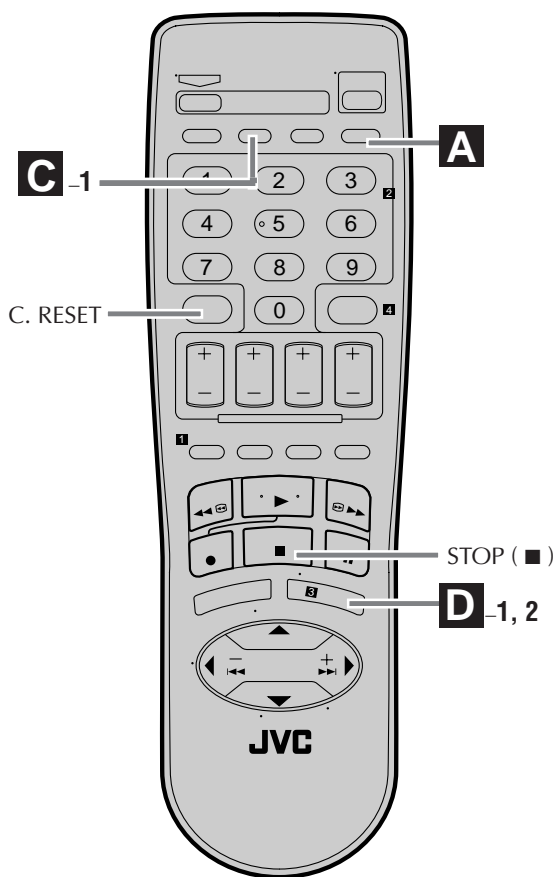

## A Changing display information

Press **DISPLAY** during recording or recording pause. Each time you press the button, the front panel display shows the time counter, channel number and the clock time in sequence.

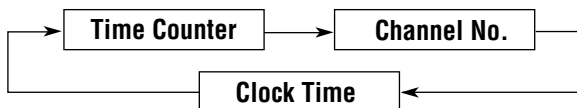

- To display the VCR status including the time counter, channel number, and the clock time on the TV screen, see "Showing on-screen display" (☞ pg. 21).

To reset the time counter, press **C. RESET** on the Remote. The counter reading becomes "0:00:00". It is also reset when a tape is inserted.

## B Specifying recording length

### — Instant Timer Recording (ITR)

You can easily specify the recording length from 30 minutes to 6 hours and the VCR shuts off after recording is finished.

During recording, press **REC (●)** on the front panel repeatedly until the recording length you want appears on the front display panel.

The  (record) indicator starts flashing. Each time you press the button, recording length increases in 30-minute intervals (up to 6 hours).

To cancel an ITR, press **STOP (■)** on the Remote or **STOP/EJECT (■/▲)** on the front panel.

## C Watching one program while recording another

### 1 Engage TV mode

During recording...

- If you connect the TV and the VCR only using the RF connection (☞ pg. 7) to view pictures from the VCR

Press **TV/VCR** on the Remote so that VCR mode indicator goes off from the front display panel. The TV broadcast being recorded disappears.

- If you are using the AV connection (☞ pg. 7) to view pictures from the VCR, change the TV's input mode from AV to TV.

### 2 Select channel for viewing

Select the channel, you want to watch, on the TV.

## D Showing on-screen display

When "SUPERIMPOSE" is set to "ON" (☞ pg. 28, 29), you can see the current VCR status on the TV screen.

- For more detailed information about the on-screen display, see page 37.

### 1 Display VCR status on TV screen

During recording or recording pause, press **OSD**.

All indications corresponding to the current VCR status are displayed for 5 seconds.

The time counter remains on the screen indicating the elapsed time.

- The indications are not recorded.

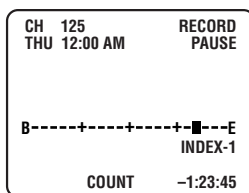

### 2 Exit on-screen display

Press **OSD** again.

#### NOTES:

- If the VCR is in recording pause mode, "RECORD/PAUSE" is always displayed.
- The VCR status can be also displayed during playback.

# Special Effect Playback

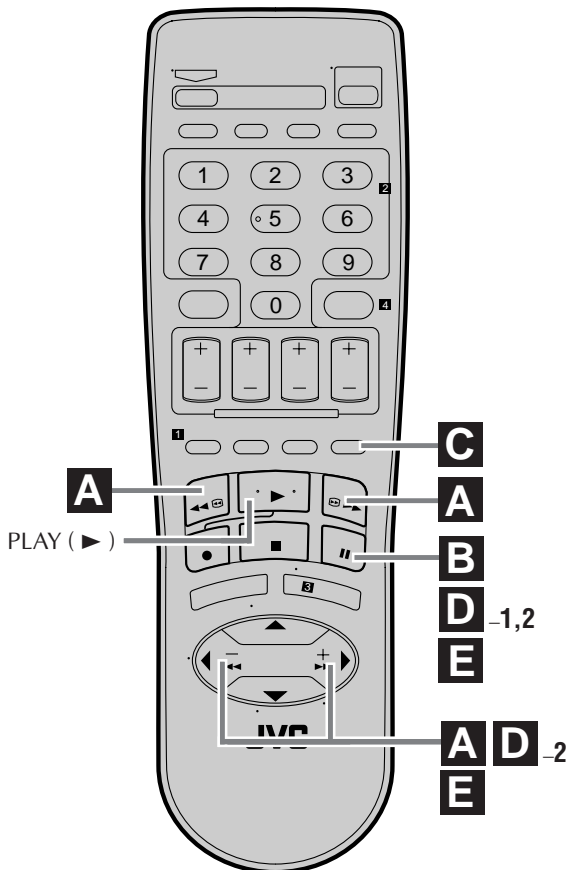
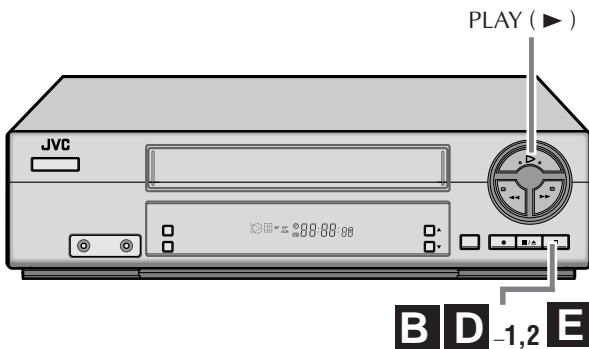

## A Locating particular scene rapidly — Picture Search

### ■ High-Speed Picture Search:

Possible during normal playback or still picture playback.

You can rapidly locate a particular scene on the tape.

**To do forward picture search,** press **FF** (▶▶).

**To do reverse picture search,** press **REW** (◀◀).

- If you press and hold the button for more than 2 seconds, simply releasing it cancels the picture search, and normal playback resumes.

**To resume normal playback,** press **PLAY** (▶).

### ■ Variable-Speed Picture Search:

You can change the speed of picture search.

#### How to use the SHUTTLE PLUS buttons on the Remote:

**To do forward picture search,** press **SHUTTLE PLUS** ▶▶ repeatedly.

Each time you press the button, the search speed increases.

- To decrease the speed while forward picture search (toward normal playback, then reverse picture search), press **SHUTTLE PLUS** ◀◀ repeatedly.

**To do reverse picture search,** press **SHUTTLE PLUS** ◀◀ repeatedly.

Each time you press the button, the search speed increases while reverse picture search.

- To decrease the speed while reverse picture search (toward normal playback, then forward picture search), press **SHUTTLE PLUS** ▶▶ repeatedly.

**To resume normal playback,** press **PLAY** (▶).

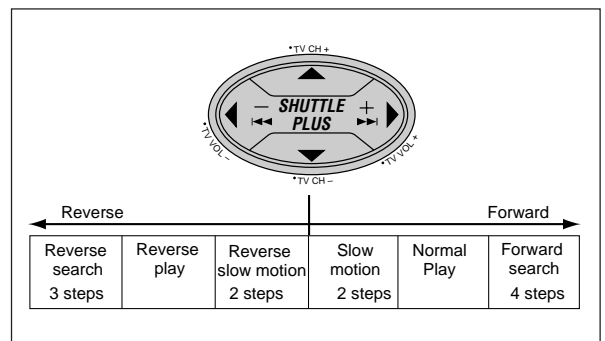

## **B** Viewing still picture

### — Still Picture Playback

Press **PAUSE ( || )** during normal playback. Playback is frozen and a still picture appears.

To resume normal playback, press **PLAY ( ► )**.

#### *NOTE:*

To obtain a noiseless still picture, it may be necessary to adjust tracking in slow motion playback before starting still picture playback.

## **C** Skipping unwanted portions

### —Skip Search

You can skip over (view at high speed) unwanted portions of the tape.

Press **SKIP SEARCH** once to 4 times during playback. Each press initiates a 30-second period of high speed playback (up to 2 minutes). When the specified portion of the tape is skipped, normal playback resumes automatically.

To return to normal playback during Skip Search, press **PLAY ( ► )**.

## **D** Viewing still picture frame by frame

### — Frame-by-Frame Playback

#### **1** Pause during playback

Press **PAUSE ( || )**. Playback is frozen and a still picture appears.

#### **2** Advance or reverse still picture

To advance a still picture, press **SHUTTLE PLUS ►►** on the Remote (or **PAUSE ( || )**) repeatedly.

To reverse a still picture, press **SHUTTLE PLUS ◀◀** on the Remote repeatedly.

To resume normal playback, press **PLAY ( ► )**.

## **E** Viewing slow motion picture

### — Slow Motion Playback

#### On the front panel:

**During normal playback or still picture playback:** Press and hold **PAUSE ( || )** for more than 2 seconds.

#### On the Remote:

##### ● During normal playback:

Press **SHUTTLE PLUS ◀◀** to decrease the playback speed.

Each time you press the button, the speed decreases (toward reverse slow motion playback, then reverse picture search).

● Holding **PAUSE ( || )** for more than 2 seconds also starts forward slow motion playback.

To resume normal playback, press **PLAY ( ► )**.

##### ● During still picture playback:

Press and hold **SHUTTLE PLUS ►►** to start forward (or **SHUTTLE PLUS ◀◀** to start reverse) slow motion playback. When you release the button, slow motion playback stops and a still picture appears.

● Holding **PAUSE ( || )** for more than 2 seconds also starts forward slow motion playback.

To resume normal playback, press **PLAY ( ► )**.

#### *NOTE:*

Manual tracking is possible during slow motion playback. During slow motion playback, simply press **CH ▲** and **▼** on the front panel or **CH +** or **-** on the Remote to adjust tracking.

# Express Timer Programming

Turn on the VCR and the TV, and select the VCR channel 3 or 4 (or AV mode) on the TV.

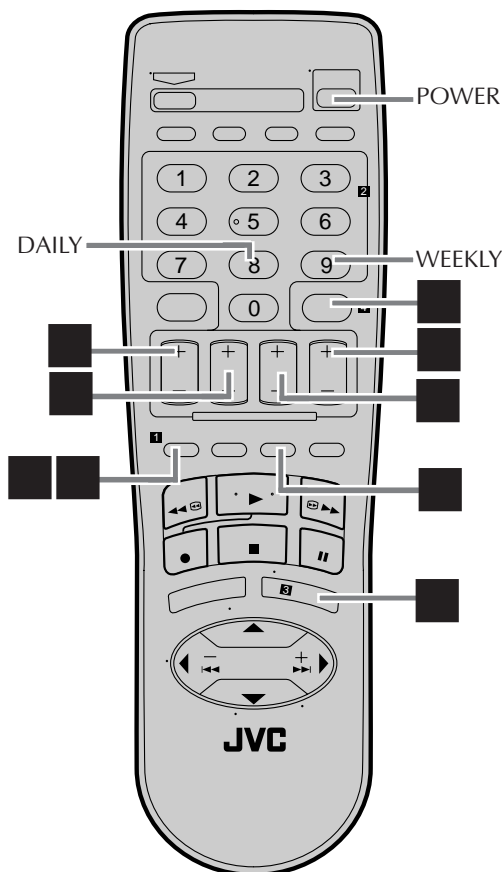

You can directly program the VCR's timer to record up to 8 broadcasts, as far as a year in advance. Remember, the clock must be set before you can program the timer (see pg. 8 or 10).

## Load a cassette

Make sure the record safety tab is intact. If not, cover the hole with adhesive tape, then load it into the VCR.

- The VCR turns on, and the counter is reset, automatically.

## Access Program screen

Press **PROG.** (If no program is stored, "PROGRAM 1" appears.)

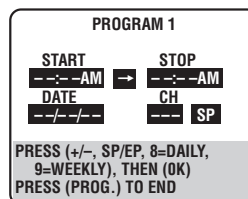

## Set program start time

Press **START +/-** repeatedly to enter the time you want recording to start.

- Press and hold **START +/-** to increase the time in 30-minute intervals.

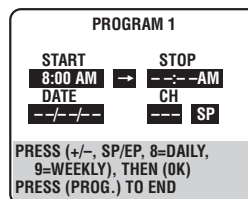

## Set program stop time

Press **STOP +/-** repeatedly to enter the time you want recording to stop.

- Press and hold **STOP +/-** to increase the time in 30-minute intervals.

## Set program date

Press **DATE +/-**. (The current date is displayed on the screen. The date you enter appears in its place.)

## Set channel number

Press **CH +/-**.

- Holding down **CH +/-** rapidly changes the channel numbers.
- If you receive your programs through a cable box, select the cable box output channel — the channel on which you view the cable box programs on the TV.



### Set tape speed

Press **SP/EP** to set the tape speed.

### Return to normal screen

Press **PROG.** or **OK**.

“PROGRAM COMPLETED” appears on the screen for about 5 seconds, then normal screen appears.

- If “PROGRAM NOT COMPLETED PROGRAM OVERLAP” appears, you have another program overlapping the program you have just made. The Program Check screen appears and conflicting programs will start blinking. You can now correct the conflicting programs. See “When programs overlap each other” on page 27.

### Engage timer recording standby mode

Press **TIMER**.

The VCR turns off automatically and “⊖” is displayed on the front panel display.

### NOTES:

- Even if a power failure occurs, the VCR keeps your timer programs. However, the clock time, channel settings, and other menu settings are lost. As a result, when the power is supplied again to this VCR after the power failure, the following will take place.
  1. This VCR starts the Plug & Play setting automatically to restore the clock time and channel setting.
  2. If the clock time and channel setting are restored correctly, each timer program you have made will start as its start time unless its end time has elapsed.
- Programs that start after midnight must have the next day's date.
- After timer recording is completed, the VCR turns off automatically.
- You can program the timer recording while a regular recording is in progress; the menu screens will not be recorded.
- If the tape reaches its end during timer recording, the cassette is automatically ejected.
- To timer-record cable channels, be sure to keep the cable box turned on with the correct channel selected with the correct channel selected.

### To timer-record daily (Monday–Friday) or weekly serials

Press **DAILY (M–F)** (number “8”) or **WEEKLY** (number “9”) anytime during steps ■ through ■.

“DAILY” or “WEEKLY” appears on the Program screen.

- Pressing the button again makes the corresponding indication disappear.

### To use the VCR while it is in timer recording standby mode

Press **TIMER** to cancel the timer recording standby mode, then press **POWER** to turn on the VCR.

DO NOT forget to put the VCR into timer recording standby mode again by pressing **TIMER** after you use the VCR; otherwise, you cannot record the broadcast you want.

- When “AUTO TIMER” (pg. 29) is set to “ON”, the timer recording standby mode is automatically engaged when the VCR is turned off. It is temporarily canceled when the VCR is turned on. You do not have to press **TIMER** to engage or disengage the timer recording standby mode.

Turn on the VCR and the TV, and select the VCR channel 3 or 4 (or AV mode) on the TV.

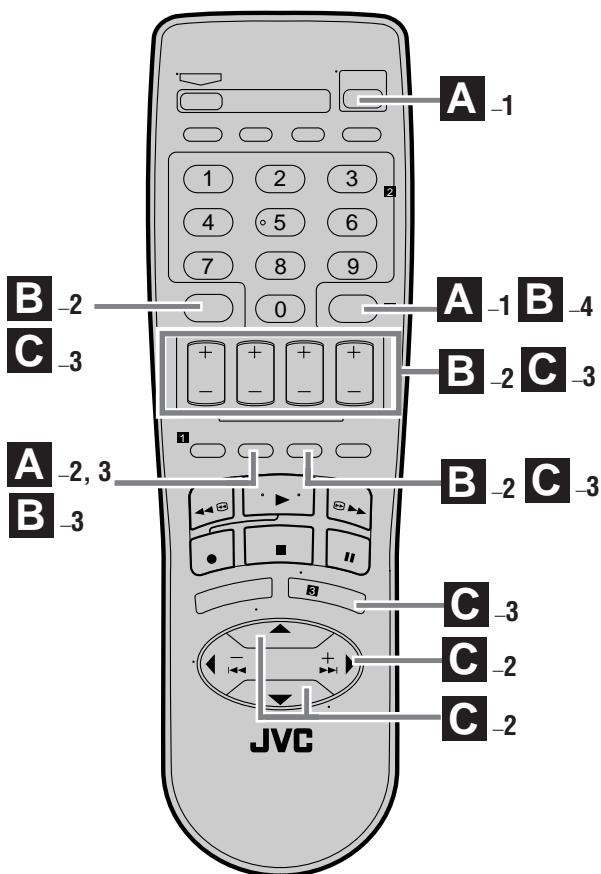

### Other Useful functions for timer recording

You can also use the following functions for timer recording.

#### • Auto Timer (pg. 29)

When "AUTO TIMER" is set to "ON", the timer recording standby mode is automatically engaged when the VCR is turned off. It is temporarily canceled when the VCR is turned on. You do not have to press **TIMER** to engage or disengage the timer recording standby mode.

#### • Auto SP → EP Timer (pg. 30)

If there is not enough tape to record the entire broadcast for recording in SP mode, the VCR automatically switches to EP mode to allow complete recording. This feature is especially handy when recording a broadcast of more than 2 hours in length.

## A Checking program settings

### 1 Disengage timer

Press **TIMER**, then press **POWER**.

- When "AUTO TIMER" (pg. 29) is set to "ON", you do not have to press **TIMER**.

### 2 Access Program Check screen

Press **PROG. CHECK**.

PR	START	STOP	CH	DATE
1	8:00P	10:00	12	12/24
2	10:00A	10:45	40	12/25
3	11:30P	1:00	125	12/25
4				
5				
6				
7				
8				

PRESS (CHECK) TO NEXT

### 3 Access Program screen

Press **PROG. CHECK** again to check more detailed information. Each time you press **PROG. CHECK**, the next program's Program screen appears. When all Program screens are shown, normal screen resumes.

## B Canceling or changing program settings

### 1 Access Program screen

Repeat steps 1 to 3 above.

### 2 Cancel or change program setting

**To cancel a program**, press **CANCEL** when the Program screen you do not want is shown.

**To change a program**, press the appropriate button: **START+/-**, **STOP+/-**, **DATE+/-**, **CH+/-**, and/or **SP/EP** when the Program screen on which you want to make changes is shown.

### 3 Return to normal screen

Press **PROG. CHECK** as many times as necessary until no Program screen is shown.

### 4 Reengage timer recording standby mode

Press **TIMER**.

- When "AUTO TIMER" (pg. 29) is set to "ON", the timer recording standby mode automatically resumes when you turn off the VCR.

## C When programs overlap each other

If "PROGRAM NOT COMPLETED PROGRAM OVERLAP" appears, you have another program overlapping the program you have just made. The Program Check screen appears and conflicting programs will start blinking.

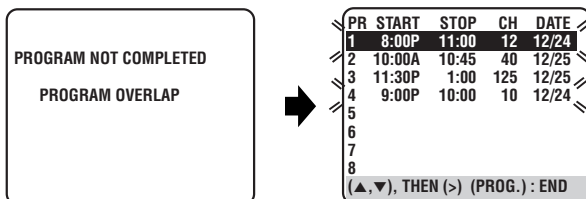

**EX. Program 1 (you have just made) and Program 4 overlap each other**

### 1 Confirm overlapping programs

Overlapping programs blink on the screen.

### 2 Select program to modify

Press **SHUTTLE PLUS ▲▼**, then press **SHUTTLE PLUS ▶**.

- You can only select one of the overlapping programs.

#### NOTE:

If you do not mind this overlap, press **PROG.** to finish the timer program setting. See "ATTENTION" to the right. Without doing anything for about 1 minute, the VCR will finish the timer programming.

### 3 Cancel or change program setting

To cancel a program, press **CANCEL** when the Program screen you do not want is shown. "PROGRAM COMPLETED" appears on the screen for about 5 seconds, then normal screen appears.

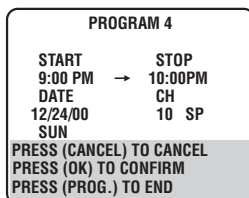

To change a program, press the appropriate button: **START+/-**, **STOP+/-**, **DATE+/-**, **CH+/-**, and/or **SP/EP** when the Program screen on which you want to make changes is shown, then press **OK**. "PROGRAM COMPLETED" appears on the screen for about 5 seconds, then normal screen appears.

#### NOTE:

If the overlap is not yet solved or another overlap occurs with the timer program setting made last after making correction on a program, the conflicting programs will be shown on the Program Check screen again. Repeat the above steps again until the overlap is solved.

#### ATTENTION

If there is a conflict in the timer schedule and one program overlaps with another, only the parts shown below in gray will be recorded.

**Pattern 1:** The program with the lower program number will be recorded.

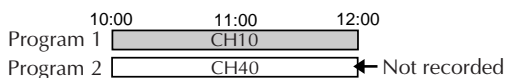

**Pattern 2:** The program starting earlier will be recorded.

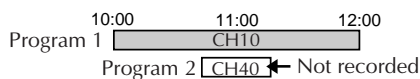

**Pattern 3:** The program starting earlier will be recorded, followed by the remaining portion of the other program.

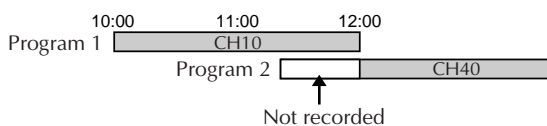

# Useful Function Settings

Turn on the VCR and the TV, and select the VCR channel 3 or 4 (or AV mode) on the TV.

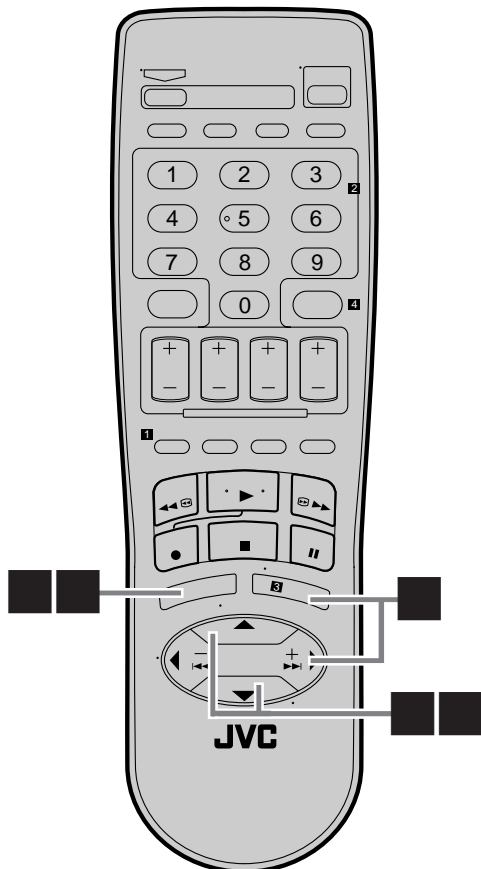
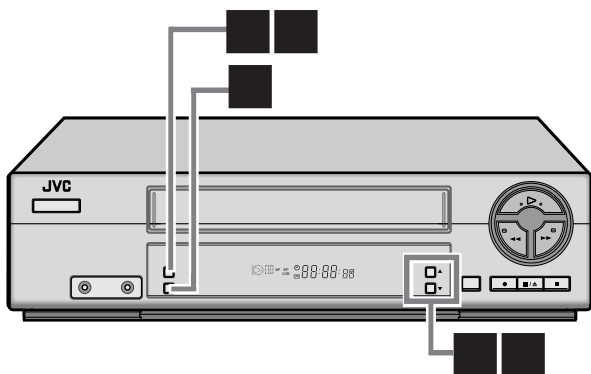

You can use the other useful function settings on the Function Set screen by following the procedure described below.

- For the functions you can set on the Function Set screen, see pages 29 and 30.

## Access Main Menu screen

Press **MENU**.

## Access Function Set screen

### On the front panel:

Press **CH▲▼** to move the highlight bar (arrow) to "FUNCTION SET".

### On the Remote:

Press **SHUTTLE PLUS**

**▲▼** to move the highlight bar (arrow) to "FUNCTION SET".

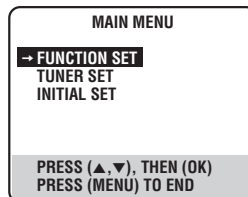

## Select Function.

### On the front panel:

Press **CH▲▼** to move the highlight bar (arrow) to the function you want to set.

### On the Remote:

Press **SHUTTLE PLUS ▲▼** to move the highlight bar (arrow) to the function you want to set.

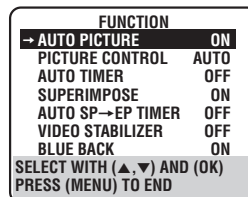

## Change setting

### On the front panel:

Press **OK**.

### On the Remote:

Press **OK** or **SHUTTLE PLUS ►**.

## Return to normal screen

Press **MENU**.

\* The default setting is **bold** in the table below.

<p>■ <b>AUTO PICTURE</b> ON OFF</p>	<p>When this function is set to "ON", this VCR checks the condition of the tape in use during playback, and compensates to provide the highest-possible playback pictures.</p>
<p>■ <b>PICTURE CONTROL</b> <b>AUTO</b> (NORM): Normally select this. Picture quality is adjusted automatically. When "AUTO PICTURE" is "OFF", "NORM" will appear instead of "AUTO". <b>EDIT</b>: Minimizes picture degradation during editing (recording and playback). <b>SOFT</b>: Reduces image coarseness when viewing overplayed tapes containing much noise. <b>SHARP</b>: Clearer, sharper-edged picture when viewing images with much flat, same-colored surfaces such as cartoons.</p>	<p>This function helps you to adjust the playback picture quality according to your preference.</p> <p><b>NOTES:</b></p> <ul style="list-style-type: none"> <li>• When you select "EDIT", "SOFT" or "SHARP", the selected mode will not change until you select again.</li> <li>• Select "EDIT" when you are dubbing tapes (☞ pg. 31). After you finish dubbing the tapes, select "AUTO" ("NORM" when "AUTO PICTURE" is "OFF".)</li> </ul>
<p>■ <b>AUTO TIMER</b> ON OFF</p>	<ul style="list-style-type: none"> <li>• <b>When this function is set to "ON":</b> The timer recording standby mode is automatically engaged when the VCR is turned off. It is temporarily canceled when the VCR is turned on. You do not have to press <b>TIMER</b> to engage or disengage the timer recording standby mode.</li> <li>• <b>When this function is set to "OFF":</b> You have to press <b>TIMER</b> to engage or disengage the timer recording standby mode.</li> </ul>
<p>■ <b>SUPERIMPOSE</b> ON OFF</p>	<p>When this function is set to "ON", various VCR status information (on-screen display) appears on the screen.</p> <p><b>NOTES:</b></p> <ul style="list-style-type: none"> <li>• When you use this VCR as the playback VCR for editing a tape, be sure to set this function to "OFF"; otherwise, the VCR status information (on-screen display) will be recorded on the edited tape.</li> <li>• If you select a channel on which no signal is received, the channel number is displayed regardless of this function setting.</li> </ul>

\* The default setting is **bold** in the table below.

<p>■ <b>AUTO SP → EP TIMER</b> ON OFF</p>	<p>When this function is set to “ON”, the VCR automatically switches to EP mode to allow complete recording if there is not enough tape to record the entire program while timer-recording in SP mode.</p> <p><b>For Example . . .</b> Recording a program of 140 minutes in length onto a 120-minute tape</p> <table border="1" data-bbox="583 372 1171 432"> <tr> <td style="text-align: center;">Approximately 110 minutes</td> <td style="text-align: center;">Approximately 30 minutes</td> </tr> <tr> <td style="text-align: center;">SP mode</td> <td style="text-align: center;">EP mode</td> </tr> </table> <p>Make sure you set this function to “ON” before the timer-recording starts.</p> <p><b>NOTES:</b></p> <ul style="list-style-type: none"> <li>● If you have programed the VCR to timer-record 2 or more programs, the second program and those thereafter may not fit on the tape with this function set to “ON”. In this case, do not use this function, but change the tape speed manually during timer programing.</li> <li>● In order to ensure that the recording fits on the tape, this function may leave a slight non-recorded portion at the end of the tape.</li> <li>● There may be some noise and sound disturbance where the tape speed switches from SP to EP mode on the tape.</li> <li>● This function is not available during ITR (Instant Timer Recording), and will not work properly on the following tapes: T(ST)-30, T(ST)-60, T(ST)-90, and T(ST)-120.</li> </ul>	Approximately 110 minutes	Approximately 30 minutes	SP mode	EP mode
Approximately 110 minutes	Approximately 30 minutes				
SP mode	EP mode				
<p>■ <b>VIDEO STABILIZER</b> ON OFF</p>	<p>When this function is set to “ON”, you can automatically correct vertical vibrations in the picture when playing back unstable recordings made on another VCR.</p> <p><b>NOTES:</b></p> <ul style="list-style-type: none"> <li>● When you finish viewing a tape, be sure to set this function to “OFF”.</li> <li>● Regardless of the setting, this function has no effect during recording and during special effects playback.</li> <li>● The on-screen display may jitter vertically when this function is set to “ON”.</li> <li>● To watch recordings with close-caption, set this function to “OFF”.</li> </ul>				
<p>■ <b>BLUE BACK</b> ON OFF</p>	<p>When this function is set to “ON”, the TV screen becomes all blue in the following cases:</p> <ul style="list-style-type: none"> <li>● When receiving a channel not in use.</li> <li>● When stopping playback.</li> </ul> <p><b>NOTE:</b> When you want to receive an unstable channel with poor signals, set this function to “OFF”.</p>				

# Edit To Or From Another VCR

## Connection

Ex. When using this VCR as the playback VCR

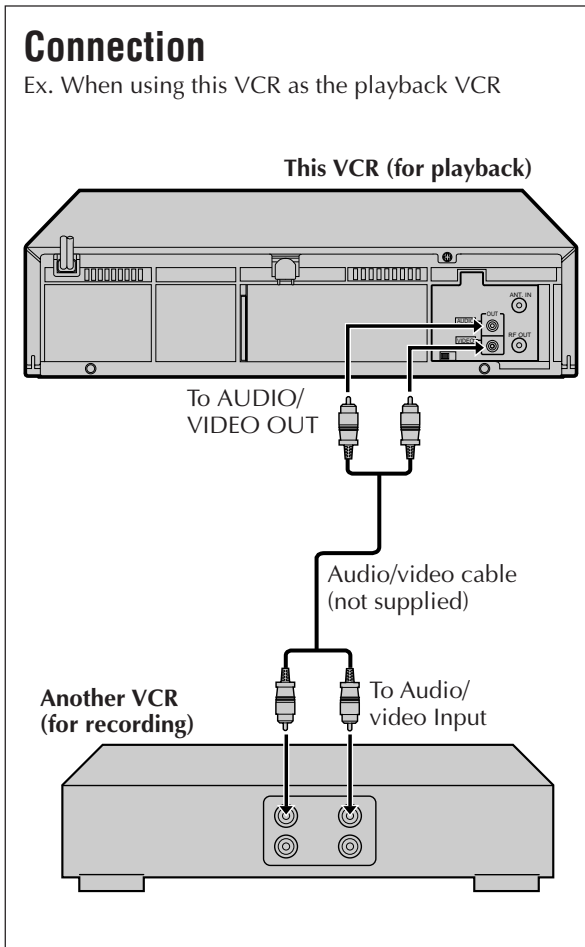

You can use your VCR as the playback or recording VCR.

- Refer also to the other VCR's instruction manual for connection and its operations.

### Make connections

Connect an audio/video cable between the playback VCR's audio/video output connectors and the recording VCR's audio/video input connectors.

- When using this VCR as the recording VCR, connect this VCR's audio/video input connectors to the audio/video output connectors on the other VCR.

### Load cassettes

Insert the playback cassette into the playback VCR and the cassette to be recorded on into the recording VCR.

### Select input mode on recording VCR

Select the correct external input on the other VCR.

- On this VCR (when using this VCR as the recording VCR);  
Select "F-1" — when connecting the other VCR to the audio/video input connectors on the front panel.

#### On the front panel:

Press **CH▲▼**.

#### On the Remote:

Press the **Number** key "0 (AUX)" or **CH +/-**.

### Select EDIT function

Set the EDIT function to "ON".

- On this VCR, follow the procedure described on pages 28 and 29.

### Start playback

Press **PLAY (▶)** on the playback VCR.

#### NOTE:

If the playback VCR is equipped with a superimpose/OSD disable feature then set it to "OFF" before starting playback (⇨ pg. 28 and 29).

### Start recording

Press **REC (●)** on the recording VCR.

#### NOTE:









Be sure to select "AUTO" for "PICTURE CONTROL" (or "NORM" when "AUTO PICTURE" is set to "OFF") after you finish dubbing the tapes (⇨ pg. 28 and 29).

Before requesting service, use this chart and see if you can repair the trouble yourself. Small problems are often easily corrected, and this can save you the trouble of sending your VCR off for repair.





<b>POWER</b>		
<b>SYMPTOM</b>	<b>POSSIBLE CAUSE</b>	<b>CORRECTIVE ACTION</b>
1. The power will not come on.	<ul style="list-style-type: none"> <li>• The AC power cord is disconnected.</li> </ul>	Connect the AC power cord.
2. The clock works, but the VCR's power will not come on.	<ul style="list-style-type: none"> <li>• The VCR is in the timer recording standby mode with "AUTO TIMER" set to "OFF" (☞ pg. 28 and 29).</li> </ul>	Press <b>TIMER</b> to disengage.
3. The Remote will not function.	<ul style="list-style-type: none"> <li>• The batteries are discharged.</li> </ul>	Replace the dead batteries with new ones.
<b>TAPE TRANSPORT</b>		
<b>SYMPTOM</b>	<b>POSSIBLE CAUSE</b>	<b>CORRECTIVE ACTION</b>
1. The cassette gets stuck partway during loading, and is ejected.	<ul style="list-style-type: none"> <li>• The cassette was inserted incorrectly.</li> </ul>	Make sure the cassette's window is facing up, the rear label side is facing you and the arrow on the front of the cassette is pointing towards the VCR. Then insert the cassette.
<b>PLAYBACK</b>		
<b>SYMPTOM</b>	<b>POSSIBLE CAUSE</b>	<b>CORRECTIVE ACTION</b>
1. The tape is running but the picture will not appear.	<ul style="list-style-type: none"> <li>• If the RF connection (☞ pg. 7) is used to view the picture, the channel on the TV is set incorrectly.</li> <li>• If the AV connection (☞ pg. 7) is used to view the picture, the TV receiver is set to the wrong mode.</li> </ul>	Select channel 3 or 4 on the TV.  Select the AV mode on the TV.
3. The playback picture is blurred or interrupted, even though TV broadcasts are clear.	<ul style="list-style-type: none"> <li>• The video heads may be dirty.</li> </ul>	The heads must be cleaned. Consult your JVC dealer.
<b>RECORDING</b>		
<b>SYMPTOM</b>	<b>POSSIBLE CAUSE</b>	<b>CORRECTIVE ACTION</b>
1. Recording will not start.	<ul style="list-style-type: none"> <li>• There is no cassette loaded.</li> <li>• The loaded cassette has had its record safety tab removed.</li> </ul>	Insert a cassette. Remove the cassette and cover the hole with adhesive tape, or load a cassette on which the record safety tab is intact.
2. TV broadcasts will not be recorded properly.	<ul style="list-style-type: none"> <li>• The VCR has been set to "F-1" input mode by mistake.</li> </ul>	Select the appropriate channel on the VCR.
3. Tape-to-tape editing will not work.	<ul style="list-style-type: none"> <li>• The VCRs or the camcorder and the VCR have been incorrectly connected.</li> <li>• The power to one or more of the units has not been turned on.</li> <li>• The recording VCR's input mode has been set incorrectly.</li> </ul>	Refer to the directions and the illustration under "Edit To Or From Another VCR" (☞ pg. 31) and properly connect the units. Make sure the power to all units is on.  Select the appropriate input mode on the recording VCR.



## TIMER RECORDING

SYMPTOM	POSSIBLE CAUSE	CORRECTIVE ACTION
1. Timer recording will not work.	<ul style="list-style-type: none"> <li>• The clock and/or the timer have been set incorrectly.</li> <li>• The timer is not engaged.</li> </ul>	<p>Set the clock and/or timer correctly.</p> <p>Press <b>TIMER</b> and check to make sure that  appears on the front display panel. Re-perform the set-up procedures.</p>
2. Timer programing will not work.	<ul style="list-style-type: none"> <li>• Timer recording is in progress.</li> </ul>	<p>Timer programing cannot be performed when timer recording is in progress. Wait until it finishes.</p>
3.  and  on the front display panel will not stop blinking.	<ul style="list-style-type: none"> <li>• The VCR has not been set up properly.</li> </ul>	<p>Load a cassette with the record safety tab intact, or with the hole covered with adhesive tape.</p>
4. The cassette is automatically ejected, and  and  on the front display panel will not stop blinking.	<ul style="list-style-type: none"> <li>• The loaded cassette has had its record safety tab removed.</li> </ul>	<p>Remove the cassette and cover its hole with adhesive tape, or replace it with a cassette on which the safety tab is intact.</p>
5.  blinks for 10 seconds and the timer mode is disengaged.	<ul style="list-style-type: none"> <li>• <b>TIMER</b> has been pressed when there are no programs in memory, or the timer recording program has not been set correctly.</li> </ul>	<p>Check the programed data and set again if necessary, then press <b>TIMER</b> again.</p>
6. The cassette is automatically ejected, the power shuts off and  and  will not stop blinking.	<ul style="list-style-type: none"> <li>• The tape reaches its end during timer recording.</li> </ul>	<p>The program may not have been recorded in its entirety. Next time be sure you have enough time on the tape to record the entire broadcast.</p>
7. "PROGRAM FULL" is displayed on the screen.	<ul style="list-style-type: none"> <li>• All 8 programs of the VCR's timer memory are used.</li> </ul>	<p>Wait until a space in memory clears, or cancel unnecessary program information ( pg. 26).</p>

## OTHER PROBLEMS

SYMPTOM	POSSIBLE CAUSE	CORRECTIVE ACTION
1. When scanning channels, some of them are skipped over.	<ul style="list-style-type: none"> <li>• Those channels have been preset to be skipped.</li> </ul>	<p>If you need the skipped channels, restore them ( pg. 14).</p>
2. The channel cannot be changed.	<ul style="list-style-type: none"> <li>• Recording is in progress.</li> </ul>	<p>Press <b>PAUSE</b> () to pause the recording, change channels, then press <b>PLAY</b> () to resume recording.</p>
3. Even though Auto or Semiauto Clock Set has been performed, the clock is incorrect.	<ul style="list-style-type: none"> <li>• The clock setting data received from the host channel is incorrect.</li> </ul>	<p>Select a different host channel during Semiauto Clock Set ( pg. 11), or perform Manual Clock Set ( pg. 12).</p>

## Questions and answers

### PLAYBACK

- Q. What happens if the tape reaches its end during playback or search?**  
 A. The VCR automatically rewinds it to the beginning.
- Q. Can the VCR indefinitely remain in still mode?**  
 A. No. It stops automatically after 5 minutes to protect the heads.
- Q. During picture search, still picture playback and frame-by-frame playback, the picture is intermittent. What's the cause?**  
 A. Picture loss occurs when these types of playback are attempted with a tape recorded in LP mode. Pressing **PLAY (▶)** to return to normal playback will restore the picture.
- Q. When returning from variable-speed picture search to normal playback, the picture is disturbed. Should I be concerned about this?**  
 A. No, it is normal.
- Q. When playing back programs that have been timer-recorded consecutively (such one program from 8:00 to 9:00 and another one from 9:00 to 10:00), the picture and sound become momentarily distorted where the first program ends and the second program begins. Is this a malfunction?**  
 A. No. This is normal.
- Q. Other than preventing further recording, what effect does removing the safety tab have?**  
 A. It disables marking of index codes.
- Q. Sometimes, during index search, the VCR cannot find the program I want to see. Why not?**  
 A. There may be index codes too close together.
- Q. During playback, on-screen display sometimes jitters. Why does this happen?**  
 A. If the condition of the tape being played back is not good, jittering of the video (including on-screen display) may occur.

### RECORDING

- Q. When I pause and then resume a recording, the end of the recording before the pause is overlapped by the new recording. Why does this happen?**  
 A. This is normal. It reduces distortion at the pause and resume points.
- Q. Can the VCR indefinitely remain in the recording pause mode?**  
 A. No. The VCR automatically stops after 5 minutes to protect the heads. When paused during Instant Timer Recording (ITR), the VCR shuts off automatically after 5 minutes.
- Q. What happens if the tape reaches its end during recording?**  
 A. The VCR automatically rewinds it to the beginning.

### TIMER RECORDING

- Q. REC and ⊖ remain lit on the front display panel. Is there a problem?**  
 A. No. This is a normal condition for a timer recording in progress.
- Q. Can I program the timer while I'm watching a tape or a TV broadcast?**  
 A. Yes, but while you are setting the timer you will not see the tape's or broadcast program's picture as it is replaced by the on-screen menu. (The sound from the tape or broadcast program will be heard during the timer setting.)

### MOISTURE CONDENSATION

Moisture in the air will condense on the VCR when you move it from a cold place to a warm place, or under extremely humid conditions—just as water droplets form on the surface of a glass filled with cold liquid. Moisture condensation on the head drum will cause damage to the tape. In conditions where condensation may occur, keep the VCR turned on for a few hours to evaporate the moisture before inserting a tape.

### ABOUT HEAD CLEANING

Accumulation of dirt and other particles on the video heads may cause the playback picture to become blurred or interrupted. Be sure to contact your nearest JVC dealer if such troubles occur.

#### ATTENTION

This VCR contains microcomputers. External electronic noise or interference can cause microcomputer to malfunction. If the VCR does not operate correctly switch its power off and unplug the AC power cord from the AC supply. Wait for a while and then plug the power back in. Eject and check the condition of the cassette. If everything appears normal, you can operate the VCR as usual.

## List of terms

This guide serves as a quick way to locate frequently used terms and on-screen display names.

### A

Accidental erasure prevention 19  
Auto Channel Set 13  
Auto Daylight Saving Time 11  
Auto Picture 29  
Auto SP→EP Timer 30  
Auto Timer 29  
Automatic tracking 17  
AV connection 7

### B

Blue Back 30

### C

Channel No. indication 20  
Clock setting 10  
    Manual setting 12  
    Preparations 10  
    Semiauto setting 11  
Clock time 16, 20  
Connection to TV 6  
Contents 5  
Counter reset 16, 20

### E

Editing 31  
Express timer recording 24

### F

Frame-by-Frame Playback 23  
Function Set screen 28

### H

High-Speed Picture Search 22  
Host channel 8

### I

Index Search 18  
Instant Review 18  
Instant Timer Recording (ITR) 20

### L

Language setting 9

### M

Manual tracking 17

### N

Next Function Memory 17

### O

On-screen display 21, 37

### P

PBS channel 8  
Picture Control 29  
Picture Search 22  
Playback 15  
Plug & Play 8

### R

Recording 19  
Repeat play 16  
RF connection 7

### S

Slow Motion Playback 23  
Special effect playback  
    Frame-by-Frame Playback 23  
    High-Speed Picture Search 22  
    How to use the SHUTTLE PLUS  
        buttons 22  
    Picture Search 22  
    Skip Search 23  
    Slow Motion Playback 23  
    Still Picture Playback 23  
    Variable-Speed Picture Search 22  
Specifications 39  
Still Picture Playback 23  
Superimpose 29

### T

Tape position indicator 16  
Tape speed 19  
Time counter 16, 20  
Time zone selection 11  
Timer recording  
    Canceling 26  
    Changing 26  
    Checking 26  
    Express 24  
    Overlap 27  
Tracking 17  
Troubleshooting 32  
Tuner setting 13  
    Adding channels 14  
    Auto Channel Set 13  
    Manual Channel Set 14  
    Skipping channels 14

### V

Variable-Speed Picture Search 22  
Video Stabilizer 30

### Front panel

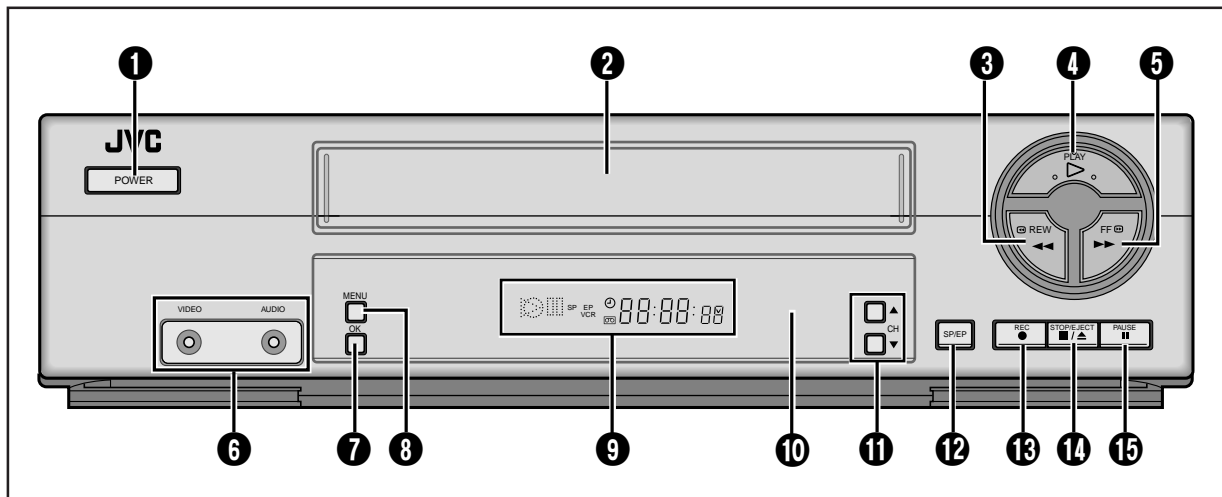

- 1 POWER button : ☞ pg. 15, 19
- 2 Cassette loading slot
- 3 REW (◀◀) button : ☞ pg. 15, 19
- 4 PLAY (▶) button : ☞ pg. 15, 19
- 5 FF (▶▶) button : ☞ pg. 15, 19
- 6 AUDIO/VIDEO input connectors : ☞ pg. 31
- 7 OK button
- 8 MENU button
- 9 Front display panel : ☞ below
- 10 Remote sensor
- 11 CH ▲▼ buttons : ☞ pg. 19
- 12 SP/EP button : ☞ pg. 19
- 13 REC (●) button : ☞ pg. 19, 20
- 14 STOP/EJECT (■/▲) button : ☞ pg. 15, 19
- 15 PAUSE (||) button : ☞ pg. 19, 23

### Front display panel

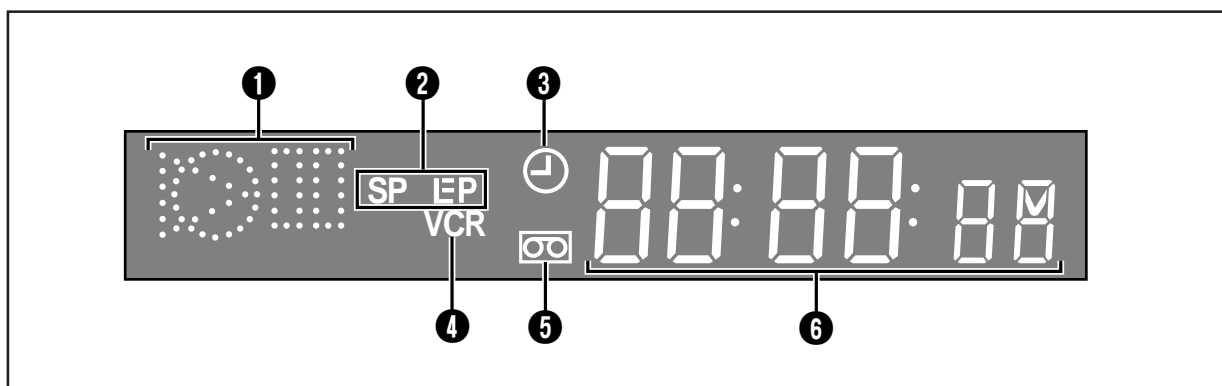

- 1 Symbolic Mode Indicators
- 2 Tape speed indicators
- 3 Timer mode indicator : ☞ pg. 25
- 4 VCR mode indicator : ☞ pg. 19, 20
- 5 Cassette mark
- 6 Channel and auxiliary input ("F-1")  
Counter reading : ☞ pg. 16, 20  
Clock time : ☞ pg. 16, 20

PLAY: FF/REW VARIABLE SHUTTLE SEARCH:	▶	STILL: SLOW:	▶
		RECORD:	○
		RECORD PAUSE:	○

## Rear panel

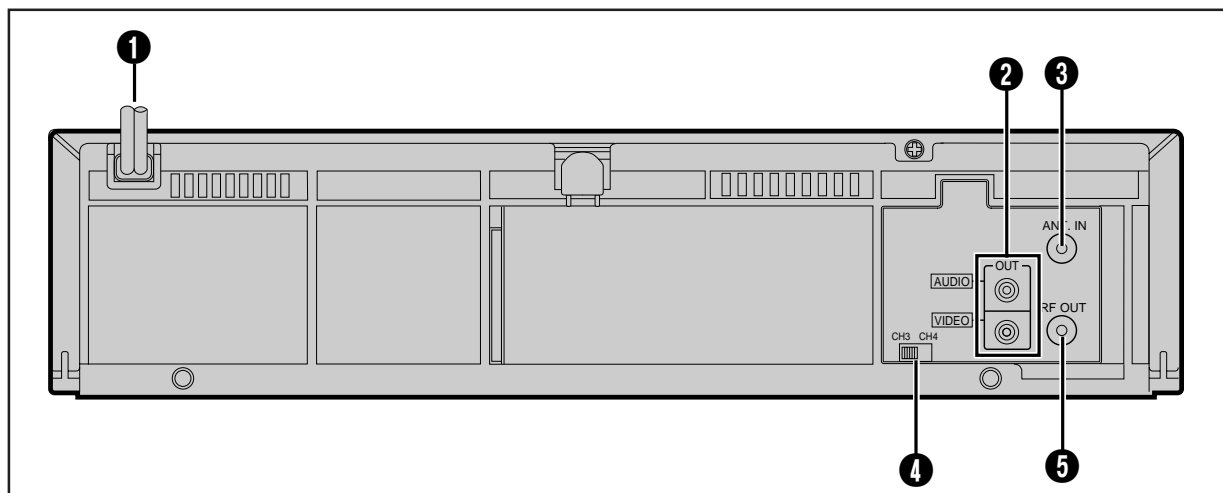

- ❶ AC power cord : ☞ pg. 6
- ❷ AUDIO/VIDEO OUT connectors : ☞ pg. 6, 31
- ❸ ANT. (Antenna) IN terminal : ☞ pg. 6
- ❹ CH3-CH4 switch : ☞ pg. 7
- ❺ RF OUT terminal : ☞ pg. 6

## On-screen display

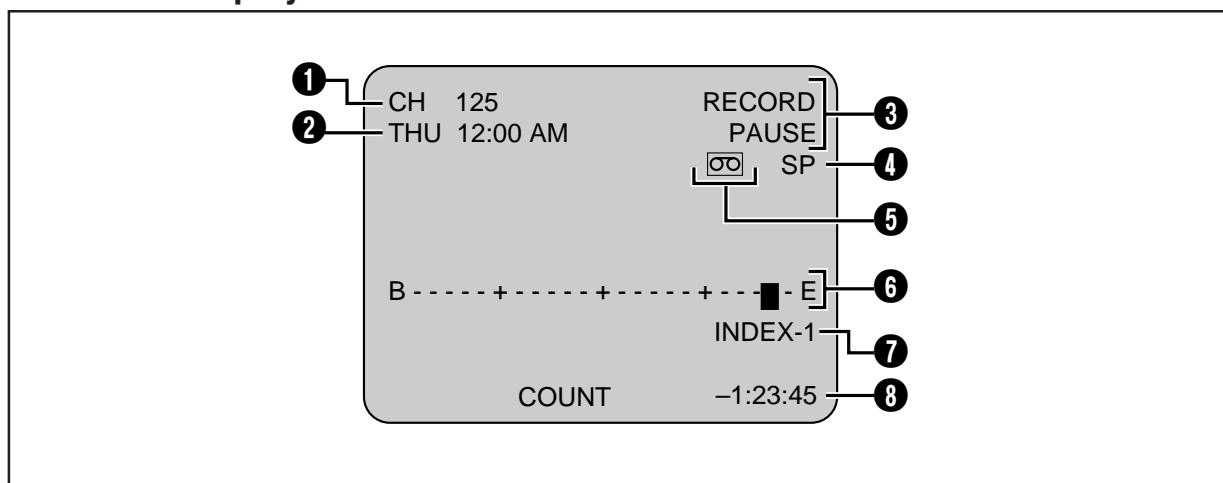

- ❶ Channel and auxiliary input ("F-1")
- ❷ Day and clock time : ☞ pg. 16, 20
- ❸ VCR operation mode indication
- ❹ Tape speed indication
- ❺ Cassette indication
- ❻ Tape position indicator : ☞ pg. 16
- ❼ Index no. indication : ☞ pg. 18
- ❽ Time counter : ☞ pg. 16, 20

## Remote

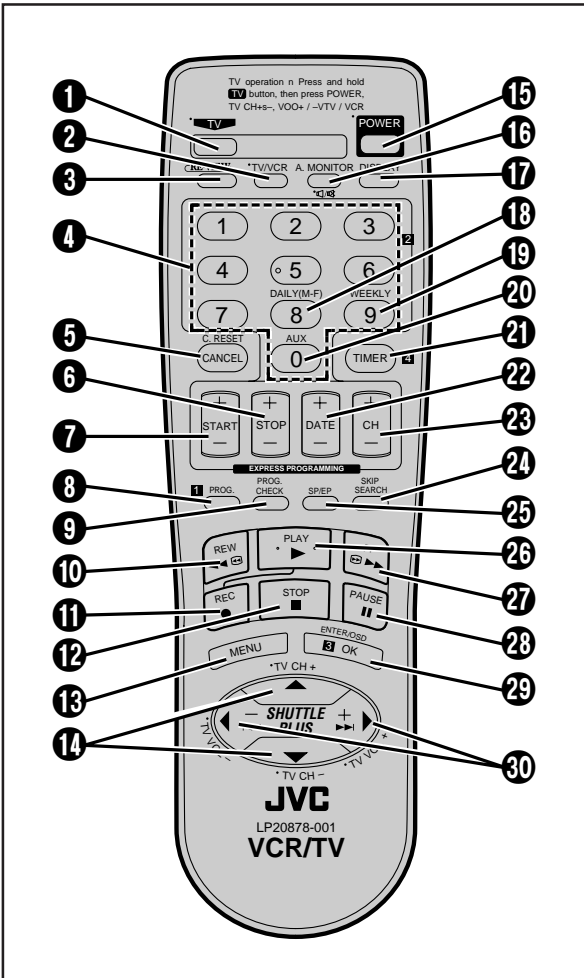
**You can operate JVC's TV**

Buttons (2, 14, 15, 16, 30) with a small dot on the left side of the name can also be used to operate a JVC's TV while holding down TV (1) on the Remote.

- 1 TV button : See below
- 2 TV/VCR button : ☞ pg. 19, 20
- 3 REVIEW button : ☞ pg. 18
- 4 Number buttons : ☞ pg. 14, 19
- 5 C. (Counter) RESET button : ☞ pg. 16, 20  
CANCEL button : ☞ pg. 26
- 6 STOP +/- button : ☞ pg. 24
- 7 START +/- button : ☞ pg. 24
- 8 PROG. (Program) button : ☞ pg. 24
- 9 PROG. CHECK button : ☞ pg. 26
- 10 REW ( ◀ ◀ ) button : ☞ pg. 15, 19, 22
- 11 REC ( ● ) button : ☞ pg. 19, 20
- 12 STOP ( ■ ) button : ☞ pg. 15, 19
- 13 MENU button
- 14 SHUTTLE PLUS ▲▼ buttons  
TV CH +/- buttons
- 15 POWER button : ☞ pg. 15, 19
- 16 A. (Audio) MONITOR button : Does not function on this VCR.  
⏸ (TV Muting) button : See below
- 17 DISPLAY button : ☞ pg. 16, 20
- 18 DAILY (M-F) button : ☞ pg. 25
- 19 WEEKLY button : ☞ pg. 25
- 20 AUX button : ☞ pg. 31
- 21 TIMER button : ☞ pg. 25, 26
- 22 DATE +/- button : ☞ pg. 24
- 23 CH +/- button : ☞ pg. 19, 24
- 24 SKIP SEARCH button : ☞ pg. 23
- 25 SP/EP button : ☞ pg. 19, 25
- 26 PLAY ( ▶ ) button : ☞ pg. 15, 19
- 27 FF ( ▶▶ ) button : ☞ pg. 15, 19, 22
- 28 PAUSE ( || ) button : ☞ pg. 19, 23
- 29 OK button  
ENTER button  
OSD button : ☞ pg. 21
- 30 SHUTTLE PLUS ◀◀▶▶▶▶ (◀▶) button : ☞ pg. 22  
TV VOL +/- button

**How to use the Remote**

Before use, insert two AA size batteries into the Remote with the polarity (⊕ and ⊖) matched correctly as indicated on the battery compartment or on the lid.

The Remote can operate most of your VCR's functions, as well as basic functions of JVC's TV sets.

- Point the Remote toward the remote sensor on the target component.
- The maximum operating distance of the remote control is about 8 m.

**NOTE:**

If the Remote does not work properly, remove its batteries, wait for a few seconds, replace the batteries and then try again.

**GENERAL**

Power requirement	: AC 120 V $\sim$ , 60 Hz
Power consumption	
Power on	: 17 W
Power off	: 2.5 W
Temperature	
Operating	: 5°C to 40°C (41°F to 104°F)
Storage	: -20°C to 60°C (-4°F to 140°F)
Operating position	: Horizontal only
Dimensions (W x H x D)	: 360 x 94 x 278 mm (15-3/4" x 3-3/4" x 11")
Weight	: 3.1 kg (6.8 lbs)
Format	: VHS NTSC standard
Maximum recording time	
SP	: 210 min. with ST-210 video cassette
EP	: 630 min. with ST-210 video cassette

**VIDEO/AUDIO**

Signal system	: NTSC-type color signal and EIA monochrome signal, 525 lines/60 fields
Recording/ Playback system	: DA-4 (Double Azimuth) head helical scan system
Signal-to-noise ratio	: 45 dB
Horizontal resolution	: 230 lines (VHS)
Frequency range	: 70 Hz to 10,000 Hz
Input/Output	: RCA connectors (IN x 1, OUT x 1)

**TUNER**

Tuning system	: Frequency-synthesized tuner
Channel coverage	
VHF	: Channels 2-13
UHF	: Channels 14-69
CATV	: 113 Channels
RF output	: Channel 3 or 4 (switchable; preset to Channel 3 when shipped) 75 ohms, unbalanced

**TIMER**

Clock reference	: Quartz
Program capacity	: 1-year programmable timer/ 8 programs

*\* Memory backup for timer is not supported.*

**ACCESSORIES**

Provided accessories	: RF cable (F-type), Infrared remote control unit, "AA" battery x 2
----------------------	---

*Specifications shown are for SP mode unless specified otherwise.*

*E. & O.E. Design and specifications subject to change without notice.*

**HOW TO LOCATE YOUR JVC SERVICE CENTER****TOLL FREE: 1-800-252-5722****<http://www.jvcservice.com>****Dear customer:**

In order to receive the most satisfaction from your purchase, read the instruction booklet before operating the unit. In the event that repair is necessary, or for the address nearest your location, please refer to the factory service center list below or within the Continental United States, call 1-800-252-5722 for your authorized servicer. Remember to retain your Bill of Sale for Warranty Service.

— JVC

**JVC SERVICE & ENGINEERING  
COMPANY OF AMERICA  
DIVISION OF JVC AMERICAS CORP.**

FACTORY SERVICE CENTER LOCATIONS

10 New Maple Avenue  
Pine Brook, NJ 07058-9641  
(973) 396-1000

1500 Lakes Parkway  
Lawrenceville, GA 30243-5857  
(770) 339-2522

705 Enterprise Street  
Aurora, IL 60504-8135  
(630) 851-7855

5665 Corporate Avenue  
Cypress, CA 90630-4727  
(714) 229-8011

10700 Hammerly Boulevard, Suite 110  
Houston, TX 77043-2310  
(713) 935-9331

2969 Mapunapuna Place, Suite 105  
Honolulu, HI 96819-2000  
(808) 833-5828

13 Cummings Park  
Woburn, MA 01801-2105  
(781) 376-9100

8192 W State Road 84  
Davie, FL 33324-4611  
(954) 472-1960

890 Dubuque Avenue  
South San Francisco, CA 94080-1804  
(650) 871-2666

*Sophisticated electronic products may require occasional service. Just as quality is a keyword in the engineering and production of the wide array of JVC products, service is the key to maintaining the high level performance for which JVC is world famous. The JVC service and engineering organization stands behind our products.*

NATIONAL HEADQUARTERS  
JVC SERVICE & ENGINEERING COMPANY OF AMERICA  
DIVISION OF JVC AMERICAS CORP.  
10 New Maple Avenue  
Pine Brook, NJ 07058-9641

**If you ship the product...**

Pack your JVC unit in the original carton or one of equivalent size and strength. Enclose, with the unit, a letter stating the problem or symptom that exists and also a copy of the receipt or bill of sale you received when you purchased your JVC unit. Print your home return address on the outside and the inside of the carton. Send to the appropriate JVC Factory Service Center as listed above.

**Don't service it yourself.****CAUTION**

To prevent electrical shock, do not open the cabinet.  
No user serviceable parts inside.  
Refer servicing to qualified service personnel.

**ACCESSORIES**

To purchase accessories for your JVC product, you may contact your local JVC Dealer.  
Or from the 48 Continental United States call toll free:  
1-800-882-2345.



**LIMITED WARRANTY**

**CONSUMER VIDEO 1-90**

JVC COMPANY OF AMERICA warrants this product and all parts thereof, except as set forth below ONLY TO THE ORIGINAL PURCHASER AT RETAIL to be FREE FROM DEFECTIVE MATERIALS AND WORKMANSHIP from the date of original retail purchase for the period as shown below. ("The Warranty Period")

PARTS	<b>1</b>	LABOR	<b>90</b>
	YR		DAYS

THIS LIMITED WARRANTY IS VALID ONLY IN THE FIFTY (50) UNITED STATES, THE DISTRICT OF COLUMBIA AND IN COMMONWEALTH OF PUERTO RICO.

**WHAT WE WILL DO:**

If this product is found to be defective, JVC will repair or replace defective parts at no charge to the original owner. Such repair and replacement services shall be rendered by JVC during normal business hours at JVC authorized service centers. Parts used for replacement are warranted only for the remainder of the Warranty Period. All products and parts thereof may be brought to a JVC authorized service center on a carry-in basis except for Television sets having a screen size 25 inches and above which are covered on an in-home basis.

**WHAT YOU MUST DO FOR WARRANTY SERVICE:**

Return your product to a JVC authorized service center with a copy of your bill of sale. For your nearest JVC authorized service center, please call toll free: (800) 252-5722.

If service is not available locally, box the product carefully, preferably in the original carton, and ship, insured, with a copy of your bill of sale plus a letter of explanation of the problem to the nearest JVC Factory Service Center, the name and location of which will be given to you by the toll-free number.

If you have any questions concerning your JVC Product, please contact our Customer Relations Department.

**WHAT IS NOT COVERED:**

This limited warranty provided by JVC does not cover:

1. Products which have been subject to abuse, accident, alteration, modification, tampering, negligence, misuse, faulty installation, lack of reasonable care, or if repaired or serviced by anyone other than a service facility authorized by JVC to render such service, or if affixed to any attachment not provided with the products, or if the model or serial number has been altered, tampered with, defaced or removed;
2. Initial installation and installation and removal for repair;
3. Operational adjustments covered in the Owner's Manual, normal maintenance, video and audio head cleaning;
4. Damage that occurs in shipment, due to act of God, and cosmetic damage;
5. Signal reception problems and failures due to line power surge;
6. Video Pick-up Tubes/CCD Image Sensor, Cartridge, Stylus (Needle) are covered for 90 days from the date of purchase;
7. Accessories;
8. Batteries (except that Rechargeable Batteries are covered for 90 days from the date of purchase); from the date of purchase);

There are no other express warranties except as listed above.

THE DURATION OF ANY IMPLIED WARRANTIES INCLUDING THE IMPLIED WARRANTY OF MERCHANTABILITY, IS LIMITED TO THE DURATION OF THE EXPRESS WARRANTY HEREIN.

JVC SHALL NOT BE LIABLE FOR THE LOSS OF USE OF THE PRODUCT, INCONVENIENCE, LOSS OR ANY OTHER DAMAGES, WHETHER DIRECT, INCIDENTAL OR CONSEQUENTIAL (INCLUDING, WITHOUT LIMITATION, DAMAGE TO TAPES, RECORDS OR DISCS) RESULTING FROM THE USE OF THIS PRODUCT, OR ARISING OUT OF ANY BREACH OF THIS WARRANTY. ALL EXPRESS AND IMPLIED WARRANTIES, INCLUDING THE WARRANTIES OF MERCHANTABILITY AND FITNESS FOR PARTICULAR PURPOSE, ARE LIMITED TO THE WARRANTY PERIOD SET FORTH ABOVE.

Some states do not allow the exclusion of incidental or consequential damages or limitations on how long an implied warranty lasts, so these limitations or exclusions may not apply to you. This warranty gives you specific legal rights and you may also have other rights which vary from state to state.

JVC COMPANY OF AMERICA  
DIVISION OF JVC AMERICAS CORP.

1700 Valley Road  
Wayne, New Jersey 07470

REFURBISHED PRODUCTS CARRY A SEPARATE WARRANTY, THIS WARRANTY DOES NOT APPLY. FOR DETAILS OF REFURBISHED PRODUCT WARRANTY, PLEASE REFER TO THE REFURBISHED PRODUCT WARRANTY INFORMATION PACKAGED WITH EACH REFURBISHED PRODUCT.

**For customer use:**

Enter below the Model No. and Serial No. which is located either on the rear, bottom or side of the cabinet. Retain this information for future reference.

Model No.: \_\_\_\_\_

Serial No.: \_\_\_\_\_

Purchase date: \_\_\_\_\_

Name of dealer: \_\_\_\_\_





**JVC**

VICTOR COMPANY OF JAPAN, LIMITED

## Free Manuals Download Website

<http://myh66.com>

<http://usermanuals.us>

<http://www.somanuals.com>

<http://www.4manuals.cc>

<http://www.manual-lib.com>

<http://www.404manual.com>

<http://www.luxmanual.com>

<http://aubethermostatmanual.com>

Golf course search by state

<http://golfingnear.com>

Email search by domain

<http://emailbydomain.com>

Auto manuals search

<http://auto.somanuals.com>

TV manuals search

<http://tv.somanuals.com>