

MACROM



M2A.4000

Owner's Manual

www.macrom.it

Front/Rear view

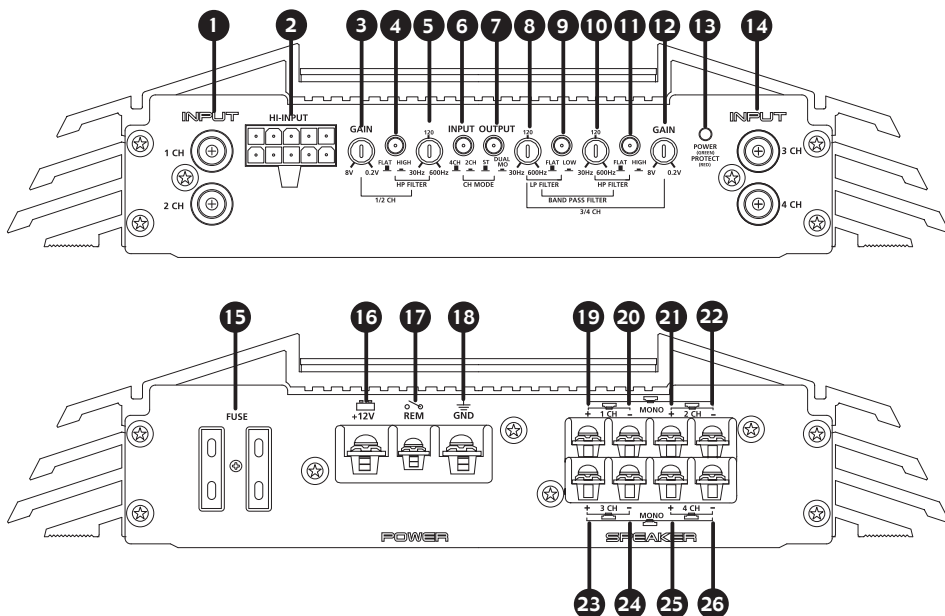

- 1 Low Level Input (CH1/CH2)
- 2 High Level Input (CH1/CH2 & CH3/CH4)
- 3 Gain Control (CH1/CH2)
- 4 High pass switch (CH1/CH2)
- 5 High pass cutting adjustment
- 6 Input Mode selector
- 7 Output Mode selector
- 8 Low pass cutting adjustment (CH3/CH4)
- 9 Low pass switch (CH3/CH4)
- 10 High pass cutting adjustment (CH3/CH4)
- 11 High pass switch (CH3/CH4)
- 12 Gain Control (CH3/CH4)
- 13 Led indicator
- 14 Low Level Input (CH3/CH4)

- 15 Fuse
- 16 12V (DC) power terminal
- 17 Remote terminal
- 18 GND terminal
- 19 + CH1 terminal (+ MONO)
- 20 - CH1 terminal
- 21 + CH2 terminal
- 22 - CH2 terminal (- MONO)
- 23 + CH3 terminal (+ MONO)
- 24 - CH3 terminal
- 25 + CH4 terminal
- 26 - CH4 terminal (- MONO)

Input setting CH1/CH2

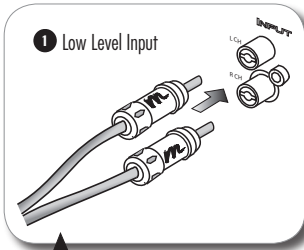

(Eng) Connect the output Audio coming from the car radio, in to the Low level input of the amplifier.

(FR) Relier par un câble RCA de bonne qualité les sorties RCA de l'autoradio aux entrées "Input" RCA de l'amplificateur.

(IT) Collegare l'uscita Audio proveniente dall'autoradio, all'ingresso Low level dell'amplificatore.

(D) Verbinden Sie den Audioausgang (RCA) des Autoradios mit dem RCA Eingang des Verstärkers.

(SP) Para conectar venir audio de la salida de la radio de coche, entrar el nivel bajo del amplificador.

(Eng) Low level OR High level - **(FR)** Avec des RCA ou avec des câbles haut-parleur -

(IT) Basso livello O Alto livello -

(D) Niedriges Niveau ODER hohes Niveau - **(SP)** Nivel bajo O alto nivel

(Eng) Connect the Loudspeakers output coming from the car radio, in to the High level input of the amplifier.

(FR) Relier les sorties haut-parleur de votre autoradio aux entrées haut niveau de l'amplificateur

(IT) Collegare l'uscita Altoparlanti provenienti dall'autoradio, all'ingresso Alto livello dell'amplificatore.

(D) Verbinden Sie den Audioausgang (HI-Level) des Autoradios mit dem HI-Level Eingang des Verstärkers.

(SP) Conecte venir hecho salir los altavoces de la radio de coche, adentro con la entrada del alto nivel del amplificador

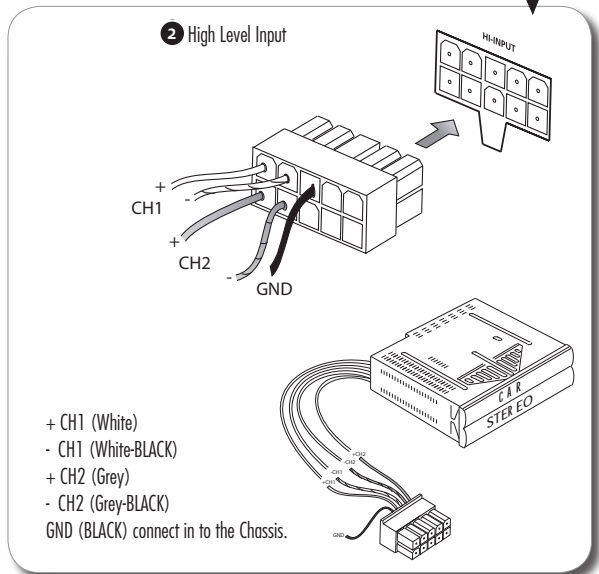

(Eng) Adjust the gain control, according to the Audio level output.

(FR) Ajuster le niveau d'entrée "Gain" de l'amplificateur.

(IT) Regolare il controllo di guadagno, in funzione del segnale Audio in uscita.

(D) Passen Sie mit dem Gainregler die Eing.empfindlichkeit an.

(SP) Ajuste el control del aumento, según la salida llana audio.

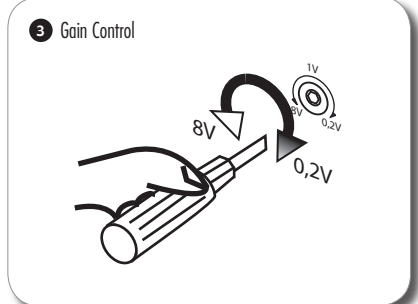

Input setting CH3/CH4

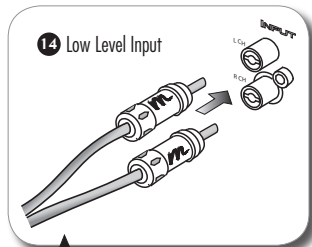

1 Low Level Input

(Eng) Connect the output Audio coming from the car radio, in to the Low level input of the amplifier.

(FR) Relier par un câble RCA de bonne qualité les sorties RCA de l'autoradio aux entrées "Input" RCA de l'amplificateur.

(IT) Collegare l'uscita Audio proveniente dall'autoradio, all'ingresso Low level dell'amplificatore.

(D) Verbinden Sie den Audioausgang (RCA) des Autoradios mit dem RCA Eingang des Verstärkers.

(SP) Para conectar venir audio de la salida de la radio de coche, entrar el nivel bajo del amplificador.

(Eng) Low level OR High level - **(FR)** Avec des RCA ou avec des câbles haut-parleur -

(IT) Basso livello O Alto livello -

(D) Niedriges Niveau ODER hohes Niveau - **(SP)** Nivel bajo O alto nivel

(Eng) Connect the Loudspeakers output coming from the car radio, in to the High level input of the amplifier.

(FR) Relier les sorties haut-parleur de votre autoradio aux entrées haut niveau de l'amplificateur.

(IT) Collegare l'uscita Altoparlanti provenienti dall'autoradio, all'ingresso Alto livello dell'amplificatore.

(D) Verbinden Sie den Audioausgang (HI-Level) des Autoradios mit dem HI-Level Eingang des Verstärkers.

(SP) Conecte venir hecho salir los altavoces de la radio de coche, adentro con la entrada del alto nivel del amplificador

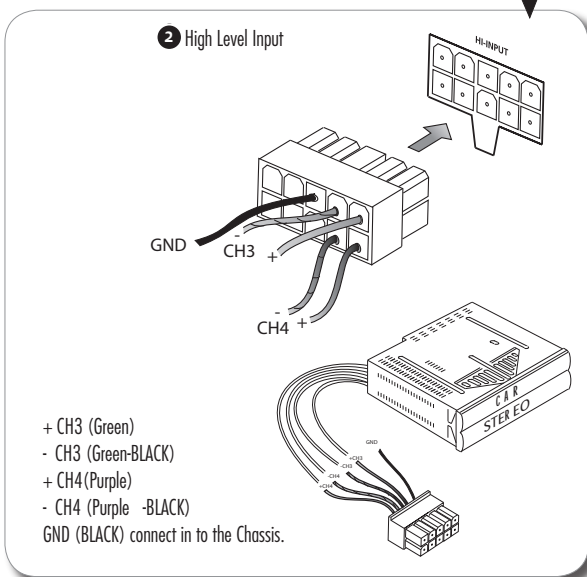

2 High Level Input

+ CH3 (Green)
 - CH3 (Green-BLACK)
 + CH4 (Purple)
 - CH4 (Purple -BLACK)
 GND (BLACK) connect in to the Chassis.

(Eng) Adjust the gain control, according to the Audio level output.

(FR) Ajuster le niveau d'entrée "Gain" de l'amplificateur.

(IT) Regolare il controllo di guadagno, in funzione del segnale Audio in uscita.

(D) Passen Sie mit dem Gainregler die Eing.empfindlichkeit an.

(SP) Ajuste el control del aumento, según la salida llana audio.

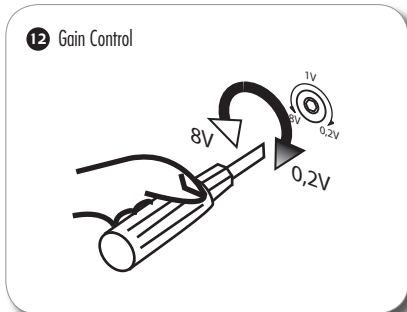

12 Gain Control

Crossover setting CH1/CH2

(Eng) Select "FLAT" for a complete frequency range.

(FR) Choisir la position "Flat" pour déconnecter le filtre actif (Large Bande).

(IT) Selezionare "FLAT" per una completa risposta in frequenza.

(D) Wählen Sie "FLAT" für eine Übertragung des gesamten Frequenzbereichs.

(SP) Seleccione "FLAT" para una gama de frecuencia del complete.

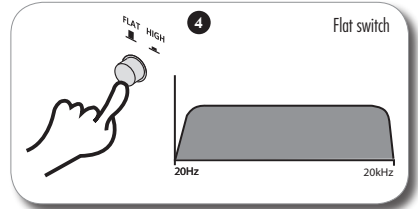

(Eng) Select "HIGH" for a high frequency range.

(FR) Choisir la position "High" pour utiliser le filtre actif passe haut.

(IT) Selezionare "HIGH" per la risposta delle frequenze alte.

(D) Wählen Sie "HIGH" für eine Übertragung des Hochton-Frequenzbereichs.

(SP) Seleccione el "HIGH" para una gama de alta frecuencia

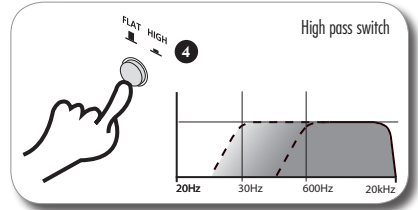

5 High pass cutting adjustment

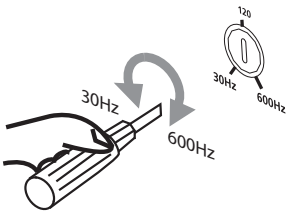

(Eng) The cut frequency is selectable between 30 to 600 Hz.

(FR) La fréquence de coupure est variable de 30 à 600Hz.

(IT) La frequenza di taglio è selezionabile fra 30 a 600 Hz.

(D) Die Trennfrequenz ist zwischen 30 bis 600 Hz einstellbar.

(SP) La frecuencia del corte es seleccionable entre 30 a 600 hertzios.

Crossover setting CH3/CH4

(Eng) Select "FLAT" for a complete frequency range.

(FR) Choisir la position "Flat" pour déconnecter le filtre actif (Large Bande).

(IT) Selezionare "FLAT" per una completa risposta in frequenza.

(D) Wählen Sie "FLAT" für eine Übertr. des ges. Frequenzbereichs.

(SP) Selecciona "FLAT" para una gama de frecuencia del complete.

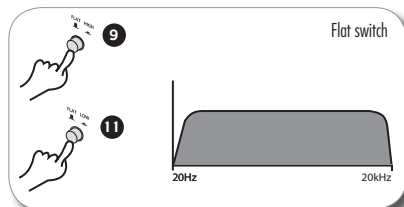

(Eng) Select "LOW" for a low frequency range.

(FR) Choisir la position "Low" pour utiliser le filtre actif passe bas.

(IT) Selezionare "LOW" per la risposta delle frequenze basse.

(D) Wählen Sie "LOW" für eine Übertr. des Bass-Frequenzbereichs.

(SP) Selecciona el "LOW" para una gama de la frecuencia baja.

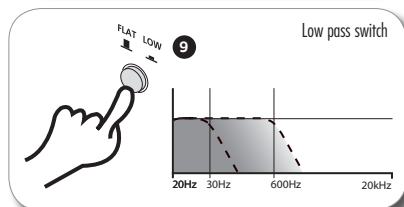

(Eng) Select "HIGH" for a high frequency range.

(FR) Choisir la position "High" pour utiliser le filtre actif passe haut.

(IT) Selezionare "HIGH" per la risposta delle frequenze alte.

(D) Wählen Sie "HIGH" für eine Übertragung des Hochton-Frequenzbereichs.

(SP) Selecciona el "HIGH" para una gama de alta frecuencia

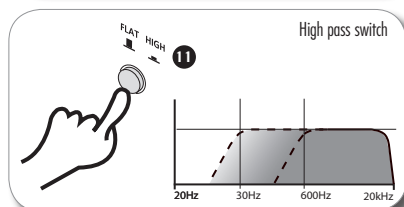

(Eng) Select "LOW and High" for a band pass frequency range.

(FR) Choisir les positions "High" et "Low" pour utiliser le filtre actif passe bande

(IT) Selezionare "LOW e HIGH" per la risposta passa banda.

(D) Wählen Sie "LOW und HIGH" für einen Bandpassbereich.

(SP) "LOW y HIGH selectos" para una gama de frecuencia del paso de la venda.

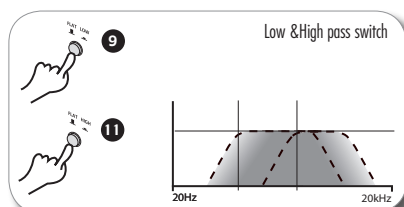

8 10 Low & High pass cutting adjustment

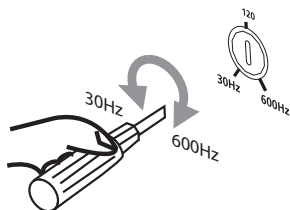

(Eng) The cut frequency is selectable between 30 to 600 Hz.

(FR) La fréquence de coupure est variable de 30 à 600Hz.

(IT) La frequenza di taglio è selezionabile fra 30 a 600 Hz.

(D) Die Trennfrequenz ist zwischen 30 bis 600 Hz einstellbar.

(SP) La frecuencia del corte es seleccionable entre 30 a 600 hertzios.

Input/Output Mode setting

(Eng) Loudspeakers configuration in function of the Inputs and Set up.

(FR) Tableau des configurations pour la compatibilité des impédances.

(IT) Configurazione altoparlanti in funzione degli ingressi e Set up.

(D) Lautsprecherkonfiguration in Abhängigkeit von den Eingängen.

(SP) Configuración de los altavoces en la función de las entradas e instalada.

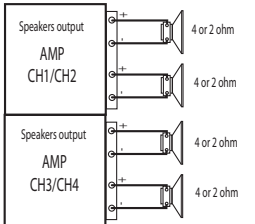
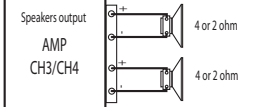
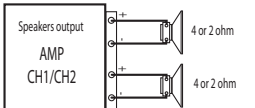
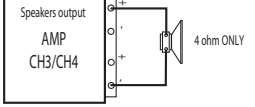
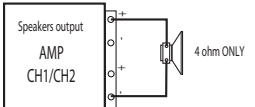
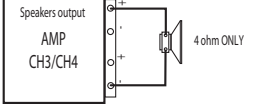
	RCA INPUT		SWITCH INPUT		SWITCH OUTPUT		SPEAKER OUTPUT CONFIGURATION	CROSSOVER CONFIGURATION
	CH1/CH2	CH3/CH3	4CH	2CH	ST	DUAL		
4 Channel Output	*	*	*		*			FLAT / HIGH
	*			*	*			FLAT / LOW HIGH BAND
3 Channel Output	*	*	*		*			FLAT / HIGH
	*			*	*			FLAT / LOW HIGH BAND
DUAL Channel Output	*			*		*		
								FLAT / LOW HIGH BAND

CH1/CH2 Speakers connection

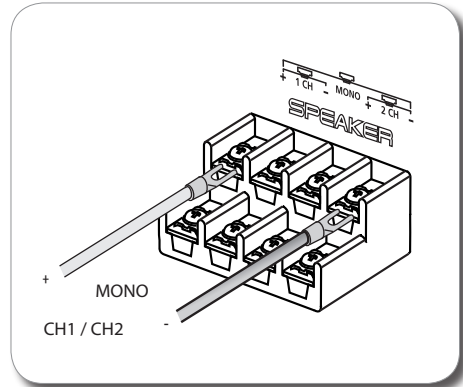
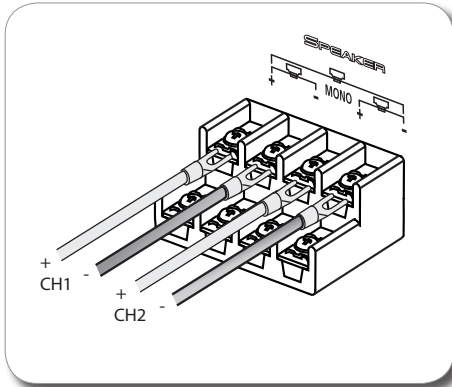

(Eng) Minimal acceptable Impedance 2 ohm. To adhere itself to the illustrations for the connections.

(FR) Impédance minimale 2 ohm en stéréo, 4 ohm ponté. Suivre les illustrations pour les branchements.

(IT) Minima Impedenza accettabile 2 ohm. Attenersi alle illustrazioni per i collegamenti

(D) Minimale Anschlußimpedanz 2 Ohm. Beachten Sie die Abbildungen für die Anschlüsse.

(SP) Impedancia aceptable mínima 2 ohmios. Para adherirse a las ilustraciones para las conexiones.

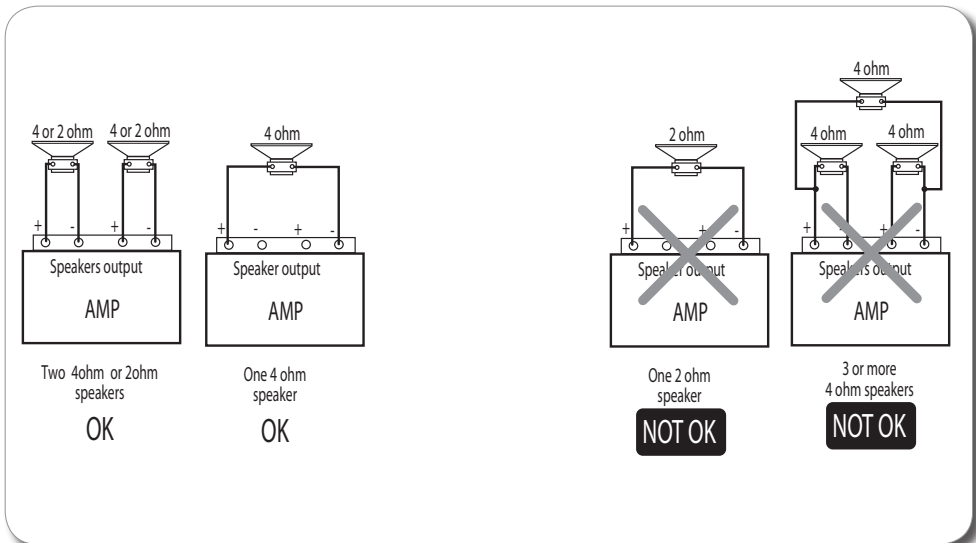

CH3/CH4 Speakers connection

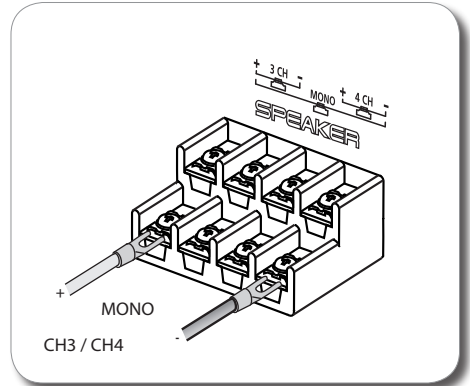
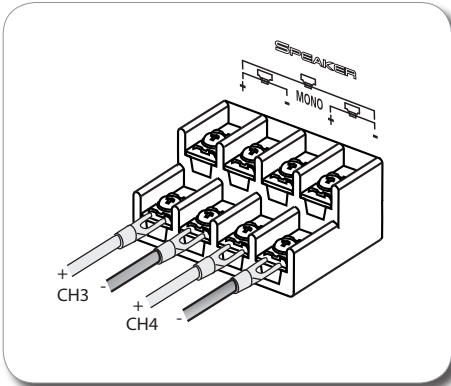

(Eng) Minimal acceptable Impedance 2 ohm. To adhere itself to the illustrations for the connections.

(FR) Impédance minimale 2 ohm en stéréo, 4 ohm ponté. Suivre les illustrations pour les branchements.

(IT) Minima Impedenza accettabile 2 ohm. Attenersi alle illustrazioni per i collegamenti

(D) Minimale Anschlußimpedanz 2 Ohm. Beachten Sie die Abbildungen für die Anschlüsse.

(SP) Impedancia aceptable mínima 2 ohmios. Para adherirse a las ilustraciones para las conexiones.

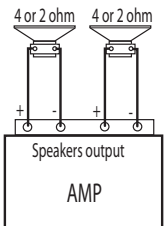

Two 4ohm or 2ohm speakers

OK

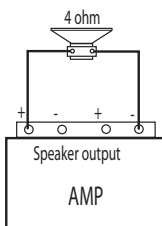

One 4 ohm speaker

OK

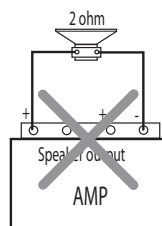

One 2 ohm speaker

NOT OK

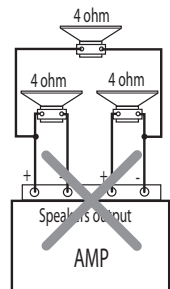

3 or more 4 ohm speakers

NOT OK

Power connection

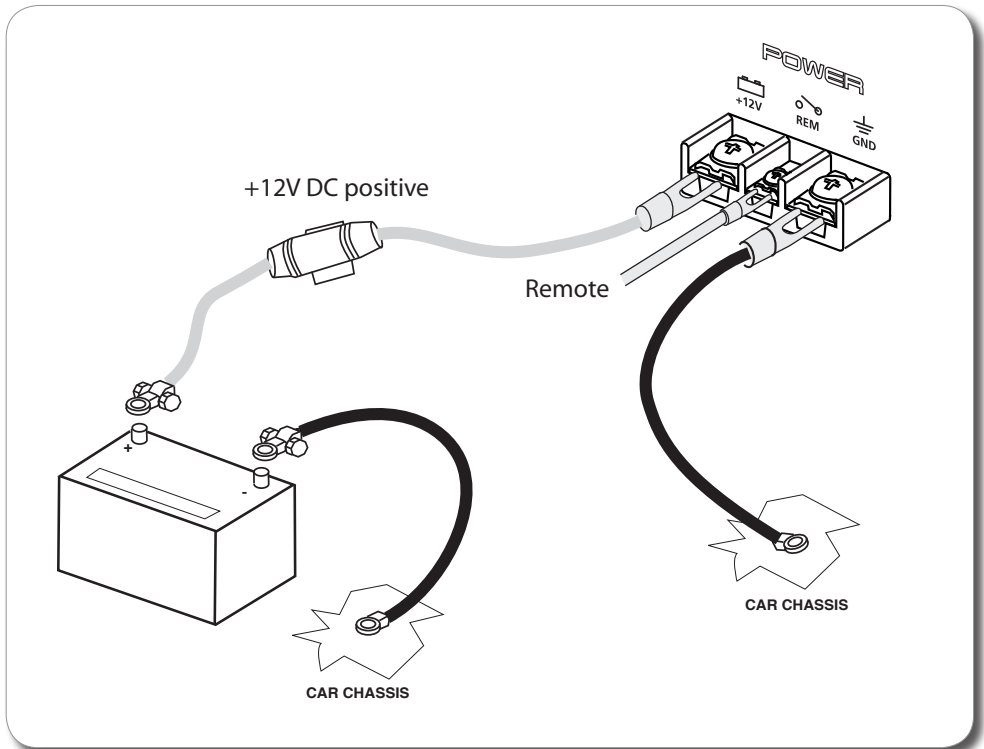

(Eng) Connect the Positive (+12V) directly to the Battery of the car. To make sure itself to insert a fuse of adequate amperage in order protect the system. Connect the Ground in to the car chassis, close as possible to the amplifier.

(FR) Relier la borne +Battery de l'amplificateur directement à la borne +12V de la batterie du véhicule à l'aide d'un câble de section appropriée. Il est indispensable de placer un fusible à moins de 30 cm de la batterie.

Relier la borne -GND de l'amplificateur au châssis du véhicule à l'aide d'un câble de même section que l'alimentation et le plus court possible.

(IT) Collegare il Positivo (+12V) direttamente alla Batteria dell'auto. Assicurarsi di inserire un fusibile di adeguato amperaggio per proteggere il sistema. Collegare il Negativo al telaio dell'automobile, più vicino possibile all'amplificatore.

(D) Schließen Sie das Stromkabel (+12V, Rot) direkt an die Batterie ihres Fahrzeugs an.

Um sich selbst und die Geräte zu schützen verwenden Sie entsprechend dimensionierte Kabel und eine dafür ausgelegte Sicherung. Diese sollte max. 20cm nach der Batterie verbaut werden. Verbinden Sie die Masseleitung (-, Schwarz) mit der Fahrzeugkarosserie. Achten Sie auch hierbei auf eine ausreichende Dimensionierung der Leitungen.

(SP) Conecte el positivo (+12V) directamente con la batería del coche. Para cerciorarse de sí mismo para insertar un fusible del amperaje adecuado en orden proteja el sistema.

Conecte la negativa adentro con el chasis del coche, cierre como sea posible al amplificador.

Features

- **Four channel power amplifier**
- **90 x4 watts into 2 ohms load**
- **60 x2 watts into 4 ohms load**
- **T03P transistor on amplifier stage**
- **Variable Low-High-Band pass x-over at 18/12dB/oct on rear section**
- **Variable High pass x-over at 12dB/oct on front section**
- **In/Out mode selector (2/4 ch In)(ST/Dual mono Out)**
- **Adjustable x-over from 30Hz to 600Hz**
- **High level Input (booster In)**
- **Mos-Fet power supply**
- **Screws terminals connectors**

Technical data

RMS Power at 4 ohm Stereo load at 14,4 volts	60 x 4 watts
RMS Power at 2 ohm Stereo load at 14,4 volts	90 x 4 watts
RMS Power at 4 ohm Bridged load at 14,4 volts	180 x 2 watts
THD (total Harmonic Distortion)	< 0,1%
Frequency response (+0/-1 dB)	10 - 30,000Hz
Signal to noise ratio	> 95dB
Low Input sensitivity	200-8,000mV
High Input sensitivity	1-10V
Input impedance	22k/100 ohm
Crossover type	Variable
Crossover frequency & filter slop (High-pass)	30 to 600Hz -12dB/octave
Crossover frequency & filter slop (Low-pass)	30 to 600Hz -18dB/octave
Dimension (w * h * d) mm	244 x 54 x 280

Free Manuals Download Website

<http://myh66.com>

<http://usermanuals.us>

<http://www.somanuals.com>

<http://www.4manuals.cc>

<http://www.manual-lib.com>

<http://www.404manual.com>

<http://www.luxmanual.com>

<http://aubethermostatmanual.com>

Golf course search by state

<http://golfingnear.com>

Email search by domain

<http://emailbydomain.com>

Auto manuals search

<http://auto.somanuals.com>

TV manuals search

<http://tv.somanuals.com>