

marantz®

Model PV6111W User Guide

HD-Ready Rear Projection Television











As an ENERGY STAR® Partner, Marantz has determined that this product meets the ENERGY STAR® guidelines for energy efficiency. ENERGY STAR is a U.S. registered mark.

Contents

GENERAL INFORMATION

IMPORTANT INFORMATION	3
IMPORTANT SAFEGUARDS	4
Main Features	6
Supplied Accessories	7
Before Operating Your Rear Projection TV	7
Antenna Connections	9
Main Unit	13
Basic Remote Control Functions	14
EZ SETUP on First Power On	16

BASIC OPERATIONS

Menu Functions	17
 TIMER/CLOCK	19
CLOCK SET	19
SLEEP TIME	21
TV-ON TIME	22
 Closed Caption	24
How to set Closed Caption	24
 Video Adjust	25
VIDEO Adjust	25
PRO Adjust	26
VIDEO NR	27
OPC (optical control)	27
 Audio Adjust	28
Audio Adjust	28
Other Audio Settings	29
MTS/SAP Select mode	30
 Screen Adjust	31
 Parent Control (V-CHIP operation)	33
 How to Set V-CHIP	35
Parent Control First Setting	35
MPAA Rating	36
TV Rating	37
Additional mode	38
Turn on V-CHIP Block	40
 Parent Control (VIEW TIMER)	43
VIEW TIMER	43
 Channel Setup	45
AIR/CABLE Setting	45
Saving Broadcast TV channels to memory (Channel Search)	46
Adding Weak or Additional Channels or Erasing Unwanted Channels from TV Memory	47
FAVORITES	48
UNIVERSAL PLUS Function	49

 Setup	50
LANGUAGE	50
GRAY SCREEN	51
ENERGY SAVE	52
CONVERGENCE ADJUST	53
INPUT MODE	55
CH/INPUT ID	56

SPECIAL FUNCTIONS

Changing Screen Size	57
Selecting DDFC Mode or AV Mode	58
Selecting DDFC Mode	58
Selecting AV Mode	58
Multi-screen Function	59
View two Screens (TWIN PICTURE Screen)	59
Making Notes From the Program Content (Freeze Screen)	60
Searching for a Program on a Different Channel (Search Screen)	61
Interchanging the Left and Right Screens you are Currently Watching (Swap Screen)	62
Scanning other channels during a commercial break (Commercial Skip)	62

OTHERS

Operation of the Remote Control for Other Devices	63
How to Identify a VCR	64
Identifying your VCR through the Search method ...	65
How to Identify a DVD Player	66
How to Identify a DTV STB (Digital TV Set-Top Box)	67
Identifying your DTV STB through the Search method	67
How to Identify a Cable Converter	68
Identifying your Cable Converter through the Search method	68
Specifications	69
Using the Video and Audio Input Jacks	70
Using the Audio Output Jacks	72
Before Calling for Service	73

Spanish (Español)/French (Français)

Unidad Principal	74
Funciones Básicas del Control Remoto	75
Antes de llamar al Servicio de Reparaciones	76
Unité Principale	77
Fonctions de Base de la Télécommande	78
Avant de faire appel au Service Après-vente ..	79

All mentions of "Rear Projection TV" in this OPERATION MANUAL refer to the Marantz HD-Ready Rear Projection Television.

IMPORTANT

To aid reporting in case of loss or theft, please record the Rear Projection TV model and serial numbers in the space provided. The numbers are located at the rear of the Rear Projection TV.

Model No.: _____

Serial No.: _____

Important Information

WARNING: TO REDUCE THE RISK OF FIRE OR ELECTRIC SHOCK, DO NOT EXPOSE THIS APPLIANCE TO RAIN OR MOISTURE

	CAUTION RISK OF ELECTRIC SHOCK DO NOT OPEN	
CAUTION: TO REDUCE THE RISK OF ELECTRIC SHOCK, DO NOT REMOVE COVER (OR BACK). NO USER-SERVICEABLE PARTS INSIDE. REFER SERVICING TO QUALIFIED SERVICE PERSONNEL.		



The lightning flash with arrowhead within a triangle is intended to tell the user that parts inside the product are a risk of electric shock to persons.



The exclamation point within a triangle is intended to tell the user that important operating and servicing instructions are in the papers with the appliance.

CAUTION: TO PREVENT ELECTRIC SHOCK, MATCH WIDE BLADE OF PLUG TO WIDE SLOT, FULLY INSERT.

WARNING - FCC Regulations state that any unauthorized changes or modifications to this equipment not expressly approved by the manufacturer could void the user's authority to operate this equipment.

Note on the TWIN PICTURE screen and SEARCH screen functions

The TWIN PICTURE screen and SEARCH screen functions provided in this monitor are intended for private viewing only. Use of the above video processing functions for profitmaking purpose or for public viewing (clubs, hotels, etc.) without prior authorization from the transmitter and/or owner of the video program(s) may be an infringement of existing copyright laws.

"Note to CATV system installer: This reminder is provided to call the CATV system installer's attention to Article 820-40 of the National Electrical Code that provides guidelines for proper grounding and, in particular, specifies that the cable ground shall be connected to the grounding system of the building, as close to the point of cable entry as practical."

INFORMATION

This equipment has been tested and found to comply with the limits for a Class B digital device, pursuant to Part 15 of the FCC Rules. These limits are designed to provide reasonable protection against harmful interference in a residential installation. This equipment generates, uses, and can radiate radio frequency energy and, if not installed and used in accordance with the operation manual, may cause harmful interference to radio communications. However, there is no guarantee that interference will not occur in a particular installation. If this equipment does cause harmful interference to radio or television reception, which can be determined by turning the equipment off and on, the user is encouraged to try to correct the interference by one or more of the following measures:

- Relocate or adjust the receiving antenna.
- Increase the separation between the equipment and receiver.
- Connect the equipment into an outlet on a circuit different from that to which the receiver is connected.
- Consult the dealer or an experienced radio/TV technician for help.

NOTE: This Rear Projection TV will display television closed captioning, in accordance with paragraph 15.119 of the FCC rules.

NOTICE ON ADVERSE EFFECTS ON THE SCREEN

When playing TV games or displaying still pictures with your Rear Projection TV, be sure to keep in mind the following points:

Picture Burn Prevention

- Continuous on-screen displays such as video games, stock market quotations, computer generated graphics, and other fixed (non-moving) patterns can cause permanent damage to projection television receivers. Such "PATTERN BURNS" constitute misuse and are **NOT COVERED** by your Marantz Factory Warranty.
- When using TWIN PICTURE/Multi-Picture function, the sub-picture should not be left permanently in one corner of the screen or a "PATTERN BURN" may develop over a long period of time.

Public Viewing of Copyrighted Material

Public viewing of programs broadcast by TV stations and cable companies, as well as programs from other sources, may require prior authorization from the broadcaster or owner of the video program material.

IMPORTANT SAFETY INSTRUCTIONS

Electrical energy can perform many useful functions. This unit has been engineered and manufactured to ensure your personal safety. But **IMPROPER USE CAN RESULT IN POTENTIAL ELECTRICAL SHOCK OR FIRE HAZARD**. In order not to defeat the safeguards incorporated into this equipment, observe the following basic rules for its installation, use and servicing. For your own protection and reliable usage of your equipment, please be sure to read these "Important Safeguards" carefully before use.

1. Read Instructions—All the safety and operating instructions should be read before the product is operated.
2. Retain Instructions—The safety and operating instructions should be retained for future reference.
3. Heed Warnings—All warnings on the product and in the operating instructions should be adhered to.
4. Follow Instructions—All operating and use instructions should be followed.
5. Cleaning—Unplug this product from the wall outlet before cleaning. Do not use liquid cleaners or aerosol cleaners. Use a damp cloth for cleaning.
6. Attachments—Do not use attachments not recommended by the product manufacturer as they may cause hazards.
7. Water and Moisture—Do not use this product near water – for example, near a bathtub, wash bowl, kitchen sink, or laundry tub; in a wet basement; or near a swimming pool; and the like.
8. Accessories—Do not place this product on an unstable cart, stand, tripod, bracket or table. The product may fall, causing serious injury to a child or adult, and serious damage to the product. Use only with a cart, stand, tripod, bracket or table recommended by the manufacturer, or sold with the product. Any mounting of the product should follow the manufacturer's instructions, and should use a mounting accessory recommended by the manufacturer.
9. Wall or Ceiling Mounting—The product should be mounted to a wall or ceiling only as recommended by the manufacturer.
10. A product and cart combination should be moved with care. Quick stops, excessive force, and uneven surfaces may cause the product and cart combination to overturn.
11. Ventilation—Slots and openings in the cabinet are provided for ventilation to ensure reliable operation of the product and to protect it from overheating, and these openings must not be blocked or covered. The openings should never be blocked by placing the product on a bed, sofa, rug, or other similar surface. This product should not be placed in a built-in installation such as a bookcase or rack unless proper ventilation is provided or the manufacturer's instructions have been adhered to.
12. Power Sources—This product should be operated only from the type of power source indicated on the marking label. If you are not sure of the type of power supply to your home, consult your product dealer or local power company. For products intended to operate from battery power, or other sources, refer to the operating instructions.
13. Grounding or Polarization—This product may be equipped with a polarized alternating-current line plug (a plug having one blade wider than the other). This plug will fit into the power outlet only one way. This is a safety feature. If you are unable to insert the plug fully into the outlet, try reversing the plug. If the plug should still fail to fit, contact your electrician to replace your obsolete outlet. Do not defeat the safety feature of the polarized plug.
14. Power-Cord Protection—Power-supply cords should be routed so that they are not likely to be walked on or pinched by items placed upon or against them, paying particular attention to cords at plugs, convenience receptacles, and the point where they exit from the product.
15. Lightning—For added protection for this product during a lightning storm, or when it is left unattended and unused for long periods of time, unplug it from the wall outlet and disconnect the antenna or cable system. This will prevent damage to the product due to lightning and power-line surges.



16. Power Lines—An outside antenna system should not be located in the vicinity of overhead power lines or other electric light or power circuits, or where it can fall into such power lines or circuits. When installing an outside antenna system, extreme care should be taken to keep from touching such power lines or circuits as contact with them might be fatal.
17. Overloading—Do not overload wall outlets, extension cords, or integral convenience receptacles as this can result in a risk of fire or electric shock.
18. Object and Liquid Entry—Never push objects of any kind into this product through openings as they may touch dangerous voltage points or short-out parts that could result in a fire or electric shock. Never spill liquid of any kind on the product.
19. Servicing—Do not attempt to service this product yourself as opening or removing covers may expose you to dangerous voltage or other hazards. Refer all servicing to qualified service personnel.
20. Damage Requiring Service—Unplug this product from the wall outlet and refer servicing to qualified service personnel under the following conditions:
 - a. When the power-supply cord or plug is damaged.
 - b. If liquid has been spilled, or objects have fallen into the product.
 - c. If the product has been exposed to rain or water.
 - d. If the product does not operate normally by following the operating instructions. Adjust only those controls that are covered by the operating instructions, as an improper adjustment of other controls may result in damage and will often require extensive work by a qualified technician to restore the product to normal operation.
 - e. If the product has been dropped or damaged in any way.
 - f. When the product exhibits a distinct change in performance—this indicates a need for service.
21. Replacement Parts—When replacement parts are required, be sure the service technician has used replacement parts specified by the manufacturer or with the same characteristics as the original part. Unauthorized substitutions may result in fire, electric shock, or other hazards.
22. Safety Check—Upon completion of any service or repairs to this product, ask the service technician to perform safety checks to determine that the product is in proper operating condition.
23. Heat—The product should be situated away from heat sources such as radiators, heat registers, stoves, or other products (including amplifiers) that produce heat.
24. Outdoor Antenna Grounding—If an outside antenna or cable system is connected to the product, be sure the antenna or cable system is grounded so as to provide some protection against voltage surges and built-up static charges. Article 810 of the National Electrical Code, ANSI/NFPA 70, provides information with respect to proper grounding of the mast and supporting structure, grounding of the lead-in wire to an antenna discharge unit, size of grounding conductors, location of antenna-discharge unit, connection to grounding electrodes, and requirements for the grounding electrode.

EXAMPLE OF ANTENNA GROUNDING ACCORDING TO NATIONAL ELECTRICAL CODE, ANSI/NFPA 70

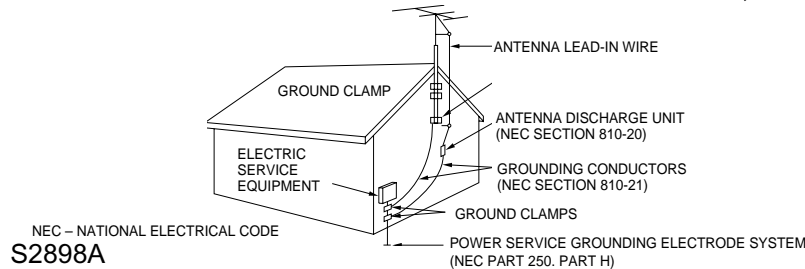

25. Do not subject your Monitor to impact of any kind. Be particularly careful not to damage the screen surface.

Main Features

- **SDTV and HDTV compatible**

SDTV and HDTV broadcasts can be displayed by connecting a commercially available DTV decoder.

- **DUAL TUNER (TWIN PICTURE screen and SEARCH screen function)**

Two TV tuners are provided, making it possible to split the screen vertically in two and display moving images simultaneously on them. In addition, the channel search function makes it possible to view other programs on the right side of the screen.

DTV HIGH IMAGE QUALITY

- **HD CONTRAST ENHANCER (30MHz)**

A CRT driver compatible with broadband HD broadcasts is used to minimize black and white bleeding for faithful reproduction.

- **HD COLOR PURITY PROCESSOR (30MHz)**

This processor is compatible with broadband HD broadcasts and achieves faithful and vivid color reproduction.

NTSC HIGH IMAGE QUALITY

- **DDFC (Digital Double Format Converter) - 1080 CIRCUIT**

This circuit first converts conventional broadcasts to 480P and then further converts them to 1080I images for reduced flicker and smooth edges.

- **10-BIT 3D-Y/C CIRCUIT**

The use of high-definition brightness signal processing from 8 bits to 10 bits improves data resolution capability by a factor of 4 for a much higher S/N ratio.

- **INTELLIGENT NOISE REDUCTION CIRCUIT**

This circuit detects the image S/N ratio and controls Y coring emphasizing the brightness signal element at the optimum level for image reproduction with minimal noise.

- **EVC (Enhanced Video Circuit)**

The use of intelligent gamma and luminance/chrominance transit correction results in optimum picture quality suitable for large screens.

- **Dual System Component Input for NTSC/Progressive**

Connection to a DVD player with a component output terminal enables high picture quality, superior to that of S-VIDEO terminal connections. Also, the Rear Projection TV has a high-resolution component input (480I, 480P, 1080I), which functions as an interface for high-quality HDTV and DVD images.

HIGH SOUND QUALITY

- **3D Q SOUND (3D VIRTUAL SURROUND)**

New 3D sound processing is used to obtain a sound field with natural expansion and a greater sense of depth. Virtual surround is possible with only 2 speakers by connecting a DTV Decoder and DVD (Dolby digital).

- **4-speaker system**

With the high sound quality, you can enjoy a powerful audio presence during HDTV movie broadcasts.

OTHERS

- **Universal remote control with light function**

The remote control allows you to easily operate a DTV Decoder as well as a VCR, DVD player and cable box. It also comes with a function to light up the main buttons for use in a dimly-lit room.

- **PICTURE OUT PICTURE**

The two built-in tuners enable you to watch two TV programs at the same time, one in the main picture and one as the sub-picture, while a commercial message is on the screen.

- **VARIABLE AUDIO OUTPUT (VAO)**

The VAO offers TV remote control of the volume level from separate audio components.

Supplied Accessories

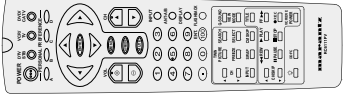
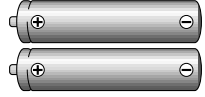
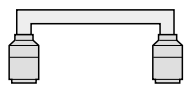
		
Infrared Remote Control Part Number : RRMCG1704CESA	Size AA Dry Batteries (2 pcs.)	Coaxial Cable

Before Operating Your Rear Projection TV

Location

- For normal operation, your Rear Projection TV should be set up in the room where cool, adequate ventilation is provided. Do not position the back of the Rear Projection TV in a place where free airflow is restricted.
- Any magnetic force may disturb the color picture. Make sure that magnets, speakers, electric clocks, toys using magnets or any other magnetic substance, such as an iron are kept well away from this Rear Projection TV.

Power

Your Rear Projection TV operates on 120 Volts, 60 Hertz (normal household current in the USA) and has a polarized plug. If you are unable to insert the plug fully into the outlet, try reversing the plug. If it does not fit, contact an electrician. Do not defeat the safety feature of the polarized plug.



- If the Rear Projection TV is not used for a long period, unplug the Rear Projection TV from the wall outlet to economize power. (If the Rear Projection TV is plugged in, slight current still flows, even with the POWER button in the OFF position.)
- Lines and other noise may appear in TV broadcast images when an FM tuner or radio is located near the Rear Projection TV and radio and TV broadcasts are received at the same time. Should such noise appear, turn off either the Rear Projection TV or the radio.
- If you are listening to AM broadcasts, turn the Rear Projection TV off. AM broadcast signals may not be received due to the interference of the Rear Projection TV.

Convergence

Your Rear Projection TV may need to be converged after being installed in your home. Please follow the simple instructions on page 53.

Before Operating Your Rear Projection TV (Continued)

Viewing

The main feature of the Rear Projection TV is its large viewing screen. To be able to enjoy this large screen at its best, test the Rear Projection TV by placing it in various different parts of the room, in which it will be set, to find the ideal spot for viewing.

It is best viewed by sitting directly in front of the Rear Projection TV and about 10 to 18 feet from the screen. The brightness decreases as the viewer moves to the left or to the right of the set.

During the daytime, reflections from light outside may appear on the screen. Drapes or screens can be used to reduce the reflection or the Rear Projection TV can be placed in a different part of the room.

If the Rear Projection TV's audio output is connected to a Hi-Fi system's external speakers, the best audio performance will be obtained by placing the speakers on each side of the set at an equal distance as well as on a height which is equal to that of the screen center. For best stereo separation, first place the external speakers at least four feet from each side of the Rear Projection TV, then place the surround speakers to the side or behind the viewing area. Due to the differences in room sizes and acoustic environments some experimentation regarding speaker placement for best performance will be required.

Before using the Rear Projection TV, prepare the remote control.

To use the remote control, insert batteries first.

- 1** Open the battery cover. Pull up the lid in the direction of the arrow.

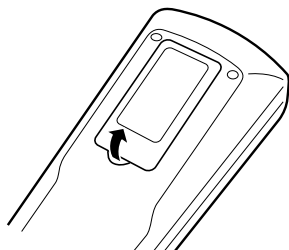

- 2** Load the batteries. Load the two "AA" size batteries supplied so that the battery poles \oplus and \ominus are positioned as indicated.

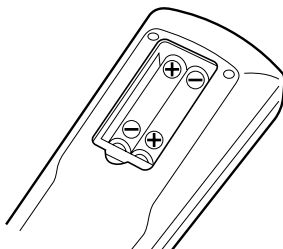

- 3** Close the battery cover. Lower the lid in the direction of the arrow.

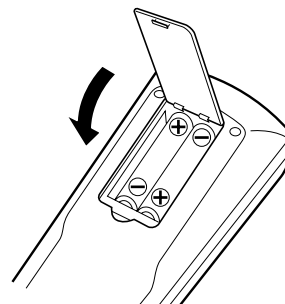

Antenna Connections

- To fully utilize the various features provided, such as the 2-Tuner POP System, UNIVERSAL PLUS, and some connectors for high-quality VCR/DVD playback, set up this unit properly by following the procedures below.

Universal Remote Control

- The UNIVERSAL REMOTE CONTROL can be compatible with various VCR/DVD player and CATV converter brands by setting the correct control code.

UNIVERSAL PLUS

- The VCR/DVD input mode is selected by pressing the VCR/DVD player PLAY button on the UNIVERSAL REMOTE CONTROL.
- To use this UNIVERSAL PLUS function, the settings on page 49 must be set in advance.

Antennas

- The antenna requirements for good color Rear Projection TV reception are more important than those for black & white television reception. For this reason, a good quality outdoor antenna is strongly recommended.

Type of connector	
<p>1. The 75 ohm system generally uses a round cable with an F-type connector that can easily be attached to a terminal without tools (not supplied). The F-type connector should be finger tightened only.</p>	<p>F-type connector</p> <p>75-ohm coaxial cable (round)</p>
<p>2. The 300 ohm system uses a flat "twin-lead" cable that can be attached to a 75 ohm terminal through a 300-75 ohm ADAPTOR (not supplied).</p>	<p>300-ohm twin-lead cable (flat)</p>

- Switching between ANTENNA-A and ANTENNA-B is possible by pressing the ANT-A/B button on the remote control.
- A good color picture depends on a good TV signal, and so does good multi-channel sound. Ask your dealer for advice on how to install your external antenna to receive the best possible signal.
- If you subscribe to Cable TV or have a central antenna in your building, you may not need an external antenna.

A-1. Connection with Converter/Descrambler Box and VCR

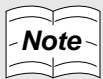
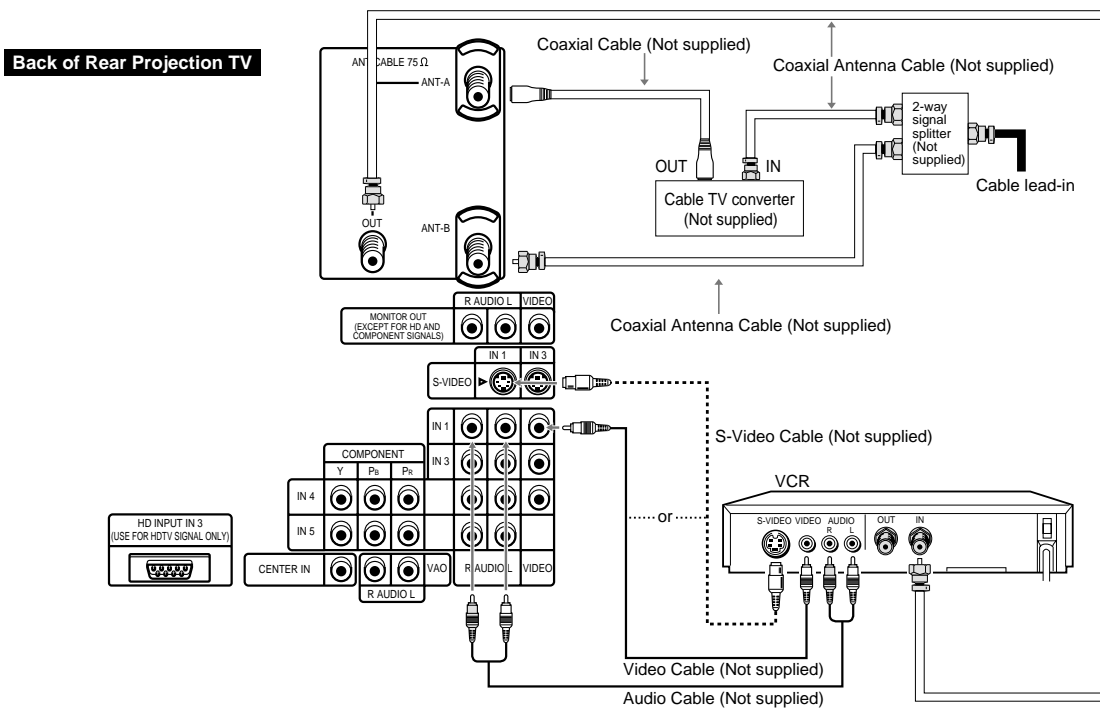

- Shown here is the preferred method of connecting a VCR and CATV Converter to your Rear Projection TV if you are in an area with good signal reception. This way you can view either TV programs or VCR tapes regardless the position of the VCR's TV/VCR switch and you can enjoy stereo tape playback from a stereo VCR.
- If your VCR has an S-VIDEO or S-VHS OUT connector, you can connect it to the S-VIDEO IN 1, IN 2 (on the front of the Rear Projection TV) or IN 3 connector on the Rear Projection TV in addition to or instead of using the video cable.

Antenna Connections (Continued)

A-2. Connection recommendation if your cable TV converter has AUX terminals. (If your cable TV converter has both RF OUTPUT and AUX terminals, it is recommended to connect them as shown in example A-1.)

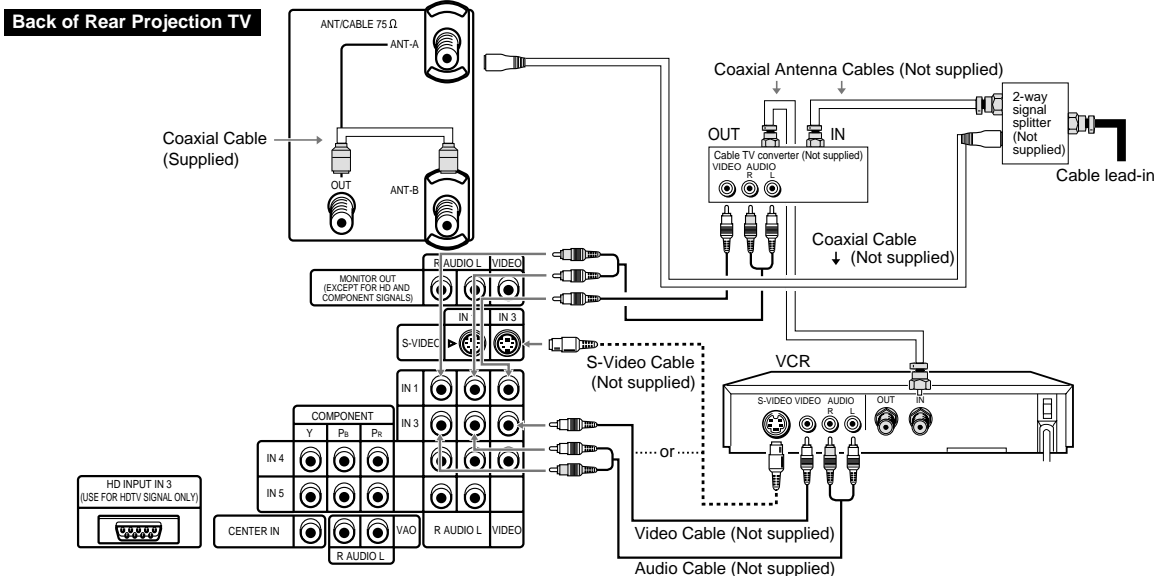

B. Connection with Converter/Descrambler Box without VCR

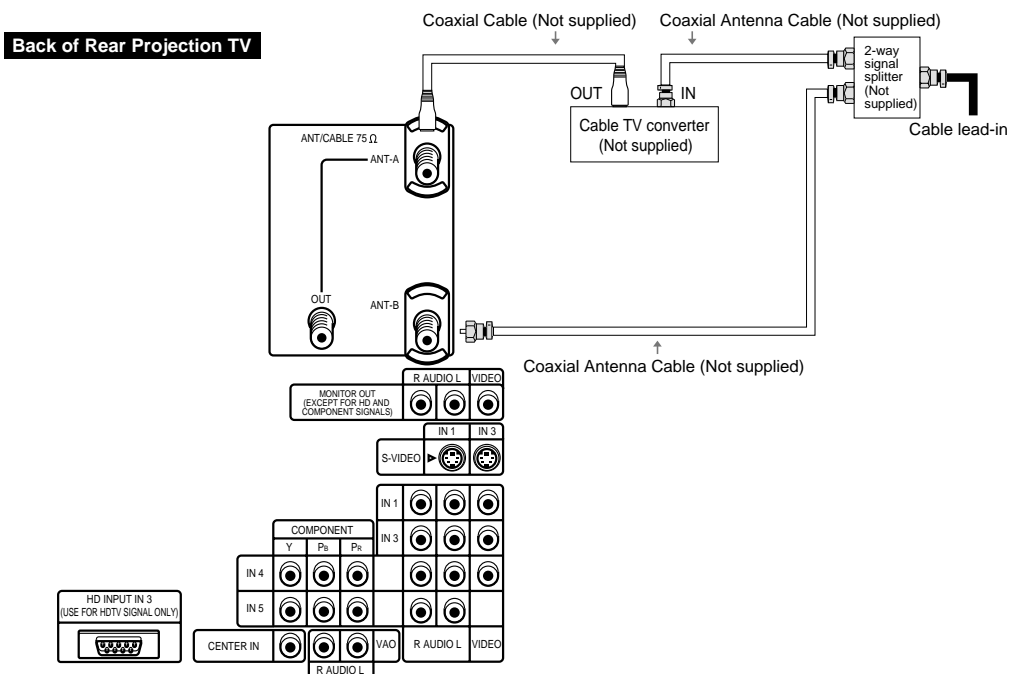

Antenna Connections (Continued)

C. Connection with Antenna Cable and VCR

Back of Rear Projection TV

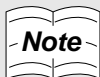
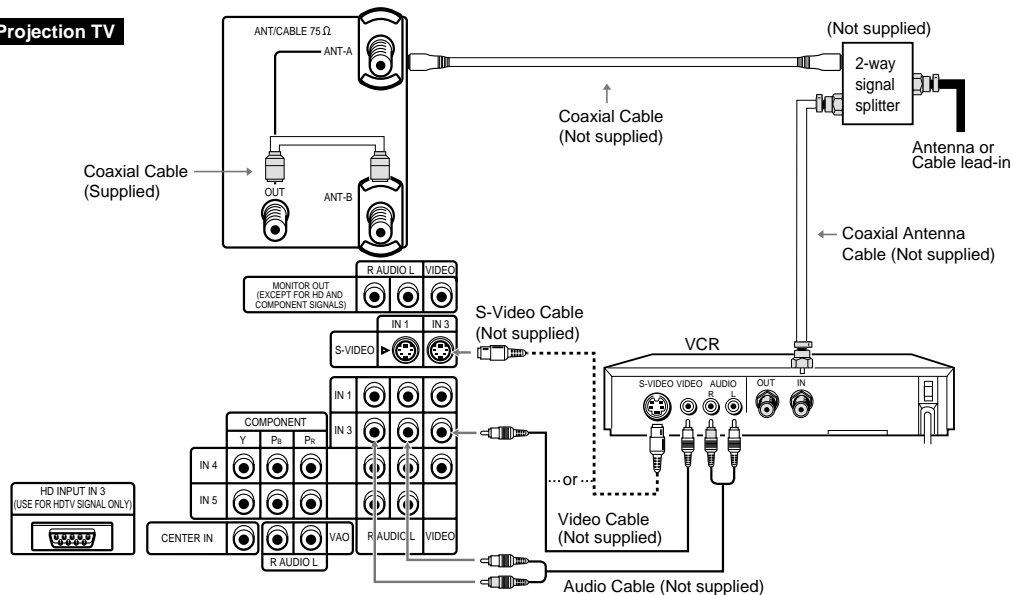

- Shown here is the preferred method of connecting a VCR to your Rear Projection TV if you are in an area with good signal reception. This way you can view either TV programs or VCR tapes regardless of the position of the VCR's TV/VCR switch and you can enjoy stereo tape playback from stereo VCR.
- If your VCR has an S-VIDEO or S-VHS OUT connector, you can connect it to the S-VIDEO IN 1, IN 2 or IN 3 connector on the Rear Projection TV in addition to or instead of using the video cable.
- To enable the Commercial Skip function (See page 62), connect your TV OUT and ANT-B connector with the coaxial cable (supplied).
- If your lead cable is a 300 ohm twin-lead cable or UHF/VHF separate cable, use a 300/75 ohm ADAPTOR or COMBINER (output side is 75 ohm coaxial) to connect to the Rear Projection TV.

D. Connection with Converter/Descrambler Box and DVD

Back of Rear Projection TV

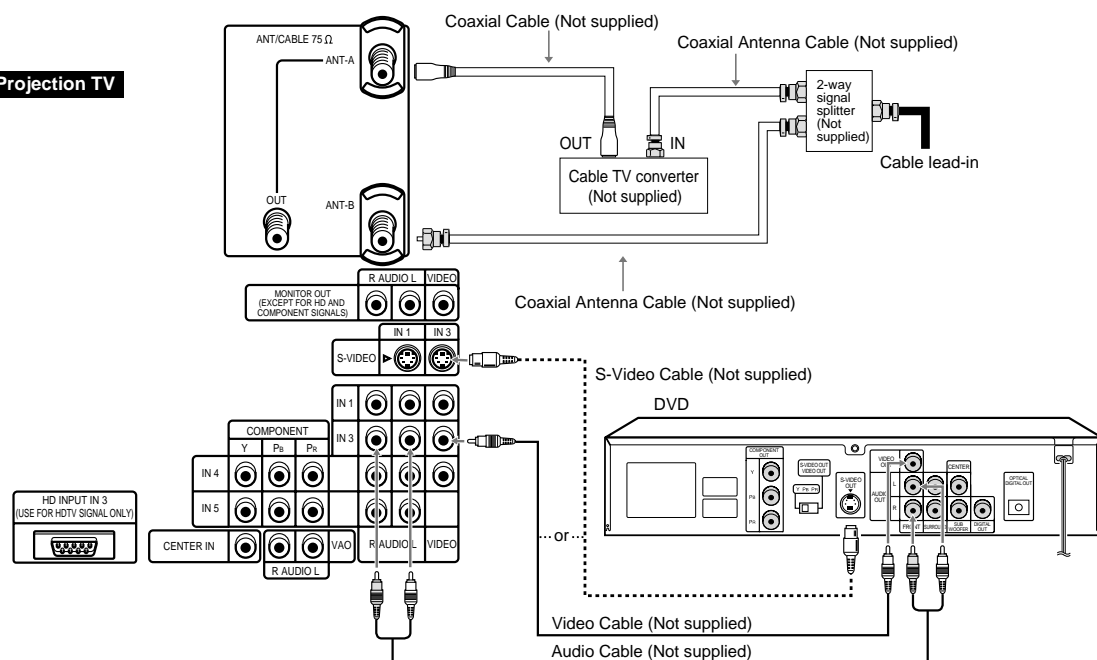

Antenna Connections (Continued)

E. Connection with Antenna Cable

1. Cable without a CATV Converter
2. VHF/UHF Combination Antenna

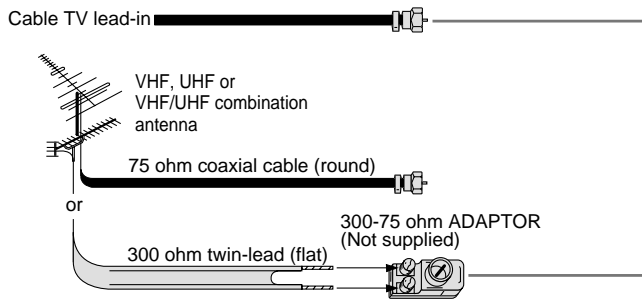

3. Separate VHF/UHF Antenna

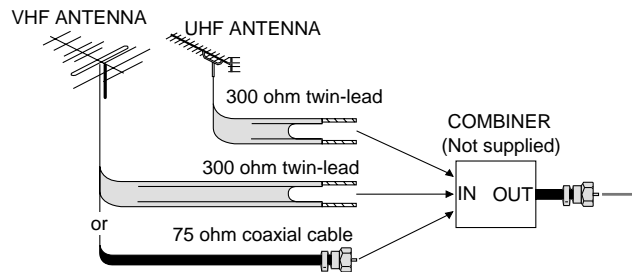

Back of Rear Projection TV

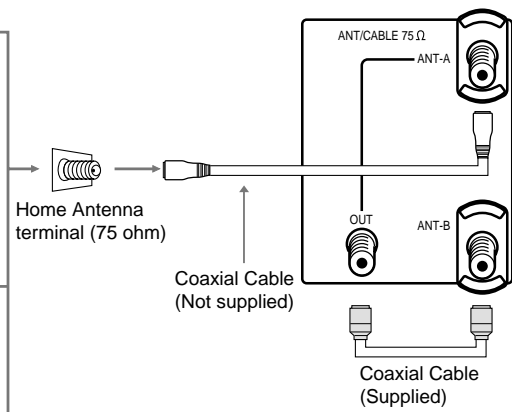

Main Unit

Front control section

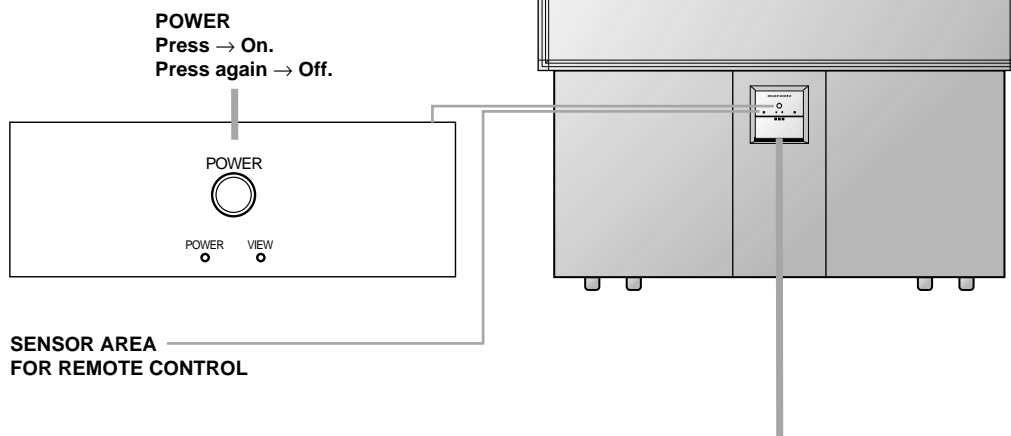

To open the cover

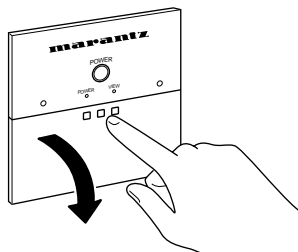

BEHIND THE COVER

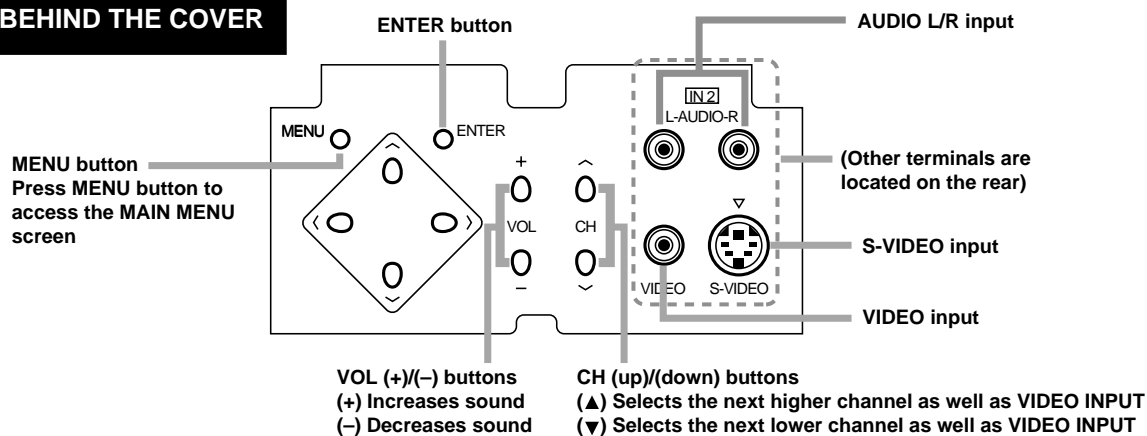

- If the Rear Projection TV is not used for a long period or during a blackout, turn OFF the POWER of the main unit to prevent the Rear Projection TV from malfunctioning.

Basic Remote Control Functions

This remote control can be used to operate the Rear Projection TV, a VCR, a DTV STB Decoder, a DVD Video Player and a Cable TV converter.

The buttons that can be used differ according to the device connected. Please refer to the next page for details.

INFRARED TRANSMITTER WINDOW

POWER

Press → On.
Press again → Off. (Stand-by)

PERSONAL PREFERENCE buttons

• Used to select any of four preset channels.
(See page 48 to setup.)

Cursor buttons

Used to move cursor on menu screen.

VOLUME UP/DOWN

(+) Increases sound.
(-) Decreases sound.

AV MODE

(See page 58.)

MUTE

Press → Mutes sound.
Press again → Restores sound.
• CLOSED CAPTION appears when sound is muted.

DIRECT CHANNEL ACCESS

Accesses any channel/inputs numbers by the keypad.
◉ button: DTV Decoder only

POP FUNCTION

You can watch two pictures at the same time. (See page 59.)

▼-CH-▲: Used to switch the channel for the sub-picture of the TWIN PICTURE screen.

INPUT: Used to select the source from INPUT terminals for the sub-picture of the TWIN PICTURE screen.

TWIN PICTURE: Splits the screen into two smaller equally sized screens, when pressed again, enlarges the left screen, and, if pressed again, exits the function.

SEARCH: Press to select the SEARCH screen mode.

SELECT: Selects the screen in TWIN PICTURE and Search screen modes.

FREEZE: When this button is pressed with the regular screen, will change to the TWIN PICTURE screen and the picture at the time the button was pressed will become the sub-picture, displayed as a frozen image.

SWAP: The left and right screens are interchanged with the TWIN PICTURE function.

CM SKIP: Use this function when you want to scan other channels during a commercial break.

LIGHT

When this button is pressed, some buttons on the remote control unit will light. The lighting will turn off if no operations are performed within about six seconds. This button is used for performing operations in dark places.

Remote control mode select buttons

Use to switch the remote control unit modes.

• By selecting one of the three mode select buttons, this remote control can be used to adjust common functions, such as channel selection, for that device.

ENTER button

MENU

Press → Accesses MAIN MENU.
Press again → Exits MAIN MENU.
(See page 17.)

CHANNEL UP/DOWN

(+) Selects the next higher channel.
(-) Selects the next lower channel.

INPUT

Press → Switches to external video INPUT 1 mode.
Press again → Switches to external video INPUT 2 mode.
Press 3 times → Switches to external video INPUT 3 mode.
Press 4 times → Switches to external video INPUT 4 mode.
Press 5 times → Switches to external video INPUT 5 mode.
Press 6 times → Switches back to the original TV mode.

ANT-A/B button

Press to switch between ANTENNA-A and ANTENNA-B when you wish to watch TV.

DISPLAY

Press → Displays receiving channel for four seconds.
Press again → Displays remaining time of SLEEP TIMER and VIEW TIMER for four seconds.

FLASHBACK

Returns to previously viewed channel.

ENT.

Used in some instances where a Cable Converter Box requires an "enter" command after selecting channels, when using the DIRECT ACCESS button. (See page 63.)

Q-SOUND

Controls the surround settings.
(See page 29.)

VIEW MODE

Select view size. (See page 57.)

VCR/DVD/DTV CONTROL

(See pages 63 ~ 67.)

DDFC

Used to select High-quality image.
(See page 58.)

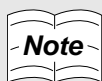

- The light button on the Remote Control glows in the dark. To use the glow-in-the-dark display on the remote control, place it under a fluorescent light or other lighting.
- The phosphorescent material contains no radioactive or toxic material, so it is safe to use.
- The degree of illumination will vary depending on the strength of lighting used.
- The degree of illumination will decrease with time and depending on the temperature.
- The time needed to charge the phosphorescent display will vary depending on the surrounding lighting.

Basic Remote Control Functions (Continued)

- Buttons which can be used with the Rear Projection TV, VCR, CATV, DVD player and DTV STB.

Name of button	Operation	TV/VCR		CATV/DVD		DTV STB
		TV	VCR	CATV	DVD	
POWER	Power ON/OFF	○		○		○
VOLUME-UP	Vol - UP	○		□		□
VOLUME-DOWN	Vol - DOWN	○		□		□
MUTE	Muting	○		□		□
0	} Selects Channel	○		○		○
1		○		○		○
2		○		○		○
3		○		○		○
4		○		○		○
5		○		○		○
6		○		○		○
7		○		○		○
8		○		○		○
9		○		○		○
100/ENT.		○		○		○
•						○
CHANNEL-UP		○		○		
CHANNEL-DOWN		○		○		
DISPLAY	Displays OSD	○		□		○
INPUT	Selects Input 1 to 5 or TV	○				
MENU	MENU	○			○	
CURSOR ↑	CURSOR ↑	○			○	
CURSOR ↓	CURSOR ↓	○			○	
CURSOR →	CURSOR →	○			○	
CURSOR ←	CURSOR ←	○			○	
ENTER	ENTER	○			○	
FLASHBACK	Returns to previously viewed channel	○		□		□
PERSONAL PREFERENCE A	PERSONAL PREFERENCE A	○		□		□
PERSONAL PREFERENCE B	PERSONAL PREFERENCE B	○		□		□
PERSONAL PREFERENCE C	PERSONAL PREFERENCE C	○		□		□
PERSONAL PREFERENCE D	PERSONAL PREFERENCE D	○		□		□
ANT A/B	Antenna A/B	○		□		□
TWIN PICTURE	TWIN PICTURE →POP→OFF	○		□		□
SELECT	Selects another screen	○		□		□
SUB CH-UP	} Selects sub screen channel	○		□		□
SUB CH-DOWN		○		□		□
SUB INPUT		○		□		□
SEARCH	Channel search by 3 small screens	○		□		□
FREEZE	Sub screen is frozen	○		□		□
SWAP	Interchanges between main and sub-screen	○		□		□
CM SKIP	Commercial skip	○		□		□
AV MODE	Selects picture set mode	○		□		□
VIEW MODE	Changes screen image	○		□		□
DDFC	Selects 540P/1080I/1080I (AUTO)	○		□		□
Q-SOUND	On/Off	○		□		□
POWER(VCR/DVD)	On/Off for VCR or DVD player		○		○	
REC	Rec for VCR only		○			
PLAY	Play		○		○	
REW	Rewind		○		○	
FF	Fast Forward		○		○	
STOP	Stop		○		○	
PAUSE	Pause		○		○	
TITLE	Displays title screen for DVD only				○	
SKIP←/VCR-ch up	Skips one channel/track up for VCR/DVD		○		○	
SKIP→/VCR-ch down	Skips one channel/track down for VCR/DVD		○		○	
DTV • STB	} Selects Remote control mode	○	○	○	○	○
TV • VCR		○	○	○	○	○
CATV • DVD		○	○	○	○	○
Light button	Lights buttons on the Remote control	○	○	○	○	○

□ : Buttons which can be used with the Rear Projection TV functions.

EZ SETUP on First Power On

When you turn on the Rear Projection TV for the first time, it automatically memorizes the broadcasting channels in your area.

Please perform the following steps before you press the POWER button.

- (1) Insert the batteries into the remote control. (See page 8.)
- (2) Connect the antenna cable to the Rear Projection TV. (See pages 9 ~ 12.)
- (3) Plug in the AC POWER cord to the wall outlet.

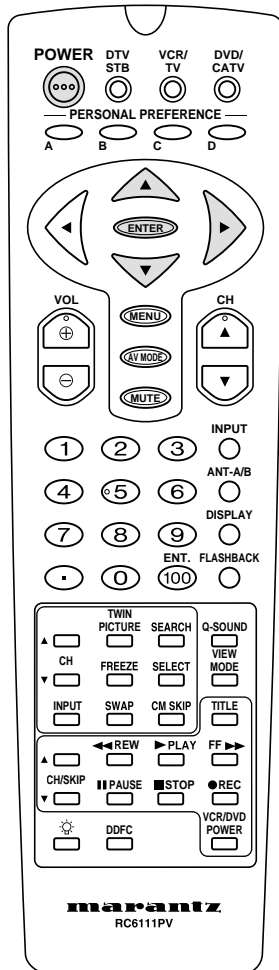

- 1** Press the **POWER** button on the Rear Projection TV or **POWER** on the Remote Control to turn on the Rear Projection TV.
 - The **SELECT LANGUAGE** screen is displayed.



- 2** Press **▲** or **▼** to select OSD language from "ENGLISH", "ESPAÑOL" (SPANISH) or "FRANCAIS" (FRENCH) and then press **ENTER**.
 - The **SELECT ANTENNA** screen is displayed.



- 3** Press **▲** or **▼** to select "ANT-A" or "ANT-B" and then press **ENTER**.
 - The **SELECT AIR/CABLE** screen is displayed.

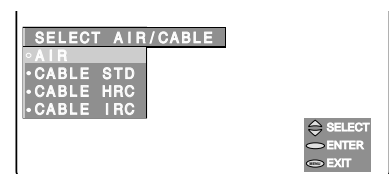

- 4** Press **▲** or **▼** to select "AIR", "CABLE STD", "CABLE HRC" or "CABLE IRC" and then press **ENTER**.
 - The **EZ SETUP** screen is displayed.
 - For detailed information, see page 45.



- 5** Press **ENTER**.
 - The tuner automatically searches for broadcasting and cable TV channels. (The CH No. automatically increases when a station is found.)



- Once EZ SETUP is completed, the lowest channel number memorized is displayed (e.g. 2 CH).

Note

- If EZ SETUP does not memorize all the channels in your area, please refer to page 45 for more information on manually memorizing the channels using CHANNEL SETUP.
- It may be difficult to preset channels when the broadcasting signals are weak, the channel cycle frequency is incorrect or frequency jamming occurs in the area. Please refer to pages 45 ~ 47 for more information on manually memorizing the channels using CHANNEL SETUP.
- If you exit the SELECT LANGUAGE mode, during step 1 or 2 of EZ SETUP during the "first power on" procedure, by pressing the **MENU** button, the next time you turn your Rear Projection TV on, the SELECT LANGUAGE menu appears on the screen.

Menu Functions

When you master these basic operations, the rest is simple.

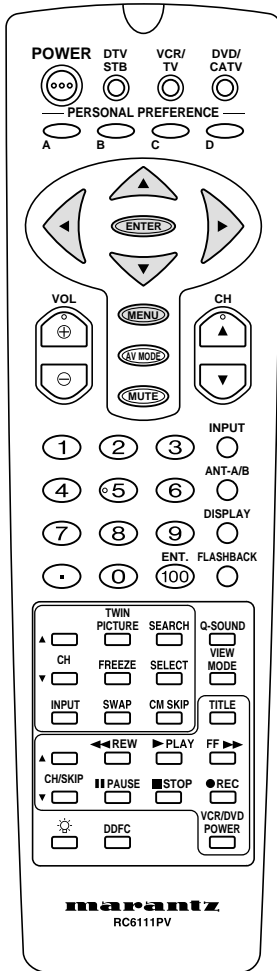

- 1** Press **MENU** to access MAIN MENU screen.

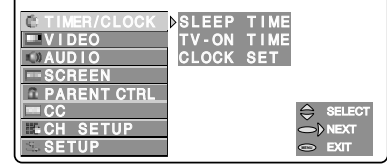

- 2** Press or to move the cursor to the desired function mode.
- moves the cursor up.
 - moves the cursor down.

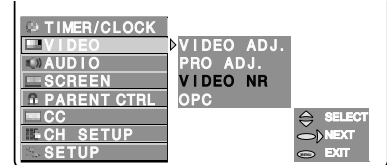

- 3** Press **ENTER** or to access the desired function mode.

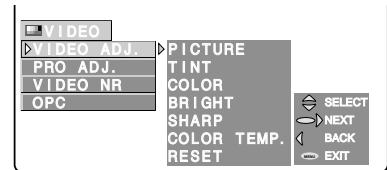

- 4** Press **MENU** to exit.

- You can return to a previous screen by pressing , when "BACK" is displayed on the right side of the MENU SCREEN.

Menu Functions (Continued)

■ MENU SUMMARY

1. TIMER/CLOCK

Using the TIMER/CLOCK mode, you can set the current time and the times for automatically switching on and off the power of the Rear Projection TV. See pages 19 ~ 23.

2. VIDEO

You can adjust the settings of VIDEO ADJ. (PICTURE, TINT, COLOR, BRIGHT, SHARP, COLOR TEMP.), PRO ADJ. (VMS, EVC, BLACK, VDE, GAMMA), VIDEO NR and OPC (optical control). See pages 25 ~ 27.

3. AUDIO

You can adjust the AUDIO ADJ. (BASS, TREBLE, BALANCE), Q SOUND, EQUISOUND, internal SPEAKER and MTS. See pages 28 ~ 30.

4. SCREEN

You can adjust the screen size. See pages 31 ~ 32.

5. PARENT CTRL (V-CHIP/VIEW TIMER)

- SECRET No.: You must set the password (SECRET No.) when using parent control functions.
- V-CHIP: This function allows you to restrict viewing of TV programs, to control TV usage based on FCC data and to prevent your children from watching violence or sexual scenes that may be harmful. See pages 33 ~ 42.
- VIEW TIMER: This function allows you to restrict TV viewing time and also to control TV usage. This function is for preventing your children from watching too much TV. See pages 43 ~ 44.

6. CC (CLOSED CAPTION)

Your Rear Projection TV is equipped with an internal Closed Caption decoder. "Closed Caption" is a system which allows you to view conversations, narration, and sound effects in TV programs and home videos as subtitles on your TV screen. See page 24.

7. CH SETUP (CHANNEL SETUP)

You can set AIR/CABLE, CH SEARCH, CH MEMORY, FAVORITES and UNIV. PLUS. See pages 45 ~ 49.

- AIR/CABLE: You can set the TV signal mode of AIR, CABLE STD, CABLE HRC and CABLE IRC. See page 45.
- CH SEARCH: You can save broadcast TV channels into memory. See page 46.
- CH MEMORY: You can add weak or additional channels, or erase unwanted channels from TV memory. See page 47.
- FAVORITES: By selecting the FAVORITES channels in advance you can select your favorite channels easily. See page 48.
- UNIV. PLUS: The VCR/DVD input mode will be selected when VCR/DVD player play starts. See page 49.

8. SETUP

You can set LANGUAGE, GRAY SCREEN, ENERGY SAVE, CONVER. ADJ., INPUT MODE, and CH/INPUT ID. See pages 50 ~ 56.

- LANGUAGE: Allows you to select between ENGLISH, SPANISH and FRENCH from the ON SCREEN DISPLAY. See page 50.
- GRAY SCREEN: Automatically turns the screen gray if a broadcast signal is not received. See page 51.
- ENERGY SAVE: This function controls the BRIGHTNESS level of CRT and reduces power consumption about 20 percent. See page 52.
- CONVER. ADJ.: You can use this mode to align (converge) the three picture beams of red, green and blue colors. See pages 53 ~ 54.
- INPUT MODE: You can select input signal in "Input 3 or 4". See page 55.
- CH/INPUT ID: This function can be used to input and display names (up to four letters) for channels and terminal inputs. See page 56.

TIMER/CLOCK

Using the TIMER/CLOCK mode, you can set the current time and the times for automatically switching on and off the power of the Rear Projection TV. The TIMER/CLOCK mode features the following three types:

- CLOCK SET mode..... Sets the current time.
- SLEEP TIME mode Sets the time for switching off the power.
- TV-ON TIME mode Sets the time for switching on the power.

CLOCK SET

SETTING THE TIME MANUALLY

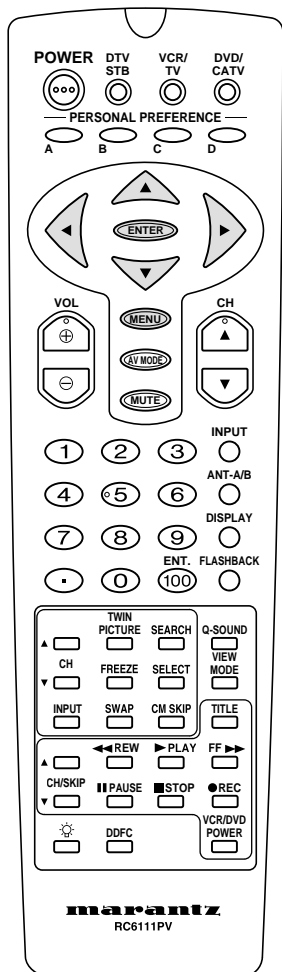

- 1** Press **MENU** to access MAIN MENU screen.

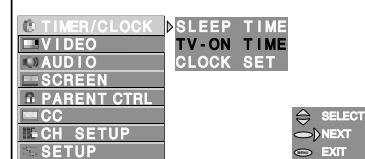

- 2** Press **ENTER** or **RIGHT** to access the TIMER/CLOCK mode.

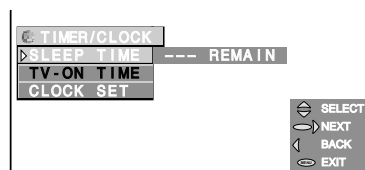

- 3** Press **UP** or **DOWN** to move the cursor to "CLOCK SET".



- 4** Press **ENTER** or **RIGHT** to access the CLOCK SET mode.



- 5** Use **UP** or **DOWN** to select "OFF" and then press **ENTER** to access the current time setting screen.



- If "ON" is selected, the time that is being sent from the broadcasting station will automatically be set (proceed to steps under "AUTO CLOCK SETTING" on page 20).

- 6** Input the current time by using **UP**, **DOWN**, **LEFT** or **RIGHT** then press **ENTER** to set.



- 7** Press **MENU** to exit.



TIMER/CLOCK (Continued)

AUTO CLOCK SETTING

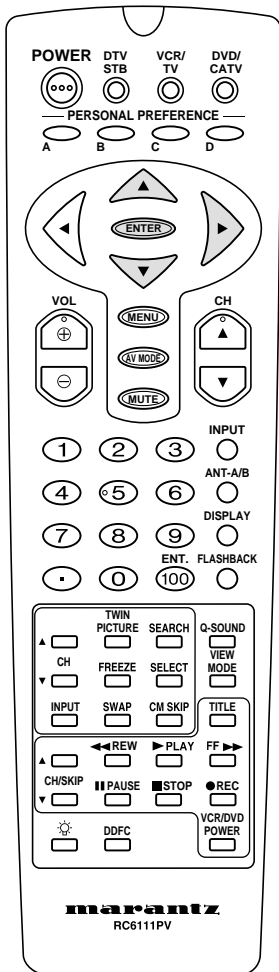

5

Use or to select "ON" and then press to display the XDS CH screen.



6

Press or , select "AUTO", "ANT-A" or "ANT-B" and then press .

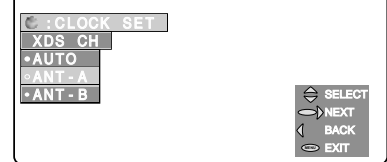

AUTO: XDS CH (This function will automatically register the time from the extended channel).

ANT-A: This function will automatically register the time from the channel that is connected to ANT-A.

ANT-B: This function will automatically register the time from the channel that is connected to ANT-B.

- It is recommended that the "AUTO" function is utilized.

7

If you decide to select "ANT-A" or "ANT-B", press and then, select the channel number by using , , and then press .

- The following message will appear after having selected the AUTO CLOCK function.



8

Turn the power off.

- The current time will be automatically registered.

Note

XDS is information provided by television programs which contains program rating data, program Start and End times, and Time of Day information. This XDS data determines whether or not parental block settings will effect the program or channel being viewed.

Note

- If you move to another area, set the channels (See page 46 for memorizing the channels) and the clock again according to the above procedure.
- In the event that the AUTO CLOCK has still not been set, even after turning off the power for a few hours, it could be that XDS signals are not being broadcast in your area. In this case, the clock should be set manually (See page 19 for manual clock settings.)
- If the antenna signal is weak, the AUTO CLOCK function may not operate properly.
- The AUTO CLOCK will not function if there is no XDS signal broadcast.
- Select a channel that carries XDS signals with the or button.

"AIR" → 2 3 4 68 69 2 ...

"CABLE-STD" → 2 3 4 124 125 2 ...

"CABLE-HRC", "CABLE-IRC" → 1 2 3 124 125 2 ...

TIMER/CLOCK (Continued)

SLEEP TIME

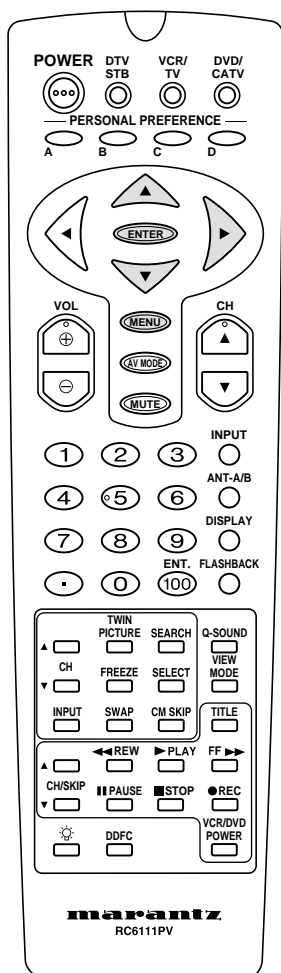

1 Press **MENU** to access MAIN MENU screen.

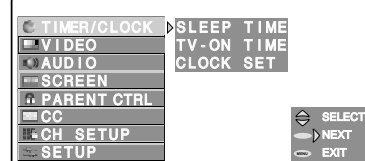

2 Press **ENTER** or **RIGHT** to access the TIMER/CLOCK mode.

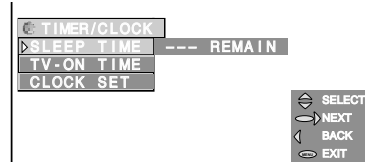

3 Press **ENTER** or **RIGHT** to access the SLEEP TIME mode.

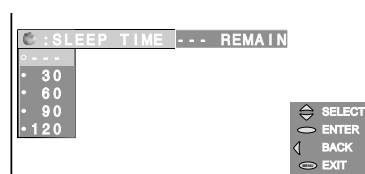

4 Press **UP** or **DOWN** to select a sleep time from "30", "60", "90" or "120" minutes.

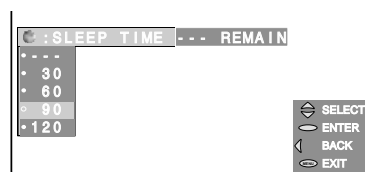

5 Press **ENTER** to confirm your selection.

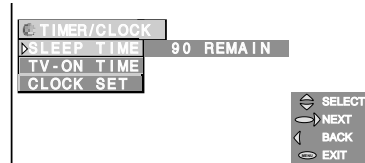

6 Press **MENU** to exit.



- To turn off the SLEEP TIME, repeat the above steps and select "--- REMAIN" during step 4.
- The amount of time remaining is displayed for four seconds at one-minute intervals for five minutes before the power is switched off.
- "0 REMAIN" is displayed for 10 seconds before the power is switched off.

TIMER/CLOCK (Continued)

TV-ON TIME

This function cannot be used if the current time has not been set. (See page 19.)

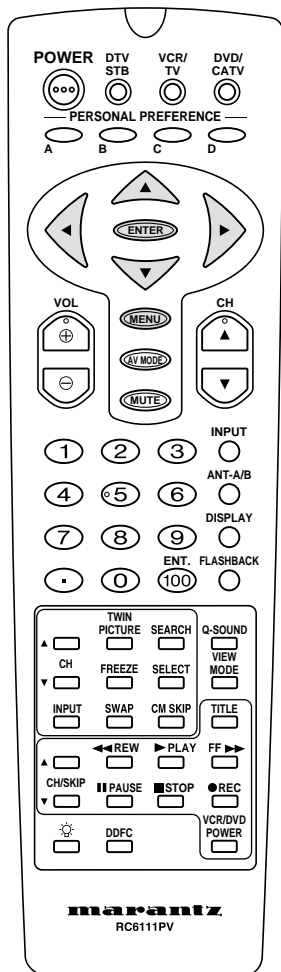

- 1** Press **MENU** to access MAIN MENU screen.

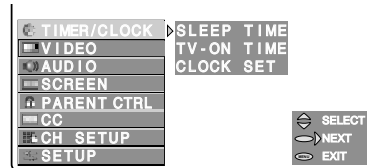

- 2** Press **ENTER** or **RIGHT** to access the TIMER/CLOCK mode.

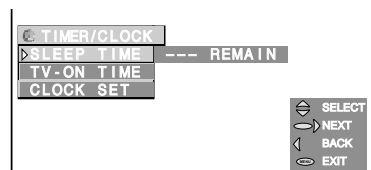

- 3** Press **UP** or **DOWN** to select "TV-ON TIME" and then press **ENTER** or **RIGHT** to display the TV-ON TIME screen.

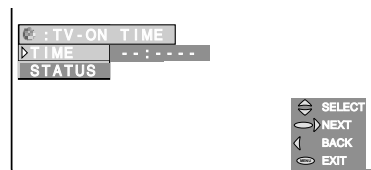

- 4** Use **UP** or **DOWN** to select "TIME" and then press **ENTER** or **RIGHT**.

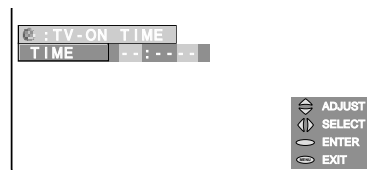

- 5** Specify the time when you want the Rear Projection TV to turn on by pressing **UP**, **DOWN**, **LEFT**, and **RIGHT** and then press **ENTER**.

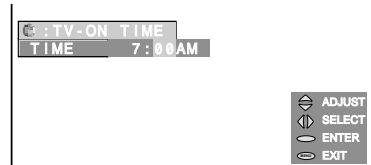



- 6** Press **DOWN** to select "STATUS" and then press **ENTER**.



TIMER/CLOCK (Continued)

7

Press  or  to select "ON" or "OFF".

- ON: Activates the TV-ON TIMER.
- OFF: Deactivates the TV-ON TIMER.



8

Press  to exit.

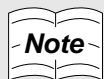

Note

- Be aware that if the time is not set, the TV-ON TIME function cannot be used. Prior to accessing the above function, remember to set the current time.
- When the STATUS of TV-ON TIME is ON, the VIEW TIMER LED will light up.
- When the STATUS of TV-ON TIME is ON, and a blackout occurs, the VIEW TIMER LED will start to blink. (This is to inform that there is the possibility that the TIMER is not or was not active during the blackout.)
To stop the LED from blinking, reset the current time, and set the STATUS to OFF.
- Once the TV-ON TIME becomes activated, the STATUS automatically goes back to OFF. (The time the TV was set to turn on will not be cleared).



CC Closed Caption

How to set Closed Caption

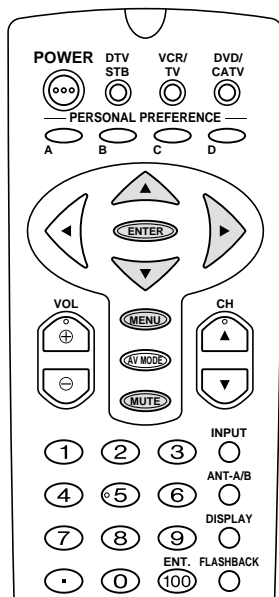
- Your Rear Projection TV is equipped with an internal Closed Caption decoder. "Closed Caption" is a system which allows you to view conversations, narration, and sound effects in TV programs and home videos as subtitles on your Rear Projection TV screen.
- Not all programs and videos offer closed caption. Please confirm whether the Closed Caption system applies to the broadcast program or the video tape you are watching. (The  mark signifies compatibility with the Closed Caption system.)
- Closed Caption broadcasts can be viewed in two modes: CAPTION and TEXT. For each mode, two channels are available, CH1 and CH2.
- The CAPTION mode displays subtitles for dialogue in TV programs while allowing clear view of the picture.
- The TEXT mode superimposes other information (such as TV program schedules, weather forecasts, etc.) that is independent of the TV programs, in the picture.





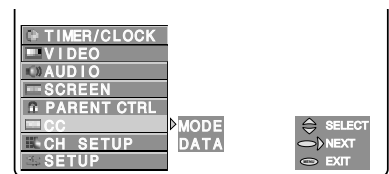

1 Press **MENU** to access MAIN MENU screen.

2 Press  or  to move the cursor to "CC" (Closed Caption).





3 Press **ENTER** or  to access the CC (Closed Caption) setting mode.

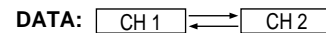
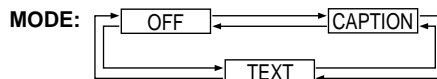
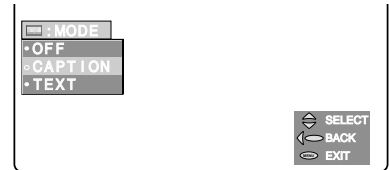

4 Press  or  to move the  mark to either "MODE" or "DATA" (e.g. "MODE") and then press **ENTER** or .



5 Press  or  to move the cursor to an item you want to set.

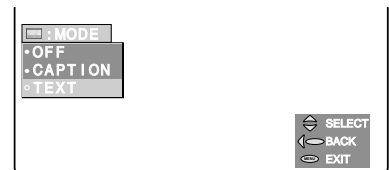

6 Press **MENU** to exit.

Note

- If a broadcast has Closed Caption and **MUTE** is pressed, the Rear Projection TV enters CAPTION mode automatically. Pressing **MUTE** again will return the Rear Projection TV to its previous condition.
- Closed Caption may malfunction (white blocks, strange characters, etc.) if signal conditions are poor or if there are problems at the broadcast source. This does not necessarily indicate a problem with your Rear Projection TV.
- If any button is pressed to call up the ON SCREEN DISPLAY while viewing a Closed Caption broadcast, the closed captions will disappear momentarily.
- When viewing in TEXT mode, if no TEXT broadcast is being received, for some programs the screen may become dark and blank. Should this occur, set the Closed Caption mode to "OFF".

Video Adjust

Description of Adjustment Items

Selected item	◀ button	▶ button
PICTURE	To decrease contrast	To increase contrast
TINT	To make skin tones purplish	To make skin tones greenish
COLOR	To decrease color intensity	To increase color intensity
BRIGHT	To decrease brightness	To increase brightness
SHARP	To decrease sharpness	To increase sharpness
COLOR TEMP.	Allows hue adjustment of the entire screen (Low produces the reddest hue while High produces the bluest hue). (LOW-M.L. (Mid Low)-M.H. (Mid High)-HIGH)	
RESET	To return all adjustments to the factory preset levels	

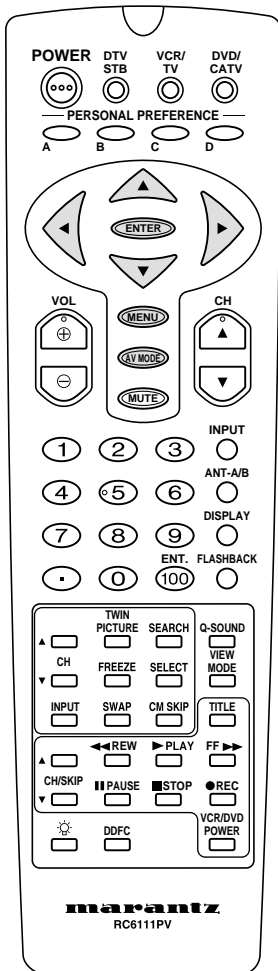

- 1** Press **MENU** to access MAIN MENU screen and then use **▲** or **▼** to select "VIDEO".

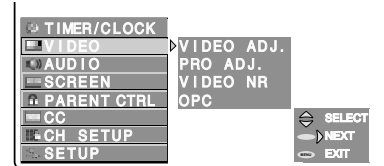

- 2** Press **ENTER** or **▶** to access the VIDEO mode.

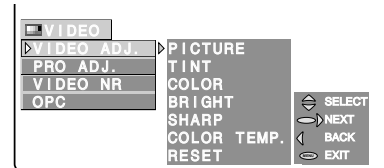

- 3** Press **▲** or **▼** to move the "▶" mark to "VIDEO ADJ." and then press **ENTER** or **▶** to access the VIDEO ADJ. mode.

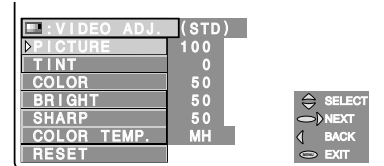

- 4** Press **▲** or **▼** to move the "▶" mark to an item (e.g. "COLOR") you want to adjust.

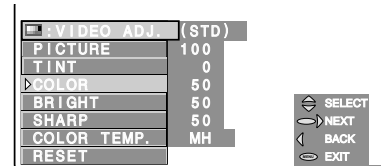

- 5** Press **ENTER** or **▶** to access the COLOR adjust mode.



Video Adjust (Continued)

- 6** Press or to adjust "COLOR" and press .



- 7** Press to exit.
 • To set other VIDEO adjustments, repeat steps 4 to 6.



Note • Pressing changes the setting applied to the currently viewed image in the following sequence (See page 59.):
 STD → SOFT → USER → DYNAMIC → STD
 For example, the "SOFT" setting can be used conveniently with the VCR and the "DYNAMIC" setting can be used with the DVD player.

PRO Adjust

Description of Adjustment Items

Selected item	Adjustment	Variable value
VMS (Velocity Modulation Scanning)	This circuit modifies the frequency or speed of scanning.	OFF-LOW-MID-HIGH
EVC (Enhanced Video Circuit)	Switching this on enhances the detail of video and color.	ON-OFF
BLACK	Allows adjustment of the degree of dark portions of the picture to change the sense of depth.	ON-OFF
VDE (Vertical Detail Enhancement)	Allows contour adjustment in the vertical direction.	ON-OFF
GAMMA	Allows the dark portions of the picture to be corrected for easier viewing.	OFF-SOFT-MID-HARD
RESET	To return all adjustments to the factory preset levels.	

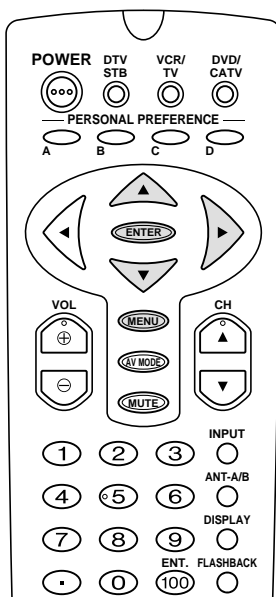

- 1** Press to access MAIN MENU screen and then use or to select "VIDEO".

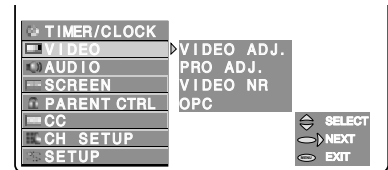



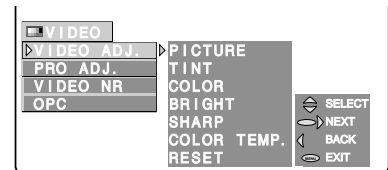

- 2** Press or to access the VIDEO mode.

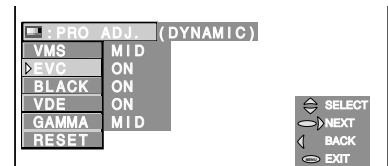





- 3** Press or to move the "▶" mark to "PRO ADJ." mode, and then press or to access the PRO ADJ. mode.

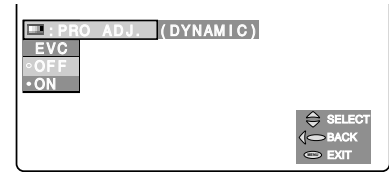

Video Adjust (Continued)



- 4** Press  or  to move the "▶" mark to an item (e.g. "EVC") you want to adjust, then press  or  to access the EVC mode.



- 5** Press  or  to select "ON" or "OFF", and then press .

- 6** Press  to exit.
- To set other PRO adjustments, repeat steps 4 to 5.

VIDEO NR

This produces a sharper picture when video images input from the S-VIDEO or VIDEO input terminal appear gritty. This function is only available when using VIDEO IN 1, 2, 3 or 4/S-VIDEO IN 1, 2 or 3. You can choose a setting from "OFF", "SOFT" or "HARD" by using  or  and  to set VIDEO NR adjustment.

OPC (optical control)

This function automatically adjusts the screen brightness, by sensing the brightness of the area where the Rear Projection TV is located. It is activated by setting to "ON" the OPC item in the VIDEO ADJ. menu.

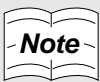

- Set this function to "OFF" if it is not to be used.

Audio Adjust

Description of Adjustment Items

Selected item	◀ button	▶ button
BASS	To decrease bass response.	To increase bass response.
TREBLE	To decrease treble response.	To increase treble response.
BALANCE	To emphasize the left speaker's volume.	To emphasize the right speaker's volume.
RESET	To return all adjustments to the factory preset levels.	

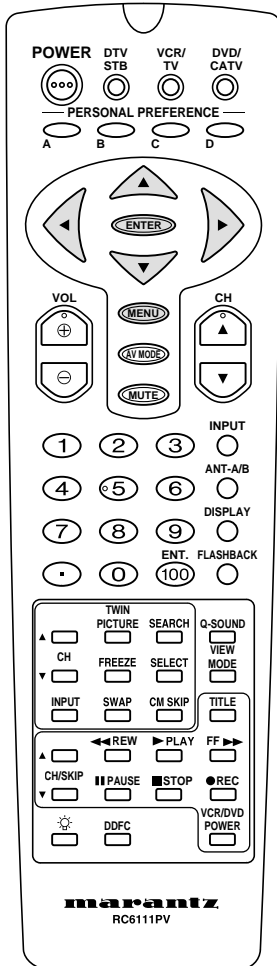

- 1** Press **MENU** to access MAIN MENU screen and then use **▲** or **▼** to select "AUDIO".

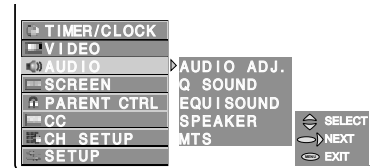

- 2** Press **ENTER** or **▶** to access the AUDIO mode.

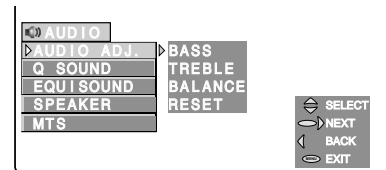

- 3** Press **ENTER** or **▶** to access the AUDIO ADJ. mode.

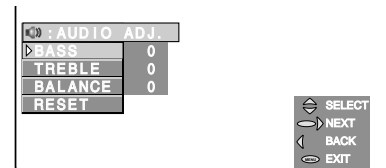

- 4** Press **▲** or **▼** to move the "▶" mark to an item (e.g. "BASS") and then press **ENTER** or **▶** to access the BASS Adjust mode.



- 5** Press **◀** or **▶** to adjust "BASS", and then press **ENTER**.

- 6** Press **MENU** to exit.
 • To set other AUDIO adjustments, repeat steps 4 to 5.



Audio Adjust (Continued)

Other Audio Settings

Q SOUND

This function simulates surround sound.

EQUISOUND

This function keeps the volume level constant during program changes and commercial breaks.

INTERNAL SPEAKER SWITCH (SPEAKER)

This function turns the Rear Projection TV's internal speakers "ON" or "OFF" when listening to sound from external speakers and using the AUDIO OUTPUT JACKS. In addition, it is possible to use the built-in speakers as the speakers for an external device (CENTER-IN). (See page 70.)

- The setting sequence is described on the right side.

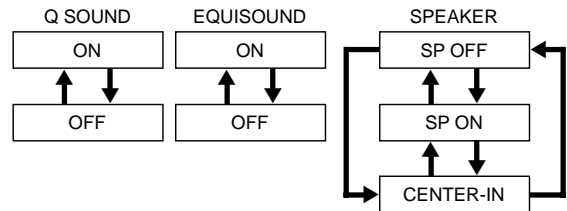

MTS.....See page 30.

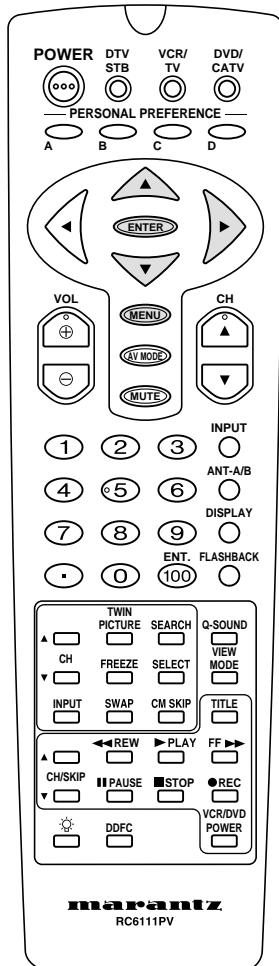

- 1 Press **MENU** to access MAIN MENU screen and then use or to select "AUDIO".

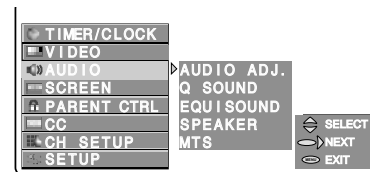

- 2 Press **ENTER** or to access the AUDIO mode.

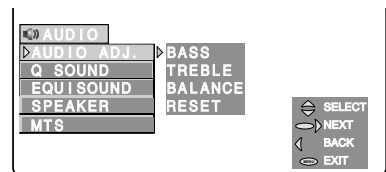

- 3 Press or to move the "▶" mark to an item (e.g. "EQUISOUND") you want to adjust.

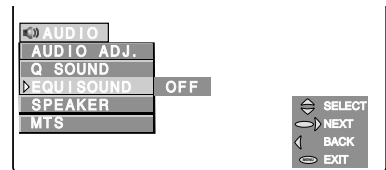

- 4 Press **ENTER** or to access the EQUISOUND mode.



- 5 Press or to turn the EQUISOUND setting "ON" or "OFF" and then press **ENTER**.



Note

- The Q SOUND works effectively in STEREO mode. In MONO (monaural) mode, the Q SOUND does not have a surround effect.

- 6 Press **MENU** to exit.
 - To set other AUDIO adjustments, repeat steps 3 to 5.



Audio Adjust (Continued)

MTS/SAP Select mode

Switching MTS mode and displaying the broadcasting mode

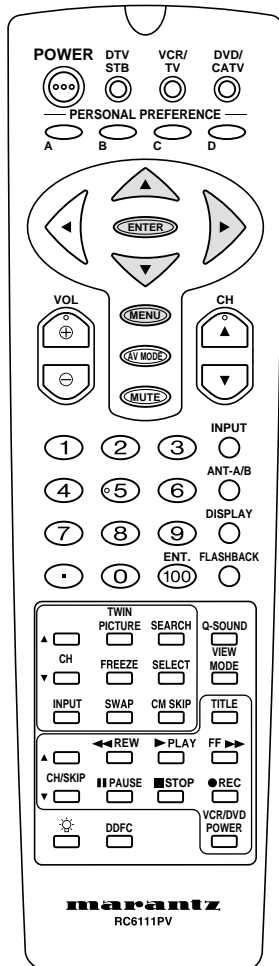

1 Press **MENU** to access MAIN MENU screen and then use or to select "AUDIO".

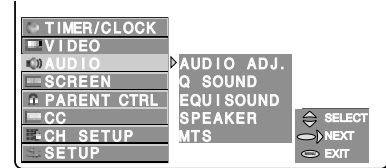

2 Press **ENTER** or to access the AUDIO mode.

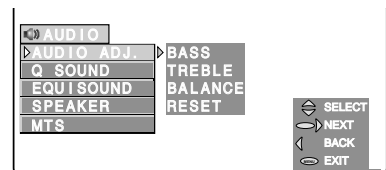

3 Press or to move the cursor to "MTS" and then press **ENTER** or to access the MTS mode.



4 Press or to select your desired setting, and then press **ENTER**.

- For detailed information on the settings of "STEREO", "SAP" and "MONO", see the description below.



5 Press **MENU** to exit.

- To set other AUDIO adjustments, repeat steps 3 to 4.

An on-screen graphic appears when receiving STEREO broadcasts.

You can enjoy Hi-Fi stereo sound or SAP broadcasts where available.

- Stereo broadcasts
Live broadcasts of sports events, shows, concerts, etc. can be received in dynamic stereo sound.
- SAP broadcasts
Television broadcasts can be received with either MAIN or SAP sound.
MAIN sound: The normal program soundtrack. (Monaural or stereo where available.)
SAP sound: Second language, supplementary commentaries, etc. (SAP sound is monaural.)

If stereo sound is difficult to hear:

- You can obtain clearer sound by manually switching to fixed monaural mode.

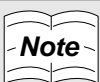

- Once MONO mode is selected, the TV sound remains monaural even if the Rear Projection TV receives a stereo broadcast. You must switch the mode back to STEREO if you want to hear stereo sound again.
- Selecting MTS while in the INPUT mode does not change the type of sound; in this case, sound is determined by the video source.



Screen Adjust

You can adjust the vertical or horizontal screen size and screen position in this mode. (This mode can be used only when the picture is in LETTERBOX, PANORAMIC, or ANAMORPHIC (vertical only) view mode. (See page 57.) You can adjust the items by following the tables below.

Screen adjustment items vary depending on Screen size mode.

	INPUT	Image Format
△	RGB	480P
○	Component	480I, 480P
▽	Video, S-Video	Composite, Y/C

Screen size mode	POSITION (V)	SIZE (V)	POSITION (H)	SIZE (H)
4:3	–	–	–	–
PANORAMIC	▽, ○, △	▽, ○, △	△	△
LETTERBOX	▽, ○, △	▽, ○, △	△	△
ANAMORPHIC	–	▽, ○, △	△	△

	INPUT	Image Format
△	RGB	540P, 720P, 1080I
○	Component	720P, 1080I

Screen size mode	POSITION (V)	SIZE (V)	POSITION (H)	SIZE (H)
ANAMORPHIC	–	–	△	–
ZOOM	○, △	○, △	△	△

Description of Adjustment Items

POSITION (V)	△ moves the on-screen image upward ▽ moves the on-screen image downward
SIZE (V)	△ makes the on-screen image larger vertically ▽ makes the on-screen image smaller vertically
POSITION (H)	◀ moves the on-screen image leftward ▶ moves the on-screen image rightward
SIZE (H)	◀ makes the on-screen image smaller horizontally ▶ makes the on-screen image larger horizontally
RESET	To return all adjustments to the factory preset levels

Screen Adjust (Continued)

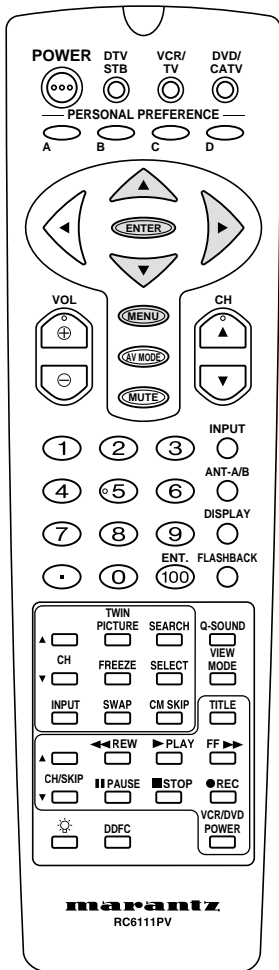

1 Press **MENU** to access MAIN MENU screen.

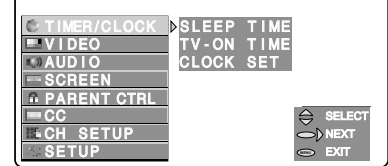

2 Press **▲** or **▼** to move the cursor to "SCREEN".

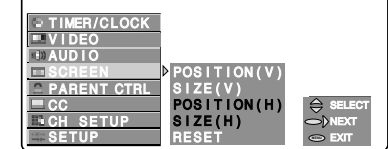

3 Press **ENTER** or **▶** to access the Screen Adjust mode.

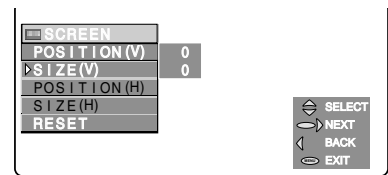

4 Use **▲** or **▼** to select the item you want to adjust (e.g. "POSITION (V)"), then press

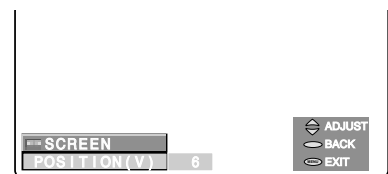
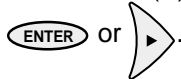

5 Press **▲** or **▼** to adjust vertical position, then press **ENTER**.

6 Press **MENU** to exit.



Parent Control (V-CHIP operation)

- This function allows you to restrict TV programs and also allows you to control TV usage based on FCC data. This function is for preventing your children from watching programs of mature nature.
- Restriction of TV programs is based on information about the program's MPAA rating and the TV Parental Guidelines. MPAA is restricted by age. TV Parental Guidelines are restricted by age and contents.
- Since a TV program may use either the MPAA rating or the TV Guidelines, you should adjust both for complete control.
- The FREEZE and SEARCH functions do not work if the V-CHIP status is set to "ON". (See page 60 for FREEZE screen and page 61 for SEARCH screen.)

[1] MPAA RATING

RATING		
age base	G	GENERAL AUDIENCES. All ages admitted.
	PG	PARENTAL GUIDANCE SUGGESTED. Some material may not be suitable for children.
	PG-13	PARENTS STRONGLY CAUTIONED. Some material may be inappropriate for children under 13.
	R	RESTRICTED. Under 17 requires accompanying parent or adult guardian.
	NC-17	NO ONE 17 AND UNDER ADMITTED.
	X	X Rating is an older rating that is unified with NC-17 but may be encoded in older movies.

• MPAA RATING (Example)

Example 1.

"PG-13" in the age-based RATING is blocked. This will automatically block the high ratings "R", "NC-17" and "X" also.

1. User setting

G	----
PG	----
PG-13	BLOCK
R	BLOCK
NC-17	BLOCK
X	BLOCK

2. Block table

G	not to block
PG	not to block
PG-13	Select block
R	auto-block
NC-17	auto-block
X	auto-block

Example 2.

"R" in the age-based RATING is blocked. This will automatically block the high rating "NC-17" and "X" also.

1. User setting

G	----
PG	----
PG-13	----
R	BLOCK
NC-17	BLOCK
X	BLOCK

2. Block table

G	not to block
PG	not to block
PG-13	not to block
R	Select block
NC-17	auto-block
X	auto-block



- MPAA RATING only uses age-based ratings.

[2] TV PARENTAL GUIDELINES (TV RATINGS)

RATING	← content base →					
	Age	FV (Fantasy Violence)	V (Violence)	S (Sexual Situation)	L (Adult Language)	D (Sexually Suggestive Dialogue)
↑ age base	TV-Y (All children)	X				
	TV-Y7 (Direct to Older Children)	X	X			
	TV-G (General Audience)	X				
	TV-PG (Parental Guidance Suggested)	X		X	X	X
	TV-14 (Parents Strongly Cautioned)	X		X	X	X
↓ age base	TV-MA (Mature Audience Only)	X		X	X	

X: Content Rating can be set.

[3] ADDITIONAL MODE

Besides the above "MPAA RATINGS" and "TV PARENTAL GUIDELINES", new ratings systems data can be downloaded when they become available. (See page 38.)



How to Set V-CHIP

Parent Control First Setting

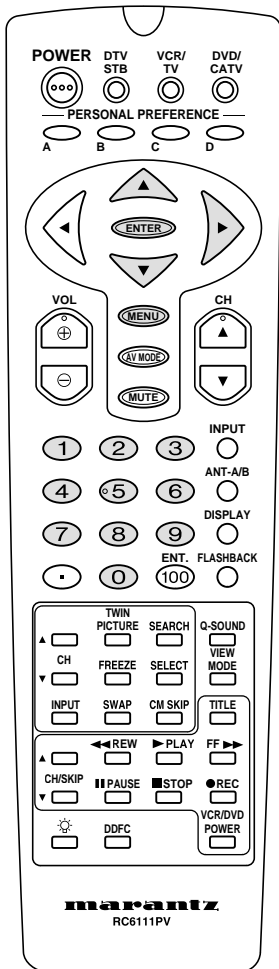

1 Press **MENU** to access MAIN MENU screen.

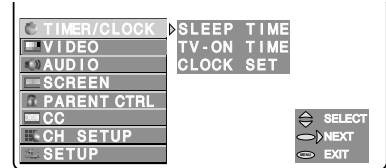

2 Press **UP** or **DOWN** to move the cursor to "PARENT CTRL".

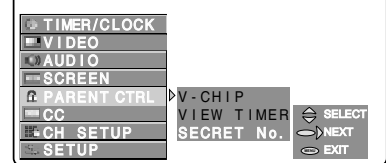

3 Press **ENTER** or **RIGHT** to access the SECRET number select mode,

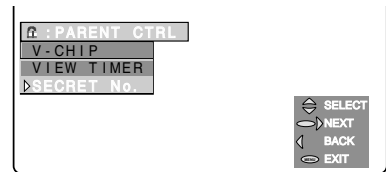

4 Press **ENTER** or **RIGHT** to access the NEW SECRET number input mode.

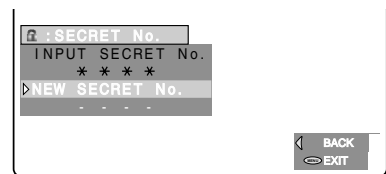

5 Enter the 4-digit SECRET number using **DIRECT ACCESS** (0 ~ 9) to access the PARENT CTRL mode.

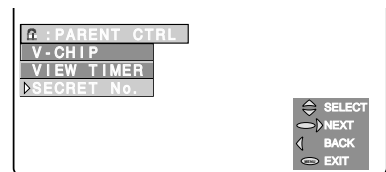

- The V-CHIP and VIEW TIMER mode can be adjusted when the steps 1 ~ 5 are finished.



How to Set V-CHIP (Continued)

MPAA Rating

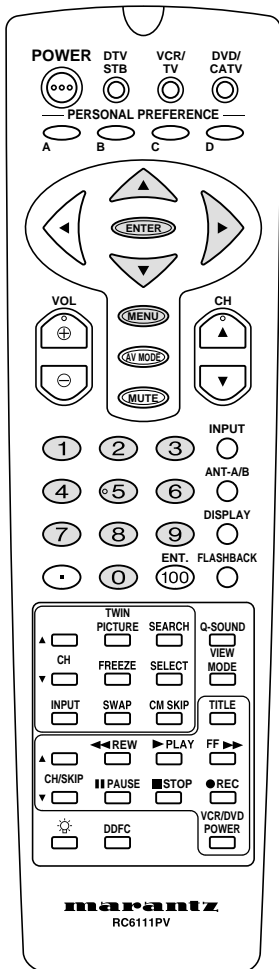

1 Press **MENU** to access MAIN MENU screen.

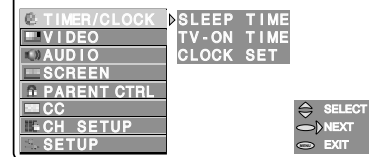

2 Press **UP** or **DOWN** to move the cursor to "PARENT CTRL", then press **ENTER** or **RIGHT** to access the PARENT CTRL mode.

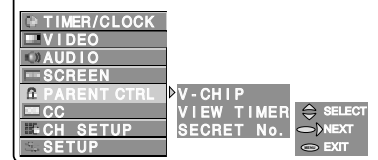

3 The message "INPUT SECRET No." will appear if you have already set the secret number, input your secret number by using **DIRECT ACCESS** (0 ~ 9). (See steps 2, 3 on page 41.)

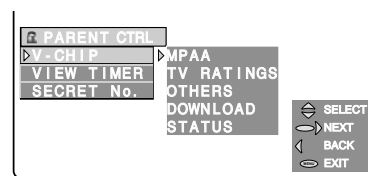

4 Press **ENTER** or **RIGHT** to access the V-CHIP mode.

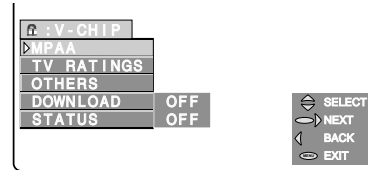

5 Press **ENTER** or **RIGHT** to access the MPAA rating mode, then press **UP** or **DOWN** to move the "▶" mark to "PG".

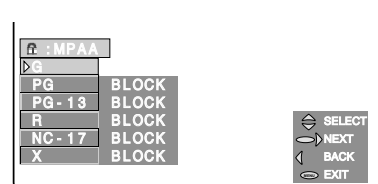

6 Press **ENTER** or **RIGHT** and then use **UP** or **DOWN** to move the cursor to "BLOCK".

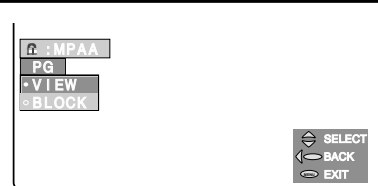

7 Press **ENTER** to access the BLOCK mode.

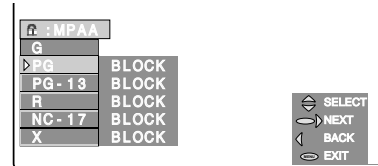

8 Press **MENU** to exit.

Note

- If you set "PG" to BLOCK, "PG-13", "R", "NC-17" and "X" are automatically blocked.
- If you set "G" to BLOCK, all RATINGS are automatically blocked.
- If you set "X" to BLOCK, "G", "PG", "PG-13", "R" and "NC-17" are not blocked.



How to Set V-CHIP (Continued)

TV Rating

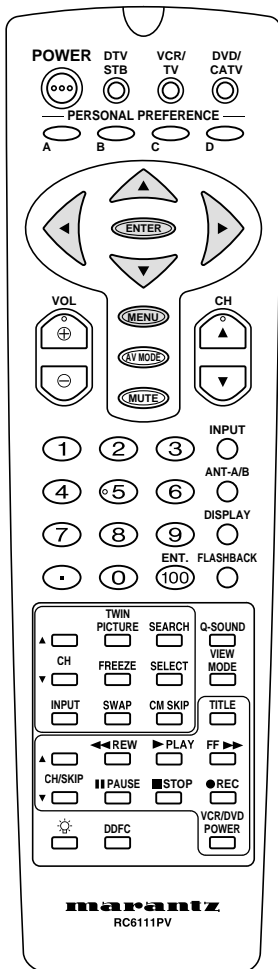

1 Repeat steps 1 to 4 of MPA Rating on page 36.

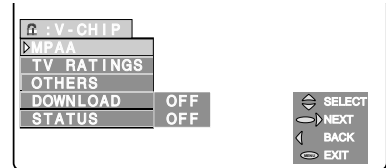

2 Press or to move the "▶" mark to "TV RATINGS", and then press or .

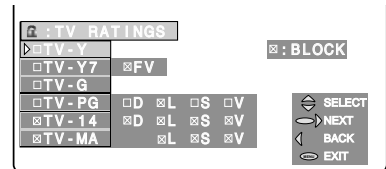

3 Press or to move the "▶" mark to "TV-Y7", and then press or .

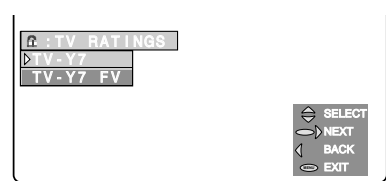

4 Press or to move the "▶" mark to "TV-Y7", then press or .



5 Press or to move the cursor to "VIEW" or "BLOCK" (e.g. "BLOCK").



6 Press to access the BLOCK mode.

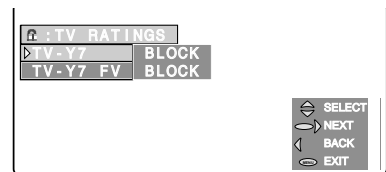

7 Press to exit.

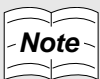

- If you set "TV-Y7" to BLOCK, "TV-G", "TV-PG", "TV-14" and "TV-MA" are automatically blocked "D", "L", "S", "V" and "FV".
- You can return to a previous screen by pressing to select "BACK" before pressing to exit.



How to Set V-CHIP (Continued)

Additional mode

There may be new or additional rating systems in the future. In that case, please set up as follows and the new rating system will be set up automatically.

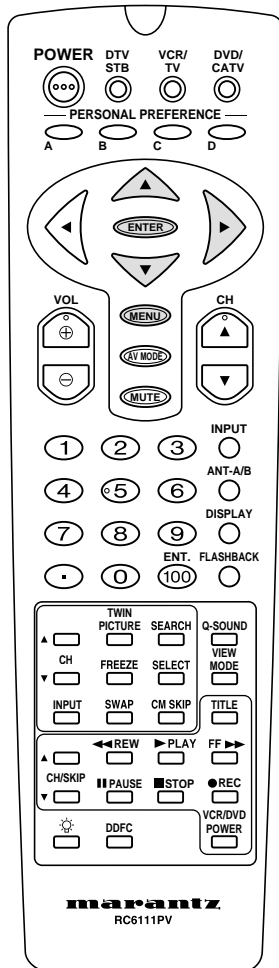

- 1 Repeat steps 1 to 4 of MPAA Rating on page 36 to access V-CHIP select mode.

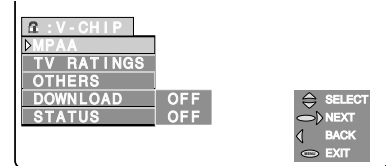

- 2 Press or to select "DOWNLOAD".

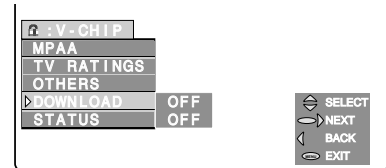

- 3 Press or and then use or to select "ON".



- 4 Press to exit.

■ DOWNLOAD V-CHIP DATA

- 1 If you watch the program with "New Rating System Data", DOWNLOAD screen will be displayed.

PLEASE WAIT
NOW DOWNLOADING
V-CHIP DATA

- 2 DOWNLOAD screen will disappear once the download is complete.



- DOWNLOAD will not start if you do not watch the program with New Rating System Data.



How to Set V-CHIP (Continued)

■ Additional mode (Example)

Before performing the procedure below, download V-CHIP data correctly. (See page 38.)

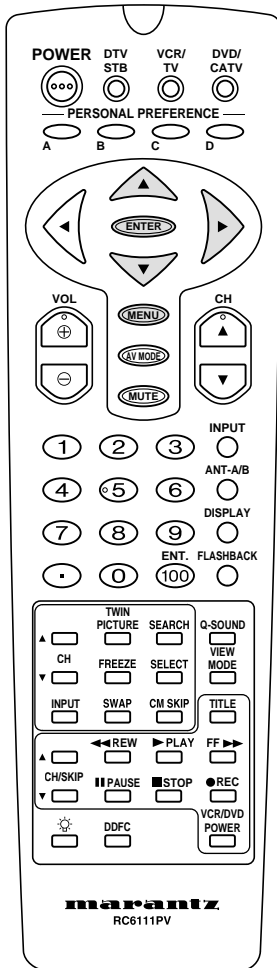

1 Repeat steps 1 to 4 of MPAA Rating on page 36.

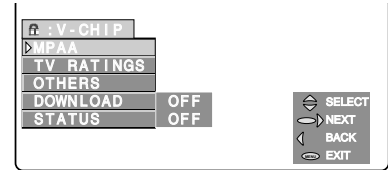

2 Press or to select "OTHERS", then press or .

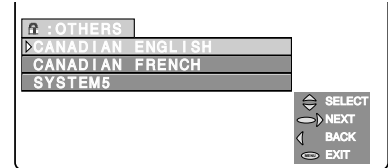

3 Use or to move the cursor to an item (e.g. "CANADIAN ENGLISH") you want to set and then press or .

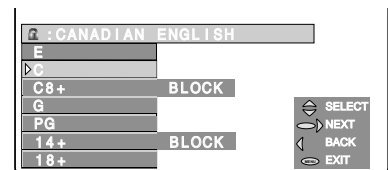

4 Press or to move the cursor to select an item you want to set (e.g. "C"), and press or .

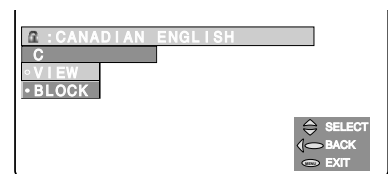

5 Press or to select "VIEW" or "BLOCK" from each RATING, and press .

• Repeat steps 3 to 5 for other settings you want to adjust.

6 Press to exit.



• Includes two types (English mode, French mode), so you are able to download four kinds of modes in Additional mode.



How to Set V-CHIP (Continued)

Turn on V-CHIP Block

To operate V-CHIP BLOCK

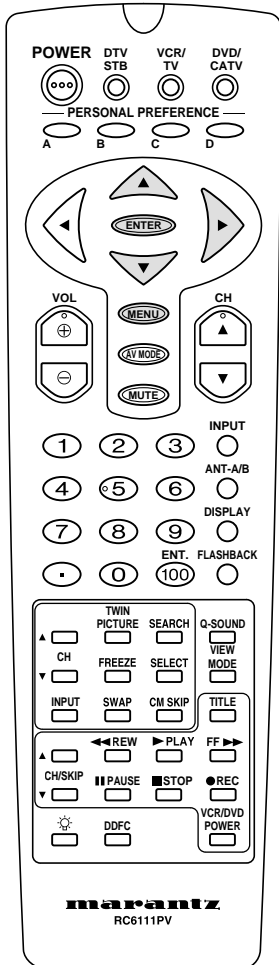

1

Repeat steps 1 to 4 of MPAA Rating on page 36.

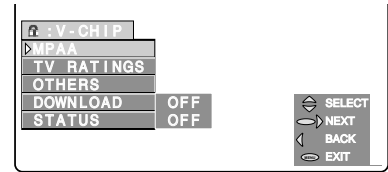

2

Press or to move the "▶" mark to "STATUS".

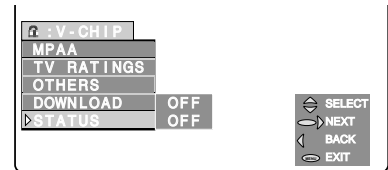

3

Press or and then use or to select "ON".

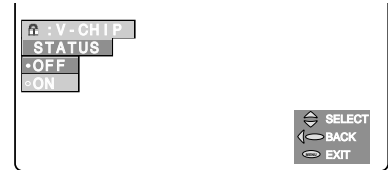

4

Press to exit.



How to Set V-CHIP (Continued)

■ To cancel the V-CHIP BLOCK screen while V-CHIP BLOCK is activated

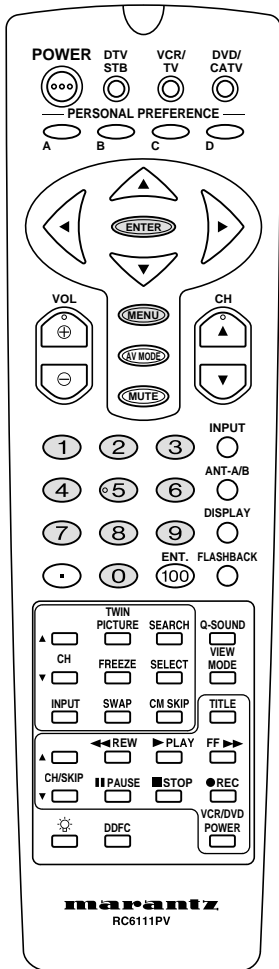

1

"V-CHIP BLOCK IS ACTIVATED" will be displayed if you watch a program with Program Rating data matching those you have configured.

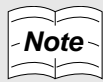
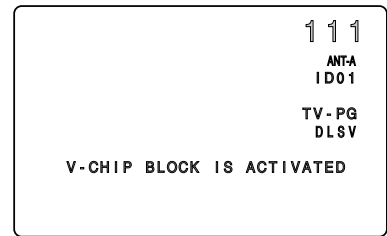

• "V-CHIP BLOCK IS ACTIVATED" will not be displayed if STATUS is not configured to "ON" (See page 40.).

2

Press **ENTER**.
• "INPUT SECRET No." will be displayed.



3

Enter the 4-digit SECRET No. using **DIRECT ACCESS** (0 ~ 9).
• V-CHIP BLOCK temporarily will be canceled.

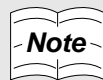

• If the wrong SECRET number is entered, a warning screen appears ("SECRET No. IS INCORRECT"), then "INPUT SECRET No." will be displayed again. Input the correct SECRET number again in this case.

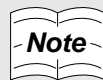

• If you forget "SECRET No." in step 3, press **MENU** to repeat steps 1 to 2 of MPA Rating on page 36, then "INPUT SECRET No." will be displayed again. Press and hold both **ENTER** and **MENU** on the front panel of the Rear Projection TV simultaneously for about five seconds until the message "INPUT SECRET No." disappears, then PARENT CTRL mode will be displayed.
• If you turn on the Rear Projection TV's power, then V-CHIP BLOCK will be turned on again.



How to Set V-CHIP (Continued)

■ To change the V-CHIP BLOCK setting (Secret No. is registered.)

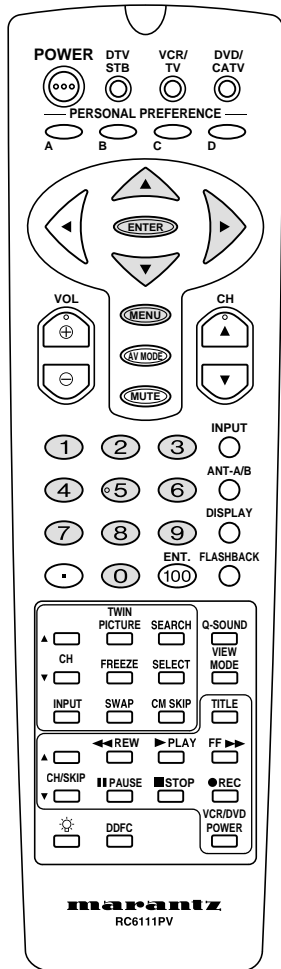

1

Repeat steps 1 to 2 of MPAA Rating on page 36.
• "INPUT SECRET No." will be displayed.

2

Enter the 4-digit SECRET No. by using **DIRECT ACCESS** (0 ~ 9).
• The V-CHIP select mode will be displayed.

3

Repeat the configuration of the V-CHIP BLOCK on the page 40.

■ To cancel the V-CHIP setting while V-CHIP BLOCK is set

In case you forget the Secret No., you can cancel the setting of the V-CHIP setting using the method as outlined below.

1

Repeat steps 1 to 2 of MPAA Rating on page 36, then "INPUT SECRET No." appears.

2

Press and hold both **ENTER** and **MENU** on the front panel of the Rear Projection TV simultaneously for about five seconds until the message "INPUT SECRET No." disappears.

3

Press **MENU** to exit.
• The setting of the Secret No. is canceled and the STATUS of the V-CHIP changes from ON to OFF.

BEHIND THE COVER

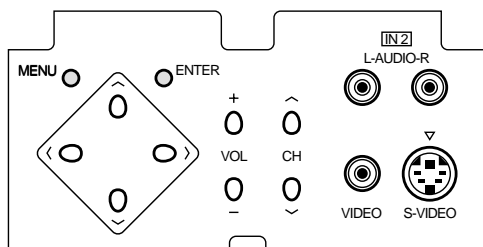

On the front panel of Rear Projection TV



Parent Control (VIEW TIMER)

VIEW TIMER

This function allows you to restrict Rear Projection TV viewing times and also to control Rear Projection TV usage. This function is for preventing your children from watching too much Rear Projection TV.

- It is recommended that the "OFF TIME" function and the "VIEWING TIME" function are both set under the "VIEW TIMER" function.

The VIEWING TIME: sets the duration of the viewing time of the Rear Projection TV.

The OFF TIME: sets the duration the Rear Projection TV may remain off unless the Secret No. is used to turn it off.

- When using the VIEWING TIME function by itself, the Rear Projection TV will start from the time the "STATUS" was set to "ON" and will turn off automatically at the set duration.
- When using the OFF TIME function by itself, the Rear Projection TV cannot be turned on from the time it was turned off until the time it was set to.

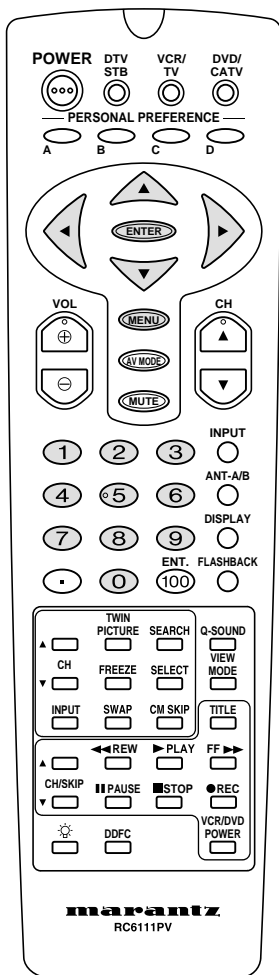

How to set VIEW TIMER

- 1 Press **MENU** to access MAIN MENU screen and then use or to move the cursor to "PARENT CTRL".

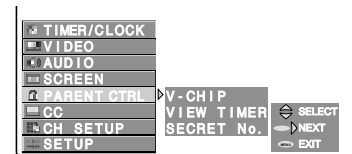

- Press **ENTER** or to access the PARENT CTRL mode.

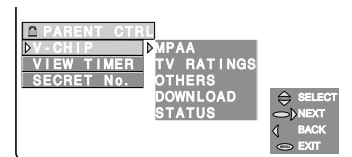

- 2 Input your secret number by using **DIRECT ACCESS** (0 ~ 9).

- 3 Press or to move the "▶" mark to "VIEW TIMER".

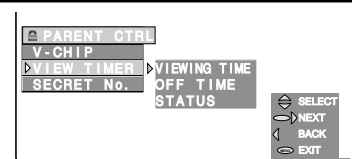

- 4 Press **ENTER** or to access the VIEW TIMER mode, then press or to select "VIEWING TIME" or "OFF TIME" (e.g. "VIEWING TIME").

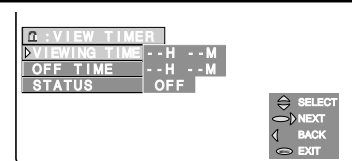

- 5 Press **ENTER** or to access the VIEWING TIME mode.



- 6 Press or to adjust the time duration, and then press **ENTER**.

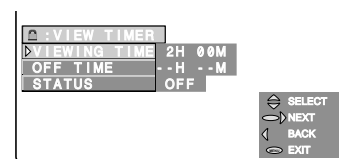

Note

- Even when the power is turned off, the remaining time on the VIEWING TIME function will stay unchanged. The timer then resumes countdown after the power is turned on again.



Parent Control (VIEW TIMER) (Continued)

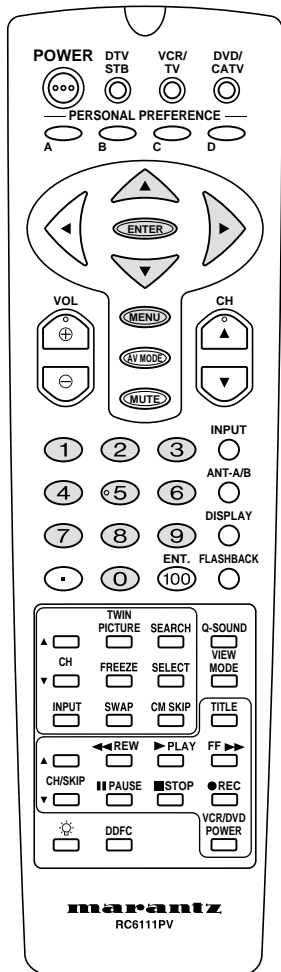

8 Press or to move the "▶" mark to "STATUS".

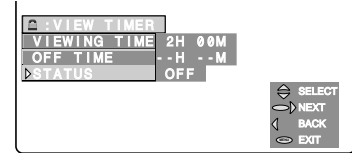

9 Press or and then use or to set "STATUS" to "ON" to turn on the VIEW TIMER.

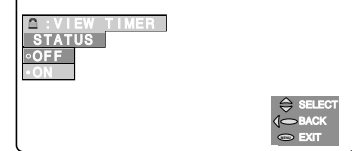

10 Press to exit.

- If you want to set "OFF TIME", select "OFF TIME" in step 5.

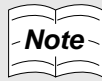

Notice on Remaining VIEWING TIME

- For every 30 minute interval, the remaining time will be displayed for four seconds.
- For the last five minutes, the remaining time will be displayed every minute.
- "0H 00M REMAIN" will be displayed for 10 seconds just before the VIEWING TIME is completed.

■ To cancel the VIEW TIMER setting

1 Repeat steps 1 to 2 of "How to set VIEW TIMER" on page 43, then "INPUT SECRET No." appears.

2 Press and hold both and on the front panel of the Rear Projection TV simultaneously for about five seconds until the message "INPUT SECRET No." disappears.

3 Press to exit.

- The setting of the Secret No. is canceled and the STATUS of the VIEW TIMER changes from ON to OFF.

- If you have forgotten your secret number, holding down and on the front panel of the Rear Projection TV simultaneously for about five seconds causes the original secret number to be canceled. A new secret number can be entered after canceling the original secret number.

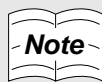

- When you enter the correct SECRET number, the VIEW TIMER mode is displayed. If the secret number is incorrect, "SECRET No.IS INCORRECT" is displayed (for two seconds). Input the SECRET number again in this case.
- While the Rear Projection TV is OFF but the OFF TIME is set, pressing POWER cause "TIME OVER" to appear on the screen. If you do nothing, the Rear Projection TV will turn off in approximately 30 seconds.

Channel Setup

If EZ SETUP does not memorize all the channels in your region, follow the instructions below to manually memorize the channels.

AIR/CABLE Setting

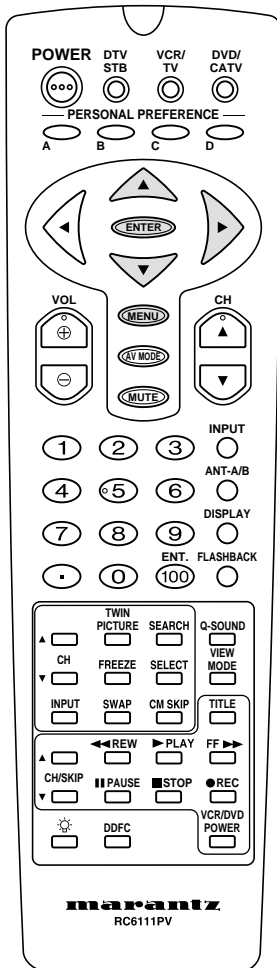

- 1** Press **MENU** to access MAIN MENU screen.

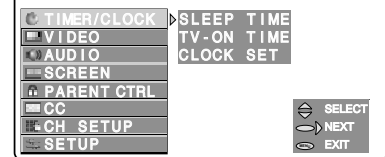

- 2** Press **▲** or **▼** to move the cursor to "CH SETUP".

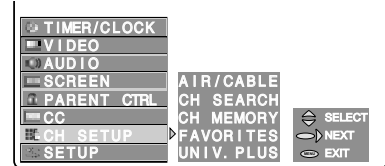

- 3** Press **ENTER** or **▶** to access the CH SETUP mode.

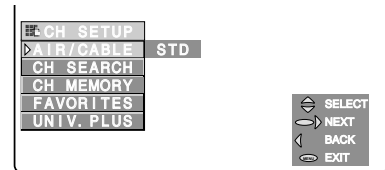

- 4** Press **▲** or **▼** to move the "▶" mark to "AIR/CABLE".

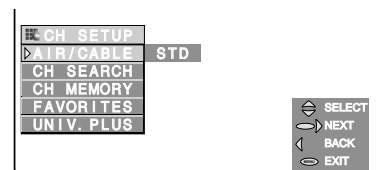

- 5** Press **ENTER** or **▶** to access the AIR/CABLE select mode.

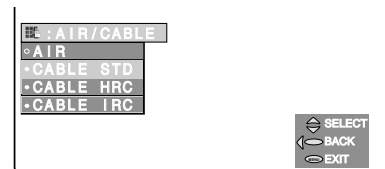

- 6** Press **▲** or **▼** to select your TV signal mode.

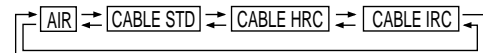

- 7** Press **MENU** to exit.

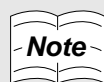

Receivable channels of your Rear Projection TV are:

- AIR channels:
 VHF: 2 through 13
 UHF: 14 through 69
 CABLE channels:
 1 (HRC and IRC mode only)
 2 through 125 (STD, HRC and IRC)



Channel setup (Continued)

Saving Broadcast TV channels to memory (Channel Search)

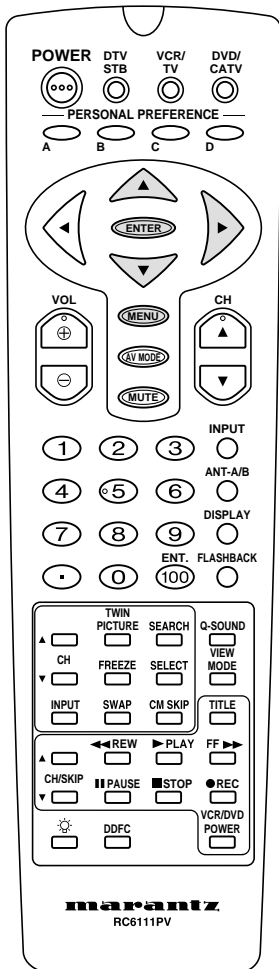

1 Repeat steps 1 to 3 of AIR/CABLE Setting on page 45.

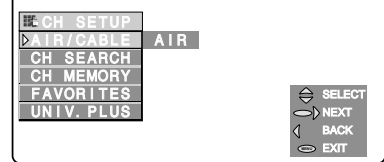

2 Press or to move the "▶" mark to "CH SEARCH".

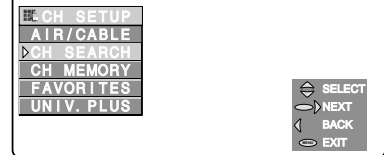

3 Press or to access the CH SEARCH mode.



4 Press or to move the "▶" mark to "START", then press .

- The tuner will search through all available channels in your area and add them into the Rear Projection TV's memory.



TO STOP SEARCH

Press or to move the "▶" mark to "STOP", then press .

- CH SEARCH will stop at the current channel and will not add any higher channels.



5 Press to exit.

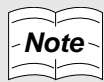

- If you START again while in the CH SEARCH mode, the auto-program will start again, and the previously memorized channels will be lost.



Channel setup (Continued)

Adding Weak or Additional Channels or Erasing Unwanted Channels from TV Memory

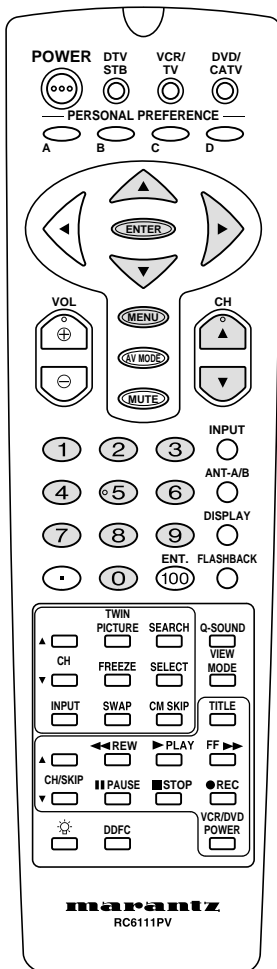

- 1** Repeat steps 1 to 3 of AIR/CABLE Setting on page 45.

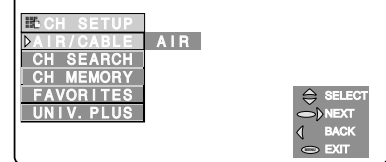

- 2** Press or to move the "▶" mark to "CH MEMORY".

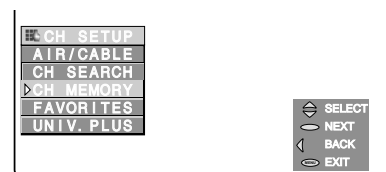

- 3** Press or to access the CH MEMORY mode.

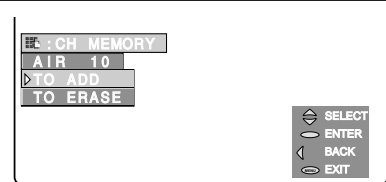

- 4** Use Channel or or **DIRECT ACCESS** (0 ~ 9) to select each desired channel you want to add or erase.

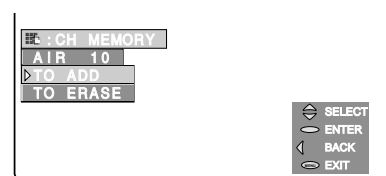

- 5** Use or to select "TO ERASE" or "TO ADD" to erase or add a channel and then press .

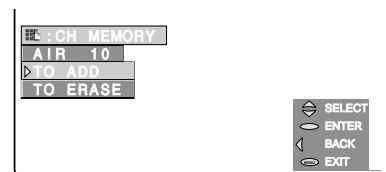

- 6** Press to exit.



Channel setup (Continued)

FAVORITES

FAVORITES allows you to program four favorite channels, in four different categories. (A total of 16 channels) By setting the FAVORITES channels in advance, you can select your favorite channels easily. Press **A**, **B**, **C** or **D** a number of times until your favorite channel is selected.

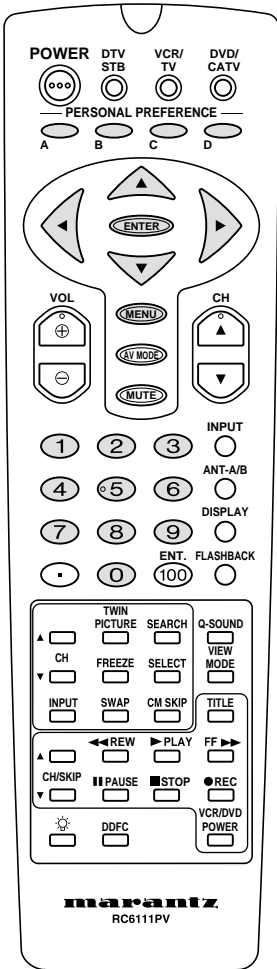

- 1** Repeat steps 1 to 3 of AIR/CABLE Setting on page 45.

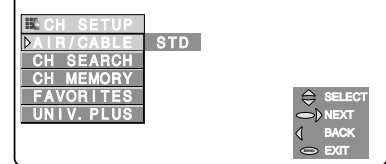

- 2** Press **▲** or **▼** to move the "▶" mark to "FAVORITES".

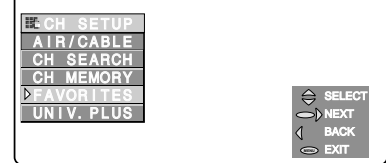

- 3** Press **ENTER** or **▶** to access the FAVORITES mode.

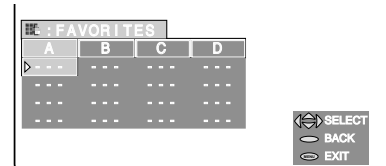

- 4** Press **▲**, **▼**, **◀** or **▶** to move the "▶" mark to the desired position.

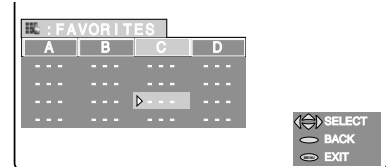

- 5** Press **DIRECT ACCESS** (**0** ~ **9**) to input the channel number into the memory.

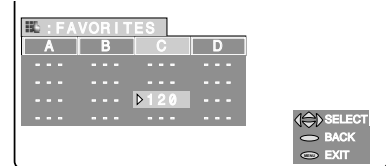

- Repeat steps 4 to 5 to input more CHANNEL numbers.

- 6** Press **MENU** to exit.



Channel setup (Continued)

UNIVERSAL PLUS Function

VCR/DVD input mode will be selected automatically when pressing VCR/DVD player PLAY button on the UNIVERSAL REMOTE CONTROL. (For VCR/DVD player connections, see pages 9 ~ 11)

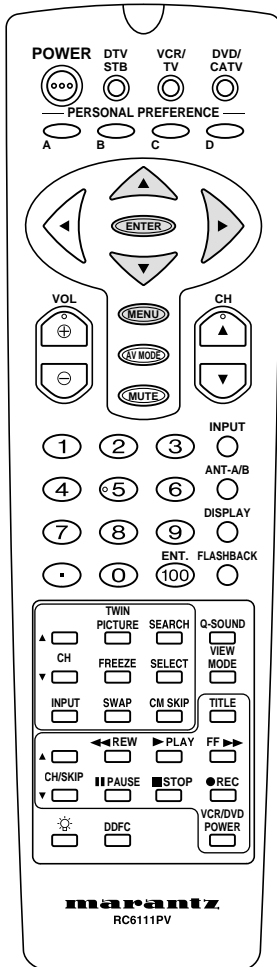

1 Repeat steps 1 to 3 of AIR/CABLE Setting on page 45.

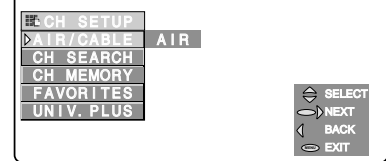

2 Press or to move the "▶" mark to "UNIV. PLUS".

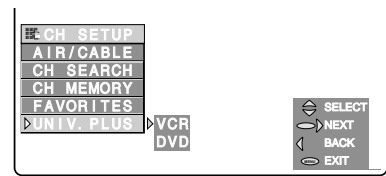

3 Press or to access the UNIV. PLUS mode.



4 Press or to select "VCR" or "DVD" (e.g. "VCR"), then press or .

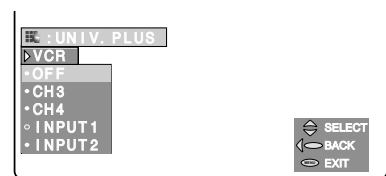

5 Press or to select channel or Input mode.



6 Press to exit.

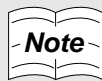

- It is not possible to select the same input mode for VCR and DVD player.
- The DVD input must be set to "OFF" or "INPUT1" ~ "INPUT5".

Setup

LANGUAGE

The language for the ON SCREEN DISPLAY can be set to ENGLISH, SPANISH or FRENCH.

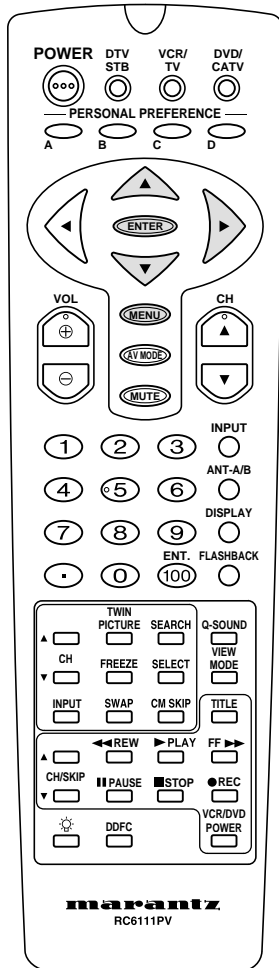

- 1** Press **MENU** to access MAIN MENU screen.

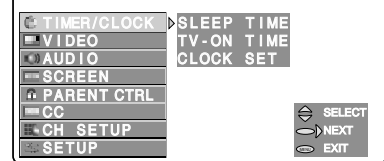

- 2** Press **▲** or **▼** to move the cursor to "SETUP".

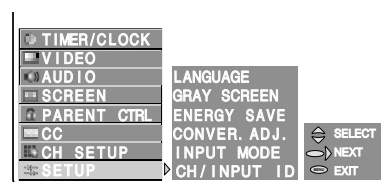

- 3** Press **ENTER** or **▶** to access the SET UP mode.

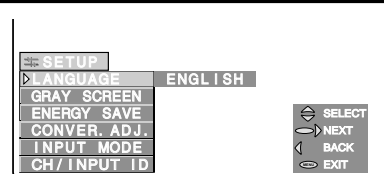

- 4** Press **ENTER** or **▶** to access the LANGUAGE mode.

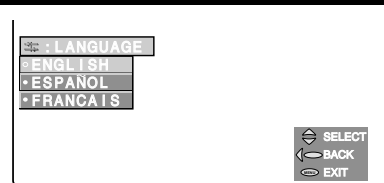

- 5** Press **▲** or **▼** to select "ENGLISH", "ESPAÑOL" (SPANISH) or "FRANÇAIS" (FRENCH).

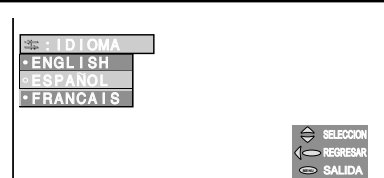

- 6** Press **MENU** to exit.

Setup (continued)

GRAY SCREEN

Automatically turns the screen gray if a broadcast signal is not received.

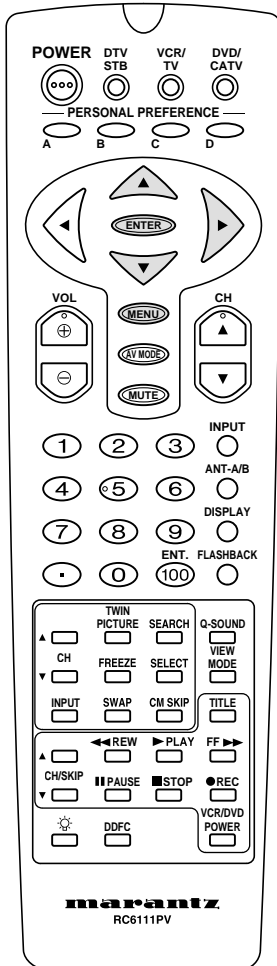

- 1** Press **MENU** to access MAIN MENU screen.

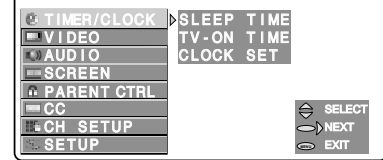

- 2** Press **▲** or **▼** to move the cursor to "SETUP", and then press **ENTER** or **▶** to access the SET UP mode.

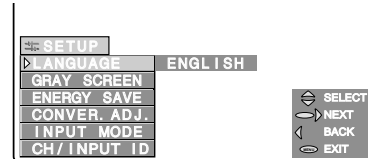

- 3** Press **▲** or **▼** to move the "▶" mark to "GRAY SCREEN".

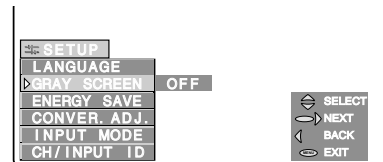

- 4** Press **ENTER** or **▶** to access the GRAY SCREEN select mode.



- 5** Press **▲** or **▼** to move the cursor to "ON".



- 6** Press **MENU** to exit.



Note

- When the GRAY SCREEN function has been set to ON, the screen will flicker if the broadcast signal is weak.

Setup (Continued)

ENERGY SAVE

This feature lets you lower the power consumption of your Rear Projection TV which in turn saves electricity and minimizes the impact on the environment. When this feature is turned on, it reduces the brightness of the Rear Projection TV to a level that consumes approximately 20 percent less energy than when the feature is turned off.

The reduction in brightness will be less noticeable under low room lighting conditions.

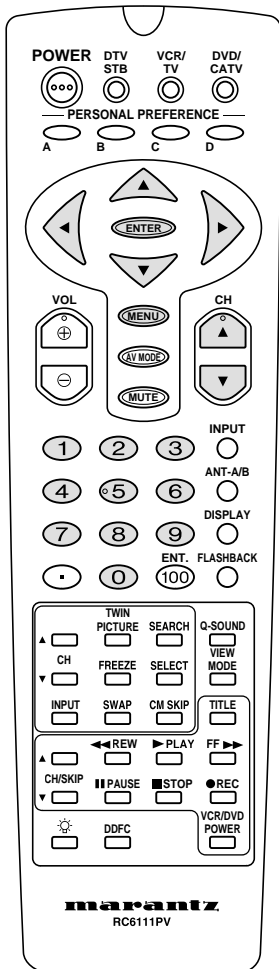

- 1** Press **MENU** to access MAIN MENU screen.

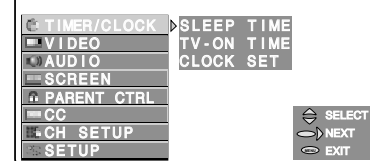

- 2** Press **▲** or **▼** to move the cursor to "SETUP", and then press **ENTER** or **▶** to access the SETUP mode.

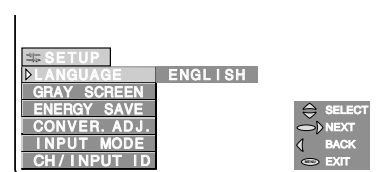

- 3** Press **▲** or **▼** to move the "▶" mark to "ENERGY SAVE".

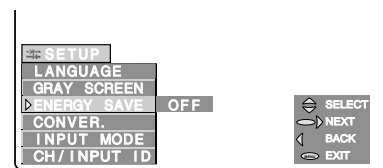

- 4** Press **ENTER** or **▶** to access the ENERGY SAVE mode.



- 5** Press **▲** or **▼** to move the cursor to "ON" or "OFF".



- 6** Press **MENU** to exit.

Setup (Continued)

CONVERGENCE ADJUST

Your Rear Projection TV has three color projection tubes: one for red, one for green, one for blue. When mixed together in the proper proportion, the output of these three color tubes can produce any color. To produce these colors, however, the beams must be precisely aligned over each other so that the colors can be mixed. The process of aligning these picture beams is called "convergence".

Over a period of time, the picture tubes can drift out of alignment due to normal bumps and vibrations or moving the Rear Projection TV. If you move your Rear Projection TV, or if, after a time, you notice color rings or halos around objects in the picture, you may want to converge (align) the colors.

Properly converged, the lines appear white, which is actually a combination of the outputs of the three color tubes. The output of the green tube is stationary. The outputs of the red and blue tubes can be adjusted.

To simplify convergence, this Rear Projection TV incorporates a feature to allow you to display a test pattern of horizontal and vertical lines at nine different locations on the screen. Simply use the remote control to adjust the red and blue colors to match the green.

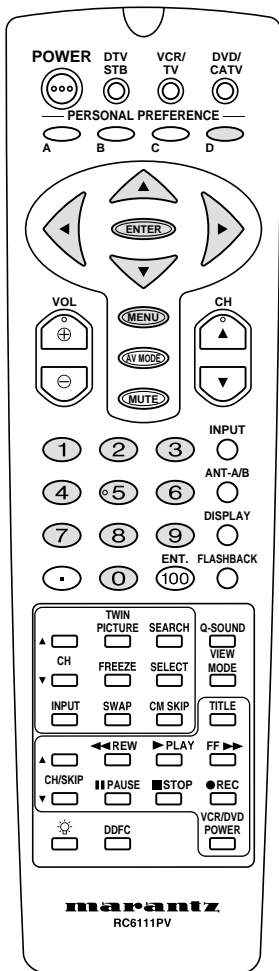

1

Repeat steps 1 and 2 of the ENERGY SAVE setting on page 52.

Press or to move the "▶" mark to "CONVER. ADJ."



2

Press or to access the CONVER. ADJ. mode.



3

Press or to select "ON" and then press or to display nine crosshatches.

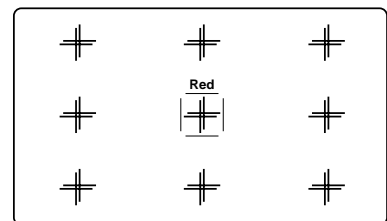

4

Use , , , or to move the red cross in the center to match it to the green cross.

- When adjusting convergence, always start at the center of the screen.
- Four lines surrounding a crosshatch indicate the point being adjusted. The color of these surrounding lines indicates the color being adjusted.

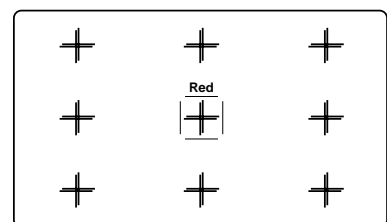

Setup (Continued)

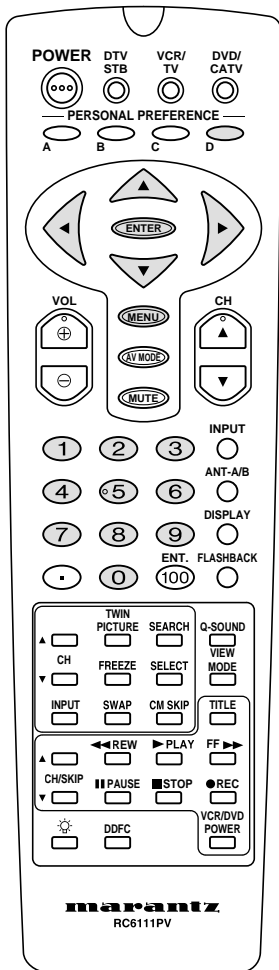

5 Specify the crosshatch which stands out with a comparatively uneven color by using ① ~ ⑨. (e.g. bottom right)*, press , , or to move the red cross to match it to the green cross.

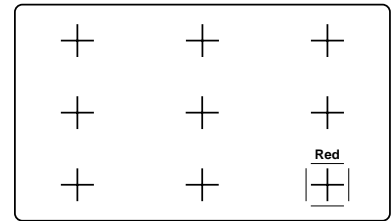

* Buttons which corresponds to each crosshatch

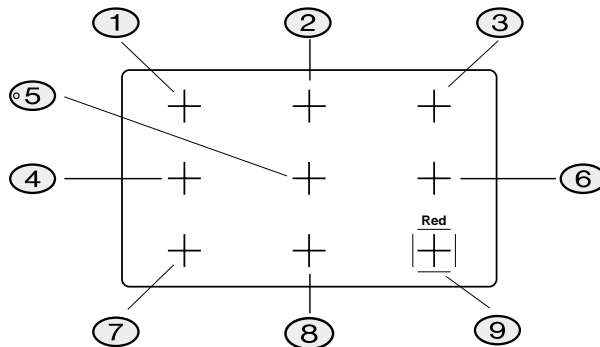

6 Press **ENTER** and then use , , or to move the blue cross to match it to the yellow cross.

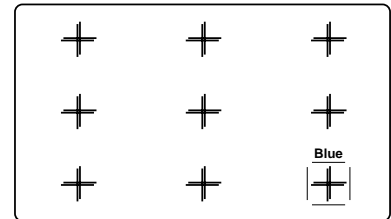

7 Apply step 5 and match the blue cross to the yellow cross.

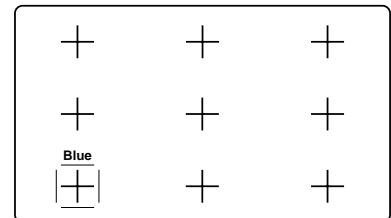

IMPORTANT

8 Press the **PERSONAL PREFERENCE** button on the remote control to confirm the adjustment.

- After steps 1-7 are performed, turning the power off also saves your adjustment into memory without pressing **PERSONAL PREFERENCE**.

9 Press **MENU** to exit.

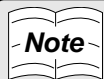

- If you do not wish to save your adjustment data into memory, press the remote control **AV MODE**. When the Rear Projection TV is turned on again, your old convergence data will be restored.
- On-screen display MENU text may become offset when the signal is lost. Restoring the signal and the MENU text resumes normal appearance.

Setup (Continued)

INPUT MODE

You can select the input signal in INPUT 3 and INPUT 4. The setting items vary in INPUT 3 and INPUT 4.

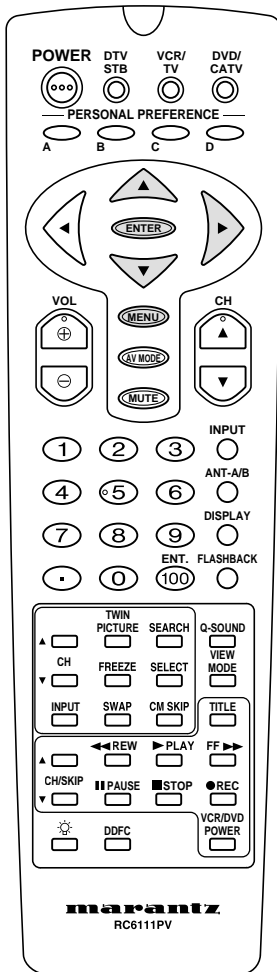

- 1** Repeat steps 1 and 2 of the ENERGY SAVE setting on page 52.

Press or to move the "▶" mark to "INPUT MODE".

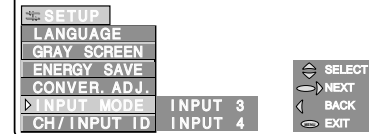

- 2** Press or to access the INPUT MODE.

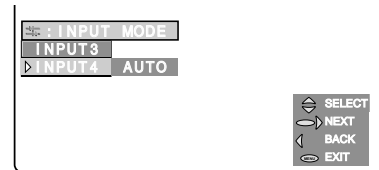

- 3** Press or to select INPUT No. which you want to adjust, and then press or to access the INPUT MODE (e.g. INPUT 4).

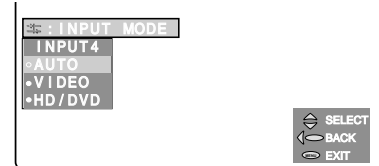

- 4** Press or to select the instrument (HD/DVD).

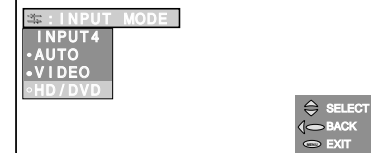

- 5** Press to exit.

Description of setting items

INPUT 3 : Select input port and input signal between VIDEO and RGB.

VIDEO : Only VIDEO

RGB : RGB signal

INPUT 4 : Select input port and input signal from AUTO, VIDEO or HD/DVD.

AUTO : This setting automatically distinguishes the input source (input signal).

VIDEO : Only VIDEO

HD/DVD : To connect a player which has component video output terminals, such as DVD player, etc. The signal is chosen automatically (480I/480P/720P/1080I).

Setup (Continued)

CH/INPUT ID

With the "CH ID" of the CH/INPUT ID function, it is possible to input the names (up to four letters) of channels, for example CNN, NBC. With the "INPUT ID", it is possible to input names (up to four letters) for each of the input terminals on the Rear Projection TV (for example, VCR, DVD, STB). This function makes it easy to select the source being displayed on the screen.

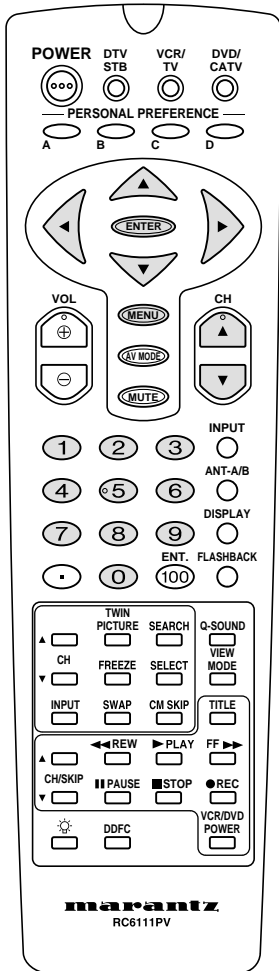

- 1** Repeat steps 1 and 2 of the ENERGY SAVE setting on page 52.
- Press or to move the "▶" mark to "CH/INPUT ID".

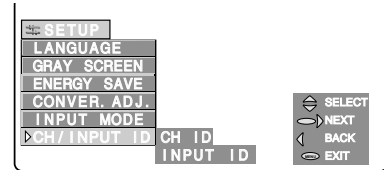

- 2** Press or to access the CH/INPUT ID mode.

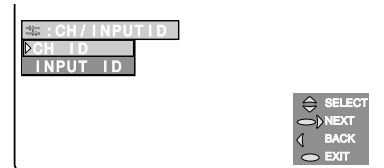

- 3** Press or to select "CH ID" or "INPUT ID" and then press or (eg. "CH ID").

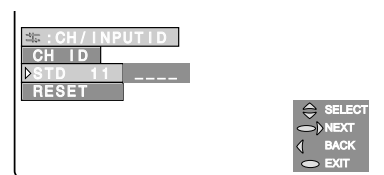

- 4** Use or , or **DIRECT ACCESS** (0 ~ 9) to select channel whose name you want to register. Then press .



- 5** Use , , , or to input the name.
- , ... Selects a letter
 - , Changes the place where a letter is input



- 6** Press .

- Repeat steps 5 to 7 to input more CH/INPUT IDs.

- 7** Press to exit.

Changing Screen Size

The size of the picture can be adjusted to the following screen sizes.

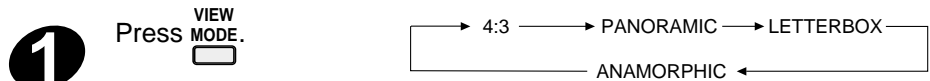
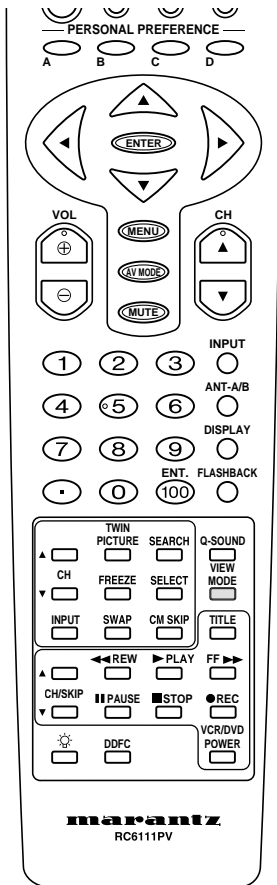

- Each time **VIEW MODE** is pressed, the mode changes in the order above.

4:3: Suitable for viewing news or sitcoms. Video software can be viewed in its original screen frame size.

(4:3 image)

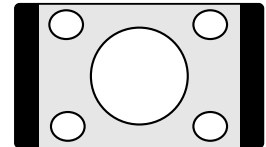

PANORAMIC: Suitable for viewing news or sports programs. Movies or Sports programs can be viewed with an expansive powerful image.

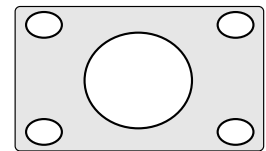

LETTERBOX: Suitable for viewing Vista size and other such movie images. Provides a more expansive, powerful image. This screen size is also convenient when viewing a Cinemascope size image that has subtitles.

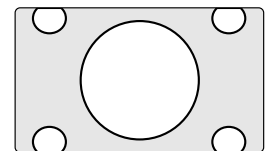

ANAMORPHIC: Suitable for viewing wide-screen images or anamorphic DVDs.

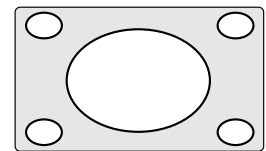

IMPORTANT!

In case of a 540P/720P/1080I signal, pressing **VIEW MODE** switches the view mode between ANAMORPHIC and ZOOM.

ZOOM:

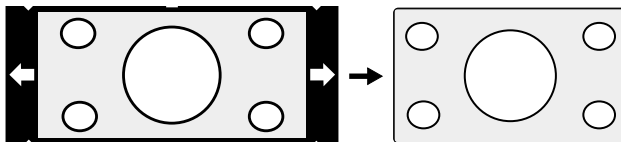

- Black bands may remain at the top and bottom of the screen depending on the size of the picture (such as in the case of Cinemascope size).
- Some portions of captions may be missing with certain types of commercially available video software. When this happens, switch the screen to the optimum screen size with the screen size button, and adjust screen scroll or vertical size.
- This TV is provided with these view modes to display images with various aspect ratios. When 4:3 images are fully displayed on a wide TV screen in the PANORAMIC mode, LETTERBOX mode, or ANAMORPHIC mode, some parts of the images may be cut off or distorted, as described in the above illustrations.
- Continuous operation for extended periods in 4:3 mode may burn the screen. Marantz thus recommends that use of this mode should be limited.

Selecting DDFC Mode or AV Mode

Selecting DDFC Mode

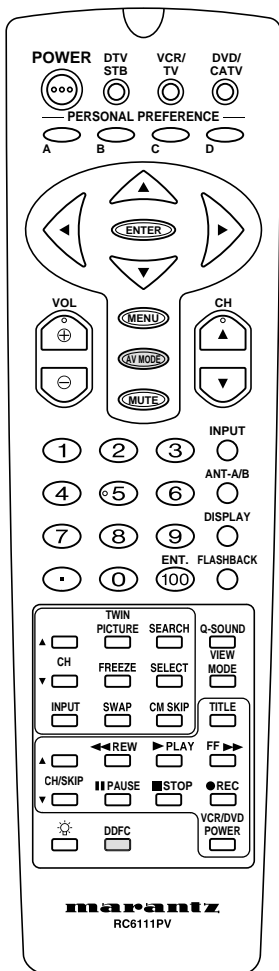

1 Press .

- You can select the picture quality from three different modes.
- Each time is pressed, the mode changes in the order below.

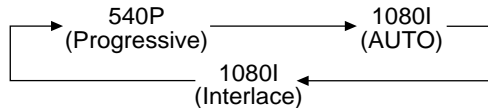

540P (Progressive)	This mode is used to display still images or graphics without flickering.
1080I (AUTO)	This mode is used to enjoy movies on DVD without flickering.
1080I (Interlace)	This mode is used to enjoy movies on DVD with 3:2 pull-down.

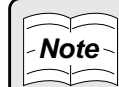
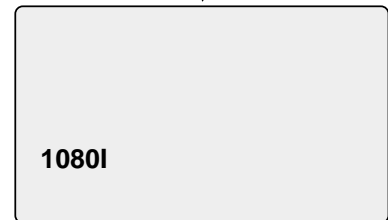
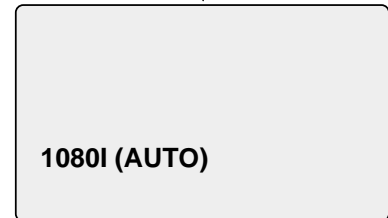
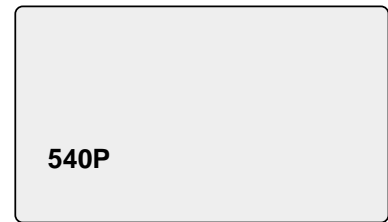

- Selecting the mode "540P" reduces screen flickering when using a video game machine.
- If the input signal is 480P, 1080I Auto mode cannot be accessed.

Selecting AV Mode

You can select the picture setting which displays the video in the most desirable way.

1 Press .

- Each time is pressed, the mode changes in the following order.

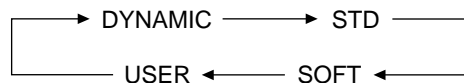

DYNAMIC: an actively forceful image definition mode

SOFT: a soft and gentle image definition mode

STD: a standard image definition mode suited for everybody as well as for many types of VCR tapes and DVD discs.

- DYNAMIC/STD/SOFT

A common value is set for all input signals.

- USER

A different value is set for each of the TV's terminals, INPUT 1-5. (When switching to a different input, a specific value is set.)

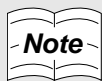

DDFC Mode change only operates with 480I, 480P, or conventional broadcast signals. It has no effect on other formats.

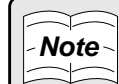

- The VIDEO ADJ. or PRO ADJ. settings can be memorized in each AV mode (see pages 25 - 26 for Video Adjust.)

Multi-screen Function

View two Screens (TWIN PICTURE Screen)

The screen can be split vertically, making it possible to view different images on the left and right.

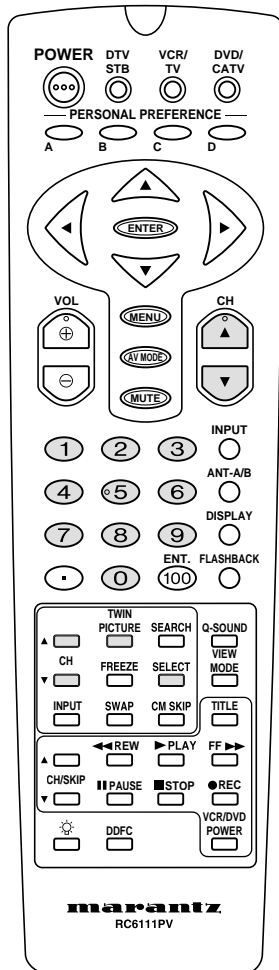

1 Press TWIN PICTURE.

- Press **DIRECT ACCESS** (1 ~ 9) or or to select your desired channel for the Main picture.

- Press to select your desired channel for the Sub-picture.

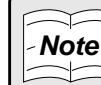
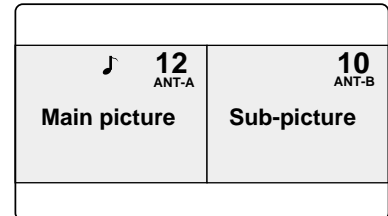

- The screen on which “♪” is displayed is the main picture, and the other screen is the sub-picture. Sound will be output for the main picture.
- Regular operations can be performed for the main picture.
- When the button is pressed, “♪” will move to the other screen.
- The closed caption function does not work in the Twin picture screen.

2 Press TWIN PICTURE to make the left part of the screen become larger.

- The only image that can be enlarged is the left one. It is not possible to enlarge the image on the right.

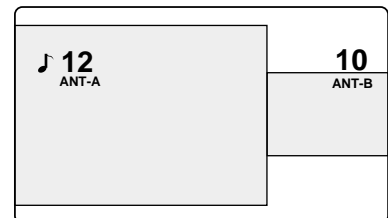

3 Press TWIN PICTURE to return to the initial screen.

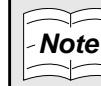



- In the TWIN PICTURE screen mode, it is not possible to display two images from the same input source.
- The broadcasting signal in ANT-A, ANT-B in the TWIN PICTURE screen mode cannot change as in the normal screen.

Multi-screen Function (Continued)

Making Notes From the Program Content (Freeze Screen)

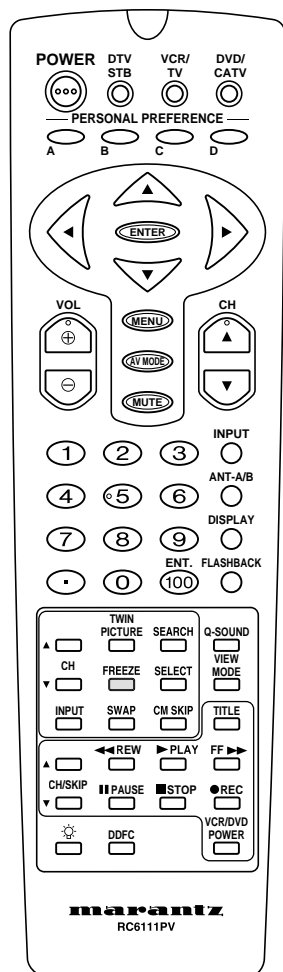
The screen can be frozen, such as for taking down a recipe from a cooking program or address for entering a contest.



1 Press  .

- The freeze function serves as a memo function. By changing a full screen into twin picture mode the left screen is frozen. This function is convenient when information you want to take down is displayed on the screen.

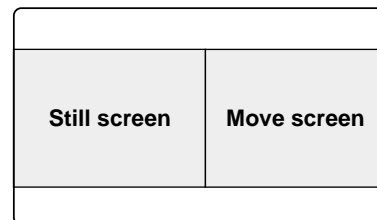

2 Press  again to restore to full screen.

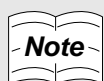

Note

- This function is operable only with the normal screen.
- The Closed Caption function does not work when Freeze is used.
- The Freeze Screen function is disabled when "STATUS" of the V-CHIP is "ON."

Multi-screen Function (Continued)

Searching for a Program on a Different Channel (Search Screen)

The screen on the right side can be divided into three different screens, making it possible to search for programs or enjoy multiple images.

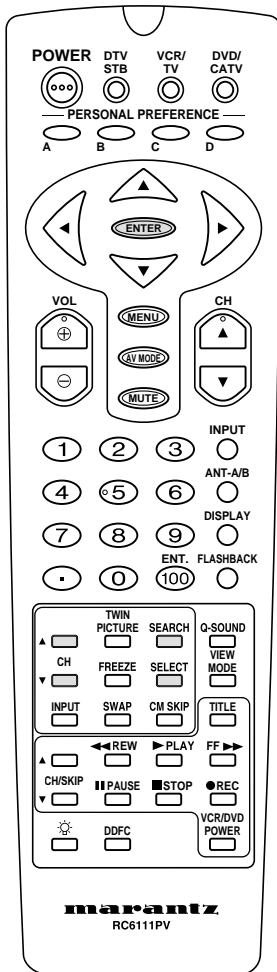

- 1 Press **SEARCH** to display 3-SEARCH screen.

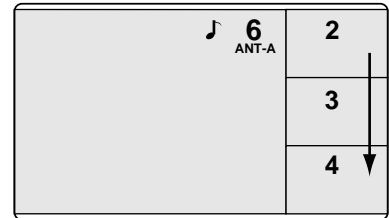

- Each time **SEARCH** is pressed, the screen mode changes in the following order.

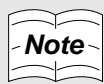

- Pressing **CH** / **CH** changes the channels of the three subscreens into three new screens.
- It is not possible to alter the color or the sound of the Search picture.
- Sound output is limited to the main picture.

To enlarge one of three subscreens

- (1) Press **SELECT** a number of times until the screen you want to enlarge is selected.
- (2) Press **ENTER** to enlarge selected screen.

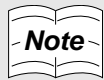

- Continuous operation for extended periods in SEARCH screen mode may burn the screen. Marantz thus recommends that use of the Search function should be limited.
- The 3-SEARCH screen function is disabled when "STATUS" of the V-CHIP is "ON".
- The Closed Caption function does not work when using the 3-Search function.

Multi-screen Function (Continued)

Interchanging the Left and Right Screens you are Currently Watching (Swap Screen)

Use **SWAP** to interchange the left and right screens you are currently watching.

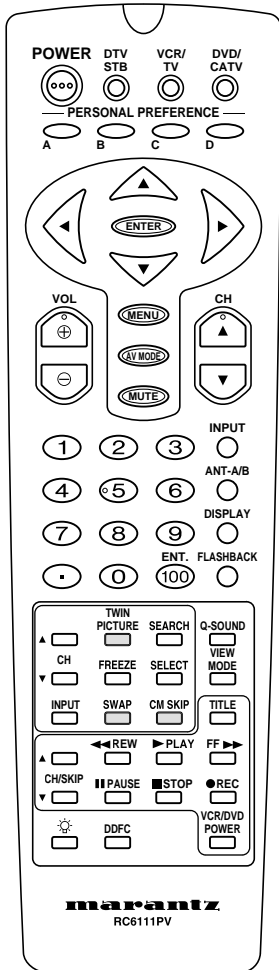

- 1 Press **PICTURE** to use the twin picture display.

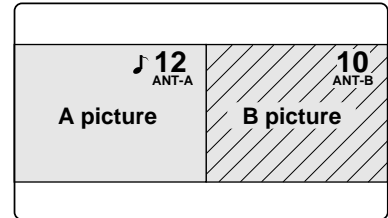

- 2 Press **SWAP** to interchange the left and right screens.

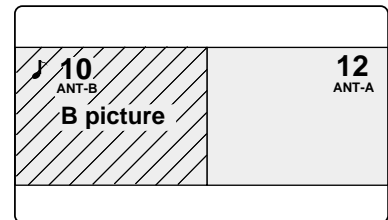

Note

- This operation is only performed during the twin picture display.
- If you use the SWAP function, the Antenna signal (ANT-A / ANT-B) interchanges as well. (See the step 2 above.)

Scanning other channels during a commercial break (Commercial Skip)

During airing of commercial message, you can watch other programs by using the Commercial Skip function.

- 1 When a commercial break occurs, press **CM SKIP** to move the main picture to the subpicture on the right.

- While you are watching other channels you can check the subpicture.

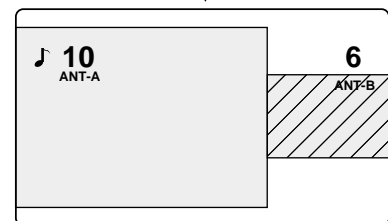
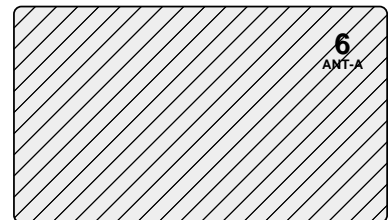

- 2 Press **CM SKIP** when the program in the subpicture starts again.
- Then the subpicture moves to the main picture.

Note

- CM SKIP only works with the tuner. It does not work with Video Input/Component.

Operation of the Remote Control for Other Devices

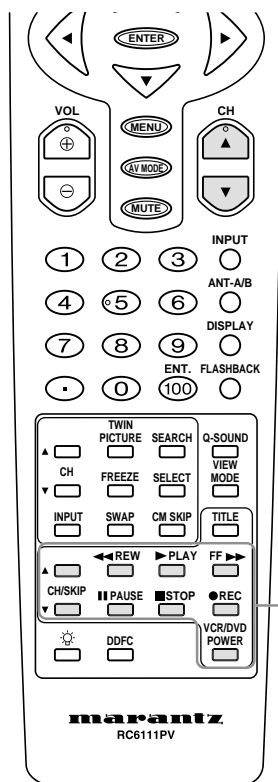

	VCR/DVD POWER Press to turn the VCR/DVD player on and off.
	VCR CHANNEL, DVD SKIP CHANNEL UP (▲) / DOWN (▼) for VCR, SKIP for DVD player Press to scan up or down through channels on the VCR or SKIP for DVD player.
	REWIND Press to perform fast reversing with the tape/disc. For some VCRs/DVD players, you may need to press first, then . In Playback mode, hold the button down to view picture moving rapidly in reverse.
	PLAY Press to play back.
	FAST FORWARD Press to perform fast forwarding with the tape/disc. For some VCRs/DVD players, you may need to press first, then . In Playback mode, hold the button down to view the picture rapidly in the forward direction.
	PAUSE Press to temporarily stop the tape or disc during playback (or recording only for VCR). Press again to restart playback.
	STOP Press to stop the tape or disc.
	RECORD Press to begin recording only for VCR.

■ Universal Remote Control

With the purchase of your Rear Projection TV you also have received the latest innovation in remote control technology. With its easy-to-use push button keyboard, your remote can control your Rear Projection TV and most infrared remote controlled VCRs, DVD players, cable TV converters and DTV STB as well.

	• Depending on the model, year produced, brand and type of VCR/DVD player, some models may not be compatible with the remote control.
	• Some brands of Cable TV converter Box may not enable channel selection until is pressed.

■ Using your Remote control with a DTV STB (Decoder)

After installing the batteries, press DTV STB. (If you can change the channel of the DTV STB (Decoder) by pressing or on the remote control, the unit is in the DTV mode.)

■ Using Your Remote With Your Rear Projection TV

After installing the batteries, set the DTV STB-TV-CATV on the remote to the TV position. (If you can change the channel of the TV by pressing or on the Remote Control, the unit is in the TV position.)

■ “Identifying” Remote VCR/DVD player, Cable TV Converters and DTV STB

Your remote control has been set at the factory to operate your Rear Projection TV and many remote controlled VCRs, DVD players, Cable Converters and DTV STB. However, in some cases an easy one-time set-up step may be necessary before the remote will operate VCRs, DVD players, Cable Converters and DTV STB.

- In this set-up step, the remote locates and memorizes the remote control transmitter code for the VCR, DVD player, Cable Converter or DTV STB.
- Once “identified”, the remote sends the proper remote signals to operate your equipment.
- This identification step will not have to be repeated until power to the remote is interrupted, e.g. due to battery replacement.

■ USING YOUR REMOTE CONTROL WITH A VCR OR DVD PLAYER

Once you make certain the remote control has “identified” your remote controlled VCR or DVD player, the remote control is ready to operate your equipment. The various VCR/DVD function buttons on the remote control will not operate your VCR/DVD player unless those features are available on the VCR/DVD player.

- All VCR/DVD buttons will operate whether the remote control is in the TV or CATV modes.
- For detailed information on the use of the VCR or DVD player, refer to the operation manual of the VCR or DVD player.

Operation of the Remote Control for Other Devices (Continued)

How to Identify a VCR

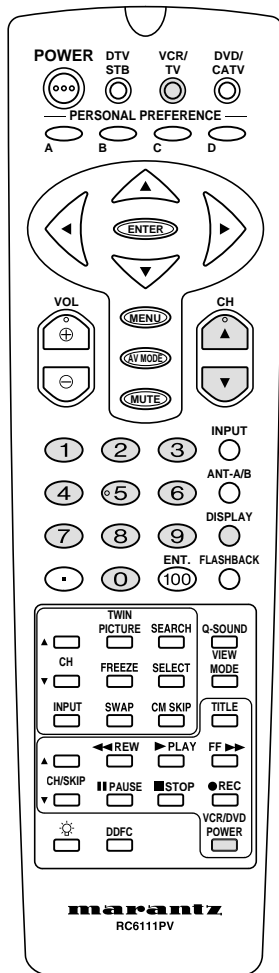









The remote control may already be set to operate your VCR. Try this initial check to see whether it will be necessary to “identify” your VCR.

- (1) Point the remote towards the VCR and press  .
- (2) Does the remote turn the VCR ON and OFF?
 - If yes, the remote is ready to operate the VCR and no further steps are needed.
 - If no, continue to the “identify” section.

■ To Identify Your VCR – Direct Entry Method.

Use the following steps and the list (on page 65) to quickly find the remote control code for your VCR.



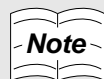

- First look up your VCR’s remote control code number (on page 65) before continuing the direct code entry steps.

- (1) Press  and the button lights.
- (2) While holding down  , press  on your remote control.
Make sure  lamp goes out and then release both buttons.
- (3) Within ten seconds after releasing  and  , enter your VCR’s two-digit remote control code number using **DIRECT ACCESS** ( ~ ) (refer to the list on page 65). The code should be identified within two minutes.
 -  lights for two seconds and then goes out. This indicates that the setting is performed successfully.
 - The remote control is now ready to send commands to your VCR. Some brands have more than one remote code listed, due to changes in the remote codes from early to later model years, or due to format differences (VHS/BETA). In such cases, you may have to try more than one code to find the code your VCR accepts.



- Depending on the model, year produced, brand, and type of VCR, some models may not be compatible with the remote control.

Tips on Identifying your VCR through the Search method

- (1) While pointing the front part of the remote control towards the infrared sensor of the VCR, press  and then  and hold them down for up to two minutes. Be careful not to let the VCR scan more than five channels when the indicator starts to increase. If you continue to hold down the buttons after five channel scans, the proper remote code can be passed up and the two-minute cycle will have to be repeated.
 - The remote control then searches in order for the VCR Brand Code Number (listed on page 65).
- (2) At the instant when the VCR channel changes, release  and  and the procedure will be completed. If a channel change does not occur on the VCR within two minutes, read the identifying instructions again and repeat the steps. Should a channel change still not occur, the remote will most likely not operate your VCR.

Operation of the Remote Control for Other Devices (Continued)

VCR BRAND	REMOTE CONTROL CODE NUMBER
Akai	25, 26, 37
Audio Dynamics	15, 22, 30
Broksonic	32
Canon	04
Capehart	34
Craig	31
Curtis Mathis	04
Daewoo	34
DBX	15, 22, 30
Dynatech	29
Emerson	21, 32, 35
Fisher	09, 11
Funai	29
GE	04
Goldstar	24
Hitachi	06
Instant Replay	04
JC Penney	04, 06, 24, 30
JVC	15, 41, 42
Kenwood	15
Lloyds	29
Magnavox	04, 05, 08
Magnin	31
Marantz	30
Memorex	04, 10, 24, 29
Minolta	06
Mitsubishi	17, 18, 39, 40
Montgomery Ward	02, 43

VCR BRAND	REMOTE CONTROL CODE NUMBER
Multitech	29
NEC	15, 22, 30
Panasonic	04, 44
Pentax	05, 06
Philco	04, 05
Philips	04, 05, 08
Quasar	04
RCA	06, 07, 33
Realistic	01, 02, 24
Samsung	23, 31
Scott	20
Sears	06, 11, 24
Sharp	01, 02, 03
Shintom	36
Sony	12, 13, 38
Sound Design	29
Sylvania	04, 05, 08
Symphonic	29
Tatung	15
Teac	15, 29
Teknika	27, 29
Thomas	29
TMK	21
Toshiba	19, 20
Video Concepts	30
Yamaha	15, 29, 30
Zenith	16

Operation of the Remote Control for Other Devices (Continued)

How to Identify a DVD Player

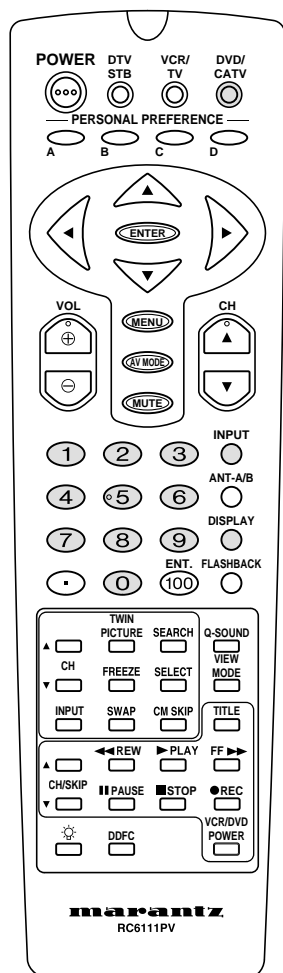

■ To Identify Your DVD player –Direct Entry Method

Use the following steps and the list below to quickly find the remote control code for your DVD player.

- First look up your DVD player's remote code number on the list below before continuing the direct code entry steps below.

(1) Press **DVD/CATV** and the button lights.

(2) While holding **DISPLAY**, press **INPUT** on your remote control.

Make sure **DVD/CATV** lamp goes out and then release both buttons.

(3) Within ten seconds after releasing **DISPLAY** and **INPUT**, enter your DVD player's two-digit code number using **DIRECT ACCESS** (0 ~ 9) (refer to the list). The code should be identified within two minutes.

- **DVD/CATV** lights for two seconds and then goes out. This indicates that the setting is performed successfully.
- The remote control is now ready to send commands to your DVD player.

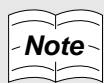

Note

- Depending on the model, year produced, brand, and type of DVD player, some models may not be compatible with the remote control.

DVD PLAYER BRAND	REMOTE CONTROL CODE NUMBER
JVC	09
Mitsubishi	06
Panasonic	02
Pioneer	08
RCA	03
Samsung	07
Sharp	01
Sony	05
Toshiba	04

Operation of the Remote Control for Other Devices (Continued)

How to Identify a DTV STB (Digital TV Set-Top Box)

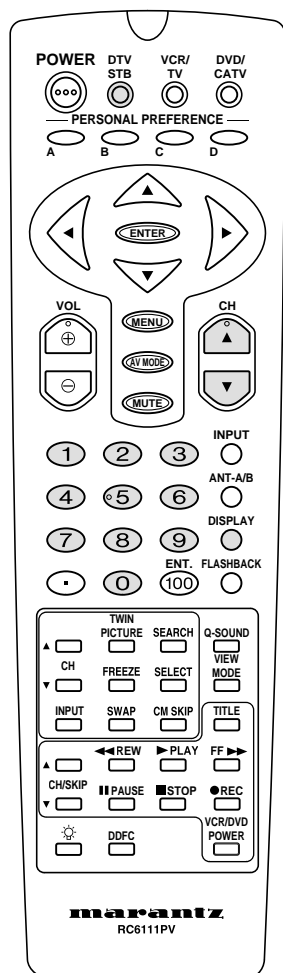

■ To Identify Your DTV STB –Direct Entry Method

Use the following steps and the list below to quickly find the remote control code for your DTV STB.

- First look up your DTV STB's remote code number on the list below before continuing the direct code entry steps below.

- (1) Press **DTV/STB** and the button lights.
- (2) While holding down **DISPLAY**, press **DOWN** on your remote control. Make sure **DTV/STB** lamp goes out and then release both buttons.
- (3) Within ten seconds after releasing **DISPLAY** and **DOWN**, enter your DTV STB's two-digit code number using **DIRECT ACCESS** (0 ~ 9) (refer to the list). The code should be identified within two minutes.

- **DTV/STB** lights for two seconds and then goes out. This indicates that the setting is performed successfully.
- The remote control is now ready to send commands to your DTV STB.

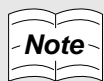

• Depending on the model, year produced, brand, and type of DTV STB, some models may not be compatible with the remote control.

Identifying your DTV STB through the Search method

- (1) While pointing the front part of the remote control towards the infrared sensor of the DTV STB, press **DISPLAY** and then **DOWN** and hold them down for up to two minutes. Be careful not to let the DTV STB scan more than five channels when the indicator starts to increase. If you continue to hold down the buttons after five channel scans, the proper remote code can be passed up and the two-minute cycle will have to be repeated.
 - The remote control then searches in order for the DTV STB Brand Code Number (listed below).
- (2) At the instant when the DTV STB channel changes, release **DISPLAY** and **DOWN** and the procedure will be completed. If a channel change does not occur on the DTV STB within two minutes, read the identifying instructions again and repeat the steps. Should a channel change still not occur, the remote will most likely not operate your DTV STB.

DTV STB BRAND	REMOTE CONTROL CODE NUMBER
Panasonic	04
Pioneer	01
RCA	02
Sharp	01
Sony	03

Operation of the Remote Control for Other Devices (Continued)

How to Identify a Cable Converter

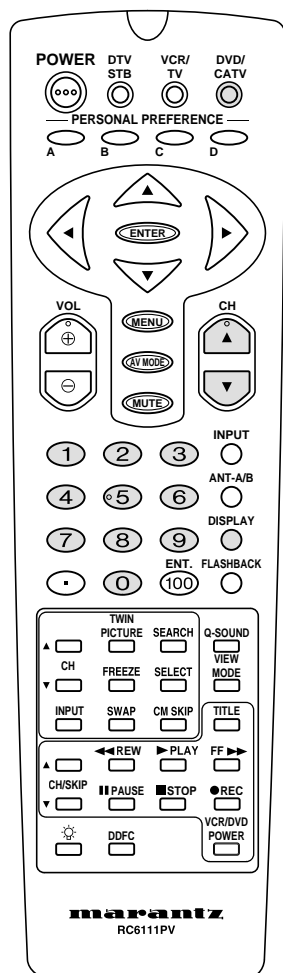

■ To Identify Your Cable Converter –Direct Entry Method

Use the following steps and list (on page 69) to quickly find the remote control code for your cable TV converter.

- First look up your converter's remote code number on page 69 before continuing the direct code entry steps below.

(1) Press **DVD/CATV** and the button lights.

(2) While holding down **DISPLAY**, press **DVD/CATV** on your remote control.

Make sure **DVD/CATV** lamp goes out and then release both buttons.

(3) Within ten seconds after releasing **DISPLAY** and **DVD/CATV**, enter your converter's two-digit code number using **DIRECT ACCESS** (0 ~ 9) (refer to the list on page 69). The code should be identified within two minutes.

- **DVD/CATV** lights for two seconds and then goes out. This indicates that the setting is performed successfully.
- The remote control is now ready to send commands to your converter.

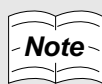

- Depending on the model, year produced, brand, and type of CATV converter, some models may not be compatible with the remote control.

Identifying your Cable Converter through the Search method

(1) While pointing the front part of the remote control towards the infrared sensor of the cable converter, press **DISPLAY** and then **DVD/CATV** and hold them down for up to two minutes. Be careful not to let the cable converter scan more than five channels when the indicator starts to increase. If you continue to hold down the buttons after five channel scans, the proper remote code can be passed up and the two-minute cycle will have to be repeated.

- The remote control then searches in order for the cable converter Brand Code Number (listed on page 69).

(2) At the instant when the cable converter channel changes, release **DISPLAY** and **DVD/CATV** and the procedure will be completed. If a channel change does not occur on the cable converter within two minutes, read the identifying instructions again and repeat the steps. Should a channel change still not occur, the remote will most likely not operate your cable converter.

Operation of the Remote Control for Other Devices (Continued)

CATV CONVERTER BRAND	REMOTE CONTROL CODE NUMBER	CATV CONVERTER BRAND	REMOTE CONTROL CODE NUMBER
Anvision	07, 08	Philips	07, 08, 19, 26, 28, 29, 32, 33, 40, 41
Cable Star	07, 08	Pioneer	18, 20
Eagle	08	Randtek	07, 08
Eastern International	02	RCA	27
General Instrument	04, 05, 15, 23, 24, 25, 30, 36	Regal	12
Hamlin	12, 13, 34	Regency	02
Jerrold	04, 05, 15, 23, 24, 25, 30, 36	Scientific Atlanta	03, 22, 42
Macom	37	Sylvania	11
Magnavox	07, 08, 19, 25, 28, 29, 32, 33, 40, 41	Teknika	06
NSC	09	Texscan	11
Oak	01, 16, 38	Tocom	17, 21
Oak Sigma	18	Unika	31
Panasonic	27, 39	Viewstar	07, 08, 19, 26, 28, 29, 32, 33, 40, 41
		Zenith	14

Specifications

Model	PV6111W
Signal System	NTSC
Channel	AIR 2ch – 69ch CATV 1ch – 125ch
Antenna input	ANT A/B 75 Ω unbalance
Video input	(INPUT 1, 2, 3, 4) Composite Input jack: Pin-jack × 1 Input level: 1 Vp-p/75 Ω/negative sync
S video input	(INPUT 1, 2, 3) Y/C Y: 1 Vp-p/75 Ω/negative sync C: 0.286 Vp-p/75 Ω
Component input	(INPUT 4, 5) Component (Y, P _B , P _R) Input jack: Pin-jack × 3 (INPUT 4) Input signal: 480I, 480P, 720P, 1080I Y: 1Vp-p/75 Ω/negative sync P _B , P _R : 0.525 Vp-p/75 Ω (75 % saturation level)
HD input (RGB)	(INPUT 3) R, G, B, H, V INPUT jack: Dsub 15 pin × 1 Input signal: 480P, 540P, 720P, 1080I RGB: 0.7 Vp-p/75 Ω/no sync HD, VD: TTL level/positive and negative
AUDIO input	(INPUT 1, 2, 3, 4, 5) Input jack: Pin-jack × 2 0.5 Vrms/22 kΩ or over
VAO (Variable audio output)	Output jack: Pin-jack × 2 0.89 Vrms (max)/2.2 kΩ
Monitor Out	Video: Composite Video 1 Vp-p/75 Ω/negative Audio: 500 mVrms (100% modulation/Less than 1 kΩ)
Audio output	30 W (15 W + 15 W)
Power supply	120 V AC, 60Hz
Power consumption	290 W
Dimensions	56 ²¹ / ₃₂ " (W) × 57 ⁷ / ₈ " (H) × 28 ⁴⁵ / ₆₄ " (D) [1439 mm (W) × 1470 mm (H) × 729 mm (D)]
Weight	298lbs (135.2 kg)

Using the Video and Audio Input Jacks

■ Connecting video equipment for video playback

- When the television is connected to video equipment as shown below, the material being played back on the video equipment can be seen on the television screen.

Connecting a video device equipped with a video output terminal

(Front terminals of Rear Projection TV)

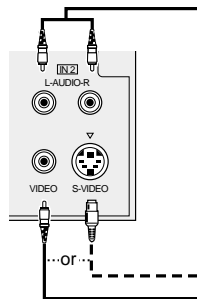

When noise or distortion appears on TV caused by connecting a video game machine, select the other setting of the DDFC mode (See page 58).

VIDEO EQUIPMENTS

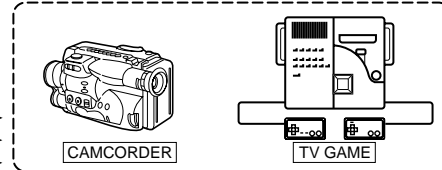

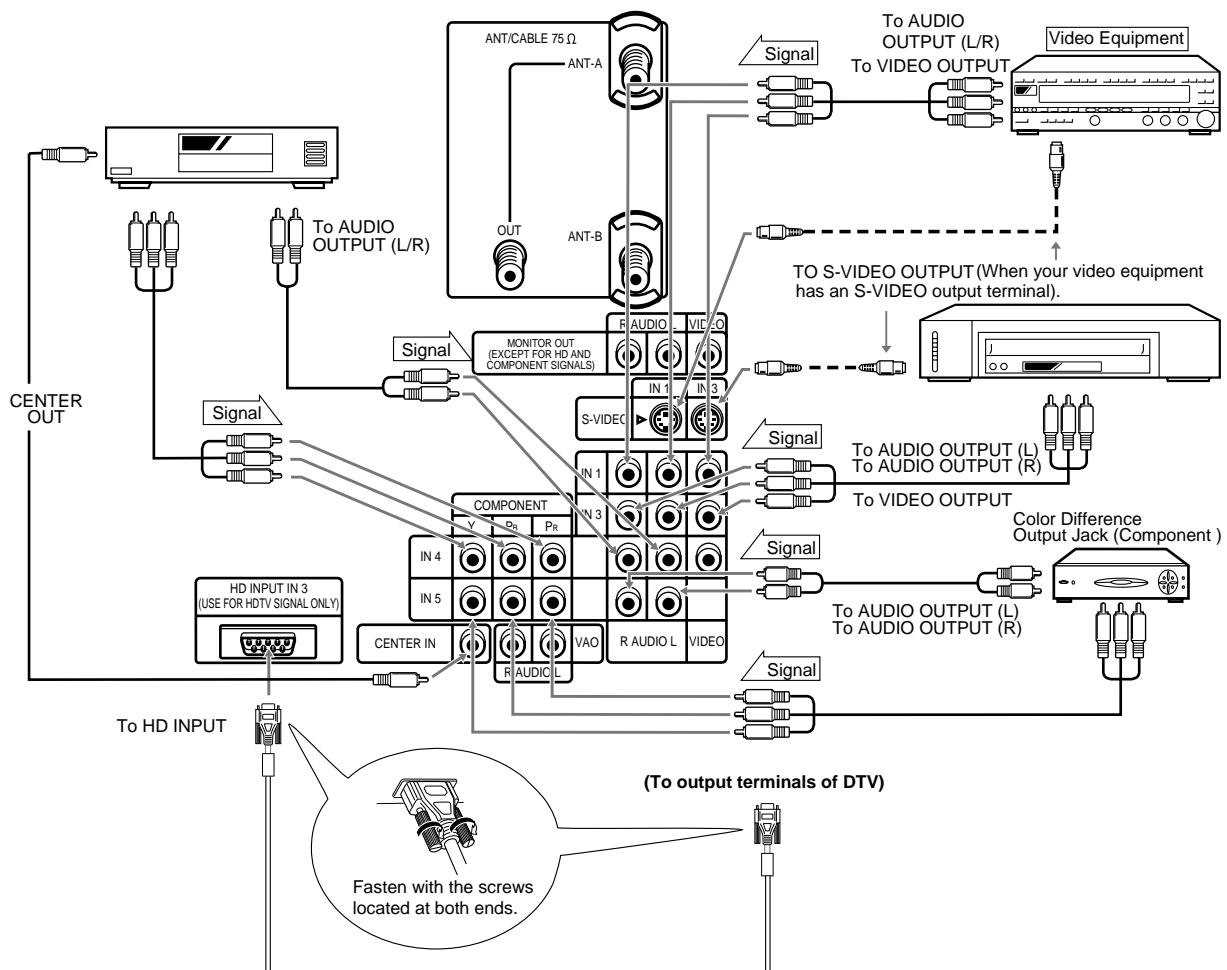

- The S-VIDEO INPUT terminals offer a higher quality image by accepting the image signal separated into color and brightness signals.
- S-VIDEO INPUT terminals are for video signals only. The audio signals are connected to either IN 1 or IN 3 AUDIO terminals (left and right).

(Rear terminals of Rear Projection TV)





Using the Video and Audio Input Jacks (Continued)

■ Video playback

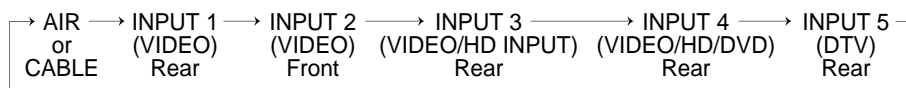
- Press the remote's  to select the VIDEO INPUT mode to which the video equipment you want to play back is connected.
- The external VIDEO INPUT mode will change as follows each time  is pressed.



- You can select INPUT mode by pressing  when the TV is set to the highest channel stored in memory, or by pressing  when it is set to the lowest channel.



Note

- When connecting video or audio equipment to the television, be sure that the power is turned off in order to prevent damage to either the television or the equipment being connected.
- An S-VIDEO terminal has priority over its corresponding VIDEO terminal. When you want to watch pictures from video equipment connected to a VIDEO terminal, unplug equipment connected to the corresponding S-VIDEO terminal.
- It is the intent of Marantz that this product be used in full compliance with the copyright laws of the United States and that prior permission be obtained from copyright owners whenever necessary.
- For detailed information on the connection and use of auxiliary equipment, refer to the instruction manuals of the equipment being used.
- Connection cables can be obtained from your local video store.

Using the Audio Output Jacks

These jacks are used for connecting a standard studio amplifier. Control of STEREO/MONO/SAP, BASS, TREBLE, BALANCE, VOLUME and MUTE is retained at the Rear Projection TV. These jacks relay the audio signals of all programs being displayed on the Rear Projection TV screen.

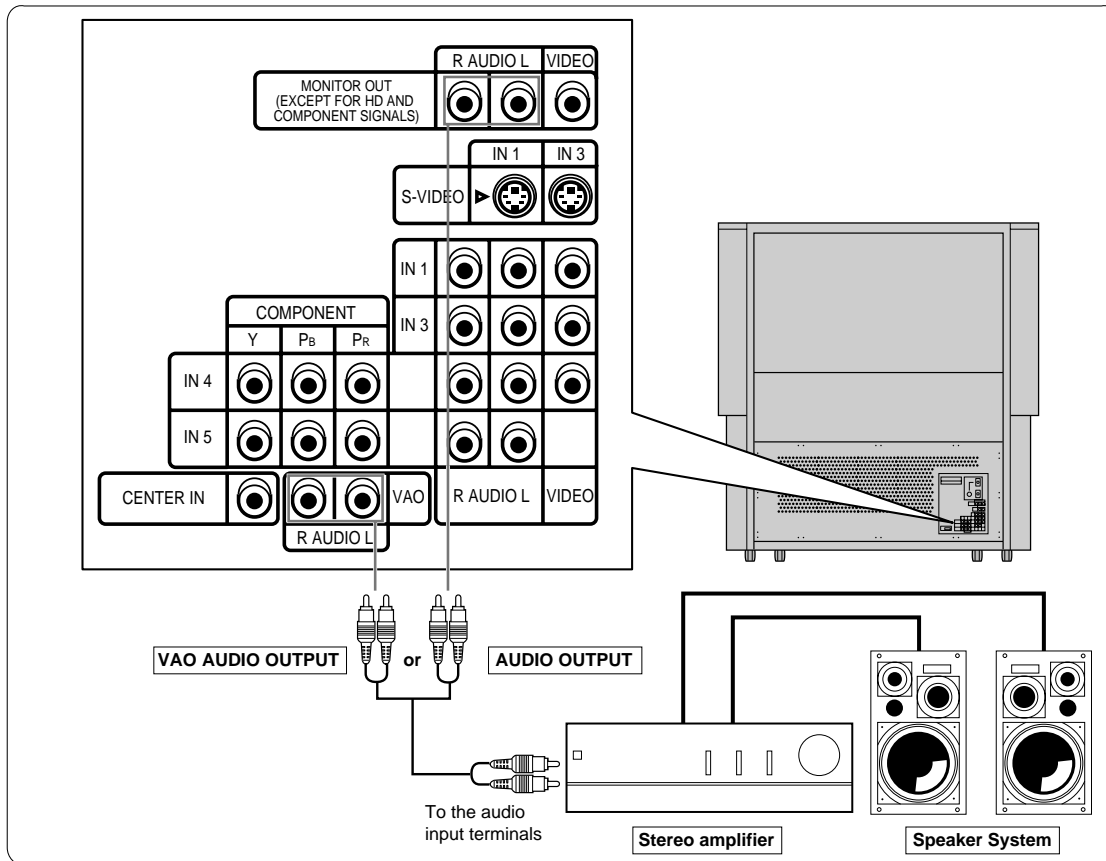

- (1) Before connecting the cable, turn on the Rear Projection TV and adjust the VOLUME control on the TV for a moderate listening level.
- (2) Turn off the Rear Projection TV and connect the audio cord to the AUDIO OUTPUT or VAO AUDIO out JACKS on the Rear Projection TV.
- (3) Turn the Rear Projection TV and stereo amplifier on.
- (4) To change SPEAKER settings, see page 29. To check SPEAKER connections, see page 70.
- (5) Adjust the VOLUME control on the stereo amplifier as desired.
- (6) Control of the audio can be done using the audio controls (STEREO/MONO/SAP, VOLUME, EQUISOUND and MUTE), from either the remote control, or directly from the Rear Projection TV.

- For detailed information on the connection and use of auxiliary equipment, refer to the operation manuals of the equipment being used.
- When connecting monaural equipment to the AUDIO INPUT or OUTPUT of this set, use an audio connection cable and plug adapter as shown below.
- When using VAO terminals, for optimal sound quality, it is recommended to keep the Rear Projection TV's audio output level high.

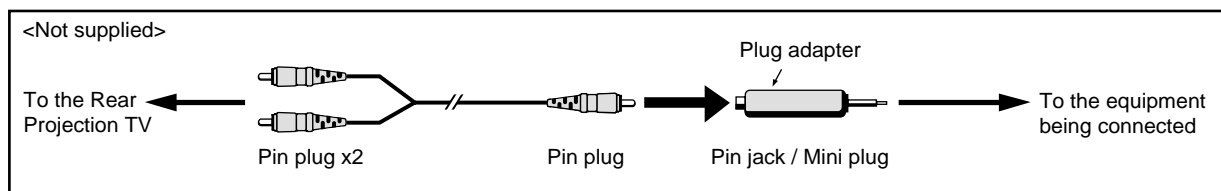

Before Calling for Service

Check these items and see if you can correct a problem with a slight adjustment of the controls.

QUICK SERVICE CHECK LIST		PROBLEM																
		No Playback of VCR and Disk Player	No Picture or Sound from External Video/Audio Products	Remote Control Does not Work	Bars On Screen	Picture Distorted	Picture Rolls Vertically	No Color	Poor Reception on Some Channels	Weak Picture	Lines or Streaks in Picture	Ghosts in Picture	Picture Blurred	Sound OK, Picture Poor	Picture OK, Sound Poor	No Picture or Sound	Dark and Blank Picture	External Electrical Noise Interfering with TV's Operation
POSSIBLE REMEDY																		
Try a new channel, if OK, then possible station trouble.						X	X	X	X	X	X	X	X	X	X	X		
Is Rear Projection TV plugged in? Power at outlet?			X	X													X	
Is Rear Projection TV's POWER button on?			X														X	
Is antenna connected to terminal on the back of the set?								X	X	X		X		X		X		
If outside antenna is being used, check for broken wire.					X	X	X	X	X	X	X	X	X	X		X		
Check for local interference or external electrical noise.					X		X		X		X	X		X	X			X
Turn off with POWER button and then turn it on after about a minute.			X														X	
Adjust COLOR control.								X										
Adjust PICTURE control.										X				X				
Check external Video/Audio products; look for loose / broken connections cables. (Refer to page 70.)		X	X											X	X	X		
Check the batteries of Remote Control.				X														
Are audio cables connected firmly? Check the volume level.																	X	
Is SP ON? See page 29.																	X	
Change Closed Caption mode to "OFF" / Energy Save mode to "OFF".																		X
Unplug the Rear Projection TV and plug it in again after 2 minutes.				X			X	X	X	X				X	X	X	X	X

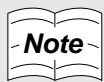

- When viewing in TEXT mode, if no TEXT broadcast is being received, the screen may become dark and blank. Should this occur, set the Closed Caption mode to "OFF".
- If your TV does not work normally in case of a power failure, turn the power off and then turn the power on again.

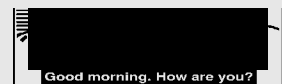

(Dark and Blank Picture)

Unidad Principal

Sección de control delantera

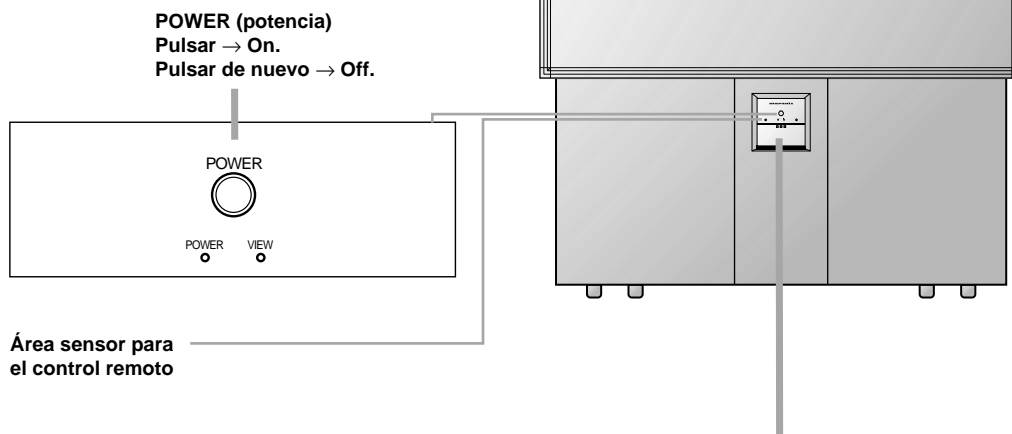

Para abrir la cubierta

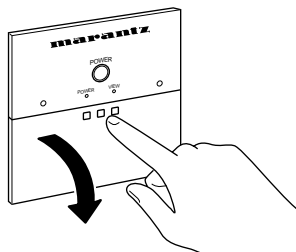

DETRÁS DE LA CUBIERTA

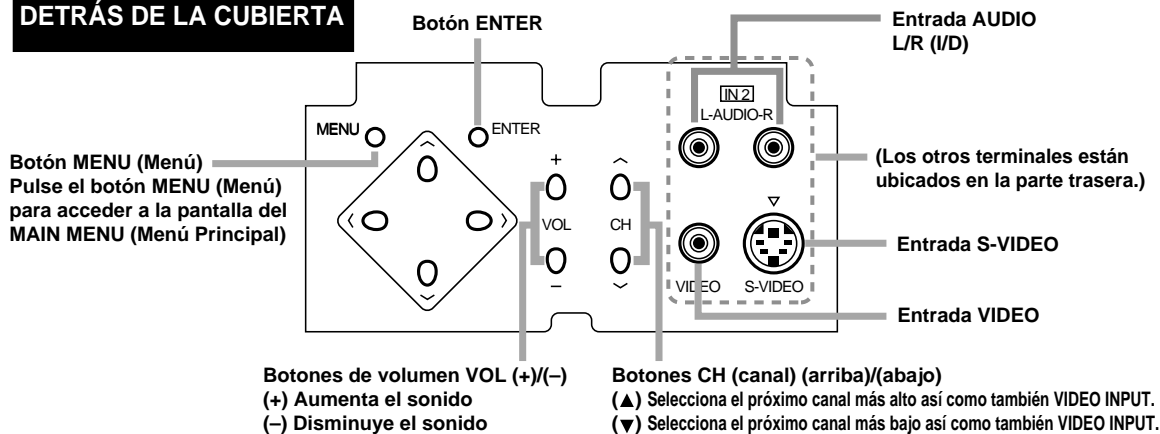

- Si el televisor de retroproyección no es usado por un largo período de tiempo, desactive la alimentación de la unidad principal para evitar que el televisor de retroproyección falle en su funcionamiento (por ej. si TV POWER se ajusta a ON durante un corte de luz, el estado del televisor de retroproyección antes del corte, TV POWER cambia a ON cuando se restaura la alimentación).

Funciones Básicas del Control Remoto

Este control remoto puede usarse para operar el televisor de retroproyección, una videograbadora, un decodificador DTV STB, un reproductor de video DVD y un convertidor de cable TV. Los botones que pueden usarse varían de acuerdo al dispositivo conectado. Para los detalles, refiérase a la página siguiente.

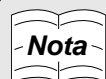
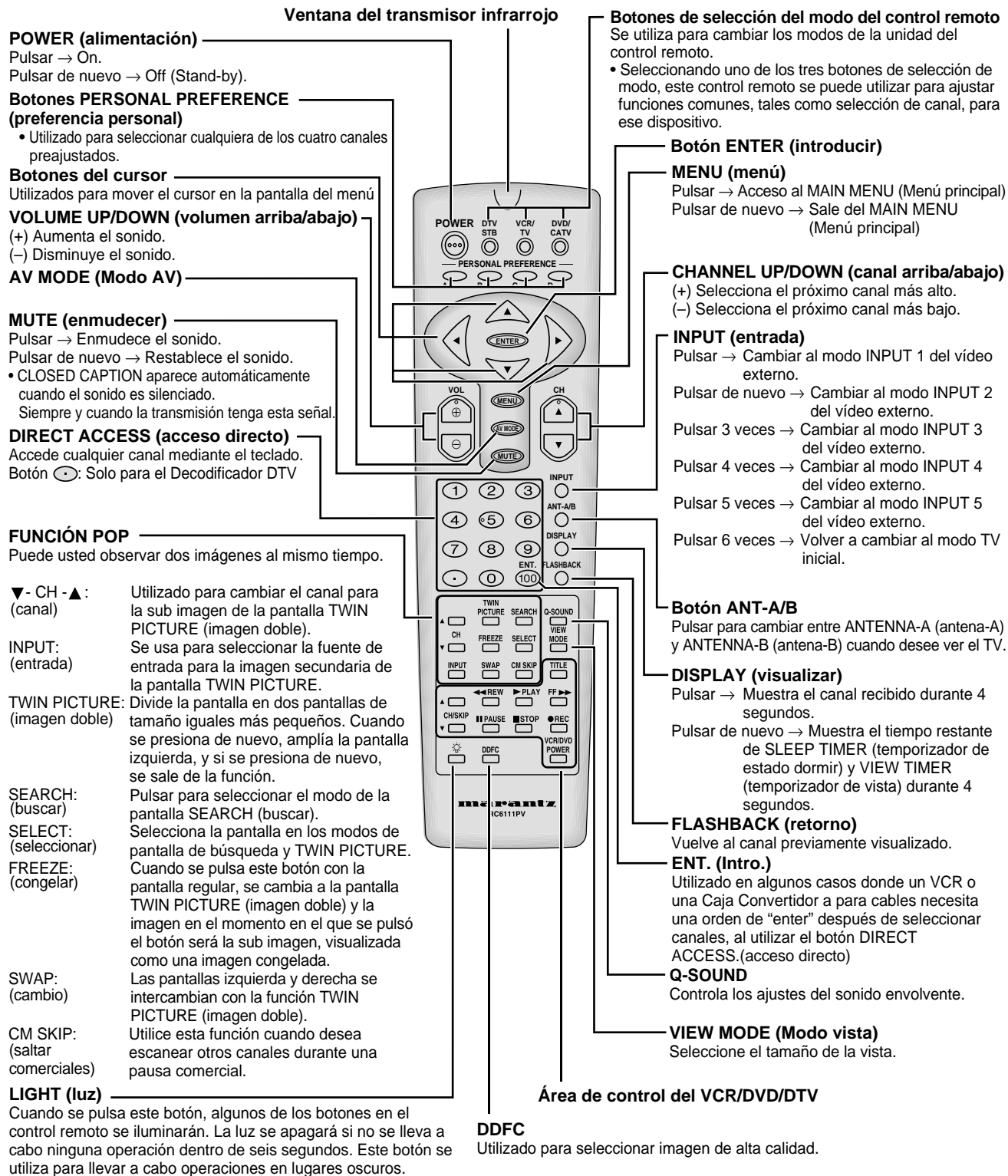

- El botón de iluminación en el control remoto se ilumina en la oscuridad. Para usar la visualización de iluminación en la oscuridad en el control remoto colóquelo bajo una luz fluorescente u otra iluminación.
- El material fosforescente no contiene material radioactivo o tóxico, su uso por lo tanto es seguro.
- El grado de iluminación variará dependiendo en la fuerza de la luz utilizada.
- El grado de iluminación disminuirá con el tiempo y dependiendo en la temperatura.
- El tiempo que se necesita para cargar la visualización fluorescente varía dependiendo en la luz alrededor.

Antes de llamar al Servicio de Reparaciones

Verifique los siguientes puntos para ver si puede solucionar el problema.

LISTA DE COMPROBACIONES DE SERVICIO RAPIDO	PROBLEMA																
	El vídeo o el reproductor de discos de video no reproduce imágenes	El equipo de video/audio externo no produce imagen ni sonido	El control remoto no funciona	Barras en la pantalla	Imagen distorsionada	La imagen se desplaza verticalmente	No hay color	Mala recepción de algunos canales	Imagen débil	Franjas en la imagen	Imagen fantasma	Imagen borrosa	Sonido adecuado, imagen mala	Sonido adecuado, sonido malo	No hay imagen ni sonido	Imagen oscura y en blanco	Interferencia de ruido eléctrico externo con el funcionamiento del televisor de retroproyección
POSIBLE SOLUCIÓN																	
Pruebe con otro canal y si todo está bien, el problema puede ser de la emisora.				X	X	X	X	X	X	X	X	X	X	X	X		
¿Está conectado el televisor de retroproyección? Llega electricidad al tomacorrientes?	X	X													X		
¿Está conectado el interruptor del televisor de retroproyección?	X														X		
¿Está conectado la antena al terminal del panel posterior del televisor?							X	X	X		X		X		X		
Si utiliza una antena exterior, asegurese de que el cable no esté dañado.				X	X	X	X	X	X	X	X	X	X		X		
Compruebe si hay interferencia local.				X		X		X		X	X		X	X			X
Desconecte el interruptor POWER y vuelva a conectarlo después de transcurrir un minuto.		X													X		
Adjuste el control de COLOR.							X										
Adjuste el control de MATIZ.									X				X				
Verifique los productos externos de Video/Audio, revise si hay gufas de conexiones sueltas o rotas.	X	X											X	X	X		
Compruebe el estado de las pilas del control remoto.			X														
Están bien conectados los cables de sonido? Compruebe el nivel del volumen.															X		
¿Está la función SP en ON (activada)?															X		
Desactive (OFF) el modo CLOSED CAPTION / Desactive (OFF) el modo Ahorro de Energía (Energy Save).																X	
Desenchufe el televisor de retroproyección y vuelva a enchufarlo después de dos minutos.			X			X	X	X	X				X	X	X	X	X

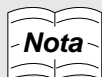

- Cuando se ve en modo TEXTO sin recibir emisiones de TEXTO, la pantalla puede ponerse en blanco y negro. Si ocurriera ésto, ponga el modo CLOSED CAPTION en OFF.
- Si su televisor no funciona normalmente en caso de corte de energía eléctrica, apague el televisor y vuelva a encenderlo otra vez.

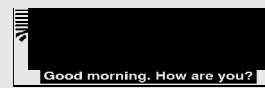

(Imagen oscura y en blanco)

Unité Principale

Commandes avant

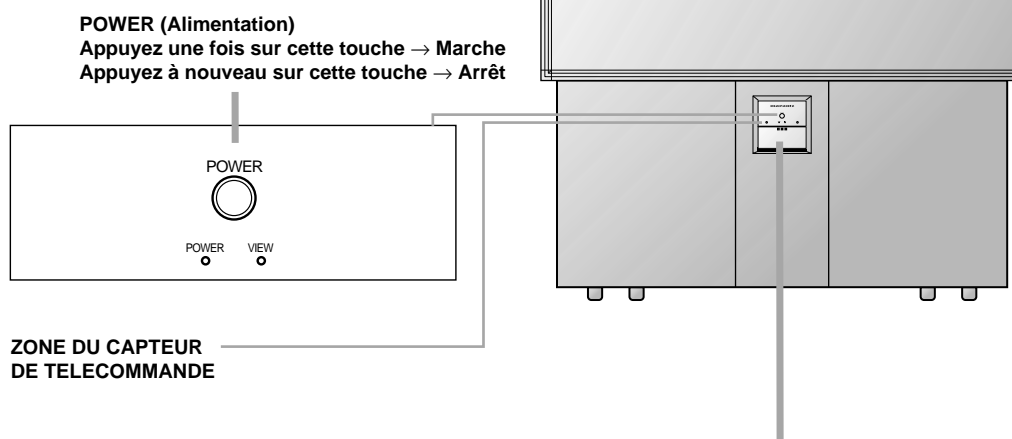

Pour ouvrir le couvercle

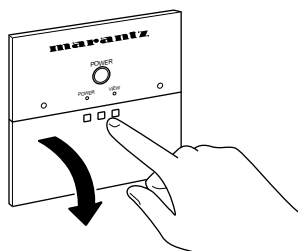

Derrière le couvercle

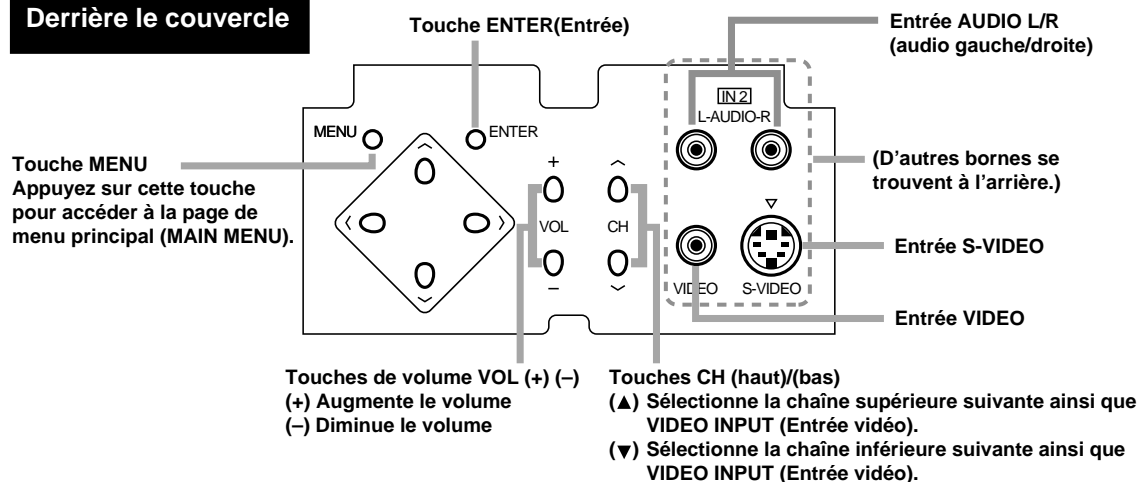

- Si le téléviseur à rétroprojection n'est pas utilisé pendant longtemps ou lors d'une panne de courant, réglez la touche POWER de l'unité principale sur Arrêt (OFF) pour éviter un mauvais fonctionnement du téléviseur. (Par exemple, si la touche POWER du téléviseur est réglée sur Marche (ON) pendant une panne de courant, le téléviseur à rétroprojection reste dans l'état d'avant la panne de courant et le téléviseur est mis sous tension (ON) lorsque le courant est rétabli.

Fonctions de Base de la Télécommande

Cette télécommande peut être utilisée pour faire fonctionner le téléviseur à rétroprojection, un magnétoscope, un décodeur DTV STB, un lecteur vidéo DVD et un convertisseur de télévision par câble. Les touches utilisables varient selon l'appareil utilisé. Consultez la page suivante pour les détails.

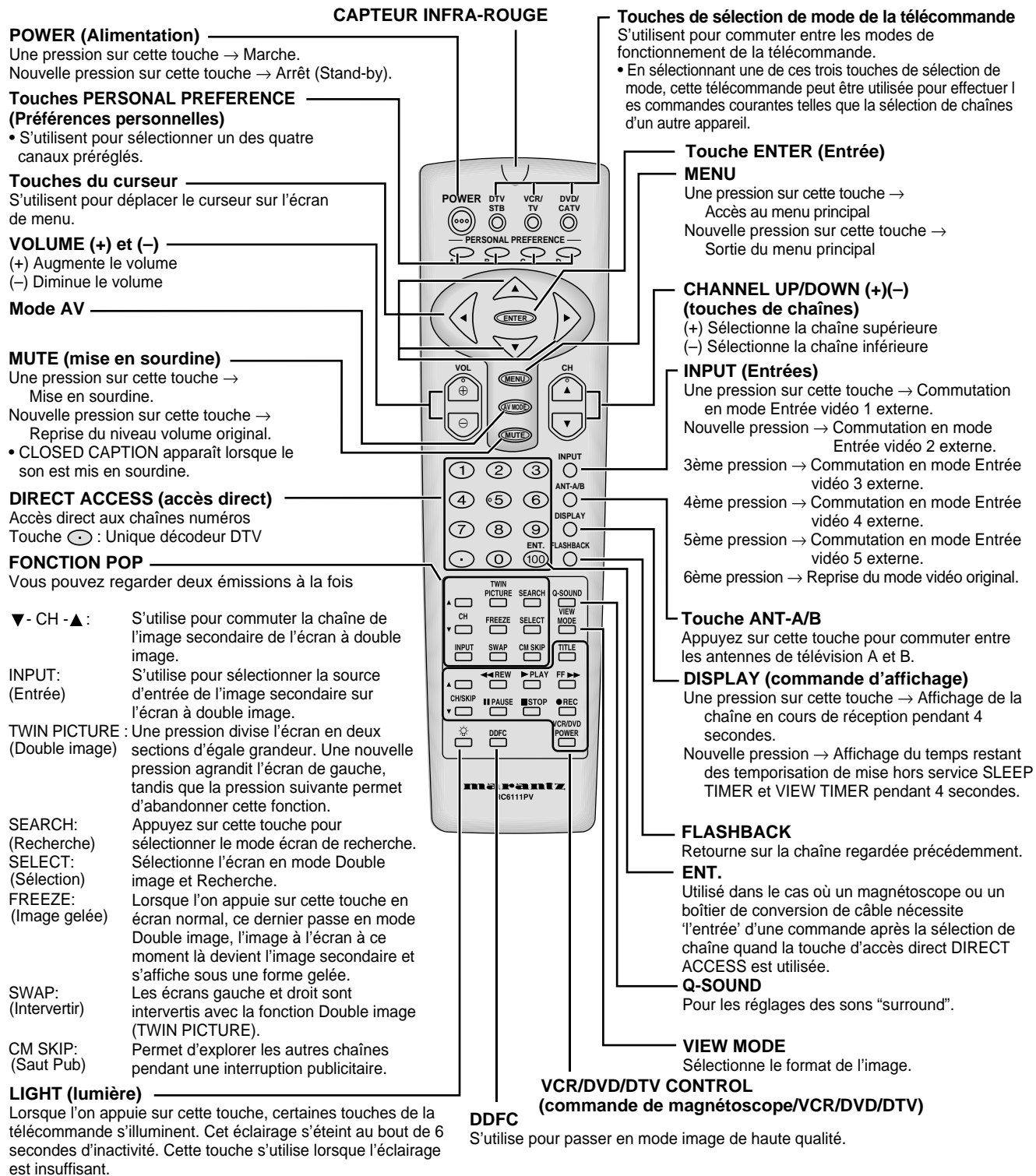

- Les touches claires sur la télécommande luisent dans l'obscurité. Pour utiliser l'éclairage phosphorescent de la télécommande, placez celle-ci sous une lampe fluorescente ou un autre éclairage.
- Les matériaux phosphorescents employés ne contiennent pas de produit radioactif ou toxique et cette télécommande peut être utilisée sans crainte.
- Le degré d'illumination dépend de l'intensité de la source de lumière utilisée.
- Le degré d'illumination diminue dans le temps en fonction aussi de la température.
- Le temps de rechargement de l'affichage phosphorescent varie suivant la source de lumière.

Avant de faire appel au Service Après-vente

Vérifiez les points suivants pour voir s'il n'est pas possible de résoudre le problème par un simple ajustement des commandes.

LISTE DE VÉRIFICATION RAPIDE	PROBLÈME																
	Pas de lecture par le magnétoscope et le lecteur de disque	Absence d'image et de sons des dispositifs audio/vidéo externes	La télécommande ne fonctionne pas	Barres sur l'écran	Distorsion d'image	Défilement vertical de l'image	Absence de couleur	Mauvaise réception de certaines chaînes	Image faible	Lignes ou striés sur l'image	Fantômes sur l'image	Image floue	Son normal, mais image défectueuse	Image normale, mais son défectueux	Absence d'image et de son	Image sombre ou vierge	Bruits électriques externes gênant le fonctionnement du téléviseur à rétroprojection
CORRECTION POSSIBLE																	
Essayer une autre chaîne. Si normal, panne possible de station.					X	X	X	X	X	X	X	X	X	X	X		
Le téléviseur à rétroprojection est-il branché? Prise secteur sous tension?		X	X													X	
La touche POWER du téléviseur à rétroprojection est-elle allumée?		X														X	
L'antenne est-elle branchée sur la borne à l'arrière de l'appareil?							X	X	X		X		X		X		
Si une antenne extérieure est utilisée, s'assurer que son fil n'est pas cassé.				X	X	X	X	X	X	X	X	X	X		X		
Vérifier la présence d'interférences locales ou de bruits électriques externes.				X		X		X		X	X		X	X			X
Mettre hors tension par la touche POWER et remettre sous tension après une minute environ.		X														X	
Ajuster la commande COLOR.							X										
Ajuster la commande PICTURE.									X				X				
Vérifier les dispositifs audio/vidéo externes. S'assurer que les fils de branchement ne sont pas détachés ou cassés.	X	X											X	X	X		
Vérifier les piles de la télécommande.			X														
Les cordons audio sont-ils fermement branchés? Vérifier le niveau du volume.																X	
La touche SP est-elle sur ON?																X	
Changer le mode Closed Caption à "OFF" / mode Economie d'énergie à "OFF".																	X
Débrancher le téléviseur à rétroprojection et le rebrancher 2 minutes plus tard.			X			X	X	X	X				X	X	X	X	X



- A l'emploi du mode TEXTE, si une émission TEXTE n'est pas reçue, l'écran peut devenir sombre ou vierge. Dans ce cas, désactivez (OFF) le mode Closed Caption.
- Si le téléviseur ne fonctionne pas normalement après une panne de courant, mettez-le hors tension, puis à nouveau sous tension.

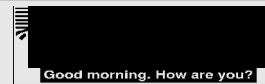

(Image en noir et blanc)

DIMENSIONS FOR INSTALLATION

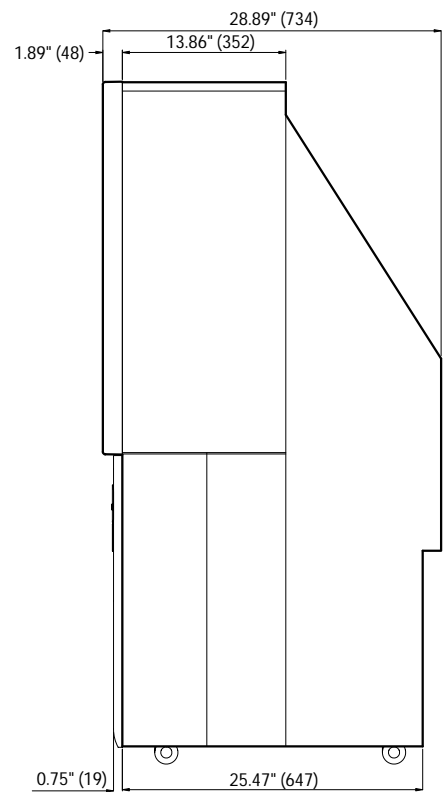
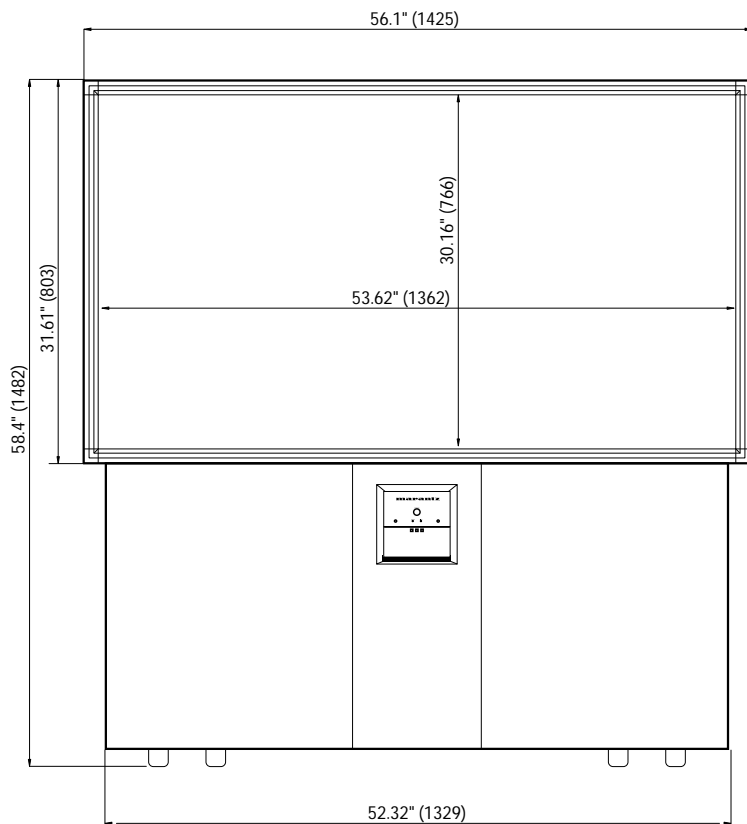
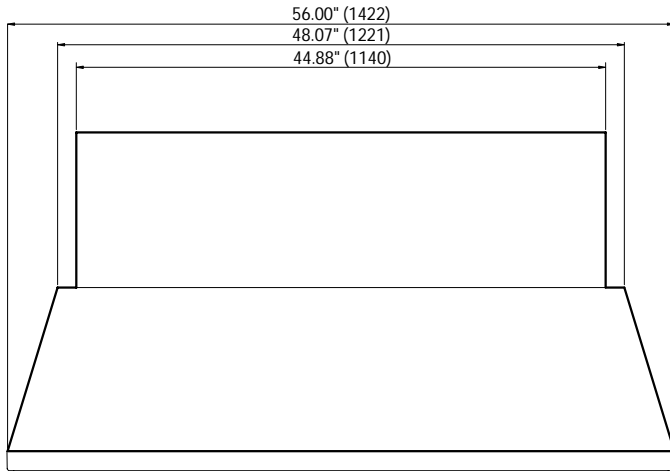

PV6111W
 DIMENSIONS SHOWN AS
 INCHES (MM)

NOTES

NOTES

NOTES



Limited Warranty for the Marantz Rear Projection Television

Who is covered?

You must have proof of purchase to receive warranty service.

What is covered?

- 1) Warranty coverage begins the day you purchase your Rear Projection Television, and continues for a period of one year.
- 2) Marantz America will incur all labor charges for repairs during the warranty period.
- 3) Marantz America will incur all freight charges for warranty repairs, both to Marantz and the return to the customer.

We suggest keeping all packing materials for any shipping that might be required.

4) All parts, including repaired and replaced parts are covered only for the original warranty period. When the warranty on the product expires, the warranty on all replaced and repaired parts also expires.

What is excluded?

Your warranty does not cover:

- 1) Labor charges for installation or setup of the product, cleaning, adjustment of customer controls on the product, and installation or repair of antenna systems outside of the product.
- 2) Improper installation, removal or maintenance, or failure to follow instructions supplied with the product.
- 3) Reception problems caused by signal conditions from cable or antenna systems outside the product.
- 4) Burn in and or phosphor damage, due to the display of still images.
- 5) Repair, attempted repair or modification performed by anyone other than an authorized Marantz America service center.
- 6) Any product, on which the serial number has been defaced, modified or removed.
- 7) Warranty is void if purchase was made from anyone other than an authorized Marantz dealer.**
- 8) Warranty is void if purchased from outside The United States of America or Canada.
- 9) Warranty only valid in the United States of America and Canada.
- 10) Damage due to lightning or power line surges, spikes and brown outs, damages that occur during shipping or transit, or damage which is attributed to acts of God.
- 11) Incidental or consequential damages resulting from the product. (Some states do not allow the exclusion of incidental or consequential damages, so the above exclusion may not apply to you. This warranty gives you specific legal rights, and you may also have other rights that vary from state to state.)
- 12) Commercial or institutional use.
- 13) Any other causes which does not relate to product defect.

Before requesting service:

Please check your owner's manual before requesting service. Adjustments of the controls and hook up guidelines discussed there may save you a service call.

To get warranty service:

Repair must be performed by an authorized service center. If you do not know of a Marantz authorized Television service center, contact your dealer. If your dealer is an authorized service center, they will arrange for repair. If your dealer is not a Marantz authorized Television service center, they will direct you to an authorized service center.

Free Manuals Download Website

<http://myh66.com>

<http://usermanuals.us>

<http://www.somanuals.com>

<http://www.4manuals.cc>

<http://www.manual-lib.com>

<http://www.404manual.com>

<http://www.luxmanual.com>

<http://aubethermostatmanual.com>

Golf course search by state

<http://golfingnear.com>

Email search by domain

<http://emailbydomain.com>

Auto manuals search

<http://auto.somanuals.com>

TV manuals search

<http://tv.somanuals.com>