

marantz®

Model SM-11S1 User Guide

Stereo Power Amplifier

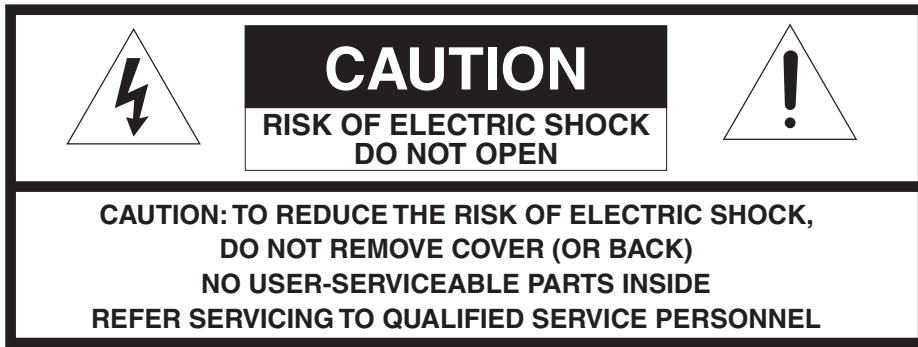

The lightning flash with arrowhead symbol within an equilateral triangle is intended to alert the user to the presence of uninsulated “dangerous voltage” within the product’s enclosure that may be of sufficient magnitude to constitute a risk of electric shock to persons.



The exclamation point within an equilateral triangle is intended to alert the user to the presence of important operating and maintenance (servicing) instructions in the literature accompanying the product.

WARNING

TO REDUCE THE RISK OF FIRE OR ELECTRIC SHOCK, DO NOT EXPOSE THIS APPLIANCE TO RAIN OR MOISTURE.

CAUTION: TO PREVENT ELECTRIC SHOCK, MATCH WIDE BLADE OF PLUG TO WIDE SLOT, FULLY INSERT.

ATTENTION: POUR EVITER LES CHOCS ELECTRIQUES, INTRODUIRE LA LAME LA PLUS LARGE DE LA FICHE DANS LA BORNE CORRESPONDANTE DE LA PRISE ET POUSSER JUSQU'AU FOND.

IMPORTANT SAFETY INSTRUCTIONS

READ BEFORE OPERATING EQUIPMENT

This product was designed and manufactured to meet strict quality and safety standards. There are, however, some installation and operation precautions which you should be particularly aware of.

1. Read these instructions.
2. Keep these instructions.
3. Heed all warnings.
4. Follow all instructions.
5. Do not use this apparatus near water.
6. Clean only with dry cloth.
7. Do not block any ventilation openings. Install in accordance with the manufacture's instructions.
8. Do not install near any heat sources such as radiators, heat registers, stoves, or other apparatus (including amplifiers) that produce heat.
9. Do not defeat the safety purpose of the polarized or grounding-type plug. A polarized plug has two blades with one wider than the other. A grounding type plug has two blades and a third grounding prong. The wide blade or the third prong are provided for your safety. If the provided plug does not fit into your outlet, consult an electrician for replacement of the obsolete outlet.



10. Protect the power cord from being walked on or pinched particularly at plugs, convenience receptacles, and the point where they exit from the apparatus.
11. Only use attachments/accessories specified by the manufacturer.
12. Use only with the cart, stand, tripod, bracket, or table specified by the manufacturer, or sold with the apparatus. When a cart is used, use caution when moving the cart/apparatus combination to avoid injury from tip-over.
13. Unplug this apparatus during lightning storms or when unused for long periods of time.
14. Refer all servicing to qualified service personnel. Servicing is required when the apparatus has been damaged in any way, such as power-supply cord or plug is damaged, liquid has been spilled or objects have fallen into the apparatus, the apparatus has been exposed to rain or moisture, does not operate normally, or has been dropped.

Additional Safety Information!

- This product should not be placed in a built-in installation such as a bookcase or rack unless proper ventilation is provided or the manufacturer's instructions have been adhered to.
- Apparatus shall not be exposed to dripping or splashing and that no objects filled with liquids, such as vases, shall be placed on the apparatus.
- When the switch is in the OFF position, the apparatus isn't completely switched-off from the MAINS.
- The equipment shall be installed near the Socket-Outlet and shall be easily accessible.

Do not touch hot spots during and immediately after use.

During and immediately after use, this product is hot in areas other than the controls and rear panel connection jacks. Do not touch hot spots and especially the top panel. Contact with hot areas can cause burns.

Do not expose the unit to excessive heat such as direct sunlight, fire or the like.

AMP_070719U2

ENGLISH

WARRANTY

For warranty information, contact your local Marantz distributor.

RETAIN YOUR PURCHASE RECEIPT

Your purchase receipt is your permanent record of a valuable purchase. It should be kept in a safe place to be referred to as necessary for insurance purposes or when corresponding with Marantz.

IMPORTANT

When seeking warranty service, it is the responsibility of the consumer to establish proof and date of purchase. Your purchase receipt or invoice is adequate for such proof.

FOR U.K. ONLY

This undertaking is in addition to a consumer's statutory rights and does not affect those rights in any way.

FRANÇAIS

GARANTIE

Pour des informations sur la garantie, contacter le distributeur local Marantz.

CONSERVER L'ATTESTATION D'ACHAT

L'attestation d'achat est la preuve permanente d'un achat de valeur. La conserver en lieu sûr pour s'y reporter aux fins d'obtention d'une couverture d'assurance ou dans le cadre de correspondances avec Marantz.

IMPORTANT

Pour l'obtention d'un service couvert par la garantie, il incombe au client d'établir la preuve de l'achat et d'en corroborer la date. Le reçu ou la facture constituent des preuves suffisantes.

DEUTSCH

GARANTIE

Bei Garantiefragen wenden Sie sich bitte an Ihren Marantz-Händler.

HEBEN SIE IHRE QUITTING GUT AUF

Die Quittung dient Ihnen als bleibende Unterlage für Ihren wertvollen Einkauf. Das Aufbewahren der Quittung ist wichtig, da die darin enthaltenen Angaben für Versicherungszwecke oder bei Korrespondenz mit Marantz angeführt werden müssen.

WICHTIG!

Bei Garantiefragen muß der Kunde eine Kaufunterlage mit Kaufdatum vorlegen. Ihre Quittung oder Rechnung ist als Unterlage ausreichend.

NEDERLANDS

GARANTIE

Voor inlichtingen omtrent garantie dient u zich tot uw plaatselijke Marantz.

UW KWITANTIE, KASSABON E.D. BEWAREN

Uw kwitantie, kassabon e.d. vormen uw bewijs van aankoop van een waardevol artikel en dienen op een veilige plaats bewaard te worden voor evt. verwijzing bijv. in verband met verzekering of bij correspondentie met Marantz.

BELANGRIJK

Bij een evt. beroep op de garantie is het de verantwoordelijkheid van de consument een gedateerd bewijs van aankoop te tonen. Uw kassabon of factuur zijn voldoende bewijs.

ITALIANO

GARANZIA

L'apparecchio è coperto da una garanzia di buon funzionamento della durata di un anno, o del periodo previsto dalla legge, a partire dalla data di acquisto comprovata da un documento attestante il nominativo del Rivenditore e la data di vendita. La garanzia sarà prestata con la sostituzione o la riparazione gratuita delle parti difettose.

Non sono coperti da garanzia difetti derivanti da uso improprio, errata installazione, manutenzione effettuata da personale non autorizzato o, comunque, da circostanze che non possano riferirsi a difetti di funzionamento dell'apparecchio. Sono inoltre esclusi dalla garanzia gli interventi inerenti l'installazione e l'allacciamento agli impianti di alimentazione.

Gli apparecchi verranno riparati presso i nostri Centri di Assistenza Autorizzati. Le spese ed i rischi di trasporto sono a carico del cliente.

La casa costruttrice declina ogni responsabilità per danni diretti o indiretti provocati dalla inosservanza delle prescrizioni di installazione, uso e manutenzione dettagliate nel presente manuale o per guasti dovuti ad uso continuato a fini professionali.

CE MARKING

CE English

The SM-11S1 is in conformity with the EMC directive and low-voltage directive.

CE Français

Le SM-11S1 est conforme à la directive EMC et à la directive sur les basses tensions.

CE Deutsch

Das Modell SM-11S1 entspricht den EMC-Richtlinien und den Richtlinien für Niederspannungsgeräte.

CE Nederlands

De SM-11S1 voldoet aan de EMC eisen en de vereisten voor laag-voltage.

CE Italiano

Il SM-11S1 è conforme alle direttive CEE ed a quelle per i bassi voltaggi.

English

WARNINGS

- Do not expose the equipment to rain, moisture, dripping or splashing.
- Do not remove the cover from the equipment.
- Do not insert anything into the equipment through the ventilation holes.
- Do not handle the mains cord with wet hands.
- Do not cover the ventilation with any items such as tablecloths, newspapers, curtains, etc.
- No naked flame sources, such as lighted candles, should be placed on the equipment.
- When disposing of used batteries, please comply with governmental regulations or environmental public instruction's rules that apply in your country or area.
- Make a space of about 0.2 meter around the unit.
- No objects filled with liquids, such as vases, shall be placed on the equipment.
- When the switch is in the OFF position, the equipment is not completely switched off from MAINS.
- The equipment shall be installed near the power supply so that the power supply is easily accessible.
- Do not touch hot spots during and immediately after use.
- During and immediately after use, this product is hot in areas other than the controls and rear panel connection jacks. Do not touch hot spots and especially the top panel. Contact with hot areas can cause burns.
- Do not expose the unit to excessive heat such as direct sunlight, fire or the like.

Français

AVERTISSEMENTS

- Ne pas exposer l'appareil à la pluie, à l'humidité, à l'égouttement ou aux éclaboussures.
- Ne pas essayer de retirer le boîtier de l'appareil.
- Ne rien insérer dans l'appareil par les orifices de ventilation.
- Ne pas manipuler le cordon d'alimentation avec les mains mouillées.
- Ne pas recouvrir les ouïes de ventilation avec un objet quelconque comme une nappe, un journal, un rideau, etc.
- Ne placer aucune source de flamme nue, comme une bougie allumée, sur l'appareil.
- Pour mettre au rebut les piles usées, respecter les lois gouvernementales ou les règlements officiels concernant l'environnement qui s'appliquent à votre pays ou région.
- Veiller à ce qu'aucun objet ne soit à moins de 0,2 mètre des côtés de l'appareil.
- Aucun objet rempli de liquide, un vase par exemple, ne doit être placé sur l'appareil.
- Lorsque l'interrupteur est sur la position OFF, l'appareil n'est pas complètement déconnecté du SECTEUR (MAINS).
- L'appareil sera installé près de la source d'alimentation, de sorte que cette dernière soit facilement accessible.
- Ne pas toucher aux zones chaudes pendant et immédiatement après l'utilisation.
- Pendant l'utilisation et immédiatement après, cet appareil est chaud en dehors des commandes et des prises de raccordement arrière. Ne pas toucher aux zones chaudes, et particulièrement au panneau supérieur, pour éviter tout risque de brûlure.
- Ne pas exposer l'appareil à une chaleur excessive, comme celle des rayons directs du soleil, d'un feu, etc.

Deutsch

WARNHINWEISE

- Das Gerät nicht Regen, Feuchtigkeit, Tropf- oder Spritzwasser aussetzen.
- Die Abdeckung nicht vom Gerät abnehmen.
- Keine Gegenstände durch die Belüftungsschlitze stecken.
- Das Netzkabel nicht mit feuchten oder nassen Händen anfassen.
- Decken Sie die Lüftungsöffnungen nicht mit einem Tischtuch, einer Zeitung, einem Vorhang usw. ab.
- Es dürfen keine Gegenstände mit offener Flamme, wie etwa brennende Kerzen, auf dem Gerät aufgestellt werden.
- Beachten Sie bei der Entsorgung der verbrauchten Batterien alle geltenden lokalen und überregionalen Regelungen.
- Auf allen Geräteseiten muß ein Zwischenraum von ungefähr 0,2 meter vorhanden sein.
- Auf das Gerät dürfen keine mit Flüssigkeiten gefüllte Behälter, wie etwa eine Vase, gestellt werden.
- Wenn der Schalter ausgeschaltet ist (OFF-Position), ist das Gerät nicht vollständig vom Stromnetz (MAINS) abgetrennt.
- Das Gerät sollte in der Nähe einer Netzsteckdose aufgestellt werden, damit es leicht an das Stromnetz angeschlossen werden kann.
- Berühren Sie während oder unmittelbar nach dem Gebrauch keine heißen Stellen des Gerätes.
- Während oder unmittelbar nach dem Gebrauch ist dieses Produkt mit Ausnahme der Bedienelemente und der Anschlussbuchsen auf der Rückseite heiß. Berühren Sie die heißen Stellen und insbesondere die Oberseite nicht. Der Kontakt mit heißen Flächen kann zu Verbrennungen führen.
- Setzen Sie das Gerät keiner übermäßigen Wärme aus, z.B. durch Aufstellung in direkter Sonneneinstrahlung, in der Nähe eines offenen Feuers usw.

Nederlands

WAARSCHUWINGEN

- Stel het apparaat niet bloot aan regen, vocht, druppels of spetters.
- Verwijder de afdekplaat van het apparaat niet.
- Duw niets door de ventilatieopeningen in het apparaat.
- Raak het netsnoer niet met natte handen aan.
- Bedek de ventilatieopeningen niet met enige voorwerpen, zoals tafelkleden, kranten, gordijnen, enz.
- Plaats geen brandende voorwerpen, zoals kaarsen, op het apparaat.
- Volg bij het weggooien van verbruikte batterijen de overheidswetgeving of milieuvoorschriften op die van kracht zijn in het land of de regio waarin u zich bevindt.
- Zorg dat er 0,2 meter vrije ruimte rond het toestel is.
- Plaats geen voorwerpen met een vloeistof erin, zoals een bloemenvaas, op het apparaat.
- Als de schakelaar op OFF staat, is het apparaat niet volledig losgekoppeld van de netspanning (MAINS).
- De apparatuur wordt in de buurt van het stopcontact geïnstalleerd, zodat dit altijd gemakkelijk toegankelijk is.
- Raak hete gedeelten van het apparaat niet aan tijdens en onmiddellijk na het gebruik.
- Tijdens en onmiddellijk na het gebruik is dit product heet, behalve in de omgeving van de bedieningstoetsen en de aansluitingen op het achterpaneel. Raak geen hete plekken aan, vooral niet het bovenpaneel. Contact met hete plekken kan brandwonden veroorzaken.
- Stel het apparaat niet bloot aan grote warmte, zoals direct zonlicht, vuur en dergelijke.

Italiano

AVVERTENZE

- Non esporre l'apparecchio alla pioggia, all'umidità, al gocciolamento o agli spruzzi.
- Non rimuovere il coperchio dell'apparecchio.
- Non introdurre oggetti all'interno dell'apparecchio attraverso i fori di ventilazione.
- Non toccare il cavo di alimentazione con le mani bagnate.
- Non coprire le fessure di ventilazione con tovaglie, giornali, tende od oggetti analoghi.
- Non posare sull'apparecchio sorgenti di fiamme scoperte quali candele accese.
- Smaltire le pile usate in conformità alle norme governative o disposizioni ambientali vigenti nel proprio paese o zona.
- Lasciare 0,2 metro liberi tutto intorno l'unità.
- Non mettere sull'apparecchiatura alcun contenitore di liquido, come ad esempio dei vasi.
- Quando l'interruttore è nella posizione OFF, l'apparecchiatura non è completamente scollegata da MAINS.
- L'apparecchio va installato in prossimità della fonte di alimentazione, in modo che quest'ultima sia facilmente accessibile.
- Non toccare i punti caldi né durante, né immediatamente dopo l'uso.
- Durante, e subito dopo l'utilizzo, questo prodotto risulta essere molto caldo in alcune sue parti come ad esempio i connettori del pannello posteriore. Non toccare i punti caldi e specialmente la superficie del pannello. Il contatto con parti calde può provocare ustioni.
- Non esporre l'unità ad eccessivo calore come la luce diretta del sole, il fuoco o simili.

Thank you for purchasing this Marantz SM-11S1 Stereo Power Amplifier.

Please read these operating instructions carefully. We recommend that you read the entire user guide before you attempt to connect or operate the player.

After you have reviewed the contents of this manual, we suggest that you make all system connections before you attempt to operate the unit.

■ Checking the accessories

After opening the cover of the packing box, check that the following accessories are included.

- **AC Power cord**
SM-11S1 (U.S.A.)

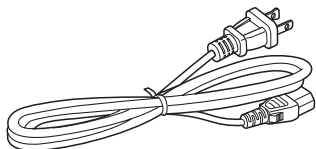

SM-11S1 (Europe)

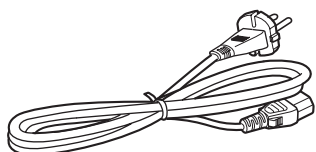

- **User Guide**
- **Warranty Card (U.S.A)**
(U.S.A. x 1, Canada x 1)

A NOTE ABOUT RECYCLING



This product's packaging materials are recyclable and can be reused. This product and the accessories packed together are the applicable product to the WEEE directive except batteries. Please dispose of any materials in accordance with your local recycling regulations. When discarding the unit, comply with your local rules or regulations. Batteries should never be thrown away or incinerated but disposed of in accordance with your local regulations concerning chemical wastes.

CONTENTS

FEATURES 2

BEFORE USING 3

 EQUIPMENT MAINS WORKING SETTING 3

 COPYRIGHT 3

 INAPPROPRIATE PLACES FOR INSTALLATION 3

NAMES AND FUNCTIONS OF PARTS 4

 FRONT PANEL 4

 DISPLAY 5

 REAR PANEL 6

CONNECTIONS 7

 BALANCED JACKS 7

 WIRING SPEAKER CABLE 8

 SPEAKER POSITIONING FOR SUPER AUDIO MULTI-CHANNEL SOUND 17

 CONNECTING THE POWER SUPPLY 17

HOW TO USE AND SET FEATURES 18

 HOW TO USE THE METER MODE BUTTON (DIGITAL POWER METER) 18

 BALANCED INPUT/UNBALANCED INPUT GAIN SETTINGS 18

 AMP MODE 19

 HOW TO OPERATE THE SIDE ILLUMINATION 19

 REMOTE POWER CONTROL 20

TROUBLESHOOTING 21

SPECIFICATIONS & DIMENSIONAL DRAWINGS 22

OTHERS 23

FEATURES

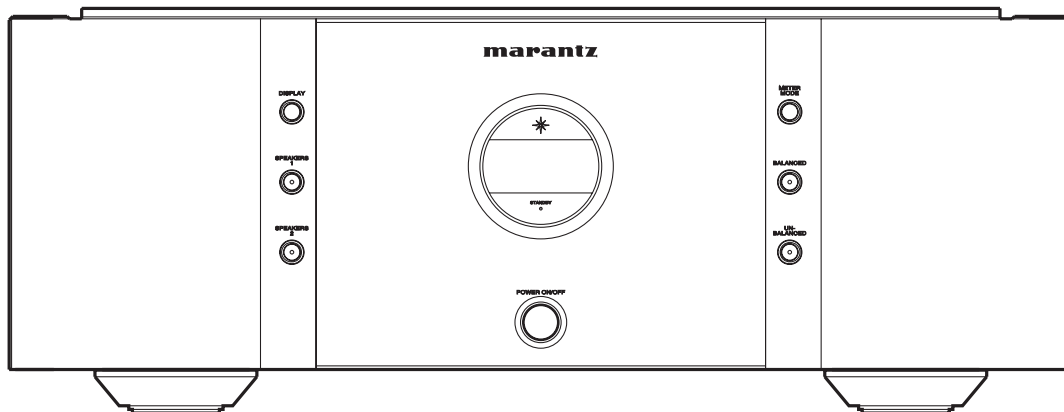

This unit was developed with many of the same functions as the flagship model MA-9S2 and with a 2-channel function, without compromising the sound quality.

● HDAM-SA3

The HDAM-SA3 is an amp module equipped with a new circuit that has further improved stability from the previous HDAM-SA and HDAM-SA2.

The HDAM-SA3 is an essential part of this unit's amp module, incorporated into many components such as the voltage-current converter and input buffer.

● Dual Structure Voltage Amplifier + Power Buffer Amplifier

Speakers with powerful magnetic circuits have large back electromotive force, and are therefore not easy to drive.

Therefore, in the same way as the MA-9S2, this unit was developed with the dual structure of a voltage amplifier and power buffer amplifier so that there is no influence from the back electromagnetic force.

● Differential Input Voltage Amplifier

The current feedback voltage amplifier that is equipped with the newly developed HDAM-SA3 and features differential input amplifies the voltage of the balanced input signals and unbalanced input signals.

Furthermore, it can also be switched between gain conversion or stereo mode to BTL monaural mode.

● New Current Feedback Power Buffer Amplifier

The power buffer amplifier that powerfully drives the speakers incorporates a voltage-current conversion circuit that contains a newly developed Complimentary Cascade Push-pull Circuit, which greatly increases stability.

Furthermore, the combination of the Wilson current mirror circuit and Cascade bootstrap circuit in the current amplification circuit provides power amplification with low distortion in the super-high frequency.

● Improved Instantaneous Current Delivery Capacity

The final stage of the power buffer amp has a LAPT special power transistor parallel push-pull construction to improve delivery, and the block capacitor and power buffer amplifier are unified.

Also, the block capacitor and unified power buffer enable the reduction of the current loop path, creating superior channel separation.

● Input Buffer

Each input has its own input buffer that directly uses HDAM-SA3 technology to prevent interference between channels or input sources.

● BALANCED/UNBALANCED Individual Gain Setting Function

The gain can be set individually for BALANCED input and UNBALANCED input according to the intended use.

● Digital Power Meter

The actual output power can be indicated on the display by detecting the speaker output voltage and output current.

Considering overall sound quality, a PLD (programmable logic device) is used instead of DSP for the digital processing to minimize the amount of digital noise.

● Remote Power Control

The Power to this unit can be switched ON/OFF in sync with the Marantz SC-11S1 stereo control amplifier ON/OFF control using the remote power control function.

The connection with the SC-11S1 is made without a ground loop being formed, therefore sound quality is not adversely affected.

BEFORE USING

This section must be read before any connection is made to the mains supply.

EQUIPMENT MAINS WORKING SETTING

Your Marantz product has been prepared to comply with the household power and safety requirements that exist in your area.

- Power requirements (U.S.A.)AC 120V 60Hz
- Power requirements (Europe)AC 230V 50/60Hz

COPYRIGHT

Recording and playback of any material may require consent. For further information refer to the following:

- Copyright Act 1956
- Dramatic and Musical Performers Act 1958
- Performers Protection Acts 1963 and 1972
- Any subsequent statutory enactments and orders

INAPPROPRIATE PLACES FOR INSTALLATION

To keep your player in perfect working order for the longest possible time, avoid installing the player in the following locations.

- Wherever it will be exposed to direct sunlight
- Wherever it will be close to a heater or other heat-radiating appliance
- Wherever the humidity is high or ventilation is poor
- Wherever it is very dusty
- Wherever it will be subject to vibration
- On top of a rickety stand or in an unstable location which is tilted at an angle
- In an audio rack with little space at the top and bottom or other location where the heat dissipation will be obstructed

To ensure proper heat dissipation, install the player while leaving clearances between the player and wall or other components, as shown in the figure below.

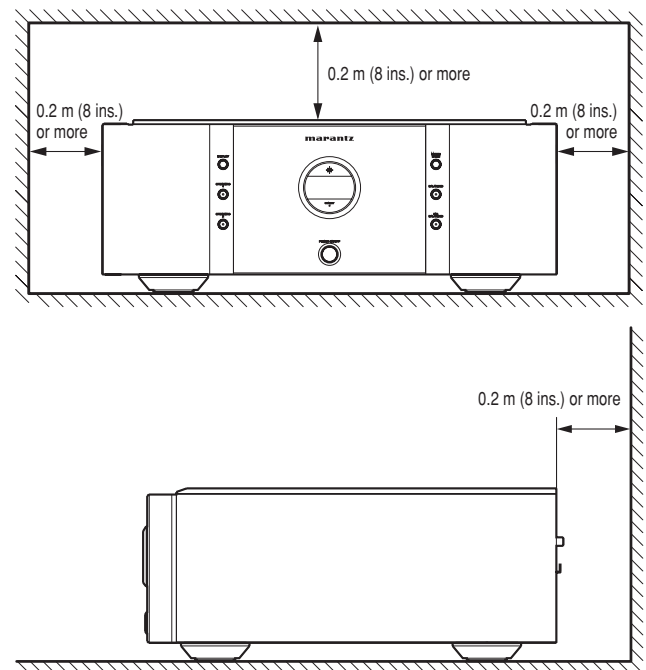

■ Do not place objects on top

- Refrain from placing any objects on top of the player.

■ Cautions on handling power cord

- Do not touch the power cord with wet hands.
- When disconnecting the power cord, always make sure that you take hold of the plug. Yanking out or bending the cord can damage it and/or cause electric shocks or a fire.
- Get into the habit of disconnecting the power plug before leaving home.

■ Do not touch hot spots during and Immediately After Use

During and immediately after use, the unit is hot in areas other than the controls and rear panel connection jacks. Do not touch hot spots and especially the top panel. Contact with hot areas can cause burns.

NAMES AND FUNCTIONS OF PARTS

FRONT PANEL

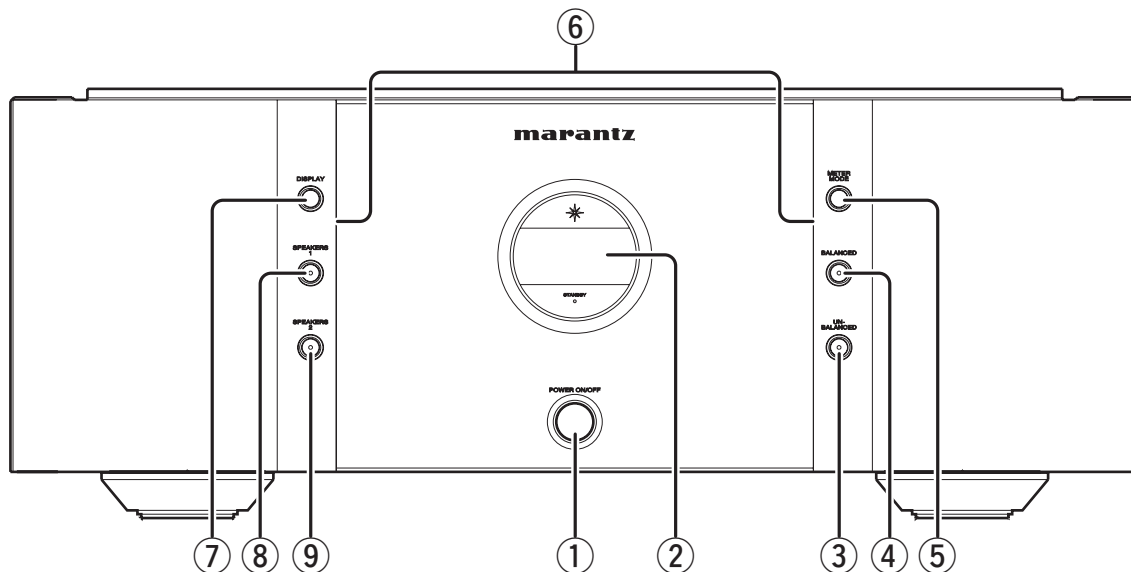

① POWER ON/OFF Switch

This switch turns power to the SM-11S1 ON and OFF. When pressed, power is activated and the blue indicator in the display ② lights up. Pressing the switch again turns the power OFF.

② Display

The monitor displays the output power to the speakers, and setting status of the various setting modes.

③ UNBALANCED Input Selection Button

This button switches the input signal from the UNBALANCED terminal on the rear panel ON/OFF. Press this button for 3 seconds or more to set the gain settings for the input signal from the UNBALANCED terminal. For instructions on **BALANCED INPUT / UNBALANCED INPUT GAIN SETTING**, see pg. 18.

④ Balanced Input Selection Button

This button switches the input signal from the BALANCED terminal on the rear panel ON/OFF. Press this button for 3 seconds or more to set the gain settings for the input signal from the BALANCED terminal. For instructions on **BALANCED INPUT / UNBALANCED INPUT GAIN SETTING**, see pg. 18.

⑤ METER MODE Button

This button changes the display to digital power meter display mode. For more information on **HOW TO USE THE METER BUTTON (DIGITAL POWER METER)**, see pg. 18.

⑥ Illumination Lamp

The illumination lamp casts a blue light over the switches and buttons. It can be turned ON and OFF with the DISPLAY button. For instructions on **HOW TO OPERATE THE SIDE ILLUMINATION**, see pg. 19.

⑦ DISPLAY Button

This button turns the display and side illumination ON and OFF. For instructions on **HOW TO OPERATE THE SIDE ILLUMINATION**, see pg. 19.

⑧ SPEAKERS 1 Button

This button switches the speaker output signal from the SPEAKERS 1 terminal on the rear panel ON/OFF.

⑨ SPEAKERS 2 Button

This button switches the speaker output signal from the SPEAKERS 2 terminal on the rear panel ON/OFF.

NAMES AND FUNCTIONS OF PARTS

DISPLAY

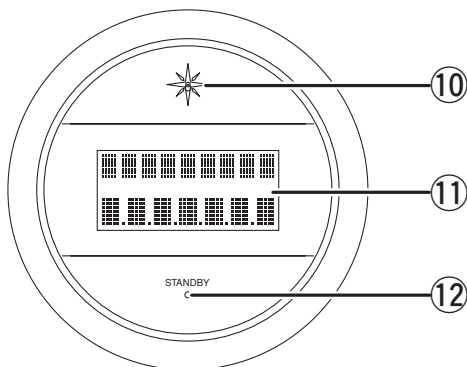

⑩ Power Indicator

This indicator is lit a blue color while power to the unit is ON.

⑪ Display Panel

- Speaker Output Power Display

In STEREO Mode

```
L POWER R
000 000
```

In BTL Mode

```
POWER
000
```

- Input signal ON/OFF switch, gain setting display

```
BALANCED
GAIN: 0
```

```
UNBALANCE
GAIN: 0
```

- Meter mode setting display

```
METER
MODE: 1
```

```
METER
MODE: 2
```

- Display when protective circuit trips

```
PROTECT
```

⑫ STANDBY Indicator

When using the remote power control function, this indicator flashes when the unit is in standby mode. Also, this indicator flashes if a protective circuit trips to give notification of a malfunction.

NAMES AND FUNCTIONS OF PARTS

REAR PANEL

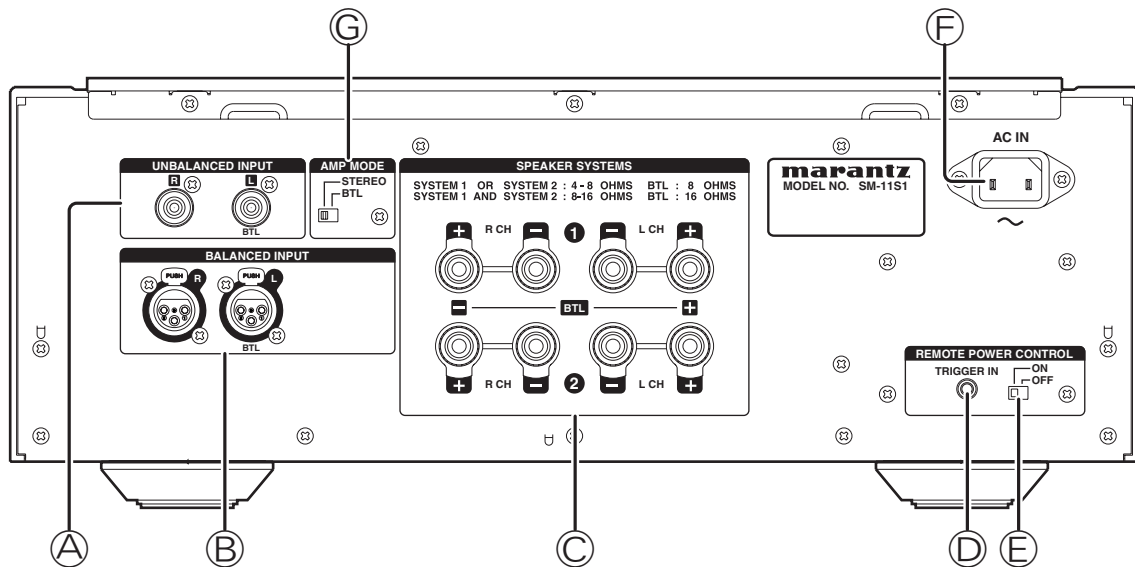

A UNBALANCED INPUT Jack

These jacks are for connecting to the unbalanced output jacks of a control amplifier. In BTL mode, the Lch input terminal is used.

B BALANCED INPUT Jacks

These jacks are for connecting to the balanced output jacks of a control amplifier. In BTL mode, the Lch input terminal is used.

C SPEAKER SYSTEMS Output Terminals

These jacks are for connecting to a speaker system. You can connect 2 speaker systems to the SM-11S1, SPEAKER SYSTEM 1 and 2. Speaker output can be turned ON/OFF from the SPEAKERS 1 / 2 buttons on the front panel.

When using BLT mode, connect the speaker + side to the Lch + jack, and the speaker – side to the Rch + jack.

D REMOTE POWER CONTROL Jacks (TRIGGER IN)

This jack controls this unit's power ON/OFF in sync with the Marantz SC-11S1 control amplifier ON/OFF control. Connect to the SC-11S1 TRIGGER OUT jack using a commercially available cable.

For more information on **REMOTE POWER CONTROL**, see pg. 20.

E REMOTE POWER CONTROL ON/OFF Switch

ON: Set to control this unit's power ON/OFF in sync with the Marantz SC-11S1 control amplifier ON/OFF control.

OFF: Set to use the POWER ON/OFF switch on the front panel of the unit to switch the unit's power ON/OFF.

F AC IN Power Cable Connection Socket

Connect this socket to the power outlet using the included power cable.

G AMP MODE Switch

STEREO: Set to use the SC-11S1 as an ordinary stereo power amplifier.

BTL: Set to connect a stereo amp by BTL and use this unit as a monaural power amp.

For more information on **AMP MODE**, see pg. 19.

Caution:

Always make sure that the power is OFF before switching this switch.

CONNECTIONS

Connection examples 1~5 are examples of connecting this unit to a Marantz SC-11S1 stereo control amplifier.

Refer to these connection examples when connecting to control amplifiers other than the SC-11S1.

Caution:

- Do not connect the power cord of this amplifier or any of the other components to the power supply until all of the connections are completed.
- Insert the plugs of the connections cords firmly into the connecting jacks. Incorrect insertion may cause noise.
- Connect the wires correctly to the L (left) and R (right) channels. The red jack is the R (right) channel, and the white jack is the L (left) channel.
- Make sure that input and output are connected correctly.
- Refer also to the instruction manuals of components to connect equipment correctly.

BALANCED JACKS

- ① The BALANCED jacks on this unit are equipped with XLR connectors that are widely used on professional equipment. Their features are listed below.
 - The 3 pin construction enables the musical signal to be transmitted as a balanced signal, with little effect from external noise
 - The detachable locking mechanism minimizes connector play and enhances connection reliability.
- ② The XLR connector for professional use is internally wired in either of the following two systems.
 1. USA system (Pin ② = COLD, Pin ③ = HOT)

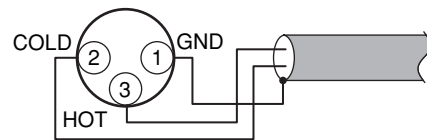

2. European system (Pin ② = HOT, Pin ③ = COLD)

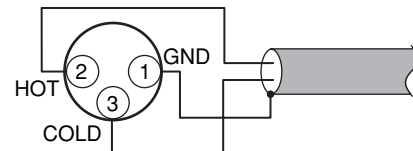

- ③ This unit uses the 1. USA system.

When a preamp or main amplifier adopting the European system is connected using a cable with XLR balanced connectors, the reproduced signal may be inverted of phase.

In this case, refer to “ANALOG OUTPUT CONNECTOR PHASE SWITCHING”, and set so that the correct phase is used.

CONNECTIONS

WIRING SPEAKER CABLE

- Peel off the coating of speaker cable as shown below.

Approx. 1 cm

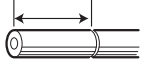

Cut the coating of cable.

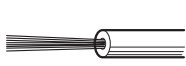

Peel off the edge of cable.

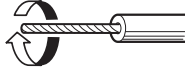

Twist conductors.

- Wiring with speaker cable.

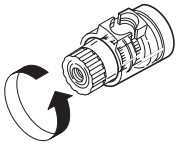

Turn counter-clockwise to loosen.

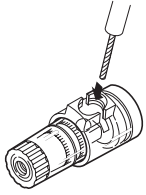

Insert conductor of cable.

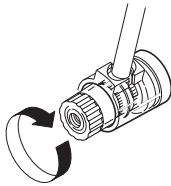

Turn clockwise to tighten.

- Wiring with "Y" style terminal

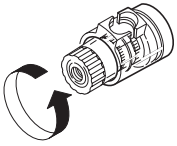

Turn counter-clockwise to loosen.

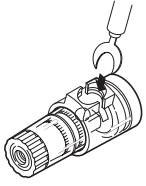

Insert conductor.

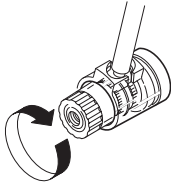

Turn clockwise to tighten.

Your speaker system needs to meet the following requirements. If speakers that do not meet the following requirements are used, the amplifier protective circuit may trip, and sounds will not playback correctly. In certain cases, damage may also be caused to the amplifier and speaker system.

- If using 1 set of speakers, total speaker impedance must be 4Ω or more.
- If using 2 sets of speakers, total speaker impedance must be 8Ω or more.
- When using the speaker system in BTL mode, use a speaker system that has an impedance of 8Ω or higher.

Notes:

- To prevent damage to circuitry, do not let the bare speaker wires touch each other and do not let them touch any metal part of this unit.

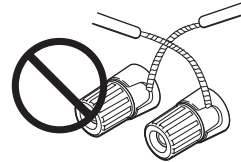

- Do not touch the speaker terminals when the power is on. It may cause you to receive an electric shocks.
- Do not connect more than one speaker cable to one speaker terminal. Doing so may damage this unit.
- Be sure to connect the positive and negative cables for the speaker properly. If they are miss-connected, the signal phase will be reversed and the signal quality will be corrupted.

CONNECTIONS

■ Connection Example 1: Basic Connection for Normal Stereo Playback

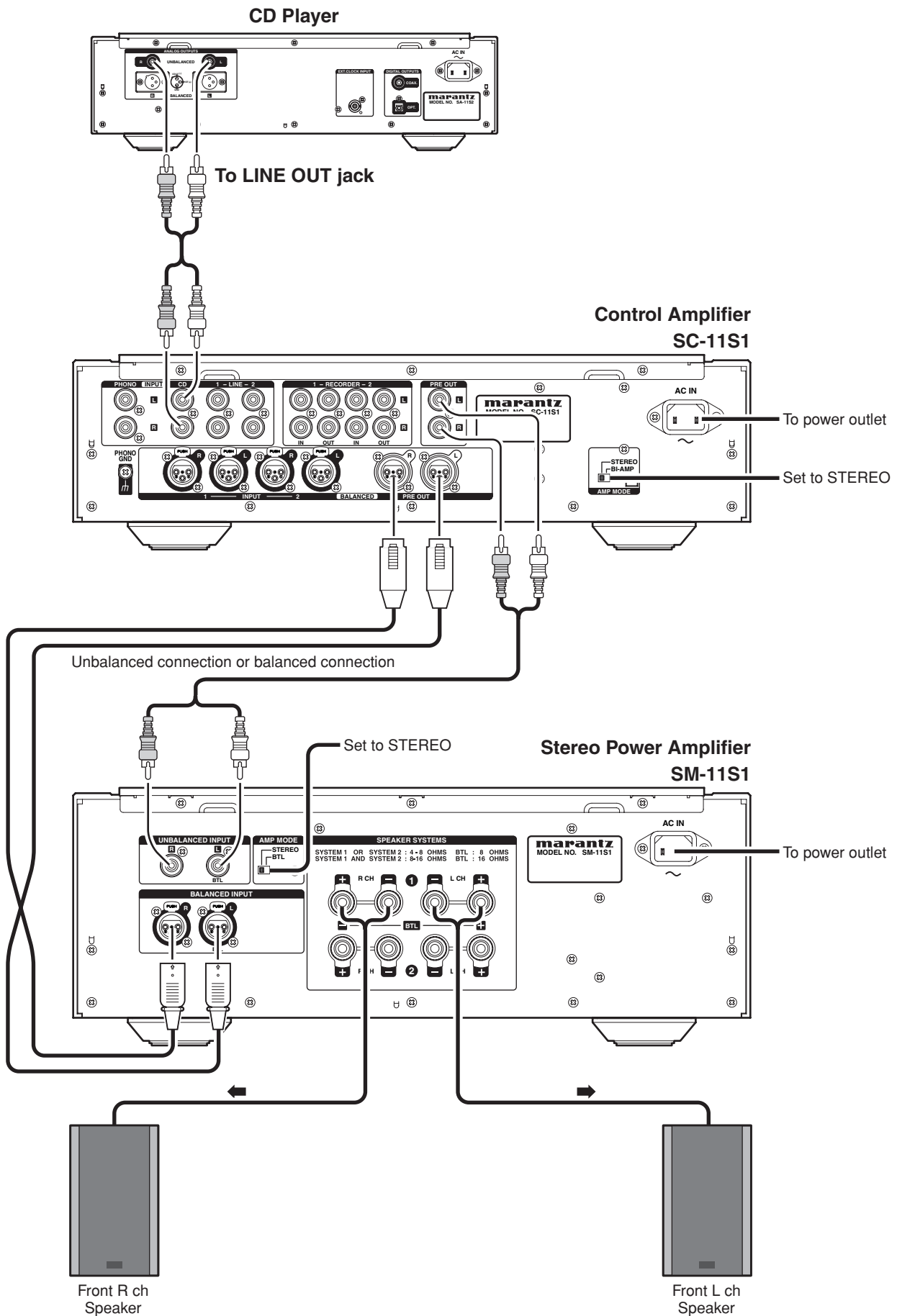

CONNECTIONS

■ Connection Example 2: Upgraded version of connection example 1 using bi-wiring connections

Use bi-wiring connections to connect the unit and speaker system with 2 sets of speaker cables.

Before connecting the speaker system using bi-wiring, check to make sure that the speaker system supports bi-wiring.

● Bi-Wiring Connection

Bi-wiring connection is a technique for improving sound quality by separately connecting the low and mid/high jacks of the speaker to the amplifier using separate cables.

By using separate cables for low and mid/high sounds, the return current generated in the low speaker causes little interference with the mid/high speaker.

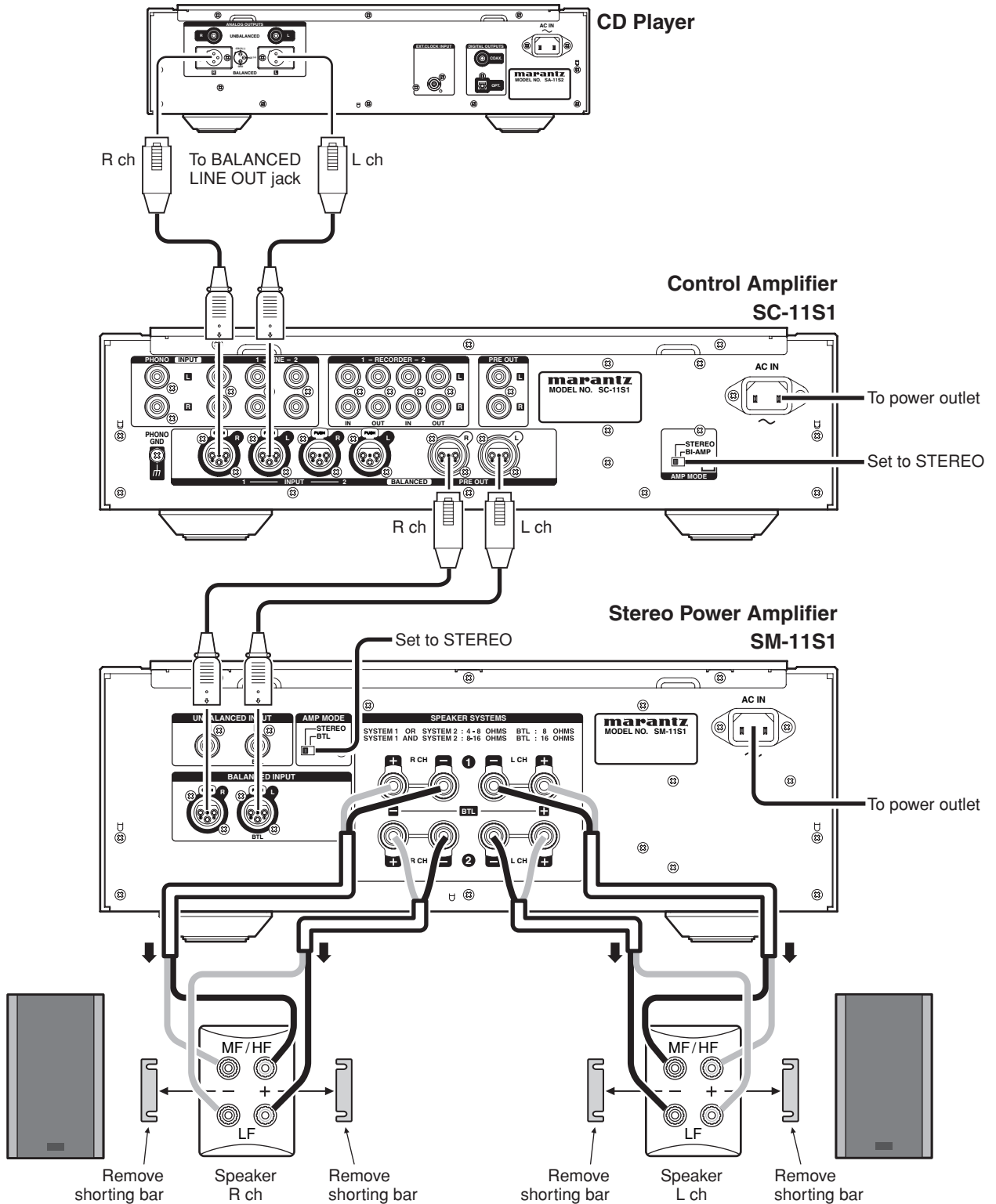

Set the BALANCED Button and SPEAKER 1, 2 buttons on the SM-11S1 ON.

CONNECTIONS

■ Connection Example 3: Connection for using connecting 2 SM-11S1s in BTL mode for stereo playback

Note:

When using this unit in BTL mode, ensure that the speakers have an impedance of more than 8Ω.

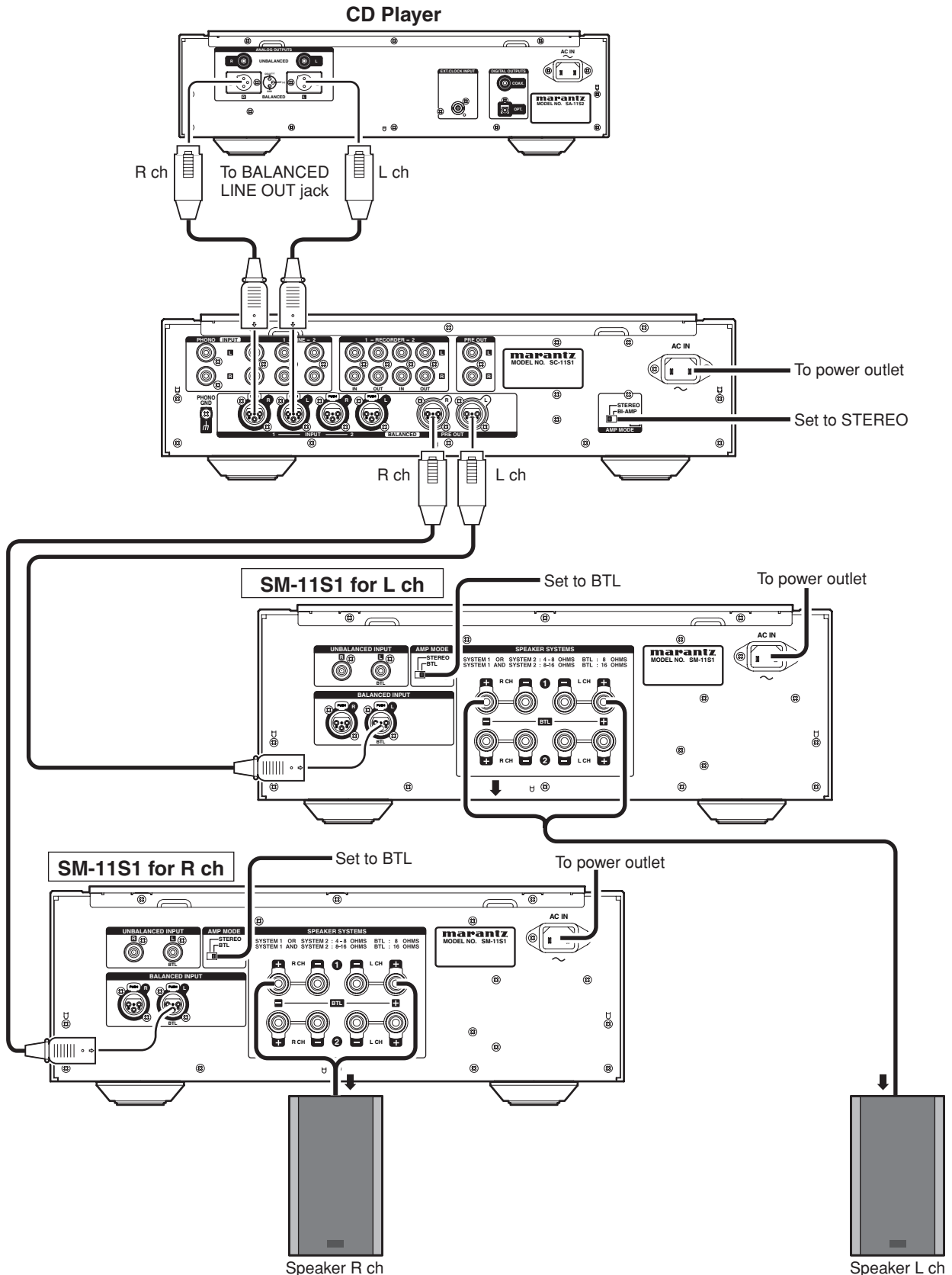

Set the BALANCED button and SPEAKER 1 button on the front panel of the SM-11S1s for both the left channel and right channel to ON

CONNECTIONS

■ Connection Example 4: Stereo Complete Bi-amp Connection

1. Connect 2 Marantz SC-11S1 by F.C.B.S. for synchronized control.
For F.C.B.S. connection, connect with commercially available cables with monaural ↔ monaural miniplugs or stereo ↔ stereo miniplugs as described in **F.C.B.S.** (pg. 26) in the SC-11S1 instruction manual.
2. Refer to the SC-11S1 instruction manual (pg. 27) and set the SC-11S1 ID numbers.
3. Connect the analog output of the CD player etc. to the L ch input jacks of both pre-amps. As both pre-amps operate as monaural pre-amps in BI-AMP mode, do not use the R channel of the input jacks for the SC-11S1.

● About Complete Bi-Amp

Proposed by Marantz, the complete bi-amp connection is an advanced technique that enhances sound quality. The low and mid/high amplifiers are separate and independent of the preamplifier, therefore interference between low and mid/high sounds is reduced to a minimum. As a result, a wide sound environment can be reproduced.

Note:

Speaker systems that can be connected using complete bi-amp must support bi-amp connections. Before connecting your speaker system, check the speaker system instruction manual, or contact the speaker manufacturer to check whether the speakers support bi-amp connections.

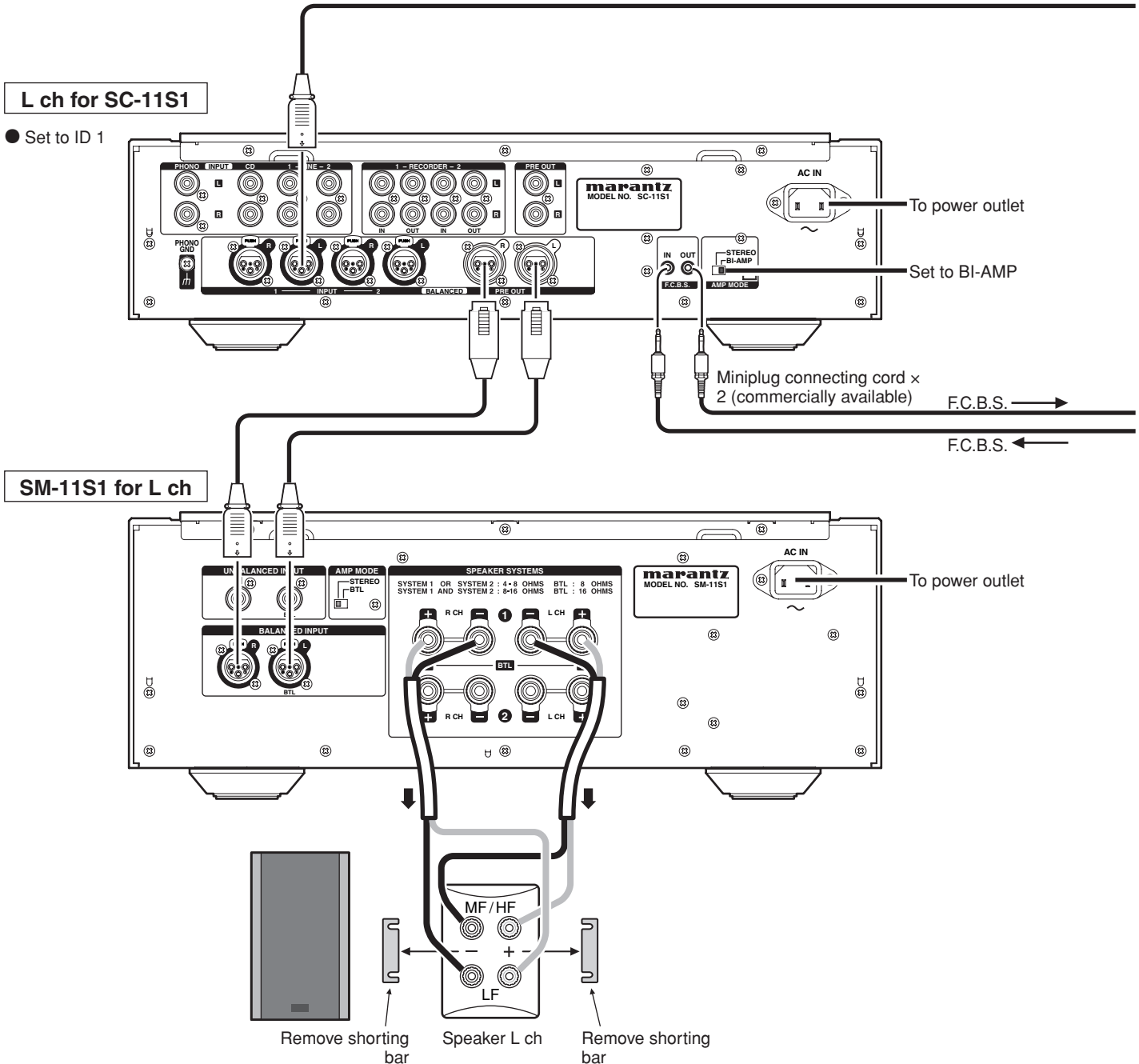

Set the BALANCED button and SPEAKER 1 button on the front panel of the SM-11S1s for both the left channel and right channel to ON

CONNECTIONS

CD Player

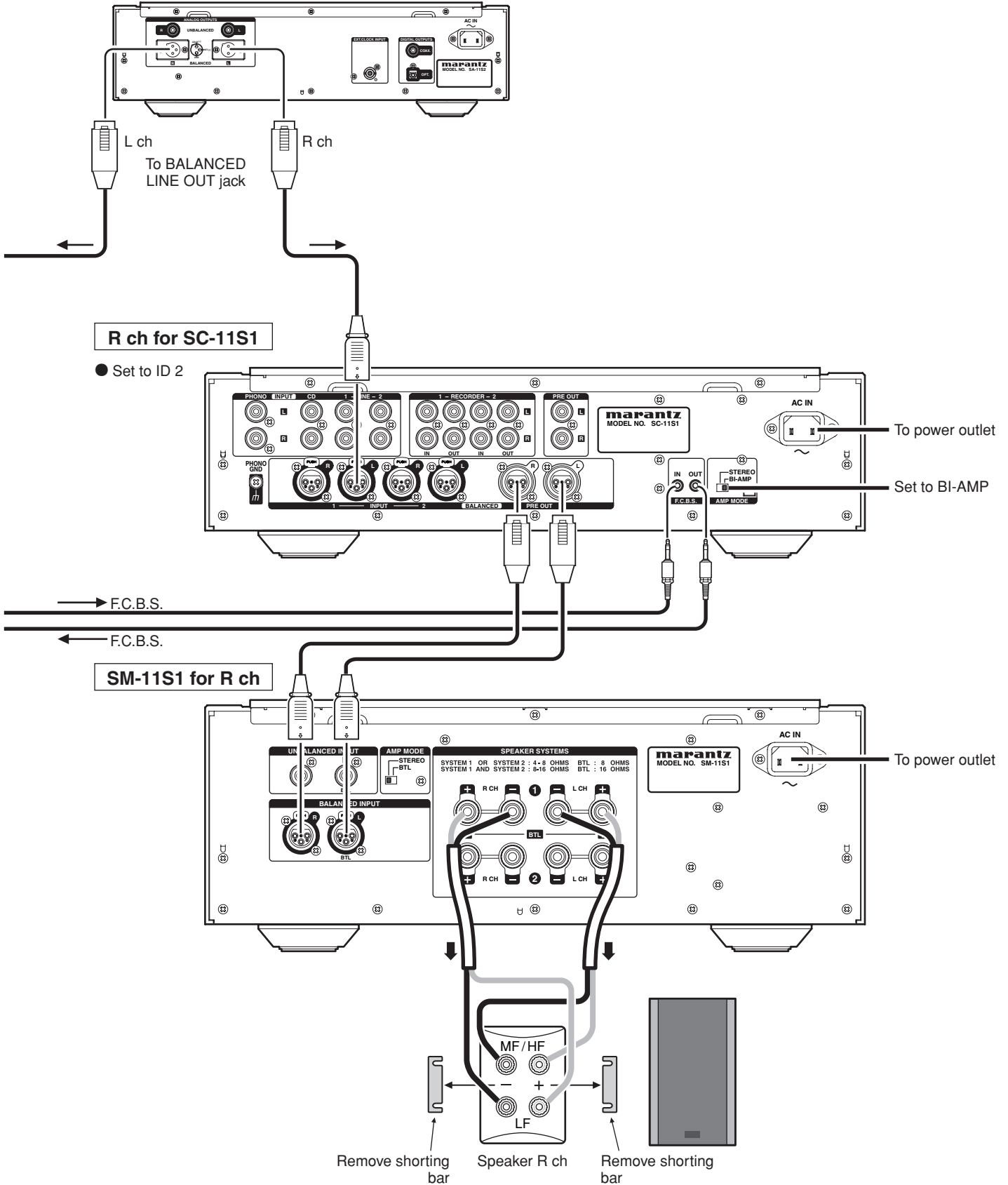

Set the BALANCED button and SPEAKER 1 button on the front panel of the SM-11S1s for both the Lch (left channel) and Rch (right channel) to ON

CONNECTIONS

■ Connection Example 5: Basic Connection for 5.1 Multi-Channel Playback

1. Three amplifiers are connected by F.C.B.S. for synchronized use. Refer to **F.C.B.S.** (pg. 26) in the SC-11S1 instruction manual, and prepare 3 commercially available connecting cables.
2. Refer to the SC-11S1 instruction manual (pg. 27) and set the SC-11S1 ID numbers.
3. Connect the outputs of players that have 5.1 channel analog outputs to each of the three pre-amps.
4. When using a sub-woofer with a built-in amplifier, see the sub-woofer's instruction manual.

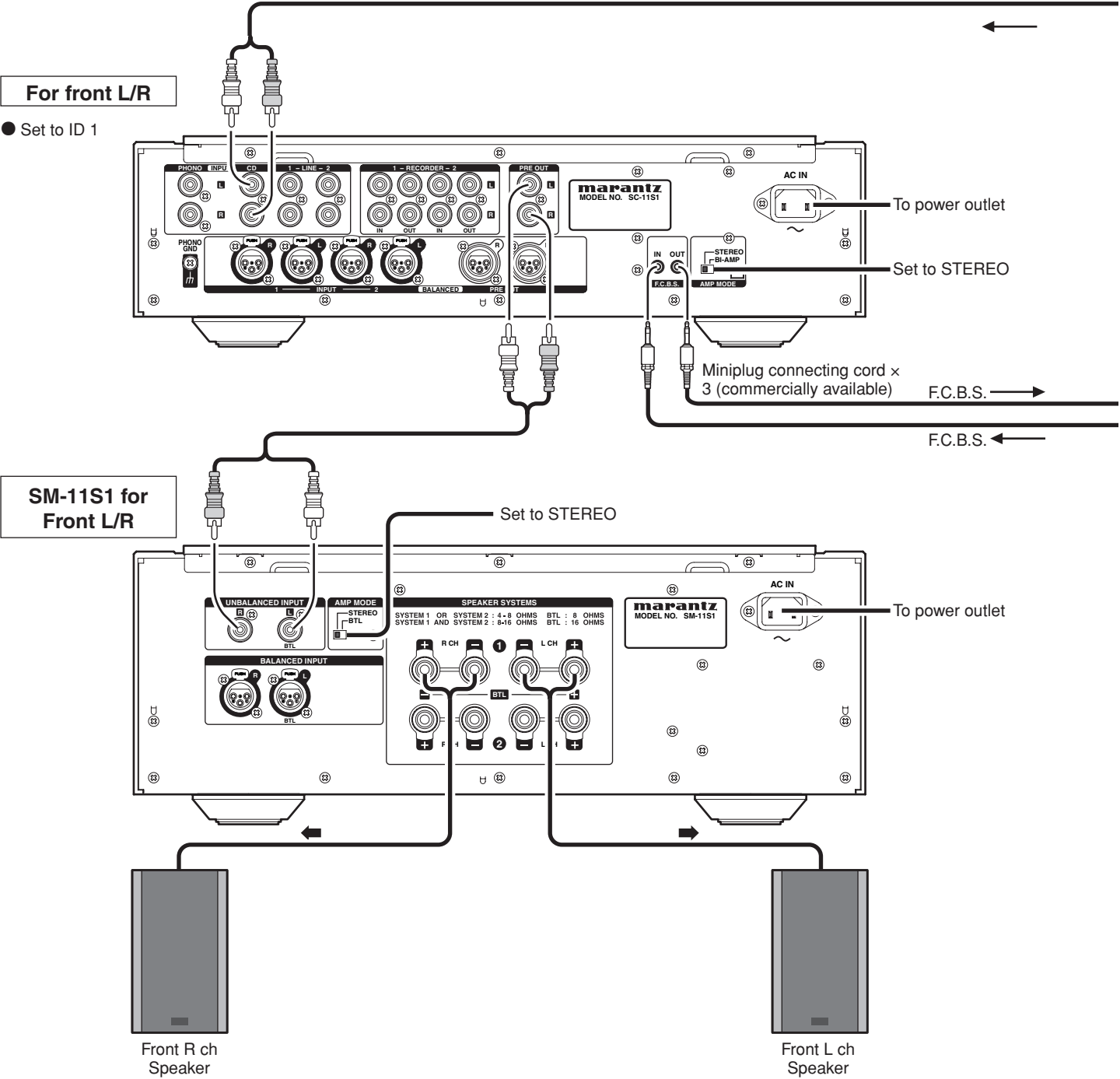

CONNECTIONS

Super Audio CD Multi-channel Player etc.

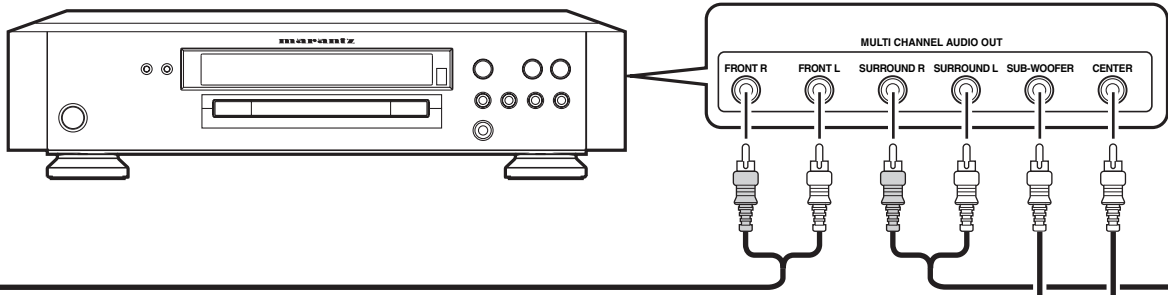

To pg. 16

For center/
subwoofer

● Set to ID 2

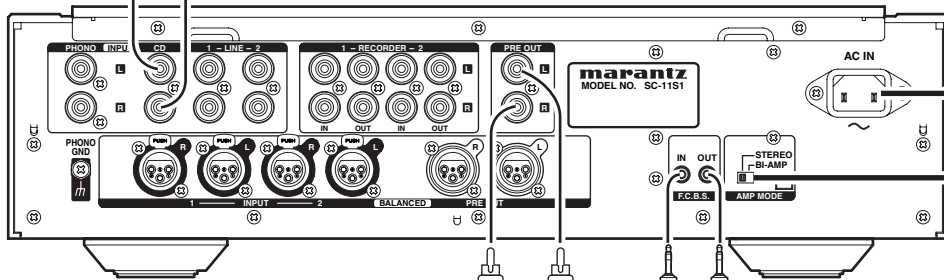

To power outlet

Set to STEREO

To pg. 16

SM-11S1 for
center

Set to STEREO

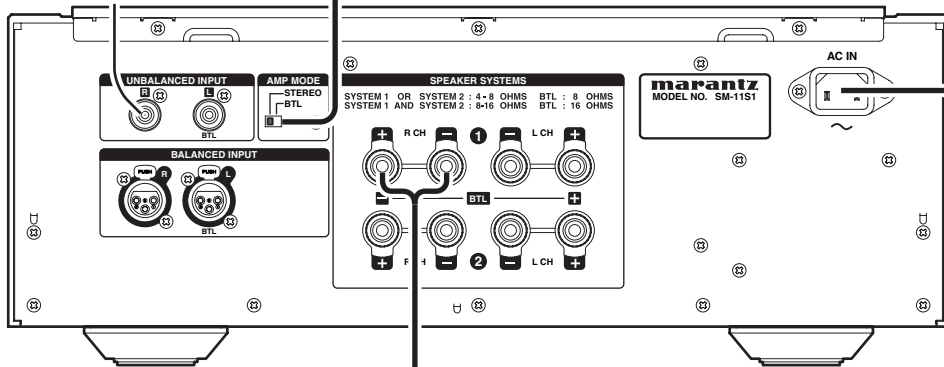

To power outlet

To line input
jack

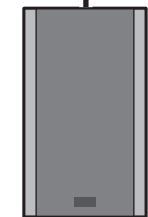

Center speaker

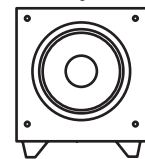

Amplifier built-in
subwoofer

CONNECTIONS

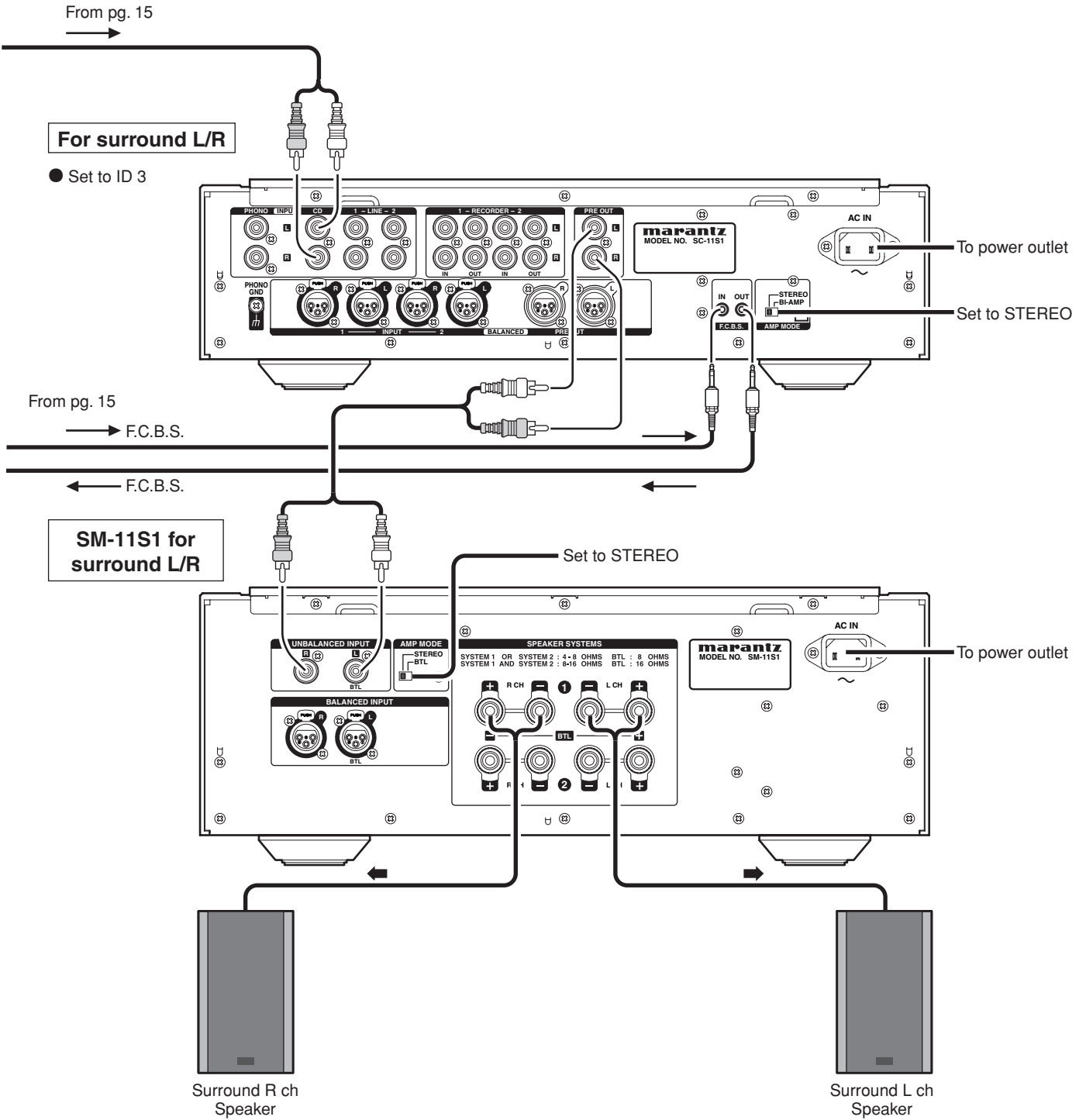

CONNECTIONS

SPEAKER POSITIONING FOR SUPER AUDIO MULTI-CHANNEL SOUND

In order to enjoy Super Audio CD multi-channel sound with the best possible acoustics, it is recommended to position speakers as specified in ITU-R BS.775-1 of the International Telecommunication Union (ITU). Super Audio CD multi-channel discs are recorded and mixed so as to achieve the optimum effect with a speaker system laid out as specified in ITU-R BS.775-1.

- With Super Audio CD multi-channel discs, the music signals are basically recorded using 5 channels (3 - 6 channels sometimes), but in some cases, LFE (for subwoofer) is recorded as a sixth channel. Each disc indicates how many channels have been recorded on it.
- The basic layout is 3 speakers in the front and 2 in the back since multi-channel discs usually have 5 channels. The 2 front, 1 center and 2 surround (rear) speakers should be set in a circle around the listening point as shown below. If using speakers of differing sizes, adjust volume balance from the amplifier.
- The location of the subwoofer in the figure is just for explanatory purposes. It can be located anywhere in the room. For connection and positioning instructions, see the instruction manual that came with the subwoofer.

● ITU (International Telecommunication Union)

The ITU is a special organization of the United Nations. It consists of a number of organs, one of which is the Radio Broadcasting Section.

ITU-R BS in the recommendation which consists of standards relating to broadcasting (audio) operations, one of which is the ITU-R BS.775-1 which governs "multi-channel stereo sound systems."

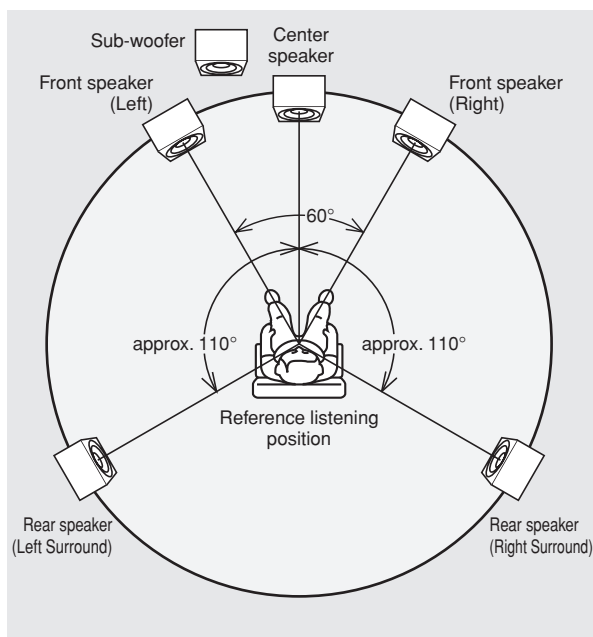

CONNECTING THE POWER SUPPLY

1. Plug the power cable into AC IN jack on the back panel.

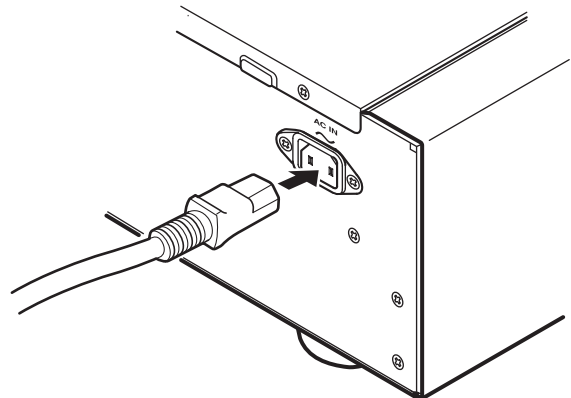

2. Turn on the power switch of the audio unit (amplifier, etc.) that is connected with this unit. Set the selector on the connected unit to this unit.
3. Plug the power cable into an AC outlet.

HOW TO USE AND SET FEATURES

HOW TO USE THE METER MODE BUTTON (DIGITAL POWER METER)

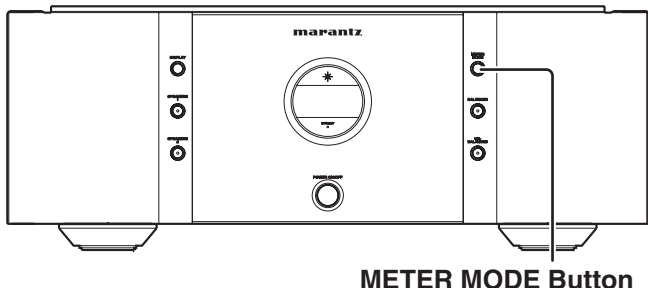

METER MODE Button

The actual output power can be displayed on the display by detecting the speaker output voltage and output current, and then digitally processing the information.

● Hold Function

Press the METER MODE button to hold the display of the left and right power output status at the time the button was pressed. When the METER MODE button is pressed again, hold is released. (Hold is also released if a different button is operated.)

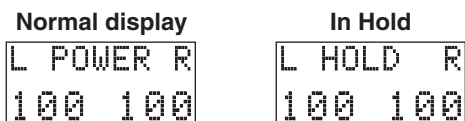

● How to Set Meter Mode

There are two types of display mode for this unit's digital power meter.

Mode 1: The power display hold time is set to 1 second in this mode. The power output value is displayed every 1 second.

Mode 2: The power display hold time is set to unlimited in this mode. When a larger output than the currently displayed value is output, that output value is displayed on the display.

The setting procedures for mode 1 and mode 2 are shown below.

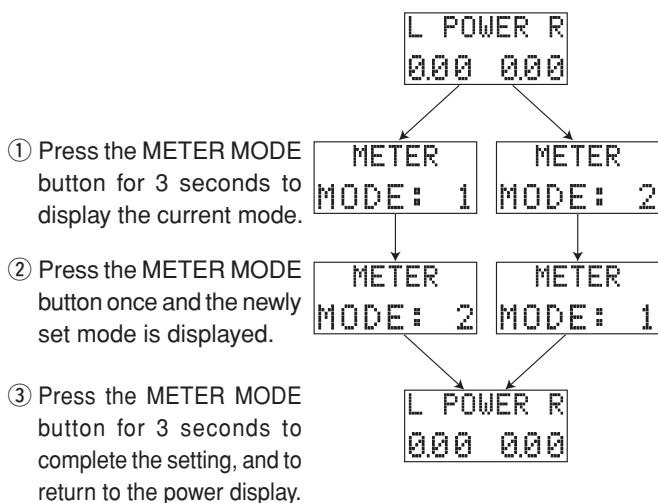

BALANCED INPUT/UNBALANCED INPUT GAIN SETTINGS

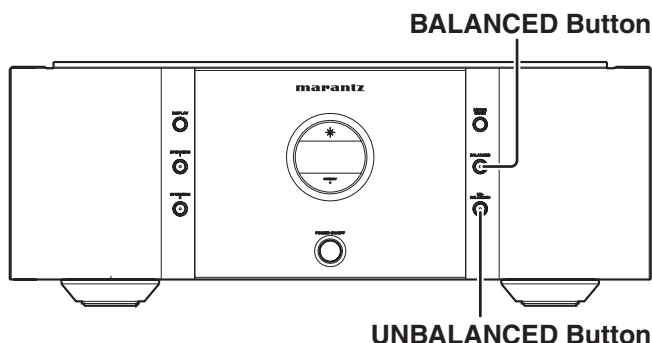

BALANCED Button

UNBALANCED Button

There are two types of input jack on this unit, BALANCED jack input and UNBALANCED jack input. The input types are independent from each other, and gain settings can be independently set.

The procedure for setting the gain settings is the same for BALANCED input and UNBALANCED input.

The standard gain can be set across a +6dB to -6dB range.

The factory default setting is ±0dB (23dB) from the standard gain.

1. Press the BALANCED (UNBALANCED) button for 3 seconds. The display changes from the power display to the gain setting mode, and the current gain value is displayed. In the gain setting mode, the amplifier switches to mute, and no sounds are output.

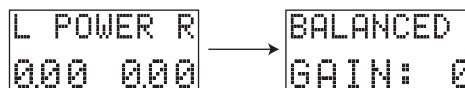

2. The setting value changes every time the BALANCED (UNBALANCED) button is pressed. Press the BALANCED (UNBALANCED) button until the desired gain value is displayed.

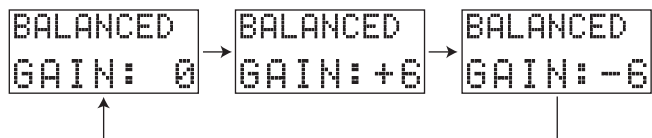

3. When the desired gain value is displayed, press the BALANCED (UNBALANCED) button for 3 seconds to complete the setting.

The set gain value is displayed for 3 seconds, then the display returns to the normal power display. At the same time, muting is released, and sound is output.

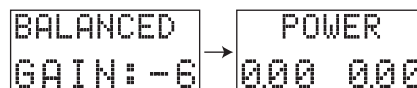

HOW TO USE AND SET FEATURES

AMP MODE

This unit can be used in normal stereo mode or in BTL monaural mode by switching the AMP MODE switch on the rear panel to match the connected speaker system.

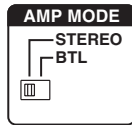

STEREO: Set to this mode to use the unit as a normal stereo power amplifier.

BTL: Set to connect a stereo amp by BTL and use the unit as a monaural power amp.



When in BTL mode, the amplifier gain increases by +6dB higher than the STEREO mode.

Alter the gain settings to suit the conditions in which the unit is used. (pg. 18)

Caution:

Always make sure that the power is OFF before switching this switch.

HOW TO OPERATE THE SIDE ILLUMINATION

Illumination Lamp

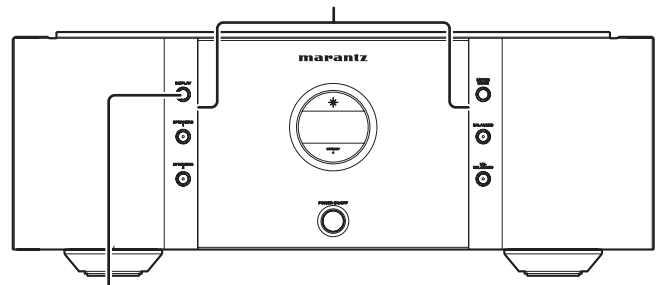

DISPLAY button

The illumination lamp has an always-ON mode (factory setting) and an always-OFF mode.

In the always-ON mode, the illumination lamp turns ON/OFF in sync with the display.

1. With the illumination lamp lit, press and hold the DISPLAY button for 3 seconds or longer. The illumination lamp goes out, and the always-OFF mode is engaged.
2. To cancel the always-OFF mode and turn the illumination lamp ON, press and hold the DISPLAY button for 3 seconds or longer.

HOW TO USE AND SET FEATURES

REMOTE POWER CONTROL

By connecting this unit to a Marantz SC-11S1 stereo control amplifier using the remote power control connection, the power controls of this unit are operated in sync with the SC-11S1 power ON/OFF controls.

The SC-11S1 has two trigger output terminals, therefore two SM-11S1s can be connected to one SC-11S1.

1. Prepare the correct number of double-ended mini plug audio connection cables for the number of SM-11S1s to be connected. Either of the following types of connection cables are adequate.

Caution:

Do not use connecting cables that contain resistance.

- Monaural miniplug ⇔ monaural miniplug connecting cable

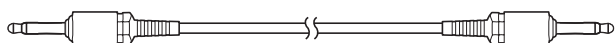

- Stereo miniplug ⇔ stereo miniplug connecting cable

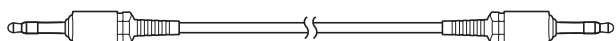

2. Check that the power to the unit and SC-11S1 that will be connected to it are both OFF.
3. After completing the connections shown below, switch the remote power control ON/OFF switch on the rear panel of the unit to ON.
4. Press the POWER ON/OFF switch on the unit to switch to standby mode.
5. In this condition, press the POWER ON/OFF switch on the SC-11S1, and the power of the SM-11S1 will switch ON in sync.

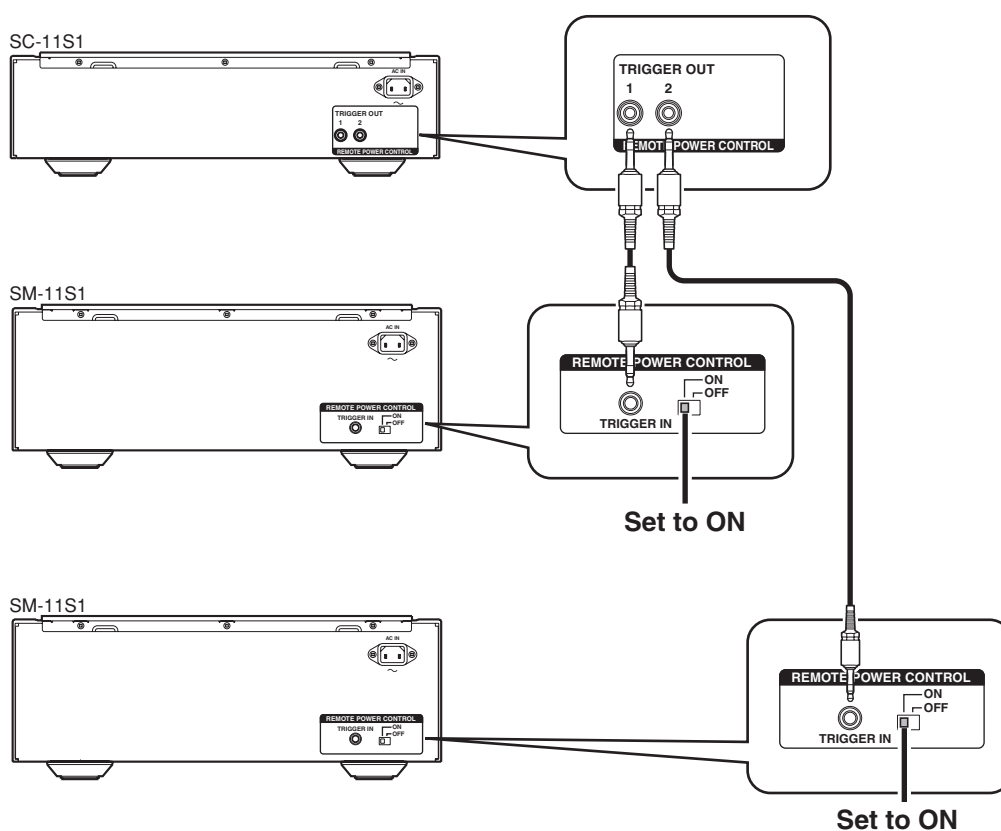

TROUBLESHOOTING

If you experience trouble with the SM-11S1, make the below checks before thinking the worst. Improper operation can cause the SM-11S1 to behave in a way that makes you think something is wrong with the equipment when actually not. If the trouble cannot be fixed after making the below checks, contact the place of purchase, your nearest Marantz dealer, our customer service center or our repair service center.

● Power does not turn ON

1. Is the power cable securely plugged into a power outlet?
2. Is the remote power control switch on the rear panel set correctly?

● Nothing is heard from the speakers

1. Is the SPEAKERS button on the front panel OFF?
2. Is the input set correctly using the BALANCED button or UNBALANCED button on the front panel?
3. Is the gain switching mode in use causing sound to be muted?
4. Are connection cables and speaker cables securely connected?
5. A protective circuit may have tripped causing sound to be muted. If PROTECT is flashing in the display, switch the power off and wait for approximately 1 minute before switching the power on again.

● Sound from the speakers is not stereo

The MODE switch on the rear panel may be set to BTL. If the switch is set to BTL, switch off the power, change the AMP MODE switch to STEREO, and then switch the unit's power back on again.

■ Protective Circuits

This unit is equipped with protective circuits to protect the amplifier circuits and speaker system against damage. If a protective circuit trips, the sound is instantly muted. In this case, "PROTECT" flashes on the display and the STANDBY indicator also flashes.

● At Power ON

For about 8 seconds after power is activated, a protective circuit trips and mutes the sound to give amplifier circuits time to stabilize. Once the amplifier circuits stabilize, the protective circuit releases and audio is enabled.

● In the Event of Over current

A protective circuit trips if current that exceeds the set level is detected, which can happen if excessive signal flow is input to the amplifier, or if the unit is connected to a speaker system of less than 4Ω impedance. A protective circuit can also trip if a speaker cable accidentally shorts. In these cases, "PROTECT" flashes on the display, and the STANDBY indicator flashes red. To release the protective circuits, switch the power OFF, and wait for approximately 1 minute before switching the power back ON again.

● If Strong Bass Signals Are Input

A protective circuit trips if bass signals of an excessive level are detected. In these cases, "PROTECT" flashes on the display, and the STANDBY indicator flashes red. To release the protective circuits, switch the power OFF, and wait for approximately 1 minute before switching the power back ON again.

● If the Amplifier Overheats

A protective circuit trips if the temperature of the main amplifier rises above the set level, which can happen if excessive signal flow is continually input into the amplifier. Temperature can also exceed the trip level of the protective circuits if the vents on the top of the unit are covered, or if the unit is installed on a cramped audio rack. In these cases, "PROTECT" flashes on the display, and the STANDBY indicator flashes red. To release the protective circuit, switch off the power supply and wait for the amplifier to cool to operational temperature before switching the power on again.

● In the Event of Amplifier Trouble

A protective circuit trips and automatically shuts off the power if an abnormality is detected in the power circuit for whatever reason. The same happens if the main fuse inside the amplifier blows. In these cases, the STANDBY indicator on the display flashes red.

Switch off the power supply, and wait for a few minutes before switching the power on again. If the display does not light and the STANDBY indicator continues to flash after switching the power on again, the unit has a fault.

SPECIFICATIONS & DIMENSIONAL DRAWINGS

- Power output (20Hz~20kHz simultaneous drive of both channels)
 - 110W +110W (8Ω load)
 - 220W + 220W (4Ω load)
- Power output during BTL 420W (8Ω load)
- Total frequency distortion (20Hz~20kHz simultaneous drive of both channels)
 - 0.02% (8Ω load)
- Output bandwidth (8Ω load, 0.05%) 5Hz~40kHz
- Frequency response (1W, 8Ω) 5Hz~120kHz
- Dumping factor (20Hz~20kHz, 8Ω load) 110
- Input sensitivity/Input impedance
 - 2V / 22kΩ (UNBALANCED)
 - 2V / 22kΩ (BALANCED)
- S/N rate (IHF-A network, 1W, 8Ω)
 - 101dB (UNBALANCED)
 - 101dB (BALANCED)
- Voltage amplification
 - 17dB (GAIN SETTING: -6dB)
 - 23dB (GAIN SETTING: ±0dB)
 - 29dB (GAIN SETTING: +6dB)
- Power requirement
 - AC120V 60Hz (U.S.A.)
 - AC230V 50/60Hz (Europe)
- Power consumption 380W (EN60065) (UL60065)
- Maximum outer dimensions
 - Width 440mm (17-3/8)
 - Height 168mm (6-5/8)
 - Depth 429mm (16-15/16)
- Weight 26.6kg (58.6 lbs)
- Accessories
 - AC Power Cord 1
 - User Guide 1
 - Warranty Card (U.S.A.) 1
 - Warranty Card (Canada) 1

● Dimensions (unit: mm (inch))

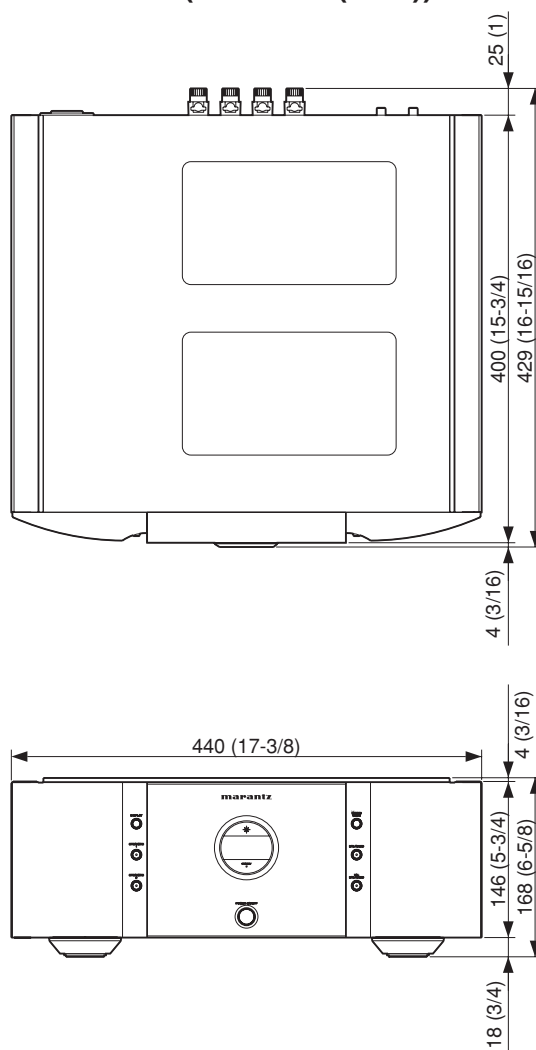

Specifications subject to change without prior notice.

OTHERS

The section describes the care and maintenance tasks that must be performed to optimize the operation of your Marantz equipment.

■ Cleaning of equipment external surfaces

The exterior finish of your unit will last indefinitely with proper care and cleaning. Never use scouring pads, steel wool, scouring powders or harsh chemical agents (e.g., lye solution), alcohol, thinner, benzine, insecticide or other volatile substances as these will mar the finish of the equipment. Likewise, never use cloths containing chemical substances. If the equipment get dirty, wipe the external surfaces with a soft, lint-free cloth.

If the equipment becomes heavily soiled:

- dilute some washing up liquid in water, in a ratio of one part detergent to six parts water.
- dip a soft, lint free in the solution and wring the it is damp.
- wipe the equipment with the damp cloth.
- dry the equipment by wiping it with a dry cloth.



■ Repairs

Only the most competent and qualified service technicians should be allowed to service the factory-trained warranty station personnel have the knowledge and special facilities needed for repair and calibration of this precision equipment. After the warranty period has expired, repairs will be performed for a charge if the equipment can be returned to normal operation.

In the event of difficulty, refer to your dealer or write directly to the nearest location to you that is listed on the Marantz Authorized Service Station list. If writing, please include the model and serial number of the equipment together with a full description of what you think is abnormal about the equipment's behaviour.

www.marantz.com

You can find your nearest authorized distributor or dealer on our website.

marantz[®] is a registered trademark.

Free Manuals Download Website

<http://myh66.com>

<http://usermanuals.us>

<http://www.somanuals.com>

<http://www.4manuals.cc>

<http://www.manual-lib.com>

<http://www.404manual.com>

<http://www.luxmanual.com>

<http://aubethermostatmanual.com>

Golf course search by state

<http://golfingnear.com>

Email search by domain

<http://emailbydomain.com>

Auto manuals search

<http://auto.somanuals.com>

TV manuals search

<http://tv.somanuals.com>