

# **marantz®**

**Model SR7300 / SR7300SE User Guide**

---

AV Surround Receiver

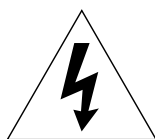
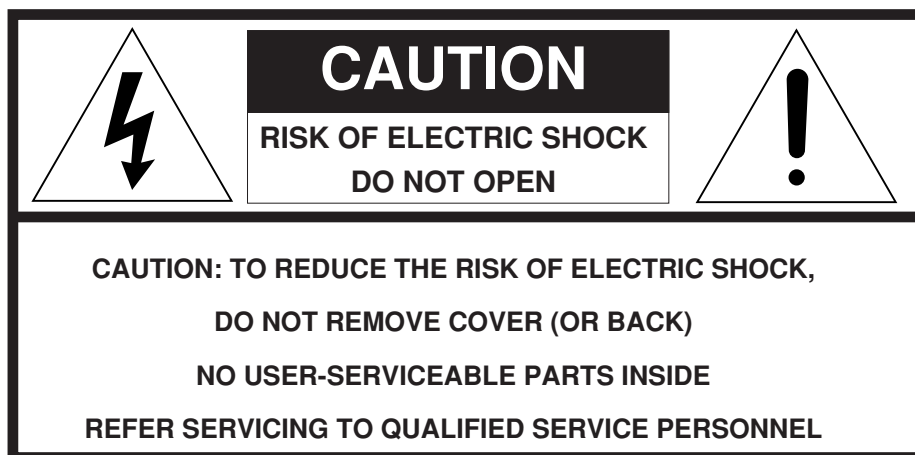

The lightning flash with arrowhead symbol within an equilateral triangle is intended to alert the user to the presence of uninsulated “dangerous voltage” within the product’s enclosure that may be of sufficient magnitude to constitute a risk of electric shock to persons.



The exclamation point within an equilateral triangle is intended to alert the user to the presence of important operating and maintenance (servicing) instructions in the literature accompanying the product.

## WARNING

**TO REDUCE THE RISK OF FIRE OR ELECTRIC SHOCK,  
DO NOT EXPOSE THIS PRODUCT TO RAIN OR MOISTURE.**

**CAUTION: TO PREVENT ELECTRIC SHOCK, MATCH WIDE  
BLADE OF PLUG TO WIDE SLOT, FULLY INSERT.**

**ATTENTION: POUR ÉVITER LES CHOC ÉLECTRIQUES,  
INTRODUIRE LA LAME LA PLUS LARGE DE LA FICHE DANS LA  
BORNE CORRESPONDANTE DE LA PRISE ET POUSSER  
JUSQU’AU FOND.**

### NOTE TO CATV SYSTEM INSTALLER:

This reminder is provided to call the CATV (Cable-TV) system installer’s attention to Section 820-40 of the NEC which provides guidelines for proper grounding and, in particular, specifies that the cable ground shall be connected to the grounding system of the building, as close to the point of cable entry as practical.

### NOTE:

This equipment has been tested and found to comply with the limits for a Class B digital device, pursuant to Part 15 of the FCC Rules. These limits are designed to provide reasonable protection against harmful interference in a residential installation. This equipment generates, uses and can radiate radio frequency energy and, if not installed and used in accordance with the instructions, may cause harmful interference to radio communications. However, there is no guarantee that interference will not occur in a particular installation. If this equipment does cause harmful interference to radio or television reception, which can be determined by tuning the equipment off and on, the user is encouraged to try to correct the interference by one or more of the following measures:

- Reorient or relocate the receiving antenna.
- Increase the separation between the equipment and receiver.
- Connect the equipment into an outlet on a circuit different from that to which the receiver is connected.
- Consult the dealer or an experienced radio/TV technician for help.

### NOTE:

Changes or modifications not expressly approved by the party responsible for compliance could void the user’s authority to operate the equipment.

# IMPORTANT SAFETY INSTRUCTIONS

## READ BEFORE OPERATING EQUIPMENT

This product was designed and manufactured to meet strict quality and safety standards. There are, however, some installation and operation precautions which you should be particularly aware of.

1. Read Instructions – All the safety and operating instructions should be read before the product is operated.
2. Retain Instructions – The safety and operating instructions should be retained for future reference.
3. Heed Warnings – All warnings on the product and in the operating instructions should be adhered to.
4. Follow Instructions – All operating and use instructions should be followed.
5. Cleaning – Unplug this product from the wall outlet before cleaning. Do not use liquid cleaners or aerosol cleaners. Use a damp cloth for cleaning.
6. Attachments – Do not use attachments not recommended by the product manufacturer as they may cause hazards.
7. Water and Moisture – Do not use this product near water-for example, near a bath tub, wash bowl, kitchen sink, or laundry tub, in a wet basement, or near a swimming pool, and the like.
8. Accessories – Do not place this product on an unstable cart, stand, tripod, bracket, or table. The product may fall, causing serious injury to a child or adult, and serious damage to the product. Use only with a cart, stand, tripod, bracket, or table recommended by the manufacturer, or sold with the product. Any mounting of the product should follow the manufacturer's instructions, and should use a mounting accessory recommended by the manufacturer.
9. A product and cart combination should be moved with care. Quick stops, excessive force, and uneven surfaces may cause the product and cart combination to overturn.



10. Ventilation – Slots and openings in the cabinet are provided for ventilation and to ensure reliable operation of the product and to protect it from overheating, and these openings must not be blocked or covered. The openings should never be blocked by placing the product on a bed, sofa, rug, or other similar surface. This product should not be placed in a built-in installation such as a bookcase or rack unless proper ventilation is provided or the manufacturer's instructions have been adhered to.
11. Power Sources – This product should be operated only from the type of power source indicated on the marking label. If you are not sure of the type of power supply to your home, consult your product dealer or local power company. For products intended to operate from battery power, or other sources, refer to the operating instructions.

12. Grounding or Polarization – This product may be equipped with a polarized alternating-current line plug (a plug having one blade wider than the other). This plug will fit into the power outlet only one way. This is a safety feature. If you are unable to insert the plug fully into the outlet, try reversing the plug. If the plug should still fail to fit, contact your electrician to replace your obsolete outlet. Do not defeat the safety purpose of the polarized plug.

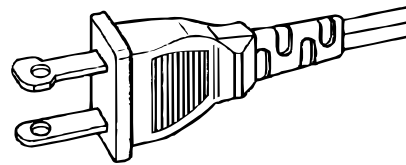

AC POLARIZED PLUG

13. Power-Cord Protection – Power-supply cords should be routed so that they are not likely to be walked on or pinched by items placed upon or against them, paying particular attention to cords at plugs, convenience receptacles, and the point where they exit from the product.
14. Protective Attachment Plug – The product is equipped with an attachment plug having overload protection. This is a safety feature. See Instruction Manual for replacement or resetting of protective device. If replacement of the plug is required, be sure the service technician has used a replacement plug specified by the manufacturer that has the same overload protection as the original plug.
15. Outdoor Antenna Grounding – If an outside antenna or cable system is connected to the product, be sure the antenna or cable system is grounded so as to provide some protection against voltage surges and built-up static charges. Article 810 of the National Electrical Code, ANSI/NFPA 70, provides information with regard to proper grounding of the mast and supporting structure, grounding of the lead-in wire to an antenna discharge unit, size of grounding conductors, location of antenna-discharge unit, connection to grounding electrodes, and requirements for the grounding electrode. See Figure 1.
16. Lightning – For added protection for this product during a lightning storm, or when it is left unattended and unused for long periods of time, unplug it from the wall outlet and disconnect the antenna or cable system. This will prevent damage to the product due to lightning and power-line surges.
17. Power Lines – An outside antenna system should not be located in the vicinity of overhead power lines or other electric light or power circuits, or where it can fall into such power lines or circuits. When installing an outside antenna system, extreme care should be taken to keep from touching such power lines or circuits as contact with them might be fatal.
18. Overloading – Do not overload wall outlets, extension cords, or integral convenience receptacles as this can result in a risk of fire or electric shock.
19. Object and Liquid Entry – Never push objects of any kind into this product through openings as they may touch dangerous voltage points or short-out parts that could result in a fire or electric shock. Never spill liquid of any kind on the product.

20. Servicing – Do not attempt to service this product yourself as opening or removing covers may expose you to dangerous voltage or other hazards. Refer all servicing to qualified service personnel.
21. Damage Requiring Service – Unplug this product from the wall outlet and refer servicing to qualified service personnel under the following conditions:
  - a. When the power-supply cord or plug is damaged.
  - b. If liquid has been spilled, or objects have fallen into the product.
  - c. If the product has been exposed to rain or water.
  - d. If the product does not operate normally by following the operating instructions. Adjust only those controls that are covered by the operating instructions as an improper adjustment of other controls may result in damage and will often require extensive work by a qualified technician to restore the product to its normal operation.
  - e. If the product has been dropped or damaged in any way, and
  - f. When the product exhibits a distinct change in performance – this indicates a need for service.
22. Replacement Parts – When replacement parts are required, be sure the service technician has used replacement parts specified by the manufacturer or have the same characteristics as the original part. Unauthorized substitutions may result in fire, electric shock, or other hazards.
23. Safety Check – Upon completion of any service or repairs to this product, ask the service technician to perform safety checks to determine that the product is in proper operating condition.
24. Wall or Ceiling Mounting – The product should be mounted to a wall or ceiling only as recommended by the manufacturer.
25. Heat – The product should be situated away from heat sources such as radiators, heat registers, stoves, or other products (including amplifiers) that produce heat.

**FIGURE 1**  
**EXAMPLE OF ANTENNA GROUNDING AS PER**  
**NATIONAL ELECTRICAL CODE, ANSI/NFPA 70**

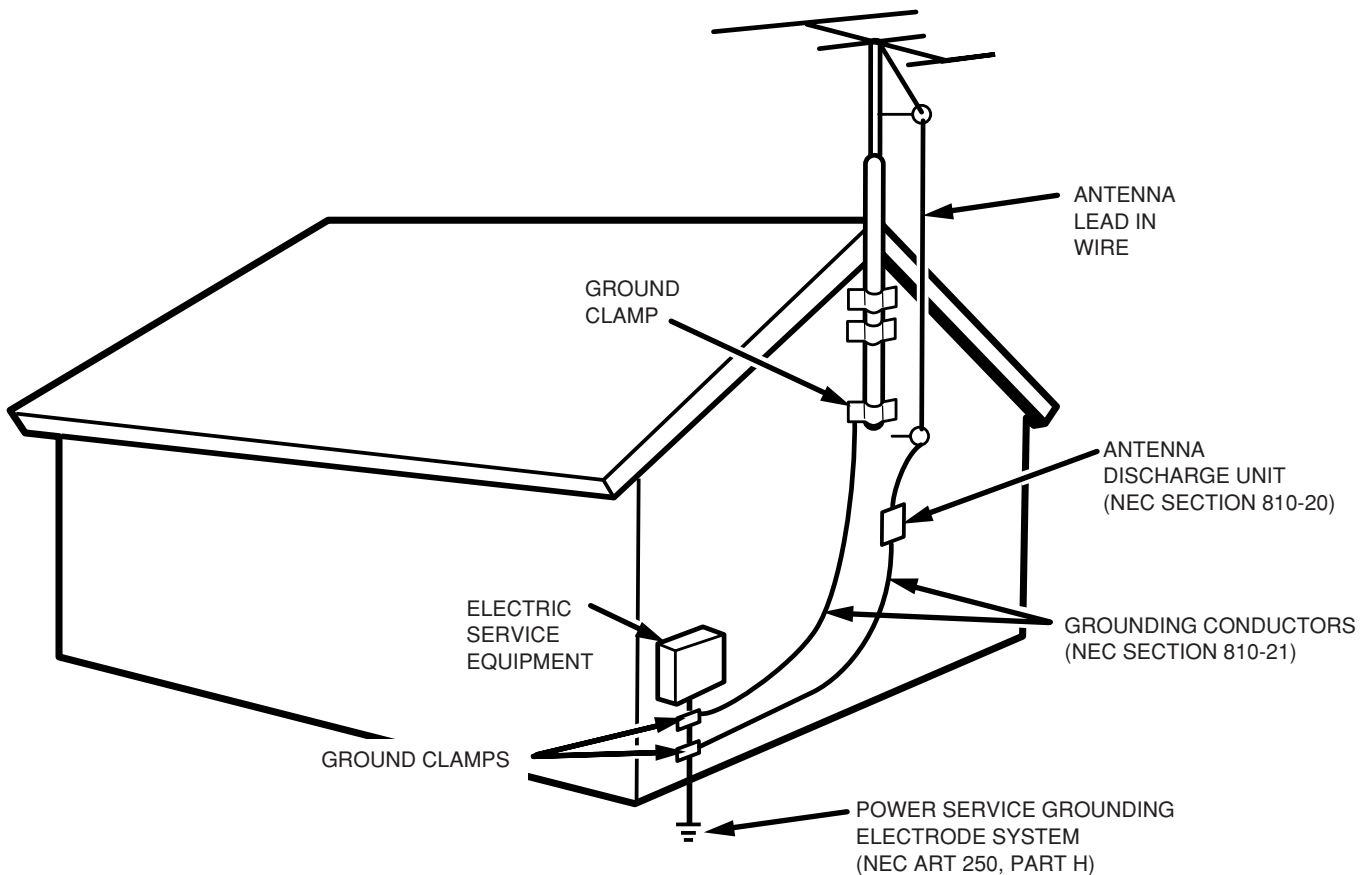

NEC - NATIONAL ELECTRICAL CODE

This Class B digital apparatus complies with Canadian ICES-003.

Cet appareil numérique de la Classe B est conforme à la norme NMB-003 du Canada.

# TABLE OF CONTENTS

<b>INTRODUCTION</b> .....	<b>2</b>	<b>SURROUND MODE</b> .....	<b>29</b>
<b>PRECAUTIONS</b> .....	<b>2</b>	<b>OTHER FUNCTION</b> .....	<b>32</b>
<b>DESCRIPTION</b> .....	<b>2</b>	TV AUTO ON/OFF FUNCTION .....	32
<b>FEATURES</b> .....	<b>4</b>	ATTENUATION TO ANALOG INPUT SIGNAL .....	32
<b>ACCESSORIES</b> .....	<b>4</b>	LISTENING OVER HEADPHONES .....	32
<b>FRONT PANEL</b> .....	<b>5</b>	VIDEO ON/OFF .....	32
<b>FL DISPLAY</b> .....	<b>7</b>	DISPLAY MODE .....	32
<b>REAR PANEL</b> .....	<b>8</b>	SELECTING ANALOG AUDIO INPUT OR DIGITAL AUDIO INPUT ....	32
<b>REMOTE CONTROLLER RC7300SR</b> .....	<b>10</b>	RECORDING AN ANALOG SOURCE .....	33
NAMES AND FUNCTIONS .....	10	HT-EQ .....	33
REMOTE CONTROL RANGE .....	12	SPEAKER A/B .....	33
LOADING BATTERIES .....	12	7.1 CH INPUT .....	34
GENERAL INFORMATION OF RC7300SR TO SR7300 .....	13	AUX2 INPUT .....	34
<b>CONNECTIONS</b> .....	<b>14</b>	<b>BASIC OPERATION (TUNER)</b> .....	<b>35</b>
SPEAKER PLACEMENT .....	14	LISTENING TO THE TUNER .....	35
CONNECTING SPEAKERS .....	15	PRESET MEMORY .....	35
CONNECTING AUDIO COMPONENTS .....	16	<b>MULTI ROOM SYSTEM</b> .....	<b>38</b>
CONNECTING VIDEO COMPONENTS .....	17	MULTI ROOM PLAYBACK USING	
ADVANCED CONNECTING .....	18	THE MULTI ROOM OUT TERMINALS .....	38
CONNECTING REMOTE CONTROL JACKS .....	18	OPERATION TO MULTI ROOM OUTPUTS	
CONNECTING THE ANTENNA TERMINALS .....	19	WITH THE REMOTE CONTROLLER FROM SECOND ROOM. ....	38
CONNECTING FOR THE MULTI ROOM .....	20	<b>REMOTE CONTROLLER OPERATION</b> .....	<b>39</b>
<b>SETUP</b> .....	<b>21</b>	CONTROLLING MARANTZ COMPONENTS .....	39
ON SCREEN DISPLAY MENU SYSTEM .....	21	LEARN MODE .....	41
1 INPUT SETUP (ASSIGNABLE DIGITAL INPUT) .....	22	MACRO MODE .....	42
2 SPEAKER SETUP .....	22	<b>TROUBLESHOOTING</b> .....	<b>46</b>
3 PREFERENCE .....	24	<b>TECHNICAL SPECIFICATIONS</b> .....	<b>48</b>
4 SURROUND .....	24	<b>DIMENSION</b> .....	<b>48</b>
5 PL II (PRO LOGIC II) MUSIC PARAMETER .....	25		
6 CS II (CIRCLE SURROUND II) PARAMETER .....	25		
7 MULTI ROOM .....	25		
8 7.1 CH INPUT LEVEL .....	26		
9 DC TRIGGER SETUP .....	26		
<b>BASIC OPERATION (PLAY BACK)</b> .....	<b>27</b>		
SELECTING AN INPUT SOURCE .....	27		
SELECTING THE SURROUND MODE .....	27		
ADJUSTING THE MAIN VOLUME .....	27		
ADJUSTING THE TONE (BASS & TREBLE) CONTROL .....	27		
TEMPORARILY TURNING OFF THE SOUND .....	28		
USING THE SLEEP TIMER .....	28		
NIGHT MODE .....	28		

## INTRODUCTION

Thank you for purchasing the Marantz SR7300 Surround receiver. This remarkable component has been engineered to provide you with many years of home theater enjoyment. Please take a few minutes to read this manual thoroughly before you connect and operate the SR7300.

As there are a number of connection and configuration options, you are encouraged to discuss your own particular home theater setup with your Marantz A/V specialist dealer.

## PRECAUTIONS

### CAUTIONS ON INSTALLATION

For heat dispersal, leave at least 20 cm/8 inch of space between the top, back and sides of this unit and the wall or other components.

- Do not obstruct the ventilation holes.

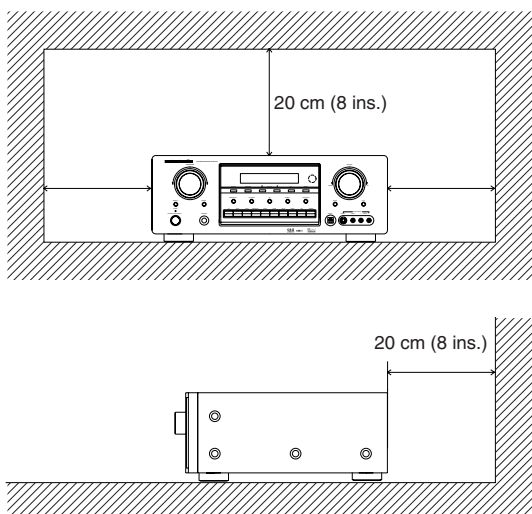

## DESCRIPTION

DIGITAL  
**dts**  
SURROUND

DTS was introduced in 1994 to provide 5.1 channels of discrete digital audio into home theater systems.

DTS brings you premium quality discrete multi-channel digital sound to both movies and music.

DTS is a multi-channel sound system designed to create full range digital sound reproduction.

The no compromise DTS digital process sets the standard of quality for cinema sound by delivering an exact copy of the studio master recordings to neighborhood and home theaters. Now, every moviegoer can hear the sound exactly as the moviemaker intended.

DTS can be enjoyed in the home for either movies or music on of DVD's, LD's, and CD's.

"DTS" and "DTS Digital Surround" are registered trademarks of Digital Theater Systems, Inc.

**dts** **neo:6**

The advantages of discrete multichannel systems over matrix are well known.

But even in homes equipped for discrete multichannel, there remains a need for high-quality matrix decoding. This is because of the large library of matrix surround motion pictures available on disc and on VHS tape; and analog television broadcasts.

The typical matrix decoder of today derives a center channel and a mono surround channel from two-channel matrix stereo material. It is better than a simple matrix in that it includes steering logic to improve separation, but because of its mono, band-limited surround it can be disappointing to users accustomed to discrete multichannel.

Neo 6 offers several important improvements as follow,

- Neo 6 provides up to six full-band channels of matrix decoding from stereo matrix material. Users with 6.1 and 5.1 systems will derive six and five separate channels, respectively, corresponding to the standard home-theater speaker layouts.
- Neo 6 technology allows various sound elements within a channel or channels to be steered separately, and in a way which follows naturally from the original presentation.
- Neo 6 offers a music mode to expand stereo nonmatrix recordings into the five- or six-channel layout, in a way which does not diminish the subtlety and integrity of the original stereo recording.

EXTENDED  
**dts** **ES**  
SURROUND

DTS-ES Extended Surround is a new multi-channel digital signal format developed by Digital Theater Systems Inc. While offering high compatibility with the conventional DTS Digital Surround format, DTS-ES Extended Surround greatly improves the 360-degree surround impression and space expression thanks to further expanded surround signals. This format has been used professionally in movie theaters since 1999.

In addition to the 5.1 surround channels (FL, FR, C, SL, SR and LFE), DTS-ES Extended Surround also offers the SB (Surround Back) channel for surround playback with a total of 6.1 channels. DTS-ES Extended Surround includes two signal formats with different surround signal recording methods, as DTS-ES Discrete 6.1 and DTS-ES Matrix 6.1.

"DTS", "DTS-ES Extended Surround" and "Neo:6" are trademarks of Digital Theater Systems, Inc.



The stereo CD is a 16-bit medium with sampling at 44.1 kHz. Professional audio has been 20- or 24-bit for some time, and there is increasing interest in higher sampling rates both for recording and for delivery into the home. Greater bit depths provide extended dynamic range. Higher sampling rates allow wider frequency response and the use of anti-alias and reconstruction filters with more favorable aural characteristics.

DTS 96/24 allows for 5.1 channel sound tracks to be encoded at a rate of 96kHz/24bits on DVD-Video titles.

When DVD-video appeared, it became possible to deliver 24-bit, 96 kHz audio into the home, but only in two channels, and with serious limitations on picture. This capability has had little use.

DVD-audio allows 96/24 in six channels, but a new player is needed, and only analog outputs are provided, necessitating the use of the D/A converters and analog electronics provided in the player.

DTS 96/24 offers the following:

1. Sound quality transparent to the original 96/24 master.
2. Full backward compatibility with all existing decoders. (Existing decoders will output a 48 kHz signal)
3. No new player required: DTS 96/24 can be carried on DVD-video, or in the video zone of DVD-audio, accessible to all DVD players.
4. 96/24 5.1-channel sound with full-quality full-motion video, for music programs and motion picture soundtracks on DVD-video.



Dolby Digital identifies the use of Dolby Digital (AC-3) audio coding for such consumer formats as DVD and DTV. As with film sound, Dolby Digital can provide up to five full-range channels for left, center, and right screen channels, independent left and right surround channels, and a sixth (".1") channel for low-frequency effects.

Dolby Surround Pro Logic II is an improved matrix decoding technology that provides better spatiality and directionality on Dolby Surround program material; provides a convincing three-dimensional soundfield on conventional stereo music recordings; and is ideally suited to bring the surround experience to automotive sound. While conventional surround programming is fully compatible with Dolby Surround Pro Logic II decoders, soundtracks will be able to be encoded specifically to take full advantage of Pro Logic II playback, including separate left and right surround channels. (Such material is also compatible with conventional Pro Logic decoders.)

Dolby Digital EX creates six full-bandwidth output channels from 5.1-channel sources. This is done using a matrix decoder that derives three surround channels from the two in the original recording. For best results, Dolby Digital EX should be used with movies soundtracks recorded with Dolby Digital Surround EX.

Manufactured under license from Dolby Laboratories. "Dolby", "Pro Logic", and the double-D symbol are trademarks of Dolby Laboratories.



Circle Surround II (CS-II) is a powerful and versatile multi-channel technology. CS-II is designed to enable up to 6.1 multi-channel surround sound playback from mono, stereo, CS encoded sources and other matrix encoded sources. In all cases the decoder extends it into 6 channels of surround audio and a LFE/subwoofer signal. The CS-II decoder creates a listening environment that places the listener "inside" music performances and dramatically improves both hi-fi audio conventional surround-encoded video material. CS-II provides composite stereo rear channels to greatly improve separation and image positioning – adding a heightened sense of realism to both audio and A/V productions.

CS-II is packed with other useful feature like dialog clarity (SRS Dialog) for movies and cinema-like bass enrichment (TruBass). CS-II can enable the dialog to become clearer and more discernable in movies and it enables the bass frequencies contained in the original programming to more closely achieve low frequencies – overcoming the low frequency limitations of the speakers by full octave.

SRS Circle Surround II, SRS Dialog, SRS TruBass, SRS and  symbol are trademarks of SRS Labs, Inc.

SRS Circle Surround II, SRS Dialog and SRS TruBass technology are incorporated under license from SRS Labs, Inc.



HDCD<sup>®</sup> (High Definition Compatible Digital<sup>®</sup>) is a patented process for delivering on Compact Disc the full richness and details of the original microphone feed.

HDCD encoded CDs sound better because they are encoded with 20-bits of real musical information as compared to 16-bits for all other CDs. HDCD overcomes the limitation of the 16-bit CD format by using a sophisticated system to encode the additional four bits onto the CD while remaining completely compatible with the CD format.

When listening to HDCD recordings, you hear more dynamic range, a focused 3-D sound stage, and extremely natural vocal and musical timbre. With HDCD, you get the body, depth and emotion of the original performance not a flat, digital imitation.

<sup>®</sup>, HDCD<sup>®</sup>, High Definition Compatible Digital<sup>®</sup> and Pacific Microsonics<sup>™</sup> are either registered trademarks or trademarks of Pacific Microsonics, Inc. in the United States and/or other countries. HDCD system manufactured under license from Pacific Microsonics, Inc. This product is covered by one or more of the following: In the USA: 5,479,168, 5,638,074, 5,640,161, 5,808,574, 5,838,274, 5,854,600, 5,864,311, 5,872,531, and in Australia: 669114. Other patents pending.

## FEATURES

The SR7300 incorporates the latest generation of digital surround sound decoding technology such as Dolby Digital EX, Dolby Digital, DTS ES (Discrete 6.1 and Matrix 6.1), DTS Neo:6 (Cinema, Music), Dolby Pro-Logic II (Movie and Music), Circle Surround II (Cinema and Music).

In addition, Marantz has focused on the future. By utilizing pre-out jacks, 7.1 direct inputs and a RS232C communication port, the SR7300 is upgradeable to tomorrow's technology, today!

The SR7300 features a fully discrete 6 channel current feedback amplifier section capable of delivering 105 watts of high-current amplification, for continuously clean and stable power into each of the six channels. It employs a massive EI power transformer in combination with oversized filter capacitors. Current feedback topology allows total operation stability, while requiring minimal amounts of negative feed-back, resulting in an excellent transient frequency response and superb sonic transparency. This design configuration is capable of a clear and powerful reproduction of the most demanding action movie soundtracks and full range (multi-channel) music discs. Through its ability to generate very high output voltages, the SR7300 can easily drive the most demanding speakers with optimum results.

The SR7300 incorporates the most advanced Digital Signal Processing circuitry, along with a Crystal® 192 kHz/24 bit D/A converter in each of the 8 channels. Independent power supply circuits are incorporated for the FL display, audio and video sections for maximum separation, clarity and dynamic range. Together with hand-selected customized components, all elements work in harmony to recreate the emotion, exactly as the artist had intended.

The SR7300 is designed and engineered with extensive feedback from custom installation experts, dealers and consumers. It features multi-room/multisource, 2 assignable DC triggers, a RS232C communication port, heavy duty speaker binding posts and an extensive array of both analog and digital inputs / outputs. With 6 assignable digital inputs (7 total), 2 component inputs, SACD Multi Channel (7.1 channel) direct inputs and a speaker-B and OSD output versatility is taken to a stunning new level. Furthermore, the SR7300 can output the OSD information through the Y/C (S-video) and composite video outputs.

An easy-to-use programmable, learning remote control allows full access to all of the operating functions and can be used for system operation as well.

The new generation of Marantz Receivers are stylish and completely symmetrical. On the front panel of the SR7300, buttons are kept to a minimum. Source selectors and volume controls are intuitively placed. The large left dial knob on the left can be used as multi dial which allows all functions of the SR7300 to be operated via the front panel. The SR7300 is here to perform in your unrivaled home entertainment setup.

- Dolby Digital EX, Dolby Digital , DTS ES (Discrete 6.1, Matrix 6.1, Neo: 6)
- Dolby Pro Logic II (Movie, Music)
- Circle Surround II (Movie, Music, Mono)
- 6 x 105 Watts (8 Ohm), Discrete Amplifiers
- High Power Current Feedback Circuitry
- Massive Energy Power Supply, Huge EI Transformer, Large ELCO's.
- 192 kHz/24 bit Crystal® DAC for all 8 Channels
- 24 bit Digital Surround Processing Chipsets
- Video Off Mode
- Large Heavy Duty Banana Type Speaker Terminals for all Channels
- RS232C Terminal for Future Upgrades or System Control
- Set Up Menu Via Composite, and S-Video Output
- Auto Input Signal Detection
- Improved Station Name Input Method, 50 Presets
- Auto Adjust Function for Speaker Distance Settings (Delay Time)
- Front Optical AUX Input (Digital Camera, Portable DVD)
- Large Multi Operation Left Dial Knob
- 2 Assignable DC Trigger Outputs
- Programmable, learning remote control
- Built in HDCD decoder (OSE version only)

## ACCESSORIES

### Remote Controller RC7300SR

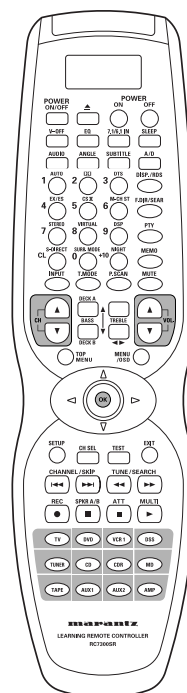

### AA-size batteries X 2

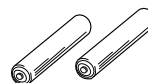

### AM Loop Antenna

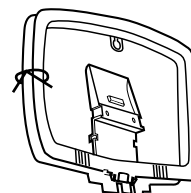

### FM Antenna

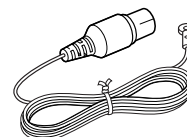

### Registration Card

### User Guide



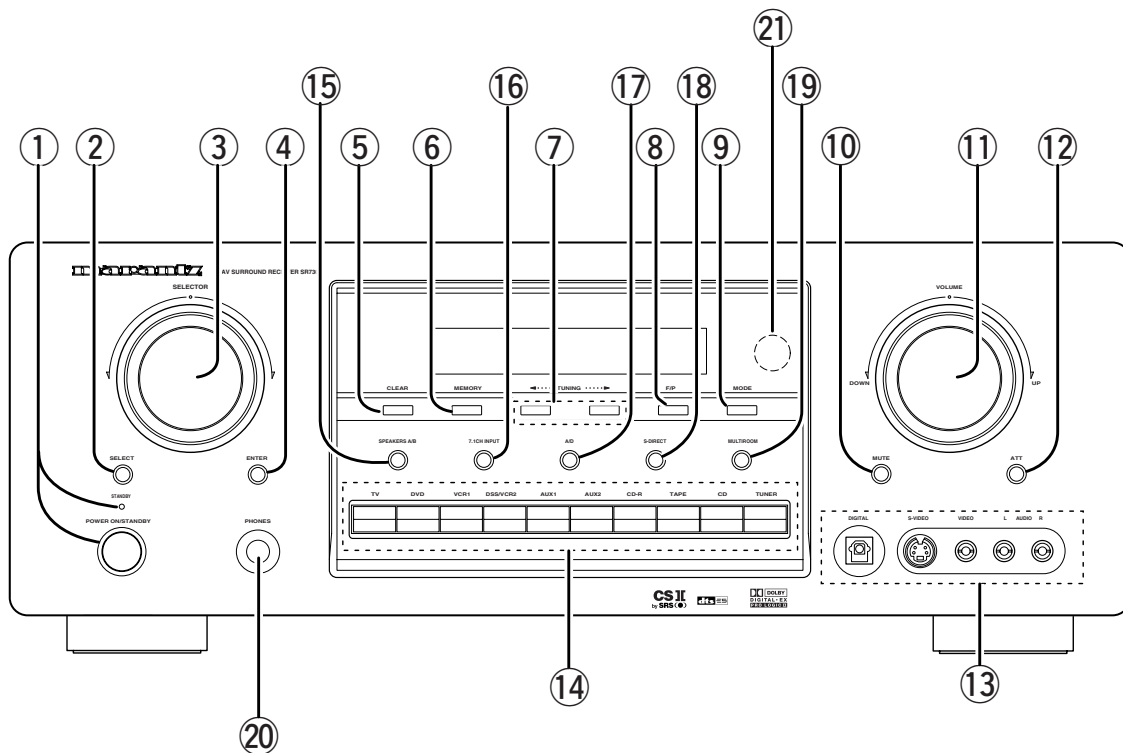

**① POWER switch and STANDBY indicator**  
 When this switch is pressed once, the unit turns ON and display appears on the display panel. When pressed again, the unit turns OFF and the STANDBY indicator lights. When the STANDBY indicator is turned on, the unit is NOT disconnected from the AC power.

**② SELECT (MULTI FUNCTION MODE SELECT) button**  
 Press this button to change the mode for MULTI FUNCTION control dial.

**③ SURROUND MODE Selector & MULTI FUNCTION control dial**  
 This dial changes surround mode sequentially or select contents of OSD menu system.

**④ ENTER (MULTI FUNCTION ENTER) button**  
 Press this button to enter the setup by MULTI FUNCTION dial.

**⑤ CLEAR button**  
 Press this button to cancel the station-memory setting mode or preset scan tuning. (See page 35)

**⑥ MEMORY button**  
 Press this button to enter the tuner preset memory numbers or station names. (See page 35)

**⑦ TUNING ◀ (Down) / ▶ (Up) buttons**  
 Press these buttons to change the frequency or the preset number. These buttons can change setup parameter to each content in OSD menu system. (See page 35)

**⑧ F/P (Frequency / Preset) button**  
 During reception of AM or FM, you can change the function of the UP/DOWN buttons for scanning frequencies or selecting preset stations by pressing these buttons. (See page 35)

**⑨ MODE button**  
 Press this button to select the auto stereo mode or mono mode when the FM band is selected. The "AUTO" indicator lights in the auto stereo mode. (See page 35)

**⑩ MUTE button**  
 Press this button to mute the output to the speakers. Press it again to return to the previous volume level.

**⑪ VOLUME control knob**  
 Adjusts the overall sound level. Turning the control clockwise increases the sound level.

**⑫ ATT (Attenuate) button**  
 If the selected analog audio input signal is greater than the capable level of internal processing, PEAK indicator will light. If this happens, you should press the ATT button. "ATT" is displayed when this function is activated. The signal-input level is reduced by about the half. Attenuation will not work with the output signal of "REC OUT" (TAPE, CD-R/MD, VCR1 and VCR2 output). This function is memorized for each input function.

**13 AUX1 input jacks**

These auxiliary video/audio and optical digital input jacks accept the connection of a camcorder, portable DVD, game etc.

**14 INPUT FUNCTION SELECTOR buttons (AUDIO/ VIDEO)**

These buttons are used to select the input sources.

The video function selector, such as TV, DVD, VCR1, DSS and AUX1, selects video and audio simultaneously.

Audio function sources such as CD, TAPE, CDR/MD, TUNER, and AUX2 may be selected in conjunction with a Video source.

This feature (Sound Injection) combines a sound from one source with a picture from another.

Choose the video source first, and then choose a different audio source to activate this function.

Press TUNER button to switch the between FM or AM.

**15 SPEAKERS A/B button**

Press these buttons to select speakers systems A and/or B.

**16 7.1CH IN button**

Press this button to select the output of an external multi channel decoder.

**17 A/D (Analog/Digital) SELECTOR button**

This is used to select between the analog and digital inputs.

**Note:**

- This button is not used for an input source that is not set to a digital input in the system setup menu.

**18 S- (Source) DIRECT button**

When this button is pressed, the tone control circuitry is bypassed as well as Bass Management.

**Notes:**

- The surround mode is automatically switched to AUTO when the source direct function is turned on.
- Additionally, Speaker Configurations are fixed automatically as follow.  
Front SPKR = Large, Center SPKR = Large,  
Surround SPKR = Large, Sub woofer = On

**19 MULTI (Multi Room) button**

Press this button to activate the Multiroom system . "MULTI " indicator will light in the display.

**20 PHONES jack for stereo headphones**

This jack may be used to listen to the SR7300's output through a pair of headphones. Be certain that the headphones have a standard 1 / 4" stereo phone plug. Note that the main room speakers will automatically be turned off when the headphone jack is in use.

**Notes:**

- When using headphones, the surround mode will automatically change to STEREO.
- The surround mode returns to the previous setting as soon as the plug is removed from the jack.

**21 INFRARED receiving sensor window**

This window receives infrared signals for the remote control unit.

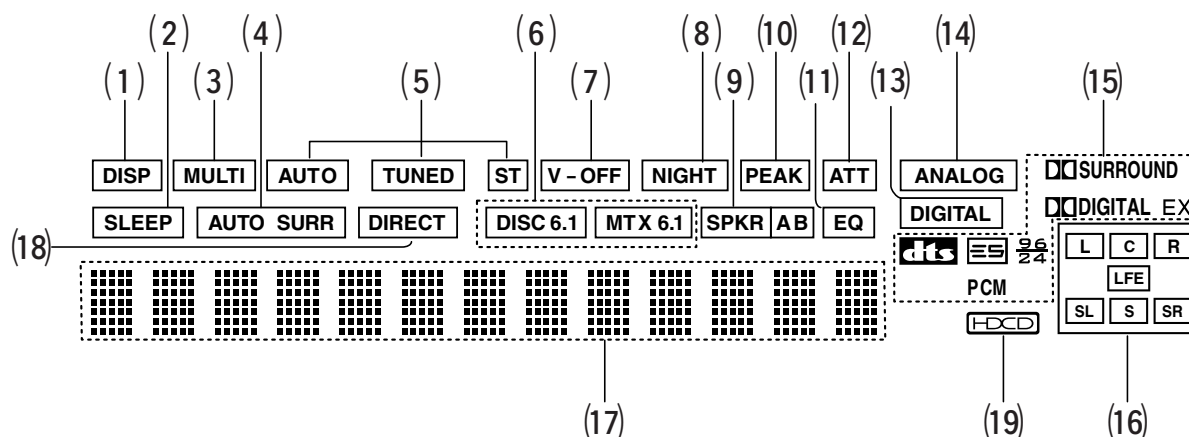

**(1) DISP (Display Off) indicator**

This indicator lights when the SR7300 is in the display off condition.

**(2) SLEEP timer indicator**

This indicator lights when the sleep timer function in main-room is in use.

**(3) Multi-room system indicator**

This indicator lights when the multi-room system is active.

**(4) AUTO SURR (Auto Surround mode) indicator**

This indicator illuminates to show that the AUTO SURROUND mode is in use.

**(5) TUNER's indicators**

**AUTO** : This indicator illuminates when the tuner's Auto mode is in use.

**TUNED** : This indicator illuminates when a station is being received with sufficient signal strength to provide acceptable listening quality.

**ST(Stereo)** : This indicator illuminates when an FM station is being tuned in stereo condition.

**(6) DTS-ES mode indicators (DISC6.1, MTX6.1)**

These indicators will show to DTS-ES decoding mode (Discret 6.1 or Matrix 6.1).

**(7) V (video)-OFF mode indicator**

This indicator lights when the Video-OFF function is active.

**(8) NIGHT mode indicator**

This indicator lights when the SR7300 is in the Night mode, which reduces the dynamic range of digital program material at low volume levels.

**(9) SPKR (speaker) AB indicator**

Active speaker system will be shown by this indicator.

**(10) PEAK indicator**

This indicator is a monitor for an analog audio input signal. If the selected analog audio input signal is greater than the capable level of internal processing, this will light. If this happens, you should press the ATT button.

**(11) EQ mode indicator**

This indicator lights when the HT-EQ function is active.

**(12) ATT (Attenuation) indicator**

This indicator lights when the attenuation function is active.

**(13) DIGITAL Input Indicator**

This indicator lights when digital input has been selected.

**(14) ANALOG input indicator**

This indicator lights when an analog input source has been selected.

**(15) SIGNAL FORMAT indicators**

**DIGITAL, EX, SURROUND, dts, ES, 96/24, PCM**

When the selected input is a digital source, some of these indicators will light to display the specific type of signal in use.

**(16) ENCODED CHANNEL STATUS indicators**

These indicators display the channels that are encoded with a digital input signal. If the selected digital input signal is Dolby Digital 5.1ch or DTS 5.1ch, "L", "C", "R", "SL", "SR" and "LFE" will light up. If the digital input signal is 2 channel PCM-audio, "L" and "R" will be displayed. If Dolby Digital 5.1ch signal with Surround EX flag or DTS-ES signal comes in, "L", "C", "R", "SL", "S", "SR" and "LFE" will show.

**(17) Main Information Display**

This display shows messages relating to the status, input source, surround mode, tuner, volume level or other aspects of unit's operation.

**(18) DIRECT (Source direct) indicator**

This indicator lights when the SR7300 is in the SOURCE DIRECT mode.

**(19) HDCD indicator (OSE version only)**

When HDCD signal is decoded, this indicator will light up.

# REAR PANEL

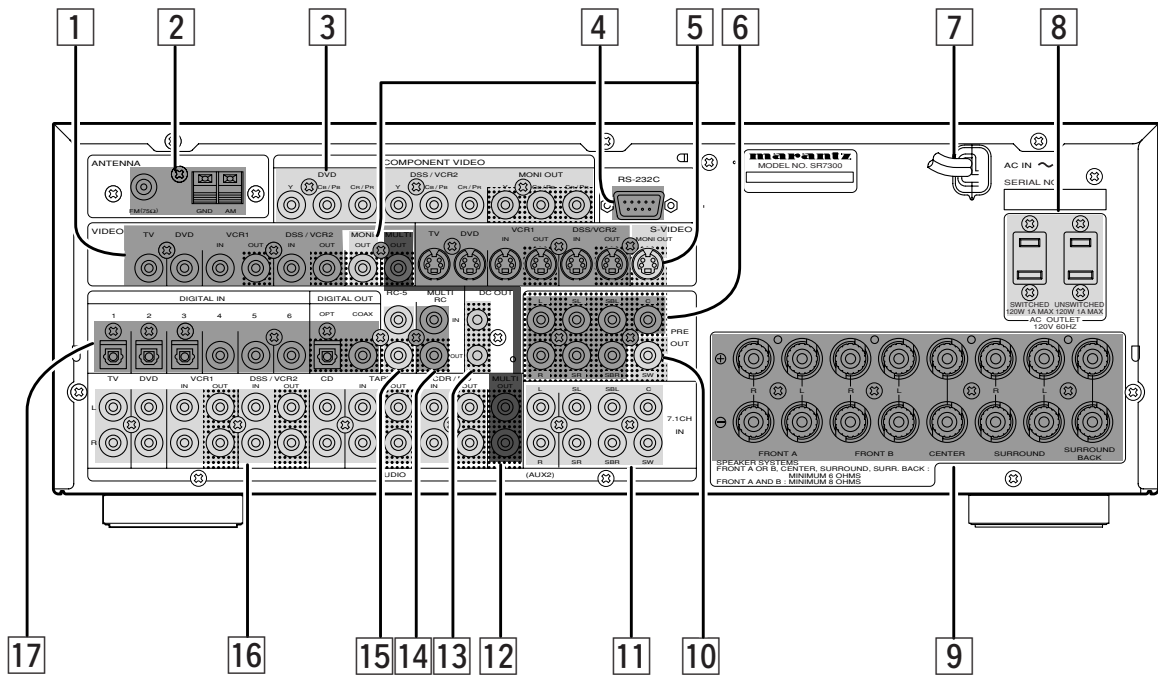

## 1 VIDEO IN/OUT (TV, DVD, VCR1, DSS/VCR2)

These are the video inputs and outputs. There are 4 video inputs and 2 video outputs and each one includes both composite video and S-video configurations. Connect VCRs, DVD players, and other video components to the video inputs.

S-video sources can be viewed through the S-video outputs, and composite sources can only be viewed through the composite output. The 2 video output channels can be used to be connected to video tape recorders for making recordings.

## 2 FM antenna terminal (75 ohms)

Connect an external FM antenna with a coaxial cable, or a cable network FM source.

### AM antenna and ground terminals

Connect the supplied AM loop antenna. Use the terminals marked "AM" and "GND". The supplied AM loop antenna will provide good AM reception in most areas. Position the loop antenna until you hear the best

## 3 COMPONENT VIDEO INPUT/OUTPUT

If your DVD player or other device has component video connectors, be sure to connect them to these component video connectors on the SR7300. The SR7300 has two component video input connectors to obtain the color information (Y, C<sub>B</sub>, C<sub>R</sub>) directly from the recorded DVD signal or other video component and one component video output connector to output it directly into the matrix decoder of the display device.

By sending the pure DVD component video signal directly, the DVD signal forgoes the extra processing that normally would degrade the image. The result is vastly increased image quality, with incredibly lifelike colors and crisp detail.

### Notes:

- This component video output is disable to OSD menu system.

## 4 RS232C

The RS232C port is to be used in conjunction with an external controller to control the operation of the SR7300 by using an external device.

The RS232C port may also be used in the future to update the operating software of the SR7300 so that it will be able to support new digital audio formats and the like as they are introduced.

## 5 MONITOR OUT

This is a monitor output and each one includes both composite video and S-video configurations. When connecting two video monitors or televisions, be aware that the OSD interface can be used with both MONITOR OUT.

## 6 Preamp Outputs (L, R, SL, SR, SBL, SBR, C)

Jacks for L (front left), R (front right), C (Center), SL (surround left), SR (surround right), SBL (surround back left) and SBR (surround back right).

Use these jacks for connection to some external power amplifiers.

## 7 Power cable

Connect to AC power outlet.

SR7300 can be powered by 120 V AC only.

### Caution:

- In order to avoid potential turn-off thumps, anything plugged in here should be powered up BEFORE the SR7300 is turned on.

## 8 AC OUTLETS

Connect the AC power cables of components such as a DVD and CD player to these outlets. SWITCHED and UNSWITCHED outlets are provided.

The one marked SWITCHED provides power only when the SR7300 is turned on and is useful for components which you use every time you play your system.

The one marked UNSWITCHED is always live as long as the SR7300 is plugged into a live outlet.

A component connected here may be left on permanently, or may be switched off with its own power switch.

### Caution:

- In order to avoid potential turn-off thumps, anything plugged in here should be powered up before the SR7300 is turned on.
- The capacity of this AC outlet is 120W. Do not connect devices that consume electricity more than the capacity to this AC outlet. If total power consumption of connected devices exceeds the capacity, protection circuit shuts down the power supply.

## 9 Speaker outputs terminals (for Main room)

Six terminals are provided for the front left, front right, front center, surround left, surround right and surround back speakers.

## 10 Subwoofer Output

Connect this jack to the line level input of a powered subwoofer. If an external subwoofer amplifier is used, connect this jack to the subwoofer amplifier input. If you are using two subwoofers, either powered or with a 2 channel subwoofer amplifier, connect a "Y" connector to the subwoofer output jack and run one cable from it to each subwoofer amplifier.

## 11 7.1 CHANNEL or AUX2 INPUT

By connecting a DVD Audio player, SACD multi channel player, or other component that has a multi channel port, you can playback the audio with 5.1 channel or 7.1 channel output.

## 12 Multiroom Outputs (Audio L&R, Video)

These are the audio and video output jacks for the Multi zone (Multi room).

Connect these jacks to the optional audio power amplifiers or video display devices to listen and view to the source selected by the multiroom system in a remote room.

## 13 DC TRIGGER output terminals

Connect a device that needs to be triggered by DC under certain conditions (screen, power strip, etc...)

Use the system OSD setup menu to determine the conditions by which these jacks will be active.

### Note:

- This output voltage is for (status) control only, It is not sufficient for drive capability.

## 14 MULTI ROOM REMOTE IN/OUT terminals

IN: Connect to multi-room remote control device, available from your Marantz dealer.

OUT: Connect to the Marantz component equipped with remote control (RC-5) terminals in Multi zone (Multi room).

## 15 REMOTE CONT. IN/OUT terminals

Connect to a Marantz component equipped with remote control (RC-5) terminals.

## 16 AUDIO IN/OUT (CD, TAPE, CD-R, TV, DVD, VCR1, DSS/VCR2)

These are the analog audio inputs and outputs. There are 7 audio inputs (4 of which are linked to video inputs) and 4 audio outputs (2 of which are linked to video outputs). The audio jacks are nominally labeled for cassette tape decks, compact disc players, DVD players and etc.... The audio inputs and outputs require RCA-type connectors.

## 17 DIGITAL INPUT (Dig.1 - 6) / OUTPUT (coaxial, optical)

These are the digital audio inputs and outputs. There are 3 digital inputs with coaxial jacks, 3 with optical jacks.

The inputs accept digital audio signals from a compact disc, LD, DVD, or other digital source component.

For digital output, there is 1 coaxial output and 1 optical output.

The digital outputs can be connected to MD recorders, CD recorders, DAT decks, or other similar components.

# REMOTE CONTROLLER RC7300SR

## NAMES AND FUNCTIONS

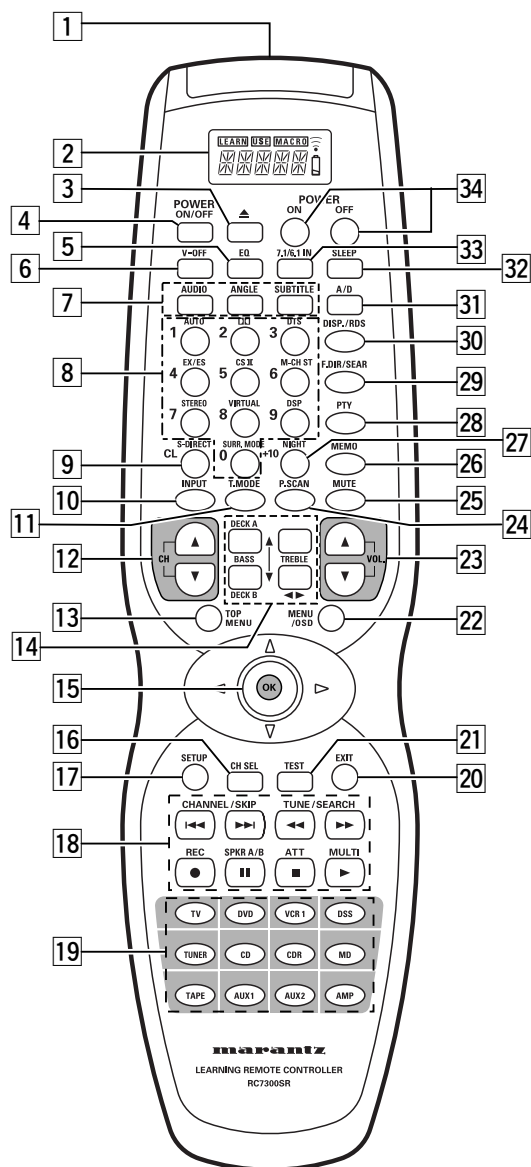

### 1 Infrared window

Outputs and inputs an infrared control signals.

### 2 LCD (Liquid Crystal Display)

Used to display information about currently selected functions.

### 3 ▲ (open/close) button

Used to open or close the door.

#### Note:

- This button is unavailable for SR7300.

### 4 Source POWER ON/OFF button

Used to turn specific sources (such as DVD players, etc.) ON and OFF independently from the rest of the system.

### 5 EQ button

Used to turn on or off HT (Home Theater)-EQ mode. This mode compensates for the audio portion of a movie sounding "bright". When this button is pressed, "HT-EQ" indicator lights up.

### 6 V-OFF (video off) button

Used to turn off the video signal.

### 7 DVD operating buttons

(when DVD mode is selected)

#### AUDIO button

Used to select one of the audio language.

#### ANGLE button

Used to change the different camera angle.

#### SUBTITLE button

Used to select one of the subtitle language.

### 8 Numeric buttons 1 to 9, 0 / Surround mode buttons

#### Numeric buttons

Used to enter figures in the selection of a tuner preset station and station name preset or to set select a CD track number, etc. The functions of these buttons are dependent on the function button selected.

#### Surround mode buttons (when AMP mode is selected)

Used to select the surround mode.

### 9 CL (clear) / S-DIRECT (source direct) button

Used to cancel for certain memory or programming operations.

#### (when AMP mode is selected)

Used to select the S-DIRECT (source direct) mode. In source direct mode, the tone control circuitry is bypassed.

### 10 INPUT button

Used to select monitor input.

#### Note:

- This button is unavailable for SR7300.

### 11 T.MODE button

(when TUNER mode is selected)

Used to select the auto stereo mode or mono mode when the FM band is selected.

The "AUTO" indicator lights in the auto stereo mode.

### 12 (TV) CH ▲/▼ buttons

Used to increase or decrease the TV channel.

### 13 TOP MENU button

(when DVD mode is selected)

Used to call up the top menu of the DVD.

### 14 Tone / Deck control buttons

#### Tone control buttons (when AMP mode is selected)

The TREBLE buttons are used to adjust the tone control of high frequency sound for left and right speaker.

The BASS buttons are used to adjust the tone control of low frequency sound for left, right and subwoofer speaker.

#### Deck control buttons (when Tape mode is selected)

The DECK A button are used to select the deck A.

The DECK B button are used to select the deck B.

The ◀▶ button are used to change the direction.

**15 CURSOR / OK button**

Used to operate on-screen and other displays used by receivers and other components.

**16 CH SEL. (channel select) button**

*(when AMP mode is selected)*

Used to call up SETUP MAIN MENU and adjust speaker levels or 7.1 ch input level.

**17 SETUP button**

*(when AMP mode is selected)*

Used to call up the SETUP MAIN MENU of the SR7300.

**18 CONTROL buttons**

These buttons are used when operating the CD player, TAPE deck, etc.

The function of these buttons are dependent on the function button selected.

*(when AMP mode is selected)*

**ATT button**

When the input signal is too high and the voice distorts even by throttling the SR7300 VOLUME control, turn on this function. "ATT" is indicated when this function is activated.

The input level is reduced. Attenuator is invalid for use with the output signal of "REC OUT".

**Note:**

- This function is unavailable during the digital input is selected.

**SPKR A/B button**

Speaker mode is switched in the following sequence.

A → B → A+B → off

**MULTI button**

This button is used to switch the unit to multi room mode.

**19 Input selector buttons/ FUNCTION SELECTOR buttons (AUDIO/VIDEO INPUT)**

Used to switch the remote controller to the command sets for specific sources (amplifier, receiver, etc.), thereby allowing a single remote controller to control up to 11 different components. To use these buttons to switch the amplifier's source, press the desired button twice within 2 seconds. The AMP button is used only to switch command set of the remote controller itself and therefore does not transmit any signal. Further, the function buttons may also be programmed to execute macros. (A macro allows a complex string of operations to be performed in series simply by pressing a single button.) One button can be programmed to learn sequences containing up to 10 commands. The following is an example of such a sequence that can be activated automatically using a macro:

Turn the receiver ON → Switch the function to DVD → Set the Surround Mode to VIRTUAL → Set the DVD player to Play.

**20 EXIT button**

*(when AMP mode is selected)*

Used to exit setup menu.

**21 TEST button**

*(when AMP mode is selected)*

Used to enter the test tone menu.

**22 MENU/OSD button**

*(when AMP mode is selected)*

When this button is pressed, the current setting are displayed on the TV monitor.

**23 VOLUME ▲ / ▼ buttons**

Used to adjust the volume on receivers and other components (TV) equipped with volume control.

**24 P.SCAN (preset scan) button**

*(when TUNER mode is selected)*

Used to start preset scan when SR7300 is selected TUNER mode.

**25 MUTE button**

Muting button of the SR7300. Press this button decrease the sound temporarily. Press this button again to return to the previous sound.

**26 MEMO button**

Memory enable button for various preset functions.

**27 NIGHT button**

*(when AMP mode is selected)*

Pressing this button prevents the Dolby Digital signal from playback at a loud voice. This function reduces the voice by 1/3 to 1/4 at maximum. Thus, it eliminates the occurrence of an abruptly loud voice at night. However, the function is valid only for the case when the Dolby Digital signal is entered into OPTICAL or COAXIAL and data to compress the voice exists in the signal to be played back.

When this button is pressed, "NIGHT" indicator lights up.

**28 PTY button (European model only)**

*(when TUNER mode is selected)*

Used to display the programme type information of the current station. The RDS system categorizes programmes according to their genre into different programme type (PTY) groups.

**29 F.DIR/SEAR button**

*(when TUNER mode is selected)*

Used to select the mode of frequency direct input.

**30 DISP./RDS button**

*(when TUNER mode is selected: European model only)*

Selects display mode function in RDS (Radio Data System) by this button.

*(when AMP mode is selected)*

Selects the display mode for the front display of the SR7300.

**31 A/D button**

This is used to switch between the analog and digital inputs.

**32 SLEEP (sleep timer) button**

This button is used for setting the sleep timer. It can be operated the same way as the button in unit.

**33 7.1/6.1CH IN button**

Press this button to select the output of an external multi channel decoder.

**34 POWER ON, OFF buttons**

*(when AMP mode is selected)*

Press to switch the power of the SR7300 ON or OFF.

## LCD (Liquid Crystal Display)

Information about currently selected functions and modes is displayed on the LCD.

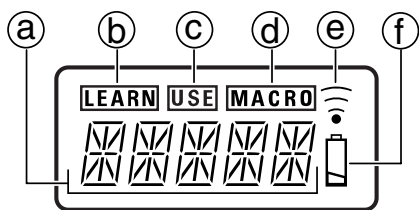

### Ⓐ Function Name indicator

Displays the name of the currently selected function (DVD, TV, etc.) using up to 5 characters.

### Ⓑ LEARN indicator

Indicates when the remote controller is in the LEARN mode.

### Ⓒ USE indicator

For normal operation the USE indicator is displayed.

### Ⓓ MACRO indicator

Indicates when the remote controller is in the MACRO mode.

### Ⓔ Transmission indicator

Indicates when the remote controller is transmitting a signal.

### Ⓕ Low battery indicator

When this indicator appears, the batteries should be replaced.

## REMOTE CONTROL RANGE

The distance between the transmitter of the remote control unit and the IR SENSOR of the SR7300 should be less than about 5 meters. If the transmitter is pointed to a direction other than the IR SENSOR or if there is an obstacle between them, remote control may not be possible.

### Remote-controllable range

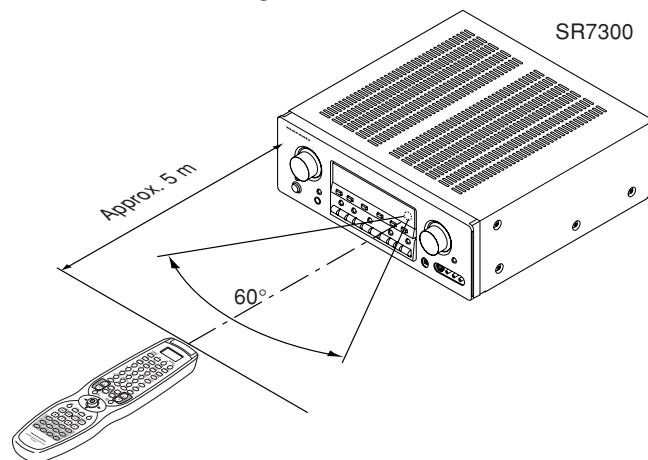

Remote control unit (RC7300SR)

## LOADING BATTERIES

The life of the batteries used with the remote control unit is about 4 months with normal use. Also be sure to replace batteries earlier when you notice that they are getting weak.

1. Remove the back cover.

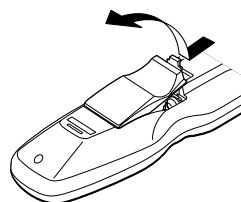

2. Insert the new batteries (AA type) with correct (+) and (-) polarity.

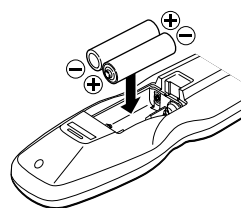

3. Close until it clicks.

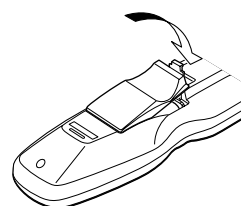

### Note:

- The supplied batteries are shipped to confirm the initial operation. Therefore, the supplied batteries will be consumed quickly.



# GENERAL INFORMATION OF RC7300SR TO SR7300

To control the SR7300 by your RC7300SR, you have to select the device AMP or TUNER by function selector button. Please refer as below for the details in AMP and TUNER mode.

## AMP MODE

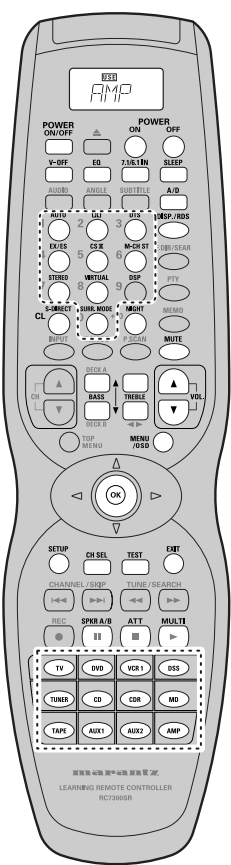

## TUNER MODE

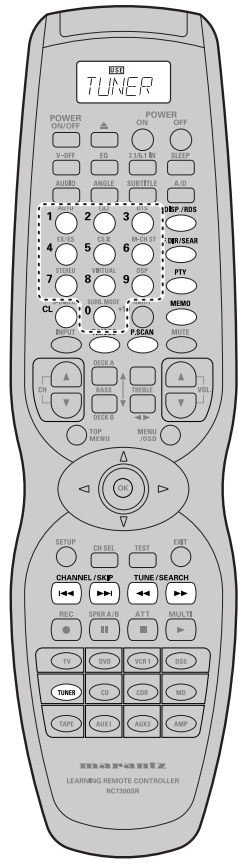

POWER ON/OFF	Turns the SR7300 on and off
POWER ON	Turns the SR7300 on
POWER OFF	Turns the SR7300 off
V-OFF	Turns on or off Video OFF mode
EQ	Turns on or off HT-EQ mode
7.1/6.1 IN	Selects the 7.1CH IN
SLEEP	Sets the sleep timer function
A/D	Switches between the analog and digital inputs
DISP./RDS	Changes the front display mode
Surround mode (0-9)	Selects the surround mode * DSP button is unavailable to SR7300.
S-DIRECT	Selects the Source Direct mode
NIGHT(+10)	Turns on or off NIGHT mode
MUTE	Decreases the sound temporarily
BASS ▲▼	Adjusts the tone control of low frequency sound
TREBLE ▲▼	Adjusts the tone control of high frequency sound
VOL ▲▼	Adjusts the over all sound level
MENU/OSD	Displays the current setting on the monitor
Cursor	Moves the cursor for setting in "On screen display" mode
OK	• Enter the "On screen display" • Confirms the setting in "On screen display" mode
SETUP	Same as OK button
CH SEL	Calls up SETUP MENU and adjusts speaker levels or 7.1ch input level
TEST	Enters the test tone menu
EXIT	Exits from SETUP MAIN MENU
SPKR A/B	Selects the speaker system
ATT	Reduces the input level
MULTI	Turns the multi room mode on or off
Function selector	Selects a particular source component

0-9	Inputs the numeric
DISP./RDS	Selects the display mode in RDS (*)
F.DIR/SEAR	Selects the "Frequency direct input"
PTY	Displays the program type information of the current station (*)
MEMO	Enters the tuner preset memory numbers
CL	Clears the inputting
T.MODE	Selects the auto stereo mode or mono mode
P.SCAN	Starts preset scan
CHANNEL/SKIP	• Selects a preset station • Changes a PTY type
TUNE/SEARCH	Tunes a station
TUNER	Selects a frequency band

(\*): European model only

## CONNECTIONS

### SPEAKER PLACEMENT

The ideal surround speaker system for this unit is 7-speaker systems, using front left and right speakers, a center speaker, surround left and right speakers, a surround back and a subwoofer.

For best results we recommend that all front speakers be of the same type, with identical or similar driver units. This will deliver smooth pans across the front sound stage as the action moves from side to side.

Your center channel speaker is very important as over 80 % of the dialog from a typical motion picture emanates from the center channel. It should possess similar sonic characteristics to the main speakers. Surround channel speakers need not be identical to the front channel speakers, but they should be of high quality.

The surround center speaker is useful for playback of Dolby Digital Surround EX or DTS-ES. One of the benefits of both Dolby Digital (AC-3) and DTS is that surround channels are discrete full range, while they were frequency limited in earlier "Pro Logic" type systems. Bass effects are an important part of home theater. For optimal enjoyment a subwoofer should be used as it is optimized for low frequency reproduction. If you have full range front speakers, however, they may be used in place of a subwoofer with proper setting of the switches in the menu system.

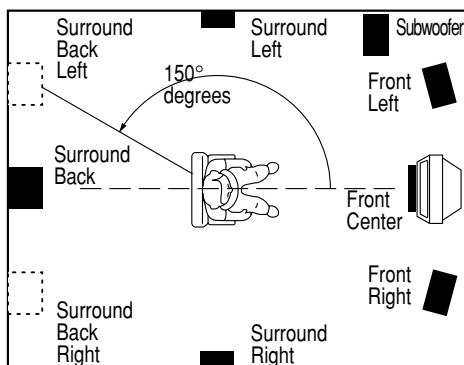

#### Front left and right speakers

We recommend to set the front L and R speakers with 45-60 degrees from the listening position.

#### Center speaker

Align the front line of the center speaker with the front L/R speakers. Or place the center speaker a little backward from the line.

#### Surround left and right speakers

Place the speakers right beside of the listening position or a little forward.

#### Surround back speaker

Place the speaker behind of the listening position.

#### Surround back left and right speaker

Place the speaker behind of the listening position.

#### Subwoofer

We recommend to use a sub-woofer to have maximum bass effect. Sub-woofer bears only low frequency range so you can place it anywhere in the room.

### HEIGHT OF THE SPEAKER UNITS

#### Front left and right speakers, and a center speaker

Align the tweeters and mid-range drivers on the three front speakers on the same height as well as possible.

#### Surround left and right speakers, and surround back speaker

Place the surround left, right and surround back speakers higher to your ears 2 Ft. - 3 Ft. (70cm - 1m). Also place the speakers on the same height.

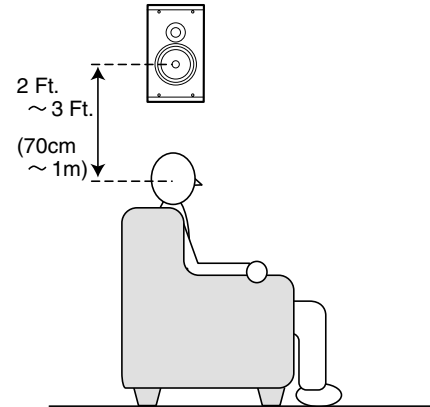

#### Note;

- Use magnetically-shielded speakers for front left, right and the center speakers when the speakers are installed near the TV and the TV is a monitor type.

## CONNECTING SPEAKERS

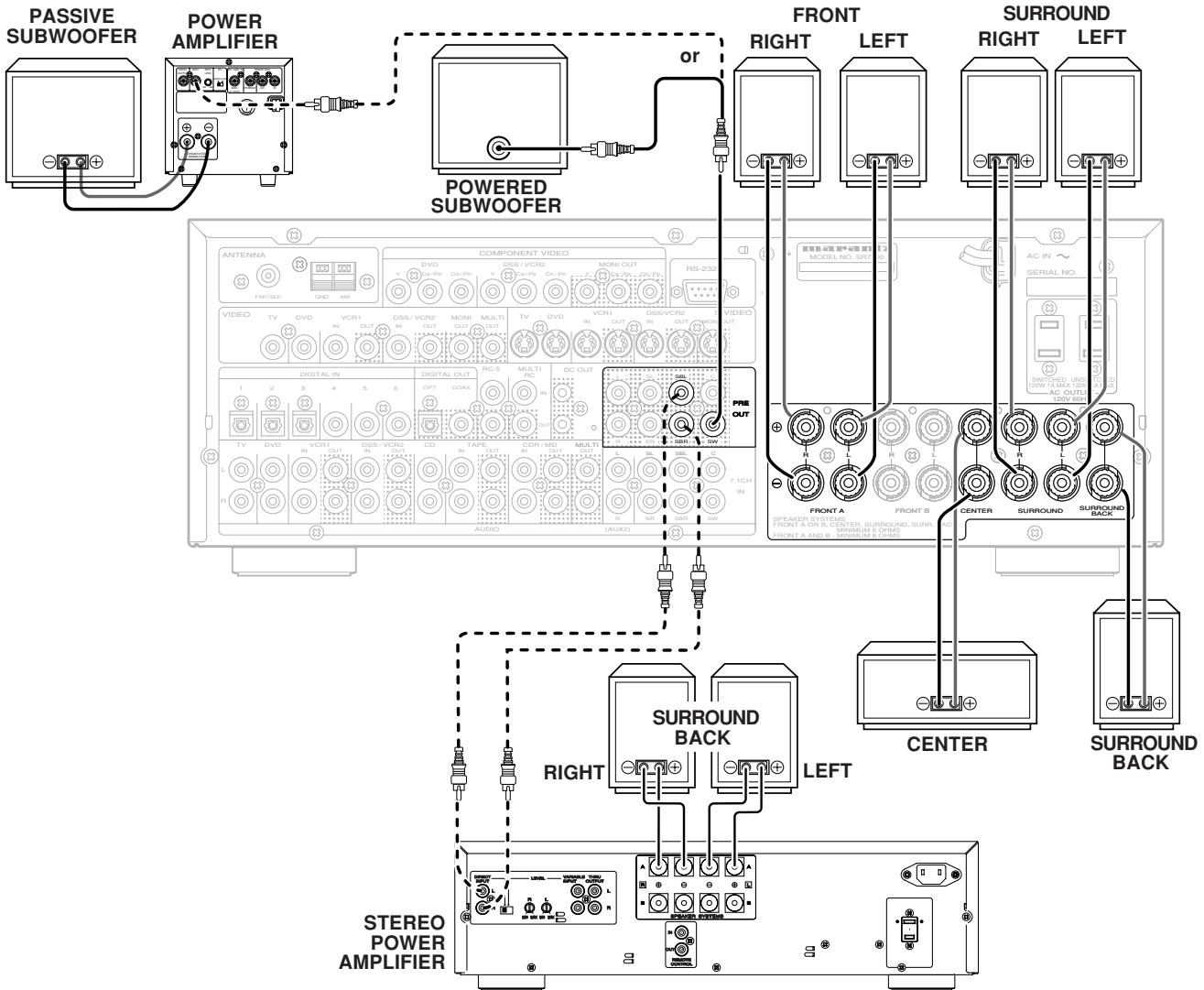

### CONNECTING SPEAKER WIRE

1. Strip away approx. 3/8 inch (10 mm) of wire insulation.
2. Twist the bared wire ends tight to prevent short circuits.
3. Loosen the knob by turning counterclockwise.
4. Insert the bare part of the wire into the hole in the side of each terminal.
5. Tighten the knob by turning clockwise to secure the wire.

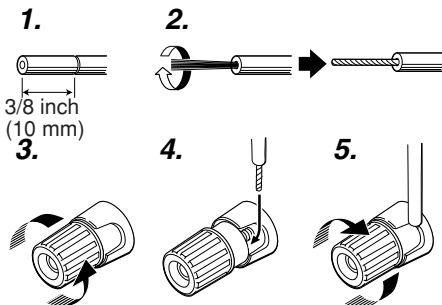

### CONNECTING BANANA PLUG

Banana plug connections are also possible. Tighten the knob by turning clockwise and then insert the banana plug.

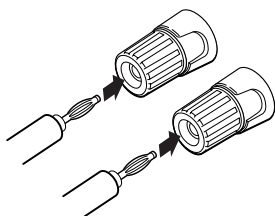

### Caution:

- Be sure to use speakers with the specified impedance shown on the rear panel of this unit.
- To prevent damage to circuitry, do not let the bare speaker wires touch each other and do not let them touch any metal part of this unit.
- Do not touch the speaker terminals when the power is on. It may cause electric shocks.
- Do not connect more than one speaker cable to one speaker terminal. Doing so may damage this unit.

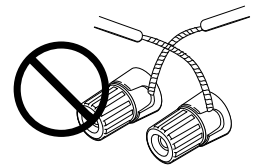

### Note:

- Be sure to connect the positive and negative cables for the speaker properly. If they are miss-connected, the signal phase will be reversed and the signal quality will be corrupted.

### CONNECTING A SUBWOOFER

Use the PRE OUT SUBWOOFER jack to connect a powered subwoofer (power amplifier built in). If your subwoofer is passive type (power amplifier is not built in), connect a monaural power amplifier to the PRE OUT SUBWOOFER jack and connect the subwoofer to the amplifier.

## CONNECTING AUDIO COMPONENTS

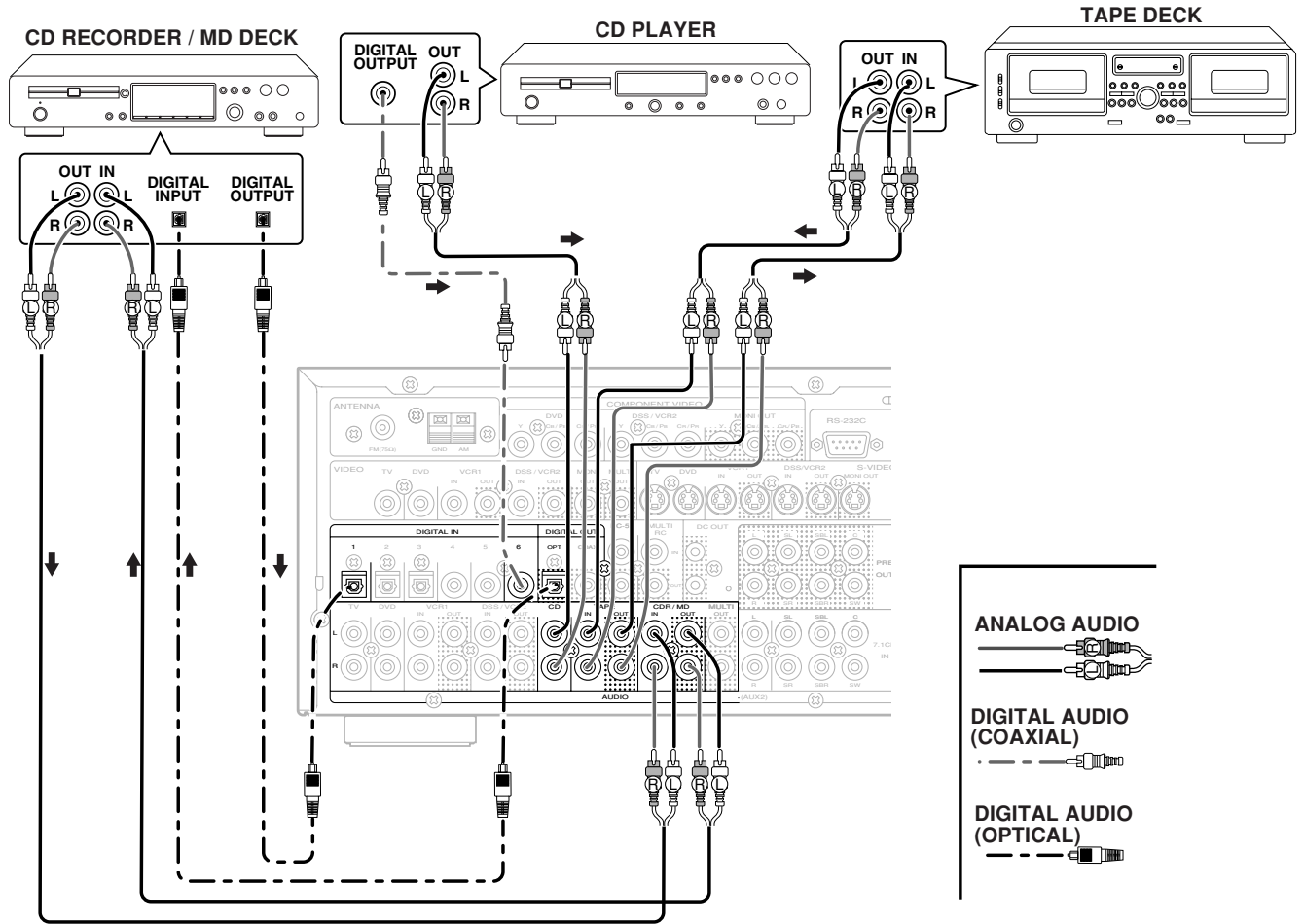

The output audio signal from the TAPE OUT jack and the CD-R/MD OUT jack is the sound source currently selected.

**Caution:**

- Do not connect this unit and other components to mains power until all connections between components have been completed.

**Notes:**

- Insert all plugs and connectors securely. Incomplete connections may make noise.
- Be sure to connect the left and right channels properly. Red connectors are for the R (right) channel, and white connectors are for the L (left) channel.
- Be sure to connect input and output properly.
- Refer to the instructions for each component that is connected with this unit.
- Do not bind audio/video connection cables with power cords and speaker cables will result in generating hum or other noise.

### CONNECTING DIGITAL AUDIO COMPONENTS

- There are 6 digital inputs, 3 coaxial jacks and 3 optical jacks, on the rear panel. You can use these jacks to input PCM, Dolby Digital and DTS bitstream signals from a CD, DVD, or other digital source components.
- There are one digital output with coaxial jack and one with optical jack on the rear panel. These jacks can be connected to CD recorder, MD deck.

- Setup the digital audio format of DVD player, or other digital source component. Refer to the instructions for each component to be connected to digital input jacks.
- Use fiber optical cables (optical) for DIG-1,2,3 input jacks. Use 75 ohms coaxial cables (for digital audio or video) for DIG-4, 5, 6 input jacks.
- You can designate the input for each digital input/output jacks according to your component. See page 22.

**Notes:**

- There is no Dolby Digital RF input jack. Please use an external RF demodulator Dolby Digital decoder when connecting the Dolby Digital RF output jack of the video disc player to the digital input jack.
- The digital signal jacks on this unit conform to the EIA standard. If you use a cable that does not conform to this standard, this unit may not function properly.
- Each type of audio jack works independently. Signals input through the digital and analog jacks are output through the corresponding digital and analog jacks, respectively.

# CONNECTING VIDEO COMPONENTS

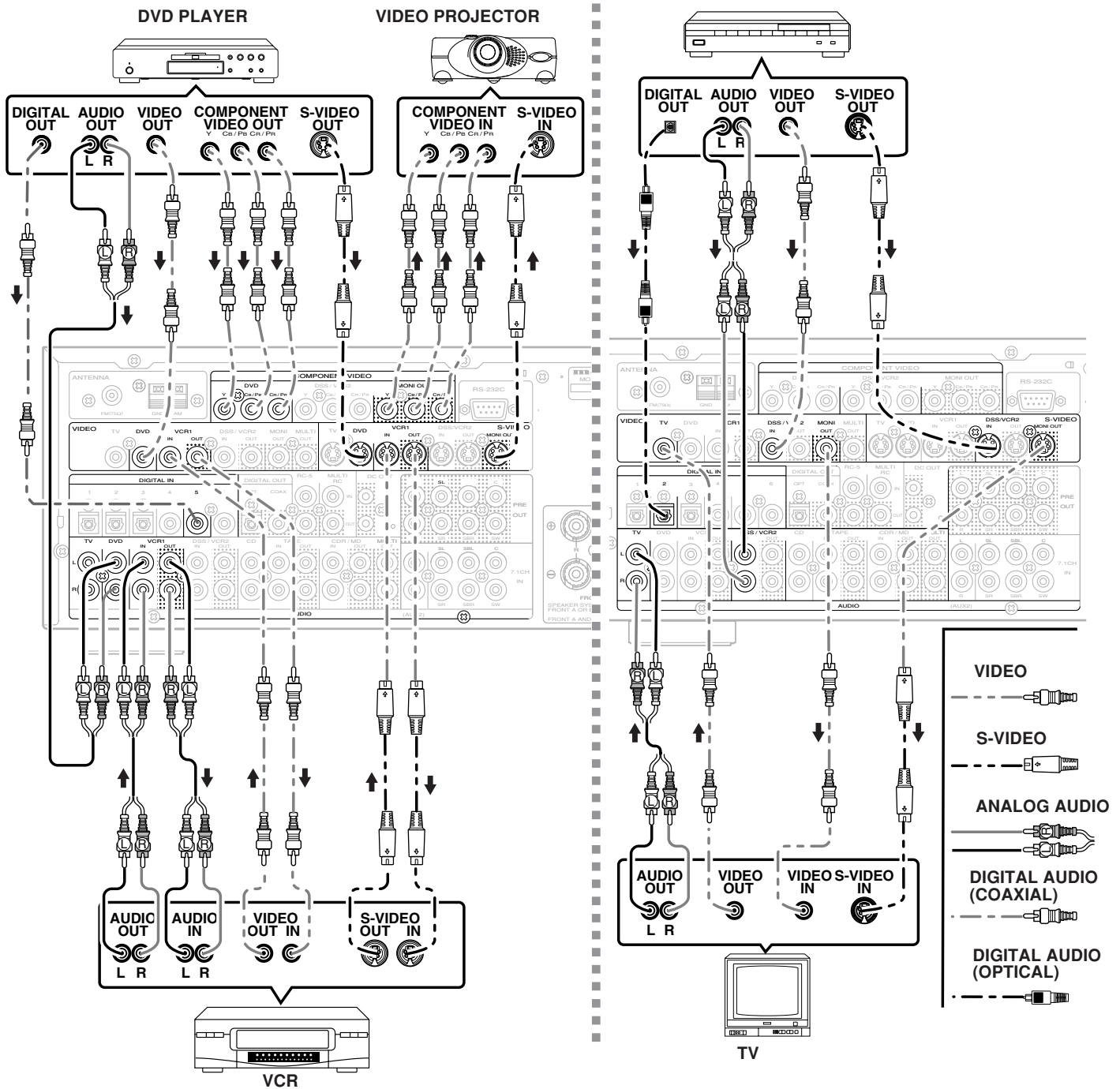

## VIDEO, S-VIDEO, COMPONENT JACKS

There are 3 types of video jacks on the rear panel.

### VIDEO jack

The video signal for the VIDEO jacks is the conventional composite video signal.

### S-VIDEO jack

The video signal is separated into luminance (Y) and color (C) signals for the S-VIDEO jack. The S-VIDEO signals enables high-quality color reproduction. If your video component has an S-VIDEO output, we recommend to use it. Connect the S-VIDEO output jack on your video component to the S-VIDEO input jack on this unit.

### Component jack

Make component video connections to a TV or monitor with component inputs to produce a higher quality video images. Use component video cable or 3 video cords to connect the component video out jacks on the SR7300 to the monitor.

### Notes:

- Be sure to connect the left and right audio channels properly. Red connectors are for the R (right) channel, and white connectors are for the L (left) channel.

- Be sure to connect input and output of video signal properly.
- If you connect the S-VIDEO or component signal to the S-VIDEO or component jack on this unit, it is not necessary to connect the conventional video signal to the VIDEO (composite) jack. If you use both video inputs, this unit gives priority to the S-VIDEO signal.
- Each type of video jack works independently. Signals input to the VIDEO (composite) and S-VIDEO jacks or component are output to the corresponding VIDEO (composite) and S-VIDEO or component jacks, respectively.
- This unit has the "TV-AUTO ON/OFF" function to turn ON or OFF automatically the power by the incoming video signal from VIDEO jacks.
- You may need to setup the digital audio output format of your DVD player, or other digital source component. Refer to the instructions of the each component connected to the digital input jacks.
- There is no Dolby Digital RF input jack. Please use an external RF demodulator with Dolby Digital decoder to connect a video disc player with the Dolby Digital RF output jack to the digital input jack on this unit.

## ADVANCED CONNECTING

### DVD AUDIO PLAYER or SACD MULTI CHANNEL PLAYER

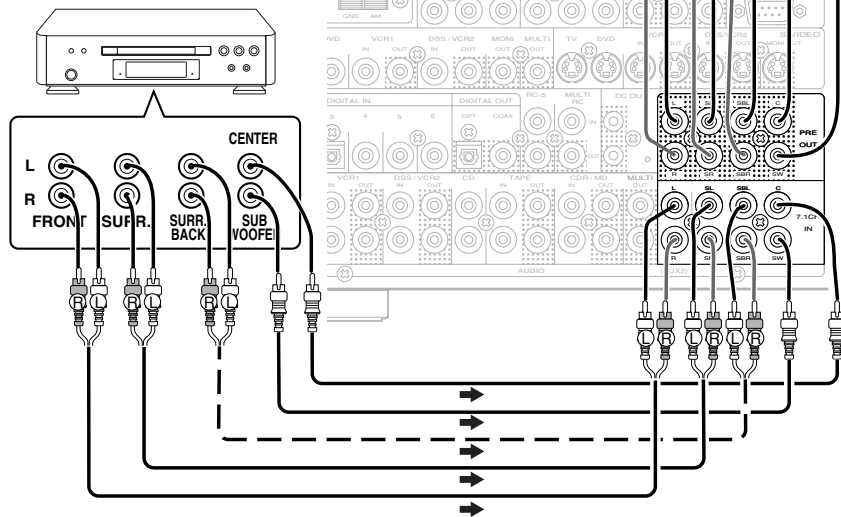

### CONNECTING MULTI CHANNEL AUDIO SOURCE

The 7.1CH INPUT jacks are for multi channel audio source such as SACD multi channel player, DVD audio player or external decoder. If you use these jacks, switch on 7.1CH INPUT and setup 7.1CH INPUT level by using SETUP MAIN MENU. See page 26.

### CONNECTING EXTERNAL POWER AMPLIFIER

The PREOUT jacks are for connecting external power amplifiers, you can have better sound quality. Be sure to connect each speaker to the corresponding external power amplifier.

## CONNECTING REMOTE CONTROL JACKS

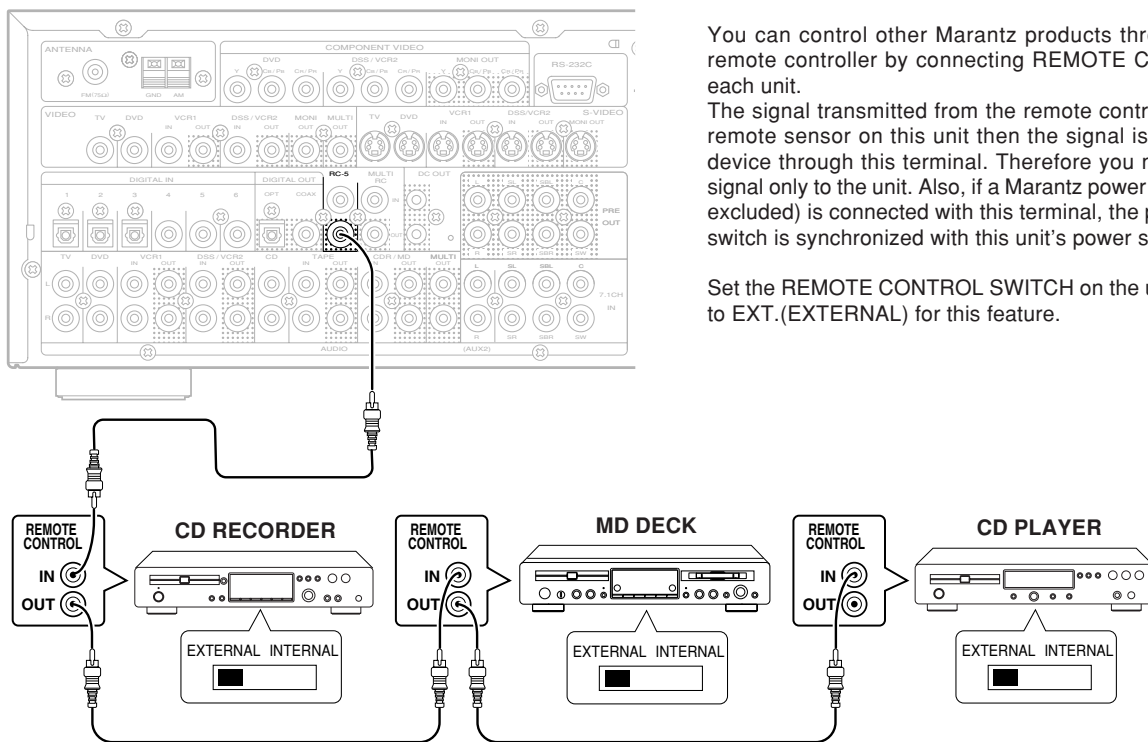

You can control other Marantz products through this unit with the remote controller by connecting REMOTE CONTROL terminals on each unit.

The signal transmitted from the remote controller is received by the remote sensor on this unit then the signal is sent to the connected device through this terminal. Therefore you need to aim the remote signal only to the unit. Also, if a Marantz power amplifier (some models excluded) is connected with this terminal, the power amplifier's power switch is synchronized with this unit's power switch.

Set the REMOTE CONTROL SWITCH on the units other than this unit to EXT.(EXTERNAL) for this feature.

## CONNECTING THE ANTENNA TERMINALS

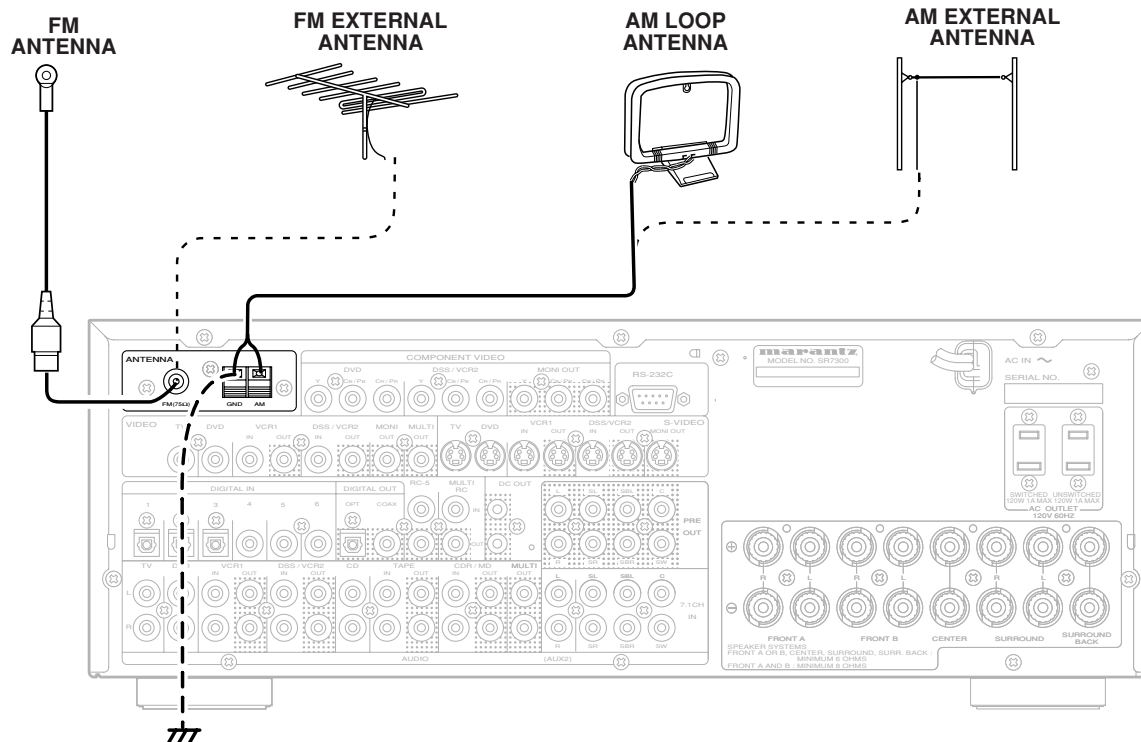

### ASSEMBLING THE AM LOOP ANTENNA

1. Release the vinyl tie and take out the connection line.
2. Bend in the reverse direction.
3. Inserting into the hole to attach the loop antenna to the antenna stand.
4. With the antenna on top any stable surface.

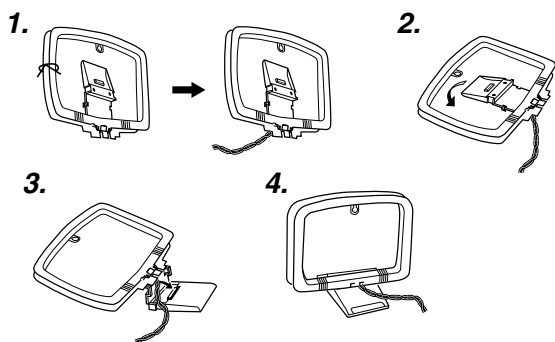

### CONNECTING THE SUPPLIED ANTENNAS

#### Connecting the supplied FM feeder antenna

The supplied FM feeder antenna is for indoor use only. During use, extend the antenna and move it in various directions until the clearest signal is received. Fix it with push pins or similar implements in the position that will cause the least amount of distortion. If you experience poor reception quality, an outdoor antenna may improve the quality.

#### Connecting the supplied AM loop antenna

The supplied AM loop antenna is for indoor use only. Set it in the direction and position where you receive the clearest sound. Put it as far away as possible from the unit, televisions, speaker cables, and power cords. If you experience poor reception quality, an outdoor antenna may improve the quality.

1. Press and hold down the lever of the AM antenna terminal.
2. Insert the bared wire into the antenna terminal.
3. Release the lever.

### CONNECTING AN FM OUTDOOR ANTENNA

#### Notes:

- Keep the antenna away from noise sources (neon signs, busy roads, etc.).
- Do not put the antenna close to power lines. Keep it well away from power lines, transformers, etc.
- To avoid the risk of lightning and electrical shock, grounding is necessary.

### CONNECTING AN AM OUTDOOR ANTENNA

An outdoor antenna will be more effective if it is stretched horizontally above a window or outside.

#### Notes:

- Do not remove the AM loop antenna.
- To avoid the risk of lightning and electrical shock, grounding is necessary.

CONNECTING FOR THE MULTI ROOM

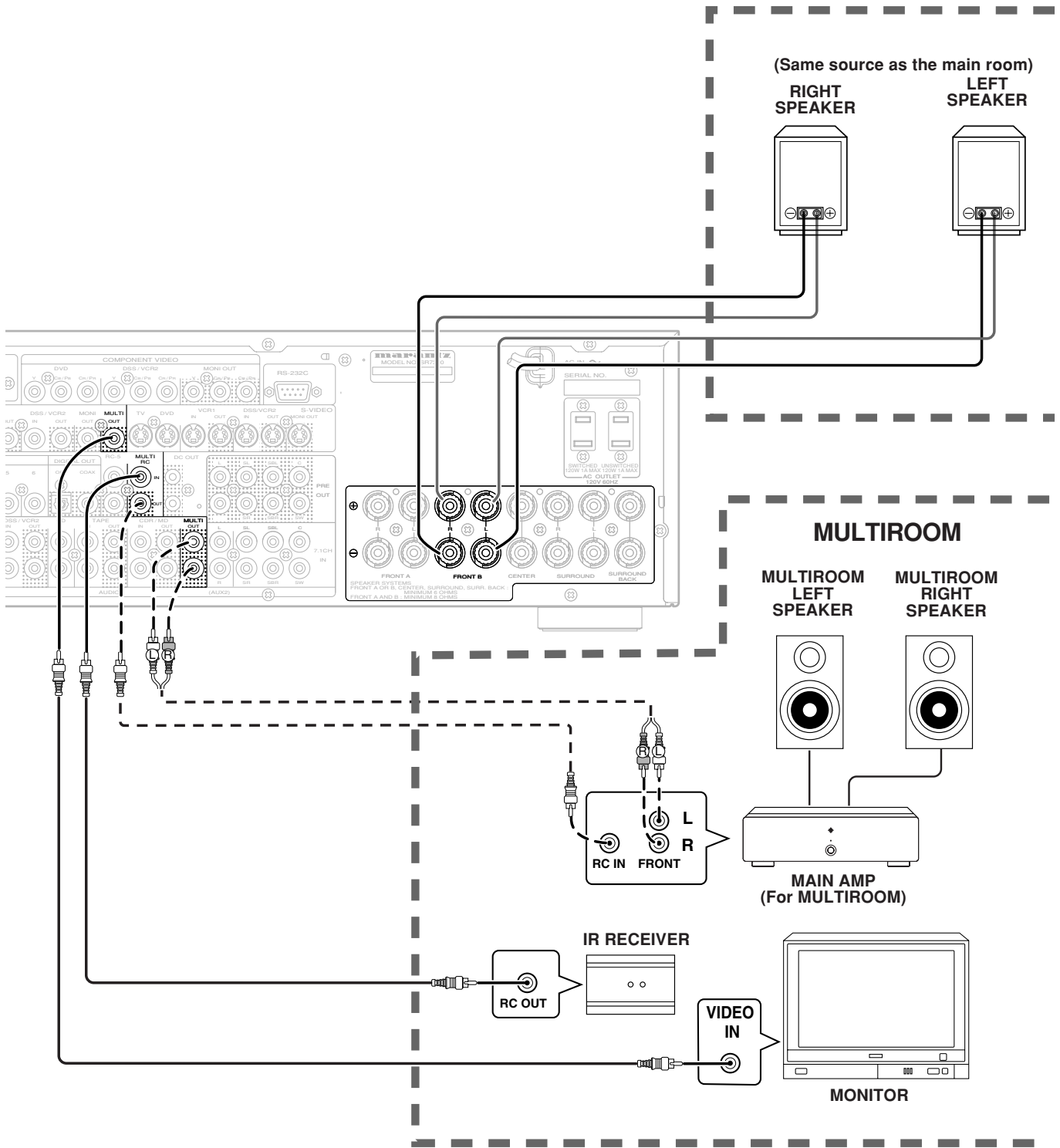



# SETUP

After all components are connected, initial setup must be performed.

## ON SCREEN DISPLAY MENU SYSTEM

The SR7300 incorporates an on-screen menu system, which makes various operations possible by using the cursor (▲, ▼, ◀, ▶) and OK buttons on the remote control unit or MULTI FUNCTION dial, TUNING ◀ / ▶ button and ENTER button on the front panel.

Use MULTI FUNCTION dial as Up/Down button in remote, TUNING ◀ / ▶ button as Left/Right button in remote, ENTER button as OK button in remote.

### Notes:

- To view the on-screen displays, make certain you have made a connection from the Monitor Out jack (VIDEO or S-VIDEO) on the rear panel to the composite, S-Video input of your TV or projector. (see 17 page)

- Select the **AMP** mode in remote control unit.
- Press **SETUP** button on the remote control unit to display the "SETUP MAIN MENU" of the OSD menu system. There are 9 items in the SETUP MAIN MENU.  
If you enter to this menu by MULTI dial on the front panel. Press **SELECT** to show "SETUP MENU" in FL display and press **ENTER** button.
- Select a desired sub-menu with ▲ or ▼ cursor button, and press the **OK** button to entry.  
The display will change to selected sub-menu.  
You can lock the condition of setup to each sub-menu with ◀ or ▶ cursor buttons.  
**Notes:** If you desire to adjust any sub-menu, you need to set UNLOCKED.
- If you desire to exit from this menu system, press **EXIT** button (or **SELECT** button on the front panel), or move the cursor to **EXIT** and press the **OK** button.

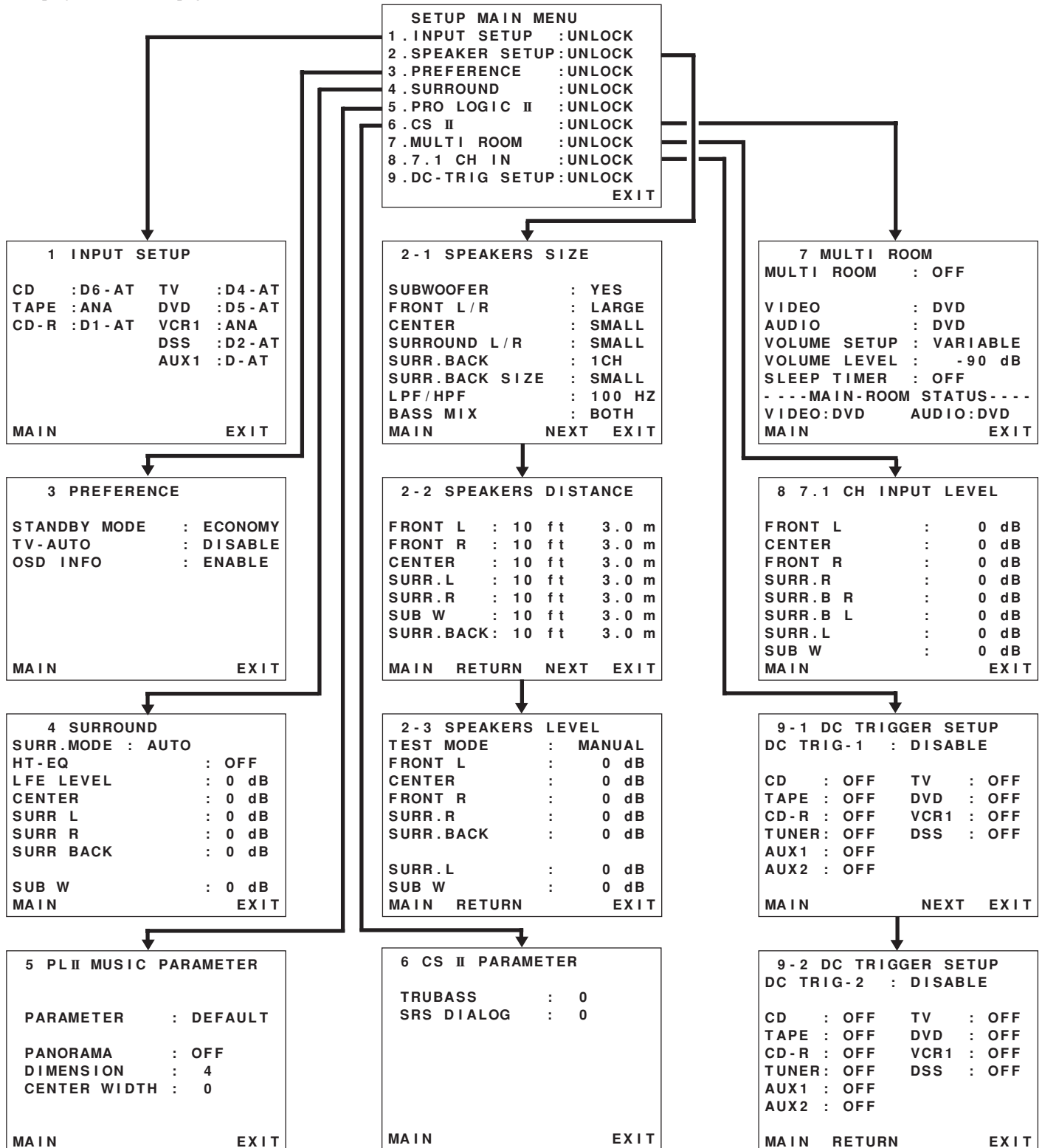

## 1 INPUT SETUP (ASSIGNABLE DIGITAL INPUT)

Six digital inputs can be assigned as the desired source. Use this menu to select the digital input jack to be assigned to the input source.

1. Select "INPUT SETUP" in SETUP MAIN MENU with ▲ or ▼ cursor button, and press the OK button.

1 INPUT SETUP			
CD	: D6 - AT	TV	: D4 - AT
TAPE	: ANA	DVD	: D5 - AT
CD - R	: D1 - AT	VCR1	: ANA
		DSS	: D2 - AT
		AUX1	: D - AT
MAIN		EXIT	

2. To select the input source, press ▲ or ▼ cursor button.
3. To select the digital input jack, press the ◀ or ▶ cursor buttons. Select "Dx-AT" for input sources, for automatic detection of the digital input signal condition.  
If no digital signal is input, the input signals to the analog input jacks will be played.  
Select "Dig x" for input sources, for fixed the digital input jack.  
Select "ANA" for input sources for which no digital input jacks are used.
4. If you finish the setup in this sub-menu, move cursor to MAIN with ▲ or ▼ cursor buttons and press OK button.

### Notes:

- The TUNER is fixed to the analog input, and cannot be selected for any digital input.
- When a DTS-LD or DTS-CD is playing, this setup is not available. This is to avoid noise being generated from the analog input.
- If "Dx-AT" is selected and a DVD, compact disc or LD is fast-forwarded during playback, decoded signals may produce a skipping sound. In such cases, change the setting to DIGITAL.

## 2 SPEAKER SETUP

After you have installed the SR7300, connected all the components, and determined the speaker layout, it is now time to perform the settings in the Speaker Setup menu for the optimum sound acoustics for your environment and speaker layout.

Before you perform the following settings, it is important that you first determine the following characteristics:

### 2-1 SPEAKER SIZE

When setting the speaker size in the SPEAKER SIZE sub-menu, use the guidelines given below.

**Large:** The complete frequency range for the channel you are setting will be output from the speaker.

**Small:** Frequencies of the channel you are setting lower than approx. 100 Hz will be output from the subwoofer.

If the Subwoofer is set to "NONE" and the front speakers are set to "Large," then the sound may be output from both the left and right speakers.

2 - 1 SPEAKERS SIZE	
SUBWOOFER	: YES
FRONT L / R	: LARGE
CENTER	: SMALL
SURROUND L / R	: SMALL
SURR. BACK	: 1CH
SURR. BACK SIZE	: SMALL
L PF / HPF	: 100 HZ
BASS MIX	: BOTH
MAIN	NEXT EXIT

1. Select "SPEAKER SETUP" in MAIN SETUP MENU with Up or Down cursor button, and press the OK button.
2. To select the each speaker, press Up or Down cursor button.
3. To select the setting of size to each speaker, press the Left or Right cursor buttons.
4. If you finish these setup, move cursor to "NEXT" with Up or Down cursor button and then press OK button to go to next page.

### SUBWOOFER:

**YES:** Select when a subwoofer is connected.

**NONE:** Select when a subwoofer is not connected.

### FRONT L/R

**LARGE:** Select if the front speakers are large sized.

**SMALL:** Select if the front speakers are small sized.

- If "NONE" is selected for the Subwoofer setting, then this setting is fixed to "Large."

### CENTER

**NONE:** Select if no center speaker is connected.

**LARGE:** Select if the center speaker is large sized.

**SMALL:** Select if the center speaker is small sized.

### SURROUND L/R

**NONE:** Select if no surround left and right speakers are connected.

**LARGE:** Select if the surround left and right speakers are large sized.

**SMALL:** Select if the surround left and right speakers are small sized.

### SURR. BACK

**NONE:** Select if no surround back left and right speakers are connected.

**2CH: (Preout only)** Select if surround back left and right speakers are connected.

**1CH:** Select if the one surround back speaker connected.

- If "None" is selected for the Surround L/R setting, then this setting is fixed to "None."
- If you are able to position two Surround Back speakers in your listening environment, two Surround Back speakers can be used.

In this case, connect a 2 channel power amplifier to the PRE OUT SBL and SBR terminals on the SR7300, and connect the surround back left & right speakers to this power amplifier. (see page 15) You will also need to make the appropriate setting SURR BACK=2CH

### SURR. BACK SIZE

**LARGE:** Select if the surround back speakers are large sized.

**SMALL:** Select if the surround back speakers are small sized.

- If "None" is selected for the Surround L/R setting, then this setting is not available.

### L PF / HPF

When you use a subwoofer, you can select the cutoff frequency for the small speakers used. Select one of the crossover frequency levels according to the size of the small speaker connected.

**80Hz :** Select this when the cone speaker unit built in the speaker system is about 12 cm (4 3/4 inches).

**100Hz :** Select this when the cone speaker unit built in the speaker system is about 10 cm (3 15/16 inches).

**120Hz :** Select this when the cone speaker unit built in the speaker system is about 8 cm (3 3/16 inches).

### Notes:

- Use the above comments as reference when adjusting.
- If S- Direct mode, 7.1CH Input is in use, this function does not take effect.

**BASS MIX**

- The bass mix setting is only valid when "LARGE" is set for the front speakers and "YES" is set for the subwoofer at stereo playback .
- When the "BOTH" is selected, the low frequency signal range of "LARGE" are produced simultaneously from those channels and the subwoofer channel.

In this playback mode, the low frequency range expand more uniformly through the room, but depending on the size and shape of the room, interference may result in a decrease of the actual volume of the low frequency range.

- Selection of the "MIX" will play the low frequency signal range of the channel selected with "LARGE" from that channel only.

Therefore, the low frequency signal range that are played from the subwoofer channel are only the low frequency signal range of LFE (only during Dolby Digital or DTS signal playback) and the channel specified as "SMALL" in the setup menu.

**2-2 SPEAKER DISTANCE**

Use this parameter to specify the distance of each speaker's position from the listening position. The delay time is automatically calculated according to these distances.

Begin by determining the ideal or most commonly used seating position in the room.

This is important for the timing of the acoustics to create the proper sound space that the SR7300 and today's sound systems are able to produce.

Note that the speakers that you selected "None" for in the Speaker Config sub-menu will not appear here.

(There are several useful books and special DVD and LD's available to guide you through proper home theater configuration. If you are unsure, have your Marantz dealer perform the installation for you.

They are trained professionals familiar with even the most sophisticated custom installations. Marantz recommends the WWW.CEDIA.ORG website for further information about this).

2 - 2 SPEAKERS DISTANCE			
FRONT L	:	10 ft	3.0 m
FRONT R	:	10 ft	3.0 m
CENTER	:	10 ft	3.0 m
SURR . L	:	10 ft	3.0 m
SURR . R	:	10 ft	3.0 m
SUB W	:	10 ft	3.0 m
SURR . BACK	:	10 ft	3.0 m
MAIN		RETURN	NEXT EXIT

1. To select the each speaker , press ▲ or ▼ cursor button.
2. To set the distance for each speaker , press the ◀ or ▶ cursor buttons.
3. If you finish these setup, move cursor to "NEXT" with ▲ or ▼ cursor button and then press OK button to go to next page.

**FRONT L** : Set the distance from the front left speaker to your normal listening position between 1 and 30 feet in 1.0 foot interval (0.3 to 9 meters in 0.3-meter intervals).

**FRONT R** : Set the distance from the front right speaker to your normal listening position between 1 and 30 feet in 1.0 foot interval (0.3 to 9 meters in 0.3-meter intervals).

**CENTER** : Set the distance from the center speaker to your normal listening position between 1 and 30 feet in 1.0 foot interval (0.3 to 9 meters in 0.3-meter intervals).

**SURR . L** : Set the distance from the surround left speaker to your normal listening position between 1 and 30 feet in 1.0 foot interval (0.3 to 9 meters in 0.3-meter intervals).

**SURR . R** : Set the distance from the surround right speaker to your normal listening position between 1 and 30 feet in 1.0 foot interval (0.3 to 9 meters in 0.3-meter intervals).

**SUB W** : Set the distance from the subwoofer to your normal listening position between 1 and 30 feet in 1.0-foot intervals (0.3 to 9 meters in 0.3-meter intervals).

**SURR . BACK** : Set the distance from a surround back speaker to your normal listening position between 1 and 30 feet in 1.0-foot intervals (0.3 to 9 meters in 0.3-meter intervals).

**(SURR . B L)** : Set the distance from the surround back left speaker to your normal listening position between 1 and 30 feet in 1.0-foot intervals (0.3 to 9 meters in 0.3-meter intervals).

**(SURR . B R)** : Set the distance from the surround back right speaker to your normal listening position between 1 and 30 feet in 1.0-foot intervals (0.3 to 9 meters in 0.3-meter intervals).

**Notes**

- Speakers that you selected "None" for in the Speaker Size menu will not appear.
- The setting of Surr.Back L and Surr.Back R appears if set for two surround back speakers in the Speaker Size menu.
- The setting of Surr.Back appears if set for one surround back speaker in the Speaker Size menu.

**2-3 SPEAKERS LEVEL**

Here you will set the volume for each speaker so that they are all heard by the listener at the same level.

**Note:**

- The speaker level settings is not available in 7.1 channel input mode and S-Direct mode.

2 - 3 SPEAKERS LEVEL		
TEST MODE	:	MANUAL
FRONT L	:	0 dB
CENTER	:	0 dB
FRONT R	:	0 dB
SURR . R	:	0 dB
SURR . BACK	:	0 dB
SURR . L	:	0 dB
SUB W	:	0 dB
MAIN	RETURN	EXIT

**TEST MODE** : Selects "MANUAL" or "AUTO" for generating mode of test tone Left or Right cursor button.

If you select "AUTO", the test tone will be cycled through in a circular pattern which is Left → Center → Right → Surround Right → (Surround Back Right) → (Surround Back Left) → Surround Left → Subwoofer → Left → .. increments of 3 seconds for each channel.

Using the Left and Right cursor buttons, adjust the volume level of the noise from the speaker so that it is the same level for all speaker.

If you select "MANUAL", adjust the output level of each speaker as follow.

1. When you move cursor to FRONT L by pressing ▼ cursor button, the SR7300 will emit a pink noise from the front left speaker. Remember the level of this noise and then press the ▼ cursor button. (Note that this can be adjusted to any level between -10 and +10 dB in 1 dB intervals except the subwoofer setting. The subwoofer can be adjusted to any level between -15 and +10 dB in 1 dB intervals.) The SR7300 will now emit the pink noise from the center speaker.
2. Using the ◀ and ▶ cursor buttons, adjust the volume level of the noise from the center speaker so that it is the same level as the front left speaker.
3. Press the ▼ cursor button again. The SR7300 will now emit the pink noise from the front right speaker.
4. Repeat steps 2 and 3 above for the front right and other speakers until all speakers are adjusted to the same volume level.

If you finish these setup, press OK button, the cursor will move to "MAIN" and then press OK button to go to SETUP MAIN MENU.

**Notes:**

- Speakers that you selected “None” for in the Speaker Size menu will not appear.
- The setting of Surr.Back L and Surr.Back R appears if set for two surround back speakers in the Speaker Size menu.
- The setting of Surr.Back appears if set for one surround back speaker in the Speaker Size menu.
- To adjust the speaker levels for 7.1-channel input sources, you will need to use the 7.1CH-INPUT sub menu. (See page 26).

**3 PREFERENCE**

3 PREFERENCE	
STANDBY MODE	: ECONOMY
TV - AUTO	: DISABLE
OSD INFO	: ENABLE
MAIN	EXIT

1. Select “**PREFERENCE**” in SETUP MAIN MENU with ▲ or ▼ cursor button, and press the **OK** button.
2. To select a desired content, press ▲ or ▼ cursor button.

**STANDBY MODE:** When this function is set to “**ECONOMY**”, you can reduce the power consumption to standby condition.

**Note:** TV-AUTO , MULTI RC control and RC232C are disable in “**ECONOMY**” setting.

**TV AUTO:** Select the TV AUTO ON/OFF function to enable or disable with ◀ or ▶ cursor button.  
(refer to page 32)

**OSD Info:** Select the OSD information function to enable or disable with ◀ or ▶ cursor button.  
If you select “**ENABLE**”, SR7300 will display the status of the feature (Volume up/down, input select, etc..) on the TV monitor. But if you do not desire this information, select “**DISABLE**”.

If you finish the setup in this item, move cursor to “**MAIN**” with ▲ or ▼ cursor buttons and press **OK** button.

**4 SURROUND**

4 SURROUND	
SURR.MODE	: AUTO
HT - EQ	: OFF
LFE LEVEL	: 0 dB
CENTER	: 0 dB
SURR L	: 0 dB
SURR R	: 0 dB
SURR BACK	: 0 dB
SUB W	: 0 dB
MAIN	EXIT

1. Select “**SURROUND**” in SETUP MAIN MENU with ▲ or ▼ cursor button, and press the **OK** button.
2. To select a desired content , press ▲ or ▼ cursor button.

**SURR-MODE :** Select the desired surround mode with ◀ or ▶ cursor button.

**HT-EQ :** Select to active the HT-EQ with ◀ or ▶ cursor button.

The tonal balance of a film soundtrack will be excessively bright and harsh when played back over audio equipment in the home. This is because film soundtracks were designed to be played back in large movie theater environments. Activating the HT-EQ feature when watching a film made for movie theaters corrects this and restores the correct tonal balance.

The HT-EQ feature can be activated only while in Dolby Pro Logic Mode, or while decoding Dolby Digital or DTS encoded material.

**LFE LEVEL :** Select the output level of the LFE signal included in the Dolby Digital signal or the DTS signal.

Select 0 dB, -10 dB or OFF with Left or Right cursor button.

**CHANNEL LEVEL**

**CENTER LEVEL:** Set the effect level of the center speaker between –10 and +10 dB level in 1 dB level interval .

- If “None” was selected for the Center speaker setting in the Speaker size, then this setting will not appear.

**SURR L LEVEL:** Set the level of the Surround left speaker between –10 and +10 dB level in 1 dB level interval.

- If “None” was selected for the Surround left speaker setting in the Speaker size, then this setting will not appear.

**SURR R LEVEL:** Set the level of the Surround speaker between –10 and +10 dB level in 1 level interval.

- If “None” was selected for the Surround right speaker setting in the Speaker size, then this setting will not appear.

**SURR BACK LEVEL:** Set the effect level of the Surround Back speaker between –10 and +10 dB level in 1 dB level interval.

- If “None” was selected for the Surround back speakers setting in the Speaker size, then this setting will not appear.

**SUB W LEVEL:** Set the effect level of the subwoofer speaker between –15 and +10 dB level in 1 dB level interval.

- If “None” was selected for the Subwoofer speaker setting in the Speaker size, then this setting will not appear.

If you finish the setup in this item, move cursor to “**MAIN**” with ▲ or ▼ cursor buttons and press **OK** button.

## 5 PL II (PRO LOGIC II) MUSIC PARAMETER

Pro Logic II-Music mode creates a rich and enveloping surround ambience from stereo sources such as CDs.

In this mode, SR7300 includes three controls to fine-tune the soundfield as follow.

5 PL II MUSIC PARAMETER	
PARAMETER	: DEFAULT
PANORAMA	: OFF
DIMENSION	: 4
CENTER WIDTH	: 0
MAIN	EXIT

Select "PRO LOGIC II" in SETUP MAIN MENU with ▲ or ▼ cursor button, and press the OK button.

**PARAMETER:** Select "DEFAULT" or "CUSTOM" with ◀ or ▶ cursor button

If you select "CUSTOM", you can adjust three parameters as follow

**PANORAMA:** Select the Panorama mode On or Off with ◀ or ▶ cursor button.

Panorama wraps the sound of the front left and right speakers around you for an exciting perspective.

**DIMENSION:** Set the Dimension level between 0 and 6 level in 1 level interval with ◀ or ▶ cursor button.

Adjust the soundfield either towards the front or towards the rear.

This can be useful to help achieve a more suitable balance from all the speakers with certain recordings.

**CENTER WIDTH:** Set the Center width level between 0 and 7 level in 1 level interval with ◀ or ▶ cursor button.

Center Width allows you to gradually spread the center channel sound into the front left and right speakers.

At its widest setting, all the sound from the center is mixed into the left and right.

This control may help achieve a more spacious sound or a better blend of the front image.

If "None" was selected for the Center speaker setting in the Speaker size, then this setting will not appear.

If you finish the setup in this menu, move cursor to "MAIN" with ▲ or ▼ cursor buttons and press OK button.

## 6 CS II (CIRCLE SURROUND II) PARAMETER

6 CS II PARAMETER	
TRUBASS	: 0
SRS DIALOG	: 0
MAIN	EXIT

1. Select "CS II" in SETUP MAIN MENU with ▲ or ▼ cursor button, and press the OK button.

2. To Select desired contents as below, press ▲ or ▼ cursor button

**TRUBASS:** Set the TRUBASS level between 0 and 6 level in 1 level interval with ◀ or ▶ cursor button.

TRUBASS produced by the speakers to be an octave below the actual physical capabilities of the speakers adding exciting, deeper bass effects.

**SRS DIALOG:** Set the SRS DIALOG level between 0 and 6 level in 1 level interval with ◀ or ▶ cursor button.

This can be popped out of the surround audio effects allowing the listener to easily discern what the actors say.

If "NONE" was selected for the Center speaker setting in the Speaker size, then this setting will not appear.

If you finish the setup in this menu, move cursor to "MAIN" with ▲ or ▼ cursor buttons and press OK button.

## 7 MULTI ROOM

SR7300 has some feature to MULTI ROOM SYSTEM as source selector, OSD information, sleep timer, Multi Room Speaker output and remote control.

You can set such feature by this sub-menu.

7 MULTI ROOM	
MULTI ROOM	: OFF
VIDEO	: DVD
AUDIO	: DVD
VOLUME SETUP	: VARIABLE
VOLUME LEVEL	: -90 dB
SLEEP TIMER	: OFF
- - - MAIN - ROOM STATUS - - -	
VIDEO: DVD	AUDIO: DVD
MAIN	EXIT

1. Select "MULTI ROOM" in SETUP MAIN MENU with ▲ or ▼ cursor button, and press the OK button.

2. To Select desired contents as below, press ▲ or ▼ cursor button

**MULTI ROOM:** To switch on the Multi-room output ON or OFF, press ◀ or ▶ cursor button.

**VIDEO:** Select the video source of the Multi-room output with ◀ or ▶ cursor button.

**AUDIO:** Select the audio source of the Multi-room output with ◀ or ▶ cursor button.

**VOLUME SETUP:** Select whether the Multi-room output level is variable or fixed with a ◀ or ▶ cursor button.

**VOLUME LEVEL:** Adjust the Multi-room output level with ◀ or ▶ cursor button.

**SLEEP TIMER:** SLEEP timer function is available during the multiroom is active, set the time with ◀ or ▶ cursor button.

**MAIN ROOM STATUS:** Selected input source in the main room will be displayed.

**Notes:**

- If "VOLUME" is set to "FIXED", the multi-room output level cannot be adjusted from the second zone.

If you finish the setup in this menu, move cursor to "MAIN" with ▲ or ▼ cursor buttons and press OK button.

## 8 7.1 CH INPUT LEVEL

This sub-menu is to adjust the speaker levels for 7.1-channel input sources.

Here you will adjust the volume for each channel so that they are all heard by the listener at the same level.

8 7.1 CH INPUT LEVEL		
FRONT L	:	0 dB
CENTER	:	0 dB
FRONT R	:	0 dB
SURR. R	:	0 dB
SURR. B R	:	0 dB
SURR. B L	:	0 dB
SURR. L	:	0 dB
SUB W	:	0 dB
MAIN		EXIT

1. Select "7.1CH IN" in MAIN SETUP MENU with ▲ or ▼ cursor button, and press the **OK** button.
2. To Select desired channel , press ▲ or ▼ cursor button.
3. Using the ◀ or ▶ cursor buttons, adjust the volume level of each channel.
4. If you finish the setup in this menu, move cursor to "MAIN" with ▲ or ▼ cursor buttons and press **OK** button.

**Note:**

- The condition of these setup will be memorized to 7.1CH INPUT source.

## 9 DC TRIGGER SETUP

SR7300 has two DC trigger control jacks, each one is selectable to link with input functions for the main room or multi room.

1. Select "DC-TRIG SETUP" in SETUP MAIN MENU with ▲ or ▼ cursor button, and press the **OK** button.

9 - 1 DC TRIGGER SETUP		
DC TRIG-1 : DISABLE		
CD	: OFF	TV : OFF
TAPE	: OFF	DVD : OFF
CD-R	: OFF	VCR1 : OFF
TUNER	: OFF	DSS : OFF
AUX1	: OFF	
AUX2	: OFF	
MAIN		NEXT EXIT

2. You can select MAIN ROOM, MULTI ROOM or DISABLE by pressing ◀ or ▶ cursor buttons.
3. To Select desired input source , press ▲ or ▼ cursor button.
4. To set ON or OFF, press ◀ or ▶ cursor button.
5. If you finish the setup to DC-1 trigger, move cursor to "NEXT" with ▲ or ▼ cursor buttons and press **OK** button to go to next page.

9 - 2 DC TRIGGER SETUP		
DC TRIG-2 : DISABLE		
CD	: OFF	TV : OFF
TAPE	: OFF	DVD : OFF
CD-R	: OFF	VCR1 : OFF
TUNER	: OFF	DSS : OFF
AUX1	: OFF	
AUX2	: OFF	
MAIN	RETURN	EXIT

6. You can select MAIN ROOM, MULTI ROOM or DISABLE by pressing ◀ or ▶ cursor buttons.
7. To Select desired input source , press ▲ or ▼ cursor button.
8. To set ON or OFF, press ◀ or ▶ cursor button.
9. If you finish the setup to these menu, move cursor to "MAIN" with ▲ or ▼ cursor buttons and press **OK** button.

## BASIC OPERATION (PLAY BACK)

### SELECTING AN INPUT SOURCE.

Before you can listen to any input media, you must first select the input source at the SR7300.

**E.G. : DVD**

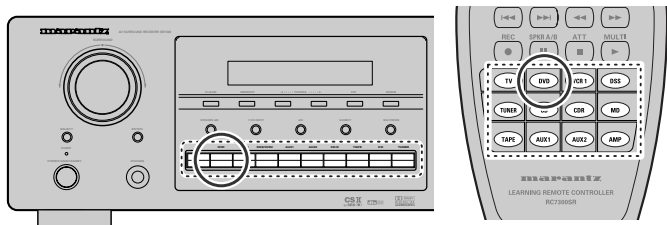

To select DVD, simply press the **DVD** button on the front panel or press **DVD** button on the remote.

After you have selected DVD, simply turn on the DVD player and play the DVD.

- As the input source is changed, the new input name will appear momentarily as an OSD information on the video display. The input name will also appear in the display on the front-panel.
- As the input is changed, the SR7300 will automatically switch to the digital input, surround mode, attenuation, and night mode status that were entered during the configuration process for that source.
- When an audio source is selected, the last video input used remains routed to the **VCR1 & VCR2** Outputs and **Monitor** Outputs. This permits simultaneous viewing and listening to different sources.
- When a Video source is selected, the video signal for that input will be routed to the **Monitor Outputs** jack and will be viewable on a TV monitor connected to the SR7300.

If a component video input is connected to the **DVD** or **DSS** component inputs, it will be routed to the **Component Video Output**. Make certain that your TV is set to the proper input to view the signal.

### SELECTING THE SURROUND MODE

**E.G. : AUTO SURROUND**

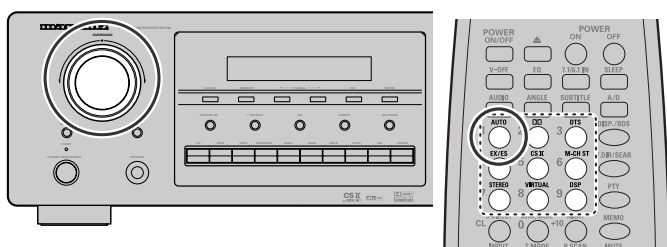

To select the surround mode during playback, turn the **SELECT** knob on the front panel or press the surround mode button on the remote .

### ADJUSTING THE MAIN VOLUME

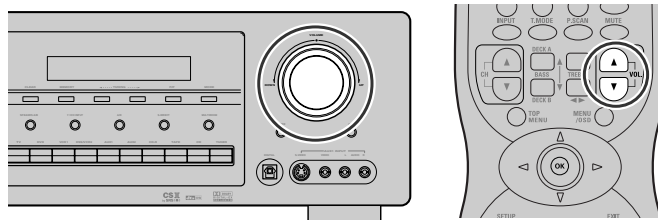

Adjust the volume to a comfortable level using the **VOLUME** control knob on the front panel or **VOL ▲ / ▼** buttons on the remote.

To increase the volume, turn the **VOLUME** knob to the clockwise or press **VOL ▲** button on the remote, to decrease the volume, turn to the counterclockwise or press **VOL ▼** button on the remote.

#### Notes:

- The volume can be adjusted within the range of  $-\infty$  to 18 dB, in steps of 1 dB.
- However, when the channel level is set as described on page 25, if the volume for any channel is set at +1 dB or greater, the volume cannot be adjusted up to 18 dB.  
(In this case the maximum volume adjustment range is "18 dB - Maximum value of channel level")

### ADJUSTING THE TONE (BASS & TREBLE) CONTROL.

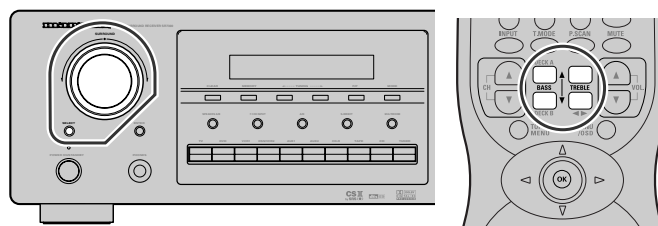

During a listening session you may wish to adjust the Bass and Treble Control to suit your listening tastes or room acoustics.

#### (using the SR7300)

To change the selector mode, press **SELECT** button, until "**BASS**" or "**TREBLE**" is shown on front display.

Turn the **SELECTOR** knob to desired level of tone control.

#### (Using the remote control unit)

To adjust the bass effect, press **BASS▲** or **BASS▼** on the remote.

To adjust the treble effect, press **TREBLE▲** or **TREBLE▼** on the remote.

#### Notes :

- The tone control function can work in the AUTO Surround, Stereo, Dolby PL2, DTS, DTS-ES, and Multi Ch. Stereo mode.

## TEMPORARILY TURNING OFF THE SOUND

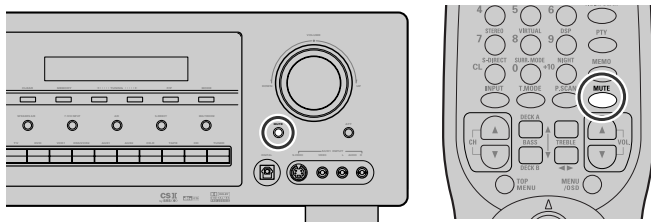

To temporarily silence all speaker outputs such as when interrupted by a phone call, press the **MUTE** button on the front panel or **MUTE** button on the remote.

This will interrupt the output to all speakers and the head-phone jack, but it will not affect any recording or dubbing that may be in progress.

When the system is muted, the display will show "**MUTE**".

Press the **MUTE** button again to return to normal operation.

## USING THE SLEEP TIMER

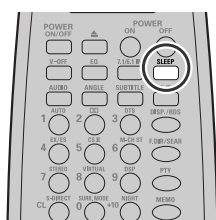

To program the SR7300 for automatic standby, press **SLEEP** button on the remote.

Each press of the button will increase the time before shut down in the following sequence.

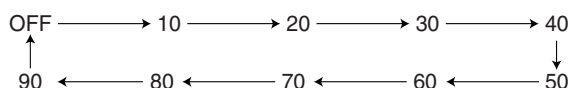

The sleep time will be shown for a few seconds in the display on the front panel, and it will count down until the time has elapsed.

When the programmed sleep time has elapsed, the unit will automatically turn off.

Note that the **SLEEP** indicator on the display will light up when the Sleep function is programmed.

To cancel the Sleep function, press the **SLEEP** button until the display shows to "**SLEEP OFF**" and the SLEEP indicator disappear.

## NIGHT MODE

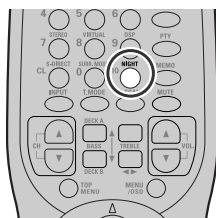

Press the **NIGHT** button on the remote to turn on the NIGHT mode.

Selecting the Night Mode ON is effective in Dolby Digital only, and it compresses the dynamic range.

This softens loud passages such as sudden explosions, to help prevent disturbing others late at night.

To turn off the Night mode, press the **NIGHT** button again.



# SURROUND MODE

The SR7300 is equipped with many surround modes. These are provided to reproduce a variety of surround sound effects, according to the content of the source to be played.

The available surround modes may be restricted depending on the input signal and speaker setup.

## AUTO

When this mode is selected, the receiver determines whether the digital input signal is Dolby Digital, Dolby Digital Surround EX, DTS, DTS-ES, DTS 96/24 or PCM-audio.

Surround EX & DTS-ES will operate for multi channel source that has a Dolby Digital Surround EX or DTS-ES auto trigger flag in the digital signal.

When a Dolby Digital or DTS signal is input, the number of channels for which the corresponding signal is encoded will be played.

Inputting a Dolby Digital two channel signal with Dolby surround status automatically subjects that signal to Pro Logic II movie processing before play.

PCM 96 kHz source material can be played in this mode.

HDCD source material can be played in this mode. (OSE version only)

### Notes:

- When you use this mode with certain DVD and CD players, performing operations such as "Skip" or "Stop" may momentarily interrupt the output.
- When the signal is not decoded is input for using mode, the mode is changed to AUTO mode automatically. Refer to page 31 to confirm the available decoding mode.

## DOLBY MODE

*(Dolby Digital, Pro Logic II MOVIE, Pro Logic II MUSIC, Pro Logic)*

This mode is used with source materials encoded in Dolby Digital and Dolby Surround.

## DOLBY DIGITAL

This mode is enabled when playing source materials encoded in Dolby Digital.

Playing multi-channel encoded 5.1-channel Dolby Digital sources provides five main audio channels (left, center, right, surround left and surround right) and Low Frequency Effect channel.

Dolby Digital EX decoding is not available in this mode.

Dolby Pro Logic II brings the excitement of surround sound to any stereo mix, while making existing Dolby Surround mixes sound more like discrete 5.1 channels Surround sound.

Dolby Pro Logic II has below 3 modes.

### Pro Logic II MOVIE

This mode provides 5.1 channel surround sound from Dolby Surround encoded stereo movie sound tracks.

### Pro Logic II MUSIC

This mode provides 5.1 channel surround sound from conventional stereo sources, analog or digital, such as CD, tape, FM, TV, stereo VCR, etc.

### Pro Logic

This mode emulated original Dolby Pro Logic decoding (3/1 surround) suit for Dolby Surround encoded stereo movie soundtracks.

### Notes:

- Pro Logic II mode is available to 2ch input signal which is encoded Dolby Digital or PCM format.
- PCM-audio signals can be subjected to Pro Logic processing when the sampling frequency is 32 kHz, 44.1 kHz or 48 kHz.

## EX/ES

This mode provides 6.1 channel surround for DOLBY DIGITAL EX, DTS-ES encoded source material such as DVD.

This mode cannot be used when an analog input has been selected.

### Dolby Digital EX

In a movie theater, film soundtracks that have been encoded with Dolby Digital surround EX technology are able to reproduce an extra channel which has been added during the mixing of the program.

This channel, called Surround Back, places sounds behind the listener in addition to the currently available front left, front center, front right, surround right, surround left and subwoofer channels.

This additional channel provides the opportunity for more detailed imaging behind the listener and brings more depth, spacious ambience and sound localization than ever before.

Dolby Digital EX is not available in the system without surround back speaker(s).

### DTS-ES (Discrete 6.1, Matrix 6.1)

DTS-ES adds the surround center channel audio to the DTS 5.1-channel format to improve the acoustic positioning and makes acoustic image movement more natural with the 6.1-channel reproduction.

This receiver incorporates a DTS-ES decoder, which can handle DTS-ES Discrete-encoded and DTS-ES Matrix-encoded program sources from DVD, etc..

DTS-ES Discrete 6.1 features digital discrete recording of all channels including the surround back channel(s) and higher quality of audio reproduction.

DTS-ES is not available in the system without surround back speaker.

## dts MODE

*(dts, Neo:6 Cinema, Neo:6 Music)*

This mode is for DTS encoded source materials such as LASER DISC, CD, and DVD. Neo:6 is to some 2 channel signal source.

**dts** : This mode is enabled when playing source materials encoded in dts multi channel.

Playing multi-channel encoded 5.1-channel dts sources provides five main audio channels (left, center, right, surround left and surround right) and Low Frequency Effect channel.

dts-ES decoding is not available in this mode.

The DTS mode cannot use when an analog input has been selected.

### Neo:6 Cinema, Neo:6 Music

This mode decodes 2-channel signals into 6-channel signals using high-accuracy digital matrix technology.

The DTS NEO:6 decoder has near-discrete properties in the frequency characteristics of the channels as well as in channel separation.

According to the signals to be played back, DTS NEO:6 uses either the NEO:6 CINEMA mode optimized for movie playback or the NEO:6 MUSIC mode optimized for music playback.

### Note:

- Neo:6 mode is available to 2ch input signal which is encoded Dolby Digital or PCM format.
- PCM-audio signals can be subjected to Pro Logic processing when the sampling frequency is 32 kHz, 44.1 kHz or 48 kHz.

## MULTI CH. ST

This mode is used to create a wider, deeper and more natural soundstage from two channel source material.

This is done by feeding the left channel signal to both left front and left surround speaker and the right channel signal to both right front and right surround speaker. Additionally, the center channel reproduces a mix of the right and left channel.

**CIRCLE SURROUND II (CSII-CINEMA, CSII-MUSIC, CSII-MONO)**

Circle Surround is designed to enable multi-channel surround sound playback of non-encoded and multi-channel encoded material. Backward compatibility provides listeners with up to 6.1 channels of surround performance from entire collection of music and film, including broadcast, videotape and stereo recorded music. Regarding to source material, you can select **CSII-Cinema** mode, **CSII-Music** mode or **CSII-Mono** mode.

**Note:**

- CS II mode is available to 2ch input signal which is encoded Dolby Digital or PCM format.
- PCM-audio signals can be subjected to Pro Logic processing when the sampling frequency is 32 kHz, 44.1 kHz or 48 kHz.

**VIRTUAL**

This mode creates a virtualized surround sound experience from a two-speaker (front L and R) playback system playing any multi-channel audio source (such as found on DVDs and digital broadcasts), including Dolby Digital, , Dolby Pro Logic or DTS.

**STEREO**

This mode bypasses all surround processing. Stereo program sources the left and right channels play normally when PCM-audio or analog stereo is input. With Dolby Digital and DTS sources, the 5.1 multi-channels are converted to two channel stereo. 96 kHz PCM source material can be playback in stereo mode. HDCD source material can be played in this mode. (OSE version only)

**S (SOURCE) - DIRECT**

In the source direct mode, the tone control circuit and bass management configuration are bypassed for full range frequency response and the purist audio reproduction. 96 kHz PCM source material can be play back in this mode. HDCD source material can be played in this mode. (OSE version only)

**Notes:**

- Internal speaker size is setup to front L/R = Large, Center = Large, Surround L/R = Large and Subwoofer = yes automatically. Tone controls and additional processing are also defeated.
- When you use this mode with certain DVD and CD players, performing operations such as "Skip" or "Stop" may momentarily interrupt the output.

**CAUTION*****NOTE for DTS signal***

- \* Connected DVD-player, laser-disc player or CD-player needs to support DTS-digital output. You may not be able to play some DTS source signals from certain CD players and LD players even if you connect the player to the SR7300 digitally. This is because the digital signal has been processed (such as the output level, sampling frequency, or frequency response) and the SR7300 cannot recognize the signal as DTS data.
- \* Depending on the player used, DTS play may produce short noise. This is not a malfunction.
- \* While signals from DTS-laser disc or CD are playing in another Surround mode, you cannot switch to digital input or from digital input to analog input by INPUT SETUP in SETUP MAIN MENU or A/D button.
- \* The outputs for the VCR 1 OUT, DSS/VCR 2 OUT, TAPE OUT, and CD-R OUT output analog audio signals. Do not record from CDs or LDs that support DTS using these outputs. If you do, the DTS-encoded signal will be recorded as noise.

***NOTE for Dolby Digital Surround EX signal***

- \* When playing Dolby Digital Surround EX-encoded software in 6.1 channels, it is required to set the EX/ES mode.
- \* Note that some of Dolby Digital Surround EX-encoded software does not contain the identification signal. In this case, set the EX/ES mode manually.

***NOTE for 96kHz PCM audio***

- \* AUTO, Source- DIRECT, and STEREO modes can be used when playing PCM signals with a sampling frequency of 96 kHz (such as from DVD-Video discs that contain 24 bit, 96 kHz audio). If such signals are input during playback in one of the other surround modes, output from SR7300 will be muted.
- \* Certain DVD player models inhibit digital output. For details, refer to the player's operation manual.
- \* Some DVD formatted discs featured copy protection. When using such disc, 96 kHz PCM signal is not output from the DVD player. For details, refer to the player's operation manual.

***NOTE for HDCD signal (OSE version only)***

- \* HDCD is effective only at the time of digital input.
- \* AUTO, Source- DIRECT, and STEREO modes can be used when playing HDCD signals (such as from CD discs that contain HDCD).
- \* You may not be able to play some HDCD source signals from certain CD players if you connect the player to the SR7300 OSE digitally. This is because the digital signal has been processed (such as the output level, sampling frequency, or frequency response) and the SR7300 OSE cannot recognize the signal as HDCD data.

**The relation between the selected surround mode and the input signal**

The surround mode is selected with the surround mode selector on SR7300 or the remote control unit. However, the sound you hear is subject to the relationship between the selected surround mode and input signal. That relationship is as follows;

Surround Mode	Input Signal	Decoding	Output Channel					Front information display	
			L/R	C	SL SR	SB	SubW	Signal format indicators	Channel status
AUTO	Dolby Surr. EX	Dolby Digital EX	○	○	○	○	○	DD DIGITAL	L, C, R, SL, SR, S, LFE
	Dolby D (5.1ch)	Dolby Digital 5.1	○	○	○	-	○	DD DIGITAL	L, C, R, SL, SR, LFE
	Dolby D (2ch)	Dolby Digital 2.0	○	-	-	-	-	DD DIGITAL	L, R
	Dolby D (2ch Surr)	Pro Logic II movie	○	○	○	-	-	DD DIGITAL, DD SURROUND	L, R, S
	DTS-ES	DTS-ES	○	○	○	○	○	dts, ES	L, C, R, SL, SR, S, LFE
	DTS 96/24	DTS 96/24	○	○	○	-	○	dts 96/24	L, C, R, SL, SR, LFE
	DTS (5.1ch)	DTS 5.1	○	○	○	-	○	dts	L, C, R, SL, SR, LFE
	PCM(Audio)	PCM (Stereo)	○	-	-	-	-	PCM	L, R
	PCM 96kHz	PCM (96kHz Stereo)	○	-	-	-	-	PCM	L, R
	(HDCD)	Stereo	○	-	-	-	-	PCM, HDCD	L, R
	Analog	Stereo	○	-	-	-	-	ANALOG	-
S-DIRECT	Dolby D Surr. EX	Dolby Digital EX	○	○	○	○	○	DD DIGITAL	L, C, R, SL, SR, S, LFE
	Dolby D (5.1ch)	Dolby Digital 5.1	○	○	○	-	○	DD DIGITAL	L, C, R, SL, SR, LFE
	Dolby D (2ch)	Dolby Digital 2.0	○	-	-	-	-	DD DIGITAL	L, R
	Dolby D (2ch Surr)	Pro Logic II movie	○	○	○	-	-	DD DIGITAL, DD SURROUND	L, R, S
	DTS-ES	DTS-ES	○	○	○	○	○	dts, ES	L, C, R, SL, SR, S, LFE
	DTS 96/24	DTS 96/24	○	○	○	-	○	dts 96/24	L, C, R, SL, SR, LFE
	DTS (5.1ch)	DTS 5.1	○	○	○	-	○	dts	L, C, R, SL, SR, LFE
	PCM (Audio)	PCM (Stereo)	○	-	-	-	-	PCM	L, R
	PCM 96kHz	PCM (96kHz Stereo)	○	-	-	-	-	PCM	L, R
	(HDCD)	Stereo	○	-	-	-	-	PCM, HDCD	L, R
	Analog	Stereo	○	-	-	-	-	ANALOG	-
EX/ES	Dolby D Surr. EX	Dolby Digital EX	○	○	○	○	○	DD DIGITAL	L, C, R, SL, SR, S, LFE
	Dolby D (5.1ch)	Dolby Digital EX	○	○	○	○	○	DD DIGITAL	L, C, R, SL, SR, LFE
	DTS-ES	DTS-ES	○	○	○	○	○	dts, ES	L, C, R, SL, SR, S, LFE
	DTS(5.1ch)	DTS-ES	○	○	○	○	○	dts	L, C, R, SL, SR, LFE
DOLBY (PL II movie) (PL II music) (Pro Logic)	Dolby D Surr. EX	Dolby Digital 5.1	○	○	○	-	○	DD DIGITAL	L, C, R, SL, SR, S, LFE
	Dolby D (5.1ch)	Dolby Digital 5.1	○	○	○	-	○	DD DIGITAL	L, C, R, SL, SR, LFE
	Dolby D (2ch)	Pro Logic II	○	○	○	-	-	DD DIGITAL	L, R
	Dolby D (2ch Surr)	Pro Logic II	○	○	○	-	-	DD DIGITAL, DD SURROUND	L, R, S
	PCM (Audio)	Pro Logic II	○	○	○	-	-	PCM	L, R
	Analog	Pro Logic II	○	○	○	-	-	ANALOG	-
DTS (Neo:6 Cinema) (Neo:6 Music)	DTS-ES	DTS 5.1	○	○	○	-	○	dts, ES	L, C, R, SL, SR, S, LFE
	DTS 96/24	DTS 96/24	○	○	○	-	○	dts 96/24	L, C, R, SL, SR, LFE
	DTS (5.1ch)	DTS 5.1	○	○	○	-	○	dts	L, C, R, SL, SR, LFE
	PCM (Audio)	Neo:6	○	○	○	○	-	PCM	L, R
	Analog	Neo:6	○	○	○	○	-	ANALOG	-
	Dolby D (2ch)	Neo:6	○	○	○	○	-	DD DIGITAL	L, R
	Dolby D (2ch Surr)	Neo:6	○	○	○	○	DD DIGITAL, DD SURROUND	L, R, S	
CS II Cinema CS II Music CS II Mono	PCM (Audio)	CS II	○	○	○	○	○	PCM	L, R
	Analog	CS II	○	○	○	○	○	ANALOG	-
	Dolby D (2ch)	CS II	○	○	○	○	○	DD DIGITAL	L, R
	Dolby D (2ch Surr)	CS II	○	○	○	○	○	DD DIGITAL, DD SURROUND	L, R, S
STEREO	Dolby Surr. EX	Stereo	○	-	-	-	○	DD DIGITAL	L, C, R, SL, SR, S, LFE
	Dolby D (5.1ch)	Stereo	○	-	-	-	○	DD DIGITAL	L, C, R, SL, SR, LFE
	Dolby D (2ch)	Stereo	○	-	-	-	-	DD DIGITAL	L, R
	Dolby D (2ch Surr)	Stereo	○	-	-	-	-	DD DIGITAL, DD SURROUND	L, R, S
	DTS-ES	Stereo	○	-	-	-	○	dts, ES	L, C, R, SL, SR, S, LFE
	DTS 96/24	Stereo	○	-	-	-	○	dts 96/24	L, C, R, SL, SR, LFE
	DTS (5.1ch)	Stereo	○	-	-	-	○	dts	L, C, R, SL, SR, LFE
	PCM (Audio)	Stereo	○	-	-	-	-	PCM	L, R
	PCM 96kHz	Stereo	○	-	-	-	-	PCM	L, R
	(HDCD)	Stereo	○	-	-	-	-	PCM, HDCD	L, R
	Analog	Stereo	○	-	-	-	-	ANALOG	-
Virtual	Dolby Surr. EX	Virtual	○	-	-	-	-	DD DIGITAL	L, C, R, SL, SR, S, LFE
	Dolby D (5.1ch)	Virtual	○	-	-	-	-	DD DIGITAL	L, C, R, SL, SR, LFE
	Dolby D (2ch)	Virtual	○	-	-	-	-	DD DIGITAL	L, R
	Dolby D (2ch Surr)	Virtual	○	-	-	-	-	DD DIGITAL, DD SURROUND	L, R, S
	DTS-ES	Virtual	○	-	-	-	-	dts, ES	L, C, R, SL, SR, S, LFE
	DTS (5.1ch)	Virtual	○	-	-	-	-	dts	L, C, R, SL, SR, LFE
	PCM (Audio)	Virtual	○	-	-	-	-	PCM	L, R
	Analog	Virtual	○	-	-	-	-	ANALOG	-
Multi Ch. Stereo	Dolby Surr. EX	Dolby Digital EX	○	○	○	○	○	DD DIGITAL	L, C, R, SL, SR, S, LFE
	Dolby D (5.1ch)	Dolby Digital 5.1	○	○	○	-	○	DD DIGITAL	L, C, R, SL, SR, LFE
	Dolby D (2ch)	Multi Channel Stereo	○	○	○	○	-	DD DIGITAL	L, R
	Dolby D (2ch Surr)	Multi Channel Stereo	○	○	○	○	-	DD DIGITAL, DD SURROUND	L, R, S
	DTS-ES	DTS-ES	○	○	○	○	○	dts, ES	L, C, R, SL, SR, S, LFE
	DTS (5.1ch)	DTS 5.1	○	○	○	-	○	dts	L, C, R, SL, SR, LFE
	PCM (Audio)	Multi Channel Stereo	○	○	○	○	-	PCM	L, R
	Analog	Multi Channel Stereo	○	○	○	○	-	ANALOG	-

**Note:**

- Dolby Digital (2 ch: Lt/Rt): signal with Dolby Surround flag Speakers are full set.
- No sound outputs from the surround speaker, center speaker and subwoofer if the DVD disc has no surround data.
- HDCD: OSE version only

- L/R : Front speakers
- C : Center speaker
- SL/SR : Surround speakers
- S : Surround Back speaker
- LFE : Sub woofer speaker

## OTHER FUNCTION

### TV AUTO ON/OFF FUNCTION

This function allows the component connected to the TV-VIDEO in jack to control the power (ON/OFF) to the SR7300.

#### AUTO POWER ON

1. Be sure TV auto mode is ENABLE. (Refer page 24 : System Setup)
2. Connect your TV TUNER (etc) to the TV-VIDEO in terminal. Be sure to connect the VIDEO input.
3. Turn OFF the power to the TV TUNER and the SR7300.
4. Turn ON the TV TUNER and tune in a receivable station.
5. When the station is received, the SR7300 turns ON and TV is selected automatically.

#### AUTO POWER OFF

1. In the above situation, turn the TV TUNER OFF or select a channel that does not contain any broadcast.
2. The power to the SR7300 switches to STANDBY after approx. 5 minutes.

#### Notes:

- AUTO POWER OFF is canceled if the SR7300 is set to a source other than TV.  
The function reactivates when TV is selected again.
- Some TV broadcasts may cause the TV AUTO FUNCTION to turn ON.
- S-Video terminal does not support "TV AUTO ON/OFF" function.

### ATTENUATION TO ANALOG INPUT SIGNAL

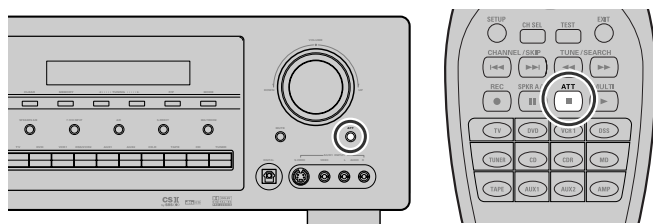

If the selected analog audio input signal is greater than the capable level of internal processing, "PEAK" indicator will light up on the front display. If this happens, you should press the **ATT** button on the front panel or on the remote.

"ATT" indicator will light up when this function is activated. The signal-input level is reduced by about the half. Attenuation will not work with the output signal of TAPE-OUT, CD-R/MD-OUT, VCR1-OUT, VCR2-OUT and MULTI ROOM OUT.

This function is memorized for each individual input source.

### LISTENING OVER HEADPHONES

This jack may be used to listen to the SR7300's output through a pair of headphones. Be certain that the headphones have a standard 1/4" stereo phone plug. (Note that the main room speakers will automatically be turned off when the headphone jack is in use.)

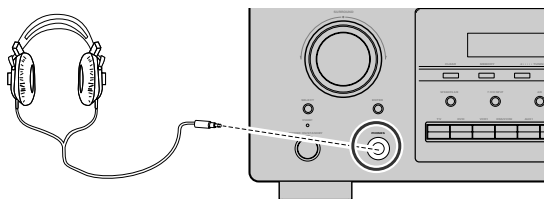

#### Notes:

- When using headphones, the surround mode will automatically change to STEREO.
- The surround mode returns to the previous setting as soon as the plug is removed from the jack.

### VIDEO ON/OFF

When no video signals of a DVD, etc., are connected to the SR7300 or the DVD, etc., are connected directly to a TV, the unnecessary video circuit can be turned off by selecting the "VIDEO OFF" setting.

To select video off condition, press the **V-OFF** on the remote.

Notes that VIDEO OFF will not work with the output signal of MULTI ROOM OUT.

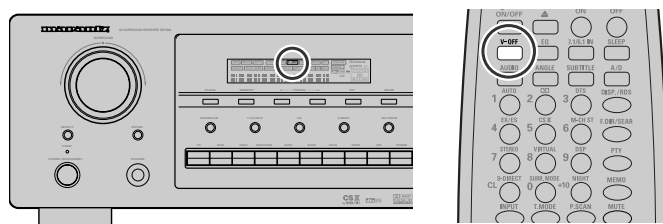

### DISPLAY MODE

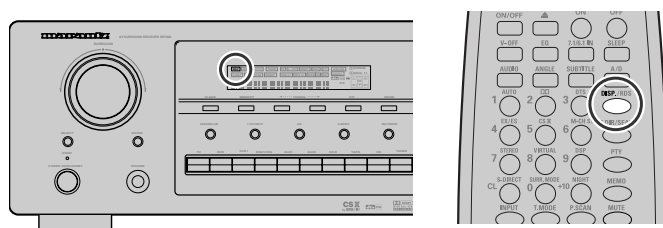

You can select the display mode for the front display of the SR7300. To select this mode, press the **DISP** on the remote control unit.

When this button is pressed, the display mode is switched in the following sequence.

→ Surround Mode → Auto-display Off → Display Off → Input Function → Surround Mode...

In Auto display off mode, turn the display on automatically, after that any condition of SR7300 is changed.

In Display off mode, turn the display off completely.

#### Notes:

- Only DISP indicator will light up on the front display in display off condition

### SELECTING ANALOG AUDIO INPUT OR DIGITAL AUDIO INPUT

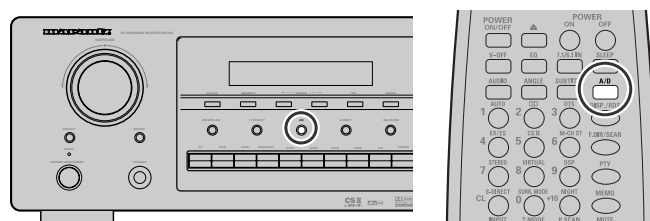

If you have already assign any digital input to input source.

You can select temporarily the audio input mode for each input source with the **A/D** button on the remote controller or front panel.

When this button is pressed, the input mode is switched in the following sequence.

→ Digital Auto → Digital → Analog → Digital Auto...

In Digital Auto mode, the types of signals being input to the digital and analog input jacks for the selected input source are detected automatically.

If no digital signal is being input, the analog input jacks are selected automatically.

In Digital mode, input is fixed to an assigned digital input terminal.

In analog mode, the analog input jacks are selected.

This selecting is temporarily, so the result will not be stored in memory.

If you need to change input mode completely, use SYSTEM SETUP in OSD menu system. (see page 22)

## RECORDING AN ANALOG SOURCE

In normal operation, the audio or video source selected for listening through the SR7300 is sent to the record outputs.

This means that any program you are watching or listening to may be recorded simply by placing machines connected to the outputs for **TAPE OUT**, **CD-R/MD OUT**, **VCR1 OUT**, and **DSS/VCR2 OUT** in the record mode.

*To record the input source signal you are currently watching or listening to*

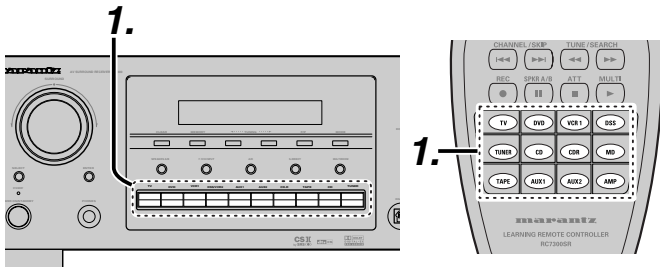

1. Select the input source to record by pressing the corresponding **input selector** button.  
The input source is now selected and you may watch or listen to it as desired.
2. Outputs the currently selected input source signal to the **TAPE OUT**, **CD-R/MD OUT**, **VCR1 OUT**, and **DSS/VCR2 OUT** outputs for recording.
3. Start recording at the recording component as desired.

**Recording the video from one source and the audio from another**  
You can add the sound from one source to the video of another source to make your own video recordings.

Below is an example of recording the sound from a compact disc player connected to CD IN and the video from a video camera connected to AUX1 IN to video cassette tape in a video cassette recorder connected to the VCR1 OUT jack.

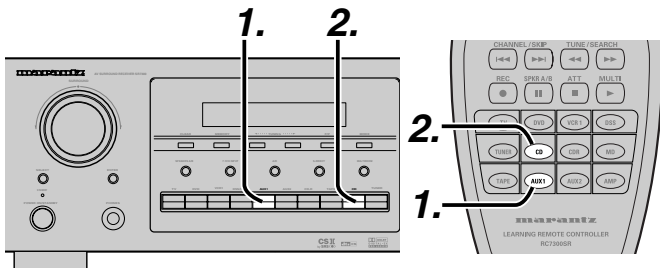

1. Press the **AUX1** input source button to set video output.
2. Press the **CD** input source button to set audio output.
3. Now "CD" has been selected as the audio input source and "AUX1" as the video input source.

### Notes:

- If you change the input source during recording, you will record the signals from the newly selected input source.
- You cannot record the surround effects.
- Digital input signals are only output to the digital outputs. There is no conversion from digital to analog.

When connecting CD players and other digital components, do not connect only the digital terminals, but the analog ones as well.

## HT-EQ

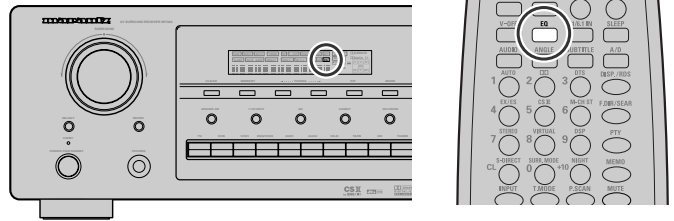

Press the **EQ** button on the remote to turn on the HT-EQ mode. The tonal balance of a film soundtrack will be excessively bright and harsh when played back over audio equipment in the home. This is because film soundtracks were designed to be played back in large movie theater environments. Activating the HT-EQ feature when watching a film made for movie theaters corrects this and restores the correct tonal balance.

## SPEAKER A/B

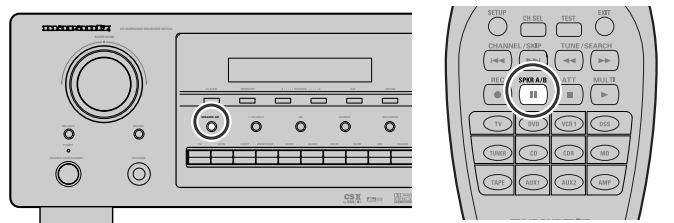

SR7300 has speaker system - A and speaker system- B to front L/R channels.

You can select these systems by pressing **SPEAKERS A/B** button on the front panel or **SPKR A/B** on the remote

## 7.1 CH INPUT.

The SR7300 is equipped for future expansion through the use of Multi channel SACD multi channel player or DVD-Audio player.

This is selected, the input signals connected to the L(front left), R (front right), CENTER, SL (surround left), SR (surround right), SBL (surround back left) and SBR (surround back right) channels of the 7.1 CH. In jacks are output directly to the front (left and right), center, surround (left and right) and surround back (left and right) speaker systems as well as the pre-out jacks without passing through the surround circuitry.

In addition, the signal input to the SW (subwoofer) jack is output to the PRE OUT SW (subwoofer) jack.

When 7.1 CH. INPUT is selected, the last video input used remains routed to the **Monitor Outputs**.

This permits simultaneous viewing with video sources.

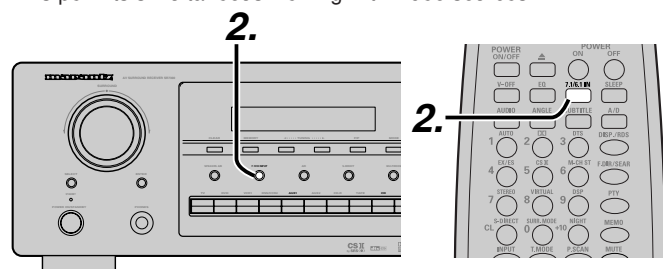

1. Select a desired Video source to decide the routed video signal to the **Monitor Outputs**.
2. Press the **7.1 CH INPUT** button on the front panel or press **7.1/6.1 IN** on the remote to switch the 7.1 channel input.
3. If necessary to adjust the output level of each channel, use "7.1 Ch. INPUT LEVEL" in OSD menu system as desired.  
Adjust the speaker output levels so that you can hear the same sound level from each speaker at the listening position. For the front left, front right, center, surround left, surround right, surround back left and surround back right speakers, the output levels can be adjusted between  $-10$  to  $+10$  dB.  
The subwoofer can be adjusted between  $-15$  and  $+10$  dB.  
These adjusting result will be stored to 7.1 Ch. INPUT condition.  
(see to page 26)
4. Adjust the main volume with the MAIN VOLUME knob or the VOL buttons on the remote.

To cancel the 7.1 Ch. INPUT setting, press the **7.1 CH-IN** button on the front panel or press **7.1/6.1 IN** on the remote.

### Notes:

- When the 7.1 Ch. Input is in use, you may not select a surround mode, as the external decoder determines processing.
- In addition, there is no signal at the record outputs when the 7.1 Ch. Input is in use.

## AUX2 INPUT

If you don't need to connect 7.1 Ch. input terminals with multi channel decoder,

L(front left) and R (front right) inputs terminals are available as AUX2 input.

In this case, You can connect additional audio source to AUX2 as other audio input terminals.

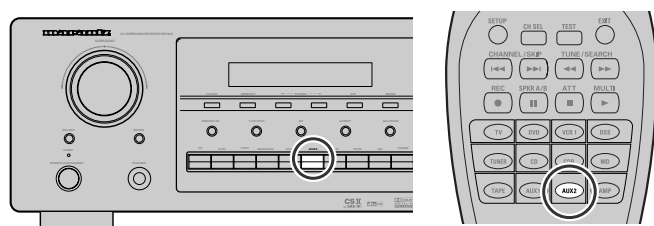

# BASIC OPERATION (TUNER)

## LISTENING TO THE TUNER

Frequency scan step for AM is selectable.  
Default setup is 10 kHz step, if your country's standard is 9 kHz step, Press **TUNER** button on the remote more than 6 seconds. Scan step will change.

**Note:**

- Preset memory for the tuner will clear by changing this setup.

### AUTO TUNING

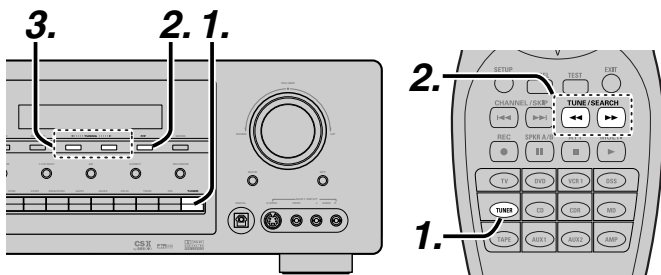

**(USING THE SR7300)**

1. To select tuner and desired band (FM or AM), press the **TUNER** button on the front panel.
2. **F/P** button on the front panel to display the frequency.
3. Press the **TUNING** ◀ or ▶ button on the front panel for more than 1 second to start the Auto tuning function.
4. Automatic searching begins then stops when a station is tuned in.

**(Using the remote control unit)**

1. To select tuner and desired band (FM or AM), press **TUNER** button twice within in two seconds on the remote.
2. Press ◀ or ▶ more than 1 second on the remote.
3. Automatic searching begins then stops when a station is tuned in.

If tuning does not stop at the desired station, use to the "Manual tuning" operation.

### MANUAL TUNING

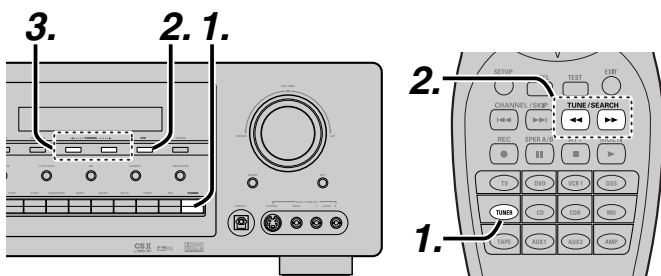

**(USING THE SR7300)**

1. To select tuner and desired band (FM or AM), press the **TUNER** button on the front panel
2. Press the **F/P (Frequency/Preset)** button on front panel, to appears frequency on the display.
3. Press the **TUNING** ◀ or ▶ button.

**(Using the remote control unit)**

1. To select tuner and desired band (FM or AM), press **TUNER** button twice within in two seconds on the remote.
2. Press ◀ or ▶ on the remote to tune in the desired station.

### DIRECT FREQUENCY CALL

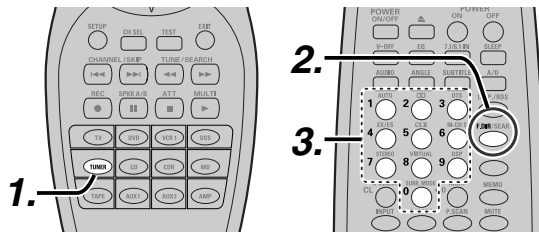

1. To select tuner and desired band (FM or AM), press **TUNER** button twice within in two seconds on the remote.
2. Press the **F.DIR** on the remote, display will show "FREQ - - - -".
3. Input your desired station's frequency with ten keypad on the remote.
4. The desired station will automatically be tuned.

### (FM) TUNING MODE (AUTO STEREO OR MONO)

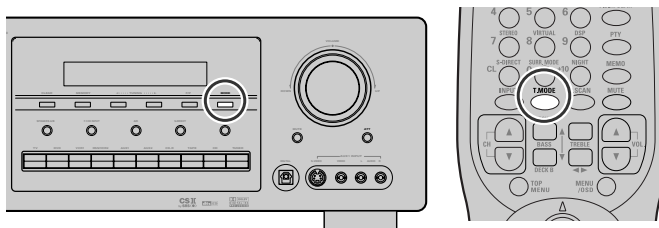

When in the auto stereo mode, **AUTO** indicator keeps to light on the display.

The "ST" indicator lights on when a stereo broadcast is tuned in. At open frequencies, the noise is muted and the "TUNED" and "ST" indicators turn off.

If the signal is weak, it may be difficult to tune into the station in stereo. In such a case, press the **MODE** button on the front panel or press **T.MODE** button on the remote.

"AUTO" indicators turn off, FM stereo broadcasts are received in monaural and the "ST" indicator turns off.

To return to auto stereo mode, press the **MODE** button or press **T.MODE** button on the remote again. **AUTO** indicator lights on the display.

### PRESET MEMORY

With this unit you can preset up to 50 FM/AM stations in any order. For each station, you can memorize the frequency and reception mode if desired.

### AUTO PRESET MEMORY

This function automatically scans the FM and AM band and enters all stations with proper signal strength into the memory.

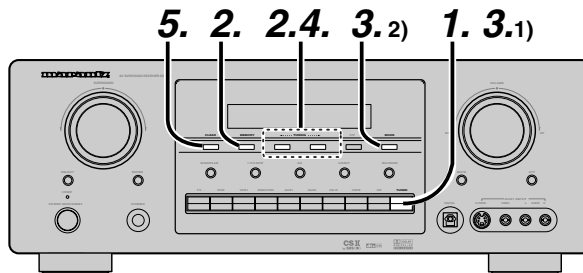

1. To select FM, press the **TUNER** button on the front panel.
2. While pressing the **MEMORY** button, press the **TUNING** ▶ button to up.  
"AUTO PRESET" will appear on the display, and scanning starts from lowest frequency.

3. Each time the tuner finds a station, scanning will pause and the station will be played for five seconds. During this time, the following operations are possible.
  - 1) The band can be changed by **TUNER** button .
  - 2) The tuning mode can be changed by **MODE** button.
4. If no button is pressed during this period, the current station is memorized in location Preset 02  
If you wish to skip the current station, press the **TUNING** ► button during this period, this station is skipped and auto presetting continues.
5. Operation stops automatically when all 50 preset memory positions are filled or when auto scanning attains the highest end of all bands. If you desire to stop the auto preset memory at anytime, press the **CLEAR** button.

**MANUAL PRESET MEMORY**

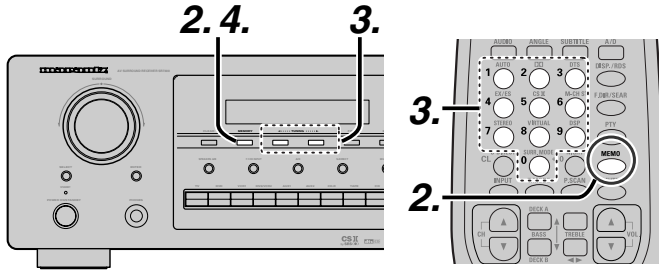

*(Using the SR7300)*

1. Tune into the radio station you desire (Refer to the “MANUAL TUNING” or “AUTO TUNING” section).
2. Press the **MEMORY** button on the front panel. “- -” (preset number) starts blinking on the display.
3. Select the preset number by pressing the **TUNING** ◀ or ▶ button, while this is still blinking (approx. 5 seconds)
4. Press the **MEMORY** button again to enter. The display stops blinking.  
The station is now stored in the specified preset memory location.

*(Using the remote control unit)*

1. Tune into the radio station you desire (Refer to the “MANUAL TUNING” or “AUTO TUNING” section).
2. Press the **MEMO** on the remote unite. “- -” (preset number) starts blinking on the display.
3. Enter the desired preset number by pressing **numeric** buttons.

**Note:**

- When entering a single digit number (2 for example), either input “02” or just input “2” and wait for a few seconds.

**RECALLING A PRESET STATION**

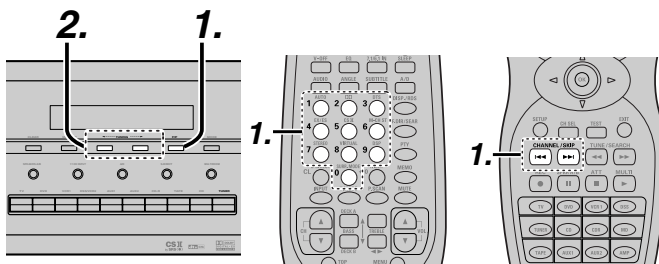

*(Using the SR7300)*

1. Press the **F/P** button to show the preset station on the display.
2. Select the desired preset station by pressing the **TUNING** ◀ or ▶ button on the front panel

*(Using the remote control unit)*

1. Press the ◀ or ▶ button to select the desired preset station, or input your desired preset channel with **numeric** buttons on the remote.

**PRESET SCAN**

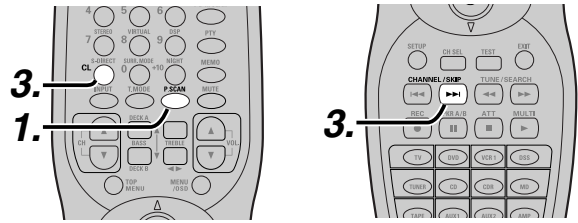

*(Using the remote control unit)*

1. Press the **P.SCAN** on remote.  
“PRESET SCAN” appears on the display and then the preset station with the lowest preset number is recalled first.
2. Preset stations are recalled in sequence (No.1 → No.2 → etc.) for 5 seconds each.  
No stored preset number will be skipped.
3. You can fast forward the preset stations by pressing the ►► continuously.  
When the desired preset station is received, cancel the preset scan operation by pressing the **CL** button or **P.SCAN** on the remote.

**CLEARING STORED PRESET STATIONS**

You can remove preset stations from memory using the following procedure.

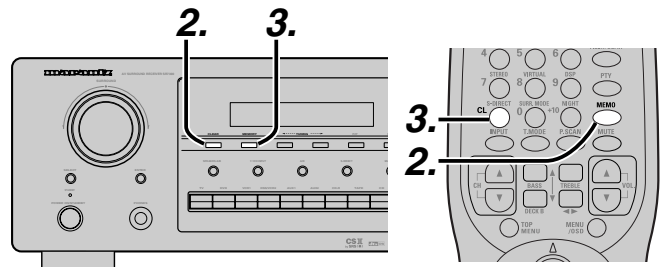

1. Recall the preset number to be cleared with the method described in “Recalling” a preset station.
2. Press the **MEMORY** button on the front panel or press **MEMO** button on the remote.
3. Stored preset number blinks in the display for 5 seconds. While blinking, press the **CLEAR** button on the front panel or press **CL** button on the remote.
4. “xx CLEAR” appears on the display to indicate that the specified preset number has been cleared.

**Notes:**

- To clear stored all preset stations, press and hold the **CLEAR** and the **F/P** buttons for two seconds.



**SORTING PRESET STATIONS**

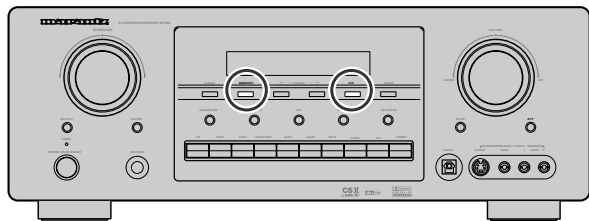

Stored preset stations number can be kept line.  
To sort the numbers, press and hold the **MEMORY** and the **F/P** buttons.  
"PRESET SORT" will appear on the display and sorting will be done.

**NAME INPUT OF THE PRESET STATION.**

This function allows the name of each preset channel to be entered using alphanumeric characters.  
Before name inputting, need to store preset stations with the preset memory operation.

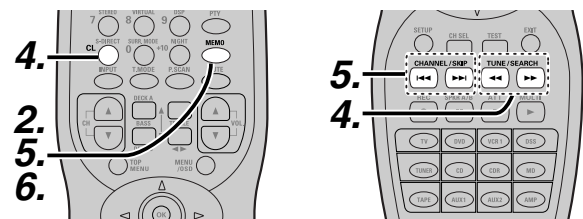
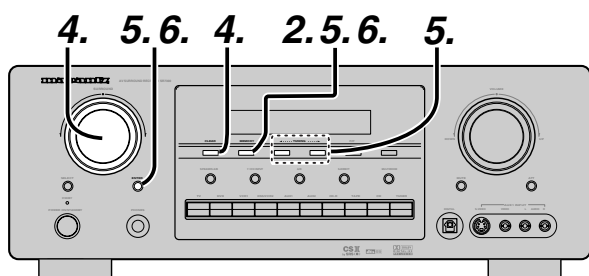

1. Recall the preset number to be inputted name with the method described in "Recalling" a preset station.
2. Press the **MEMORY** button on the front panel or press **MEMO** button on the remote for more than 3 seconds.
3. The left most column of the station name indicator flashes, indicating the character entry ready status.
4. When the **SELECT** knob is turned or press **◀/▶** button on the remote alphabetic and numeric characters will be displayed in the following order:  
**A → B → C ... Z → 1 → 2 → 3 ..... 0 → - → + → / → (Blank) → A**  
**UP →**  
**← DOWN**
5. After selecting the first character to be entered, press the **MEMORY** or **ENTER** buttons, press **MEMO** button on the remote. The entry in this column is fixed and the next column starts to flash. Fill the next column same as.  
To move back and forth between the characters, press the **TUNING ◀/▶** button or press **◀◀** or **▶▶** buttons on the remote.  
**Note:**
  - Unused columns should be filled by entering blanks.
6. To save name, press the **MEMORY** or **ENTER** button, press **MEMO** button on the remote for more than 2 seconds.

## MULTI ROOM SYSTEM

The Multi Room system is a function which allows you to listen to the same or a different source in a room other than the room in which the SR7300 is located.

To use this function, a multi room remote unit and remote control signal receiver available from your Marantz dealer are necessary. The operations possible with the multi room function are explained briefly below.

For details, refer to the instruction manual supplied with the multi room remote control unit and receiver.

When the outputs of the MULTI ROOM OUT terminals are wired and connected to amplifiers installed in other rooms, different sources can be played in rooms other than the main room in which this unit and the playback devices are installed.

SR7300 has some feature to MULTI ROOM SYSTEM as source selector, OSD information, sleep timer and remote control.

### MULTI ROOM PLAYBACK USING THE MULTI ROOM OUT TERMINALS

The SR7300 is equipped with audio pre-out terminals for which the volume is adjustable and composite video output terminals as the MULTI ROOM output terminals.

A separately sold stereo power amplifier (SM6100) can be connected to enjoy multi room playback.

**Operation to MULTI ROOM OUT without the remote controller.**

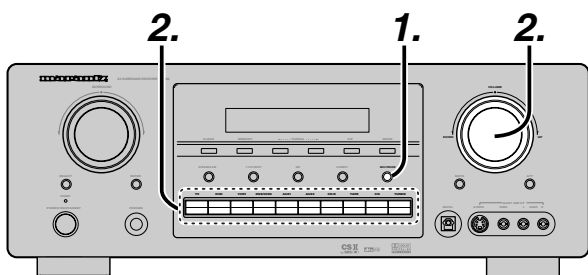

1. Press the **MULTI ROOM** button. The unit enters multi room mode and the display indicates "**SELCT SOURCE**" and flashes the "**MULTI**" indicator for approx. 10 seconds.
2. In this time, you can select the input source by pressing the input selector buttons. Then, the display indicates "**MULTI VOL**" "**VOLUME xx dB**" for approx. 5 seconds.
3. During this time, you can set the volume level in the multi room as desired. This will only set the volume in the second room.

### OPERATION TO MULTI ROOM OUTPUTS WITH THE REMOTE CONTROLLER FROM SECOND ROOM.

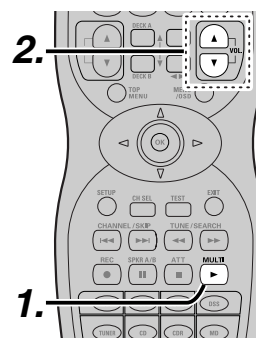

1. Press the **MULTI** on multi room remote control unit from the MULTI ROOM. This operations will put the SR7300 into multi room mode and "**MULTI**" will light in the display. MULTI ROOM Video output will show OSD information to condition of MULTI ROOM setup.

MULTI ROOM	
MULTI ROOM	: OFF
VIDEO	: DVD
AUDIO	: DVD
VOLUME SETUP	: VARIABLE
VOLUME LEVEL	: -90 dB
SLEEP TIMER	: OFF
- - - MAIN-ROOM STATUS - - -	
VIDEO: DVD	AUDIO: DVD
MAIN	EXIT

2. Press the **VOL. ▲** or **VOL. ▼** button on the multi room remote control unit to set the desired sound volume.
3. In multi room mode, the multi room remote control unit can be used in the multiroom to operate the following functions.

#### General:

- Controlling volume level, sleep timer, and muting. Selecting input audio and video source.

#### Tuner:

- Selecting band, controlling preset channel up and down, tuning up and down, direct frequency call.

#### Notes for multi room system:

- The MULTI ROOM OUT is analog outputs. This is not support to digital signals input.
- If Tuner (FM or AM) is active in main room, you can not control any function of tuner. In this case, you can listen the same condition as main room.

# REMOTE CONTROLLER OPERATION

## CONTROLLING MARANTZ COMPONENTS

1. Press the desired function button.
  - The selected function name and **USE** are displayed in LCD.
2. Press the desired operation buttons to play the selected component.
  - For details, refer to the components's user guide.
  - It may not be possible to operate some models.

### CONTROLLING A MARANTZ DVD PLAYER (DVD MODE)

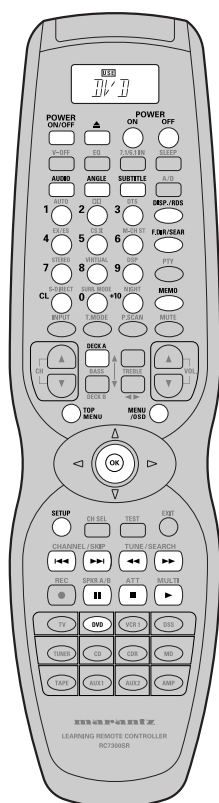

POWER ON/OFF	Turns the DVD player on and off
POWER ON	Turns the DVD player on
POWER OFF	Turns the DVD player off
▲	Opens / closes the disc tray
AUDIO	Selects the audio language
ANGLE	Selects the camera angle
SUBTITLE	Selects the subtitle language
0 - 9, +10	Inputs the numeric
DISP	Displays the disc information
F.DIR/SEAR	Searches the title or track
CL	Clears the inputting
MEMO	Calls up programming menu
DECK A	Next disc tray
TOP MENU	Calls up the top menu of the DVD disc
MENU/OSD	Calls up the menu of the DVD disc
Cursor, OK	Moves the cursor, enters the setting
SETUP	Calls up the setup menu of the DVD player
◀◀ / ▶▶	Skips forward or previous chapter/track
◀◀ / ▶▶	Searches forward or backward
⏸	Pause
■	Stop
▶	Play

### CONTROLLING A MARANTZ CD PLAYER (CD MODE)

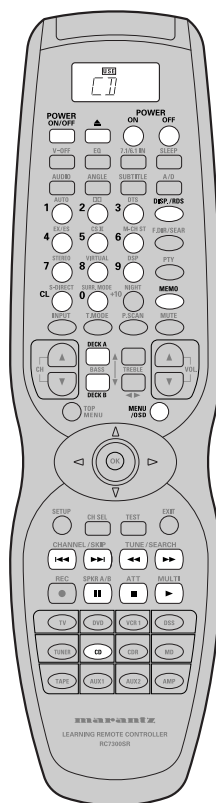

POWER ON/OFF	Turns the CD player on and off
POWER ON	Turns the CD player on
POWER OFF	Turns the CD player off
▲	Opens / closes the disc tray
0 - 9	Inputs the numeric
DISP	Scrolls the disc information
CL	Clears the inputting
MEMO	Programs
DECK A, B	Changes the disc tray
MENU/OSD	Switches the display information
◀◀ / ▶▶	Skips forward or previous track
◀◀ / ▶▶	Searches forward or backward
⏸	Pause
■	Stop
▶	Play

### CONTROLLING A MARANTZ VCR (VCR1 MODE)

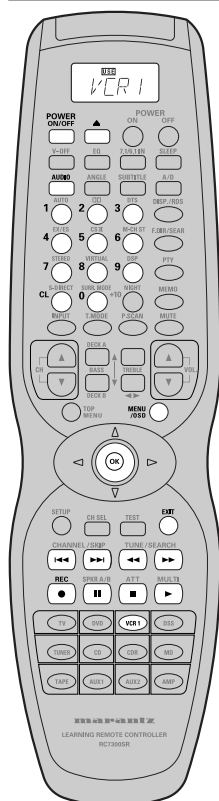

POWER ON/OFF	Turns the VCR on and off
▲	Ejects the tape
AUDIO	Selects the audio language
0 - 9	Inputs the numeric
CL	Clears the inputting
MENU/OSD	Calls up the menu
Cursor, OK	Moves the cursor, enters the setting
EXIT	Exits the programming menu
◀◀ / ▶▶	Skips forward or previous track
◀◀ / ▶▶	Searches forward or backward
●	Record
⏸	Pause
■	Stop
▶	Play

### CONTROLLING A MARANTZ CD RECORDER (CDR MODE)

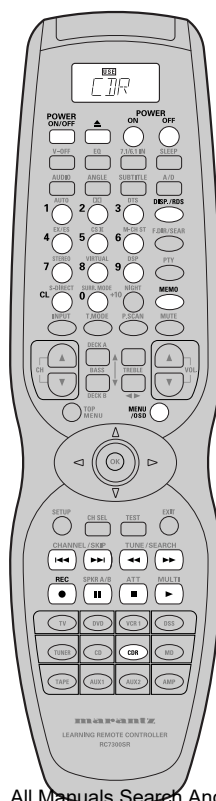

POWER ON/OFF	Turns the CD recorder on and off
POWER ON	Turns the CD recorder on
POWER OFF	Turns the CD recorder off
▲	Opens / closes the disc tray
0 - 9	Inputs the numeric
DISP	Switches the display information
CL	Clears the inputting
MEMO	Programs
MENU/OSD	Scrolls the disc information
◀◀ / ▶▶	Skips forward or previous track
◀◀ / ▶▶	Searches forward or backward
●	Record
⏸	Pause
■	Stop
▶	Play

**CONTROLLING A MARANTZ MD DECK (MD MODE)**

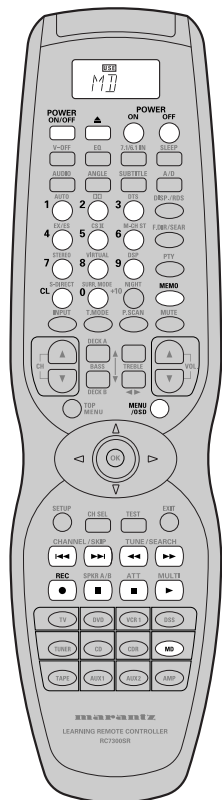

POWER ON/OFF	Turns the MD deck on and off
POWER ON	Turns the MD deck on
POWER OFF	Turns the MD deck off
▲	Eject the MD disc
0 - 9	Inputs the numeric
CL	Clears the inputting
MEMO	Programs
MENU/OSD	Switches the display information
◀◀ / ▶▶	Skips forward or previous track
◀◀ / ▶▶	Searches forward or backward
●	Record
	Pause
■	Stop
▶	Play

**CONTROLLING A MARANTZ TAPE DECK (TAPE MODE)**

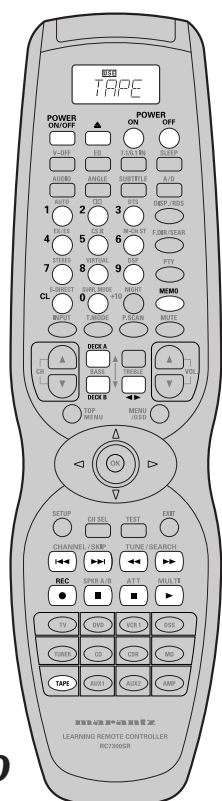

POWER ON/OFF	Turns the tape deck on and off
POWER ON	Turns the tape deck on
POWER OFF	Turns the tape deck off
▲	Eject the tape
0 - 9	Inputs the numeric
CL	Clears the inputting
MEMO	Programs
DECK A B	Changes the tape deck
◀▶	Changes the direction
◀◀ / ▶▶	Skips forward or previous track
◀◀ / ▶▶	Searches forward or backward
●	Record
	Pause
■	Stop
▶	Play

## LEARN MODE

The remote controller is capable of learning and memorizing the remote control codes used by almost any other remote controller you may already own.

- If no commands have been programmed for a particular function button, the remote controller will transmit whatever codes have been factory preset.
- The following example shows how to program your remote controller and how to use the codes for a DVD player.

### LEARNING PROCEDURE

1. Place the remote controller so that its infrared signal transmitter is facing the infrared signal receiver on the Marantz remote controller at a distance of about 5 centimeters.

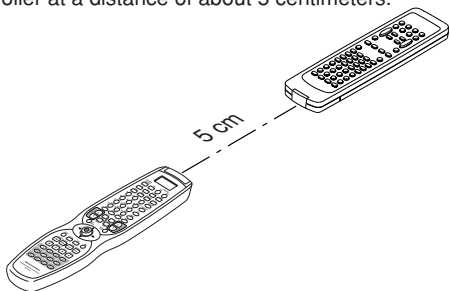

2. Press and hold down the **T.MODE** and **MEMO** buttons until **LEARN** is displayed in the display.



3. Select the **Function** button to select the function.
  - Selected function is displayed and **LEARN** is blinking.

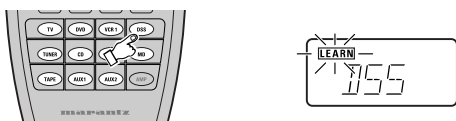

4. Select the button to be learned.
  - **LEARN** is displayed.



5. Press and hold the button of the original remote controller to learn until **OK** in the display.
  - When **NG** is displayed, repeat this step.
  - When **FULL** is displayed, the memory of the RC7300SR is full. If you want to learn the code, you should erase other learned button.

6. Repeat steps 4 and 5 to learn other buttons in same function.

7. Repeat steps 3 to 6 to learn other function.

8. When you have finished programming the remote controller, press and hold down the **OK** button until **USE** is displayed in the display.



#### Note:

- When NG is displayed in step 5 again, the transmitting code is unavailable for RC7300SR, or the transmitting signal is intercepted by noise.
- If no buttons are pressed for approximately 1 minutes while in the LEARN mode, the remote controller automatically returns to the use mode.

## ERASING LEARNING CODE

### Erasing the code by buttons

1. Press and hold down the **T.MODE** and **MEMO** buttons until **LEARN** is displayed in the display.



2. Select the **Function** button to select the button to be erased.
  - Selected function is displayed and **LEARN** is blinking.



3. Press and hold down the **CL** button and press the learned button twice to be erased.
  - **CLR** is displayed for 3 seconds and the mode returns to LEARN mode.



4. To return the USE mode, press and hold down the **OK** button until **USE** is displayed in the display.

### Erasing the code by functions

1. Press and hold down the **T.MODE** and **MEMO** buttons until **LEARN** is displayed in the display.



2. Press and hold down the **CL** button and press the learned **Function** button twice to be erased.
  - **F-CLR** and **LEARN** are blinking.

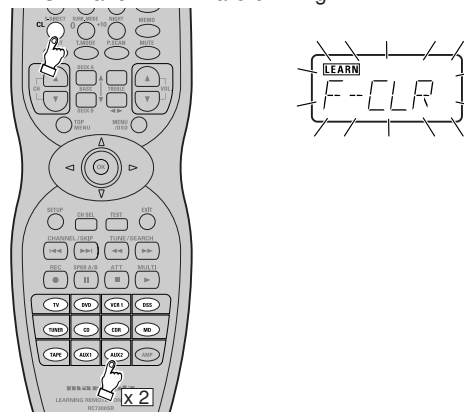

3. Press **OK** button to continue erasing.
  - **F-CLR** is displayed for 3 seconds and the mode returns to LEARN mode.

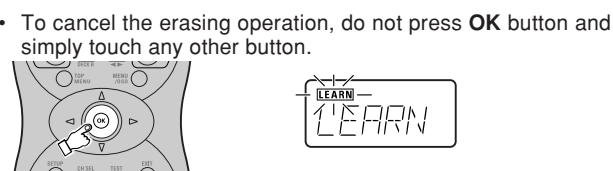

4. To return the USE mode, press and hold down the **OK** button until **USE** is displayed in the display.

**Erasing the all functions**

1. Press and hold down the **T.MODE** and **MEMO** buttons until **LEARN** is displayed in the display.



2. Press and hold down the **CL** button and press **POWER ON** and **POWER OFF** button.

- **A-CLR** and **LEARN** are blinking.

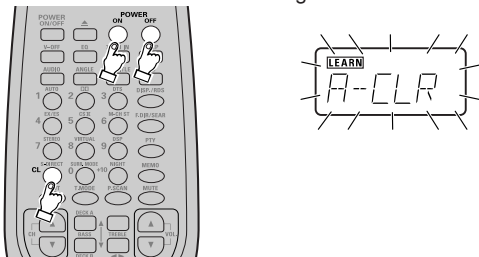

3. Press **OK** button to continue erasing.

- **A-CLR** is displayed for 3 seconds and the mode returns to **LEARN** mode.
- To cancel the erasing operation, do not press **OK** button and simply touch any other button.



4. To return the **USE** mode, press and hold down the **OK** button until **USE** is displayed in the display.

**Note:**

- Erasing codes will return to the factory preset code, or there will leave empty if the button has no factory preset code.

**MACRO MODE**

**PROGRAMMING MACROS**

Macros make it possible to use a single function button to perform more complex series of operations that would normally require pressing several buttons. A single button can be programmed to perform up to 10 steps in sequence. A typical example of such a series might be as follows:

- Turn the main amplifier power ON → Switch the function to DVD → Set the Surround Mode to Virtual → Set the DVD player to PLAY.
- No signals may be transmitted during macro programming.
- The various steps that make up a macro are set initially to be sent one after another in 1 second intervals, however these intervals may be shortened to as little as 0.5 seconds or lengthened to as much as 5 seconds using the Setup mode.
- In the macro mode, the number of steps the macro is displayed the following selected function name.
- Macros may be programmed for each of the 12 function buttons as follows:  
TV, DVD, VCR1, DSS, TUNER, CD, CDR, MD, TAPE, AUX1, AUX2, AMP

1. Press and hold the **T.MODE** and **MENU** button until the **MACRO** is displayed.

- **MACRO** and **LEARN** indicators are displayed blinking on the LCD, too.

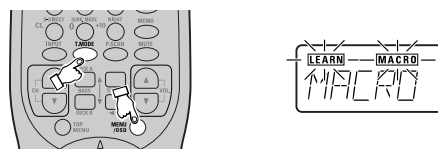

2. Press the **Function** button for which you wish to program a series of operations.

In this case, let's use the example of the DVD player. Press the **DVD Function** button. The LCD will display DVD-M.



Characters displayed on LCD include the following, depending on the function button for which the macro is being programmed:  
TV-M, DVD-M, VCR-M, DSS-M, TUN-M, CD-M, CDR-M, MD-M, TAP-M, AX1-M, AX2-M, AMP-M

- If a macro has already been set for the selected function button, the LCD will blink.

3. Press the buttons for the operations you wish to program as a macro in the sequence you want the macro to program them. For example, press DVD, PLAY.

- The number of steps in the macro is displayed on LCD and this number increases by 1 with each button pressed.
- Each function button can be programmed to perform up to 10 steps in sequence.



- When you are finished programming macros, press and hold the **OK** button until the display returns to **USE** mode.

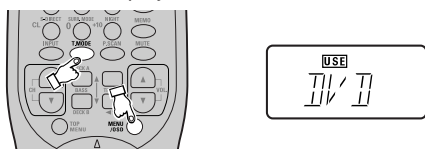

- Macros cannot be programmed for the **MEMO**, **cursor/OK**, **VOL ▲/▼** or **CL** buttons.

In the macro mode it is possible to program the memory to perform macros containing up to 10 steps.

- Each of the function operations (12 including CD, CD-R, etc.) can be used in a macro more than once, however for all except AMP, only the first function operation will be transmitted as a signal from the remote controller. Accordingly, within a single macro, it is not possible to switch between multiple function operations. (This is to prevent the switching of the receiver function operation.) Within a macro, the second time a function operation is used, it will only be used on the remote controller itself and no signal will be transmitted to the component.

**Note:**

- If, while programming, no buttons are pressed for approximately 1 minute, the remote controller will automatically return to normal mode, and no macro will be programmed in the memory.

**CONFIRMING MACROS**

Macros may be confirmed using following procedure.

- Press and hold the **T.MODE** and **MENU** button until the **MACRO** is displayed on the LCD.
  - **LEARN** and **MACRO** is displayed blinking.

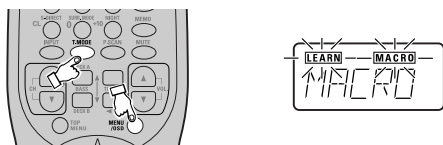

- Press the **Function** button to be confirmed. Let's use the example of the DVD player, by pressing the **DVD Function** button.
  - **DVD-M**, **LEARN** and **MACRO** is displayed blinking.



- Press the **VOL ▲** button.
  - **DVD-1** is displayed and **LEARN** is disappeared.
  - The programmed operation is transmitting.



- Repeat step 3. until the last number of the macro is displayed.
  - The display will return to step 1.
  - The each programmed operation is transmitting when the number of the macro is displayed.

- To return the **USE** mode, press and hold down the **OK** button until **USE** is displayed in the display.

**EDITING MACROS**

Macros may be edited using following procedure.

- Press and hold the **T.MODE** and **MENU** button until the **MACRO** is displayed on the LCD.
  - **LEARN** and **MACRO** is displayed blinking.

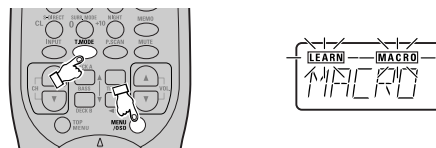

- Press the **Function** button to be changed. Let's use the example of the DVD player, by pressing the **DVD Function** button.
  - **DVD-M**, **LEARN** and **MACRO** is displayed blinking.



- Press the **Cursor ▲ / ▼** button to select the number of macro to be edited.

- The programmed operation is displayed after the number of macro is displayed.
- The number of macro can be changed with the cursor ▲ / ▼ button .
- To rewrite an existing macro step, simply press the button for the new step. The old step will be erased and rewritten with the new step.
- To insert a new step in between existing steps in a macro, after step 3 press the **MEMO** button, then press the button for the new step. The numbers of the other steps will be adjusted accordingly to accommodate the new step. Since only 10 steps may be stored in any macro, the tenth step will be erased if an step is inserted when the total number of steps is already 10.
- To erase a step in a macro, after step 3 call up the number of the step to be erased and press the **CL** button.

- Press the **OK** button to return step 1.
- To return the **USE** mode, press and hold down the **OK** button until **USE** is displayed in the display.

**USING MACROS**

The following procedure will show how to use the function buttons for which you have programmed macros.

- Press the **Function** button for the desired macro for 3 seconds.
  - **MACRO** is displayed on LCD for approximately 1 second, after which the number of steps in the macro is displayed on LCD.

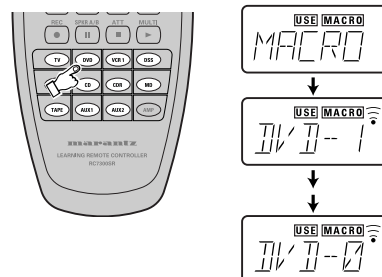

- The remote controller will do nothing if no macros are programmed. The macro steps are executed in order and the names of their buttons are displayed on the LCD. Also, the step numbers displayed on LCD disappear as each step is executed.

- After all macro commands have been transmitted, the remote controller returns to **AMP** in use mode.

**EXAMPLES OF MACRO PROGRAMS**

**Example 1**

Change the input source for the amplifier to CD and play the 3rd track on a CD in the CD player.

1. Press and hold the **T.MODE** and **MENU** button until the **MACRO** is displayed on the LCD.
  - **LEARN** and **MACRO** is displayed blinking.

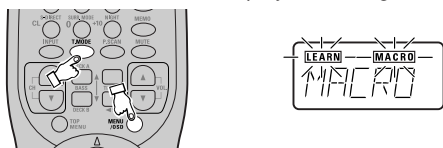

2. Press the **CD Function** button. CD-M is displayed on the LCD.



3. Press **CD**, **3**, and **▶** buttons.

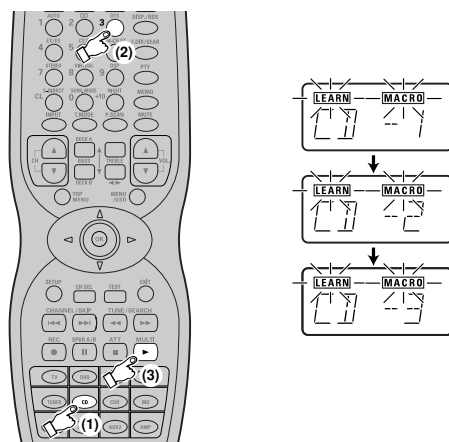

4. When you are finished programming the macro, press the **OK** button until the display returns to **USE** mode.



Now, execute the macro you just programmed.

1. Press the **CD Function** button for 3 seconds.

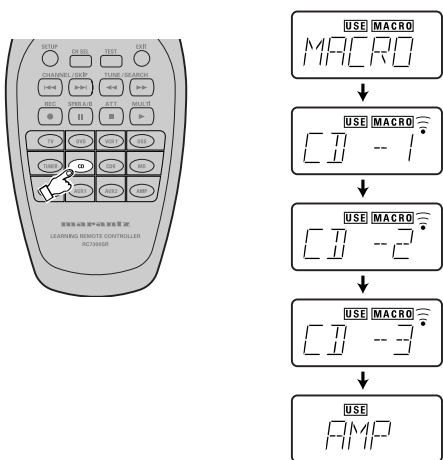

- The macro commands are transmitted to the components in order, and the steps of the operations are displayed on the LCD in order.

**Example 2**

Turn the main amplifier ON → Change the amplifier's input source to DVD → Set the Surround mode to VIRTUAL → Set the DVD player to PLAY

1. Press and hold the **T.MODE** and **MENU** button until the **MACRO** is displayed on the LCD.
  - **LEARN** and **MACRO** is displayed blinking.



2. Press the **DVD Function** button.
  - Here the **DVD Function** button is used as the macro button, but any function button can in fact be used.



3. To set the various steps of the macro, press the following buttons in order:
  - (1) **AMP\*** → (2) **POWER ON** → (3) **DVD** → (4) **AMP\*** → (5) **8 (VIRTUAL)** → (6) **DVD\*** → (7) **▶**.

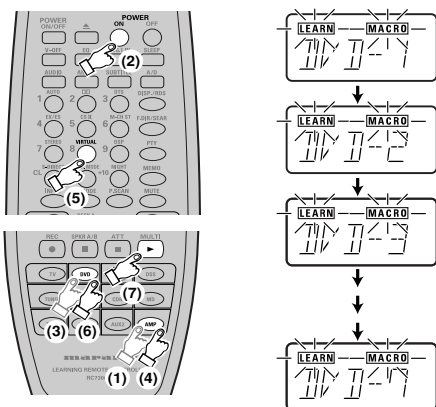

4. When you are finished programming the macro, press the **OK** button until the display returns to **USE** mode.



Now, execute the macro you just programmed.

1. Press the **DVD Function** button for 3 seconds.
  - The macro commands are transmitted in order, and the steps of the operations are displayed on LCD in order.

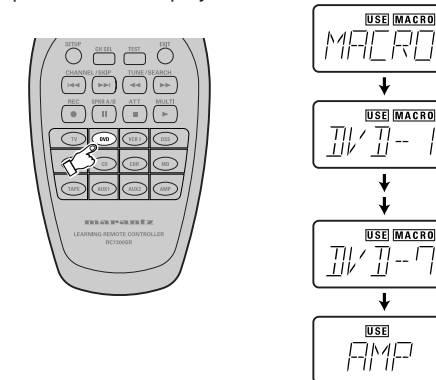

- When executing this macro, function operations AMP\* and DVD\* only switch the command set of the remote controller and no signal is transmitted to the component.



### CLEARING MACRO PROGRAMS

The following procedure is used to erase macros you have programmed into the remote controller's memory.

1. Press and hold the **T.MODE** and **MENU** button until the **MACRO** is displayed on the LCD.
  - **LEARN** and **MACRO** is displayed blinking.

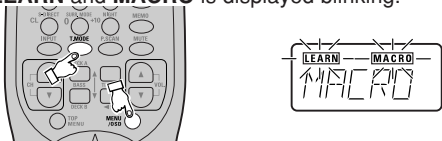

2. Press and hold the **CL** button, then press the button for the **Function** to be cleared (in this case DVD) for 3 seconds. **DVDCL** will appear on LCD.

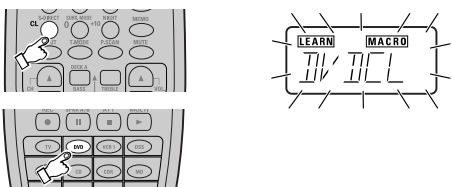

3. Press the **OK** button to clear and return step 1.
  - To cancel the memory clearing operation, do not press **OK** button and simply touch any other button.



4. To return the **USE** mode, press and hold down the **OK** button until **USE** is displayed in the display.

### ADJUSTING THE INTERVAL TIME OF MACRO

#### OPERATIONS TRANSMITTING

1. Press and hold the **T.MODE** and **SETUP** button until the **SETUP** is displayed on the LCD.
  - **SETUP** is displayed for 3 seconds

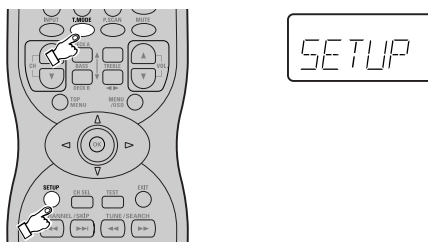

2. Confirm the display changes from **SETUP** to **MCRxx**. ("xx" means the interval time of macro operations transmitting )



3. Press the **Cursor** </> button to change the interval time.
  - The interval time can be changed from 0.5 to 5 seconds by 0.5 seconds step.

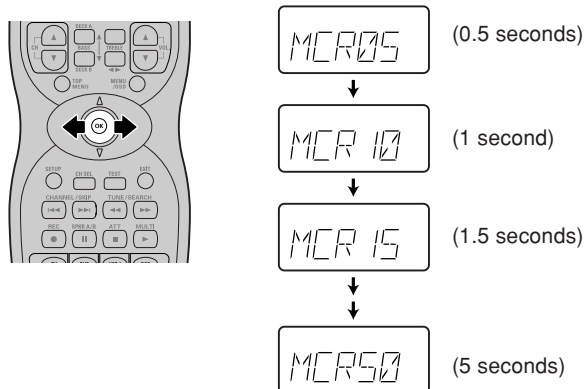

4. Press and hold down the **OK** button until **USE** is displayed in the display.



# TROUBLESHOOTING

In case of trouble, check the following before calling for service:

1. Are the connections made properly ?
2. Are you operating the unit properly following user's guide ?
3. Are the power amplifiers and speaker working properly ?

If the unit does not operate properly, check items shown in the following table.

If your trouble cannot be recovered with the remedy actions listed in the following table, malfunction of the internal circuitry is suspected; immediately unplug the power cable and contact your dealer, nearest Marantz distributor or the Marantz Service Center in your country.

SYMPTOM	CAUSE	REMEDY
SR7300 cannot be turned up.	The power plug is not connected.	Connect the power plug to the outlet.
No sound and picture are output even when power is on.	Mute is on. The input cable is not connected correctly. The master volume control is turned all the way down. The function selector position is wrong.	Cancel mute using the remote control unit. See the connection diagram and connect the cables correctly. Adjust the master volume. Select correct position.
Speaker does not outputting any sound.	The headphones are connected to the headphone jack.	Disconnect the headphones. (Speakers will not output sound when headphones are connected.)
Sound and pictures from other than equipment selected with the function selector.	Input cable connected incorrectly.	Connect the cable correctly by referring to the connection diagram.
Sound from the wrong channel is output from the speaker.	Speaker cable connected incorrectly.	Connect the cable correctly by referring to the connection diagram.
No sound is output from the center speaker.	The center speaker cable connection is incomplete. STEREO has been selected for Surround mode. Center = NONE has been selected in SETUP mode.	Connect the cable correctly. When STEREO is selected for Surround mode, no sound will be output from the center speaker. Set another Surround mode. Make the correct setting.
No sound is output from the surround speakers.	The surround speaker cable connection is incomplete. STEREO has been selected for Surround mode. Surround = NONE has been selected in SETUP mode.	Connect the cable correctly. When STEREO has been selected for Surround mode, no sound will be output from the surround speaker. Set another Surround mode. Make the correct setting.
No sound is output from the surround back speaker	The surround back speaker cable connection is incomplete Surround mode is not EX/ES mode. Surround back = NONE has been selected in SPEAKERS SIZE SETUP	Connect the cable correctly. Set surround mode EX/ES Make the correct setting.
Can not select EX/ES mode.	Surround center= NONE has been selected in SPEAKERS SIZE SETUP Input signal is incompatible.	Make the correct setting. Use 5.1channel source.
Can not select Pro Logic II mode.	Input signal is incompatible.	Use 2 channel Dolby Digital input signal, PCM input signal or analog input signal.
Can not select Neo:6 mode.	Input signal is incompatible.	Use 2 channel Dolby Digital input signal, PCM input signal or analog input signal.
Can not select CSII mode.	Input signal is incompatible.	Use 2 channel Dolby Digital input signal, PCM input signal or analog input signal.
No output to Sub Woofer Out.	Sub-woofer = NONE has been selected in SETUP mode.	Select Sub-woofer = YES.
Noise is produced during DTS-encoded CD or laser disc play.	Analog has been selected for input.	Be sure to perform digital connection, select digital input, then play.
A specific channel does not produce output.	Nothing recorded on source.	Check the encoded channel on the source side.
FM or AM reception fails.	Antenna connection is incomplete.	Correctly connect the indoor FM and AM antennas to FM and AM antenna outlets.
Noise is heard during AM reception.	Reception is affected by other electrical fields.	Try changing location where the AM indoor antenna is set up.
Noise is heard during FM reception.	The radio waves from the broadcasting station are weak.	Install an FM outdoor antenna.
Cannot get programmed station when the PRESET button is pressed.	Preset data has been erased.	Disconnecting power plug for long periods of time will erase preset data. If that happens, input the preset data again.
Control with the remote control unit fails.	Batteries are consumed. Remote controller's function-key setting is wrong. The distance between this SR7300 and the remote commander is too far. Something is blocking SR7300 and the remote commander.	Replace all the batteries with new ones. Select different position from which equipment will be controlled. Move closer to this SR7300. Remove offending object.

### GENERAL MALFUNCTION

If the equipment malfunctions, this may be because an electrostatic discharge or AC line interference has corrupted the information in the equipment memory circuits. Therefore:

- disconnect the plug from the AC line supply
- after waiting at least three minutes, reconnect the plug to the AC line supply
- re-attempt to operate the equipment

### HOW TO RESET THE UNIT

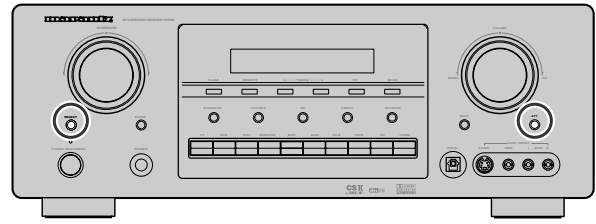

Should the operation or display seem to be abnormal, reset the unit with the following procedure.

The SR7300 is turned on, press and hold the **SELECT** and **ATT** buttons simultaneously for 3 seconds or more.

Remember that the procedure will reset the settings of the function selector, Surround mode, delay time, TUNER PRESET etc., to their initial settings.

#### Memory backup

- In case a power outage occurs or the power cord is accidentally unplugged, the SR7300 is equipped with a backup function to prevent memory data such as the preset memory from being erased.

# TECHNICAL SPECIFICATIONS

## FM TUNER SECTION

Frequency Range ..... 87.5 - 108.0 MHz  
 Usable Sensitivity ..... IHF 1.8  $\mu$ V/16.4 dBf  
 Signal to Noise Ratio ..... Mono/Stereo 76/72 dB  
 Distortion ..... Mono/Stereo 0.2/0.3 %  
 Stereo Separation ..... 1 kHz 45 dB  
 Alternate Channel Selectivity .....  $\pm$  300 kHz 60 dB  
 Image Rejection ..... 98 MHz 70 dB  
 Tuner Output Level ..... 1 kHz,  $\pm$  75 kHz Dev 800 mV

## AM TUNER SECTION

Frequency Range ..... 520 - 1710 kHz  
 Signal to Noise Ratio ..... 50 dB  
 Usable Sensitivity ..... Loop 400 $\mu$ V  
 Distortion ..... 1 kHz, 30 % Mod. 0.5 %  
 Selectivity .....  $\pm$  20 kHz 70 dB

## AUDIO SECTION

Power Output (20 Hz - 20 kHz/THD=0.08%, SR7300)  
 Front L&R ..... 8 ohms 105 W / Ch  
 Center ..... 8 ohms 105 W / Ch  
 Surround L&R ..... 8 ohms 105 W / Ch  
 Surround Back ..... 8 ohms 105 W / Ch

Front L&R ..... 6 ohms 130 W / Ch  
 Center ..... 6 ohms 130 W / Ch  
 Surround L&R ..... 6 ohms 130 W / Ch  
 Surround Back ..... 6 ohms 130 W / Ch

Power Output (20 Hz - 20 kHz/THD=0.08%, SR7300OSE)  
 Front L&R ..... 8 ohms 110 W / Ch  
 Center ..... 8 ohms 110 W / Ch  
 Surround L&R ..... 8 ohms 110 W / Ch  
 Surround Back ..... 8 ohms 110 W / Ch

Front L&R ..... 6 ohms 135 W / Ch  
 Center ..... 6 ohms 135 W / Ch  
 Surround L&R ..... 6 ohms 135 W / Ch  
 Surround Back ..... 6 ohms 135 W / Ch

Input Sensitivity/Impedance ..... 168mV/ 47 Kohms  
 Signal to Noise Ratio(Analog Input / Source Direct) ..... 105 dB  
 Frequency Response (Analog Input / Source Direct)  
 ..... 8 Hz - 100 kHz ( $\pm$  3 dB)  
 (Digital Input / 96 kHz PCM) ... 8 Hz - 45 kHz ( $\pm$  3 dB)

## VIDEO

Television Format ..... NTSC  
 Input Level/Impedance ..... 1 Vp-p/75 ohms  
 Output Level/Impedance ..... 1 Vp-p/75 ohms  
 Video Frequency Response ..... 5 Hz to 8 MHz (- 1 dB)  
 S/N ..... 60 dB

## GENERAL

Power Requirement ..... AC 120 V 60 Hz  
 Power Consumption ..... 480 W  
 Weight (SR7300) ..... 28.9 lbs (13.1 Kg)  
 (SR7300OSE) ..... 32.4 lbs (14.7 Kg)

## ACCESSORIES

Remote Control Unit RC7300SR ..... 1  
 AA-size batteries ..... 2  
 FM Antenna ..... 1  
 AM Loop Antenna ..... 1

Specifications subject to change without prior notice.

# DIMENSION

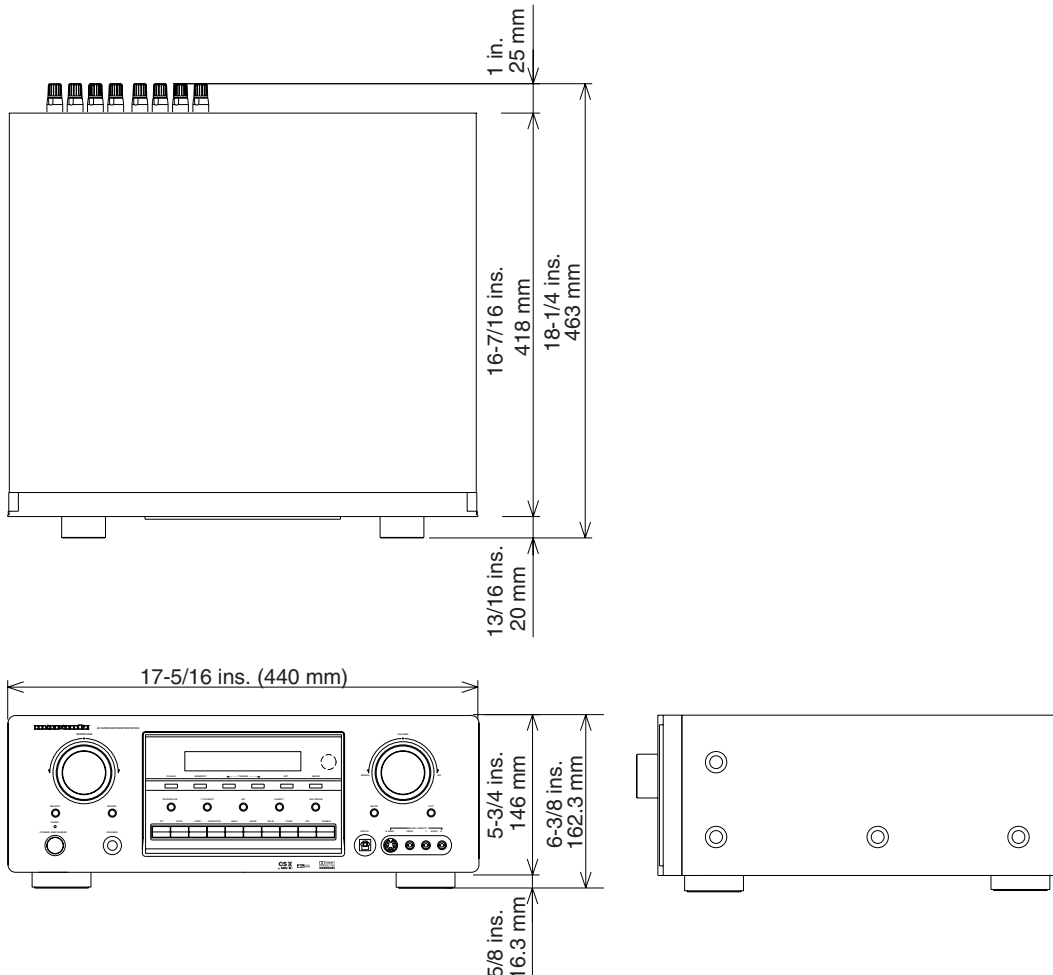

COUNTRY	COMPANY	ADDRESS
ALGERIE	Azur 2000	8, Lotissement Ben Hatadi, Alger, Algerie
ARMENIA	NGYIG Ltd.	47 A/75 St. Lalajants, 375000 Yerevan, Armenia
AUSTRALIA	QualiFi Pty. Ltd.,	P.O. Box 350, Mt. Waverley, VIC 3149, Australia
AUSTRIA	Huber & Prohaska GmbH	Taborstraße 95 / Ladestraße 1, Gebäude Hangartner, A-1200 Wien, Austria
BAHREIN	Ambassador Stores	P.O. Box 237,141, Government Avenue, Manama,Bahrein
BANGLADESH	Target	1078, Ramjoy Mohanja Lane Asadgonj, Chittagong 4000, Bangladesh
BELGIUM	Van der Heyden Audio N.V.	Brusselbaan 278, 9320 Ereembodegem, Belgium
BULGARIA	Ariescommerce GmbH	Makedonia Blvd. 16, 1606 Sofia, Bulgaria
CANADA	Lenbrook Industries Limited	633 Granite Court, Pickering, Ontario
CHINA	Guang Chang Audio International Co., Ltd.	No.38 Yushan Road, ShiQiao, Pan Yu, Guang Dong, China
CYPRUS	Empire Hifi systems Ltd.	P.O. Box 5604, Nicosia, Cyprus
CZECH REPUBLIC	Audio International	Sokolska 41, 67902 Rajecko, OKR,Blansko, Czech Republic
DENMARK	Audio Nord	Dali Allé 1, 9610 Noerager, Denmark
DUBAI	V.V. & SONS	P.O. Box 105, Dubai, U.A.E.
EGYPT	Solimco	9, El Attibaa St. Doki, Cairo, Egypt
ESTONIA	HiFi Club Estonia	Ehte 4, 90503 Haapsalu, Estonia
F.Y.R.O.M.	T.P. KODI	ul.Cedimir Kantargiev 21a, Skopje, Former Yugoslavian Republic of Macedonia
FINLAND	Audio Nord	Uudenmaankatu 4-6, Helsinki SF-00120, Finland
FRANCE	Marantz France	A division of Marantz Europe B.V., P.O. Box 301, 92 156 Suresnes Cedex, France
GERMANY	Marantz Deutschland	Hakenbusch 3, 49078 Osnabrück, Germany
GREECE	Adamco S.A.	188, Hippocratous Street, 11471 Athens, Greece
HEADQUARTERS EUROPE:	Marantz Europe B.V.	P.O. Box 8744, 5605 LS Eindhoven, The Netherlands
HONG KONG	Marantz Hong Kong Ltd.	Unit 1706, Metroplaza II, 223 Hing Fong Road, Kwai Fong, N.T., Kowloon, Hong Kong
HUNGARY	Infovox Ltd.	Terez Krt.31, 1067 Budapest, Hungary
ICELAND	ID Electronics Ltd.	Armula 38, 108 Reykjavik, Iceland
INDIA	NOVA Audio Private	8,Punam Co-op.Society 29/30 Road#5, Union Park MUMBAI 400052, India
IRAN	Home Co.	5th floor no 878 Philips Building Enghelab ave, P.O. 11365/7844 Tehran, Iran
IRELAND	Marantz Ireland	Clonskeagh, Dublin 14, Ireland
ISRAEL	Elmor Ltd.	52 Heh Beiyar Street, Kikar Hamedina, Tel Aviv, Israel
ITALY	Marantz Italy	Via Casati 23, 20052 Monza (Milano), Italy, Servizio Consumatori 1678-20026, Numero Verde
IVORY COAST	Hifivoir	B.P. 2428, Abidjan 01, Ivory Coast
JAPAN	Marantz Japan Inc.	35-1 Sagami Ohno 7-Chome, Sagamihara-shi, Kanagawa 228-8505, Japan
KOREA	MK Enterprises Ltd.	Rm604, Electro-officetel, 16-58. Hangang-ro 3Ga, Yongsan-Ku, Seoul, Korea
KUWAIT	alAlamiah Electronics Intl.	P.O. Box 8196, Salmiah 22052, Kuwait
LATVIA	Aze Ltd.	61, LacPlesa Str., Riga LV 1011, Latvia
LEBANON	AZ Electronics S.A., 1,	P.O. Box 11 2833, Beirut, Lebanon
LITHUANIA	Accapella Ltd.	Ausros, Vartu G/5, Pasazo SKG., 2001 Vilnius, Lithuania
MALAYSIA	Wo Kee Hong Electronics Sdn. Bhd.	2nd Floor Bangnan Infinite Centre, Lot1, Jalan 13/6, 46200 Petaling Jaya, Selangor Datul Ehsan, Malaysia
MALTA	Doneo Co Ltd.	78 The Strand, Sliema SLM07, Malta
MAURITIUS	SKR Electronics Ltd.	P.O. Box 685, Bell Village, Port Louis, Mauritius
MILITARY MARKET EUROPE	PASCO GmbH	PO BOX 1280, Sandhausen 69200, Germany
NEW ZEALAND	Wildash Audio Systems	14 Malvern Road, Mt. Albert, Auckland, New Zealand
NORWAY	Audio Nord	Sandkerveien 64, Oslo 0483, Norway
OMAN	Mustafa & Jawad Trading CO.	P.O. Box 1918, Ruwi, Oman
POLAND	Philips Polska Sp. z.o.o.	Al.Jerozolimskie 195b, 02 222 Warszawa, Poland
PORTUGAL	Corel2	Comércio de Electrónica Lda., Av. Luis Bivar, No 85 A, 1050 Lisboa, Portugal
PROFESSIONAL EUROPE	Marantz U.K. Ltd.	Kingsbridge House, Padbury Oaks, 575-583 Bath Road, Longford, Middlesex UB7 0EH, U.K.
PROFESSIONAL U.S.A.	Marantz America Inc.	1100 Maplewood Drive Itasca, IL 60143, U.S.A.
QATAR	Almana & Partners W.W.L.	P.O. Box 49, Doha, Qatar
REUNION	Vision +	180 Rue du Marechal Leclerc, 97400 Saint Denis, Ile de la Reunion
ROMANIA	Nova Music Entertainment	5, Zagazului Str. Bl.1G,apt.18, sector 1,Bucharest, Romania
RUSSIA	Absolute Audio	7/2, Montazhnaya Street, 107497 Moscow, Russia
SAUDI ARABIA	Adawlia Univ. Electr. Apl	P.O. Box 2154, Alkhobar 31952, Saudi Arabia
SINGAPORE	Wo Kee Hong Distribution PTE Ltd.	130 Joo Seng Road, #03-02 Olivine Building, Singapore 368357
SLOVAKIA	Bis Audio s.r.o.	Nam. SNP 10, 96001 Zvolem, Slovakia
SLOVENIA	Bofex	Smartinska 152, HALA V/3, 61000 Ljubljana, Slovenia
SOUTH AFRICA	Coherent Imports (PTY) Ltd.	P.O. Box 1614, Alberton, 1450, South Africa
SPAIN	Marantz Spain	Martinez Villergas 2, Apartado 2065, Madrid 28027, Spain
SRI LANKA	The listening Room	Mezzanine Floor, The Landmark 385, Galle Road, Colombo - 3, Sri Lanka
SWEDEN	Audio Nord	Almedalsvagen 4, Gotenborg 402-23, Sweden
SWITZERLAND	Sound Company AG	Postfach, 8010 Zürich, Switzerland
SYRIA	Hamzeh & Partners	Hafez Ibrahim Str. No 117, Damascus Shalan, Syria
TAHITI	Covecolor	Av. Prince Hinoi, Cours de l'union sacré, P.O. Box 2334, Papeete, Tahiti
TAIWAN	Pai-Yuing Co. Ltd.	6th No 148 Sung Kiang Road, Taipei 10429, Taiwan R.O.C.
THAILAND	MRZ Standard Co. Ltd.	746-750 Mahachai Road, Wangburapa, Bangkok 10200, Thailand
TUNESIA	Societe EDEVIG	40, Avenue du Golfe Arabe, El Menzah, 1004, Tunesia
TURKEY	Türk Philips Ticaret A.S.	Yukari Dudullu Organize sanayi Bolgesi, 2.Cadde no.28, 81260 Umraniye-Istanbul, Turkey
U.K.	Marantz U.K. Ltd.	Kingsbridge House, Padbury Oaks, 575-583 Bath Road, Longford, Middlesex UB7 0EH, U.K.
U.S.A.	Marantz America Inc.	1100 Maplewood Drive Itasca, IL 60143, U.S.A.
YUGOSLAVIA	ITM Company	Omladinskih Brigada 86, 11070 Belgrade, Yugoslavia

[www.marantz.com](http://www.marantz.com)

Manufactured under license from Dolby Laboratories. "Dolby", "AC-3", "Pro Logic" and the double-D symbol are trademarks of Dolby Laboratories. Confidential Unpublished Works. © 1992-1997 Dolby Laboratories, Inc. All rights reserved.

Manufactured under license from Digital Theater Systems, Inc. US Pat. No. 5,451,942 and other worldwide patents issues and pending. "DTS" and "DTS Digital Surround" are trademarks of Digital Theater Systems, Inc. © 1996 Digital Theater Systems, Inc. All rights reserved.

 HDCCD®, HDCCD®, High Definition Compatible Digital® and Pacific Microsonics™ are either registered trademarks or trademarks of Pacific Microsonics, Inc. in the United States and/or other countries.

HDCCD system manufactured under license from Pacific Microsonics, Inc. This product is covered by one or more of the following: In the USA: 5,479,168, 5,638,074, 5,640,161, 5,808,574, 5,838,274, 5,854,600, 5,864,311, 5,872,531, and in Australia: 669114. Other patents pending.

**marantz**® is a registered trademark.



## Free Manuals Download Website

<http://myh66.com>

<http://usermanuals.us>

<http://www.somanuals.com>

<http://www.4manuals.cc>

<http://www.manual-lib.com>

<http://www.404manual.com>

<http://www.luxmanual.com>

<http://aubethermostatmanual.com>

Golf course search by state

<http://golfingnear.com>

Email search by domain

<http://emailbydomain.com>

Auto manuals search

<http://auto.somanuals.com>

TV manuals search

<http://tv.somanuals.com>