

Nikon

Autofocus Speedlight

SB-28

Instruction Manual

En

Congratulations. You are now the proud owner of the Nikon Autofocus Speedlight SB-28, a flash unit offering sleek new styling and simple push-button operation. When used with Nikon SLR cameras, the SB-28's extensive capabilities range from 3D Multi-Sensor Balanced Fill-Flash, today's most advanced flash technology, to full manual operation.

To get the most out of your new flash unit, please read this manual before use.



WARNING—To avoid injury

- Do not fire the flash directly into a person's eyes at close range as this may damage the retina, leading to partial or complete blindness.
- Avoid touching the front of the flash head while using the SB-28. The flash head generates significant heat during normal operation, which could cause burns.
- Do not expose the SB-28 to water as this may result in electric shock or cause the unit to catch on fire.

Determine which group your camera belongs to.

In this manual, Nikon SLR cameras are divided into seven groups (I to VII) unless otherwise noted. First consult the camera group table to see which group your camera belongs to. Then as you read the manual, you will find specific information on how to use the SB-28 with your particular camera.

Please open the front fold-out page for easy reference.

Camera groups and available flash modes

Group	I	II	III	IV	V	VI	VII*
<div style="display: flex; align-items: center;"> <div style="writing-mode: vertical-rl; transform: rotate(180deg); font-weight: bold; margin-right: 10px;">Flash operation</div> <div> <p>Camera name</p> <p>F5 F100 F90X/N90s¹ F90-Series/ N90¹ F80-Series/ N80-Series^{1,2,3} F70-Series/ N70^{1,2}</p> </div> </div>	<p>F4-Series F65-Series/ N65-Series^{1,3} F-801s/ N8008s¹ F-801/ N8008¹ Pronea 600i/ 6j^{1,3}</p>	<p>F-601/ N6006¹ F-601M/ N6000¹</p>	<p>F60-Series/ N60¹ F50-Series/ N50¹ F-401x/ N5005¹</p>	<p>F-501/ N2020⁴ F-401s/ N4004s¹ F-401/ N4004¹ F-301/ N2000⁴</p>	<p>FM3A FA FE2 FG Nikonos V⁵</p>	<p>F3-Series⁶ New FM2 FM10 FE10</p>	
TTL	<p>3D Multi-Sensor Balanced Fill-Flash⁷</p>	P.26-30					
	<p>Multi-Sensor Balanced Fill-Flash⁷</p>						
	<p>Matrix Balanced Fill-Flash</p>		P.31-32	P.33-34	P.35-37		
	<p>Center-Weighted Fill-Flash/Spot Fill-Flash</p>	P.26-30					
	<p>Programmed TTL Auto Flash</p>					P.38-39	
	<p>Standard TTL Flash</p>	P.26-30	P.31-32	P.33-34			P.40-41
A	<p>Non-TTL Auto Flash</p>				P.42-43		
M	<p>Manual Flash</p>				P.46-51		
	<p>FP High-Speed Flash Sync</p>	P.49-51					
	<p>Repeating Flash</p>				P.52-55		

: Available
 : Not available

¹ Sold exclusively in the USA.

² F80-Series/N80-Series, F70-Series/N70 cannot perform FP High-Speed Flash Sync.

³ Center-Weighted Fill-Flash is not possible.

⁴ Sold exclusively in the USA and Canada.

⁵ An optional sync cord for land use is required.

⁶ Optional flash Unit coupler AS-4 or AS-7 is required. With AS-17, Standard TTL flash (p. 40-41) is possible, but not Repeating flash.

⁷ 3D Multi-Sensor Balanced Fill-Flash and Multi-Sensor Balanced Fill-Flash are generally referred to as Automatic Balanced Fill-Flash with TTL Multi Sensor.

* For cameras such as the Nikon F or Nikon F2, refer to Group VII. TTL Auto Flash mode cannot be performed with cameras in this group. If flash is fired with the indicator appeared on the LCD panel, the flash fires at full output.

For details on the SB-28's available TTL Auto Flash operations, see the separate Quick Reference sheet.

Speedlight parts

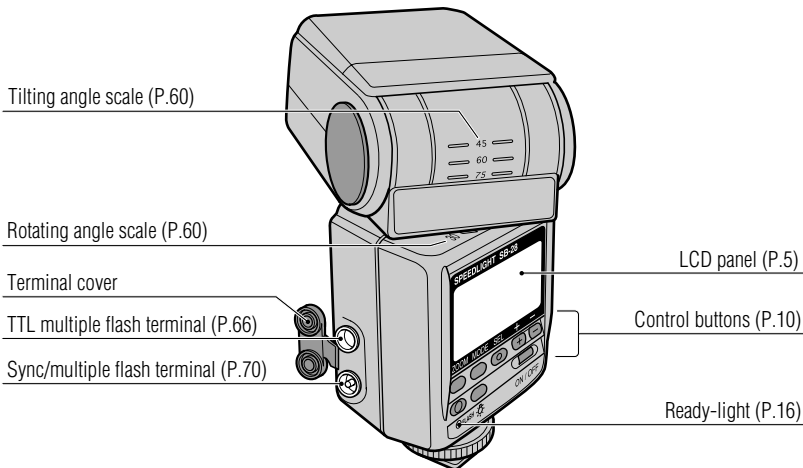
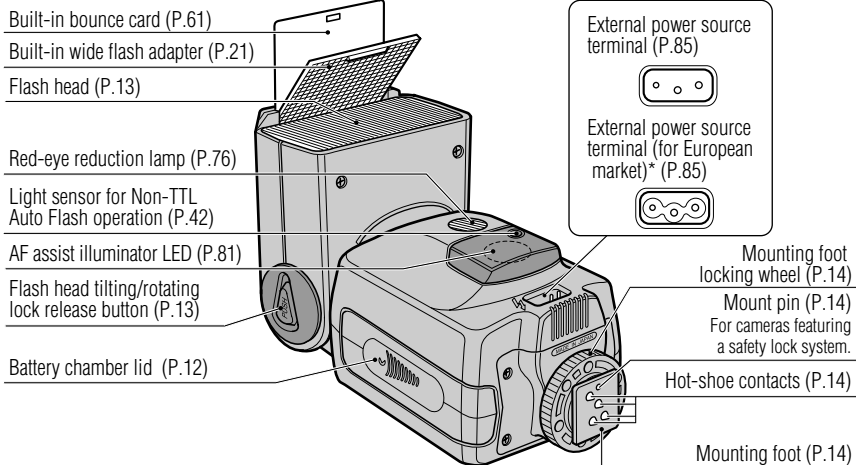

* Because the European version of the SB-28 comes with a different shaped connector, Nikon DC Units SD-7, SD-8 and the Power Bracket Unit SK-6 are not compatible.

LCD panel indications

All LCD (liquid crystal display) figures and marks do not appear at the same time. They are shown together here for ease of explanation.

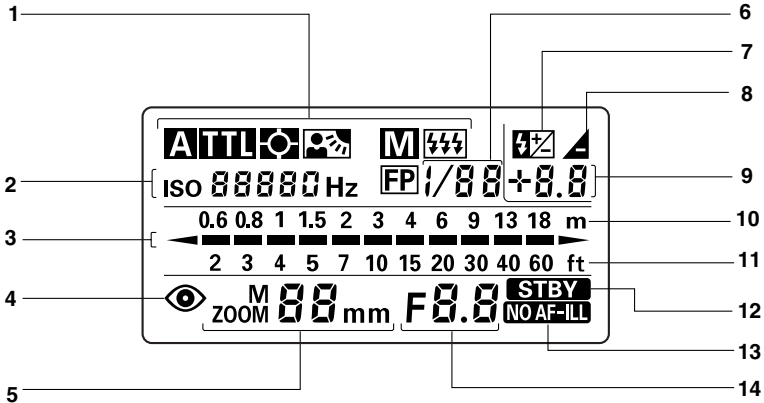

- 1 Flash mode indicator (P.22)
 - ATT Automatic Balanced Fill-Flash with TTL Multi-Sensor
 - TTL Matrix Balanced Fill-Flash, Center-Weighted/Spot Fill-Flash
 - TTL Standard TTL Flash
 - M Manual Flash (P.46)
 - FP High-Speed Flash sync (P.49)
 - Repeating Flash (P.52)
 - A Non-TTL Auto Flash (P.42)
- 2 Film speed (ISO)/number of repeating flashes per frame/frequency indicators (P.18 / P.52)
- 3 Flash shooting range indicator bars (P.13)
- 4 Red-eye reduction indicator (P.76)
- 5 Zoom-head position indicator (P.19)
- 6 Flash output level indicator (P.50)
- 7 Exposure compensation indicator (P.72)
- 8 Underexposure indicator (P.28)
- 9 Exposure compensation/underexposure value (P.72 / P.28)
- 10 Flash shooting distance scale (m: meter) (P.13)
- 11 Flash shooting distance scale (ft: feet) (P.13)
- 12 Standby mode indicator (P.15)
- 13 AF assist illuminator LED canceled indicator (P.82)
- 14 Aperture indicator (P.42)

Notes on LCDs

- Because LCDs are difficult to read when viewed from the side, you should look at the LCD panel directly.
- LCDs are temperature sensitive and may turn black at high temperatures (approx. 60°C or 140°F). They clear up when the temperature returns to normal (20°C or 68°F).
- In cold temperatures (approx. 5°C or 41°F and below), the LCDs' response time slows down. This is typical of LCDs and no cause for concern. LCDs will function properly once the temperature returns to normal (20°C or 68°F).

NOTE

Using the SB-28 in dim light

Press the  button to turn the illuminator on. Press the button again to turn it off. The illuminator turns off automatically after approx. 16 sec. when the SB-28 is not in use.

Tips on using this manual

Take some test shots.

Before taking important flash photographs, take some test shots to ascertain the SB-28 is working as desired in the mode(s) you have selected.

Use only Nikon-approved equipment.

The SB-28 is designed for use with Nikon cameras, lenses, and accessories.

- Using cameras or accessories other than those specified by Nikon may damage the SB-28.
- Nikon cannot be held responsible for malfunctions caused by using the SB-28 in ways not specified in this manual, or using the SB-28 with a camera made by another manufacturer.

About this manual

- This instruction manual consists of the main manual plus a separate Quick Reference sheet. The Quick Reference sheet provides an overview of the SB-28's capabilities and features, while the main manual supplies detailed information on all aspects of the SB-28.
- Because explanations in this manual are based on the operation of the SB-28 only, please consult the instruction manual provided with your camera for specific information on its use.

Notices used in this manual



Denotes important points where caution is required.

NOTE Denotes a useful point that should be remembered for future reference.

Determine what type of Nikkor lenses you are using.

Nikkor lenses are divided into two groups unless otherwise noted.

Nikkor lenses with a built-in CPU*	<ul style="list-style-type: none">• D- or G-type Nikkor lenses• IX Nikkor lenses**• Non-D/G-type AF Nikkor lenses***• AI-P-type Nikkor lenses
Nikkor lenses without a built-in CPU*	<ul style="list-style-type: none">• AI-S-type or AI-type Nikkor lenses• Nikon Series E lenses• AI-modified Nikkor lenses and others

* CPU (Central Processing Unit) acts as an on-board computer.

** IX Nikkor lenses are designed for use with the Nikon Advanced Photo System (IX240) format SLR camera body only and cannot be used with 35mm SLR cameras.

***Except AF Nikkor lenses for the F3AF

Contents

Foreword	2
Camera groups and available flash modes	3
Speedlight parts	4
LCD panel indications	5
Tips on using this manual	6
About this manual	7
Using control buttons	10
Getting started	11
Loading batteries	12
Adjusting the flash head / Selecting the distance scale	13
Attaching the SB-28 to the camera	14
Turning the SB-28 on and off / Standby function	15
The ready-light	16
Test firing	17
Setting the ISO film speed	18
Adjusting the zoom-head position	19-20
Setting the built-in wide flash adapter	21
Selecting a flash mode	22
Basic operation	23
III flash modes	24-25
TTL Auto Flash III Mode (For cameras in Group I)	26-30
TTL Auto Flash III Mode (For cameras in Group II)	31-32
TTL Auto Flash III Mode (For cameras in Group III)	33-34
TTL Auto Flash III Mode (For cameras in Group IV)	35-37
TTL Auto Flash III Mode (For cameras in Group V)	38-39
TTL Auto Flash III Mode (For cameras in Group VI)	40-41
Non-TTL Auto Flash A Mode (For cameras in all groups)	42-43

Advanced operation	45
Manual Flash M Mode (For cameras in all groups)	46-51
Repeating Flash RR Mode	52-55
Guide Numbers for determining correct aperture in M and RR flash modes	56-57
Bounce flash operation	58-61
Close-up flash operation in TTL Auto Flash III Mode	62-64
Multiple flash operation in III and M flash modes	65-70
Exposure compensation in flash photography (For cameras in all groups)	71-75
Red-eye reduction control (For cameras in Group I [except F5] and Pronea 600i/6i)	76
Rear-curtain flash sync	77-78
 Additional information	 79
Checking the correct exposure (For cameras in all groups)	80
Autofocus flash operation in dim light (For autofocus cameras only)	81-82
Optional accessories	83-85
Tips on Speedlight care	86
Notes on batteries	87-88
Troubleshooting	89-90
Specifications	91-95

Using control buttons

By pressing a single button, you can activate frequently used functions. When two buttons are pressed simultaneously, you can activate functions which are not necessary to set each time. For easy reference, refer to the chart on the back of the built-in bounce card.

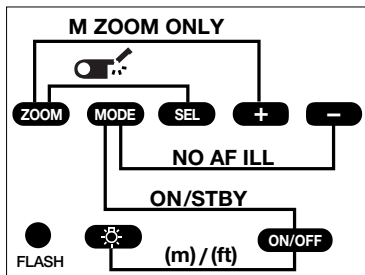
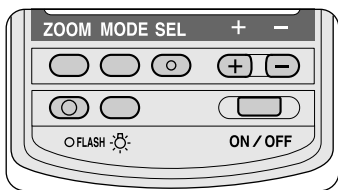

One-button operations

- ZOOM** To adjust the zoom-head position (P.19-20)
- MODE** To set the flash mode (P.22)
- SEL** To select and set various functions and values
 - +** To increase values
 - To decrease values
- FLASH** To test fire the flash (P.17)
- ☀** To illuminate the LCD panel (P.5)
- ON/OFF** To turn power on and off (P.15)

Two-button operations

- ZOOM** + **+** To set or cancel automatic zoom-head adjustment (Buttons must be pressed for 2 sec.) (P.19-20)
- ZOOM** + **SEL** To readjust the zoom-head position, if built-in wide flash adapter is broken off accidentally (P.21)
- MODE** + **-** To turn the AF assist illuminator LED on or off (P.81-82)
- MODE** + **ON/OFF** To cancel or set the standby function (Buttons must be pushed after the flash is turned off.) (P.15)
- ☀** + **ON/OFF** To select the distance scale (meters or feet) (P.13)
(Buttons must be pushed after the flash is turned off.)

Getting started

Becoming familiar with the SB-28

Before starting to take flash pictures, you should familiarize yourself with various settings and adjustments of the SB-28, regardless of which Nikon SLR camera you are using.



Loading batteries

Four penlight batteries (1.5V or lower) of any of the following types may be used:

- AA-type alkaline-manganese (1.5V)
- AA-type lithium (1.5V)
- AA-type NiCd (rechargeable) (1.2V)
- AA-type Ni-MH (Nickel Metal Hydride) (rechargeable) (1.2V)

NOTE : AA-type high-power manganese batteries are not recommended for use with the SB-28.

—See pages 87-88, Notes on batteries.

1 Open the battery chamber lid.

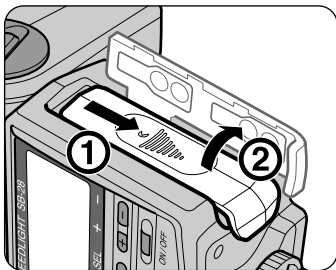

2 Install four penlight batteries following the + and – symbols inside the chamber. Close the battery chamber lid.

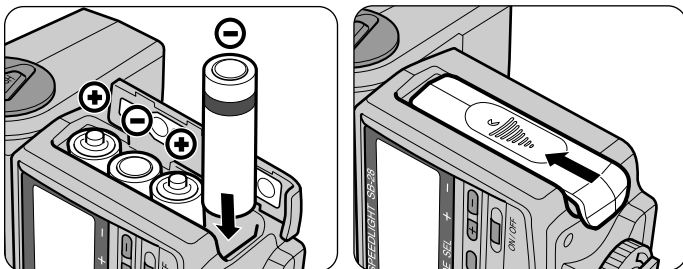

- Various optional external power source DC Units are available for use with the SB-28. See page 85, Using an external power source.



Do not mix battery types or brands, or use old with new batteries.

Adjusting the flash head / Selecting the distance scale

Adjusting the flash head

Hold down the flash head tilting/rotating lock release button while adjusting the flash head to the horizontal/front position.

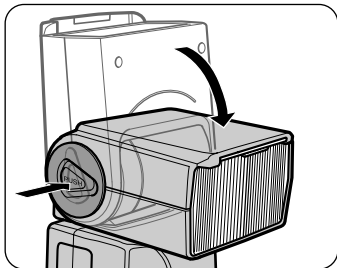

- When the **ON/OFF** button is pressed for approx. 0.5 sec. after adjusting the flash head to the horizontal/front position, the power turns on and the flash shooting range indicator bars -- appear on the LCD panel. They do not appear if the flash head is adjusted to a position other than the horizontal/front position.
- The indicator bars -- blink when the flash head is tilted down to -7° .

Selecting the distance scale (meters/feet)

Set the distance scale on the LCD panel to either meters (m) or feet (ft).

- 1 Press the **ON/OFF** button for approx. 0.5 sec. to turn the SB-28 off.
- 2 Hold down the  button as you press the **ON/OFF** button.
—To return to the former setting, repeat steps 1 and 2.

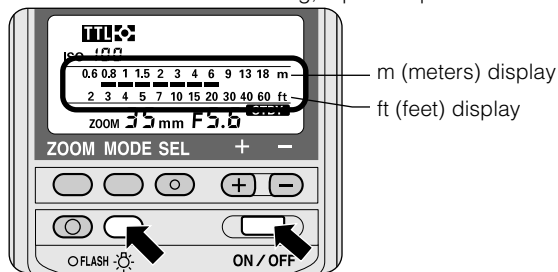

- The SB-28 is preset to meters (m) when the SB-28 is shipped from the factory.

NOTE

Although meters (m) and feet (ft) appear together in this manual for ease of explanation, they do not appear simultaneously on the SB-28's LCD panel.

Attaching the SB-28 to the camera

When attaching the SB-28 to your camera, make sure both units are turned off to avoid accidentally firing the flash.

- 1 Loosen the SB-28's mounting foot locking wheel and slide the SB-28 into the camera's accessory shoe.

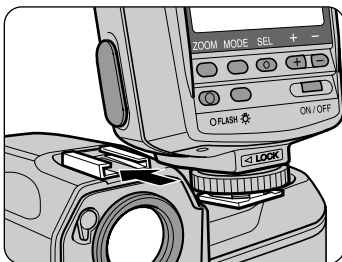
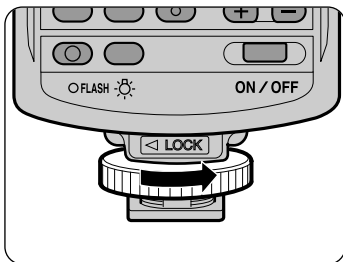

- 2 Tighten the locking wheel.

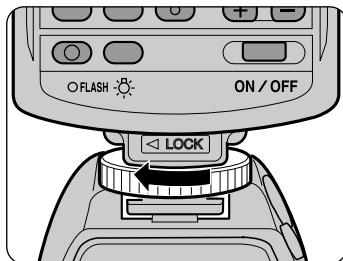

With cameras equipped with a safety lock system, the mount pin is automatically inserted into the locking hole in the camera's accessory shoe to secure the SB-28.

Detaching the SB-28

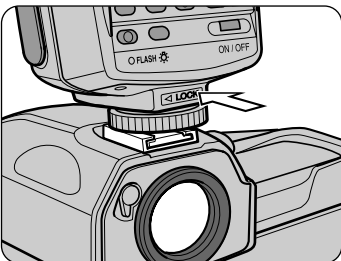
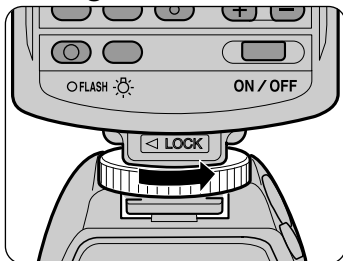

- To detach the SB-28, loosen the mounting foot locking wheel all the way. If the wheel doesn't loosen easily, push the foot forward gently in the direction of the white arrow and try loosening the wheel again.

Turning the SB-28 on and off / Standby function

Turning power on and off

To turn the SB-28 on and off, depress and hold the **ON/OFF** button for approx. 0.5 sec.

Standby function

If both the SB-28 and camera are not used for after approx. 80 seconds, the SB-28 shuts off automatically to conserve battery power. This is called the standby function.

Canceling and setting the standby function

- 1 Press the **ON/OFF** button for approx. 0.5 sec. to turn the SB-28 off.
- 2 Hold down the **MODE** button as you press the **ON/OFF** button.
—The SB-28's standby mode indicator **STBY** on the LCD panel appears when the function is set and disappears when it is not set. Perform steps 1 and 2 to cancel it or reset it.

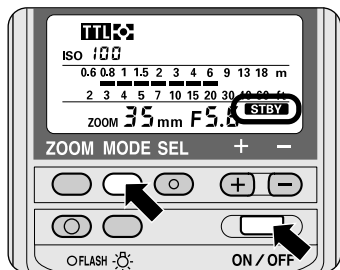

- The standby function is preset when the SB-28 is shipped from the factory. (Check that the standby mode indicator **STBY** appears on the LCD panel when the SB-28 is turned on.)



When carrying the SB-28 in your camera bag with the standby function set, make sure to turn off the flash unit to avoid accidental battery drain.

To turn the SB-28 on again after it enters the standby mode, you can:

- Lightly press the shutter release button (except cameras in Group VII).
- Press the **FLASH** button on the SB-28.
- Press the SB-28's **ON/OFF** button.

The ready-light

After the SB-28 is turned on, the ready-light lights up as soon as the SB-28 is recycled and ready to fire.

—Make sure the ready-light lights up before taking the picture.

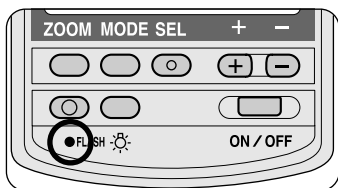

The ready-light blinks when the flash fires at maximum output.

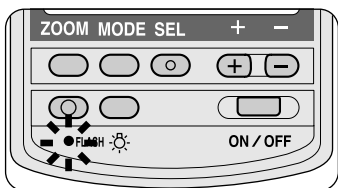

In TTL Auto Flash **[III]** or Non-TTL Auto Flash **[A]** mode, if the ready-lights on the SB-28 and inside the camera's viewfinder blink for approx. 3 seconds after the picture is taken, the flash has fired at its maximum output, indicating that light may have been insufficient for correct exposure.

- In that case, use a wider aperture or move closer to the subject before taking any more pictures.



Replace batteries.

- Replace alkaline-manganese batteries if the ready-light takes more than 30 seconds to light up. Replace lithium batteries if the ready-light takes more than 10 seconds to light up. See page 87-88, Notes on batteries.
- Recharge NiCd or Ni-MH batteries if the ready-light takes more than 10 seconds to come on.
- When exhausted batteries are used in the SB-28, the zoom-head position adjustment may be activated repeatedly, producing sound inside the unit, even when the power is turned off.

Test firing

You can perform simple test firing by pressing the **(FLASH)** button to ensure that the SB-28 is working properly.

- 1 Press the **(ON/OFF)** button to turn the SB-28 on.
- 2 After the ready-light comes on, press the **(FLASH)** button to fire the SB-28.

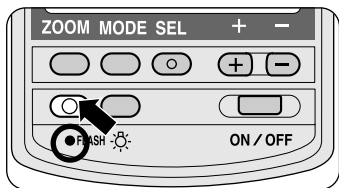

NOTE

If the SB-28 enters the standby mode, press the **(FLASH)** button once to turn the flash back on, then press the **(FLASH)** button again to test-fire the unit.

Setting the ISO film speed

Cameras in Groups I and II

The ISO film speed is automatically set and indicated on the SB-28's LCD panel.

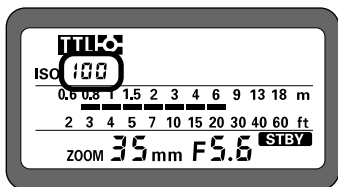

- The usable film speed in TTL Auto Flash **TTL** mode is ISO 25 to 1000.

Cameras in Groups III through VII

Set the ISO film speed manually in this manner:

- 1 Turn the SB-28 off.
- 2 Turn it on again. The film speed starts blinking.
- 3 Press the **+** or **-** button to increase or decrease the film speed.
—Press the **SEL** button to stop the film speed from blinking.

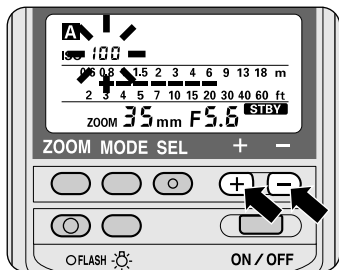

- The film speed indicator blinks during adjustment and stops after 8 seconds unless the **SEL** button is pressed. The last blinking number is the one automatically set.
- The following ISO film speeds can be used in TTL Auto Flash **TTL** mode:
ISO 25 to 1000 for cameras in Groups III and IV, plus F-501/N2020 and F-301/N2000 cameras.
ISO 25 to ISO 400 for cameras in Group VI, plus F-401s/N4004s and F-401/N4004 cameras.

Adjusting the zoom-head position

The SB-28 has six zoom-head position settings: 24mm, 28mm, 35mm, 50mm, 70mm and 85mm. (The zoom head is set to either 18mm or 20mm when the built-in wide flash adapter is used.)

Cameras in Groups I and II with Nikkor lenses with a built-in CPU

1 The zoom head is automatically adjusted.

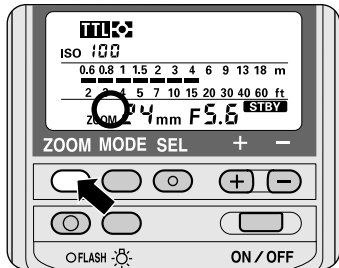

- Automatic zoom-head positioning is not possible if a small M appears above the ZOOM on the LCD panel. Press the **ZOOM** button several times until the M disappears.

2 After automatic adjustment, make sure the zoom-head position on the LCD panel matches the focal length of the lens in use.
—With a zoom lens, the zoom head automatically adjusts within the range of 24mm to 85mm. When the focal length exceeds the SB-28's available range, the zoom-head adjusts to the closest wideangle or telephoto setting of the lens in use.

Adjusting the zoom-head position

NOTE

To cancel automatic zoom-head positioning and set the position manually:

- 1 Press the **ZOOM** and **(+)** buttons simultaneously for approx. 2 sec. until the small **M** above **ZOOM** starts blinking. Then press the **ZOOM** button and set the desired zoom-head position manually.
- 2 The zoom-head position indicator changes every time you press the **ZOOM** button:
24mm → 28mm → 35mm → 50mm → 70mm → 85mm
Once set manually, the zoom-head position is locked and does not change even when the power is turned off and on again or the lens is changed.
—To resume automatic zoom-head position adjustment, press the **ZOOM** and **(+)** buttons simultaneously for approx. 2 sec. until the small **M** above **ZOOM** disappears.

Other camera/lens combinations

Press the **ZOOM** button and adjust the zoom-head position manually to match the focal length of the lens in use.

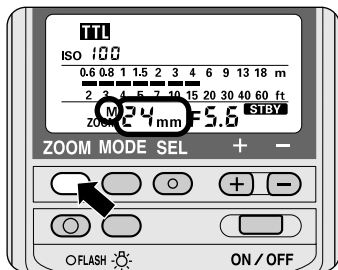

- The indicator changes each time you press the **ZOOM** button:
24mm → 28mm → 35mm → 50mm → 70mm → 85mm
When set manually, a small **M** appears above the **ZOOM** on the LCD panel.
—When using a Zoom-Nikkor lens, set the zoom-head position on the SB-28 to correspond to the shortest focal length of the lens (for example, select the 28mm setting when using a Zoom-Nikkor 28-85mm lens). Then, the flash will cover all the focal lengths.

Setting the built-in wide flash adapter

The SB-28 comes with a wide flash adapter to increase the angle of coverage to match an 18mm or 20mm lens.

- 1 Slide out the wide flash adapter ① and gently push it down into place in front of the flash head ②.

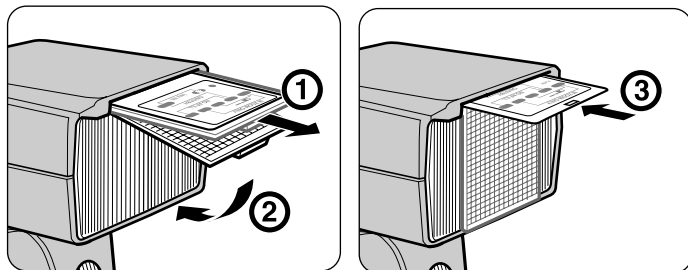

- Because the bounce card comes out at the same time, return it ③ to its original position inside the flash head.
- The zoom-head position indicator changes to 20mm and the indicator bars -- display the appropriate flash shooting distance range.

- 2 To change to 18mm, press the **(ZOOM)** button once.
—The zoom-head position indicator toggles between 18mm and 20mm each time you press the **(ZOOM)** button.

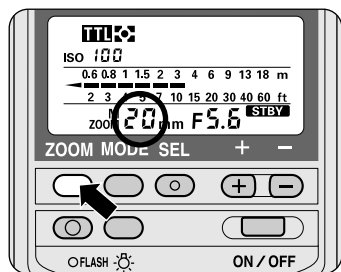

- To replace the wide flash adapter, lift it up and slide it back into its original place inside the flash head.

If the built-in wide flash adapter is broken off accidentally, it is no longer possible to set 18 or 20mm.

In this case, press the **(ZOOM)** and **(SEL)** buttons simultaneously for approx. 4 sec. until the zoom-head position indicator starts blinking, making it possible to adjust the zoom-head automatically or manually to its six basic settings (24, 28, 35, 50, 70, 85mm).

Selecting a flash mode

When the **(MODE)** button on the back of the SB-28 is pressed, the flash mode indicator sequences through these modes:



Note that the LCD indications and available flash modes differ depending on which Nikon camera and lens you are using.

The table below shows the auto flash mode recommended for use with each camera group.

—Refer to the reference pages corresponding to your camera.

Camera group	Recommended auto flash mode	Reference page
I	Automatic Balanced Fill-Flash with TTL Multi Sensor	26–30
II	Matrix Balanced Fill-Flash	31–32
III	Matrix Balanced Fill-Flash	33–34
IV	Matrix Balanced Fill-Flash	35–37
V	Programmed TTL Auto Flash	38–39
VI	Standard TTL Flash	40–41
VII	Non-TTL Auto Flash A	42–43

- For available flash operations with the SB-28 and each camera group, refer to the table on the fold-out page at the front of this manual.

Basic operation

Shooting in the auto flash mode

*The SB-28 provides a variety of flash modes to cover virtually all shooting situations. These modes range from TTL Auto Flash **III** to Non-TTL Auto Flash **A** and Manual Flash **M**. In this section, TTL and Non-TTL Auto Flash modes are explained.*



TTL Auto Flash **III :**

If your camera is in group I to VI, refer to pages 24-25, **III** flash modes, to get the most out of TTL automatic flash operations.

Non-TTL Auto Flash **A :**

If your camera is in Group VII with no TTL Auto Flash **III** mode available, refer to pages 42-43, Non-TTL Auto Flash **A** mode. This mode can also be used with cameras in all groups.

Six flash operations are possible in the TTL Auto Flash mode:

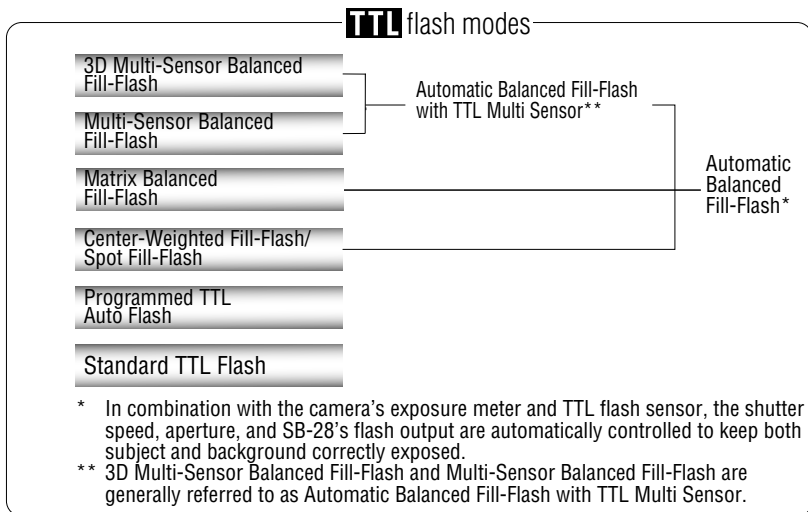

3D Multi-Sensor Balanced Fill-Flash

(Applicable to F5, F100, F90X/N90s, F90-Series/N90, F80-Series/N80-Series, F70-Series/N70)

This mode automatically controls flash output to keep both subject and background correctly exposed. The SB-28 fires a series of nearly invisible preflashes, called Monitor Preflash. These preflashes are detected by the TTL multi-sensor in Group I cameras and the data is then integrated with distance information from D-type Nikkor lenses and other exposure data to determine the optimal flash shooting distance range and flash output level for balanced fill-flash exposure. This is especially effective for scenes that include: (1) a mirror, white wall or other highly reflective surface or (2) unwanted obstacles in front of the subject.

Multi-Sensor Balanced Fill-Flash

(Applicable to F5, F100, F90X/N90s, F90-Series/N90, F80-Series/N80-Series, F70-Series/N70)

This mode automatically controls flash output to keep both subject and background correctly exposed when non-D-type AF or AI-P-type Nikkor lenses are used. The SB-28 fires a series of nearly invisible Monitor Preflashes, which are detected by the TTL multi-sensor to help determine the best exposure for both subject and background. This method is most effective for scenes that include: (1) a mirror, white wall, or other surface highly reflective surface, or (2) a subject positioned against a distant and/or plain background, such as an empty sky, clouds, etc.

Matrix Balanced Fill Flash

(Applicable to F4-Series, F65-Series/N65-Series, F60-Series/N60, F50-Series/N50, F-801s/N8008s, F-801/N8008, F-601/N6006, F-601_m/N6000, F-401x/N5005, Pronea 600i/6i)

This mode automatically controls flash output to keep both subject and background correctly exposed when D or non-D-type AF Nikkor lenses are used. The camera's Matrix Metering System determines the correct exposure based on the ambient light. Flash illumination brightens the main foreground subject but does not overpower the background.

Center-Weighted/Spot Fill-Flash

(Applicable to F5, F4-Series, F100, F90X/N90s, F90-Series/N90, F70-Series/N70, F60-Series/N60, F50-Series/N50, F-801s/N8008s, F-801/N8008, F-601/N6006, F-601_m/N6000, F-401x/N5005)

This mode operates with Center-Weighted or Spot metering. Center-weighted fill-flash measures the entire scene, but places emphasis on the center area. Spot fill-flash reads a narrower central area or spot. Not all Nikon AF cameras provide spot fill-flash.

Programmed TTL Auto Flash

(Applicable to F-501/N2020, F-401s/N4004s, F-401/N4004, F-301/N2000)

In this mode, you can perform auto flash operation with the lens set to its minimum aperture (highest f-number). The camera automatically controls the aperture according to the ISO film speed.

Standard TTL Flash



(Applicable to F5, F4-Series, F100, F90X/N90s, F90-Series/N90, F80-Series/N80-Series, F70-Series/N70, F65-Series/N65-Series, F-801s/N8008s, F-801/N8008, F-601/N6006, F-601_m/N6000, F-501/N2020, F-401s/N4004s, F-401/N4004, F-301/N2000, FM3_A, FA, FE2, FG, Pronea 600i/6i, Nikonos V)

You manually select a flash output level so that the main subject is correctly exposed regardless of the background brightness. This system is not designed to automatically provide a balance between flash and ambient light; it is limited to efficient operation in dim-light conditions and is not recommended for use in very bright lighting conditions. This system does not directly link the camera's light meter and the SB-28's TTL sensor.

TTL Auto Flash Mode

For cameras in Group I: F5, F100, F90X/N90s, F90-Series/N90, F80-Series/N80-Series, F70-Series/N70

Available flash operation in TTL Auto Flash Mode

Lens in use	Available flash operation* ¹	Camera's exposure mode	Camera's metering system* ²
D- or G-type* ³ Nikkor lenses	3D Multi-Sensor Balanced Fill-Flash 	Desired mode	Desired metering system
Non-D/G-type AF Nikkor lenses/ AI-P lenses	Multi-Sensor Balanced Fill-Flash 	Desired mode	Desired metering system
Other Nikkor lenses* ⁴	Center-Weighted Fill-Flash/Spot Fill- Flash 	Aperture-priority auto (A) Manual (M)	Center-Weighted Metering ----- Spot Metering* ²

*¹ All of the above flash modes can be changed to Standard TTL Flash .

*² Only Standard TTL Flash is possible when the F5's, F100's or F80-Series/N80-Series' Metering System is set to Spot Metering.

*³ With a G-type Nikkor lens attached to F90X/N90s, F90-Series/N90, F70-Series/N70 cameras, the A and M exposure modes cannot be used.

*⁴ With a non-CPU Nikkor lens attached to F80-Series/N80-Series cameras, Standard TTL Flash can be performed. (Can only be used with exposure mode set to Manual) The camera's exposure meter cannot be used. Set and confirm the aperture using the lens aperture ring.

Monitor Preflash will not operate:

- If the flash head is tilted up or rotated from the horizontal/front position.
- When the camera's flash sync mode is set to rear-curtain sync.
- When TTL Auto Flash (not 3D Multi-Sensor Balanced Fill-Flash or Multi-Sensor Balanced Fill-Flash) mode is selected. (In this case no  indicator appears.)
- When a Nikkor lens without a built-in CPU is used.

Camera settings

1 Set the aperture.

—The method for setting the aperture differs, depending on the lens in use and the selected exposure mode. (See page 29, Confirming flash shooting distance range in TTL Auto Flash  Mode.)

2 Set the flash sync mode.

—Set the camera's flash sync mode (if available) to front-curtain sync (Normal).

Flash settings

3 Select the flash mode.

—Press the **(MODE)** button until the desired auto flash mode appears on the LCD panel.

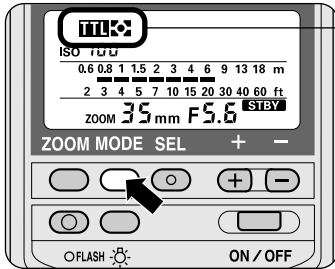

Automatic Balanced Fill-Flash with TTL Multi-Sensor



Center-Weighted/Spot Fill-Flash



Standard TTL Flash

4 Check the shooting distance.

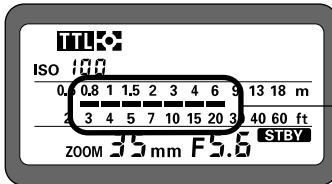

A flash shooting distance range of 0.8 to 6m (2.6 to 20 ft) is shown.

- With the F5 camera's Custom Setting, you can select 1/300 TTL High-Speed Sync. In this case, you cannot confirm the shooting distance using the indicator bars -- on the SB-28's LCD panel. (See page 30 on Flash shooting distance range in 1/300 TTL High-Speed Flash sync operation.)

5 Wait for the ready-light to come on and make sure the subject is in focus before taking the picture.

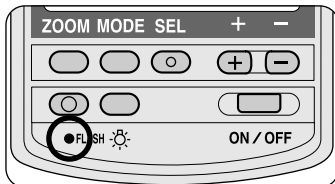

TTL Auto Flash Mode

For cameras in Group I: F5, F100, F90X/N90s, F90-Series/N90, F80-Series/N80-Series, F70-Series/N70

The ready-light blinks when the flash fires at maximum output.

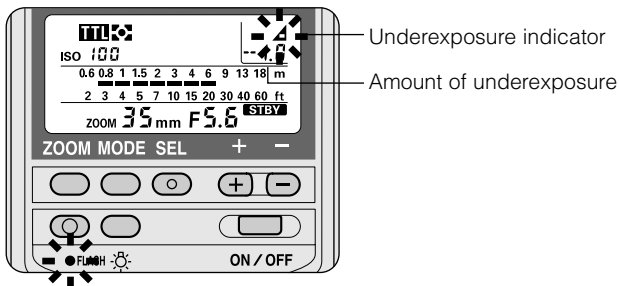

- If the SB-28's ready-light and the underexposure indicator blink for approx. 3 seconds after shooting, the flash has fired at its maximum output, indicating the light was insufficient for correct exposure. The amount of underexposure (for example, -1.0 to -3.0) also appears on the SB-28's LCD panel. To compensate, use a wider aperture or move closer to the subject and reshoot.
- You can recall the amount of underexposure last shown on the LCD panel by pressing the  button.

Confirming the flash shooting distance range in TTL Auto Flash Mode

Applicable to cameras in Groups I and II

The method for confirming the shooting distance differs, depending on the lens in use and the selected exposure mode. Check the flash shooting distance range as described below.

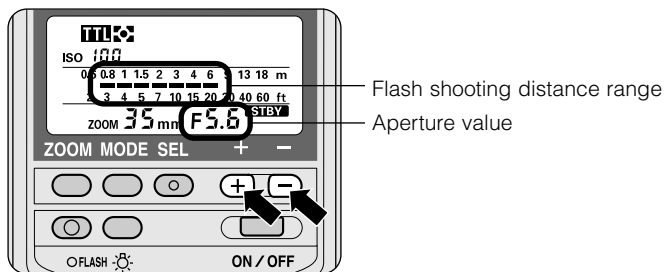

Nikkor lenses with a built-in CPU

• In Programmed auto (P, Ps) or Shutter-priority auto (S) mode:



- (1) Set the lens to its minimum aperture (highest f-number) (except G-type Nikkor lenses).
- (2) Press the shutter release button halfway and check the shooting distance range on the SB-28's LCD panel.

• In Aperture-priority auto (A) or Manual (M) mode:

Check the indicator bars -- and the subject's distance as you rotate the camera's command dial or lens aperture ring to determine the aperture value.

Nikkor lenses without a built-in CPU

• In Aperture-priority auto (A) or Manual (M) mode only:

- (1) While looking at the indicator bars --, press the  or  button to change the aperture and bring the subject within the flash shooting distance range.
- (2) Note the aperture and set it on the lens.

Flash shooting distance range in 1/300 TTL High-Speed Flash sync operation (F5 only)

In combination with the F5 camera, 1/300 High-Speed Flash Sync (with Custom Setting; 1/250 sec. at normal setting) is possible. But the farthest flash shooting distance cannot be read from the indicator bars -- on the SB-28 in TTL Auto Flash  Mode.

In this case, use the guide number table and equation for calculating this distance according to each zoom-head position.

Guide number (at ISO 100 for m/ft)

Zoom head position	18mm	20mm	24mm	28mm	35mm	50mm	70mm	85mm
Guide number	8/26	8/26	11/36	12/39	14/46	16/53	18/59	19/62

$$D \text{ (farthest flash shooting distance)} = \frac{\text{Guide number}}{f/\text{stop (aperture)}}$$

For example, when shooting with ISO 100 film, at a 35mm zoom-head position and an aperture of f/5.6:

$$D = 14/5.6 = 2.5 \text{ (measured in meters)}$$

$$D = 46/5.6 = 8.2 \text{ (measured in feet)}$$

The farthest flash shooting distance is 2.5m (8.2ft). You can read the closest shooting distance from the SB-28's indicator bars --.



- For film speeds other than ISO 100, multiply the figures in the table above by the factors shown below.

ISO film speed	25	50	200	400	800
Factor	x 0.5	x 0.71	x 1.4	x 2	x 2.8

TTL Auto Flash Mode

For cameras in Group II: F4-Series, F65-Series/N65-Series, F-801s/N8008s, F-801/N8008, Pronea 600i/6i

Available flash operation in TTL Auto Flash Mode

Lens in use*1	Available flash operation*2	Camera's exposure mode	Camera's metering system*3
Nikkor lenses with a built-in CPU*4	Matrix Balanced Fill-Flash 	Desired mode*5	Matrix Metering
	Center-Weighted Fill-Flash/ Spot Fill-Flash*6 	Desired mode	Center-Weighted Metering ----- Spot Metering*3
Nikkor lenses without a built-in CPU*7	Center-Weighted Fill-Flash/Spot Fill-Flash*6 	Aperture-priority auto (A)	Center-Weighted Metering
		Manual (M)	----- Spot Metering*3

*1 Matrix Balanced Fill-Flash operation is possible with F4-Series camera when AI-S or AI-type Nikkor lenses, Nikon Series E lenses, and lenses for the F3AF are used.

*2 The above flash modes can be changed to Standard TTL Flash .

*3 Only Standard TTL Flash can be performed when the F4's Metering System is set to Spot Metering.

*4 With a G-type Nikkor lens attached to F4-Series, F-801s/N8008s, F-801/N8008 cameras, the A and M exposure modes cannot be used.

*5 With F65-Series/N65-Series and Pronea 600i/6i cameras, only Standard TTL Flash can be performed when the camera's exposure mode is set to Manual (M).

*6 Center-Weighted Fill-Flash/Spot Fill-Flash is not possible with the F65-Series/N65-Series, Pronea 600i/6i cameras.

*7 With a non-CPU Nikkor lens attached to F65-Series/N65-Series or Pronea 600i/6i cameras, Standard TTL Flash can be performed. (Can only be used with exposure mode set to Manual) The camera's exposure meter cannot be used. Set and confirm the aperture using the lens aperture ring.

Camera settings

1 Set the aperture.

—The method for setting the aperture differs, depending on the lens in use and the selected exposure mode. (See page 29 on Confirming flash shooting distance range in TTL Auto Flash  Mode.)

2 Set the flash sync mode.

—Set the camera's flash sync mode (if available) to front-curtain sync (Normal).

TTL Auto Flash **TTL** Mode

For cameras in Group II: F4-Series, F-801s/N8008s, F-801/ N8008, Pronea 600i/6i

Flash settings

3 Select the flash mode.

—Press the **(MODE)** button until the desired auto flash mode indicator appears on the LCD panel:

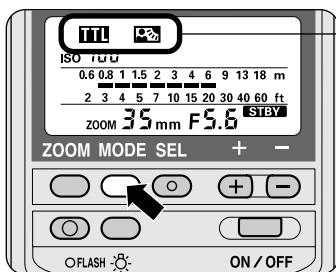

TTL Matrix Balanced Fill Flash and Center-Weighted Fill Flash/Spot Fill-Flash

TTL Standard TTL Flash

4 Check the shooting distance.

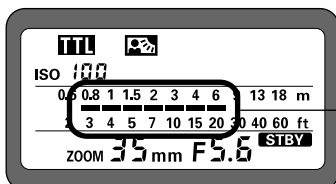

A flash shooting distance range of 0.8 to 6m (2.6 to 20 ft) is shown.

5 Wait for the ready-light to come on and make sure the subject is in focus before taking the picture.

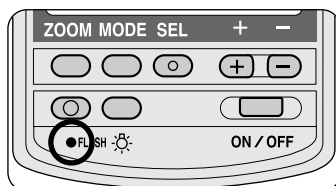



- If the ready-light blinks for approx. 3 seconds after shooting, this indicates the light may have been insufficient for correct exposure. In this case, use a wider aperture or move closer to the subject.

TTL Auto Flash Mode

For cameras in Group III: F-601/N6006, F-601M/N6000

Available flash operation in TTL Auto Flash Mode

Use the camera's MODE button to select the flash mode.

Lens in use	Available flash operation	Camera's exposure mode	Camera's metering system
Nikkor lenses with a built-in CPU*1	Matrix Balanced Fill-Flash 	Desired mode	Matrix Metering
	Center-Weighted Fill-Flash/Spot Fill-Flash 	Desired mode	Center-Weighted Metering, ----- Spot Metering*2
Nikkor lenses without a built-in CPU	Center-Weighted Fill-Flash/Spot Fill-Flash 	Aperture-priority auto (A), Manual (M)	Center-Weighted Metering, ----- Spot Metering*2



*1 G-type Nikkor lenses cannot be used with an F-601/N6006 camera. With a G-type Nikkor lens attached to an F-601M/N6000 camera, the A and M exposure modes cannot be used.

*2 Spot Metering is not possible with the F-601M/N6000.



Camera settings

1 Set the aperture.

Nikkor lenses with a built-in CPU

- In Programmed auto (P, P_M) or Shutter-priority auto (S) mode:
—Set the lens to its minimum aperture (highest f-number) (except G-type Nikkor lenses).
- In Aperture-priority auto (A) or Manual (M) mode:
—While looking at the indicator bars --, press the  or  button to change the aperture and bring the subject within the flash shooting distance range. Then set the same aperture on the lens aperture ring.

Nikkor lenses without a built-in CPU

- In Aperture-priority auto (A) or Manual (M) mode only:
—While looking at the indicator bars --, press the  or  button to change the aperture and bring the subject within the flash shooting distance range. Then set the same aperture on the lens aperture ring.

2 Set the flash sync mode.

- Set camera's flash sync mode (if available) to front-curtain sync (Normal).

3 Select the flash mode on the camera.

Flash settings

4 Select the flash mode.

—Press the **(MODE)** button until  appears on the LCD panel.

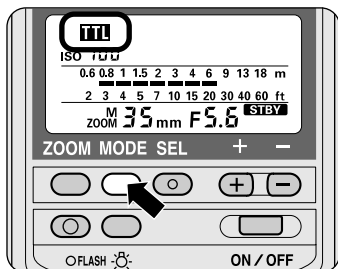

- Set your camera to the Matrix Balanced Fill Flash or Center-Weighted Fill-Flash/Spot Fill-Flash mode.

5 Check the shooting distance.

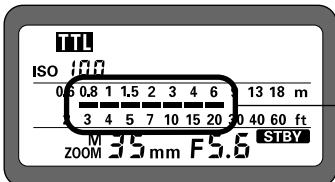

—A flash shooting distance range of 0.8 to 6m (2.6 to 20 ft) is shown.

Nikkor lenses with a built-in CPU

- In any exposure mode:

—Press the **(+)** or **(-)** button until the same aperture as displayed on the camera's LCD panel or in viewfinder is set on the SB-28's LCD panel, then confirm the flash shooting distance range.

Nikkor lenses without a built-in CPU

- In Aperture-priority auto (A) or Manual (M) mode only:

—Press the **(+)** or **(-)** button until the same aperture on the lens is set on the SB-28's LCD panel, then confirm the flash shooting distance range.

6 Wait for the ready-light to come on and make sure the subject is in focus before taking the picture.

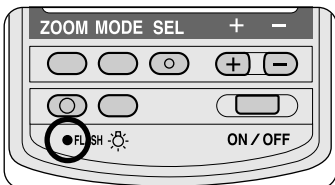



- If the ready-light blinks for approx. 3 seconds after shooting, this indicates the light may have been insufficient for correct exposure. In this case, use a wider aperture or move closer to the subject.

TTL Auto Flash Mode

For cameras in Group IV: F60-Series/N60, F50-Series/N50 and F-401x/N5005

Available flash operation in TTL Auto Flash Mode

Lens in use	Available flash operation	Camera's exposure mode*
Nikkor lenses with a built-in CPU	Matrix Balanced Fill-Flash 	Programmed auto (P) Shutter-priority auto (S) Aperture-priority auto (A) Manual (M)*
Nikkor lenses without a built-in CPU	Center-Weighted Fill-Flash/Spot Fill-Flash 	Manual (M)

* Center-Weighted Fill-Flash/Spot Fill-Flash can only be performed when the camera's exposure mode is set to Manual (M).

Flash settings

1 Select the flash mode.

—Press the **(MODE)** button until  appears on the LCD panel.

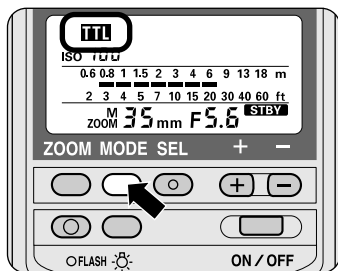

TTL Auto Flash **TTL** Mode

For cameras in Group IV: F60-Series/N60, F50-Series/N50 and F-401x/N5005

- 2** Check the shooting distance according to the lens in use and the exposure mode selected on the camera.

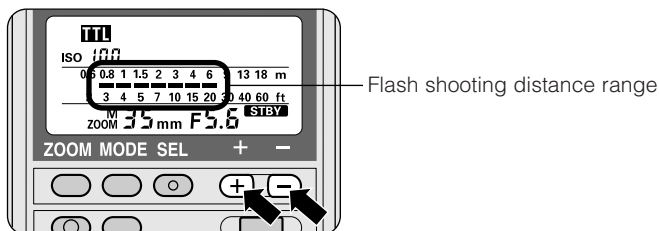

With Nikon lenses with a built-in CPU

For F60-Series/N60 and F50-Series/N50 (In Programmed Auto (P) or Shutter-Priority Auto (S) exposure mode)

With an F60-Series/N60 or F50-Series/N50 camera in the ADVANCED mode, set the aperture appearing in the camera's viewfinder on the SB-28's LCD panel by pressing the SB-28's (+) or (-) button. With an F50-Series/N50 camera in the SIMPLE mode, select the aperture from the table below and set the same aperture on the SB-28's LCD panel.

Lighting conditions (at ISO100)	Sunny day	Cloudy day or in the shadows	Indoors
Aperture setting on SB-28	f/8	f/5.6	f/4

For F-401x/N5005 (In Programmed Auto (P) or Shutter-Priority Auto (S) exposure mode)

Select the aperture from the table and set the same aperture on the SB-28's LCD panel by pressing the SB-28's (+) or (-) button. Then confirm the flash shooting distance range.

Lighting conditions: (at ISO 100)	Strong back-lighting	Sunny day	Cloudy day or in the shadows	Indoors
Aperture setting on SB-28	f/16	f/8	f/5.6	f/5.6
Usable shutter speed*	1/125 sec.			1/30 sec.

*In shutter-priority auto mode, the aperture is automatically selected by the camera.

For F60-Series/N60, F50-Series/N50 and F-401x/N5005 (in Aperture-Priority Auto (A) or Manual (M) mode)

Note the aperture set on the lens and set the same aperture on the SB-28's LCD panel by pressing the (+) or (-) button. Then confirm the flash shooting distance range.

**With Nikkor lenses without a built-in CPU
(for F60-Series/N60, F50-Series/N50 and F-401x/N5005)**

Select the aperture on the lens and set the same aperture on the SB-28's LCD panel by pressing the SB-28's (+) or (-) button, then confirm the flash shooting distance range.

- 3** Wait for the ready-light to come on and make sure the subject is in focus before taking the picture.

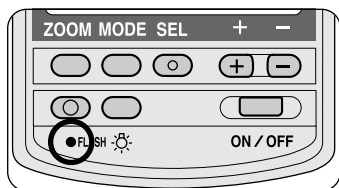



- If the ready-light blinks for approx. 3 seconds after shooting, this indicates the light may have been insufficient for correct exposure. In this case, use a wider aperture or move closer to the subject.

TTL Auto Flash Mode

For cameras in Group V: F-501/N2020, F-401s/N4004s, F-401/N4004, F-301/N2000



Available flash operation in TTL Auto Flash Mode

For F-501/N2020 and F-301/N2000

Lens in use	Available flash operation	Camera's exposure mode
Nikkor lenses with a built-in CPU* Nikkor lenses for F3AF AI-S-type Nikkor lenses AI-type Nikkor lenses Nikon Series E lenses	Programmed TTL Auto Flash 	Programmed auto (P)
	Standard TTL Flash 	Aperture-priority auto (A) Manual (M)
Other Nikkor lenses	Standard TTL Flash 	Aperture-priority auto (A) Manual (M)

*G-type Nikkor lenses cannot be used.

For F-401s/N4004s and F-401/N4004

Lens in use	Available flash operation	Camera's exposure mode
Nikkor lenses with a built-in CPU	Programmed TTL Auto Flash 	Programmed auto (P) Shutter-priority auto (S)
	Standard TTL Flash 	Aperture-priority auto (A) Manual (M)
Other Nikkor lenses	Standard TTL Flash 	Manual (M)

Flash settings

- 1 Select the flash mode.
—Press the **(MODE)** button until  appears on the LCD panel.

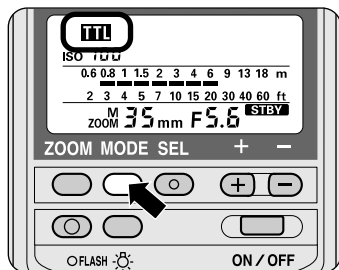

- 2** Set the aperture on the SB-28's LCD panel, then confirm the flash shooting distance range.

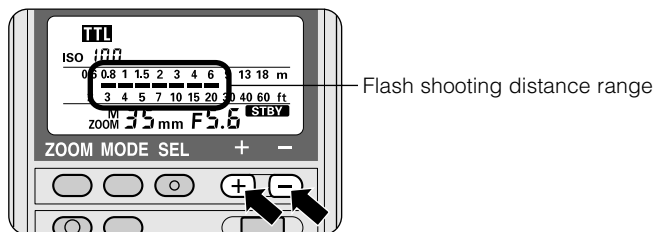

Guide to determining aperture:

For F-501/N2020 and F-301/N2000 (in Programmed Auto (P) mode)

Select the aperture for the film in use from the table (or the aperture set by the camera in aperture-priority auto (A) or manual (M) mode). Press the SB-28's (+) or (-) button to set the corresponding aperture on the SB-28's LCD panel, then confirm the flash shooting distance range.

ISO film speed	25	50	100	200	400	800
Aperture setting on SB-28	f/2.8	f/4	f/5.6	f/8	f/11	f/16

For F-401s/N4004s and F-401/N4004 (at ISO 100) (in Shutter-Priority Auto (S) or Programmed Auto (P) exposure mode)

Select the aperture from the table (aperture set on the camera in aperture-priority auto or manual mode) and set the same aperture on the SB-28's LCD panel by pressing the SB-28's (+) or (-) buttons, then check the flash shooting distance range.

Subject conditions	Strong back-lighting	Sunny day	Cloudy day or in the shadows	Indoors
Aperture setting on SB-28	f/16	f/8	f/5.6	f/5.6
Usable shutter speed*	1/125 sec.			1/30 sec.

*In shutter-priority auto mode, the aperture is automatically selected by the camera.

- 3** Wait for the ready-light to come on and make sure the subject is in focus before taking the picture.

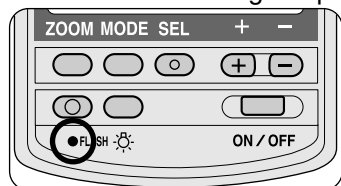

- If the ready-light blinks for approx. 3 seconds after shooting, this indicates the light may have been insufficient for correct exposure. In this case, use a wider aperture or move closer to the subject.

TTL Auto Flash Mode

For cameras in Group VI: FM3A, FA, FE2, FG, Nikonos V

Available flash operation in TTL Auto Flash Mode

Lens in use	Available flash operation	Camera's exposure mode
Nikkor lenses with a built-in CPU* and Nikkor lenses without a built-in CPU	Standard TTL Flash 	Aperture-priority auto (A)
		----- Manual (M)

*G-type Nikkor lenses cannot be used.

- In aperture-priority auto (A) mode, the shutter speed is automatically set to 1/250 sec. for the FM3A, FA, FE2, and 1/90 sec. for the FG, Nikonos V. When setting a shutter speed at a much slower speed, set the camera's exposure mode to Manual (M).
- Standard TTL Flash is not possible if the shutter speed is set to M250 or B (bulb) for the FA, FE2, and M90 for the FG, Nikonos V.

Flash settings

1 Select the flash mode.

—Press the (MODE) button until **TTL** appears on the LCD panel.

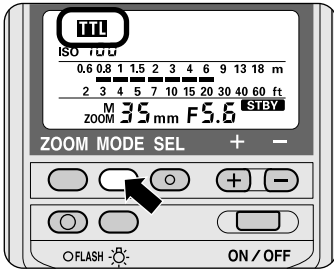

2 Check the shooting distance.

—Press the SB-28's (+) or (-) button until the aperture set on the lens is set on the SB-28's LCD panel, then confirm the flash shooting distance range.

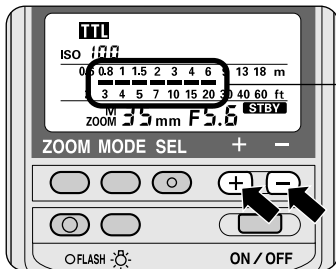

3 Wait for the ready-light to come on and make sure the subject is in focus before taking the picture.

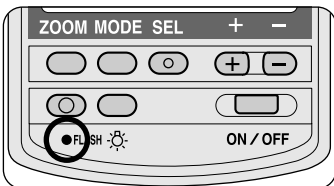

- If the ready-light blinks for approx. 3 seconds after shooting, this indicates the light may have been insufficient for correct exposure. In this case, use a wider aperture or move closer to the subject.

Non-TTL Auto Flash **A** Mode

For cameras in all groups

In Non-TTL Auto Flash shooting, the SB-28's light output automatically changes to match the flash-to-subject distance. The light, however, is not measured through the lens, but is measured by the light sensor on the front of the SB-28.

—The SB-28 can be used in Non-TTL Auto Flash mode with any Nikon camera/lens combination at any ISO film speed.

—You can choose apertures from f/2 to f/16 at ISO 100.

Flash settings

1 Select the flash mode.

—Press the **(MODE)** button until **A** appears on the LCD panel.

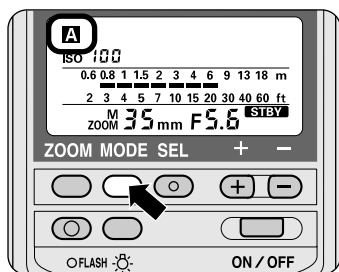

2 Select the aperture.

—Press the **(SEL)** button, then press the **(+)** or **(-)** button to change the aperture, bringing the subject within the flash shooting distance range.

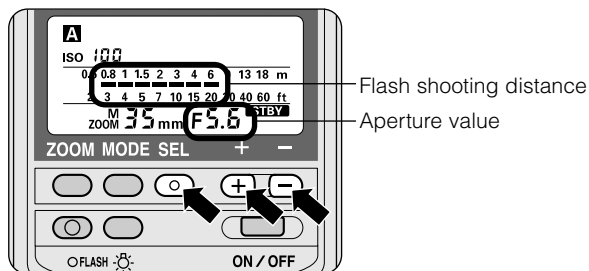

Camera settings

3 Select the exposure mode.

—Set the camera's exposure mode to Aperture-priority auto (A) or Manual (M).

4 Set the aperture on the lens.

—Set the aperture that appears on the SB-28's LCD panel on the lens.

- The subject will be overexposed if you set a larger aperture (smaller f-number) on the camera than on the SB-28, and underexposed if you set a smaller one (larger f-number).

5 Set the correct shutter speed.

—Set the camera to its highest flash sync shutter speed.

6 Wait for the ready-light to come on and make sure the subject is in focus before taking the picture.

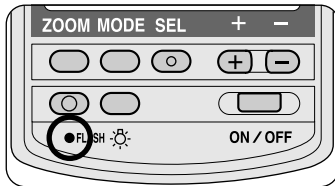

- If the ready-light blinks for approx. 3 seconds after shooting, this indicates the light may have been insufficient for correct exposure. In this case, use a wider aperture or move closer to the subject.



Advanced operation

***For handling difficult lighting situations or
expressing your ideas***

*In addition to convenient Auto Flash,
the SB-28 offers a host of other advanced operations
to match your creative ideas
or when unusual lighting situations are encountered.*



Manual flash photography is provided when shooting subjects in which the correct exposure is difficult to obtain in the TTL or Non-TTL Auto Flash Mode.

Flash settings

1 Select the flash mode.

—Press the **(MODE)** button until **M** appears on the LCD panel.

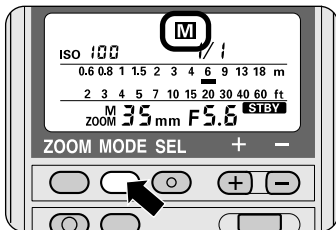

2 Adjust the flash output level.

—Press the **(+)** or **(-)** button to choose a flash output level.

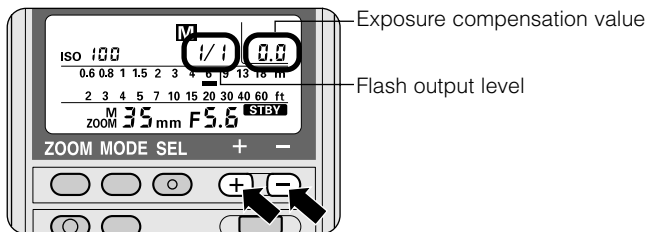

The indicator changes every time you press the **(-)** button:



→ 1/1(0.0) → 1/2(0.0) → 1/2(-0.3) → 1/2(-0.7) → 1/4(0.0) 1/64(0.0) → **■**

The indicator changes every time you press the **(+)** button:

→ **■** → 1/64(0.0) → 1/64(+0.3) → 1/64(+0.7) → 1/32(0.0) 1/2(0.0) → 1/1(0.0)

The numbers in parentheses () represent the adjustable flash output level in $\pm 1/3$ steps.

—The indicator bar **■** on the LCD panel changes to match the shooting distance at the flash output level set, and the corresponding exposure compensation value is displayed on the LCD panel.

- To extend the flash shooting distance range, choose a flash output level close to 1/1 or set the lens to a larger aperture (smaller f-number).
-  indicator appears only when used in combination with the SB-28 and cameras in Group I (except F80-Series/N80-Series, F70-Series/N70). (See page 49 on FP High-Speed Flash sync.  in Manual Flash **M** mode.)



Camera settings

3 Select the exposure mode.

—Set the camera's exposure mode to Aperture-priority auto (A) or Manual (M).

4 Set the aperture.

—For cameras in Groups I and II with Nikkor lenses with a built-in CPU: Set the aperture on the camera as you watch the indicator bar  on the LCD panel as it changes to match the shooting distance.

—For other camera/lens combinations: Press the  or  button to change the aperture on the LCD panel. Then set the same aperture on the lens aperture ring.

- You can calculate the correct shooting distance by using the guide number equation. (See pages 56-57 on Guide Numbers for determining correct aperture in Manual **M** and Repeating  Flash mode.)

5 Wait for the ready-light to come on and make sure the subject is in focus before taking the picture.

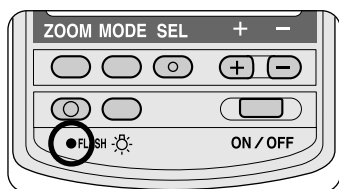

Synchronization in continuous shooting in Manual **M** mode.

The SB-28 is able to recycle fast enough to synchronize with a motor-driven camera firing continuously up to six frames per sec. at a 1/64 flash output level. It is possible to take up to 40 flash pictures in rapid succession.

Number of continuous flashes at six frames per sec.

Optional power source	Batteries Inside SB-28	Flash output			
		1/8	1/16	1/32	1/64
(SB-28 only)	All types	Up to 4	Up to 8	Up to 16	Up to 30
SD-7	AA-type alkaline-manganese	Up to 6	Up to 10	Up to 40	Up to 40
SD-8 SD-8A*	AA-type alkaline-manganese	Up to 5	Up to 10	Up to 20	
	AA-type NiCd			Up to 30	
	AA-type Ni-MH				
	Lithium				
SK-6 SK-6A*	AA-type alkaline-manganese	Up to 5	Up to 10	Up to 20	
	AA-type NiCd			Up to 30	
	AA-type Ni-MH				
	Lithium battery				

*Available in the European market only.

- SD-7 uses C-type alkaline-manganese batteries.
- Because the European version of the SB-28 comes with a different shaped connector, Nikon DC Units SD-7, SD-8 and the Power Bracket Unit SK-6 are not compatible.
- Fresh and same type batteries must be used in both the SB-28 and optional Nikon DC Units SD-8/8A*, and Power Bracket Unit SK-6/6A*.



Allow the SB-28 to cool off for at least 10 minutes after the maximum number of continuous firing shown in the table.

Flash mode and output	Max. number of continuous firings
TTL , A , SS , and M 1/1 and 1/2	15
M 1/4, 1/8, 1/16, 1/32, 1/64	40

Even if the number of continuous firings is less than those listed above, it's a good idea to let the SB-28 cool off as often as possible when using it in a warm environment.

FP High-Speed Flash sync **■** in Manual Flash **M** mode For F5, F100, F90X/N90s, F90-Series/N90

The SB-28 allows you to use faster shutter speeds for flash synchronization. With FP High-Speed Flash sync **■**, the flash emits light at an extremely rapid rate, while the shutter curtains travel to expose the film. This enables you to use a faster shutter speed as well as a wider aperture to achieve shallower depth of field to blur the background.

- Attach the SB-28 to the camera and turn on both the SB-28 and the camera, then set the SB-28 to FP High-Speed Flash sync **■**.

Camera settings

1 Set the exposure mode to Manual (M).

2 Set the aperture.

—With Nikkor lenses with a built-in CPU: Rotate the command dial on the camera or the lens aperture ring (for F90X/N90s, F90-Series/N90 cameras) as you watch the indicator bar **■** on the LCD panel change to match the shooting distance.

—With Nikkor lenses without a built-in CPU: Press the **+** or **-** button to change the aperture on the LCD panel. Then set the same aperture on the lens aperture ring.

3 Set the shutter speed.

—Set the shutter speed between 1/250 and 1/4000 sec.

- The guide number for FP High-Speed Flash sync **■** varies with the selected shutter speed and is less than that for regular flash synchronization. (See page 51 on **■** guide numbers.)
- In the **■** mode, when taking flash photographs with a shutter speed slower than 1/250 sec., it is recommended to use normal flash operation because the guide number is less in the **■** mode.
- If you set the SB-28's flash mode to a mode other than Manual **M** **■** with your camera's shutter speed set higher than 1/250 sec., the shutter speed is automatically set to 1/250 sec.

Flash settings

4 Select the flash mode.

—Press the **(MODE)** button until **M** appears on the LCD panel.

5 Set **■** on the LCD panel.

—Press the **(+)** or **(-)** button until **■** appears on the LCD panel. The indicator bar **■** on the LCD panel changes to show the shooting distance.

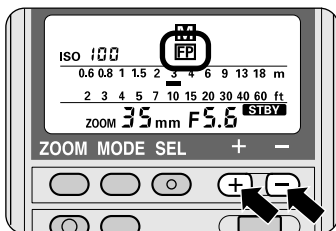

The indicator changes every time you press the **(-)** button:

→ 1/1(0.0) → 1/2(0.0) → 1/2(-0.3) → 1/2(-0.7) → 1/4(0.0) 1/64(0.0) → **■**

The indicator changes every time you press the **(+)** button:

→ **■** → 1/64(0.0) → 1/64(+0.3) → 1/64(+0.7) → 1/32(0.0) 1/2(0.0) → 1/1(0.0)

6 Wait for the ready-light to come on and make sure the subject is in focus before taking the picture.

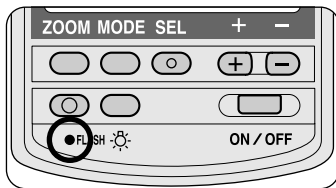

- A small amount of underexposure may result in a more pleasing photograph by shooting a subject which is further to the right by 1 or 2 steps from the distance represented by the indicator bar **■** on the LCD panel.
- If the flash-to-subject distance does not match the appropriate shooting distance shown by the indicator bar **■**, choose a different setting for the zoom-head position (smaller than the focal length of the lens in use) or move closer to or farther away from the subject.

■ guide numbers (at ISO 100; for meters/feet)

Shutter speed	Zoom-head position					
	24mm	28mm	35mm	50mm	70mm	85mm
1/250 sec.	14/46	15/50	17/56	20/65	23/74	24/77
1/500 sec.	10/33	11/36	12/39	14/46	16/52	17/56
1/1000 sec.	7/23	7.5/25	8.5/28	10/33	11/36	12/39
1/2000 sec.	5/16	5.3/17	6/20	7/23	8/26	8.5/28
1/4000 sec.	3.5/11	3.7/12	4.2/14	5/16	5.7/18	6/20

■ guide numbers vary with the ISO film speed, shutter speed, and zoom-head position.

Adjustment factors for other ISO film speeds

ISO film speed	25	50	200	400	800
Factor	x 0.5	x 0.71	x 1.4	x 2	x 2.8

- For film speeds other than ISO 100, multiply the guide numbers by the factors shown in the above chart.

For example, for a film speed of ISO 400, with the zoom-head adjusted to 35mm, and a shutter speed of 1/500 sec., the ■ guide number is $12 \times 2 = 24$ (m), or $39 \times 2 = 78$ (ft).

Notes on flash photography in FP High-Speed Flash sync ■

- **Do not use the built-in wide flash adapter.**

When used, M20 or M18, **M** and ■ blink on the LCD panel as a warning.

- **Detaching the SB-28**

When you remove the SB-28 from the F5, F100, F90X/N90s or F90-Series/N90, be sure to cancel FP flash operation. If the flash is removed with the FP setting, ■ blinks as a warning.

Repeating Flash Mode

For cameras in all groups

In the  mode, the SB-28 fires repeatedly during a single exposure, creating stroboscopic multiple-exposure effects. This mode is useful when shooting fast-moving subjects.

Flash settings

1 Select the flash mode.

—Press the **(MODE)** button until **M ** appear on the LCD panel.

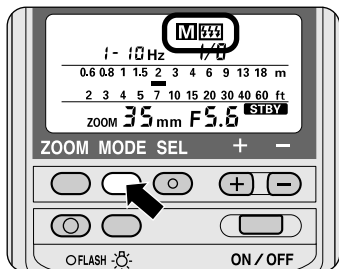

2 Set the flash output level, the frequency (Hz), and the number of repeating flashes per frame.

- Referring to the table on page 53, set the flash output level, the frequency, and the number of repeating flashes per frame separately.
—Press the **(SEL)** button until the flash output level starts blinking, then press the **(+)** or **(-)** button to set the desired flash output level. Finally, press the **(SEL)** button to stop the flash output level from blinking.
- Repeat the procedures above to set the frequency and the number of repeating flashes per frame.
- The numbers blink during adjustment and stop after 8 seconds unless the **(SEL)** button is pressed. The non-blinking number is the one automatically set.

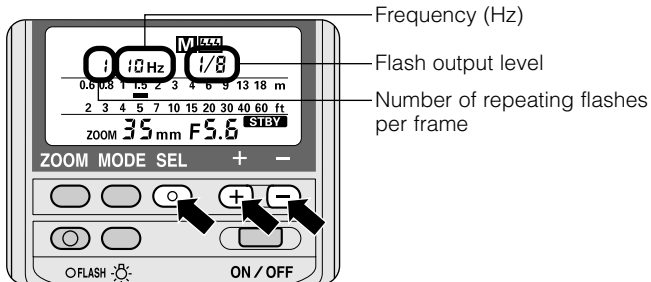

NOTE

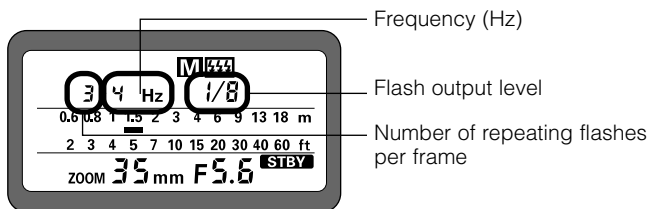

—In the example, at 1/8 flash output level, the flash will fire three times per frame at a frequency of 4 flashes per second.

Maximum number of repeating flashes per frame

Frequency*	Flash output level			
	M1/8	M1/16	M1/32	M1/64
1-2 Hz	14	30	60	90
3 Hz	12	30	60	90
4 Hz	10	20	50	80
5 Hz	8	20	40	70
6 Hz	6	20	32	56
7 Hz	6	20	28	44
8 Hz	5	10	24	36
9 Hz	5	10	22	32
10 Hz	4	8	20	28
20-50 Hz	4	8	12	24



*Frequency (Hz) represents the number of flashes per second. The higher the number, the shorter the flash firing interval.

Camera settings

3 Set the exposure mode to Manual (M).

4 Set the aperture.

—For cameras in Groups I and II with Nikkor lenses with a built-in CPU: Change the aperture on the camera as you watch the indicator bar  on the LCD panel change to match the shooting distance.

—For other camera/lens combinations: Press the  or  button to change the aperture on the LCD panel. Then set the same aperture on the lens aperture ring.

The indicator bar  shows a flash shooting distance in which the correct exposure can be obtained with a single flash firing.

5 Set the shutter speed.

—Use the equation to determine the shutter speed.

$$\text{Shutter speed} = \frac{\text{Number of flashes per frame}}{\text{Frequency of flashes (Hz)}}$$

For example, if the number of flashes per frame is 10 and frequency is 5 Hz, divide 10 by 5 to get a shutter speed of 2 sec. or slower.

—Or you can set the shutter speed to B (bulb) to accommodate any number of repeating flashes.

6 Wait for the ready-light to come on and make sure the subject is in focus before taking the picture.

—Press the  button to make sure the flash fires correctly as set.

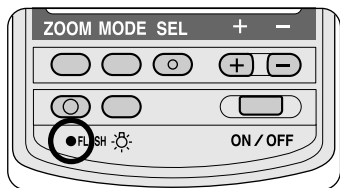

• In the Repeating Flash Mode, use a tripod to prevent camera/flash shake.



Allow the SB-28 to cool off for at least 10 minutes after 10 sequences of repeating flash.

Exposure compensation in Repeating Flash Mode

The flash shooting distance calculated in step number 4 is the correct exposure for the first flash in the sequence. Therefore, repeating flash at this flash output level will result in overexposure of the overlapped images. To prevent this, use a smaller aperture.

NOTE

Use fresh or fully charged batteries when performing repeating flash. Allow enough time for the flash to recycle between each repeating flash.

Guide Numbers for determining correct aperture in

Guide numbers help you determine a correct exposure or proper aperture (f/stop) when using the SB-28 in the Manual **M** or Repeating Flash **RF** mode.

- See page 51 for **M** guide numbers.

The guide number represents the amount of light (ISO 100: for m/ft) generated by the flash. With the SB-28, you can calculate a correct aperture by using the following equation and the guide number table.

To calculate the correct aperture:

$$f/\text{stop (aperture)} = \frac{\text{Guide number (GN)}}{\text{Flash shooting distance (m/ft)}}$$

To calculate the shooting distance:

$$\text{Flash shooting distance (m/ft)} = \frac{\text{Guide number (GN)}}{f/\text{stop (aperture)}}$$

Guide numbers (at ISO 100: for m/ft at 20°C/68°F) in **M** and **RF** modes

Flash output level	Zoom-head position							
	18mm	20mm	24mm	28mm	35mm	50mm	70mm	85mm
1/1 (full)	18/59	20/66	30/98	32/105	36/118	42/138	48/157	50/164
1/2	12.7/42	14/46	21/69	22.5/74	25.5/84	30/98	34/112	36/118
1/4	9/30	10/33	15/49	16/53	18/59	21/69	24/79	25/82
1/8	6.4/21	7/23	10.5/35	11.3/37	12.7/42	15/49	17/56	18/59
1/16	4.5/15	5/16	7.5/25	8/26	9/30	10.5/35	12/39	12.7/42
1/32	3.2/10	3.5/11	5.3/17	5.7/19	6.4/21	7.5/25	8.5/28	9/30
1/64	2.3/8	2.5/8	3.8/13	4/13	4.5/15	5.3/17	6.0/20	6.3/21

- Guide number varies with film speed.

For example, when shooting a subject located 9m (approx. 30 ft) away at 1/1 (full) flash output, with the zoom-head position at 35mm and a film speed of ISO 100, first read the guide number from the table above. In this case, it is 36 (or 118).

Then divide the guide number by the shooting distance:

$$f/\text{stop} = 36/9 \text{ (in meters)} = 4$$

$$f/\text{stop} = 118/30 \text{ (in feet)} = 3.93 = \text{approx. } 4$$

Therefore f/4 is the correct aperture.

Adjustment factors for other ISO film speeds

ISO film speed	25	50	200	400	800	1600
Factor	x 0.5	x 0.71	x 1.4	x 2	x 2.8	x 4

For film speeds other than ISO 100, multiply the guide numbers by the factors shown in the above table.

For example, if the film speed in the previous example was ISO 400 rather than ISO 100, the guide number is 72 (36 x 2).

Bounce flash operation

Applicable to all camera groups

When taking pictures indoors, direct flash often causes harsh, unattractive shadows on the subject or background. By bouncing the light off the ceiling or walls, you can soften the shadows and produce more natural-looking portraits.

With the SB-28's built-in bounce card, you can create a highlight in the subject's eyes. (See page 61, Using the built-in bounce card.)

Bounce flash shooting using diffused light



Normal flash shooting using direct flash



Camera settings

- 1 Select the exposure mode.**
—Set camera's exposure mode to Aperture-priority auto (A) or Manual (M).
- 2 Set the aperture.**
 - With bounce flash, there is a 2 to 3 stop light loss or more, depending on the height of the ceiling, when compared with normal flash operation. Therefore, you should use the largest aperture (smaller f-number) possible and bracket your exposures.

Flash settings

3 Select a flash mode.

—Press the **(MODE)** button until **III** or **A** appears on the LCD panel.

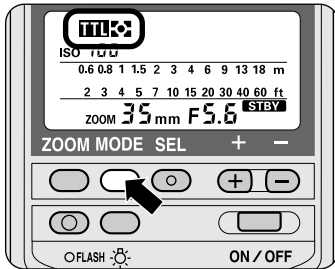

4 Tilt and/or rotate the flash head.

—Depress the flash head tilting/rotating lock release button and tilt the flash head up at least 60° to bounce light off the ceiling.

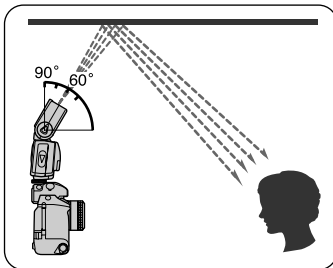

- If the angle of the flash head is not far enough off axis from the subject, uneven illumination will result from a combination of direct and bounced flash.
- In color photography, select white or highly reflective surfaces to bounce light off of. Otherwise, your pictures will come out with an unnatural color cast similar to that of the reflecting surface.

Bounce flash operation

Applicable to all camera groups

Flash head tilting and rotating angle

For bouncing light off the walls or when the camera is held vertically, the SB-28's flash head tilts up to 90° and rotates horizontally 180° (to the left) and 90° (to the right). Always set the flash head at a click stop.

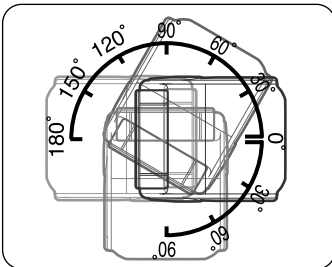
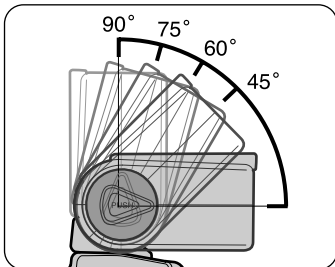

- When the flash head is tilted up or rotated from the horizontal/front position, the shooting range indicator bars -- on the LCD panel disappear and the SB-28's Monitor Preflash does not operate.
- The shooting range indicator bars -- blink when the flash head is tilted down to the -7° position. This position is used when shooting subjects 1.5m (approx. 5 ft) or closer.

5 Wait for the ready-light to come on and make sure the subject is in focus before taking the picture.

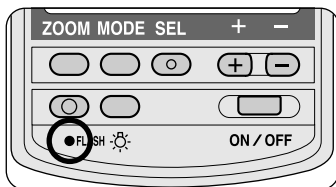

- If the ready-light blinks for approx. 3 seconds after shooting, the flash fired at its maximum output, indicating the light may have been insufficient for correct exposure. In that case, use a wider aperture or move closer to the subject.
- In bounce flash operation, no shooting range indicator bars -- appear. Therefore, you should check the distance between the flash head and the bounce surface, between the bounce surface and the subject, and the angle of tilt or rotation of flash head, then bracket your exposures by ± 1 or 2 stops.

Using the built-in bounce card

In bounce flash photography, you can create a highlight in the subject's eyes by using the SB-28's built-in bounce card. This white card reflects a small amount of light directly back to the subject, opening up the shadows and making the eyes look more vibrant.

- 1 Pull out the wide flash adapter.

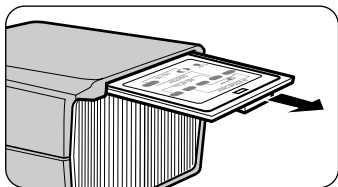

- 2 While holding the bounce card, slide the wide flash adapter back into place inside the flash head.

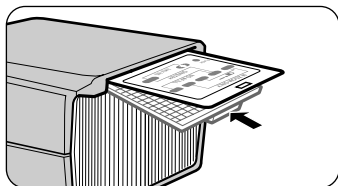

- After sliding the wide flash adapter back into place, pull out the bounce card gently as far as it goes. Be careful not to force the bounce card.

- 3 Set the flash head as shown and take pictures.

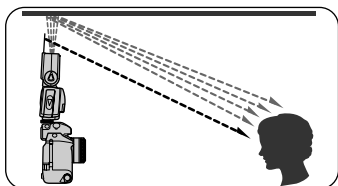

- After use, don't forget to slide the bounce card back into its original position inside the flash head.

Close-up flash operation in TTL Auto Flash Mode

When shooting subjects closer than 0.6m (2 ft), use your SB-28 off camera and utilize its built-in wide flash adapter.

- 1 Connect the SB-28 to your camera using the optional TTL Remote Cord SC-17.

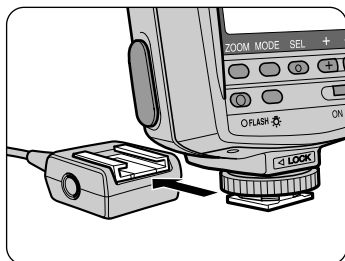

- For F5 cameras with a High-Magnification Finder DW-30 or DW-31, use the optional TTL Remote Cord SC-24.
- For F4 cameras with a High-Magnification Finder DW-20 or DW-21, use the optional TTL Remote Cord SC-24.

Camera settings

- 2 Set the exposure mode to Aperture-priority auto (A) or Manual (M).

—For cameras with VARI-PROGRAM or SIMPLE mode, close-up flash photography is easy by setting the camera to the Close-Up mode.

- 3 Set the aperture.

—Calculate the aperture (f/stop) by using this equation and table.

$$f/\text{stop} = \frac{\text{coefficient}}{\text{flash-to-subject distance}}$$

ISO film speed and coefficient

ISO film speed	100 or lower	125–400	500 or higher
Coefficient*	4 (13)	8 (26)	11 (36)

*Numbers in parentheses () represent coefficients in feet.

For example, with a subject 0.5m (1.6ft) away using ISO 100 film and the wide flash adapter in place, the suggested aperture is:

$$f/\text{stop} = \frac{4}{0.5} \text{ (in meters)} = 8, \quad f/\text{stop} = \frac{13}{1.6} \text{ (in feet)} = \text{approx. } 8$$

Therefore, you should use f/8 or a smaller aperture, such as f/11.

Flash settings

4 Set the flash mode.

—Press the (MODE) button until **III** appears on the LCD panel.

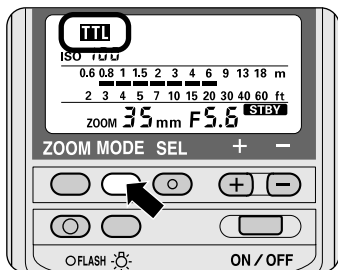

5 Position the built-in wide flash adapter over the flash head.

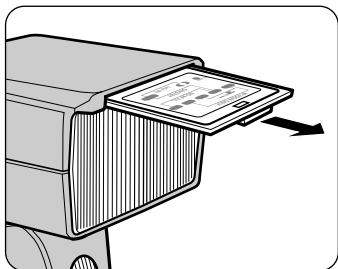

- Refer to page 21, Setting the built-in wide flash adapter.

6 Adjust the zoom-head position to 18mm or 20mm regardless of the lens focal length in use.

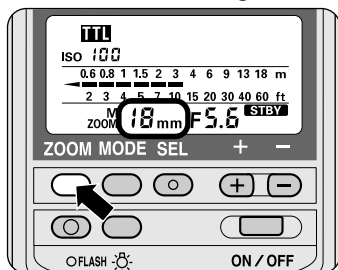

- 7** Move the SB-28 off axis, making sure the subject will receive sufficient illumination.

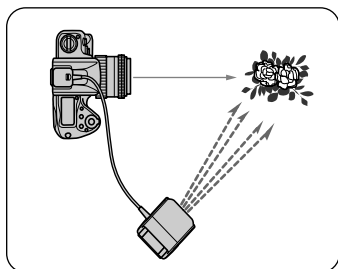

- In 3D Multi-Sensor Balanced Fill-Flash mode with cameras in Group I, you may not be able to obtain correct exposure because distance information from the lens (D-type Nikkor) is used. In this case, position the camera and SB-28 at equal distances from the subject.

- 8** Wait for the ready-light to come on and make sure the subject is in focus before taking the picture.

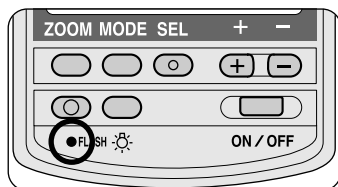

- If the ready-light blinks for approx. 3 seconds after shooting, this indicates the light may have been insufficient for correct exposure. In this case, use a wider aperture or move closer to the subject.
- Correct exposure cannot be obtained if the subject is predominantly black or white or contains a highly reflective surface. In that case, make exposure compensation according to the shooting conditions. (See pages 71-75, Exposure compensation in flash photography, to ensure correct exposure.)

Multiple flash operation in **TTL** and **M** flash modes

To eliminate harsh, directional shadows produced by a single flash unit or to add additional illumination to the background, you can attach additional Nikon Speedlights in series.

Flash shooting with more than one unit



Flash shooting with one flash unit



For multiple flash operation with the SB-28, both TTL Auto Flash **TTL** and Manual Flash **M** modes are possible.

- Multiple flash operation in TTL Auto Flash **TTL** mode is possible with cameras in Groups I through VI and F3-Series cameras. Multiple flash operation in Manual Flash **M** mode is possible with cameras in all groups.
- For applicable flash units and accessories, see pages 68-69, System chart for TTL multiple flash.
- In multiple flash operation, first decide which will be the main unit and which the secondary unit(s). To eliminate shadows, adjust the lighting ratio so that illumination from the main unit is greater than that from the secondary unit(s).

Notes on multiple flash operation

- In multiple flash operation, if the electric current in the synchro circuit exceeds a certain level, you may not be able to take a second shot after the first. In this case, turn each of the flash units off once or disconnect the SB-28 unit from the camera. This resets the circuits so you can resume shooting.
- In multiple flash operation, take care that the combined total of the coefficients (numbers shown in parentheses below) for all flash units used at the same time does not exceed 20 at 20°C (68°F), or 13 at 40°C (104°F).

Speedlight coefficients

SB-50DX (1)	SB-29 (1)	SB-28/28DX (1)	SB-27 (1)
SB-26 (1)	SB-25 (1)	SB-24 (1)	SB-23 (4)
SB-22s (1)	SB-22 (6)	SB-21 (4)	SB-20 (9)
SB-17 (4)	SB-16 (4)	SB-15 (4)	SB-14 (1)
SB-11 (1)	SB-140 (1)		

Coefficient numbers in parentheses are in units of 70μA.

TTL multiple flash operation

Cameras in Groups I through VI and F3-Series

- 1 Attach the main flash unit to the camera's accessory shoe.
 - To use the SB-28 off-camera, refer to pages 68-69, System chart for TTL multiple flash, for the correct type of optional TTL Remote Cord to use.
- 2 Set the flash mode of the master flash unit to **TTL** mode.

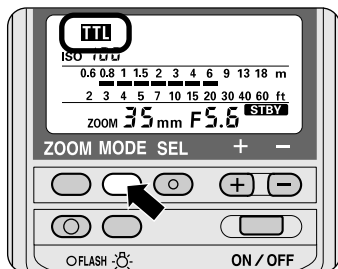

- To obtain the correct exposure with the SB-28 when used as the main flash and set to 3D Multi-Sensor Balanced Fill-Flash, cancel Monitor Preflash on the main flash unit by pressing the **(MODE)** button until **TTL** appears on the LCD panel.

- 3 Connect the main flash unit to the secondary flash unit(s).

—Use one or more TTL Remote Cords SC-18 or SC-19 to connect the SB-28 to the secondary flash unit(s) in series.

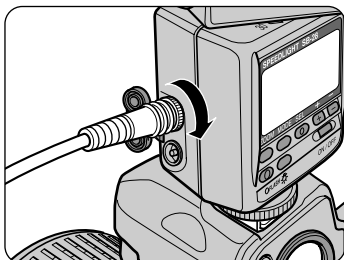

- Turn off all flash units before connecting.
- Use Multi-Flash Adapter AS-10 when using more than three flash units for TTL multiple flash operation, or if the secondary flash units are not equipped with multiple flash terminals.
- Use Tripod Adapter AS-11 to attach the SB-16A or SB-17 to a tripod.

- 4** Set the flash mode on all the flash units to **III**.
 - Turn on all flash units and make sure their Standby functions are canceled.
- 5** Follow the same procedures as in normal TTL Auto Flash **III** mode.
 - When all flash units are set to Manual flash **M** mode, Manual multiple flash operation is performed.

TTL multiple flash operation using the Wireless Slave Flash Controller SU-4 (optional)

- TTL multiple flash operation is possible by using the camera's built-in Speedlight or a Speedlight mounted on the camera's hot shoe as the master flash unit, and one or more Speedlights mounted on the Wireless Slave Flash Controller SU-4s as slave flash units. The SU-4's built-in light sensor not only detects when the master flash unit fires to trigger the slave flash unit, but also controls the flash duration of the slave flash unit in sync with the master flash unit.
Manual multiple flash operation is also possible by setting the flash mode selector to manual (M).
- These Nikon Speedlights are usable:
SB-29, SB-28/28DX, SB-27, SB-26, SB-25, SB-24, SB-23, SB-22s, SB-22, SB-20, SB-18, SB-16B, SB-15
- For more information, refer to the instruction manual provided with the SU-4.

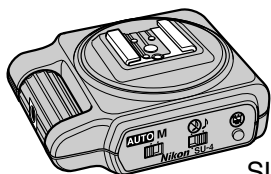

SU-4

System chart for TTL multiple flash

(For cameras in Groups I through VI, plus F3-Series cameras)

- SB-11, SB-14, SB-140, and SB-21B Speedlights cannot be used with the F-401/N4004 or F-401s/N4004s as either main or secondary units.

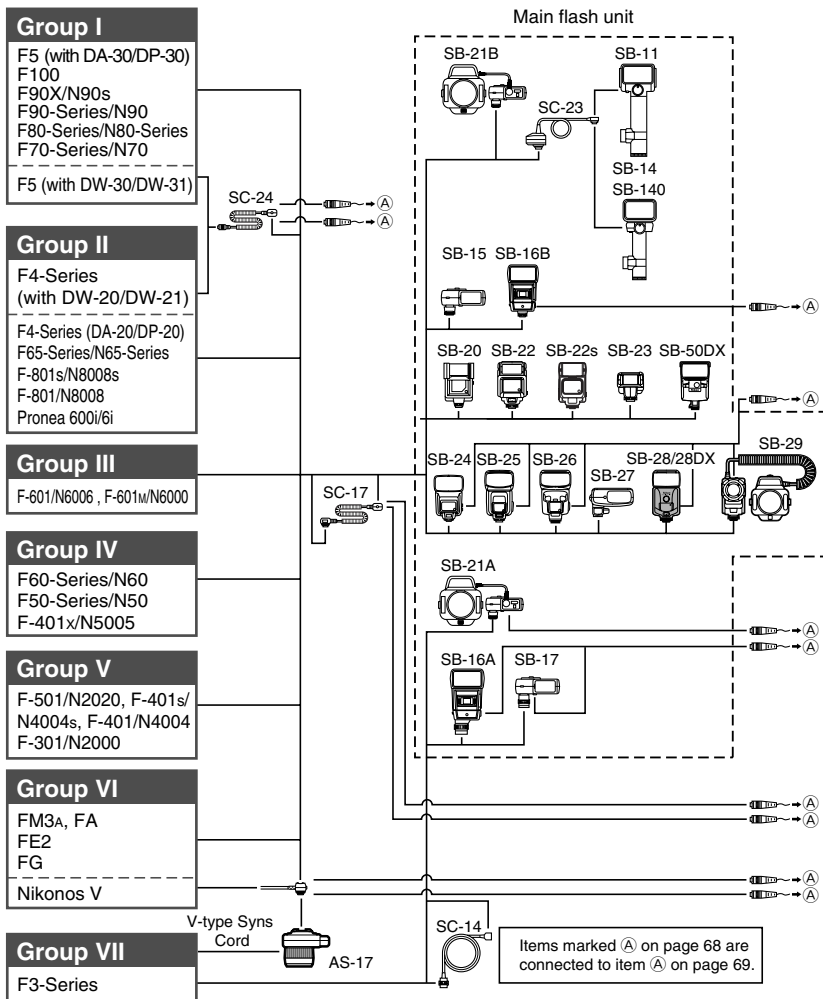

Secondary flash unit

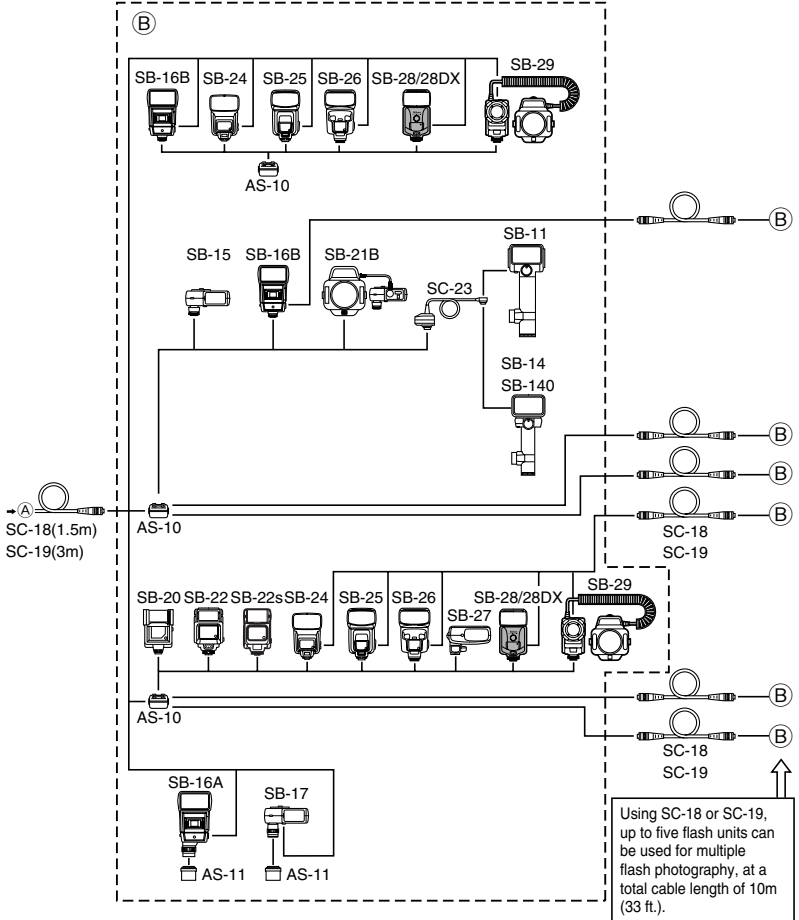

Manual multiple flash operation (For cameras in all groups)

- For speedlights which can serve as secondary flash units, see the System chart for TTL multiple flash on pages 68–69.

- 1** Connect the SB-28 to the sync terminal of the secondary flash unit(s) using a cord.

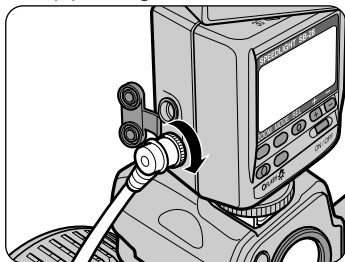

Usable optional remote cords:

Use the sync terminals for connecting the SB-28 with other flash units via the Sync Cord SC-11/SC-15, or TTL Multi-Flash Sync Cord SC-18/SC-19.

- 2** Set the flash mode of all the flash units to Manual **M**.
- 3** Set the zoom-head position and the flash-to-subject distance of the main flash unit and secondary unit(s).
 - First set the zoom-head position and the flash-to-subject shooting distance of the main flash unit, then on the secondary unit(s).
 - To calculate the maximum number of flash units that can be connected, see page 65.
- 4** Follow the same procedure as in normal Manual flash **M** mode.
 - For applicable guide numbers in Manual **M** mode for each flash output level at each zoom-head position, see pages 56-57, Guide Numbers for determining correct aperture in **M** and **SS** modes.

Exposure compensation in flash photography

For cameras in all groups

In the TTL Auto Flash **III** or non-TTL Auto Flash **A** mode, some plus compensation may be necessary when the background includes a mirror, white wall or other highly reflective surface. Likewise, some minus compensation may be required when the background is dark or includes subjects of low reflectivity.

You can also make exposure compensation to create flash photographs which are somewhat brighter or darker to match the subject or your creative preferences.

Exposure compensation methods can be divided into five categories. The flash output level is automatically compensated in category 1, and manually compensated by the user in the categories 2 to 5. But this may vary depending on which camera you are using.

1 Automatic exposure compensation in TTL Auto Flash **III** mode

In 3D multi-sensor balanced fill-flash, Multi-sensor balanced fill-flash, and Center-weighted/Spot fill-flash operations, the flash output is automatically balanced to keep both subject and background correctly exposed. To cancel automatic exposure compensation, change the flash mode to Standard TTL Flash.

2 Intentional exposure compensation of the SB-28's flash output in TTL Auto Flash **III** mode

The SB-28's flash output level can be compensated without affecting the background exposure. (See page 72)

3 Intentional exposure compensation of the SB-28's flash output and the background in TTL Auto Flash **III** mode

Use your camera's exposure compensation control button or dial to make exposure compensation to both foreground and background. (See page 74)

4 Intentional exposure compensation of the main subject in Non-TTL Auto Flash **A** mode

Set a different aperture on the camera than that set on the SB-28 to make the foreground subject lighter or darker. (See page 75)

5 Intentional exposure compensation of the main subject in Manual **M** mode

Intentionally set a different aperture on the camera than that set on the SB-28 or change the flash output level. (See page 75)

Intentional exposure compensation described in categories 2 to 5 in TTL Auto Flash **III**, Non-TTL Auto **A** and Manual **M** modes is explained on the following pages.

Flash exposure compensation in TTL Auto Flash mode

For cameras in Groups I through III when making exposure compensation to the SB-28's flash output

In the  mode, only the SB-28's flash output can be compensated without affecting the background exposure.

- Cameras with EV compensation capability allow you to make exposure compensation on either the SB-28 or the camera (or both). If you use both controls, exposure is modified by the sum total of both exposure compensation values and will affect the background exposure.

Although the SB-28's LCD panel does not display the amount of compensation set on the camera, the shooting range indicator bars-- still automatically change to match the exposure compensation.

NOTE

With cameras in Group III, make exposure compensation on the camera. The amount of compensation set on the camera does not appear on the SB-28's LCD panel.

Flash settings

- 1 Press the **(MODE)** button until  appears on the LCD panel.

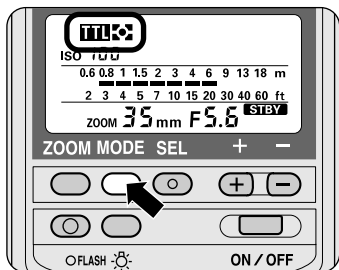

- 2 Press the **(SEL)** button until  appears on the LCD panel and the exposure compensation value starts blinking.

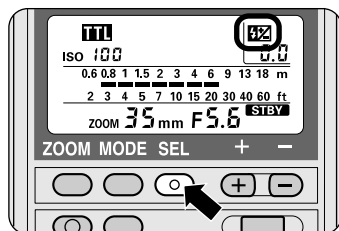

3 Set the desired exposure compensation.

—Press the (+) or (–) button to increase or decrease the compensation.

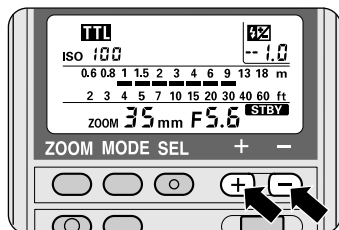

- Exposure compensation is possible in 1/3 steps from –3.0 to +1.0 EV.
- The shooting range indicator bars -- automatically change according to the amount of exposure compensation.

4 Press the (SEL) button to make the exposure compensation value stop blinking.

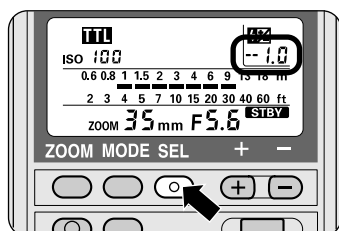

- The exposure compensation value blinks during adjustment and stops after 8 seconds unless an adjustment is made. The last blinking number is the one automatically set.

Canceling exposure compensation

Flash exposure compensation cannot be canceled by turning the SB-28 off. To cancel, reset the exposure compensation to 0.0 following the steps outlined above.

Flash exposure compensation in TTL Auto Flash **TTL** mode

For cameras in Groups I through VI (when making exposure compensation to the SB-28's flash output and the background)

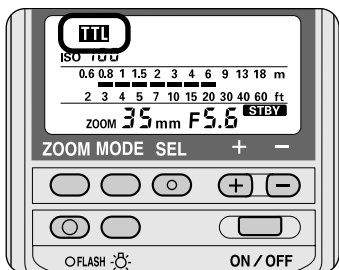

Use your camera's EV compensation control to make exposure compensation. In this mode, flash output is automatically controlled to keep both subject and background correctly exposed.

- For more details, refer to your camera's instruction manual.
The SB-28's LCD panel does not display the amount of compensation set on the camera.
- With cameras in Groups I and II, the shooting range indicator bars -- automatically change according to the amount of exposure compensation. For cameras other than those in Groups I and II, use this chart as a guide in obtaining the correct flash shooting distance range.

Exposure compensation values possible with various film speeds

Film speed	Exposure compensation value				
	+2	+1	0	-1	-2
ISO 25	—	—	25	50	100
ISO 50	—	25	50	100	200
ISO 100	25	50	100	200	400
ISO 200	50	100	200	400	800
ISO 400	100	200	400	800	—
ISO 800/1000	200	400	800	—	—

For example, with ISO 100 film, if you want to make an exposure compensation of +2 steps on the camera, set the film speed on the SB-28's LCD panel to ISO 25, then check the flash shooting distance range.

- For cameras in Groups I through VI, exposure compensation in the TTL Auto Flash **TTL** mode is not possible when the film speed exceeds those listed above. In this case, set the flash mode to Non-TTL Auto Flash **A** or Manual Flash **M** mode.

Flash exposure compensation in Non-TTL Auto Flash **A** mode

In this mode, if you don't set the same aperture on the lens as that set on the SB-28, you cannot obtain the correct exposure. Therefore, to make exposure compensation, vary the aperture set on the camera while retaining the aperture set on the SB-28.

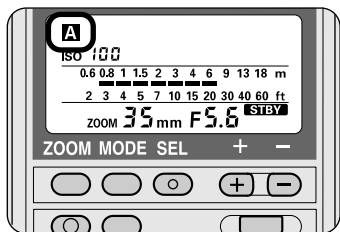

- Read the flash shooting distance range as shown on the SB-28 without changing the aperture set on the SB-28.

Flash exposure compensation in Manual Flash **M** mode

In this mode, you can obtain the correct exposure by balancing three factors: flash output level, flash-to-subject distance, and aperture. You can calculate a correct aperture and flash shooting distance range by using the guide number equations on page 56.

—First set the exposure indicated by the camera, then (1) use a different aperture on the camera than that on the SB-28, or (2) select an output setting ranging from full output (1/1) to one sixty-fourth (1/64).

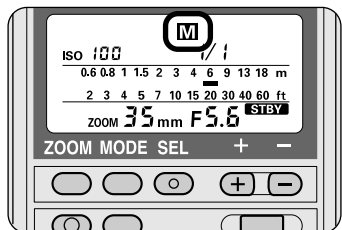

For example, the subject will be overexposed if you use a larger (smaller f-number) aperture on the camera than that set on the SB-28 or choose a higher flash output level setting, and underexposed if you do the opposite.

- Although the indicator bar **■** on the SB-28's LCD panel changes as you change the flash output level, go ahead and shoot anyway.

Red-eye reduction control

For cameras in Group I (except F5), F65-Series/N65-Series and Pronea 600i/6i

When photographing people or animals in dim light using flash, the subject's eyes may come out bright red in color pictures or white in black and white pictures. This phenomenon is known as red-eye. To prevent this, cameras in Group I (except the F5) as well as the Pronea 600i/6i feature red-eye reduction control.

- You cannot set red-eye reduction on the SB-28 directly. For more information, refer to your camera's instruction manual.
- When red-eye reduction is set on your camera, the SB-28's red-eye reduction LED lights up for approx. 1 sec. before the flash fires to close down the iris of the subject's eyes.

Setting your camera to red-eye reduction

After setting your camera to red-eye reduction, check the SB-28's LCD panel to make sure  appears.

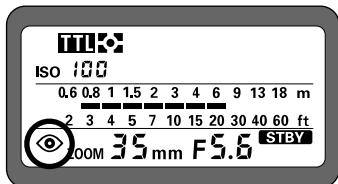

Rear-curtain flash sync

Cameras in Groups I through III featuring a rear-curtain flash sync mode (F5, F100, F90X/N90s, F90-Series/N90, F80-Series/N80-Series, F70-Series/N70, F65-Series/N65-Series, F-601/N6006 and Pronea 600i/6i cameras only)

In normal flash synchronization, the SB-28 fires at the beginning of the exposure just after the front shutter curtain opens. When shooting fast-moving subjects at slower shutter speeds, this usually results in unnatural-looking pictures where the subject frozen by the flash appears behind or within the blurred movement.

In rear-curtain flash sync, the flash fires at the end of the exposure, just before the rear curtain closes, creating a picture in which the frozen subject is in front of the blurred action.

- Because the SB-28 does not have its own rear-curtain control, only those cameras with a rear-curtain flash sync mode can perform this function by setting it on the camera.

Rear-curtain flash sync (rear)



Front-curtain flash sync (normal)



- No rear-curtain flash sync indicator appears on the SB-28's LCD panel even when this mode is set on the camera.
- In multiple flash setups, the main flash unit can be set to either front-curtain or rear-curtain flash sync. The secondary units, however, cannot be set to rear-curtain flash sync.

Rear-curtain flash sync

Cameras in Groups I through III featuring a rear-curtain flash sync mode

Flash settings

1 Select the flash mode.

—Press the **(MODE)** button until the desired mode **TTL**, **A**, or **M** appears on the LCD panel.

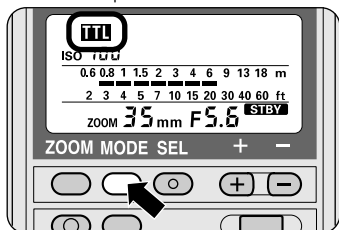

- In Manual **M** mode when either FP High-Speed Flash sync  or Repeating  Flash is selected, rear-curtain flash sync cannot be performed.

Camera settings

2 Set the flash sync mode to rear-curtain sync.

3 Set the exposure mode.

—Set the camera's exposure mode to Shutter-priority auto (S) or Manual (M).

- Although rear-curtain flash sync is possible in Programmed auto (P) or Aperture-priority auto (A) mode, it is not recommended because you cannot intentionally adjust the shutter speed.

4 Set the shutter speed.

- The slower the shutter speed you select, the more effective the results will be.
- Use of a tripod is recommended.

5 Check the shooting distance. Wait for the ready-light to come on and make sure the subject is in focus before taking the picture.

- In **TTL**, or **A** mode, if the ready-light blinks for approx. 3 seconds after shooting, this indicates the light may have been insufficient for correct exposure. In this case, use a wider aperture or move closer to the subject.

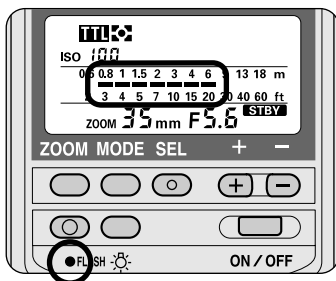

Additional information

Reference section

In this section, information on troubleshooting and optional accessories is presented. Following that are tips on Speedlight care, notes on batteries, with the SB-28's specifications coming at the end of the manual.



Checking the correct exposure

For cameras in all groups

In Non-TTL Auto Flash **A** mode, you can determine whether the subject will receive the correct exposure by test firing the SB-28 before actually taking pictures.

- 1 Set the camera's exposure mode to Aperture-priority auto (A) or Manual (M).
- 2 Press the SB-28's **(MODE)** button until **A** appears on the LCD panel.
- 3 Set the same aperture on both the SB-28 and the camera.
- 4 Check that the SB-28's ready-light is on.
- 5 Focus on the subject and check the shooting range indicator bars -- to make sure it's within range.
- 6 Press the **(FLASH)** button to fire the flash.

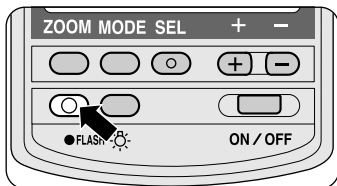

If the ready-light blinks for approx. 3 seconds after shooting, this indicates the light may have been insufficient for correct exposure. In this case, use a wider aperture or move closer to the subject.

NOTE

To determine if the exposure will be correct in TTL Auto Flash **(III)** mode, press the **(MODE)** button to change the flash mode to the Non-TTL Auto Flash **A** mode. Set the same aperture on the SB-28's LCD panel as in the **(III)** mode, then perform test firing. If the ready-light blinks for approx. 3 seconds after shooting, the light will be insufficient for correct exposure in the **(III)** mode as well.

Autofocus flash operation in dim light

For autofocus cameras only

When the light is too dim for normal autofocus operation, the SB-28's AF assist illuminator LED automatically turns on when set to illuminate dark subjects when the shutter release button is pressed halfway.



- Take care not to block the AF assist illuminator LED while shooting.
- The AF assist illuminator LED turns off as soon as the subject is in focus.
- The AF assist illuminator LED will not light up with an F5, F100, F80-Series/N80-Series or F65-Series/N65-Series camera unless the camera's central focus area is selected.

Conditions necessary to activate the AF assist illuminator LED:

- ① The subject must be sufficiently dark and within the range of 1m (3.3 ft) to 8m (16.4 ft) at 20°C (68°F).
 - ② AF Nikkor lenses must be used.
Lenses from 24mm (35mm for F-501/N2020) to 105mm are recommended.
Other AF Nikkor lenses can be used depending on shooting conditions.
Perform test firing before use.
 - ③ The camera's autofocus mode is set to Single Servo Autofocus (S).
 - ④ Focus lock is not employed.
 - ⑤ The SB-28's ready-light is on.
- Replace batteries whenever the ready-light becomes dark or blinks after the AF assist illuminator LED turns on.

NOTE

If the AF assist illuminator LED comes on but no in-focus indicator appears in the camera's viewfinder with the shutter release button pressed halfway, the subject is outside the flash shooting distance range. In this case, set the camera's focus mode selector to manual **M** and focus manually.

To cancel autofocus flash operation with the AF assist illuminator LED

Hold down the **(MODE)** button as you press the **(\square)** button.

—The **N A** indicator comes on or disappears on the LCD panel every time you press the **(MODE)** and **(\square)** buttons simultaneously.

—The AF assist illumination LED is set when the **N A** indicator is not on and canceled when the **N A** indicator appeared.

—The AF assist illumination LED is preset to operate when the SB-28 is shipped from the factory.

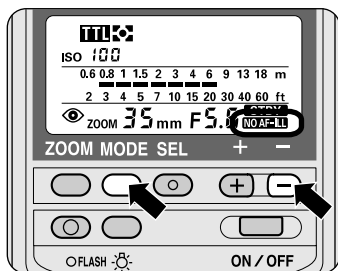

Accessories for multiple flash

Sync Cord SC-11 and SC-15

Sync Cords SC-11 and SC-15 are handy when you want to use the SB-28 off-camera or for use with cameras without accessory shoes. These cords also allow you to perform Multiple Flash photography in the Manual **M** mode. The SC-11 is approx. 25 cm (9.8 in.) long and the SC-15 is approx. 1m (3.2 ft) long.

TTL Remote Cord SC-17 and SC-24

The TTL Remote Cord SC-17 provides TTL Auto Flash operation when the SB-28 is used off-camera. Its flash shoe comes with one tripod socket and two TTL multiple flash terminals. The TTL Remote Cord SC-24 is for use with F5 cameras mounted with a High-Magnification Finder DW-30 or DW-31 or F4 cameras with a High-Magnification Finder DW-20 or DW-21. Both the SC-17 and SC-24 are approx. 1.5m (4.9 ft) long.

TTL Multi-Flash Sync Cord SC-18 and SC-19

Multi-Flash Sync Cords SC-18 or SC-19 are useful for connecting the SB-28 to the multiple flash terminal of the SC-17 or AS-10 for TTL multiple flash operation. The SC-18 is approx. 1.5 m (4.9 ft) long, and the SC-19 is approx. 3 m (9.8 ft) long.

TTL Multi-Flash Adapter AS-10

Use Multi-Flash Adapter AS-10 when connecting more than three flash units together for TTL multiple flash operation, or if the secondary flash units are not equipped with multiple flash terminals. The AS-10 comes with one tripod socket and three TTL multiple flash terminals.

Sync Terminal Adapter AS-15

The Sync Terminal Adapter AS-15 is necessary when connecting the SB-28 to cameras not having a sync terminal.

Wireless Slave Flash Controller SU-4

Useful for multiple flash photography, the SU-4 features a built-in, movable light sensor and an accessory shoe for attachment of a slave Speedlight. The SU-4's light sensor not only triggers the slave unit to fire in unison with the master flash, but controls the flash duration of the slave unit in sync with the master unit to provide TTL, non-TTL, or Manual operation.

TTL Flash Unit Coupler AS-17 for F3-Series cameras

Dedicated adapter for F3-Series cameras providing TTL flash operation with Nikon Speedlights such as SB-29 and SB-28 featuring ISO-type mounting foot (not designed for F3).

Connecting the SB-28 to your camera using a sync cord

You can connect the SB-28 to your camera by attaching a sync cord to the SB-28's sync terminal.

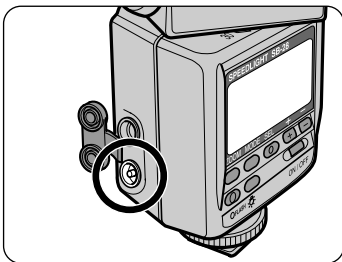

- You cannot use a sync cord when the SB-28 is set to the **III** mode.

Usable sync cords

SC-11 (approx. 25 cm)

SC-15 (approx. 1m)

NOTE

- To connect the SB-28 to a camera without a sync terminal, use optional Sync Terminal Adapter AS-15.
- Use the sync/multiple flash terminal when connecting the SB-28 to other Nikon flash units via sync cords.
- When the SB-28 is connected to a camera via a sync cord, it provides neither automatic sync speed setting nor ready-light indication inside the camera's viewfinder. To maintain all functions, use the optional TTL Remote Cord SC-17.
- If a non-Nikon flash unit—one incorporating a high-voltage (above 50V) or negative voltage sync circuits—is connected to the SB-28's sync/multiple flash terminal, the SB-28's protection circuit is activated, resulting in improper operation of the unit.

Available external power sources

External power source SD-7

External power source SD-8/8A*

Power Bracket SK-6/6A*



Use only Nikon-approved external power sources

Using external power sources other than those specified by Nikon may cause damage to the SB-28.

* Available in the European market only.

Using an external power source

Nikon's external power source DC Units increase the number of flash firings and provide faster recycling time. (See page 93.)

To use a DC Unit, connect its power cord to the SB-28's external power source terminal.

External power source terminal

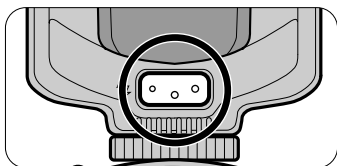

External power source terminal
(for European market)

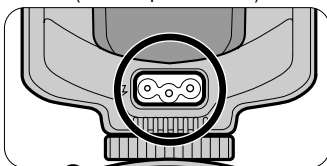

- Even when a DC Unit is used, the SB-28 still requires batteries inside the flash unit.

NOTE

Because the European version of the SB-28 comes with a different shaped connector, Nikon DC Units SD-7, SD-8 and the Power Bracket Unit SK-6 are not compatible.

Tips on Speedlight care

Avoid physical shocks

Do not drop the SB-28 or hit it against a hard surface as this may damage its precision mechanisms.

Never disassemble the SB-28

Never attempt to disassemble or repair the SB-28 yourself. The SB-28 contains high-voltage circuitry which can cause electric shock.

Keep the SB-28 away from water

The SB-28 is not waterproof and therefore should not be exposed to rain or saltwater. If water gets inside the SB-28, corrosion may occur, resulting in high repair costs.

Cleaning

Use a blower brush to remove dirt and dust from the SB-28 and clean it with a soft, clean cloth. Never use commercial cleaners containing thinner, benzene, or alcohol as they could damage its plastic parts.

Maintenance

When storing the SB-28 for two weeks or longer, remove the batteries to prevent battery leakage. Also once a month, insert fresh batteries and fire the unit several times to reform its capacitor and keep the SB-28 in top working order.

Storage

Store the SB-28 in a cool, dry place to prevent mold and mildew. Also keep it away from chemicals such as camphor or naphthalene. Avoid exposing the SB-28 to magnetic waves from TVs or radios and never store it the trunk or glove compartment of a vehicle during the summer.



WARNING

- Keep batteries out of the reach of children. If a battery is accidentally swallowed, call a doctor immediately.

Notes on handling batteries

- Do not expose batteries to excessive heat. Never store them in the truck or glove compartment of a vehicle during the summer or place them near a fire or hot surface. Even hot, direct sunlight may cause them to explode.
- When loading batteries, make sure the SB-28 is turned off, then follow the + and – symbols inside the battery chamber.
- If the SB-28 is not used for more than two weeks, remove the batteries and store them in a dry place at 20°C (68°F) or below.
- Battery power tends to weaken as the temperature drops. It also weakens after heavy use, recovering gradually after a short break. Power gradually decreases when batteries are not used for a long time. Check battery power before use; replace batteries with a new set before they are completely exhausted.
- Battery performance may differ with each brand, due to modification in specifications or improvement in performance.

Four AA-type alkaline-manganese, lithium, or rechargeable NiCd or Nickel-Metal Hydride (Ni-MH) batteries are required to power the SB-28.

- For fast recycling times: NiCd batteries are recommended followed by (2) Ni-MH, (3) alkaline-manganese, and (4) lithium batteries.
- For increasing the number of flashes per battery set: at normal temperatures, lithium batteries are recommended followed by (2) alkaline-manganese, (3) Ni-MH, and (4) NiCd batteries; at low temperatures, lithium batteries are recommended followed by (2) Ni-MH, (3) alkaline-manganese, and (4) NiCd batteries.
- Ni-MH batteries feature approx. the same battery power as 1000mAh NiCd batteries.
- 1000mAh NiCd batteries have approx. 1.4 times the power capacity of 700mAh NiCd batteries.

- Lithium batteries have approx. 1.1 to 1.2 times the power capacity of alkaline-manganese batteries.
- Lithium batteries feature greater efficiency at low temperatures when compared with alkaline-manganese batteries. Lithium batteries boast consistent performance in terms of recycling times and number of flashes, regardless temperature changes.
- NiCd batteries boast a constant recycling time regardless of temperature changes when compared with other types of batteries. Recommended for use in temperatures as low as 0°C (32°F).
- Ni-MH batteries feature a constant recycling time but a little longer recycling time at low temperatures when compared with NiCd batteries. However, Ni-MH batteries maintain their efficiency regarding the number of flashes regardless of temperature changes.











Notes on using alkaline-manganese and lithium batteries

- Non-rechargeable batteries such as alkaline-manganese and lithium batteries should not be charged in a battery charger as they may explode.
- Lithium batteries incorporate internal safety switches. When the battery becomes hot, its safety circuit is activated, cutting off power. This often occurs when the SB-28 is operated in the repeating flash mode. The flash ready-light will not light up after firing approx. 24 exposures. However, battery power will recover when the temperature goes back to normal.

Notes on using rechargeable NiCd and Ni-MH batteries

- When recharging batteries, be sure to use the battery charger specified by the battery maker and read the instructions thoroughly. Recharging should be done in temperatures from 10° to 30°C (50° to 86°F).
- Do not recharge NiCd or Ni-MH batteries with their terminals reversed in the charger or before the batteries have cooled off sufficiently.
- Overcharging and excessive use may shorten battery life. Do not overcharge and be sure to turn the SB-28 off when not in use.
- Because flash consumes a large amount of battery power, rechargeable batteries may not operate properly before reaching the end of their stated life-span or the number of charging/discharging as specified by the battery manufacturer.
- If NiCd or Ni-MH batteries do not last as long as they should after being fully charged, they are approaching the end of their life. Replace them with a new set.

Troubleshooting

Camera Group	Warning indicator	Cause	Ref. page
All camera groups	No  indicator appears.	• Batteries are not correctly installed.	12
		• Battery power is weak.	16
		• Standby function is set and operating.	15
	Ready-light blinks for approx. 3 sec. after shooting.	Flash fired at full output but light may have been insufficient.	16
	Power turns off.	Batteries are exhausted.	—
	No indicator bars -- appear.	SB-28's flash head is tilted or rotated from the horizontal/front position.	13
	Indicator bars -- blink.	Flash head is tilted down -7°.	13
Group I	No  indicators light up.	• A Nikkor lens other than one having built-in CPU is mounted.	26
		• Flash mode is set to  .	26
		• F5's or F100's Metering System is set to Spot Metering	26
	Ready-light and  blink after picture is taken.	Light was insufficient for correct exposure.	28
	  indicators and small M above the ZOOM as well as 18 or 20 blink.	Built-in wide flash adapter is used in FP High-Speed Flash sync.	51
	 blinks.	SB-28 is removed with  setting.	51
Group II	No   indicators light up.	• A Nikkor lens without a built-in CPU is mounted.	31
		• Flash mode is set to  .	31
		• F4's Metering System is not set to Spot Metering.	31

NOTE

The SB-28 incorporates a microcomputer to control flash operations. In rare cases, the SB-28 may not work properly even after fresh batteries are properly installed. If this happens, replace the batteries with the SB-28's power turned on.

Warning indications

The flash ready-light in the camera's viewfinder will blink:



F90X/N90s viewfinder display is shown.

Cameras in Groups I (except F70-Series/N70), II, III, V and VI.

—in the **III** mode, when you press the shutter release button halfway, to warn that the SB-28 has not been securely mounted on the camera or that the flash output may have been insufficient for correct exposure.

Cameras in Groups V and VI

—in the **III** mode, to indicate that the ISO rating of the film in use is higher than the ISO set on the SB-28's LCD panel, (or lower in the case of the FA camera).

Cameras in Group VI

—in the **III** mode, when the shutter speed is set to M90, M250, or B.

Cameras in Group VII

—to warn that **III** flash shooting is not possible.

































FM3A, New FM2

—when the shutter speed set is faster than the flash sync speed.

Specifications







Electronic construction	Automatic Insulated Gate Bipolar Transistor (IGBT) and series circuitry.								
Guide number	(ISO 100, m/ft)								
	Flash output level	Zoom-head position							
		18mm	20mm	24mm	28mm	35mm	50mm	70mm	85mm
	1/1 (full)	18/59	20/66	30/98	32/105	36/118	42/138	48/157	50/164
	1/2	12.7/42	14/46	21/69	22.5/74	25.5/84	30/98	34/112	36/118
	1/4	9/30	10/33	15/49	16/53	18/59	21/69	24/79	25/82
	1/8	6.4/21	7/23	10.5/35	11.3/37	12.7/42	15/49	17/56	18/59
	1/16	4.5/15	5/16	7.5/25	8/26	9/30	10.5/35	12/39	12.7/42
	1/32	3.2/10	3.5/11	5.3/17	5.7/19	6.4/21	7.5/25	8.5/28	9/30
	1/64	2.3/8	2.5/8	3.8/13	4/13	4.5/15	5.3/17	6.0/20	6.3/21
<ul style="list-style-type: none"> • See page 51 for details on guide numbers in FP High-Speed Sync Flash and see also page 30 for details on guide numbers in 1/300 TTL High-Speed Sync Flash. 									
Angle of coverage	(Variable in 6 steps, plus 2-steps with built-in wide flash adapter)								
	Flash head in horizontal/front position								
	Zoom-head position	Angle of coverage							
		Vertical	Horizontal						
	18mm (with built-in wide flash adapter in place)	90°				102°			
	20mm (with built-in wide flash adapter in place)	85°				98°			
	24mm	60°				78°			
	28mm	53°				70°			
	35mm	45°				60°			
	50mm	34°				46°			
70mm	26°				36°				
85mm	23°				31°				

Specifications

Flash duration (approx.)	1/840 sec. @ 1/1 (full) output 1/1100 sec. @ 1/2 output 1/2300 sec. @ 1/4 output 1/4800 sec. @ 1/8 output 1/9100 sec. @ 1/16 output 1/19000 sec. @ 1/32 output 1/28000 sec. @ 1/64 output																									
Bounce capability	Flash head tilts down to -7° or up to 90° with click-stops at -7° , 45° , 60° , 75° , 90° ; flash head rotates horizontally 180° to the left with click-stops at 30° , 60° , 90° , 120° , 150° , 180° and 90° to the right with click stops at 30° , 60° , 90°																									
ON/OFF button	Press the ON/OFF button for approx. 0.5 sec. to turn the SB-28 on or off. When the SB-28 is not used for approx. 80 sec. the SB-28 automatically turns itself off to conserve battery power. To turn the SB-28 back on, press the ON/OFF button.																									
Flash exposure control	<table border="1"> <thead> <tr> <th data-bbox="314 623 539 656">Selected by (MODE) button</th> <th data-bbox="539 623 948 656">Available flash operation</th> </tr> </thead> <tbody> <tr> <td data-bbox="314 656 539 700"></td> <td data-bbox="539 656 948 700"> <ul style="list-style-type: none"> Automatic Balanced Fill-Flash with TTL Multi Sensor with Nikkor lenses with built-in CPU (for cameras in Group I only) with Monitor Preflash </td> </tr> <tr> <td data-bbox="314 700 539 744"></td> <td data-bbox="539 700 948 744"> <ul style="list-style-type: none"> Matrix Balanced Fill-Flash or CenterWeighted Fill-Flash/ Spot Fill-Flash (for cameras in Groups I through IV. The  indicator appears when used with cameras in Groups I and II only.) </td> </tr> <tr> <td data-bbox="314 744 539 787"></td> <td data-bbox="539 744 948 787"> <ul style="list-style-type: none"> Standard TTL Flash (for cameras in Groups I through VI) </td> </tr> <tr> <td data-bbox="314 787 539 831"></td> <td data-bbox="539 787 948 831"> <ul style="list-style-type: none"> 1/300 TTL High-Speed Flash (for F5 only) </td> </tr> <tr> <td data-bbox="314 831 539 875"></td> <td data-bbox="539 831 948 875">Non-TTL Auto Flash</td> </tr> <tr> <td data-bbox="314 875 539 918"></td> <td data-bbox="539 875 948 918"> <ul style="list-style-type: none"> Manual Flash </td> </tr> <tr> <td data-bbox="314 918 539 962"></td> <td data-bbox="539 918 948 962"> <ul style="list-style-type: none"> Flash output setting (7 steps): 1/1, 1/2, 1/4, 1/8, 1/16, 1/32, 1/64 (in increments of $\pm 1/3$ steps) </td> </tr> <tr> <td data-bbox="314 962 539 1006"></td> <td data-bbox="539 962 948 1006"> <ul style="list-style-type: none"> High-Speed Sync Flash (for cameras in Group I [except F70-Series/N70]) </td> </tr> <tr> <td data-bbox="314 1006 539 1049"></td> <td data-bbox="539 1006 948 1049">Repeating Flash</td> </tr> <tr> <td data-bbox="314 1049 539 1093">Rear-curtain sync flash</td> <td data-bbox="539 1049 948 1093">Setting is possible in TTL, A, or M mode on cameras featuring rear-curtain sync flash mode by setting camera's flash sync mode to rear-curtain sync.</td> </tr> <tr> <td data-bbox="314 1093 539 1137">Red-eye reduction</td> <td data-bbox="539 1093 948 1137">Setting is possible on cameras having red-eye reduction or red-eye reduction in slow-sync. (When set,  indicator appears in the LCD panel.)</td> </tr> </tbody> </table>		Selected by (MODE) button	Available flash operation		<ul style="list-style-type: none"> Automatic Balanced Fill-Flash with TTL Multi Sensor with Nikkor lenses with built-in CPU (for cameras in Group I only) with Monitor Preflash 		<ul style="list-style-type: none"> Matrix Balanced Fill-Flash or CenterWeighted Fill-Flash/ Spot Fill-Flash (for cameras in Groups I through IV. The  indicator appears when used with cameras in Groups I and II only.) 		<ul style="list-style-type: none"> Standard TTL Flash (for cameras in Groups I through VI) 		<ul style="list-style-type: none"> 1/300 TTL High-Speed Flash (for F5 only) 		Non-TTL Auto Flash		<ul style="list-style-type: none"> Manual Flash 		<ul style="list-style-type: none"> Flash output setting (7 steps): 1/1, 1/2, 1/4, 1/8, 1/16, 1/32, 1/64 (in increments of $\pm 1/3$ steps) 		<ul style="list-style-type: none"> High-Speed Sync Flash (for cameras in Group I [except F70-Series/N70]) 		Repeating Flash	Rear-curtain sync flash	Setting is possible in TTL , A , or M mode on cameras featuring rear-curtain sync flash mode by setting camera's flash sync mode to rear-curtain sync.	Red-eye reduction	Setting is possible on cameras having red-eye reduction or red-eye reduction in slow-sync. (When set,  indicator appears in the LCD panel.)
Selected by (MODE) button	Available flash operation																									
	<ul style="list-style-type: none"> Automatic Balanced Fill-Flash with TTL Multi Sensor with Nikkor lenses with built-in CPU (for cameras in Group I only) with Monitor Preflash 																									
	<ul style="list-style-type: none"> Matrix Balanced Fill-Flash or CenterWeighted Fill-Flash/ Spot Fill-Flash (for cameras in Groups I through IV. The  indicator appears when used with cameras in Groups I and II only.) 																									
	<ul style="list-style-type: none"> Standard TTL Flash (for cameras in Groups I through VI) 																									
	<ul style="list-style-type: none"> 1/300 TTL High-Speed Flash (for F5 only) 																									
	Non-TTL Auto Flash																									
	<ul style="list-style-type: none"> Manual Flash 																									
	<ul style="list-style-type: none"> Flash output setting (7 steps): 1/1, 1/2, 1/4, 1/8, 1/16, 1/32, 1/64 (in increments of $\pm 1/3$ steps) 																									
	<ul style="list-style-type: none"> High-Speed Sync Flash (for cameras in Group I [except F70-Series/N70]) 																									
	Repeating Flash																									
Rear-curtain sync flash	Setting is possible in TTL , A , or M mode on cameras featuring rear-curtain sync flash mode by setting camera's flash sync mode to rear-curtain sync.																									
Red-eye reduction	Setting is possible on cameras having red-eye reduction or red-eye reduction in slow-sync. (When set,  indicator appears in the LCD panel.)																									

Power source	Four AA-type alkaline-manganese (1.5V), lithium (1.5V), NiCd (rechargeable) (1.2V), or Ni-MH (rechargeable) (1.2V) penlight batteries.																																								
Optional external power sources	<ul style="list-style-type: none"> • DC Unit SD-7; uses six C-type alkaline-manganese batteries • DC Unit SD-8/8A; uses six AA-type alkaline-manganese batteries • Power Bracket Unit (SK-6/6A); uses four AA-type alkaline-manganese batteries (The SD-7, SD-8 and SK-6 not compatible with European version of the SB-28.) <table border="1" data-bbox="280 467 915 1089"> <thead> <tr> <th></th> <th>Battery type required</th> <th>Min. recycling time* (approx.)</th> <th>Min. number of flashes/ recycling time (approx.)</th> </tr> </thead> <tbody> <tr> <td>External power source SD-7**</td> <td>C-type alkaline-manganese (x6)</td> <td>2.5 sec.</td> <td>200 times/6 sec. 400 times/6-10 sec. 450 times/6-30 sec.</td> </tr> <tr> <td rowspan="5">External power source SD-8/8A***</td> <td>AA-type alkaline-manganese (x6)</td> <td>3.5 sec.</td> <td>100 times/3.5-5 sec. 200 times/3.5-9 sec. 350 times/6-30 sec.</td> </tr> <tr> <td>AA-type NiCd (700 mAh) (x6)</td> <td rowspan="2">2 sec.</td> <td>150 times/2-30 sec.</td> </tr> <tr> <td>AA-type NiCd (1000 mAh) (x6)</td> <td>200 times/2-30 sec.</td> </tr> <tr> <td>AA-type Ni-MH (x6)</td> <td>2.5 sec.</td> <td>200 times/2.5-30 sec</td> </tr> <tr> <td>AA-type lithium (x6)</td> <td>3.5 sec.</td> <td>350 times/3.5-30 sec.</td> </tr> <tr> <td rowspan="5">Power Bracket SK-6/6A***</td> <td>AA-type Alkaline-manganese (x4)</td> <td>4 sec.</td> <td>250 times/4-30 sec.</td> </tr> <tr> <td>AA-type NiCd (700mAh) (x4)</td> <td rowspan="2">2.5 sec.</td> <td>100 times/2.5-30 sec.</td> </tr> <tr> <td>AA-type NiCd (1000mAh) (x4)</td> <td>140 times/2.5-30 sec.</td> </tr> <tr> <td>AA-type Ni-MH(x4)</td> <td>3.0 sec.</td> <td>140 times/3.0-30 sec.</td> </tr> <tr> <td>AA-type lithium (x4)</td> <td>4.5 sec.</td> <td>300 times/4.5-30 sec.</td> </tr> </tbody> </table> <p data-bbox="280 1096 886 1246"> * With fresh batteries ** With AA-type alkaline-manganese in the SB-28 ***With same type of batteries in both the external power source and the SB-28 • Above data may vary depending on the performance or type of batteries. </p>				Battery type required	Min. recycling time* (approx.)	Min. number of flashes/ recycling time (approx.)	External power source SD-7**	C-type alkaline-manganese (x6)	2.5 sec.	200 times/6 sec. 400 times/6-10 sec. 450 times/6-30 sec.	External power source SD-8/8A***	AA-type alkaline-manganese (x6)	3.5 sec.	100 times/3.5-5 sec. 200 times/3.5-9 sec. 350 times/6-30 sec.	AA-type NiCd (700 mAh) (x6)	2 sec.	150 times/2-30 sec.	AA-type NiCd (1000 mAh) (x6)	200 times/2-30 sec.	AA-type Ni-MH (x6)	2.5 sec.	200 times/2.5-30 sec	AA-type lithium (x6)	3.5 sec.	350 times/3.5-30 sec.	Power Bracket SK-6/6A***	AA-type Alkaline-manganese (x4)	4 sec.	250 times/4-30 sec.	AA-type NiCd (700mAh) (x4)	2.5 sec.	100 times/2.5-30 sec.	AA-type NiCd (1000mAh) (x4)	140 times/2.5-30 sec.	AA-type Ni-MH(x4)	3.0 sec.	140 times/3.0-30 sec.	AA-type lithium (x4)	4.5 sec.	300 times/4.5-30 sec.
	Battery type required	Min. recycling time* (approx.)	Min. number of flashes/ recycling time (approx.)																																						
External power source SD-7**	C-type alkaline-manganese (x6)	2.5 sec.	200 times/6 sec. 400 times/6-10 sec. 450 times/6-30 sec.																																						
External power source SD-8/8A***	AA-type alkaline-manganese (x6)	3.5 sec.	100 times/3.5-5 sec. 200 times/3.5-9 sec. 350 times/6-30 sec.																																						
	AA-type NiCd (700 mAh) (x6)	2 sec.	150 times/2-30 sec.																																						
	AA-type NiCd (1000 mAh) (x6)		200 times/2-30 sec.																																						
	AA-type Ni-MH (x6)	2.5 sec.	200 times/2.5-30 sec																																						
	AA-type lithium (x6)	3.5 sec.	350 times/3.5-30 sec.																																						
Power Bracket SK-6/6A***	AA-type Alkaline-manganese (x4)	4 sec.	250 times/4-30 sec.																																						
	AA-type NiCd (700mAh) (x4)	2.5 sec.	100 times/2.5-30 sec.																																						
	AA-type NiCd (1000mAh) (x4)		140 times/2.5-30 sec.																																						
	AA-type Ni-MH(x4)	3.0 sec.	140 times/3.0-30 sec.																																						
	AA-type lithium (x4)	4.5 sec.	300 times/4.5-30 sec.																																						

Specifications

Number of flashes and recycling times at full output (with batteries installed in the SB-28)	Batteries	Min. recycling time (approx.)	Min. number of flashes/ recycling time (approx.)
	4 AA-type alkaline-manganese	6.5 sec.	150/6.5-30 sec.
	4 AA-type NiCd (700 mAh)	4 sec.	60/4-30 sec.
	4 AA-type NiCd (1000 mAh)		90/4-30 sec.
	4 AA-type Ni-MH		100/4-30 sec.
	4 AA-type lithium	7.5 sec.	200/8-30 sec.
Note: Data measured with fresh batteries, but without using AF assist LED, zoom-head position adjustment, or LCD panel illumination.			
Red-eye reduction	The red-eye reduction LED lights up for approx. 1 sec. before the flash fires. This function is set on the camera. Applicable to cameras in Group I (except F5) and Pronea 600i/6i.		
AF assist illumination	Automatically fires LED beam toward subject when performing autofocus in dim light or in the dark with Nikon AF cameras. Can be canceled.		
Ready-light	<ul style="list-style-type: none"> Lights up when SB-28 is recycled and ready to fire. Blinks for 3 seconds when flash fires at its maximum output, indicating light may have been insufficient (in TTL Auto Flash  and  mode only). 		
FLASH button	<ul style="list-style-type: none"> Performs test firing for correct exposure detection in  mode or test firing in  mode. Can turn the SB-28 on again after the unit enters standby mode. 		
Built-in wide flash adapter	Allows the SB-28 to be used with 18mm or 20mm lenses.		
Safety lock system	With cameras equipped with a safety lock system, the mount pin is automatically inserted into the locking hole in the camera's accessory shoe to secure the SB-28.		
LCD panel illuminator	Turns on and off every time the  button is pressed. Illumination lasts approx. 16 seconds.		
Flash shooting distance scale	Distance scale on the LCD panel can be set to either meters (m) or feet (ft) by pressing the  and  buttons simultaneously with SB-28 turned off.		

Other features	External power source terminal, TTL multiple flash terminal, and sync/multiple flash terminal.
Dimensions (W x H x D)	Approx. 69 x 128 x 90mm (2.7 x 5 x 3.6 in.)
Weight (without batteries)	Approx. 320g (11.3 oz.)
Accessories supplied	Soft Case SS-28, External power source terminal cap

All performance data are for normal-temperature operation (20°C/68°F)
 Specifications and design are subject to change without notice.

Usable aperture/flash shooting distance ranges in TTL Auto and Non-TTL Auto flash modes

ISO film speed							Shooting distance range (in meters)									
1600*1	800*2	400	200	100	50	25	18mm	20mm	24mm	28mm	35mm	50mm	70mm	85mm		
2.8	2	1.4					2.3-20	2.5-20	3.8-20	4.0-20	4.5-20	5.3-20	6.0-20	6.3-20		
4	2.8	2	1.4				1.6-18	1.8-20	2.7-20	2.9-20	3.2-20	3.8-20	4.3-20	4.5-20		
5.6	4	2.8	2	1.4			1.2-12	1.3-14	1.9-20	2.0-20	2.3-20	2.7-20	3.0-20	3.2-20		
8	5.6	4	2.8	2	1.4		0.8-9.0	0.9-10	1.4-15	1.5-16	1.6-18	1.9-20	2.2-20	2.2-20		
11	8	5.6	4	2.8	2	1.4	0.6-6.3	0.7-7.0	1.0-10	1.0-11	1.2-12	1.4-14	1.5-16	1.6-17		
16	11	8	5.6	4	2.8	2	0.6-4.5	0.6-5.0	0.7-7.5	0.7-8.0	0.8-9.0	1.0-10	1.1-12	1.1-12		
22	16	11	8	5.6	4	2.8	0.6-3.1	0.6-3.5	0.6-5.3	0.6-5.6	0.7-6.3	0.7-7.4	0.8-8.4	0.8-8.8		
32	22	16	11	8	5.6	4	0.6-2.2	0.6-2.5	0.6-3.7	0.6-4.0	0.6-4.5	0.6-5.2	0.6-6.0	0.6-6.2		
	32	22	16	11	8	5.6	0.6-1.5	0.6-1.7	0.6-2.6	0.6-2.8	0.6-3.1	0.6-3.7	0.6-4.2	0.6-4.4		
		32	22	16	11	8	0.6-1.1	0.6-1.2	0.6-1.8	0.6-2.0	0.6-2.2	0.6-2.6	0.6-3.0	0.6-3.1		
			32	22	16	11	0.6-0.7	0.6-0.8	0.6-1.3	0.6-1.4	0.6-1.5	0.6-1.8	0.6-2.1	0.6-2.2		
				32	22	16		0.6	0.6-0.9	0.6-1.0	0.6-1.1	0.6-1.3	0.6-1.5	0.6-1.5		

 : Programmed TTL Auto Flash with Nikon F-501/N2020, F-401s/N4004s, F-401/N4004 and F-301/N2000. (ISO 25 to ISO 400 for F-401s/N4004s, F-401/N4004)

 : Non-TTL Auto Flash mode

*1: TTL Auto Flash  operation is not possible at this film speed.

*2: TTL Auto Flash  is possible for cameras in Groups I to IV and F-501/N2020 and F-301/N2000. For ISO 1000, use an aperture 1/3 of an f/stop smaller than the aperture for ISO 1600.

• Usable apertures in the TTL Auto Flash  mode are f/1.4 to f/32, and the usable shooting distance range is 0.6 to 20m.

Specifications

ISO film speed							Shooting distance range (in feet)							
1600*1	800*2	400	200	100	50	25	18mm	20mm	24mm	28mm	35mm	50mm	70mm	85mm
2.8	2	1.4					7.4-66	8.2-66	13-66	14-66	15-66	18-66	20-66	21-66
4	2.8	2	1.4				5.3-59	5.8-65	8.7-66	9.3-66	11-66	13-66	14-66	15-66
5.6	4	2.8	2	1.4			3.7-41	4.1-46	6.2-66	6.6-66	7.4-66	8.7-66	9.9-66	11-66
8	5.6	4	2.8	2	1.4		2.6-29	2.9-32	4.4-49	4.7-52	5.2-59	6.1-66	7.0-66	7.2-66
11	8	5.6	4	2.8	2	1.4	2.0-20	2.1-23	3.1-34	3.3-37	3.7-41	4.3-48	4.9-55	5.1-57
16	11	8	5.6	4	2.8	2	2.0-14	2.0-16	2.2-24	2.4-26	2.6-29	3.0-34	3.5-39	3.6-41
22	16	11	8	5.6	4	2.8	2.0-10	2.0-11	2.0-17	2.0-18	2.0-20	2.2-24	2.5-27	2.6-28
32	22	16	11	8	5.6	4	2.0-7.3	2.0-8.2	2.0-12	2.0-13	2.0-14	2.0-17	2.0-19	2.0-20
	32	22	16	11	8	5.6	2.0-5.2	2.0-5.7	2.0-8.6	2.0-9.2	2.0-10	2.0-12	2.0-13	2.0-14
		32	22	16	11	8	2.0-3.6	2.0-4.1	2.0-6.1	2.0-6.5	2.0-7.3	2.0-8.6	2.0-9.8	2.0-10
			32	22	16	11	2.0-2.6	2.0-2.8	2.0-4.3	2.0-4.6	2.0-5.2	2.0-6.0	2.0-6.9	2.0-7.2
				32	22	16	2.0	2.0-2.0	2.0-3.0	2.0-3.2	2.0-3.6	2.0-4.3	2.0-4.9	2.0-5.1

 : Programmed TTL Auto Flash with Nikon F-501/N2020, F-401s/N4004s, F-401/N4004 and F-301/N2000. (ISO 25 to ISO 400 for F-401s/N4004s, F-401/N4004)

 : Non-TTL Auto Flash mode

*1: TTL Auto Flash  operation is not possible at this film speed.

*2: TTL Auto Flash  is possible for cameras in Groups I to IV and F-501/N2020 and F-301/N2000. For ISO 1000, use an aperture 1/3 of an f/stop smaller than the aperture for ISO 1600.

- Usable apertures in the TTL Auto Flash  mode are f/1.4 to f/32, and the usable shooting distance range is 2.0 to 66 ft.

No reproduction in any form of this manual, in whole or in part (except for brief quotation in critical articles or reviews), may be made without written authorization from NIKON CORPORATION.

Nikon

NIKON CORPORATION

FUJI BLDG., 2-3, MARUNOUCHI 3-CHOME,
CHIYODA-KU, TOKYO 100-8331, JAPAN

Free Manuals Download Website

<http://myh66.com>

<http://usermanuals.us>

<http://www.somanuals.com>

<http://www.4manuals.cc>

<http://www.manual-lib.com>

<http://www.404manual.com>

<http://www.luxmanual.com>

<http://aubethermostatmanual.com>

Golf course search by state

<http://golfingnear.com>

Email search by domain

<http://emailbydomain.com>

Auto manuals search

<http://auto.somanuals.com>

TV manuals search

<http://tv.somanuals.com>