

OLYMPUS®

AZ-4 ZOOM

■ INSTRUCTIONS

Thank you for purchasing the Olympus AZ-4 Zoom. The AZ-4 Zoom is a totally new handgrip type single lens reflex camera in the full-size 35mm format. It is equipped with a 35 ~ 135mm zoom lens and, of course, focus is fully automated. Furthermore, the camera is extremely compact and easy-to-use, with features that give added flexibility including spot metering, fill-in flash, program shift, exposure compensation, double exposure, and a continuous shooting mode. With the AZ-4 Zoom, everyone can enjoy photography, from snapshots and portraiture to advanced techniques.

Before using the camera, please study this instruction manual carefully with the AZ-4 Zoom in front of you, to get the very best performance and longest service life from your new camera.

1

Symbols used in this manual



Correct



Incorrect



Operation



Operation order



Automatic operation



Attention



Presslightly



Lamp on



Lampblinking

TABLE OF CONTENTS

Preparations before taking pictures.....	3	Taking photographs III.....	33
Loading batteries.....	4	Flash auto photography.....	34
Checking the batteries.....	5	Using fill-in flash.....	36
Taking photographs I.....	6	Using an exterior flash attachment	38
Loading the film.....	7	Attaching a shoulder strap.....	39
Taking photographs.....	10	In order to take even better	
Unloading the film.....	16	photographs.....	40
Taking photographs II.....	18	Auto focus (AF).....	43
Using the focus lock.....	19	Exposure.....	45
Taking a continuous series of shots	20	Viewfinder displays.....	46
Using the self-timer.....	21	LCD panel and mode buttons.....	47
How to use the manual focus.....	23	For long-lasting enjoyment of your	
Macro photography.....	24	AZ-4 Zoom.....	48
Exposure compensation.....	26	Care and storage.....	49
Spot metering.....	27	Questions and answers.....	51
Program shift.....	29	Description of controls.....	53
Double-exposure photography.....	30	Specifications.....	55
Using the RESET button.....	32	Accessories sold separately.....	57



Preparations before Taking Pictures

Loading Batteries

Do not use incorrect batteries or mix new and old batteries at the same time.
Before replacing batteries, set the power switch to OFF.
Please remove the batteries from your camera during long periods in which the camera is not in use.

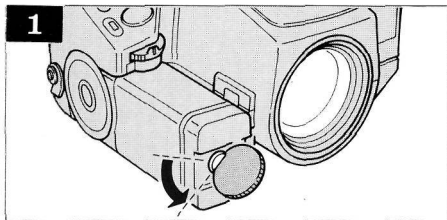

Turn the lock screw on the bottom of the grip with a coin as shown to remove the battery case lid.

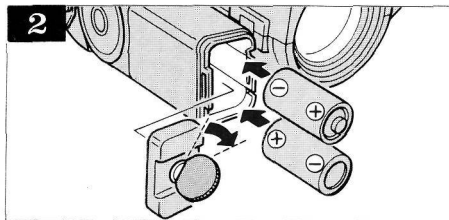

Insert the batteries correctly as shown and replace the lid using a coin to turn the screw. Use two 3V Lithium batteries (Panasonic CR-123A or Duracell DL-123A batteries.)
* Try to avoid changing batteries while the film is still in the camera. (With the batteries removed the film counter indicator will remain active for approximately 30 minutes.)

Checking the Batteries

5

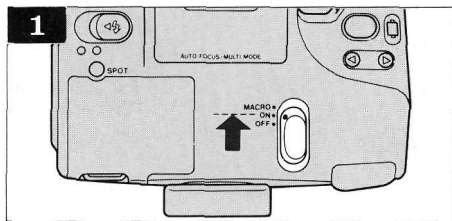

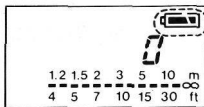

Slide the power switch ON.

* In order to conserve power, the LCD panel and the finder indicator will shut off automatically after approximately 15 sec. Lightly pressing the shutter release button will reactivate the panel and indicator.



The charge remaining in the batteries will be displayed on the LCD panel.

When  is displayed for 2 sec., the batteries are OK.

When  blinks, excess battery consumption is occurring. The batteries should be replaced as soon as possible.

When the outer frame  is blinking, the flash cannot be used.

* When  is indicated, the batteries have reached their expected life span and should be replaced immediately.



Taking Photographs I

With the AZ-4 Zoom, anyone can take photographs easily using a variety of techniques. This section explains the basics of photography.

Loading the Film

Film-loading and film-speed selection (ISO) for DX film is automatic in this camera.

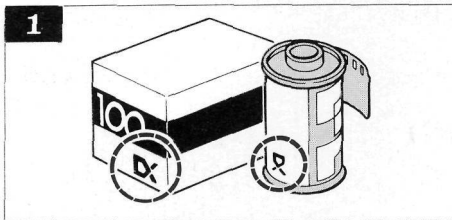

Use a DX type film. Your camera will automatically set itself for DX-coded film speeds ranging from ISO 25 to 5000.

* In case of non-DX film, film speed is automatically set at ISO 100.

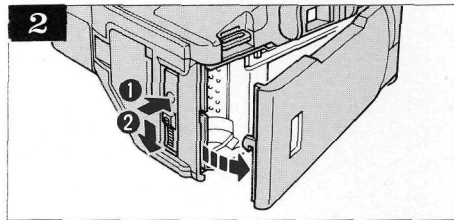

Depress the film compartment cover lock release button ① and slide the cover latch down to open ②.

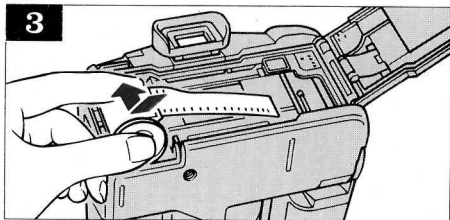

Insert the film cartridge. Always avoid direct sunlight when loading the film.

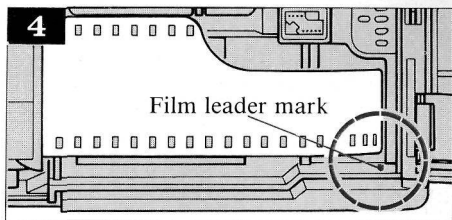

Align the film leader with the green mark.

NO
X

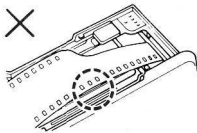

NO
X

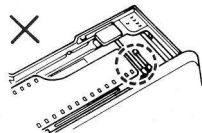

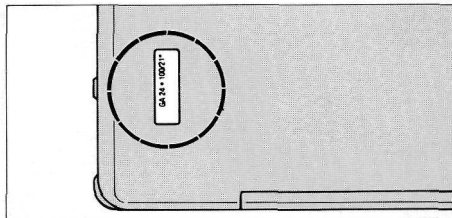
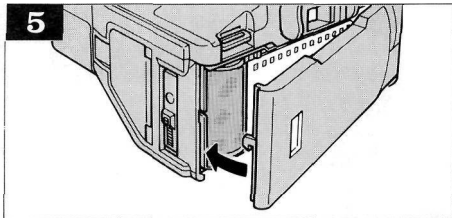

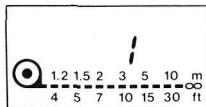

9

Close the camera back.
The film is automatically wound until the exposure counter reads 1.



* If the film is wound incorrectly, the  will blink and the shutter release will not operate. In this case, open the film compartment cover and load the film again.

Film type confirmation: This is possible through the window in the camera back.

* When using a non-DX film, if the film is not wound correctly, the number indicator in the LCD panel will stop on 0. The  indication will not appear in the LCD and the shutter release may not lock.

Taking Photographs

Preparations

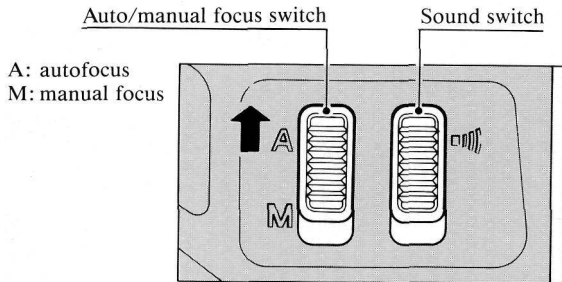

Under normal operation conditions, set the switch to A for autofocus. When you wish to set the focus manually, set the switch to M. (See p. 23)

When this camera is in focus, and when the last frame of film has been exposed, you will hear a "beep-beep" sound signaling these conditions. In order to turn off this sound, slide the sound switch to the down position.

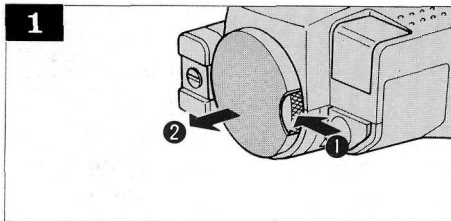

Remove the lens cap.

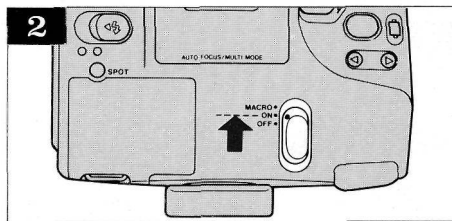

Slide the power switch to ON and the lens will extend from the camera body.

* Use the MACRO position for taking photos of objects nearby. (See p. 24)

* With the switch in the OFF position, the Viewfinder will become dark.

11

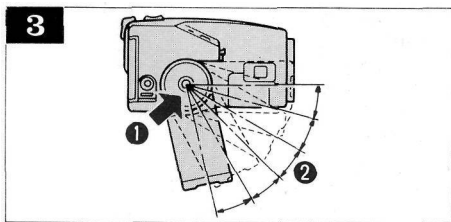

Adjust the grip angle.

* The grip angle can be adjusted ② by moving the grip as you push the grip lock release button ①.

The grip adjusts to 6 different angles at 15° increments.

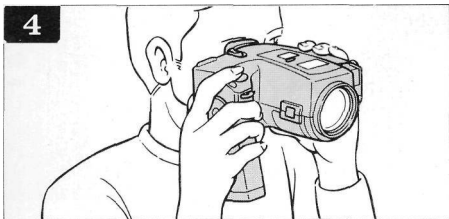

While looking through the Viewfinder, aim the camera at the subject you want to shoot.

* When the shutter speed indicator blinks in the Viewfinder, change to the flash AUTO photography mode. (See p. 34)

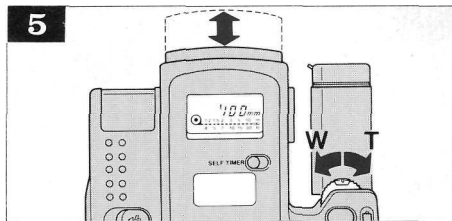
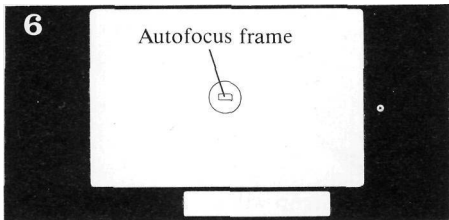

Adjust the zoom lever to the correct angle for the photo you wish to take.

* Be careful not to touch the lens surface with your finger.

Tele: long angle Wide: wide angle

* The LCD panel will indicate the lens focal length for two seconds after you stop zooming.

Move the camera so the subject is in the center of the autofocus frame.

* Be sure to keep the subject within the frame.

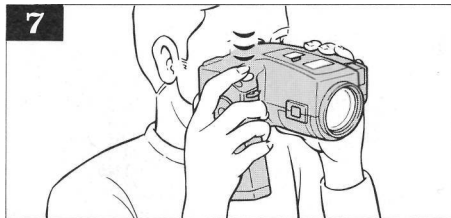

Press the shutter release button halfway to focus.

- 13
- * The button can be pressed in two steps; autofocus operates when the button is pressed to the first of these steps.
 - * When the camera is in focus, the green focus lamp comes on in the Viewfinder and you will hear the "beep-beep" sound.

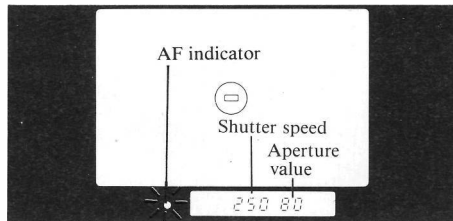
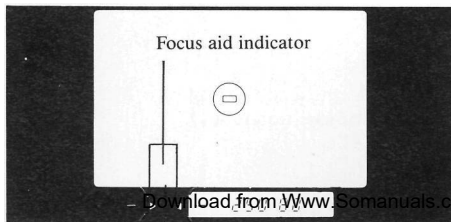

- * The shutter speed and the aperture will be indicated in the Viewfinder. (See p. 46)
- * When the shutter speed indicator is blinking, change to the flash mode. (See p. 34) If you do not use the flash in this case, the shutter speed may be too slow and it is recommended that you use a tripod to avoid the effects of camera shake.

- * If the camera is not in focus, the red focus-aid lamp will blink. In this case, push the shutter release button again.
- * The shutter cannot be released while the focus-aid indicator is blinking.

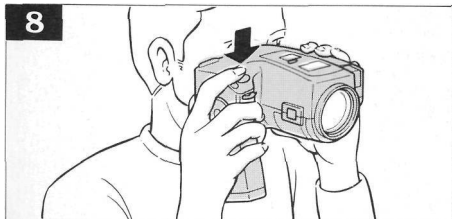

Press the shutter release button fully.

* Immediately after the shutter is released, the film is automatically wound by one frame, and the exposure counter advances by one.

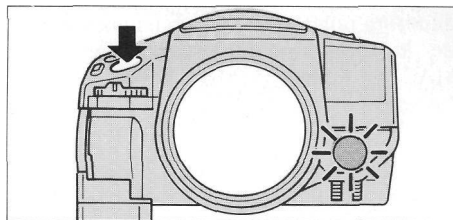
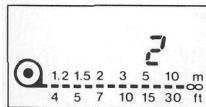
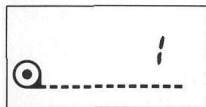

In dark places:

A red-colored light emerging from the AF illuminator aimed at your subject will provide extra illumination and allow for precise focus. (illumination distance: approx. 5.5m (18 ft))

Shooting range: Photos can be taken from a range of 1.2m (3.9 ft.) to infinity. When the  is blinking in the Viewfinder, the camera is too close to the subject. Switch to the MACRO mode.

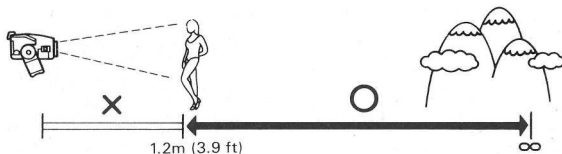

15

Aim correctly: Be careful not to touch the lens, flash or AF Illuminator.

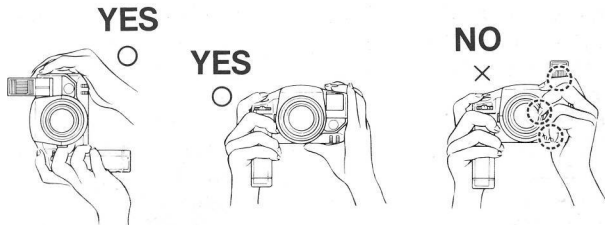

As the focal distance increases, the possibilities of the camera shake also increase. Grip the camera tightly with your right hand as you aim in order to avoid any shaking. If you use the shoulder strap, make sure that it doesn't interfere with the flash or the lens.

Unloading the Film

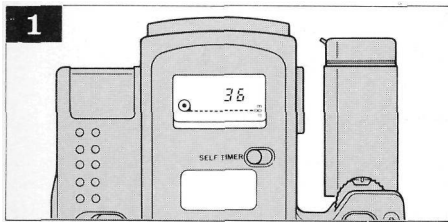

When you reach the end of the film, it will rewind automatically. You will hear the "beep-beep" sound indicating that the film has been rewound fully.

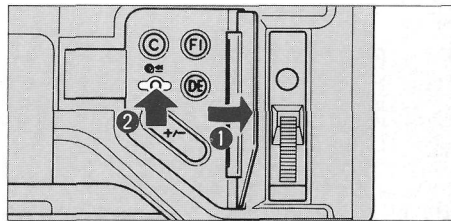
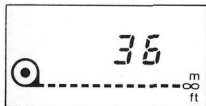

If you want to rewind the film in the middle of a roll, open the mode cover and press the rewind button.

* The final reading of the exposure counter prior to rewinding may be more than the number of exposures specified for the film.

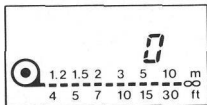
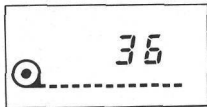

17

- * You will hear the "beep-beep" sound indicating that the film has been completely rewound and the exposure indicator will return to 0.
- * After the film has been rewound, the shutter cannot be released until the film has been removed.

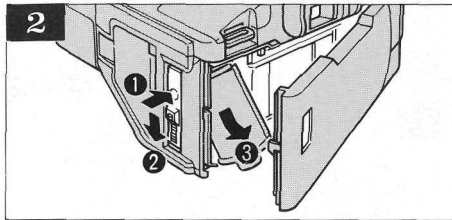

- Open the camera back, and remove the film.
- * In order to protect the shutter, the film is entirely rewound into the film canister.



Taking Photographs II

The AZ-4 Zoom is equipped with various functions that add greater versatility to photography. In this section, the operation of each of the camera's various features will be described, explaining how to use them most effectively.

Using the Focus Lock

For use when the subject is not in the center of the autofocus frame.

19



Center the subject within the autofocus frame.

Press the shutter release button lightly to lock focus on that subject.

* When focused, you will hear the "beep-beep" sound. The AF indicator will light in the Viewfinder.

The distance indicator appears in the LCD panel. (See p. 46)



Maintain the focus lock by keeping the release in this position and recompose the picture. Now fully depress the shutter release to take the picture.

Taking a Continuous Series of Shots

You can take pictures at the rate of 2 shots per second. When using the flash, the film will not be wound until the flash has finished charging.

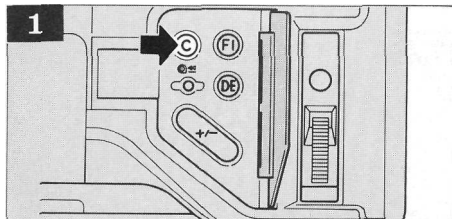

Push the continuous mode button under the mode cover, and the LCD panel will indicate C for this mode. C will appear in the LCD panel and it will blink.

* If you push the continuous mode button again, the C indication will disappear, and the camera will return to the single shot mode.

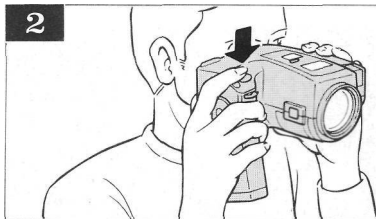
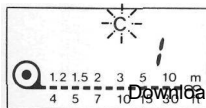

The camera will shoot repeatedly as long as the shutter release button is depressed.

* The focus will be locked to the settings corresponding to the first shot of the series, so be careful when shooting a moving subject or other subject where subject distance varies.

Using the Self-timer

The camera should be set firmly, on a tripod, for example.

21

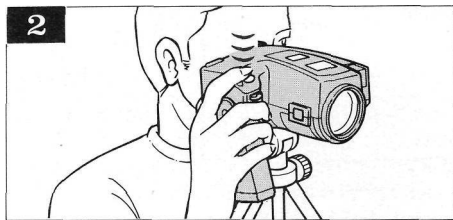
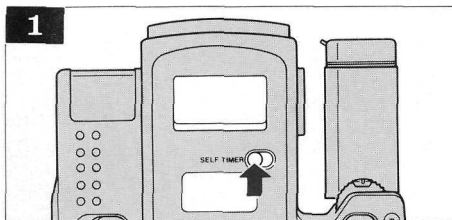

If you push the self-timer button, the ☀ will be indicated in the LCD panel. This ☀ will blink.

* If you push the self-timer button again, the ☀ indication will disappear and releasing the camera from the self-timer mode.

Press the shutter release button lightly, and focus on the subject you want to shoot.

* When focused, you will hear the "beep-beep" sound and the focus lamp will light in the Viewfinder.

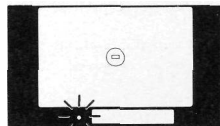
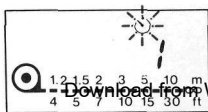

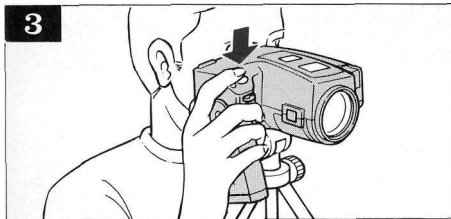

Press the shutter release button fully to start the self-timer.

* The self-timer lamp will blink and there will be a "beep-beep" sound indicating that the shutter will be engaged within 10 seconds. 2 seconds before the shutter is engaged, the self-timer lamp will remain on and the beeping sound will continue without interruption.

To avoid incorrect exposure in the self-timer mode, ensure that strong light does not enter through the Viewfinder before the self-timer mode is started.

* Once the shutter is released, the self-timer mode is disengaged.

The self-timer can be cancelled at any time before the shot is taken by performing any of the following operations:

- (1) Pressing the SELF-TIMER button
- (2) Sliding the power switch to OFF
- (3) Pressing the RESET button

How to Use the Manual Focus

Use it when the autofocus system cannot focus properly or when you prefer to focus the camera yourself. (See pg.44)

23

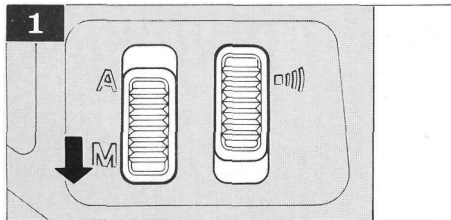

Slide the focus switch to the M position.

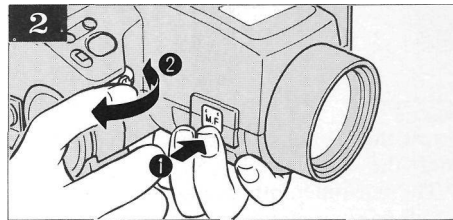

Adjust the focus by moving the zoom lever **2** as you press the manual focus button

1

* As you move the zoom lever towards the focus aid indicator in the Viewfinder, your subject will come into focus and the focus lamp will go on confirming correct focus.

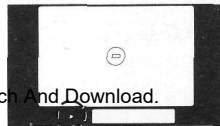

Macro Photography

You can take close-up photos at a distance of 0.49 ~ 1.2m (1.6 ~ 3.9 ft).
When using the MACRO mode, manual focusing is necessary.

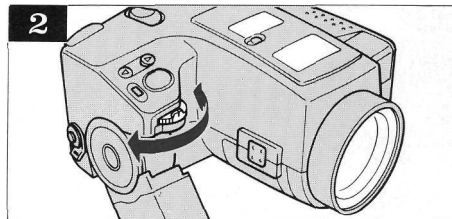
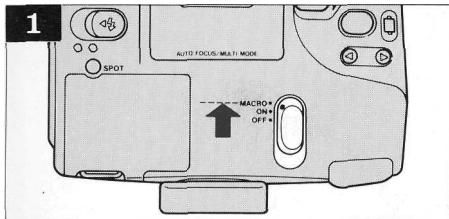

24

Move the power switch to the MACRO position.

* The  mark will light up in the Viewfinder.

Adjust the focus by aiming through the Viewfinder and moving the zoom lever. Release the shutter when your subject is in focus.

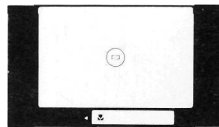
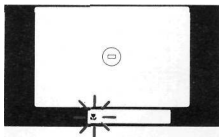

* As you move the zoom lever in the direction of the focus aid in the Viewfinder, the focus lamp will light when your picture is in focus.

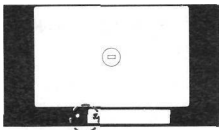

- * The autofocus does not work during macro photography.
- * In macro photography, zooming is not possible.
- * There is no need to press the manual focus button. Do not change the focus switch from the A position.

Exposure Compensation

You can adjust exposure to compensate for special lighting conditions and for special effects.

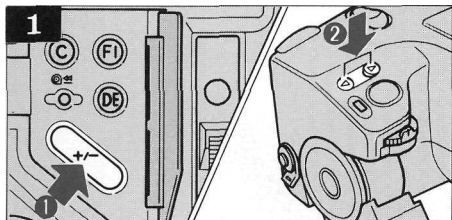

panel, you have set your exposure compensation.

- * The compensation varies between -4EV and +4EV in steps of 1/3EV every time the button is pressed.
- * During flash AUTO photography (See p. 34), exposure compensation is not possible.

26

As you press the exposure compensation button under the mode cover ① and the up-down button as illustrated simultaneously ②, and when your desired compensation is indicated in the LCD

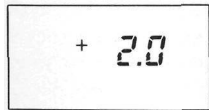

Spot Metering

You can set the exposure for critically lighted subjects. If the pop-up flash is not engaged, the activation of spot metering is especially effective.

27



Metering range

Move the camera so that the section to be metered is in the center of the Viewfinder.

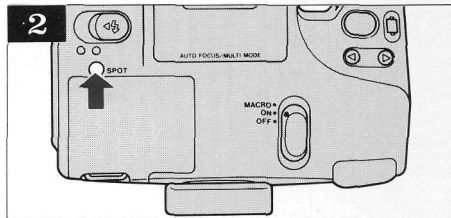
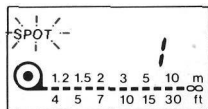

Press the SPOT button.

* The SPOT indicator blinks in the Viewfinder and the LCD panel, and the exposure (AE) is locked. If you remove your finger from the SPOT button, this exposure will be disengaged and it will return to normal operation. To use the focus lock jointly, simply press the release button lightly to the first stop. (Spot metering can be performed regardless of which button is pressed



Change the composition while pressing the SPOT button.

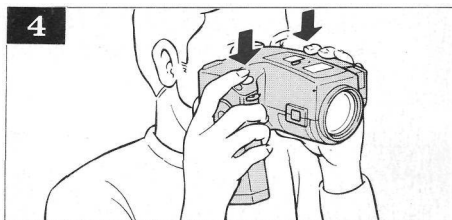

Press the shutter release button fully while keeping the SPOT button pressed.

* Spot metering will not be cancelled while the shutter release button is pressed half way, even if the SPOT button is released before the shutter is released.

28



The required subject will be exposed correctly without being affected by background illumination.

Program Shift

Allows you to adjust the effects of shutter speed (motion control) and aperture (depth of field control) without affecting overall exposure.

29

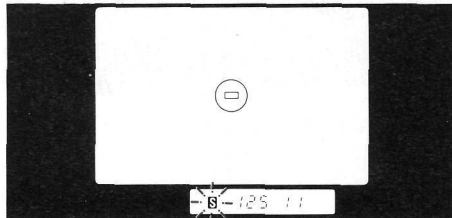
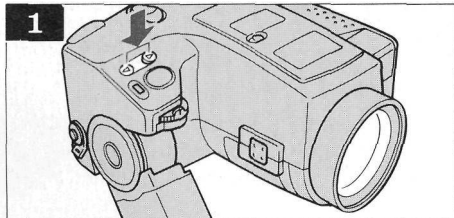

By pushing the Up-Down button, the aperture and shutter speeds will be displayed in the Viewfinder as they change. When you reach the desired combination, release the button to lock the aperture and speed.

With the power switch in OFF position, the program shift will be cancelled.

* The **S** mark will blink in the Viewfinder during your program shift.

To cancel the program shift, simply push the reset button.

* It is possible to use exposure compensation in conjunction with program shift. (See p. 26)

(for example:)

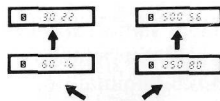

Double-exposure Photography

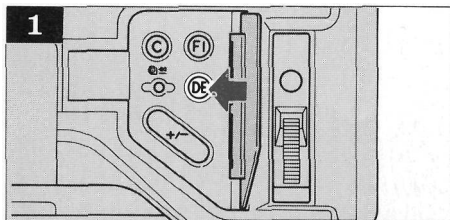

Press the DOUBLE EXPOSURE button inside the mode cover.

- * DOUBLE EXP. blinks in the LCD panel.
- Press it again for cancellation.

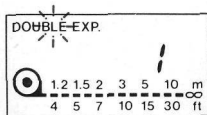

Determine the photographic composition for one frame. Press the shutter release button.

- * The DOUBLE EXP. starts blinking faster.
- The film will not be advanced to the next frame.

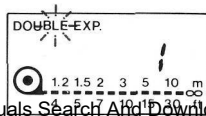

3



31

Determine the photographic composition for the second shot, and press the shutter release button.

* When the second exposure is finished, the film will be advanced to the next frame, and the DOUBLE EXP. will be cancelled.

* If you push the reset button after taking your first photo, the double exposure mode will be cancelled and the film will wind automatically.

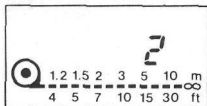

Using the RESET Button

If you have made a mistake in setting any controls, etc., press the Reset button to return to the standard shooting mode.

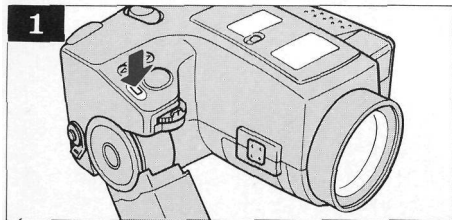

Press the RESET button.

Standard shooting mode	
Self-timer	:cancellation
Continuous series	:single frame
	:photography
Fill-in flash	:cancellation
Double exposure	:cancellation
Exposure compensation	:±0EV
Program shift	:cancellation



Taking Photographs III (Flash Photography)

The AZ-4 Zoom has an extended range of flash functions. This section explains these various functions.

Flash Auto Photography

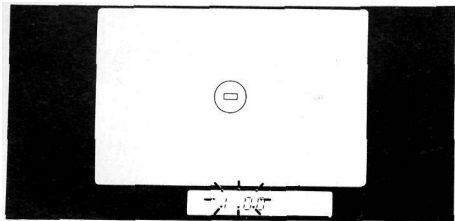

When the shutter speed indicator blinks in the Viewfinder, change to the flash photography mode.

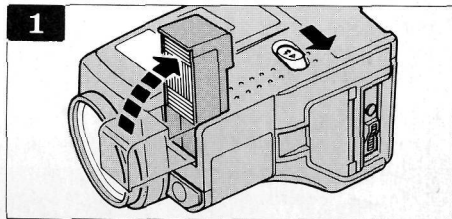

If you move the flash switch in the direction of the arrow, the flash will pop up and charging will commence.

* While the flash is being charged, the  mark will blink in the Viewfinder.

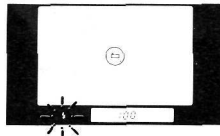

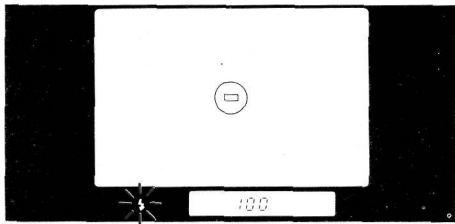

Once the flash is fully charged, the  mark will stay on and the shutter speed will be automatically adjusted to 1/100 of a second.

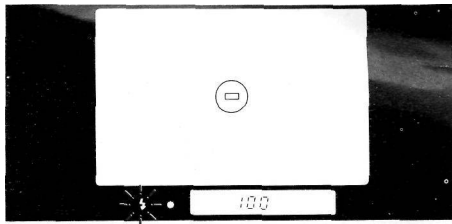

Press the shutter release button.

* As you lightly press the shutter release button, if your subject exceeds the distance of the flash potential, the  mark will start to blink. In this case, you should move closer to your subject.

Shooting range guide:

ISO	WIDE	TELE
100	1.2~5m (3.9 ~16.4 ft)	1.2~4m (3.9~13.1 ft)
400	1.2~ 10m (3.9 ~32.8 ft)	1.2~8m (3.9 ~26.2 ft)

Using Fill-in Flash

In this mode, the flash always fires. Use this mode when performing backlighting synchro photography, nighttime slow synchro flash photography or shooting backlit subjects. For normal indoor photography, we recommend flash AUTO photography to avoid any effects of camera shake.

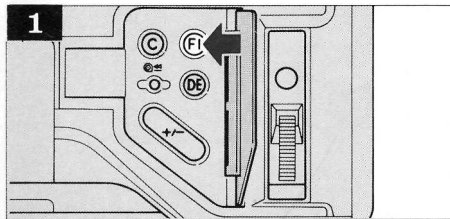

Press the FILL-IN button inside the mode cover.

FILL-IN blinks.

* Press it again for cancellation.

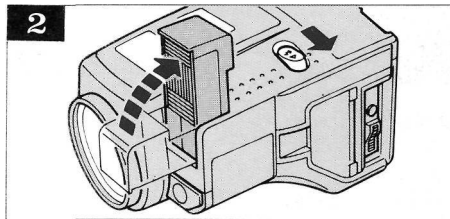
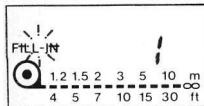

The flash pops up, and when it has been charged, you can press the shutter.

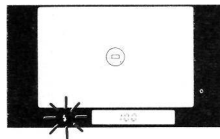

Example A: With backlighting, the person's face, etc., will be too dark.



↓ Daylight synchro



Clear photographs of a person using daylight synchro photography.

Using the FILL-IN flash mode, the shutter speed may be lengthened. Please check the shutter speed indicated within the Viewfinder. If the exposure time is lengthened, it is best to use a tripod to avoid a slower shutter speed motion blur. The slowest possible shutter speed is 2 seconds. By simultaneously employing the

Example B: When shooting a night scene, etc., which includes the background, only the person in the foreground will be illuminated.



↓ Slow synchro



The background can also be photographed using slow synchro.

Using an Exterior Flash Attachment

It is possible to light up a greater area by using the Electronic Flash L-30 which is sold separately.

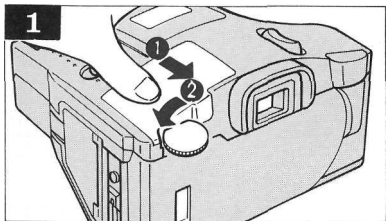

Remove the flash shoe cover by pressing towards the back of the camera with your finger ① and opening it with a coin or similar object ②.

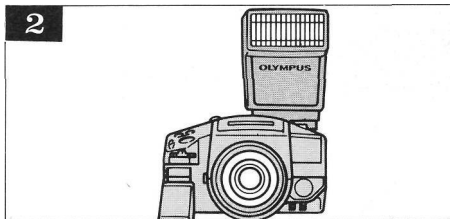

Attach the Electronic Flash L-30.

- * Flash attachments other than the Electronic Flash L-30 cannot be used.
- * Be sure to read the Electronic Flash L-30 user's manual for further details.

Attaching a Shoulder Strap

39

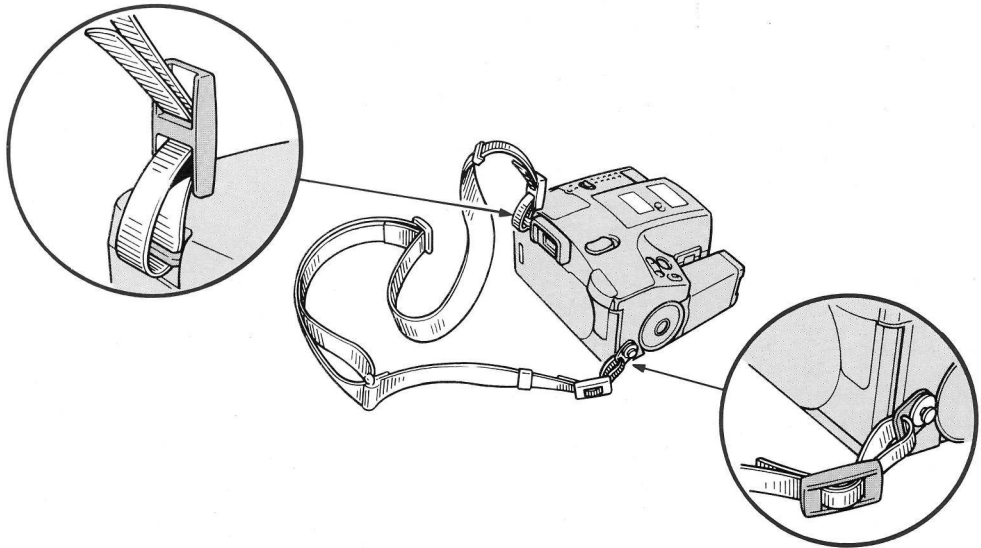

In order to take even better photographs....

Everyone wants to take pictures to be proud of. Everyone wants to master the more advanced photographic techniques. As a fundamental rule of thumb, this becomes possible only when the photographer becomes thoroughly familiar with his or her camera and its full potential. The following pages, which are based on each of the basic operations that have already been introduced, have been included with the hope that you might be able to challenge some of the more advanced techniques yourself. We'll be pleased if they help to give you the results you are seeking.

How to use your zoom lens for the best results

The AZ-4 Zoom is a compact camera equipped with a 35 ~ 135mm zoom lens. The zoom lens is a lens that moves, and allows you to alter the focal distance. With the AZ-4 Zoom, you can change the focal distance from 35mm to 135mm. This allows the photographer to change the composition of a photo through zooming while remaining in the same location, such as in the case of focusing in on a single member of a large group. This is a camera with a large amount of mobility which offers a wide range of photographic potential. Using only this single lens, it is the equivalent of having a number of interchangeable lenses with you at all times. Take advantage of your zoom lens and see what it can do for you.

The zooming operations are carried out through the zoom lever on the camera grip. By operating the zoom lens, the LCD panel will display the focal distance for approx. 2 seconds. Use this as your standard for zooming photography. Now let's take a look at some of the pictures you can take with your AZ-4 Zoom.

- **35mm** Wide-angle. This is achieved by retracting your super zoom lens. The photo format is wide and the depth of field with regard to the subject is deep, leading to a clear contrast and sharp close-up pictures.
- **70mm** Pictures taken under medium zooming conditions. In spite of the longer focal distance from the camera to the subject, the pictures are clear. The subjects are only half the size of those in pictures taken under 35mm conditions. The exaggeration found in close-ups is lessened and your pictures will seem more natural, less posed. You can use the 70mm position for snapshots, portraits, scenery and a wide variety of other photographic objectives.

63°  35mm



34°  70mm



18°  135mm

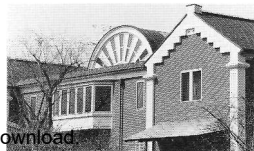

- **Over 100mm** In the full-zooming position, you will be using, in effect, a 135mm lens which will give you a field nearly 4 times as narrow as what you would have with the lens in the 35mm position. You can appreciate the excellence of a true, telephoto lens. Compared to wide-angle photography, you have a narrow field of vision and the depth of field to be photographed is fairly shallow.

Also, since your pictures will have less depth of field than with the lens in the wide-angle position, you will be able to take pictures in which you enjoy having only the subject in true focus. Aim your camera for close-up shots of sporting events or for animal subjects in their natural habitat. It is possible to achieve close-ups unnoticed of people in crowds. These kinds of snapshots and portraits with only the subject in focus can be quite enjoyable. Caution is necessary, when you are taking shots with the lens in the telephoto position, to hold the camera steadily so that you can avoid any unnecessary shaking.

* The three examples on the left are samples of the same subject photographed with the zoom lens set at three different positions. It is easy to comprehend the effects of zooming up. The three samples on the right of the same subject photographed with the zoom lens set at three different positions, but the size of the subject remains the same. It is easy to comprehend the relationship of the subject to the background in these different settings.

42

Total area of overall image sharpness within the angle of view of a specific focal length setting. Depth of Field will be at its greatest when the lens is in its lowest focal length positions.

35mm



70mm



135mm



Autofocus (AF)

43

The Autofocus (AF) mechanism automatically adjusts focus. With it, the camera measures the distance to a subject and adjusts the lens so that the subject is in focus. Currently, with the exception of a few cameras for professional use, this function is included in most of the single lens reflex and compact cameras that are now on the market. Of course, this function is used in the AZ-4 Zoom. In the AZ-4 Zoom, focusing is done by a newly-developed "Phase-Difference" detection system. In this system, light from the subject is picked up by a special sensor and any inconsistencies (phase differences) in the image are used by a microprocessor chip to calculate the best focus setting. Since the lens used in the AZ-4 Zoom is very accurate, correct focusing is even more accurate and accomplished by just aiming the lens at the subject. When there is no light reflected from the subject, for example in a dark room, focusing is performed using a beam of light from the camera (the AF-Illuminator).

Autofocus is designed so that the subject in the center of the picture frame is correctly focused. However, sometimes you may want a subject that is not in the center of the frame to be in focus; for such cases, the AZ-4 Zoom is also equipped with a focus lock

(1) Subject that does not include vertical lines

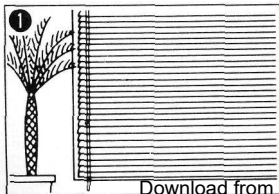

(2) Subject with low contrast

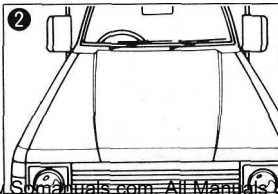

(3) A rapidly moving subject

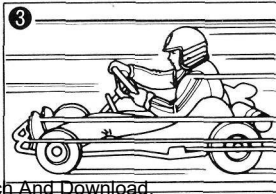

mechanism. For example, when your subject is at the edge of the picture frame, not in the center, first move the camera slightly so that the subject is in the center of the autofocus frame, then press the shutter release button halfway to focus. While keeping the button pressed, recompose the picture, and press the button fully. (See "Taking Photographs II" on p. 19). By doing this, photographs with any required composition can be taken. Manual focus is also possible.

Subjects with which autofocus is difficult

Although the AZ-4 Zoom can focus in almost any situation, there are certain conditions, such as those illustrated below, in which it may not be possible to obtain the correct focus. The focus aid indicator ($\triangleright\triangleleft$) in the Viewfinder will usually blink to warn you during these conditions; however, in situations (4), (5) and (6), the focus indicator in the Viewfinder may light even though the lens is incorrectly focused. In any of these situations, you can try focusing on a subject at a similar distance and then, using the focus lock. Or you may also use manual focus to take the photo.

44

(4) Two subjects within the focusing frame, at different distances

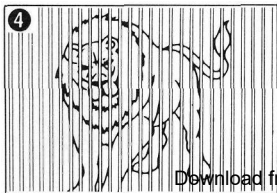

(5) Excessively bright light in the center of the focusing frame



(6) A subject with a repeated pattern

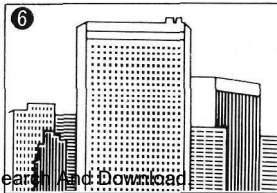

Exposure

Programmed exposure

One of the basics of photography is exposure. Exposure refers to the amount of the light which strikes the film. The correct amount of the light, or correct exposure, is controlled according to the film speed (indicated on the film package, such as ISO 100 or ISO 200), the shutter speed and aperture. Many cameras are now equipped with a programmed exposure function so that the correct exposure can be obtained easily without any guess-work or previous photographic experience.

45

With programmed auto exposure, the camera automatically sets the most suitable combination of "f" stop and shutter speed for subjects at any brightness level. As a result, the correct exposure will be obtained almost immediately. It's an automatic exposure system that means you'll never miss the opportunity to take a photograph. All the photographer has to do when holding the camera is to concentrate on aiming it correctly and press the shutter release button. For example, when you change from a dark to bright subject, the camera adjusts itself to maintain the correct exposure. Anyone can take photographs without worrying about making a mistake. Now, through the program shift function, it is possible to change combinations of shutter speed and aperture without changing the overall exposure.

Program chart

The chart below is a line chart showing the AZ-4 Zoom exposure program. In response to the use of the macro mode or zooming, the ideal shutter speed and aperture will be set automatically for an appropriate brightness in your photos. As the brightness of your target decreases, the aperture opening is increased and the shutter speed is lengthened. In order to avoid the effects of camera flutter, the shutter speed is automatically set at 1/100 sec. for pictures taken with the flash auto mode. If the format is too dark for an appropriate photo, the flash will fire automatically. In the event that the flash does not pop up, by using the fill-in flash mode, the shutter speed can be increased to compensate for brightness at the EV 4 level, and it is possible to increase the shutter speed up to a 32 sec. exposure by employing the program shift at the same time.

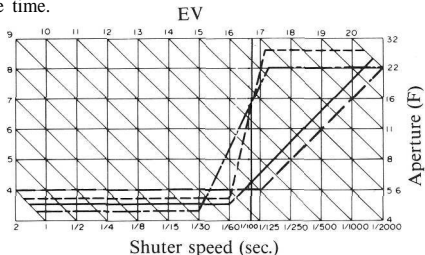

Viewfinder Displays

The Viewfinder in the AZ-4 Zoom is of the single lens reflex type which shows what is seen through the camera lens. It also displays valuable information regarding the photographic conditions.

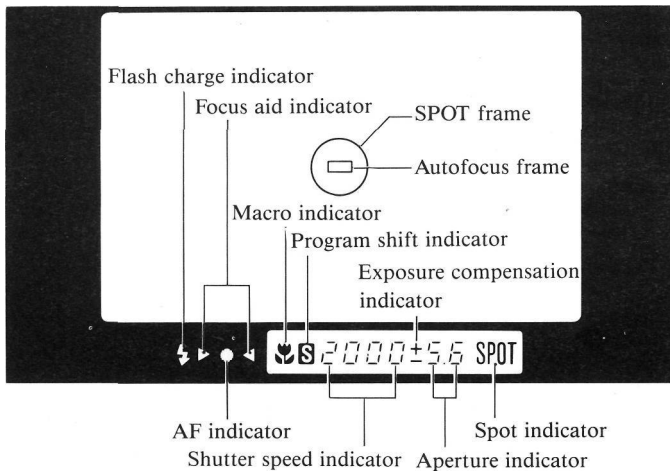

Reciprocal numbers (seconds) are indicated, except in the case of exposures of over one second.

LCD Panel and Mode Buttons

The AZ-4 Zoom has an LCD panel which displays important photographic information. These indications remain visible for 15 seconds after each operation is performed. After they go out, if you press lightly on the shutter release button, the indication is displayed again. After the power is switched off, any mode other than the self-timer and program shift which have been set are held in the camera's memory, for use next time.

47

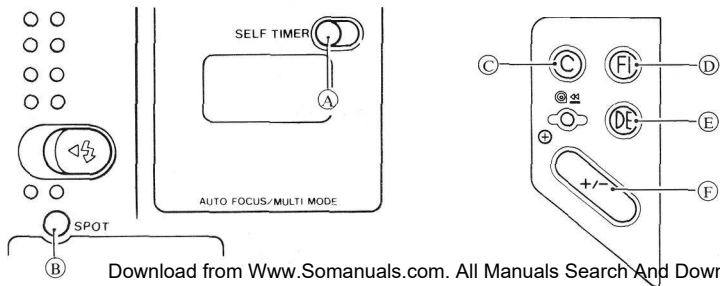
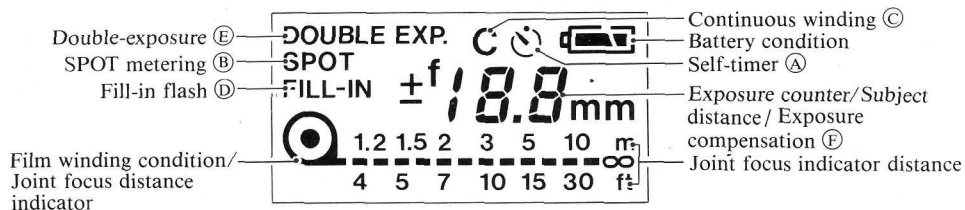

AZ-4 ZOOM

For Long-lasting Enjoyment of
Your AZ-4 Zoom

Care and Storage

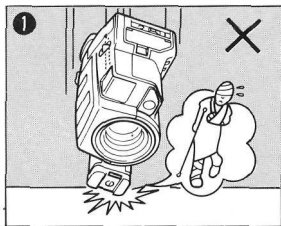

Do not drop the camera on the hard surfaces.

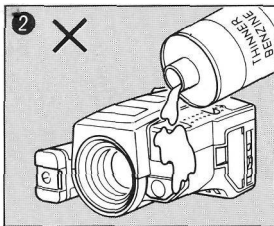

Do not use thinner, benzine or organic solvents to clean the camera.

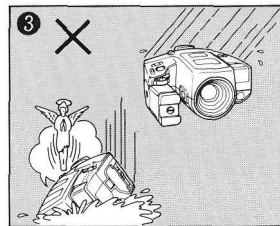

Do not expose the camera to rain shower and water.

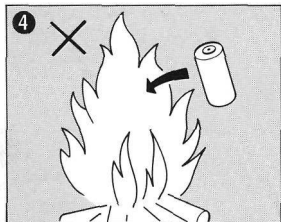

Do not throw used batteries into fires, and do not heat, disassemble or shorten them.

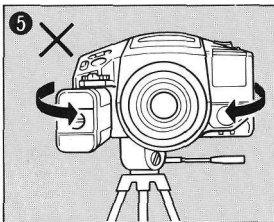

Do not tighten the tripod screw too much.

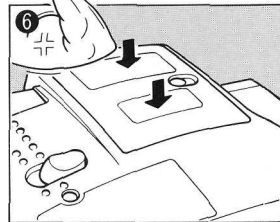

Do not apply excessive force to the camera.

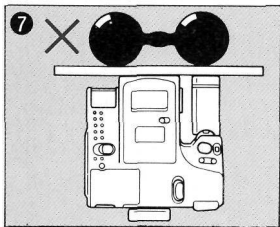

Do not put heavy object on the camera.

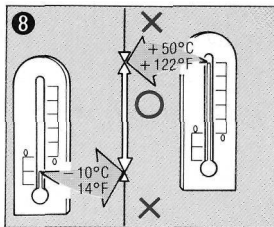

Do not put the camera in the extreme heat (over 50°C or 122°F) like inside of cars during hot summer weather or in the extreme cold (below -10°C or 14°F)

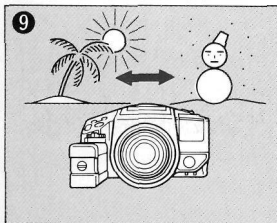
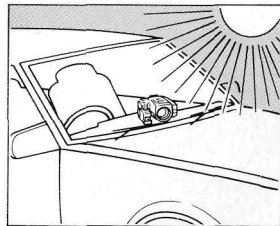

Avoid sudden temperature changes.

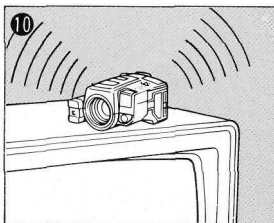

Do not leave the camera near magnetic fields, like on the top of TV set, or radio.

In case of malfunction, take the camera to your nearest Olympus service station.

Questions and Answers

Q: What kind of batteries should I use?

A: Use two lithium Panasonic CR-123A batteries or Duracell DL-123A batteries. Don't install one new battery with an old one. Change them both at the same time.

Q: How long will the batteries last?

A: Since long-life lithium batteries are used, approximately 20 rolls (24-exposure, half the shots with flash) can be taken. When the frequency with which the flash and zoom are used is less, the batteries will last longer.

Q: The camera does not work. What should I do?

A: (1) Make sure the power switch is set to ON.
(2) Check to make sure that the batteries are loaded and inserted correctly.
(3) If the film has been rewound, the camera won't work until new film is inserted.

Q: The camera does not focus correctly. What should I do?

A: The camera may not focus correctly in some cases. Focusing is difficult when, for example, the subject is moving quickly, if the camera is shaking, or if the subject is one of those with which focus is difficult. (See "Subjects to which autofocus is difficult" on p. 44)

Q: Why doesn't the camera focus although the AF Illuminator lights?

A: It may not focus if the subject is too close, too far or if the subject reflects too little light (when it is blue or black).

Q: Why won't the shutter fire when I press the shutter release button.

A: (1) Probably because the camera hasn't focused. Check the AF indicator in the Viewfinder.
(2) The flash may still be in the process of charging. Check for the  mark in the Viewfinder.

Q: The flash doesn't fire. What should I do?

A: Check to make sure if the flash has popped up.

Q: The camera does not operate in cold weather. What can I do?

A: Battery performance will be reduced temporarily by low temperatures, so it is recommended that you try to use the camera within a reasonable temperature range.

Q: How should I take advantage of all of the capacities of this excellent flash?

A: We recommend that you use the Flash Auto mode (p. 34) under normal circumstances. It will flash when conditions are dark enough to require extra lighting, and the exposure is automatically set at 1/100 sec. to avoid unnecessary flutter. There is no need to worry about lighting and the camera is easy to use. The Fill-in Flash mode is to be used under conditions of daylight synchro or slow synchro photography or other special conditions to which the Flash Auto mode cannot respond.

Q: How should I use the Fill-in Flash mode for daylight synchro or slow synchro photography?

A: The Fill-in Flash mode causes the flash to fire regardless of the available light, as well as conditions of exposure control shown in the exposure program line graph on p. 45. (Note that the shutter speed will be slower than the normal 1/100 sec.) With regard to lighting conditions, photography will be either daylight synchro or slow synchro photography. Please see the examples on p. 37 for your reference.

daylight synchro: When photographing a subject against a light source, the Flash Auto mode will not activate and the subject will be dark due to the affects of the backlighting in his surroundings. By using the Fill-in Flash mode, the flash will fire and the subject will be well-lit for an attractive picture.

slow synchro: Often, when photographing at night, if the subject is too far away from the camera the flash will not suffice. Yet if you use the Fill-in Flash mode, the shutter speed is lengthened and the flash will fire allowing for the possibility of photographing both the subject and the background. Since the exposure time is longer than usual, caution is required with moving subjects. It helps to use a tripod to avoid camera shake while using this mode.

Description of Controls

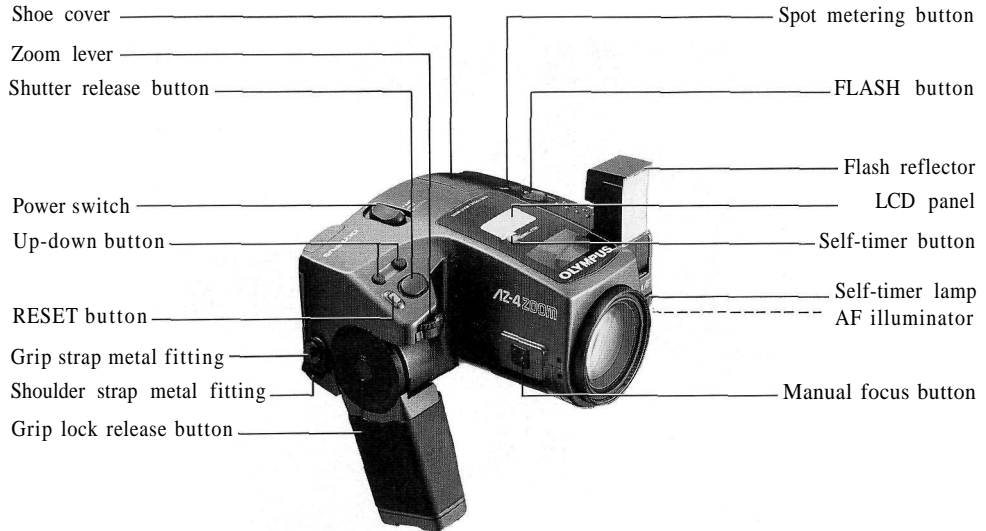

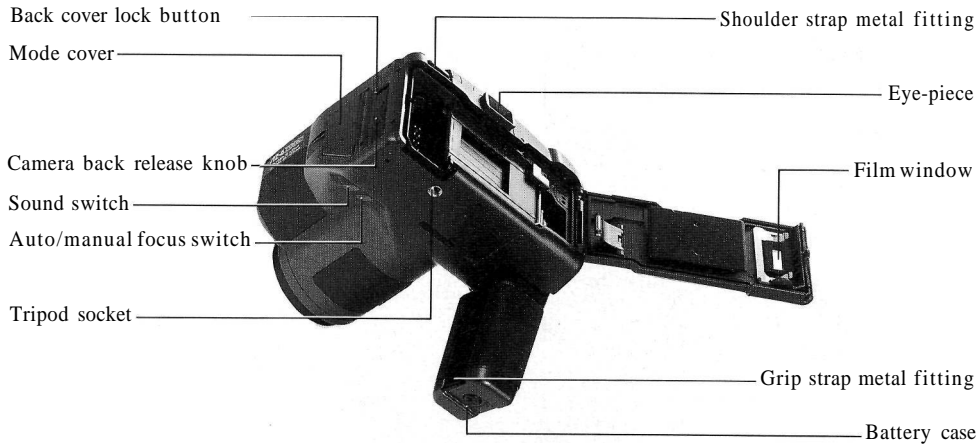

Specifications

Type: Fully automatic 35mm autofocus single-lens reflex camera with 35 ~ 135mm built-in lens

Film format: 35mm standard DX coded film (24 x 36mm)

Lens: Olympus 35 ~ 135mm F4.2 ~5.6 lens

Shutter: Programmed electronic shutter speed: 1/2000 sec.~32 sec.

Focusing: Passive autofocus system with focus lock, manual focus (power focus) and focus aid potential

Viewfinder: TTL Type, magnification X0.80 (at 50mm) Finder view field: 87%, of actual picture field

Viewfinder information: Auto focus frame, spot metering frame, focus aid indicator, AF indicator, flash charging indicator, program, shift indicator, macro indicator, spot metering indicator, shutter speed (with slow speed warning), aperture and exposure compensation indicator

Exposure control: Programmed exposure adjustment (center-weighted average light metering, switchable to spot metering), auto exposure range EV4 ~20 (ISO 100), program shift potential

Exposure compensation: ± 4 EV compensation potential (1/3 step)

Exposure counter: Progressive type, displayed in LCD panel

Self-timer: Electronic self-timer with 10 sec. delay

Film speed range: Automatic setting with DX coded film ISO 25 ~ 5000 with color negative film

Film loading: Automatic loading (automatically advances to first frame when camera back is closed)

Film advance: Automatic film winding type

Film rewinding: Automatic film rewind (automatic rewind activated at the end of film), rewind possible at any point with rewind button

Flash: Manual pop-up flash, recycling 3.5 sec. (at normal temp.), flash working range: WIDE: 1.2m (3.9 ft)~5m (16.4 ft) (ISO 100 negative color film). TELE: 1.2m (3.9 ft)~4m (13.1 ft) (ISO 100 negative color film). WIDE: 1.2m (3.9 ft)~10m (32.8 ft) (ISO 400 negative color film). TELE: 1.2m (3.9 ft)-8m (26.2 ft) (ISO 400 negative color film)

Flash modes: AUTO (automatic flash activation in low light) FILL-IN (forced activation) external flash unit sold separately (Electronic Flash L-30)

Battery check: Displayed in LCD panel

Power source: Two 3V lithium batteries (Duracell DL-123A, or Panasonic CR-123A)

Dimensions:

134.5mm(W) x 80.5mm(H) x 127.5mm(D)
(5.3" x 3.2" x 5.0")

Weight: 1,020g (36.0 oz) (without batteries)

Specifications and design are subject to change without notice.

Accessories Sold Separately

57



ELECTRONIC
FLASH L-30



TELECONVERTER
LENS X1.5



GRIP STRAP



RECORDATA BACK 400



SOFT CASE



DIOPTIC CORRECTION
LENS (with Eye Cup 2)

Free Manuals Download Website

<http://myh66.com>

<http://usermanuals.us>

<http://www.somanuals.com>

<http://www.4manuals.cc>

<http://www.manual-lib.com>

<http://www.404manual.com>

<http://www.luxmanual.com>

<http://aubethermostatmanual.com>

Golf course search by state

<http://golfingnear.com>

Email search by domain

<http://emailbydomain.com>

Auto manuals search

<http://auto.somanuals.com>

TV manuals search

<http://tv.somanuals.com>