

OWNER'S MANUAL

DieHard®

Battery Charger
15/2 Amp
Fully Automatic
Microprocessor Controlled

Engine Starter
100 Amp

Model No.
200.71224



CAUTION:

Read all Safety Rules and Operating Instructions, and follow them with each use of this product.

Sears, Roebuck and Co., Hoffman Estates, IL 60179 U.S.A.

0099000303/0103

Download from [Www.Somanuals.com](http://www.Somanuals.com). All Manuals Search And Download.

TABLE OF CONTENTS

WARRANTY	2
IMPORTANT SAFETY INSTRUCTIONS	3
PERSONAL SAFETY PRECAUTIONS	4
BEFORE USING YOUR BATTERY CHARGER	5
Assembling your charger	5
Plugging it in	5
Using an extension cord	5
PREPARING YOUR BATTERY TO BE CHARGED	6
CHARGING TIPS	6
USING YOUR BATTERY CHARGER	7
CONTROL PANEL	9
CHARGING YOUR BATTERY	10
Inside vehicle	10
Outside vehicle	11
Using Engine Start	11
ESTIMATING CHARGE TIME	12
MAINTENANCE AND CARE	13
TROUBLESHOOTING	14
PARTS	15
WIRING DIAGRAM	16

Please read this Owner's Manual before using your Battery Charger

The DieHard model 71224, Fully Automatic Battery Charger/Engine Starter, offers features to accommodate the needs for home or light commercial use. This manual will show you how to use your charger safely and effectively. Please read and follow these instructions and precautions carefully.

For information about troubleshooting, call toll-free from anywhere in the U.S.A. 7 am to 4:30 pm CT Monday through Friday.

1-800-SEARS-64 (1-800-732-7764).

WARRANTY

FULL THREE YEAR WARRANTY

If, within three years from the date of purchase this battery charger fails due to a defect in material or workmanship, simply return the charger to the place of purchase and it will be replaced free of charge.

This warranty gives you specific legal rights, and you may also have other rights which vary from state to state.

Sears, Roebuck and Co., Dept. 817WA, Hoffman Estates, IL 60179

IMPORTANT SAFETY INSTRUCTIONS

WARNING: To reduce the risk of explosion, explosive gases, or injury while using your battery charger, follow the precautions listed below:

- Read all instructions and cautions printed on the battery charger, battery, and vehicle or equipment using battery.
- Use charger only on lead-acid type rechargeable batteries, such as those used in cars, trucks, tractors, air-planes, vans, RV's, trolling motors, etc. This charger is not intended to supply power to a low voltage electrical system.
- Use only attachments recommended or sold by Sears. The use of attachments not recommended by Sears may result in fire, electric shock, or injury.
- Do not disassemble charger. Take it to a qualified service professional if service or repair is required. Incorrect assembly may result in fire or electrical shock.
- To reduce risk of electrical shock, unplug the charger from the outlet before attempting any maintenance or cleaning.
- Always charge battery in a well-ventilated area.
- Battery chargers get hot during operation and must have proper ventilation. Air needs to flow around entire charger.
- Do not set charger on flammable materials like carpeting, upholstery, paper, cardboard, etc. Charger may damage leather and melt plastic and rubber.

HELP US HELP YOU —

Remember:

- **Place** charger as far away from the battery being charged as the charger cables will permit.
- **Do not** expose charger to rain or snow.
- **Never** charge a frozen battery. If battery fluid (electrolyte) becomes frozen, bring battery into a warm area to thaw before you begin charging.
- **Never** allow battery acid to drip on charger when reading specific gravity or filling battery.
- **Never** set a battery on top of the charger.
- **Never** place charger directly above battery being charged. The gases from the battery will corrode and damage the charger.
- **Never** use charger for charging dry-cell batteries that are commonly used with home appliances like radios, stereos, remote controls, etc. These batteries may burst and cause personal injury.
- **Never** touch the battery clamps together when the charger is on. You could cause a spark.
- **Never** operate charger if it has received a hard blow, been dropped, or otherwise damaged. Take it to a qualified professional for inspection and repair.
- **Be sure** to position the charger power cord to prevent it from being stepped on, tripped over, or damaged.
- **Never** pull out the plug by the cord when unplugging the charger. Pulling on the cord may cause damage to the cord or the plug.
- **Do not** operate the charger if it has a damaged power cord or plug. Have the cord replaced.

PERSONAL SAFETY PRECAUTIONS

For your own personal safety, please follow the following precautions:

- **Wear complete eye and clothing protection** when working with lead-acid batteries.
- **Be sure** that someone is within range of your voice to come to your aid if needed while you work with or are near a lead-acid battery.
- **Have plenty of fresh water and soap** nearby for use in case battery acid contacts your eyes, skin, or clothing. If this happens, wash immediately with soap and water. Then get medical attention.
- **Avoid touching your eyes** while working with a battery. Acid particles (corrosion) may get into your eyes. If this occurs, flush eyes immediately with running cold water for at least 10 minutes. Then immediately get medical attention.
- **Remove all personal metal items** from your body such as rings, bracelets, necklaces and watches, while working with a lead-acid battery. A battery can produce a short circuit current high enough to weld a ring (or the like) to metal, causing a severe burn.
- **Take care** not to drop any metal tool or metal object onto the battery. This may spark or short circuit the battery or another electrical device that may cause an explosion.
- **Always** operate your battery charger in an open, well-ventilated area.
- **Never** smoke or allow a spark or flame in the vicinity of the battery or engine. Batteries generate explosive gases.
- **Neutralize** any acid spills thoroughly with baking soda before attempting to clean up.
- **WARNING:** Handling the cord on this product or cords associated with accessories sold with this product, will expose you to lead, a chemical known to the State of California to cause cancer and birth defects or other reproductive harm. ***Wash hands after handling.***

BEFORE USING YOUR BATTERY CHARGER

It is important to understand your charger's requirements. This section will tell you about your charger's electrical requirements and how to prepare a battery for charging.

ASSEMBLING YOUR CHARGER

Included with your battery charger are two cord wrap cleats for storage of the clamp cables.

To install, align the three tabs to correspond with the three receptacles and push until you hear a snap.

Wrap clamp cables after unplugging the power cord and store your charger in a dry location.

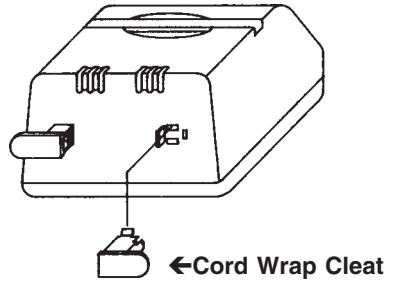

PLUGGING IT IN

Your charger requires a 120V AC receptacle installed according to all local codes and ordinances.

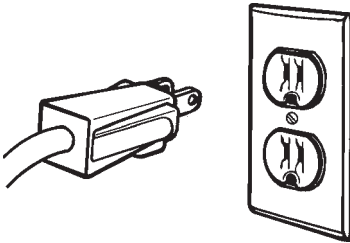

USING AN EXTENSION CORD

The use of an extension cord is not recommended. If you must use an extension cord, please make sure that you follow these guidelines:

- Make sure that the pins on charger's power cord fit firmly into the extension cord, and that the extension cord fits firmly into the receptacle.
- Check that the extension cord is properly wired and in good electrical condition.
- Make sure that the wire size is large enough for its length and for the AC ampere rating, as specified in the chart below.

MINIMUM RECOMMENDED EXTENSION CORD				
Length of Cord, in Feet	25	50	100	150
AWG* Size of Cord	18	16	12	10

*AWG=American Wire Gauge

PREPARING YOUR BATTERY TO BE CHARGED

It is important that you read and follow these guidelines while you are preparing to charge your battery.

- Make sure that you have a 12 volt lead-acid battery.
 - Clean the battery terminals. Be careful to keep corrosion from getting in or around your eyes.
 - For batteries with removable vent caps, if required, add distilled water to each cell until the battery acid reaches the level recommended by the manufacturer. This will help purge excessive gases from the cells. Be careful not to overfill. If you have a sealed battery with non-removable vent caps, no action is necessary.
 - Take time to read all battery manufacturer's specific precautions, such as removing or not removing vent caps while charging, and recommended rates of charge.
 - Wear safety glasses. See additional "Personal Safety Precautions" on page 4.
 - Be sure that the area around the battery is well ventilated while it is being charged.
 - If it is necessary to remove the battery from the vehicle to charge it, always remove the grounded terminal from the battery first. Turn off all vehicle accessories to avoid sparks from occurring.
- NOTE:** A marine battery installed in a boat must be removed and charged on shore.

CHARGING TIPS

Read the following pages before using your charger. The tips below serve only as a guide for specific situations.

If your vehicle won't start: You don't need to fully charge a battery to start your vehicle. If the charger won't start your vehicle using the 100 Amp Start rate, try charging the battery using the 15 Amp rate for 10 or 15 minutes. That should charge the battery enough to allow the 100A Start rate to start the vehicle. If the vehicle will then be operated continuously for an extended period (such as a long drive), the vehicle could charge the battery back to normal during that period. If the vehicle will only be operated for a short period (short drive), the battery might need to be charged again before it could start the vehicle.

Reviving your battery: If you only wish to charge your battery enough to

operate your vehicle, you don't need to wait for the entire charging process to be completed. When the charger displays three Battery Status LEDs (see pages 8, 9, and 12), the battery has been charged as much as by most chargers. The vehicle should then start and operate normally.

Completing an interrupted charge: If the charging process has been interrupted and restarted after three Battery Status LEDs were lit, the charger will go straight to Maintain Mode (see pages 7 & 9). However, if the original charge was started using 15 Amps, the charge can often be completed using 2 Amps.

USING YOUR BATTERY CHARGER

For best results from your battery charger, learn to use it properly. This section tells how to set the controls and how to charge a battery in and out of a vehicle.

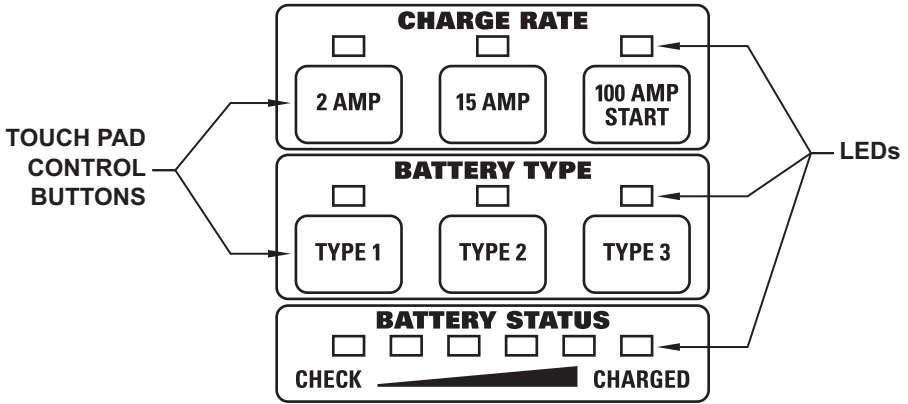

2 Amp charge rate: Intended for charging of small batteries such as those commonly used in garden tractors, snowmobiles and motorcycles. It is not to be used as a trickle charger for larger batteries.

15 Amp charge rate: Use for charging automotive batteries, marine starter batteries and deep cycle batteries. Not intended for industrial applications and very large batteries where 20 amp and greater charge rates are required.

100 Amp engine start: Provides 100 amps for cranking an engine with a weak or run down battery. Always use in combination with a battery.

Charging: Both the 2 and 15 amp charge rates perform an automatic charge function. During the first few seconds of operation, an analytical check of the battery is performed. If the charger does not detect a properly connected battery, the red "check" LED will light continuously until such a battery is detected. If a battery will not accept a normal charge, the charger will switch to a special mode of operation designed for such batteries.

Indication of this special mode is the flashing of the first amber LED in the charge status display. If successful, normal charging will resume. If not, a red LED will blink indicating that charging has been aborted. Note: The special mode could last up to 10 hours. When the amber LED is on but not flashing, normal charging is in progress. Charge completion is indicated by a green LED; at that point the charger has switched to the Maintain Mode of operation.

Maintain Mode: When the green LED is lit, the charger has started Maintain Mode. This mode of operation is also known as Float-Mode Monitoring. In this mode, the charger keeps the battery fully charged by delivering a small current, when necessary.

Battery types: The charger offers a selection of three different types of batteries:

- **Type 1** most Low-Maintenance, AGM and Gel Cell batteries;
- **Type 2** Deep Cycle and Maintenance-Free batteries;
- **Type 3** Deep cycle batteries with a built-in 'eye-type' charge indicator.

With the exception of AGM and gel cell batteries, all other battery types may or may not have vent caps. *Vent caps are located on top of the battery and provide a means to add distilled water when needed.* Batteries should be marked with their type. If charging a battery that is not marked, check the manual of the item that uses the battery. If the battery type is unknown, use the **Type 1** position. Make sure the battery complies with the safety instructions on page 3.

Engine cranking: When the **100A Start** rate is selected, the charger waits until the engine is actually being cranked before delivering 100 amps for engine start. **Note:** The charger delivers a charge of 3 to 7 amps while waiting for the engine to be cranked and will reset if the engine is not cranked within 15 minutes. Cranking is allowed for up to 3 seconds, then the charger shuts down for a 4 minute cool down period. During the cool down period the Start LED will blink. After 4 minutes, the Start LED will light continuously, indicating that another crank cycle can be performed.

Battery Status LEDs: The status of the battery is indicated by a row of six LED's. The first LED is red; it will light under the following conditions:

1. The charger is not connected to a battery. *Red LED lights continuously.*
2. The charger is reverse-connected to a battery. *Red LED lights continuously.*
3. The charge cycle was not completed within 24 hours. *Red LED blinks.*
4. The battery could not be charged in a normal manner. This could be due to a battery with a partially shorted or open cell, sulfated battery plates or electrolyte out of balance. *Red LED blinks.*

The next four LEDs are amber. During a normal charge, the leftmost amber LED will light first. Then two, then three, and eventually all four amber LEDs will light. Refer to "Estimating Charge Time" on page 12 for more information.

The sixth LED is green and lights to indicate that charging is complete. When the green LED lights, the amber LEDs will turn off and the charger will start Maintain Mode.

See the Control Panel table on the next page.

Setup and Operating: Follow all safety and connecting procedures in this manual. Located above each button on the control pad is an amber LED that lights to indicate that the selection is active.

When first plugged in, the charger will automatically default to the **2 AMP / TYPE 1** position. You may then select the charge rate and battery type. For example, if you're charging a large 12-volt deep cycle battery, press the buttons labeled **15 AMP** and **TYPE 2**. **Note:** If you press a charge rate or battery type button after charging has started, the charger will restart the charging process. Refer to "Estimating Charge Time" on page 12 for more information.

When selecting the Start position, you do not have to select a battery type. All indicator lights will turn off except for the light above the Start button. The red LED will also light if a properly connected battery has not been detected.

CHARGING YOUR BATTERY

IMPORTANT: Follow all safety instructions and precautions when charging your battery. Wear complete eye protection and clothing protection. Charge your battery in a well-ventilated area.

Charging your battery in the vehicle:

1. Avoid personal injury by keeping clear of fan blades, belts, pulleys and other engine parts.
2. Avoid damaging the charger by keeping the power cord and output cables away from the hood, door or moving engine parts.
3. Note the polarity of the battery posts by checking the identification marks on the battery: POSITIVE (POS, P or +) and NEGATIVE (NEG, N or -). The positive post is usually larger than the negative post.
4. Identify which battery post is grounded or connected to the chassis. THIS IS NORMALLY THE NEGATIVE POST.

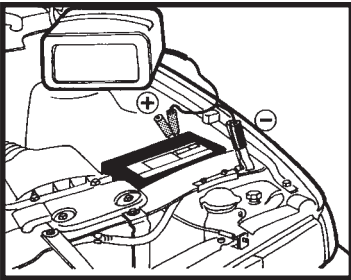

NEGATIVE GROUNDED SYSTEM

5. **Connecting to a negative-grounded system:** Connect the red (POSITIVE) output clamp to the POSITIVE post of the battery. Rock and twist the clamp back and forth to be sure a solid electrical connection

is made. Then connect the black (NEGATIVE) output clamp to a heavy, unpainted metal part of the chassis or engine block, away from the battery (see figure on this page). DO NOT connect clamp to negative battery post, carburetor, fuel line or sheet metal part.

Connecting to a positive-grounded system:

Connect the black (NEGATIVE) output clamp to the NEGATIVE post of the battery. Rock and twist the clamp back and forth to be sure a solid electrical connection is made. Then connect the red (POSITIVE) output clamp to a heavy, unpainted metal part of the chassis or engine block, away from the battery. DO NOT connect clamp to positive battery post, carburetor, fuel line or sheet metal part.

6. Plug power cord into an AC outlet. The charger will set to the default state of 2 AMP charge rate and Type 1 for battery type.
7. Press the appropriate control buttons to select the desired charge rate and battery type. Within a few seconds, the red LED should go out and the charging process should start. If the red LED does not go out, check for correct cable connection.
8. To disconnect the charger, unplug the charger power cord before attempting to disconnect the output clamps. Then, standing away from the battery, remove the output clamp from the chassis or engine block. Finally, remove the output clamp from the battery post.
9. Clean and store the charger in a dry location.

Charging your battery removed from the vehicle:

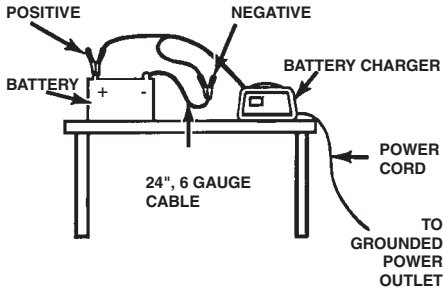

1. Note the polarity of the battery posts by checking the identification marks on the battery: POSITIVE (POS, P or +) and NEGATIVE (NEG, N or -). The positive post is usually larger than the negative post.
2. Attach at least a 24-inch-long 6-gauge (AWG) insulated battery cable to NEGATIVE (NEG, N or -) battery post. Rock and twist the clamp back and forth to be sure a solid electrical connection is made.
3. Connect the red (POSITIVE) output clamp to the POSITIVE battery post. Rock and twist the clamp back and forth to be sure a solid electrical connection is made.
4. Position yourself as far away from the battery as possible, and then connect the black (NEGATIVE) output clamp to the free end of the cable.
5. Plug the power cord into an AC outlet. The charger will set to the default state of 2 AMP charge rate and Type 1 for battery type.
6. Press the appropriate control buttons to select the desired charge rate and battery type. Within a few seconds, the red LED should go out and the charging process should start. If the red LED does not go out, check for correct cable connection.

7. To disconnect the charger, unplug the charger power cord before attempting to disconnect the charger clamps. Then, standing away from the battery, remove the output clamp from the NEGATIVE battery post. Finally, remove the output clamp from the POSITIVE battery post.
8. Clean and store the charger in a dry location.

USING ENGINE START

Your battery charger can be used to jump start your car if the battery is low. Follow these instructions on how to use the ENGINE START feature.

IMPORTANT: Follow all safety instructions and precautions when charging your battery. Wear complete eye protection and clothing protection. Charge your battery in a well-ventilated area.

IMPORTANT: Using the ENGINE START feature WITHOUT a battery installed in the vehicle could cause damage to the vehicle's electrical system.

1. With the charger plugged in and connected to the battery of the vehicle, press the 100 AMP touch pad. Only the 100 AMP indicator lamp should be lit.
2. Crank the engine for no more than 3 seconds. If engine does not start, let rest for 4 minutes before cranking again.
3. After the engine starts, unplug the power cord before disconnecting the output clamps from the battery.
4. Clean and store the charger in a dry location.

ESTIMATING CHARGE TIME

This charger adjusts the charging time in order to charge the battery completely, efficiently, and safely. The microprocessor automatically makes all necessary calculations. However, this section includes guidelines that can be used to estimate charging time. Charge times listed are typical. Actual times may vary.

The duration of the charging process depends on each of three factors.

1. Battery state: A battery that has only been slightly discharged could be charged in only a few hours. However, the same battery could take 24 hours to charge if it is very weak. Battery state can be estimated by using a voltmeter to measure the battery voltage or by using a State-of-Charge Tester. The lower the reading, the longer the charging process will take.

2. Battery rating: A higher rated battery will take much longer to charge than a lower rated battery under the same conditions. A battery's rating may be indicated in Ampere hours (Ah), Reserve Capacity (RC), or Cold Cranking Amps (CCA). The lower the rating, the quicker the charging will be completed. For example, a very small battery might be rated for 6 Ah and charge in 4 hours, but a very large battery might be rated for 100 Ah and require 24 hours to charge completely.

3. Charge rate: The charge rate is measured in amps. This charger provides charge rates of 2 Amps and 15 Amps. **Note:** the 100 Amp rate is intended for Engine Start only, NOT continuous charging. A higher charge rate results in a faster charge. **Note:** The 2 Amp rate might be too low to charge a higher rated battery within the 24 hour time limit the charger allows. However, some smaller batteries, such as motor-cycle and tractor batteries, have a

maximum recommended charge rate much less than 15 Amps. Such batteries should be charged using the 2 Amp setting.

This charger starts charging at the selected rate (2 or 15 Amps) and eventually reduces the charge rate in a precisely controlled manner. After the charging process has started, the Battery Status LEDs can be used to estimate the charge time as explained below.

- **Red LED:** Checking for properly connected battery, not charging (no output).
- **1 Amber LED:** Battery detected, charging started, 3 to 10 seconds from start.
- **2 Amber LEDs:** When second light first glows, charging is roughly at 20% to 25% complete, 1 to 5 hours from start.
- **3 Amber LEDs:** When third light first glows, charging is roughly at 35% to 50% complete, 3 to 7 hours from start. Battery charged enough for use in vehicle. Note: If charging is restarted after this point, the charger may go straight to Maintain Mode (Green LED).
- **4 Amber LEDs:** When fourth light first glows, one or two hours are left, battery virtually "good as new", 4 to 13 hours from start.
- **Green LED:** Charge complete, battery at maximum charge state, 5 to 14 hours from start.

MAINTENANCE AND CARE

A minimal amount of care can keep your battery charger working properly for years.

1. Clean the clamps each time you are finished charging. Wipe off any battery fluid that may have come in contact with the clamps to prevent corrosion.
2. Coil the input and output cords neatly when storing the charger. This will help prevent accidental damage to the cords and charger.
3. Occasional cleaning of the case of the charger with a soft cloth will keep the finish shiny and help prevent corrosion.

TROUBLESHOOTING

Performance problems often can be corrected by the user. Please read through this chart for a possible solutions to common problems.

PROBLEM	POSSIBLE CAUSE	SOLUTION
Indicator lights are lit in an erratic manner not explained in the "Using Your Battery Charger" section.	The charger may be defective.	Return to place of purchase for a replacement.
The red abort light always flashes before the battery is charged.	This will happen if the battery did not reach full charge within 24 hours. May be due to a very large battery or a bank of batteries requiring more than what a 15 Amp charger can deliver within 24 hours. The battery may also be bad.	Reset the charger by unplugging it or briefly disconnecting the negative battery clip. Select the desired charge rate and battery type again, if necessary.
Engine crank time is less than specified.	Starter motor may be drawing more than 100 Amps.	Charge the battery at the 15 Amp rate for 10 to 15 minutes then crank the engine.
The green full charge light turns on a few minutes after connecting to the battery.	The battery may be fully charged or recently charged leaving the battery voltage high enough to make the charger think the battery is fully charged.	If the battery is in a vehicle turn the headlights on for a few minutes to reduce the battery voltage and try charging again.

For information about troubleshooting, call toll-free from anywhere in the
U.S.A. 7 am to 4:30 pm CT Monday through Friday.
1-800-SEARS-64 (1-800-732-7764).

PARTS

This section shows an illustration of your battery charger. Use it to become familiar with part locations and appearance.

Replacement Parts List DieHard 71224

Item Description	Part Number	Item Description	Part Number
1. Transformer	93026557	7. AC Power Cord	90026135
2. SCR Control Module	2299001160	8. Handle	3599000270
3. Screw 8-18 x 1/2" (4)	5199000274	9. Faceplate	0899001570
4. Touch Pad Control Board	2299001191	10. Cord Cleat	1199004390
5. Circuit Breaker	3999000104	Owner's Manual	0099000303
6. Output Cables	2299001205		

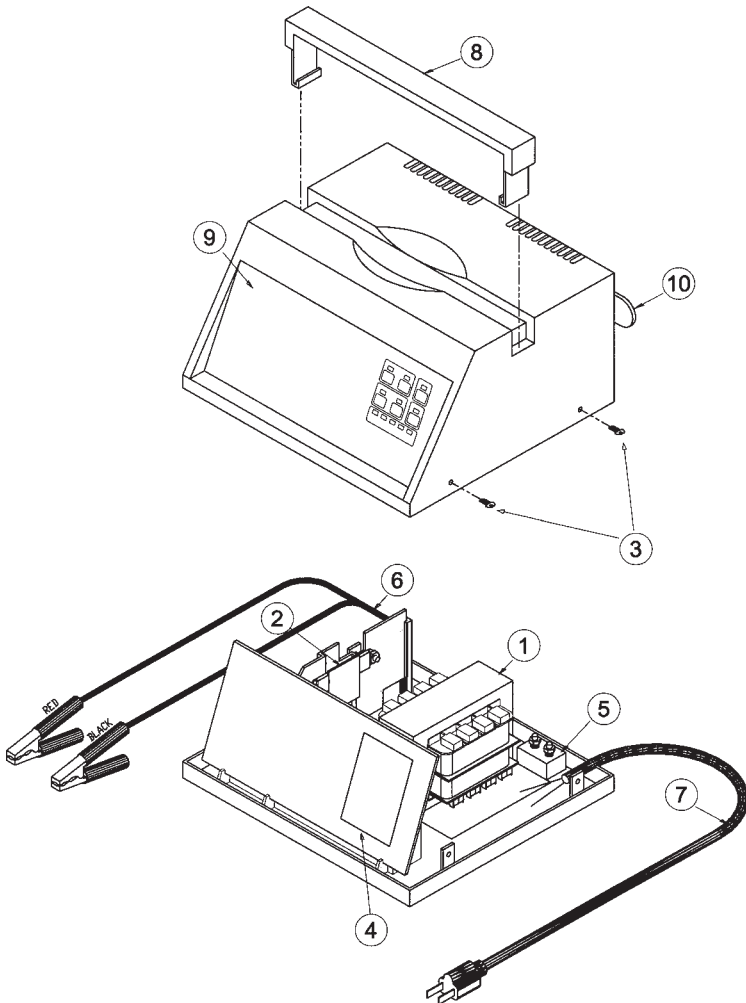

WIRING DIAGRAM

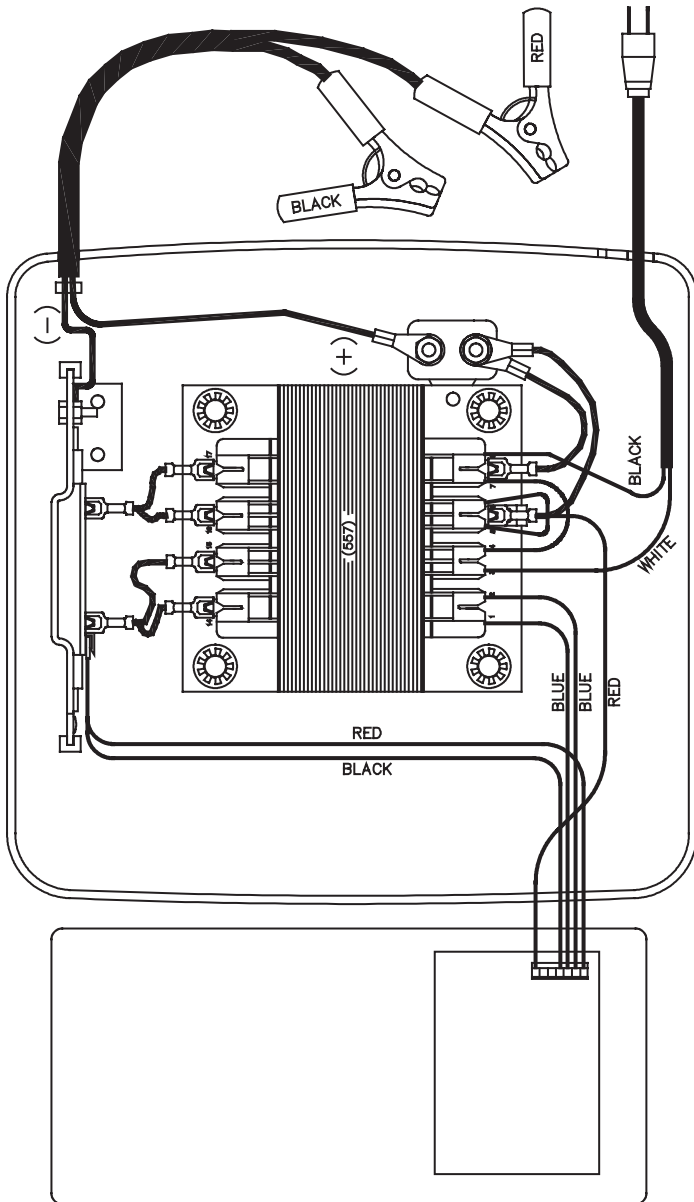

For information about troubleshooting, call toll-free from anywhere in the U.S.A. 7 am to 4:30 pm CT Monday through Friday.
1-800-SEARS-64 (1-800-732-7764).

Free Manuals Download Website

<http://myh66.com>

<http://usermanuals.us>

<http://www.somanuals.com>

<http://www.4manuals.cc>

<http://www.manual-lib.com>

<http://www.404manual.com>

<http://www.luxmanual.com>

<http://aubethermostatmanual.com>

Golf course search by state

<http://golfingnear.com>

Email search by domain

<http://emailbydomain.com>

Auto manuals search

<http://auto.somanuals.com>

TV manuals search

<http://tv.somanuals.com>