

Pro842/Pro847/Pro848

USER'S GUIDE

8

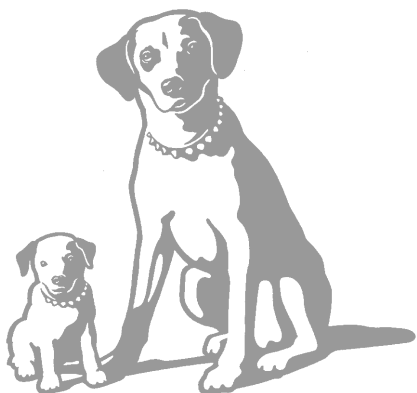

PRO8[®] CAMCORDER

PRO8

Important Safety Information

Be sure to read all the safety information before you begin to use this product.

WARNING: To reduce the risk of fire or shock hazard, do not expose camcorder or AC adapter to rain or moisture.

CAUTION

RISK OF ELECTRIC SHOCK
DO NOT OPEN



This symbol indicates "dangerous voltage" inside the product that presents a risk of electric shock or personal injury.

ATTENTION

RISQUE DE CHOC
ELECTRIQUE NE PAS OUVRIR



This symbol indicates important instructions accompanying the product.

TO REDUCE THE RISK OF ELECTRIC SHOCK, DO NOT REMOVE THE COVER (OR BACK). NO USER-SERVICEABLE PARTS ARE INSIDE. REFER SERVICING TO QUALIFIED SERVICE PERSONNEL.

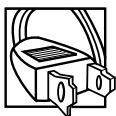

CAUTION: To prevent electric shock, match wide blade of plug to wide slot, fully insert.

ATTENTION: Pour éviter les chocs électriques, introduire la lame la plus large de la fiche dans la borne correspondante de la prise et pousser jusqu'au fond.

CAUTION: Avoid operating your camcorder immediately after moving it from a cold location to a warm location. Give the camcorder 1-1/2 to 2 hours to reach a stable temperature before inserting a video cassette. When moved from a cold area to a warm location, moisture may condense on the head drum inside the machine. This moisture could cause the tape to stick to the headwheel and damage the headwheel or tape.

FCC Regulations state that unauthorized changes or modifications to this equipment may void the user's authority to operate it.

Product Registration

Please fill out the product registration card and return it immediately. Returning this card allows us to contact you if needed.

Keep your sales receipt for proof of purchase to obtain warranty parts and service and attach it here. Record the serial and model numbers located on the bottom of the camcorder.

Model Pro842/Pro847/Pro848

Serial No: _____

Purchase Date: _____

Purchased From: _____

Assistance

We want to make sure you enjoy your new camcorder. If you have any questions, call:

Camcorder Exchange Warranty..... 800-283-6503 (Pages 54-55)

Customer Service..... 800-336-1900 (Page 53)

Accessories..... 800-338-0376 (Pages 42-47)

Table of Contents

Safety Information	i	• Tape Time Remaining Display23
Product Registration	i	• Quick Review24
First-Time Operation		• Camera Edit24
• Assistance2	• Blank Search24
• Unpack Camcorder and Accessories2	• Zooming25
• Attach Lens Cap Cord and Adjust Handstrap3	• AE Shutter Control25
• Attach Shoulder Strap3	• Focusing26
• Supply Power to the Camcorder4	• Install Clock Cell27
• Turn on the Camcorder5	• Date and Time Display28-29
• Insert a Cassette5	• Time Counter30
• Adjust Viewfinder Focus5	• Recording and Traveling Tips31
• Start and Stop Recording5	• Model Pro848 Only: Recording from a TV or VCR32-33
• Play Back what You have Recorded5		
• Turn Off Camcorder5	Playback	
• Review the Camcorder's Controls6	• Playback and Features	
Powering Your Camcorder		• Viewfinder Playback34
• Using the AC Adapter7	• Visual Searching35
• Using the Rechargeable Battery8-10	• Tape Positioning35
• Using Optional Alkaline "AA" Batteries11	• Stop-Action Pause35
• Using the Optional AC Adapter/Charger12-13	• Model Pro848 Only: Playback on TV (or VCR) with AUDIO/VIDEO IN Jacks36-37
Remote Control	14-17	Models Pro842 and Pro847 Only: Playback on TV (or VCR) with AUDIO/VIDEO IN Jacks38-39
Recording		• Playback on a TV Without Audio/Video Inputs40-41
• Video Cassettes18	Optional Accessories	42-47
• Making a Recording19	• Accessory Order Form45-47
• Viewfinder Displays20-21	References	
• Recording Features		• Care and Maintenance48-49
• Viewfinder22	• Trouble Checks50-52
• Flying Erase Head23	• Assistance53
• Microphone23	• Limited Warranty54-55
• Model Pro848 Only: External Microphone Jack23	• Specifications56
• DISPLAY Button23	• Information to User57
• White Balance and Iris23	• Index (Alphabetical)58-61

First-Time Operation

This section describes only the basic steps necessary to set up your camcorder to record. Refer to the other sections for detailed operation and feature options.

Assistance

The toll-free numbers are available to help you with any problem you may encounter.

Camcorder Exchange Warranty800-283-6503
Customer Service800-336-1900
Accessories800-338-0376

1. Unpack the camcorder and accessories.

- Save the packing materials and box in case you ever need to ship or store your camcorder.
- The items shown below are packed with your camcorder. If any are missing or appear damaged, contact your dealer immediately.

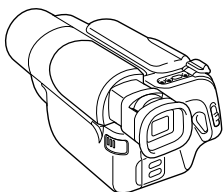

Model Pro842/Pro847/Pro848*

* Your camcorder's appearance may vary from the one shown in this manual.

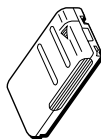

**WARNING: NICKEL
CADMIUM BATTERY
MUST BE RECYCLED
OR DISPOSED OF
PROPERLY.**

Rechargeable 6-Volt Battery
Models Pro847 and Pro848: Part No. 234330
Model Pro842: Part No. 234329



AC Adapter
Part No. 221424

Caution: Do not use this adapter for any other purpose than supplying power to this camcorder.



Shoulder Strap
Part No. 213004



Lens Cap Cord
Part No. 234328

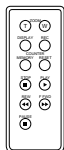

Remote control
Part No. 233195

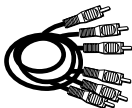

Audio/Video Output Cable
Model Pro848: Part No. 233194

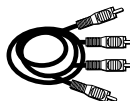

Audio/Video Output Cable
Models Pro842 and Pro847: Part No. 217496



Clock and Remote Cells
3-Volt Micro Lithium Cells – such as CR2025 – available from most local drug stores and camera shops. Use of other cells present a risk of fire or explosion.

Cautions: Lithium cells. Must be disposed of properly. Never handle punctured or leaking cells. May cause burns or personal injury. Keep out of the hands of children. Can cause death or injury if swallowed. If swallowed, consult a physician immediately for emergency treatment. The lithium cells used in these devices may explode resulting in a fire or chemical burn if mistreated. Do not recharge, disassemble, heat above 212°F (100°C), or incinerate. Never use metallic tweezers to hold the cell, and never short circuit the + and – sides of the cell.

First-Time Operation

2. Attach lens cap cord and adjust handstrap.

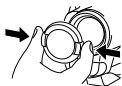

- A. Press in on the tabs on both sides of the lens cap to remove it.



- B. Attach the lens cap cord to the lens cap.

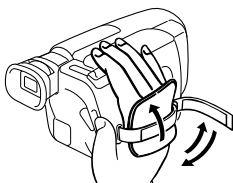

- C. Pull up the flap of the handstrap and open the strap.

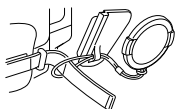

- D. Run the cord from the lens cap through the A/V terminal cover and over the end of strap.

- E. Adjust the strap for comfort and close the flap.

Note Make sure the end of the strap is positioned securely before closing the flap.

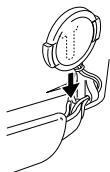

- F. Slide the lens cap onto the strap.

3. Attach shoulder strap.

- A. Unfasten one end of the shoulder strap from the buckle. Make sure you leave the buckle on the strap.

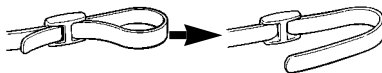

- B. Thread one end of the shoulder strap through one of the shoulder strap rings

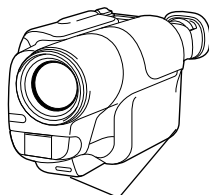

Shoulder Strap Rings

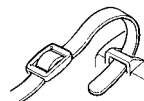

- C. Thread the strap back into the buckle *as shown below*. Pull on the strap and make sure it is fastened securely before using it to support your camcorder.

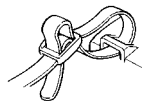

- D. Repeat steps A-C for the other end of the shoulder strap.

Cautions: When carrying the camcorder with the shoulder strap, make sure the viewfinder is in its down position. This helps prevent possible damage to the viewfinder from bumping against your body as you move.

Make sure the shoulder strap is firmly attached before using it to carry your camcorder.

First-Time Operation

4. Supply power to the camcorder.

Attach the AC Adapter

Since the battery must be charged before it can be used the first time, attach the adapter to the camcorder.

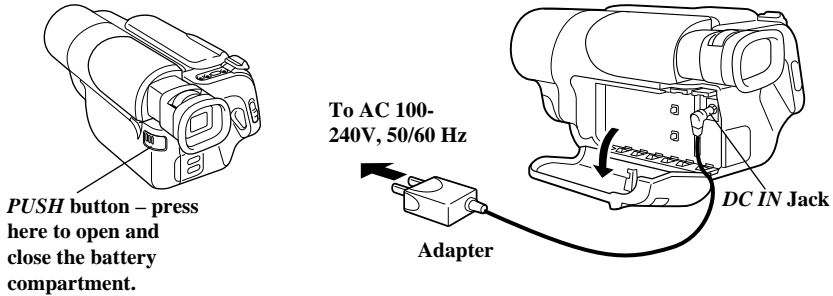

- A. Press on the *PUSH* button to release the battery compartment door. Open the compartment fully.
- B. Insert the small plug on the AC adapter in the *DC IN* jack on the camcorder.
- C. Close the battery compartment. Press the *PUSH* button to lock the battery compartment shut.
- D. Plug the AC adapter's power cord into an AC operating outlet.

Install Six Optional "AA" Alkaline Batteries

If you do not want to use the adapter, you may use six "AA" alkaline batteries.

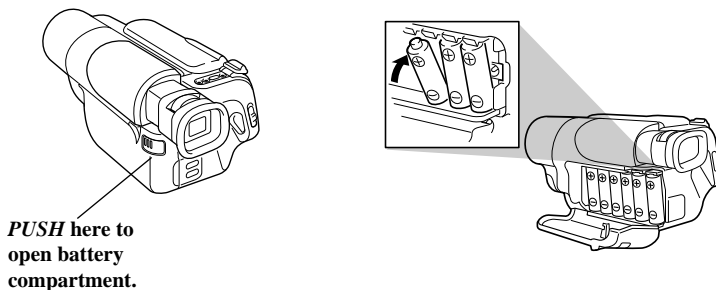

- A. Press on the *PUSH* button to release the battery compartment door. Open the compartment fully.
- B. Insert the six alkaline batteries into the compartment matching the polarities (+ and -) on the batteries to the battery compartment *as shown*.
- C. Close the battery compartment. Press the *PUSH* button to lock the battery compartment shut.

First-Time Operation

VCR (PLAY)/CAM Indicators and Button

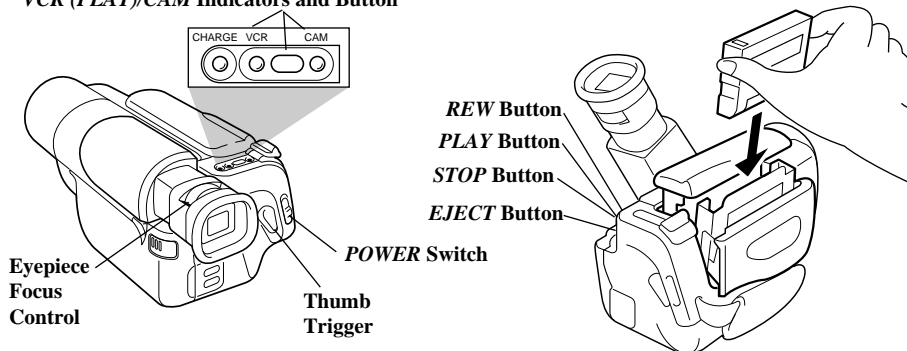

5. Turn on the camcorder.

Slide the *POWER* switch upward to turn the camcorder on.

Notes: Whenever the camcorder is turned on, it turns on in the *CAM* (camera) mode. If it does not, press the *VCR(PLAY)/CAM* button until the red *CAM* indicator beside the *VCR(PLAY)/CAM* button lights.

The green and red indicators on each side of the button let you know the mode of the camcorder. The red indicator lights when the camcorder is in the *CAM* (camera) mode and the green indicator lights when the camcorder is in the *VCR (PLAY)* mode.

6. Insert a cassette.

- Press the *EJECT* button to open the cassette compartment.
- Insert the cassette so the safety tab is at the top and the tape window faces out.
- Gently close the cassette compartment by pressing on the area labeled *PUSH* until it clicks into place. The top closes automatically. Do not press down on the top as it may damage the camcorder.

7. Adjust viewfinder focus.

Turn the eyepiece focus control right or left to obtain the clearest possible picture.

8. Start and stop recording.

- Press and release the *REC START/STOP* button (thumb trigger) to start recording. *REC* appears in the viewfinder.
- Press and release the thumb trigger again to stop recording. The camcorder is now in the record-pause mode. *PAUSE* appears in the viewfinder.

9. Play back what you have recorded.

- Press the *VCR(PLAY)/CAM* button to light the *VCR(PLAY)* indicator.
- Press *REW* to rewind the tape.
- Press *PLAY* to play back the tape.
- Press *STOP* when you are finished playing back the tape.

10. Turn off the camcorder.

Slide the *POWER* switch upward to turn off the camcorder. The *VCR(PLAY)* or *CAM* indicator will turn off.

First-Time Operation

11. Review the camcorder's controls.

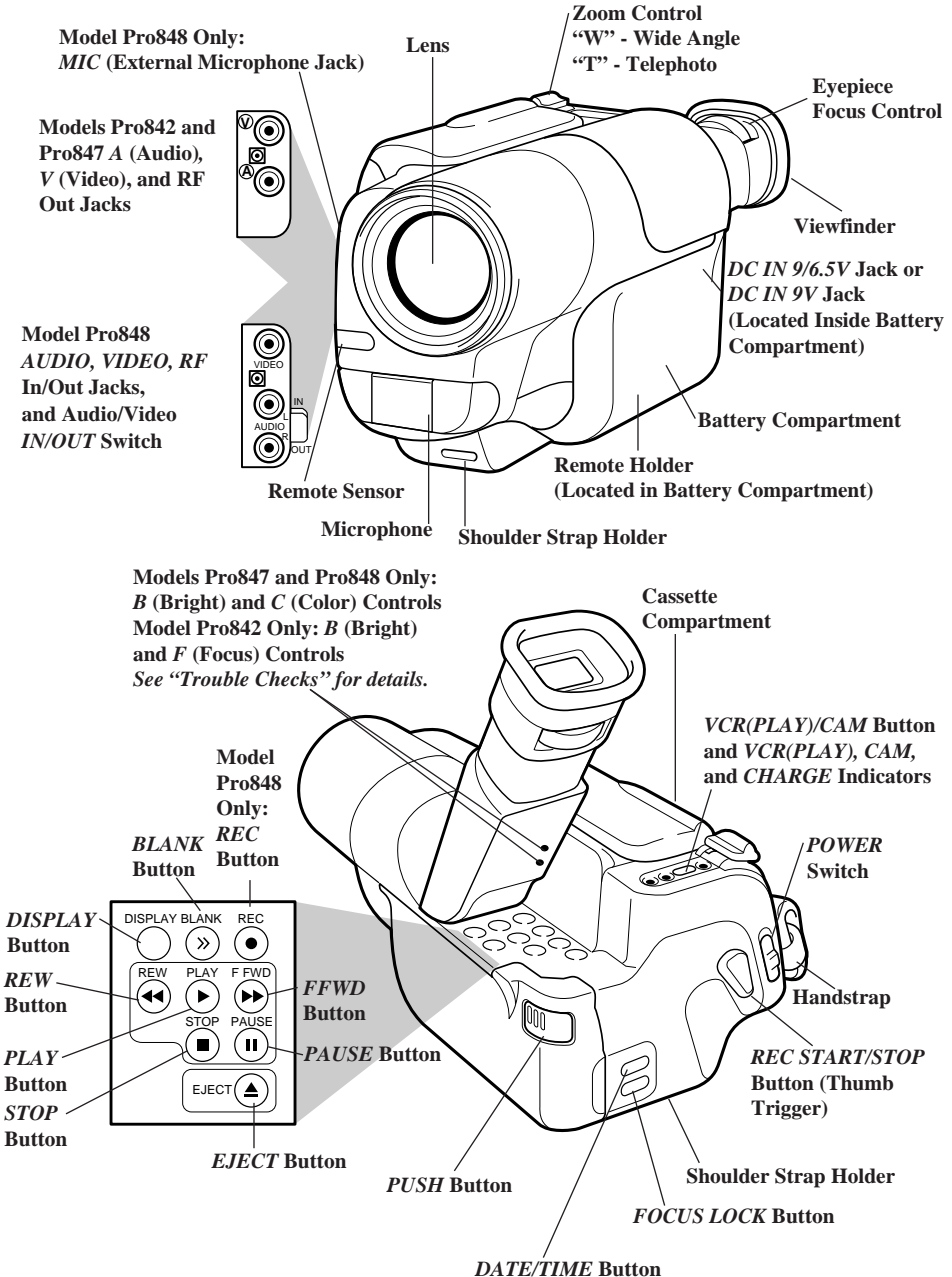

Powering Your Camcorder

Using the AC Adapter to Power Your Camcorder

The adapter lets you power your camcorder directly from standard household power. It operates on 100-240 volts, 50/60 Hz. so it can be used virtually anywhere in the world to power the camcorder.

Caution: Do not use this adapter for any purpose other than supplying power to the camcorder.

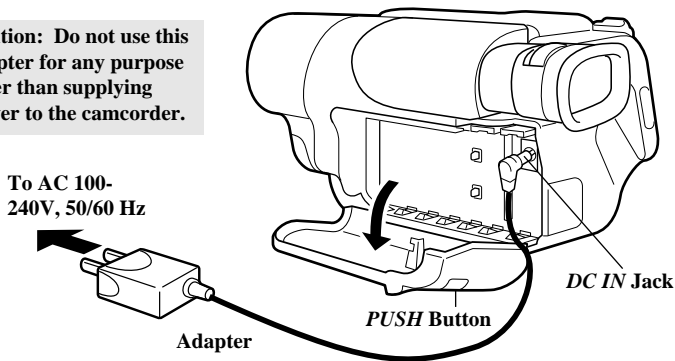

Attach the AC Adapter

1. Press the *PUSH* button to open the battery compartment. Carefully open the compartment fully.
2. Insert the small plug on the AC adapter in the *DC IN* jack on the camcorder.
3. Close the battery compartment. Press the *PUSH* button to lock the battery compartment shut.
4. Plug the AC adapter's power cord into an operating outlet.

Remove the AC Adapter

1. Unplug the adapter from the wall outlet.
2. Open the battery compartment and remove the plug from the *DC IN* jack.

Using Optional AC Plug Adapter

An optional plug adapter may be required in some countries.

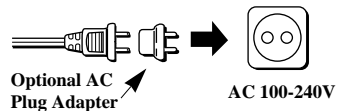

1. Plug the adapter's plug into the AC plug adapter.
2. Plug the AC plug adapter into the AC outlet.

Powering Your Camcorder

Using the Rechargeable Battery to Power Your Camcorder

The battery must be charged *as described on the next page* before it can be used the first time. Initial charging will take approximately 12 hours for the 234329 battery, and approximately 16 hours for the 234330 battery. When fully charged, the 234329 battery (model Pro842) should supply about 60 minutes of operating time and the 234330 battery (models Pro847 and Pro848) should supply about 65 minutes of operating time (depending on how much you use zoom and pause and load and unload cassettes).

Note: The small marker switch on top of the 234330 battery is for use as a personal reminder to help you remember to recharge the battery. It has no other function.

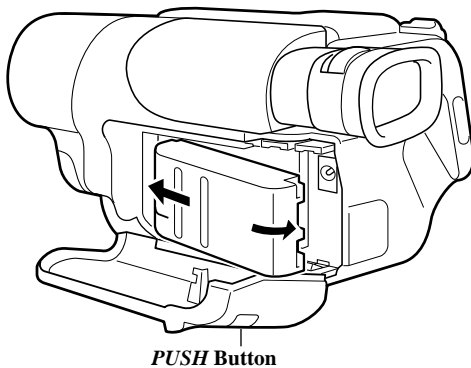

Battery Safety Precautions

Do not short the battery's terminals.

Do not attempt to disassemble or modify the battery. There are no user-serviceable parts inside.

Use the battery only with specified adapter/chargers and camcorders.

Throwing the battery into a fire or exposing it to excessive heat – over 149°F (65°C) could be hazardous.

Install the Battery

1. Press the *PUSH* button to open the battery compartment. Carefully open the compartment fully.
2. Insert the battery sideways as shown and snap into place.
3. Close the battery compartment. Press the *PUSH* button to lock the battery compartment shut.

Remove the Battery

1. Press the *PUSH* button to open the battery compartment. Carefully open the compartment fully.
2. Slide the battery towards the back of the camcorder and lift out.
3. Close the battery compartment. Press the *PUSH* button to lock the battery compartment shut.

ATTENTION: The RBRC seal on the battery used in your Thomson Consumer Electronics product indicates that we are participating in a program to collect and recycle Nickel Cadmium batteries throughout the United States. Please call 1-800-8-BATTERY for information or contact your local recycling center.



Powering Your Camcorder

Using the Rechargeable Battery to Power Your Camcorder

The battery must be installed *as described on the previous page* before it can be charged.

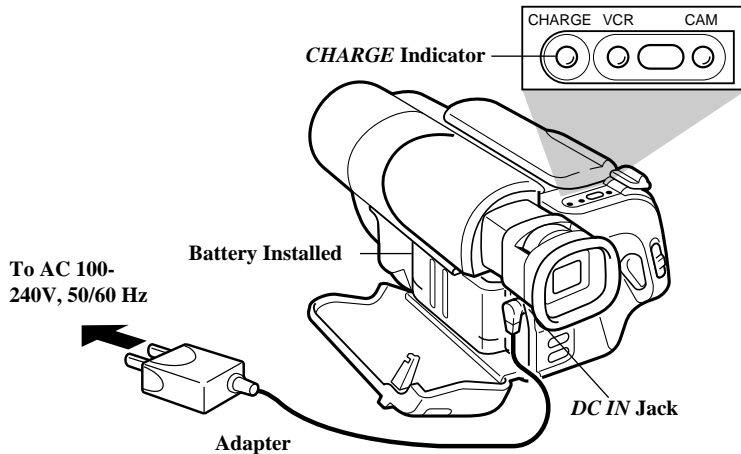

Charge the Battery

1. Install the battery *as described on the previous page*.
2. Insert the small plug on the AC adapter in the *DC IN* jack on the camcorder.
3. Plug the AC adapter into an operating AC outlet.
4. Slide the *POWER* switch down into the *CHARGE* position. The *CHARGE* indicator will light and the battery will begin charging.
5. The 234329 battery (model Pro842) takes approximately 12 hours to charge, and the 234330 battery (models Pro847 and Pro848) takes approximately 16 hours to charge.
6. When the *CHARGE* indicator starts flashing, make sure to unplug the adapter from the wall outlet and the camcorder.

Notes: After approximately 16 hours, the *CHARGE* indicator will begin flashing to remind you that the battery is charged. Your battery may be charged before the *CHARGE* indicator starts flashing.

The *CHARGE* indicator will start flashing approximately 16 hours after the *POWER* switch is placed in *CHARGE* even if no battery is being charged.

Do not charge other models of batteries with the camcorder.



Powering Your Camcorder

Battery Level Indicator

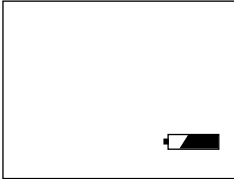
The battery level indicator appears in the viewfinder when approximately half the battery power is left. This indicator shows you the amount of power in the battery.



**Battery Level Indicator
in Viewfinder**

- As the power is used , , and  appear.

- When there is approximately five minutes of battery power left in the battery,  appears in the viewfinder. The camcorder will turn off automatically after a few minutes. Slide the *POWER* switch upward to turn off the camcorder before replacing the battery.

The battery level indicator will not be recorded on the tape when it appears in the viewfinder.

Nickel Cadmium Battery Care and Storage

Do not store a battery pack where it can reach high temperatures.

Remove the battery from the camcorder when it is not in use to prolong the battery life.

Recharge the battery just before it is used. If the battery is recharged and not used, it will slowly lose its charge.

Make sure to exhaust the charge of the battery pack completely when recording. If the battery pack is recharged when the previous charge is not completely exhausted, the charge time gradually decreases.

Charge the battery within a temperature range of 50°F to 86°F (10°C to 30°C) to prevent damage.

After repeated chargings and use, the operation time decreases gradually.

When the operation time becomes too short to be useful, it is time to replace the battery.

The operating time of the battery may be shorter than normal even after a full charge:

- If it is used for the first time.
The operating time is restored to its original level after the battery has been used two or three times (completely discharged and recharged).
- If it is used in low temperatures.
- If it is discharged completely and stored for a long period (more than three months).
- If it is stored at temperatures above 104°F (40°C).
- If the record-pause mode is used frequently.
- If excessively loading and unloading cassettes.

Powering Your Camcorder

Using Optional Alkaline “AA” Batteries

You can power the camcorder with six alkaline dry-cell “AA” batteries.

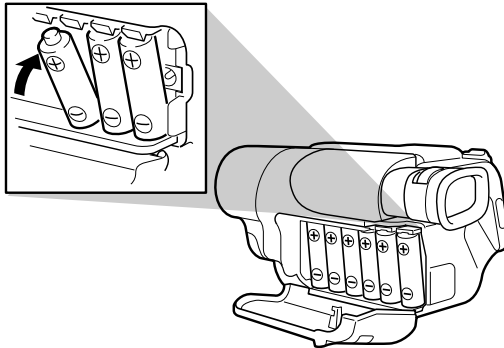

Install the Alkaline Batteries

1. Press the *PUSH* button to open the battery compartment. Carefully open the compartment fully.
2. Insert six alkaline batteries into the compartment matching the polarities (+ and –) on the batteries to the battery compartment *as shown*.
3. Close the battery compartment. Press the *PUSH* button to lock the battery compartment shut.

Notes: The camcorder may not operate properly in cold temperatures below 50°F (10° C).

The camcorder and battery level indicator may not operate properly when the batteries need to be replaced.

Remove the batteries if you will not be using the camcorder for a long period of time to extend the useful life of the batteries.

Safety Precautions When Using Alkaline Batteries

Do not short, disassemble, heat, or throw the batteries into a fire.

Do not recharge the batteries or short the battery terminals.

Do not short the battery terminals for the nickel cadmium battery.

Batteries become warm during and after use. Use caution when removing them.

Use “AA” alkaline batteries only during their recommended lifetime.

Remove at least one battery if you will not be using the camcorder for a long period of time to extend the useful life of the batteries.

Do not use manganese batteries to power the camcorder.

To reduce the risk of battery leakage or an explosion:

- Make sure battery is inserted with correct polarity.
- Remove the batteries from the camcorder before storing it.
- Do not use old and new batteries at the same time.
- If the batteries leak, remove the batteries and carefully wipe up the fluid.
- Keep the terminals clean. Use a dry cloth to wipe any dirt off the terminals.

Powering Your Camcorder

Using the Optional AC Adapter/Charger

The optional CPS801C AC adapter/charger *shown on page 43* will power the camcorder and charge your rechargeable nickel cadmium battery.

To AC Wall Outlet

100-240 Volts, 50/60 Hz.

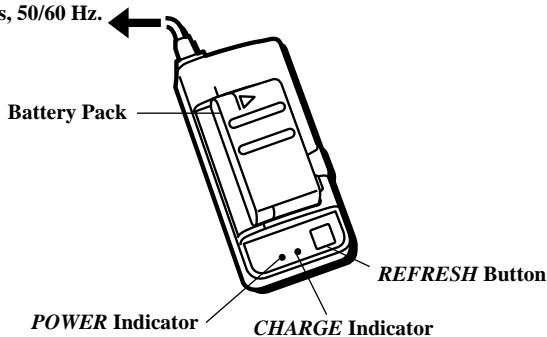

Caution:
When a battery is attached to the adapter/charger, do not turn them upside down. The battery may fall off and be damaged or cause injury.

Charging and Refreshing Rechargeable Battery

The battery pack provides longer operation time if it is refreshed (completely discharged) before every charging. Refreshing takes approximately 3-1/2 hours.

Charge the Battery

1. Plug adapter/charger into an AC outlet (100-240V, 50/60Hz).

The *POWER* indicator lights.

2. Align the reference marks on the battery with marks on the adapter/charger and slide the battery in the direction of the arrow until it locks. The *CHARGE* indicator lights while battery is charging.

3. Remove the battery when the *CHARGE* indicator turns off.

Notes: Make sure AC power cord is removed from the outlet when finished.

If the *CHARGE* indicator flashes rapidly, this may indicate the battery is improperly

installed. Remove it and try again. If the *CHARGE* indicator still flashes rapidly, it may indicate the battery pack cannot be used.

Refresh the Battery

1. Plug in the adapter/charger and attach the battery.
2. Press *REFRESH*.

The *CHARGE* indicator flashes slowly and any remaining charge in the battery is discharged. The *CHARGE* indicator then stops flashing and the battery pack is recharged.

3. Remove the battery when the *CHARGE* indicator turns off.

Powering Your Camcorder

Power the Camcorder

The optional CPS801C AC adapter/charger and optional DCC100 DC cable let you power your camcorder directly from standard household power. It operates on 100-240 volts, 50/60 Hz, so it can be used virtually anywhere in the world to power the camcorder or recharge your battery pack. You may need a plug adapter in some countries. Consult your dealer.

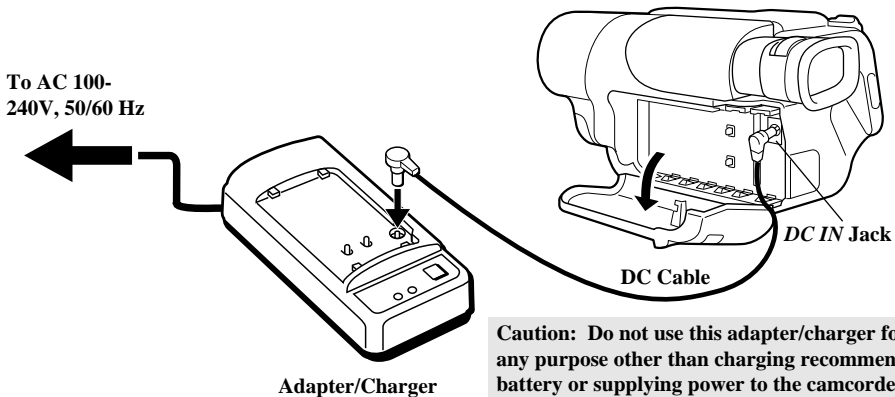

Caution: Do not use this adapter/charger for any purpose other than charging recommended battery or supplying power to the camcorder.

Attach Adapter/Charger

1. Press the *PUSH* button to open the battery compartment. Carefully open the compartment fully.
2. Plug one end of the optional DC cable into the *DC OUT* jack on the adapter/charger and the other end into the *DC IN* jack on the camcorder.
3. Close the battery compartment. Press the *PUSH* button to lock the battery compartment shut.
4. Plug the AC adapter/charger power cord into an AC operating outlet. The adapter/charger's *POWER* indicator lights.

Remove the Adapter/Charger

1. Unplug the adapter/charger from the wall outlet.
2. Disconnect the DC cable from the camcorder and adapter/charger.

Using Optional AC Plug Adapter

An optional plug adapter may be required in some countries.

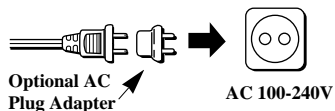

1. Plug the adapter/charger's plug into the AC plug adapter.
2. Plug the AC plug adapter into the AC outlet.

Powering Your Camcorder

Lithium Cell Installation

The remote's lithium cell is packed separately. Install it as follows:

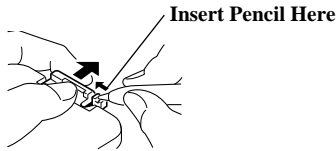

1. Turn remote over, insert a pencil or paper clip in the small hole, and slide cell holder in the direction of the arrow to remove it.

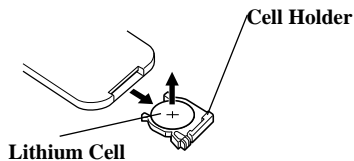

2. Insert the cell in the cell holder so the positive (+) terminal faces up.

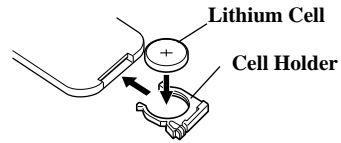

3. Replace cell holder in remote until it clicks into place.

Notes: Never place anything heavy on top of the remote control or lay it upside-down.

Replace cell when camcorder fails to respond to remote.

Remove cell from remote if it will not be used for a month or more. This will prevent possible damage from cell leakage. If leakage occurs, wipe up liquid inside compartment and replace cell.

Cautions: Lithium cell. Replace only with 3-volt lithium cell – such as CR2025. Use of other cell presents a risk of fire or explosion. Must be disposed of properly. Never handle punctured or leaking cell. May cause burns or personal injury.

Keep out of the hands of children. Can cause death or injury if swallowed. If swallowed, consult a physician immediately for emergency treatment.

The lithium cell used in this device may explode resulting in a fire or chemical burn if mistreated. Do not recharge, disassemble, heat above 212°F (100°C), or incinerate.

Never use metallic tweezers to hold the cell, and never short circuit the + and – sides of the cell.

Remote Control

Remote Sensor

The remote operates the camcorder by infrared light, so it is protected from electrical and sound interference. However, the remote must be aimed directly at the camcorder's remote sensor. There cannot be any obstructions between them.

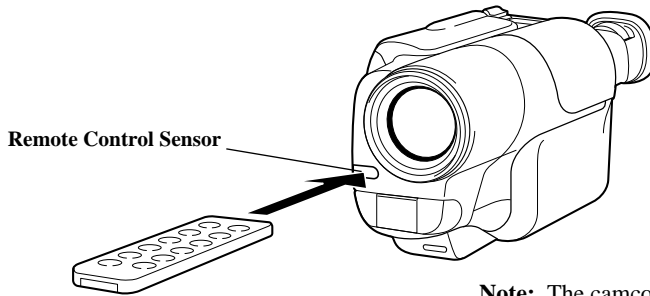

Note: The camcorder may not respond to the remote if its sensor is exposed to direct sunlight or strong artificial light.

Storing the Remote Control

When you are not using the remote control you may want to store it in the remote control holder located in the camcorder's battery compartment.

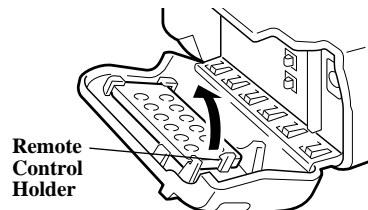
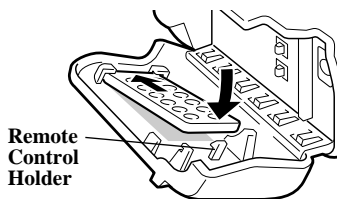

Store the Remote Control

1. Press the *PUSH* button to open the battery compartment. Carefully open the compartment fully.
2. Insert the remote control in the remote control holder and click it into place *as shown*.

Remove the Remote Control

1. Press the *PUSH* button to open the battery compartment. Carefully open the compartment fully.
2. Carefully pull back the remote control holder, and lift the remote control *as shown*.

Remote Control

A brief description of the remote button's functions is given here. Many of the buttons perform the same functions as the corresponding controls on the camcorder. The battery must be installed *as shown on page 14*.

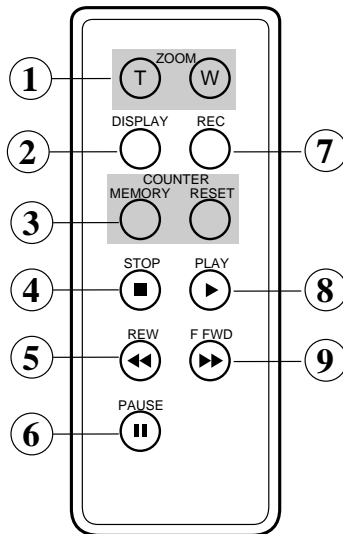

① ZOOM (*T* and *W*) Buttons

During record or record pause:

- Press *T* to move the lens in the telephoto (close-up) direction.
- Press *W* to move the lens in the wide-angle direction.

② DISPLAY Button

Press this button to have the viewfinder displays appear on a TV monitor.
Details are on pages 23, 37 and 39.

③ COUNTER MEMORY and RESET Buttons

Used with the time counter and memory stop feature. *Details are on page 30.*

④ STOP Button

When the camcorder is in *VCR (PLAY)* mode, press *STOP* to stop playback, rewind, or fast-forward operation.

Remote Control

⑤ **REW (Rewind) Button**

Camcorder is in *CAM* (camera) mode:

- When the camcorder is in record pause, press and hold *REW* to visually search the tape in reverse. Release *REW* to return to record-pause.

Camcorder is in *VCR(PLAY)* mode:

- When the camcorder is stopped, press *REW* to rewind the tape. Press *STOP* to stop rewinding the tape.
- When a tape is playing, press and hold *REW* to visually search in reverse. Release *REW* to return to normal playback.

⑥ **PAUSE Button**

During playback, press *PAUSE* to produce a stop-action picture. Press *PAUSE* or *PLAY* to return to normal playback.

Caution: Pause is designed for momentary interruptions and should not be used for an extended period of time. If the camcorder remains in pause for more than three minutes, it will automatically enter the stop mode and then turn off.

⑦ **REC (Record) Button**

When the camcorder is in *CAM* (camera) mode, press *REC* to start and stop recording.

⑧ **PLAY Button**

Press *PLAY* when the camcorder is in *VCR (PLAY)* mode to begin playback.

⑨ **F FWD (Fast Forward) Button**

Camcorder is in *CAM* (camera) mode:

- When the camcorder is in record pause, press and hold *F FWD* to visually search the tape forward. Release *F FWD* to return to record-pause.

Camcorder is in *VCR(PLAY)* mode:

- When the camcorder is stopped, press *F FWD* to fast forward the tape. Press *STOP* to fast forwarding the tape.
- When a tape is playing, press and hold *F FWD* to visually search forward. Release *F FWD* to return to normal playback.

Recording

Video Cassettes

We recommend that our cassettes be used with your camcorder. Use of poor quality or damaged tapes can contaminate the video heads. Head cleaning is not covered under warranty and is considered normal maintenance.

Inserting or Removing Cassettes

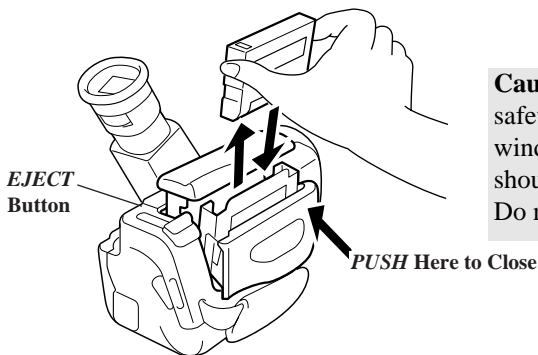

Caution: Insert the cassette so the safety tab is at the top and the tape window is facing out. The cassette should slide easily in the compartment. Do not force the cassette.

1. Attach a power supply and turn on the camcorder.
2. Press the *EJECT* button to open the cassette compartment.
3. Insert the tape with the safety tab on top and the tape window facing out.
4. Gently press the compartment where it is labeled *PUSH* until it clicks into place. The top closes automatically.

CAUTION: Do not press down on the top or you may damage your camcorder.

Erase Protection — Safety Tab

You can protect your video cassettes from being erased by closing the safety tab. To erase a previous recording, open the safety tab and record over it.

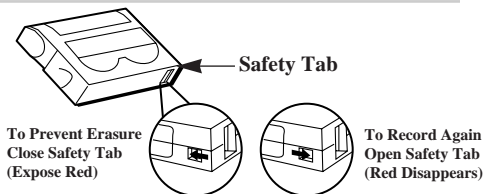

Recording Times

The camcorder records in standard speed (SP). See the chart for the maximum SP recording times for some 8mm cassettes.

Cassette	Recording Time
P6-15	15 Minutes
P6-20	20 Minutes
P6-45	45 Minutes
P6-60	60 Minutes
P6-90	90 Minutes
P6-120	120 Minutes
P6-150	150 Minutes

Recording

Making a Recording

The steps below tell you how to make a recording and suggest using some of the recording features. Each feature is described in detail *on the following pages*.

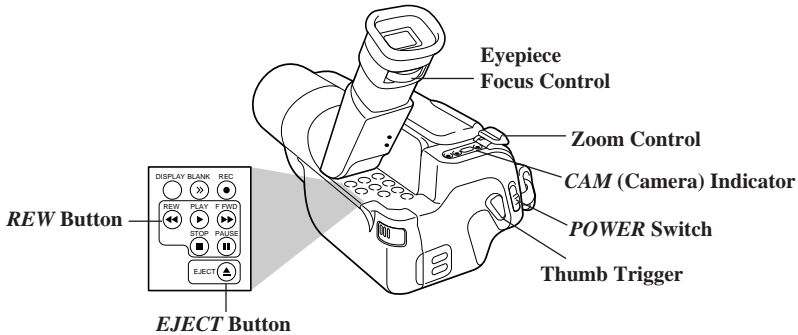

To Make a Recording:

1. Attach a power supply.

Attach the adapter, charged battery, or install optional "AA" alkaline batteries.

2. Remove the lens cap and attach it to the handstrap.

3. Slide the **POWER** switch upward to turn on the camcorder.

The **CAM** indicator will light and the camcorder will enter the record pause mode. **PAUSE** appears in the viewfinder

4. Insert a video tape.

- Press **EJECT**.
- Insert the cassette with safety tab facing up and the tape window facing out.

5. Adjust the viewfinder and eyepiece focus control for your vision.

6. Start and stop recording.

- Press and release the thumb trigger (**REC START/STOP** button) to start recording. **REC** appears in the viewfinder.

- Press and release the the thumb trigger again to stop recording. The camcorder is now in record pause. **PAUSE** appears in the viewfinder.

- The camcorder will automatically turn off if it remains in record pause for three minutes. Slide the **POWER** switch upward to turn the camcorder back on.

7. Use the zoom feature.

- Zoom in and out using the zoom control.

8. Review what you have recorded.

- Press and release **REW** to review the last few seconds of the recording.
- Press and hold **REW** or **FFWD** to visually see what you have recorded. Release the button to begin recording at that point.

9. When you are finished, slide the **POWER** switch upward to turn off the camcorder. Replace the lens cap.

Recording

Viewfinder Displays

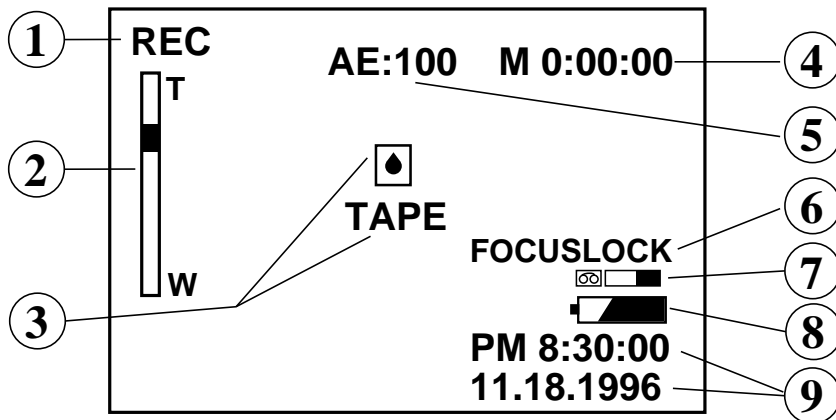

1 Status Displays



- The *REC* indicator appears when the camcorder is recording.
- The *PAUSE* indicator appears during record pause.
- The *FF* indicator appears during fast forward.
- The *REW* indicator appears during rewind.
- The *STOP* indicator appears when the camcorder is stopped.
- The *BLANK* indicator appears during blank search operation.

2 Zoom Indicator

The zoom indicator appears here when you use the zoom control.

- *Details on page 25.*

3 Warnings and Information

- *TAPE* appears during recording when there is approximately five minutes of tape left.
- *TAPE END* appears when the end of the tape is reached during recording or a cassette is inserted with its tape already at the end.
-  appears when the safety tab on the cassette has been closed, there is no cassette in the camcorder, or condensation has formed inside the cassette or camcorder.
-  indicator appears when excessive moisture (condensation) has entered the camcorder. The camcorder will not operate when this indicator appears. Place the camcorder in a warm, dry area until this indicator disappears.

Recording

④ Elapsed Time-Counter

- The time counter appears during recording and playback.
- An “M” appears in front of the time counter when memory-stop is on.
- *Details are on page 30.*

⑤ AE (Auto Exposure) Higher Shutter Speed Indicator

A shutter speed (1/60, 1/100, 1/150, or 1/250) is automatically selected by the camcorder.

- No indicator appears for 1/60 second shutter speed.
- *AE:100, AE:150, or AE:250* will appear when the higher shutter speed has been selected by the camcorder.

⑥ FOCUSLOCK (℥) Indicator

One of these indicators appears when the focus has been locked.

- *Details on page 26.*

⑦ Tape Time Remaining Indicator

This indicator shows the approximate amount of tape remaining in the cassette.

- *Details on page 23.*

⑧ Battery Level Indicator

This indicator shows how much power is left in the rechargeable battery.

- *Details are on page 10.*

⑨ AUTO DATE, Date, Date and Time, or 88:88

AUTO DATE, date, or date and time appears in this area of the viewfinder when you press the *DATE/TIME* button.

- These displays will be recorded on your tape when they appear.
- *Details are on pages 28-29.*
- *88:88* appears here when the clock lithium cell has not been installed or needs to be replaced. *Details are on page 27.*

Recording

Viewfinder

The camcorder's viewfinder is a miniature monitor that displays the picture seen by the camcorder when recording.

Adjust Viewfinder for Convenient Viewing

For convenient viewing, you can rotate the viewfinder up and down.

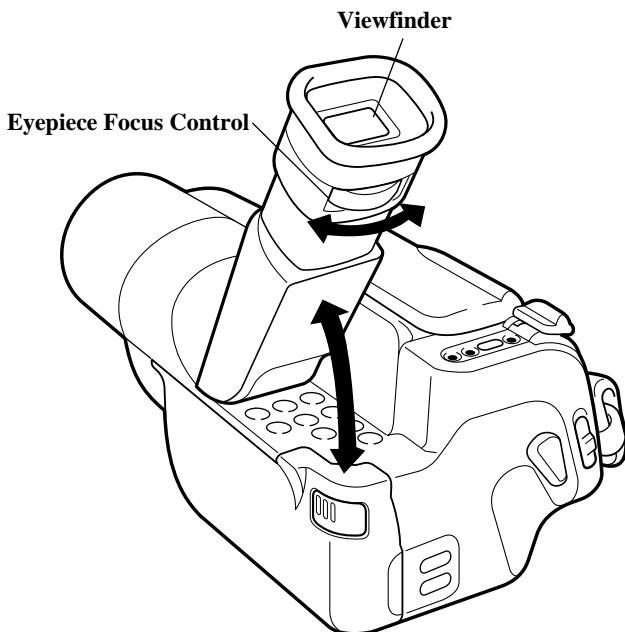

Cautions

Do not force the viewfinder to rotate completely around. This will damage the viewfinder and/or the camcorder.

When carrying the camcorder with the shoulder strap, put the viewfinder down. This helps prevent possible damage to the viewfinder from bumping against your body as you move.

Eyepiece Focus Control

The eyepiece focus control lets you set the focus of the viewfinder for your personal vision. If you wear eye glasses, you probably can operate the camcorder without them.

It is easiest to set the correct focus by focusing on one of the viewfinder's on-screen displays.

Recording

DISPLAY Button

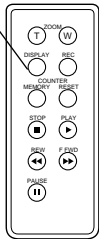

DISPLAY Button

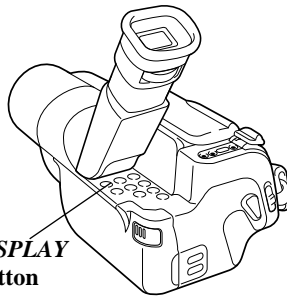

Model Pro848 Only MIC (External Microphone Jack)

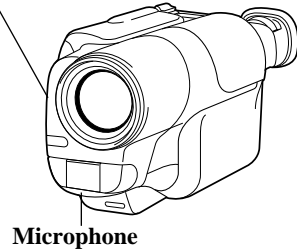

Flying Erase Head

A separate erase head is mounted on the spinning headwheel (hence the term “flying”). This allows you to make clean edits without the “glitches” or “rainbow noise” that may occur at the beginning or the end of recordings.

Microphone

The microphone picks up the sound during a recording. It is more sensitive to sounds coming from the direction the lens is pointed.

Model Pro848 Only: External Microphone Jack

The camcorder has an external microphone jack (*MIC*) for attaching an optional microphone.

DISPLAY Button

Press the *DISPLAY* button when the camcorder is connected to a TV monitor to have the viewfinder displays appear on the TV screen. They will be recorded during tape copying if they appear. Press *DISPLAY* again to remove them.

Automatic White Balance and Iris



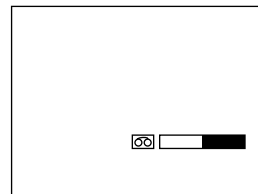

The camcorder automatically adjusts the white balance and iris to give you the best recording for each scene.

Tape Time Remaining Display

The camcorder will automatically calculate the tape time remaining on the cassette in the camcorder during recording or playback. The indicator will appear in the viewfinder at the halfway point of the tape.



Viewfinder Display

  and   appear as you near the end of the tape.

TAPE END flashes when you have reached the end of the tape.

Recording

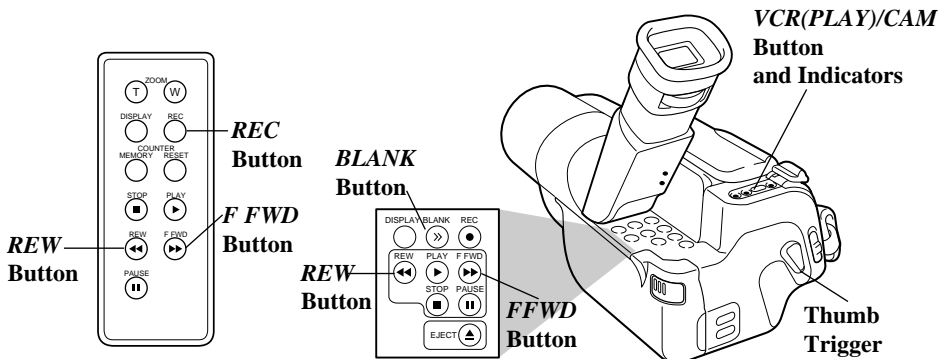

Quick Review Feature

Press and quickly release *REW* when the camcorder is in record pause to review the last few seconds of a recording. The *VCR(PLAY)/CAM* button must be in the *CAM* position.

The camcorder will play back the last few seconds of the recording, return the tape to its previous position, and return to record pause.

Camera Edit Feature

The camera edit feature allows you to position the tape when the camcorder is in record pause. The *VCR(PLAY)/CAM* button must be in the *CAM* position.

- Press and hold *REW* to visually search the recorded tape in reverse.
- Press and hold *F FWD* to visually search forward on the recorded tape.

Release the button to return the camcorder to record pause at that point on the tape. Press the thumb trigger (*REC* on remote) to start recording at this point.

Blank Search

With the press of a button, the camcorder advances through the tape looking for a blank section. This feature saves time and tape by locating the end of the last recorded segment.

1. Place the camcorder in record pause.
2. Press the *BLANK* button.

The camcorder fast forwards or rewinds the tape to the end of the recorded portion, stops, and enters record pause. *BLANK* appears in the viewfinder during blank search.

Notes: Before starting to record, make sure the camcorder has stopped on the blank section of tape where you want to begin recording. If there are blank portions of tape between scenes, the blank search feature may stop on blank sections of tape as short as 60 seconds.

Blank search can also be used in the *VCR(PLAY)* mode. When the camcorder is being used to play back a tape, just place the camcorder in the stop mode and press *BLANK*.

Recording

Zooming

You can zoom in and out for close ups or wide-angle shots just by sliding the zoom control on the camcorder or pressing the button on the remote. The camcorder can automatically focus when you zoom at most distances.

ZOOM T and W Buttons

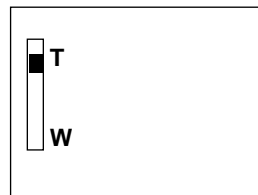
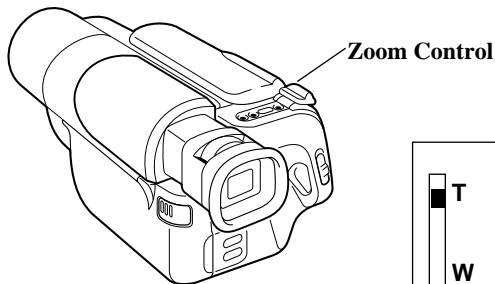
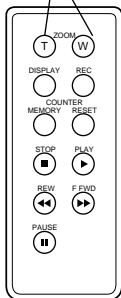

Viewfinder Display

Using the Zoom Control

1. To zoom in or out, slide the zoom control on the camcorder or press the *ZOOM T* or *W* button on the remote.
 - To move the lens in the telephoto (close-up) direction, slide the zoom control toward *T* or press the *ZOOM T* button on the remote.
 - To move the lens in the wide angle direction, slide the control toward *W* or press the *ZOOM W* button on the remote.

The zoom level indicator appears in the viewfinder.

AE (Automatic Exposure) Shutter Speed Control

The camcorder automatically adjusts the shutter speed (1/60, 1/100, 1/150, or 1/250) according to the lighting conditions.

- 1/60 second shutter speed is selected for normal recording situations. No indicator appears in the viewfinder.
- If recording in bright lighting conditions, *AE:100*, *AE:150*, or *AE:250* will appear in the viewfinder.

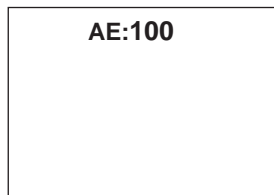

Viewfinder Display

Recording

Focusing

Under normal conditions, the camcorder can adjust focus automatically on the object located in the center area of the viewfinder. Under certain conditions, you may want to use the focus lock feature.

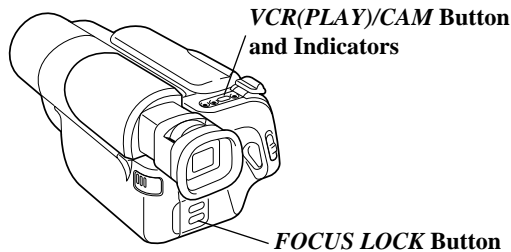

Using Focus Lock

The focus lock feature is useful when objects pass between your subject and the camcorder or your main subject is not located in the center of the viewfinder.

1. Center the main object in the viewfinder.
2. Press *FOCUS LOCK* to turn on the focus lock feature. *FOCUSLOCK* will appear for a few seconds and then Ψ will remain in the viewfinder.

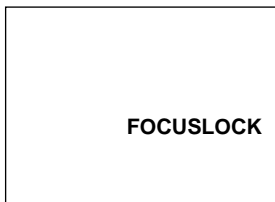

3. Press *FOCUS LOCK* again to turn off the focus lock feature. Ψ will be removed from the viewfinder.

Note: When zooming in to record a subject in the distance, auto focus might not function properly because of picture instability. Use a tripod for stable focused pictures.

Conditions Requiring Focus Lock

- When recording a subject through a dirty window.
- When recording two subjects, one nearby and one in the distance.
- When recording a horizontally or vertically striped subject.
- When the subject is not in the center of the viewfinder.
- When recording very bright subjects.
- When recording a subject without contrast, such as, a white wall.

Recording

Install the Clock Lithium Cell

The clock cell indicator 88:88 will flash for a few seconds in the viewfinder when you turn on the camcorder if the cell has not been installed or needs to be replaced.

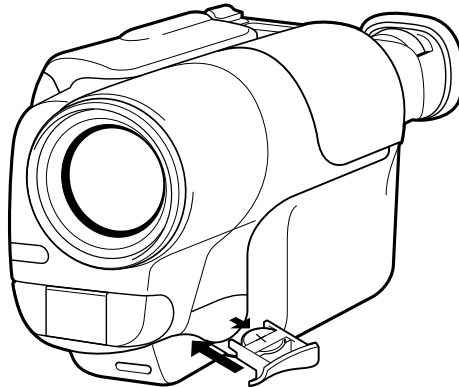

**Clock Cell
Holder**

Install Cell

1. Make sure camcorder is turned off, and remove any power supply attached to the camcorder.
2. Pull out the clock cell holder.
3. Insert the clock cell with the “+” terminal facing up in the cell holder.
4. Replace the clock cell holder. It will click into place.

Remove Cell

To remove cell, slide the cell out of the cell holder.

Cautions: Lithium cell. Replace only with 3-volt lithium cell – such as CR2025. Use of other cell presents a risk of fire or explosion. Must be disposed of properly. Never handle punctured or leaking cell. May cause burns or personal injury. Keep out of the hands of children. Can cause death or injury if swallowed. If swallowed, consult a physician immediately for emergency treatment.

The lithium cell used in this device may explode resulting in a fire or chemical burn if mistreated. Do not recharge, disassemble, heat above 212°F (100°C), or incinerate. Never use metallic tweezers to hold the cell, and never short circuit the + and – sides of the cell.

Recording

Set the Date and Time

The date and time must be set before it can be displayed and recorded on your tapes. The clock cell must be installed *as shown on page 27* before the date can be set and recorded.

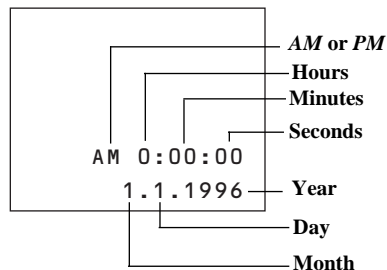
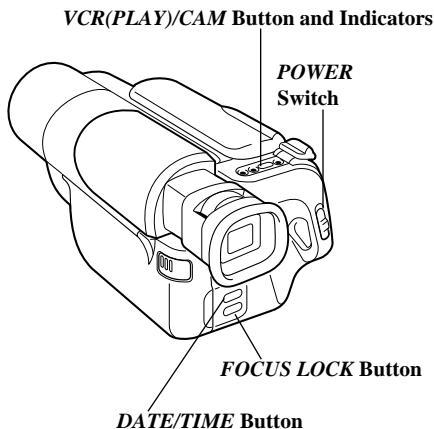

1. Attach a power supply to the camcorder. Slide the **POWER** switch upward to turn on the camcorder. Make sure the **CAM** indicator is on, if not, press the **VCR(PLAY)/CAM** button to turn it on.
2. Press and hold down the **DATE/TIME** and **FOCUS LOCK** buttons until the reset time and date appears.
3. A flashing cursor lets you know which part of the display you are setting. Press the **DATE/TIME** button repeatedly until the correct month appears.
4. Then press **FOCUS LOCK**. The flashing cursor will move to the next part of the display.
5. Repeat steps 3 and 4 until you have entered the correct month, day, year, hour with AM or PM, and minutes.
6. After you set the minutes, press **FOCUS LOCK** to start the seconds and remove the flashing cursor from the viewfinder.

Correct the Date or Time

To correct the date or time after the clock has been started, simultaneously press the **DATE/TIME** and **FOCUS LOCK** buttons. Then correct the date or time using the **DATE/TIME** and **FOCUS LOCK** buttons.

Recording

Recording Date or Date and Time on Your Tape

The date or date and time can be recorded on your tape. Whenever one of the displays appears in the viewfinder, it will be recorded. The camcorder also has an *AUTO DATE* feature.

The clock cell must be installed and the clock set.

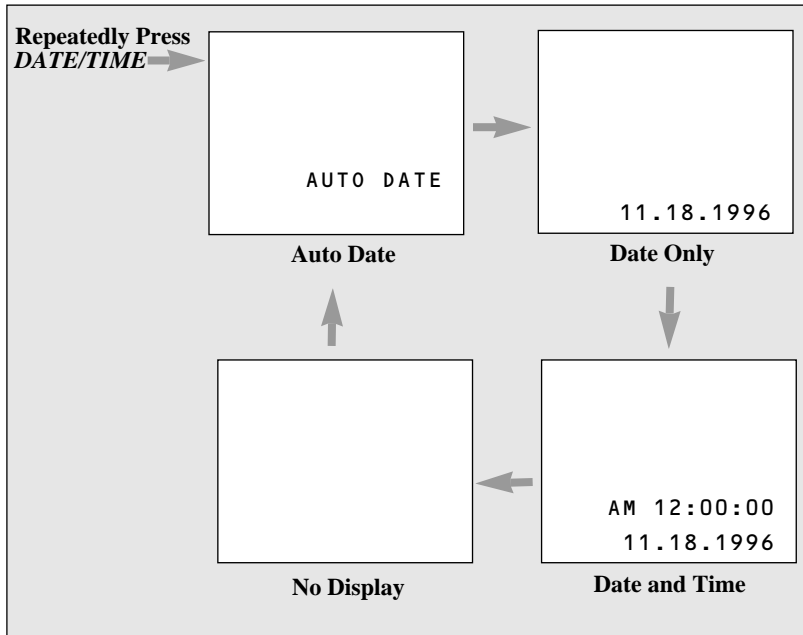

Select the Display to Record

1. Repeatedly press *DATE/TIME* to select the display you want to record.
 - Select *AUTO DATE* to automatically record the date for 15 seconds at the beginning of the first recording of the day.
 - Note: *AUTO DATE* will remain selected even if the *POWER* switch is turned off.
 - Select date only to continuously record the date.
 - Select date and time to continuously record the date and time.
 - Select no display if you do not want any of the displays recorded.

Recording

Time Counter

The time-counter display shows the actual time elapsed when recording or playing back a segment of tape. During playback, the memory-stop feature helps locate a certain point on the tape. When memory stop is on, the tape will stop automatically during rewind or fast forward when the time counter reaches *M 0:00:00*.

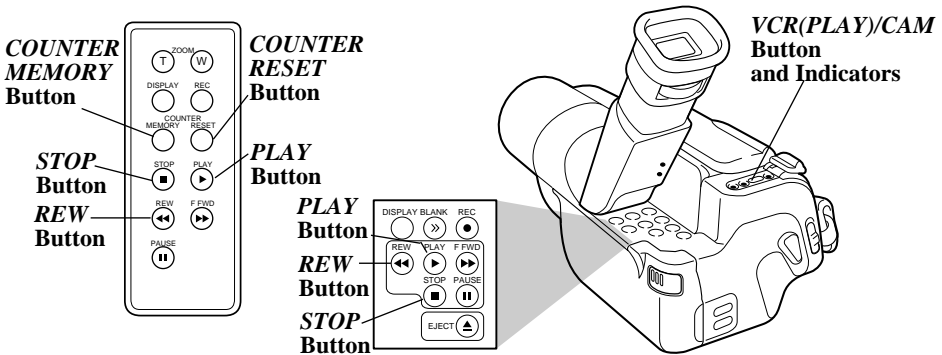

To Use the Memory-Stop Feature

1. Locate the place on the tape you want to return to, press the **VCR(PLAY)/CAM** button to light the green **VCR(PLAY)** indicator, and press **PLAY**.
2. Press **COUNTER RESET** on the remote control to reset the time counter to *0:00:00*.
3. Press **COUNTER MEMORY** on the remote control to turn the time counter's memory-stop feature on. When memory stop is on, an *M* appears before the time counter in the viewfinder.
4. Continue to play the tape. When you want to return to the place you marked, press the **STOP** button.
5. Press **REW**. The tape will rewind to the time counter reading of *M 0:00:00*.

Notes: During rewind, the tape might not stop exactly at the *M 0:00:00* point. A minus (-) will appear in front of the time counter if the tape is rewound farther back than a time counter reading of *0:00:00*.

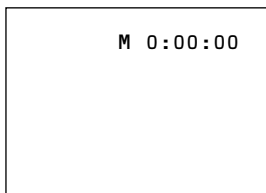

**Time Counter With
Memory Stop Turned On**

Recording

Recording Tips

- In case of fire or theft, make a video recording of your home and contents to store in a safe place.
- Try to make sure indoor scenes are well-lit.
- Do not move the camcorder rapidly from side-to-side while recording. A steady, gradual “pan” avoids blurring and “jitter”.
- Use the viewfinder to make sure the camcorder is level while recording or your scenes will appear “tilted”.
- Do not bump or tap the camcorder’s microphone while recording because this sound will be recorded.
- Include close-ups of individuals when taping family outings or group functions.
- Be aware of video and audio backgrounds. Background details barely noticed while you are taping may show up as visual “clutter” on your recording. Background noises (especially TV sets, radios, household appliances, traffic sounds, etc.) can detract from the sound you want to record.
- Avoid long “still” shots of landmarks and scenic attractions. Recordings are more interesting if they include people and details. “Local color” will give travel videos lasting appeal. Consider recording a familiar or landmark scene from an unfamiliar vantage point.

Traveling Tips

- Write down your camcorder’s serial number and keep it separate from the camcorder when traveling. If your camcorder is lost or stolen, you will be able to identify it.
- Use extra care to avoid damage to your camcorder and accessories when operating them at a beach or pool. Spray, sand, and dust should be avoided. If your lens has been exposed to the elements, clean it only with proper lens cleaning supplies.
- Make sure you have any plug adapters that you may need before taking your camcorder to other countries. Consult your dealer for advice.
- Carry your camcorder in a carrying case when traveling. *See page 42* for a case designed especially for this camcorder. An ordinary suitcase or carry bag does not offer the protection your camcorder needs. Treat your camcorder as carry-on luggage to protect it from rough handling.

Recording

Model Pro848 Only: Recording from a TV or VCR

To record on your camcorder from a TV or VCR having *AUDIO/VIDEO OUT* jacks, use the audio/video cable that came packed with your camcorder.

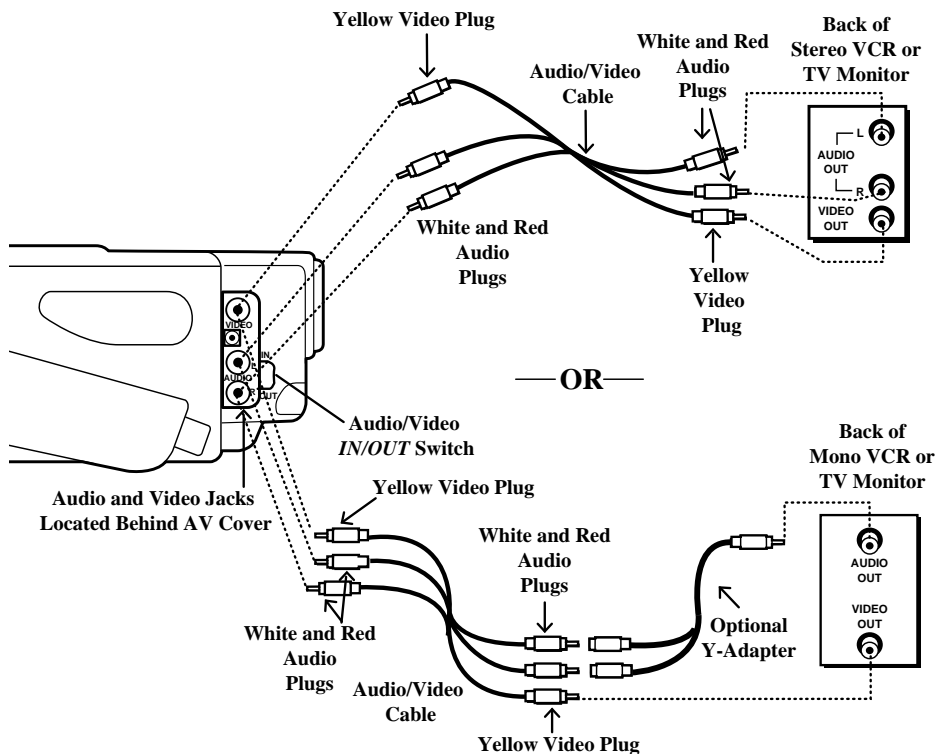

(continued on next page)

Recording

Connection

1. Attach the white plug on one end of the included audio/video cable to the *AUDIO OUT L* jack on the TV or VCR and the other white plug to the white *AUDIO L* jack under the A/V cover.
2. Attach the red plug on one end of the included audio/video cable to the *AUDIO OUT R* jack on the TV or VCR and the other red plug to the red *AUDIO R* jack under the A/V cover.
Note: If your TV or VCR is not stereo, you may need an optional Y-adapter.
3. Attach the yellow plug on one end of the included audio/video cable to the *VIDEO OUT* jack on the TV or VCR and the other yellow plug to the yellow *VIDEO* jack under the A/V cover.

Caution: The unauthorized recording of television programs and other recorded material may infringe the rights of others.

Operation

1. A. Camcorder connected directly to TV monitor: Turn on the TV and tune it to the channel you want to record.
B. Camcorder connected to the VCR that is already connected to TV: Turn on VCR and tune it to the channel you want to record (or place the cassette you want to copy in the VCR).
2. Place the camcorder's audio/video *IN OUT* switch to *IN*.
3. Place the tape you want to record on (with safety tab open) into the camcorder.
4. Attach a power supply to the camcorder.
5. Slide the camcorder's *POWER* switch upward to turn on the camcorder.
6. Press the *VCR/CAM* button to place the camcorder in playback. The green *VCR* indicator will light.
7. Press the *REC* button on the camcorder (located under the viewfinder) to begin recording.
If you are copying a tape, press *PLAY* on the VCR when you are ready to start copying.
8. Press *STOP* when you are finished.

Playback

Viewfinder Playback and Features

Viewfinder playback is the simplest way to watch tapes using the camcorder.

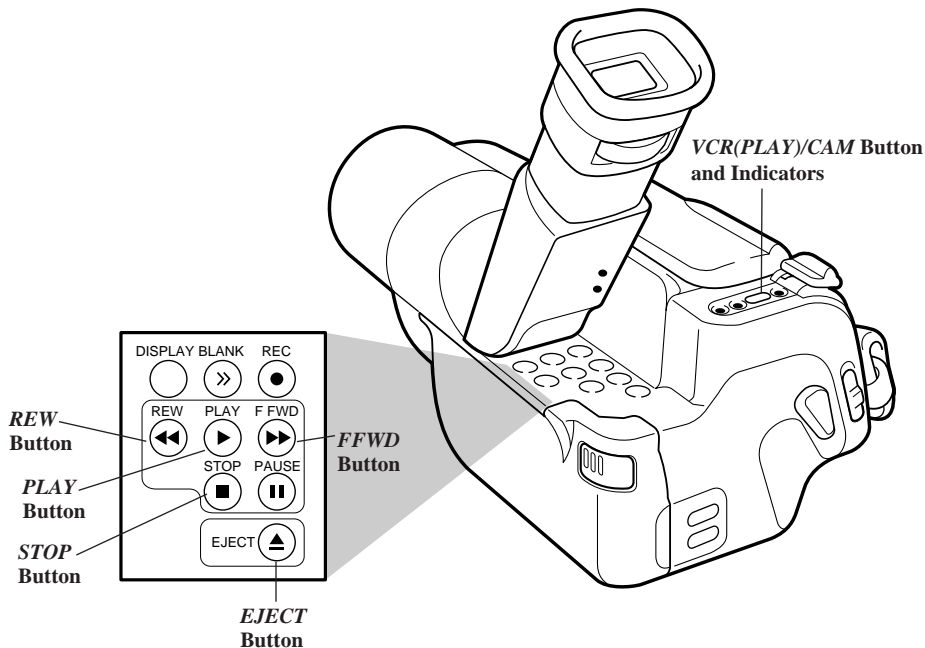

Viewfinder Playback

1. Slide the *POWER* switch upward to turn on the camcorder.
2. Press the *VCR(PLAY)/CAM* button to put the camcorder in the playback mode. The green *VCR(PLAY)* indicator will light.
3. Press *EJECT* and insert the cassette you want to play back. Close the cassette compartment.
4. Press *PLAY* to begin playback. During playback, use the playback features *described on the next page*.
5. Press *STOP* when you are finished.

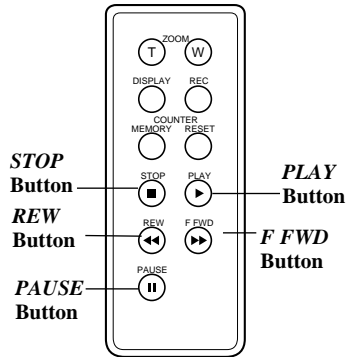

Remote

Playback Features

Visual Searching

- To visually search forward on the tape during playback or play pause, press and hold *F FWD*. Release the button to return to normal playback.
- To visually search in reverse on the tape during playback or play pause, press and hold *REW*. Release the button to return to normal playback.

Tape Positioning

1. Slide the *POWER* switch upward to turn on the camcorder.
2. Press the *VCR(PLAY)/CAM* button to put the camcorder in the playback mode. The green *VCR(PLAY)* indicator will light.
3. Press and quickly release *REW* or *F FWD* to rewind or fast-forward the tape.
4. Press *STOP* to stop the tape.

Stop-Action Pause

- During playback, press *PAUSE* to “stop the action” and view one frame of the tape.
- Press *PLAY* or *PAUSE* to return to normal playback.

Caution: Pause is designed for momentary interruptions and should not be used for an extended period of time. If the camcorder remains in pause for more than three minutes, it will automatically enter the stop mode and then turn off to prevent excessive tape wear.

Playback

Model Pro848 Only: Playback on TV (or VCR) with *AUDIO/VIDEO IN* Jacks

To connect your camcorder to a TV monitor (or VCR) with *AUDIO/VIDEO IN* jacks, you will need the supplied audio/video cable. If your TV is already connected to a VCR, you can attach the camcorder to the VCR and watch what the camcorder is recording or playing on the TV.

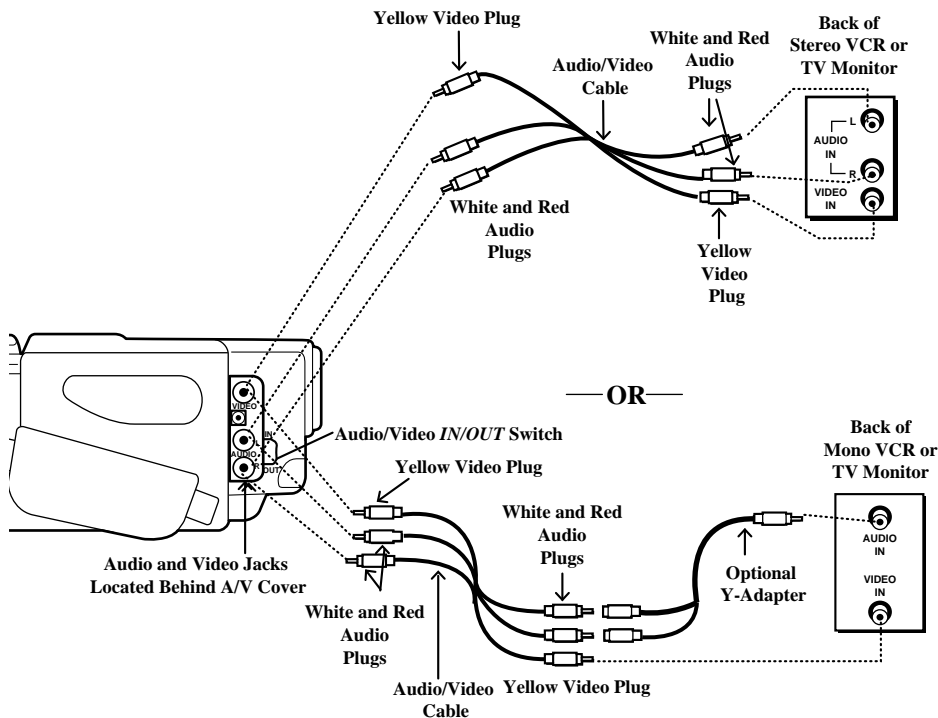

Installation

1. Attach the white and red plugs on one end of the audio/video cable to the red and white *AUDIO IN* jack on the TV (or VCR).

Notes: If your TV (or VCR) only has one *AUDIO IN*, you may need an optional Y-adaptor to hear both channels.

2. Attach the yellow plug to the *VIDEO IN* jack on the TV (or VCR).
3. Attach the white and red plugs on the

other end of the audio/video cable to the white and red *AUDIO L* and *R* jacks (located behind the *A/V* cover) on the side of the camcorder.

4. Attach the yellow plug to the yellow *VIDEO* jack on the camcorder.
5. Place the audio/video *IN/OUT* switch (located on the side of the camcorder) in the *OUT* position.

Playback

Playback Operation and How to Copy Tapes on the VCR

1. A. Camcorder connected directly to TV: Turn on the TV and tune it to the video input channel.
B. Camcorder connected to VCR that is already connected to TV: Turn on VCR and place it in the “line” or “camera mode”. (If your VCR does not have a “line” or “camera mode”, consult the VCR owner’s manual.) Operate the TV as you normally do to see the signal coming from the VCR.
2. Slide the *POWER* switch upward to turn on the camcorder.
3. Press the *VCR(PLAY)/CAM* button to put the camcorder in the playback mode. The green *VCR(PLAY)* indicator will light.
4. Press *PLAY*
 - During playback, use the playback features on page 35.
5. To copy what the camcorder is playing, place a blank cassette in the VCR, and press the VCR’s *RECORD* button.
Note: Make sure the memory-stop feature is turned off (press *COUNTER MEMORY* on the remote control) or the camcorder will enter play pause when the counter reaches *M 0:00:00*.
6. Press *STOP* when you are finished.

Caution: The unauthorized recording of copyrighted material may infringe the rights of others.

Viewing What the Camcorder is Seeing (or Recording)

1. A. Camcorder connected directly to TV: Turn on the TV, and tune it to the video input channel.
B. Camcorder connected to VCR that is already connected to TV: Turn on VCR and place it in the “line” or “camera mode”. (If your VCR does not have a “line” or “camera mode”, consult the VCR owner’s manual.) Operate the TV as you normally do to see the signal coming from the VCR.
2. Slide the *POWER* switch upward to turn on the camcorder. The red *CAM* indicator will light.
Note: When the camcorder is used as a camera, turn the TV’s volume down to prevent a high-pitched squeal caused by feedback.
3. Press the thumb trigger to begin recording. You can watch what the camcorder is seeing (or recording) on the TV screen.

Notes: The remote control will operate the camcorder.

Press the *DISPLAY* button to have the camcorder’s displays appear on the TV screen. During tape copying, these displays will be recorded when they appear on the TV screen.

Playback

Models Pro842 and Pro847 Only: Playback on TV (or VCR) with *AUDIO/VIDEO IN* Jacks

To connect your camcorder to a TV monitor (or VCR) with *AUDIO/VIDEO IN* jacks, you will need the supplied audio/video cable. If your TV is already connected to a VCR, you can attach the camcorder to the VCR and watch what the camcorder is recording or playing on the TV.

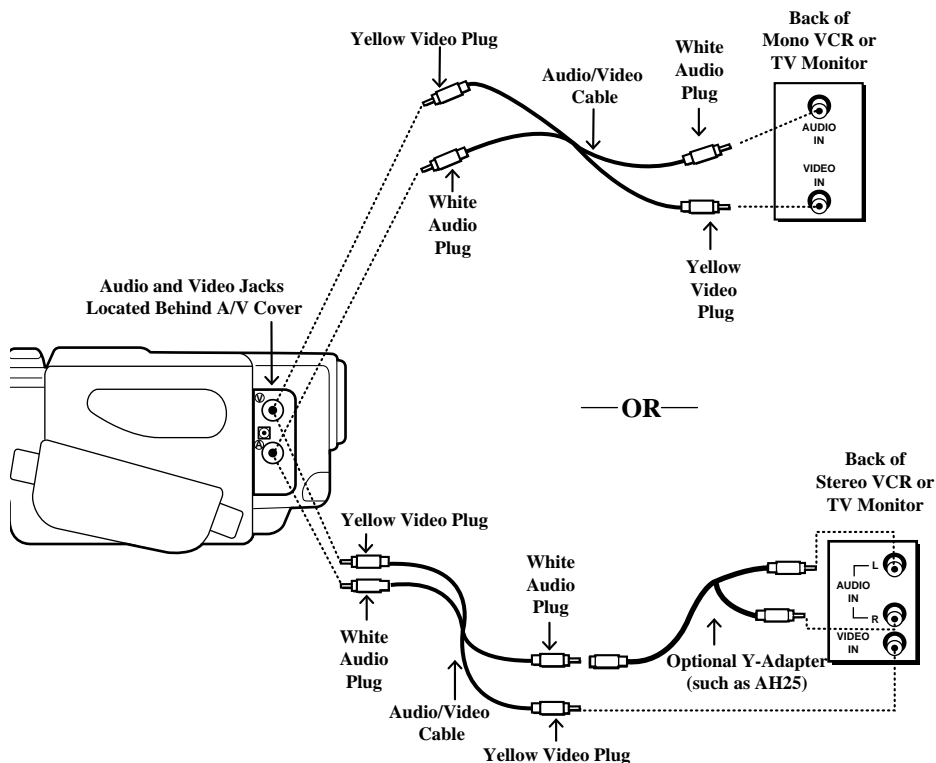

Installation

1. Attach the white plug on one end of the audio/video cable to the *AUDIO IN* jack on the TV (or VCR).
2. Attach the yellow plug to the *VIDEO IN* jack on the TV (or VCR).
3. Attach the white plug on the other end of the audio/video cable to the A (audio) jack (located behind the A/V cover) on the side of the camcorder.
4. Attach the yellow plug to the yellow V (video) jack on the camcorder.

Playback

Playback Operation and How to Copy Tapes on the VCR

1. A. Camcorder connected directly to TV: Turn on the TV and tune it to the video input channel.
B. Camcorder connected to VCR that is already connected to TV: Turn on VCR and place it in the “line” or “camera mode”. (If your VCR does not have a “line” or “camera mode”, consult the VCR owner’s manual.) Operate the TV as you normally do to see the signal coming from the VCR.
2. Slide the *POWER* switch upward to turn on the camcorder.
3. Press the *VCR(PLAY)/CAM* button to put the camcorder in the playback mode. The green *VCR(PLAY)* indicator will light.
4. Press *PLAY*
 - During playback, use the playback features on page 35.
5. To copy what the camcorder is playing, place a blank cassette in the VCR, and press the VCR’s *RECORD* button.
Note: Make sure the memory-stop feature is turned off (press *COUNTER MEMORY* on the remote control) or the camcorder will enter play pause when the counter reaches *M 0:00:00*.
6. Press *STOP* when you are finished.

Caution: The unauthorized recording of copyrighted material may infringe the rights of others.

Viewing What the Camcorder is Seeing (or Recording)

1. A. Camcorder connected directly to TV: Turn on the TV, and tune it to the video input channel.
B. Camcorder connected to VCR that is already connected to TV: Turn on VCR and place it in the “line” or “camera mode”. (If your VCR does not have a “line” or “camera mode”, consult the VCR owner’s manual.) Operate the TV as you normally do to see the signal coming from the VCR.
2. Slide the *POWER* switch upwards toward *POWER*. The red *CAM* indicator will light.
Note: When the camcorder is used as a camera, turn the TV’s volume down to prevent a high-pitched squeal caused by feedback.
3. Press the thumb trigger to begin recording. You can watch what the camcorder is seeing (or recording) on the TV screen.

Notes: The remote control will operate the camcorder.

Press the *DISPLAY* button to have the camcorder’s displays appear on the TV screen. During tape copying, these displays will be recorded when they appear on the TV screen.

Playback

Playback on a TV Without Audio/Video Inputs

To connect your camcorder to a TV without audio/video inputs, you will need an optional CRF800 output adapter and an optional coaxial RF cable, such as VH82 or VH90 shown on pages 42-43. If your TV has *AUDIO* and *VIDEO IN* jacks (or is connected to a VCR), refer to pages 36-39.

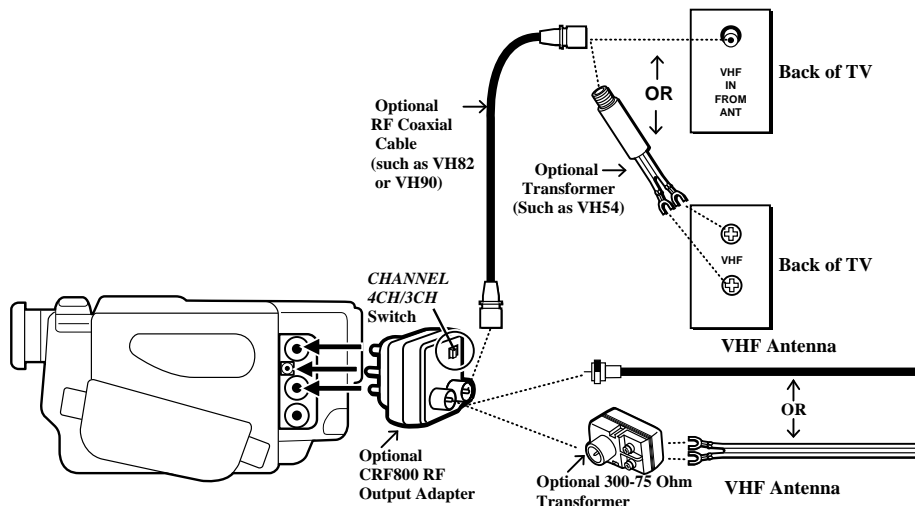

Installation

1. Disconnect the VHF antenna from your TV. Connect the antenna to the connector on the RF output adapter as shown above if you are going to leave the adapter connected to the TV.
Note: If your VHF antenna is the flat twin-lead type attached by two screws, you will also need an optional 300/75 ohm transformer.
2. Attach one end of the optional coaxial RF cable to the other connector on the adapter, and attach the other end to the VHF input on your TV as shown.

Note: If your TV has 300 ohm screw terminals, you will need a 75/300 ohm transformer, such as VH54, shown on page 43.

3. Attach the RF output adapter's plug to the audio, RF out, and video jacks (located under the A/V cover) on the side of the camcorder.
4. **Model Pro848 Only:** Make sure the audio/video *IN/OUT* switch on the side of the camcorder is in the *OUT* position.

Playback

Playback Operation

1. Set the *CHANNEL 4CH/3CH* switch on the RF output adapter to *CHANNEL 4CH* or *3CH*.
2. Turn on the TV, and tune it to the same channel you selected with the RF output adapter's *CHANNEL* switch.
3. Attach a power supply and turn on the camcorder.
4. Insert a tape.
5. Press *VCR(PLAY)/CAM* button to place the camcorder in the *VCR(PLAY)* mode. The green *VCR(PLAY)* indicator will light.
6. Press *PLAY*.
 - During playback, use the playback features *described on page 35*.
7. Press *STOP* when you are finished.

Viewing What the Camcorder Is Seeing or Recording

1. Turn on the TV and tune it to channel 3 or 4. When the camcorder is used as a camera, turn the TV's volume down to prevent a high-pitched squeal caused by feedback.
2. Set the *CHANNEL 4CH/3CH* switch on the RF output adapter to the same channel you selected on the TV.
3. Press *VCR(PLAY)/CAM* button to place the camcorder in the *CAM* mode. The red *CAM* indicator will light.
4. Press the thumb trigger to begin recording. You can watch what the camcorder is seeing (or recording) on the TV screen.

Notes: The remote will also operate the camcorder.

Press the *DISPLAY* button to have the camcorder's displays appear on the TV screen.

Normal TV Viewing

For normal TV viewing, you may leave the RF output adapter hooked up to the TV. Disconnect the adapter plug from the camcorder or turn off the camcorder.

Note to Cable TV Installer

This reminder is provided to call your attention to Article 820-40 of the National Electrical Code (Section 54 of Canadian Electrical Code, Part I), that provides guidelines for proper grounding and, in particular, specifies that the cable ground shall be connected to the grounding system of the building as close to the point of cable entry as practical.

Optional Accessories

We invite you to take a look at some great ideas for sparking creativity and adding to the fun of using your compact VHS camcorder. The following pages have a selection of accessories to help make your memorable moments look and sound even better.

These accessories are designed to make the process of recording and watching your videos more enjoyable.

To order accessories, contact your local Dealer.

If a dealer is not nearby, all accessories are available through toll-free ordering or by using the order form *on page 45*.

AC201A Soft Carrying Case

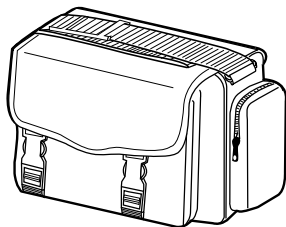

Custom compact soft case designed especially to provide protection and utility for your compact VHS camcorder and most accessories. Rugged fabric lined with soft non-abrasive material and generous padding. Has adjustable dividers for custom fit for lens filters, adapters, batteries, and tapes.

Coaxial RF Cables

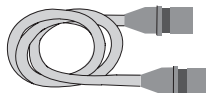

VH82 (6-ft)
VH90 (12-ft)

These RF cables are used with the RF output adapter to connect your camcorder to a standard TV (one without audio/video input jacks) for playback. If your TV has 300 ohm antenna screw terminals, you will need an optional 75-to-300 ohm transformer such as VH54. If your antenna cable is the flat twin-lead type attached by two screws, you will also need an optional 300-to-75 ohm transformer.

All specifications and descriptions of accessories are subject to change without notice.

Optional Accessories

CPS801C AC Adapter/Charger

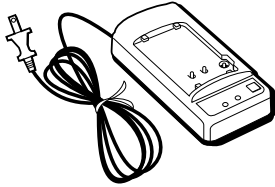

This adapter/ charger and the optional DCC100 DC cable enable you to operate your camcorder directly from standard household power. It operates on 100-240 volts, 50/60H.

It will also charge the 234330 and 234329 battery.

Caution: Do not use any other adapter/chargers with this camcorder.

DCC100 DC Cable

This DC cable lets you connect the CPS801C AC adapter/charger or the DCC05 DC car cord adapter/charger directly to the camcorder.



CRF800 RF Output Adapter

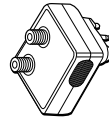

This adapter is used with a coaxial RF cable to connect your camcorder to a standard TV (one without audio/video

VH54 Cable Transformer



This 75-to-300 ohm transformer is used to connect a standard 75-ohm antenna cable (such as VH82 or VH90) to the 300 ohm screw terminals on a TV.

AH25 Y-Adapter

This Y-adapter allows you to connect your camcorder's mono audio cable to a stereo TV or VCR.



Optional Accessories

Using the Optional AC088 Tripod

Mounting the camcorder on a tripod, such as AC088, will keep the camcorder steady and produce excellent video results.

This tripod's fluid-effect head provides smooth camera pan and tilt. The quick-release mount makes it easy to attach or remove the camcorder. The grooved, tubular 3-section leg design folds down to 26" when not in use. Rubber feet allow for sure footing.

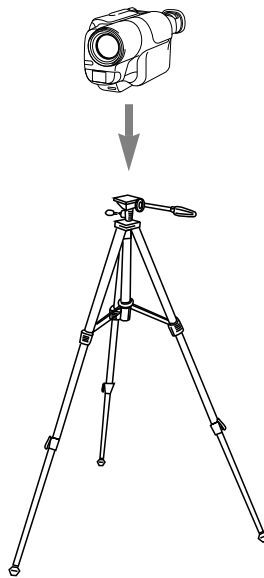

Cautions: Before using a tripod, make sure it is stable enough to hold the camcorder without falling over. Do not transport the camcorder attached to the tripod.

When attaching your camcorder to a tripod, be careful not to force the tripod screw into the camcorder's tripod mounting hole.

The tripod screw should not protrude into the camcorder more than approximately three-eighth (3/8) inch. Forcing the screw could damage the mounting hole on the bottom of the camcorder.

All specifications and descriptions of accessories are subject to change without notice.

Accessory Order Form

Order Form for Camcorder Models Pro842/Pro847/Pro848

Description	Part No.	Price	Qty.	Total
Super Lightweight Tripod	AC088	\$ 39.95		
Soft Camcorder Case	AC201A	\$ 39.95		
Y-Adapter	AH25	\$ 2.95		
AC Adapter/Charger and DC Cable	CPS801C	\$118.75		
	DCC100	\$ 12.95		
RF Output Adapter	CRF800	\$ 59.95		
75-300 Cable Transformer	VH54	\$ 2.95		
Coaxial RF Cable (6 Feet)	VH82	\$ 6.95		
Coaxial RF Cable (12 Feet)	VH90	\$ 7.95		
Shoulder Strap	213004	\$ 12.95		
Audio/Video Cable (Pro842/Pro847)	217496	\$ 18.45		
AC Adapter	221424	\$ 104.85		
Stereo Audio/Video Cable (Pro848)	233194	\$ 17.60		
Remote Control	233195	\$ 36.85		
Rechargeable Battery	234329	\$ 45.95		
Rechargeable Battery	234330	\$ 49.95		

Prices are subject to change without notice.

Total Merchandise.....\$ _____

Sales Tax\$ _____

We are required by law to collect the appropriate sales tax for each individual state, county, and locality to which the merchandise is being sent.

Shipping and Handling.....\$ **5.00**

Total Amount Enclosed\$ _____

Use VISA, MasterCard, or Discover.

Money order or check must be in U.S. currency only. No COD or cash.

Detach Here



Please make sure that both sides of this form have been filled out completely.

- Allow 4 weeks for delivery.
- All accessories are subject to availability.

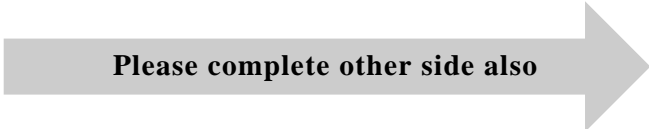

Accessory Order Form

Charge your order on your VISA,
MasterCard, or Discover Card by
filling in below

USE YOUR CREDIT CARD



IMPORTANT: Copy complete account number
from your VISA card

My card expires:



IMPORTANT: Copy complete account number
from your MasterCard

Copy Number
above your
name on
MasterCard

My card
expires:



IMPORTANT: Copy complete account number
from your Discover Card

My card expires:

AUTHORIZED SIGNATURE

Prices are subject to change without notice.

Print or type your name and
address clearly. This will be
your mailing label.



A complete and correct
order will save you days
of waiting.

Detach Here

Name: _____

Street: _____

_____ Apt: _____

City: _____

State: _____ Zip: _____

Accessory Order Form

To order accessories, contact your local Dealer.

If a dealer is not nearby, you can also follow the directions below to order by telephone or direct-by-mail.

United States and Canada Orders

To place your order by phone, have your Visa, MasterCard, or Discover card ready and call the toll-free number listed below between 8AM and 8PM (EST) Monday through Friday or between 9AM and 5PM (EST) Saturday.

Use this number only to place an order for accessory items listed on this order form.

1 – 800 – 338 – 0376

To place your order by mail, detach and mail the completed order form with credit card information, money order, or check in U.S. currency (made payable to Thomson Consumer Electronics, Inc.) to the following address:

Video Accessories
PO Box 8419
Ronks, PA 17573

Care and Maintenance

Cleaning the Camcorder

To clean the camcorder's exterior, remove any power source connected to the camcorder and gently wipe it with a clean soft cloth.

Caution: Use of strong cleaning products, such as those containing alcohol or benzine, may damage the camcorder.

Cleaning the Camcorder's Lens

To clean the camcorder's lens, blow it with a blower brush, and then gently wipe the lens with cleaning tissue and commercially prepared cleaning solution designed for use on camera lens. Improper cleaning may scratch the lens.

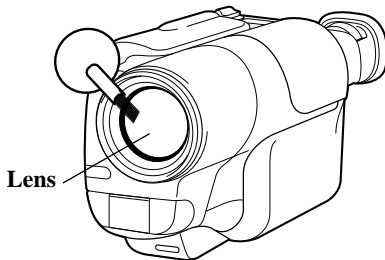

Caution: Do not touch the lens with your fingers. The oil from your skin can damage the lens.

Cleaning the Camcorder's Viewfinder

The viewfinder eyepiece can be removed for cleaning.

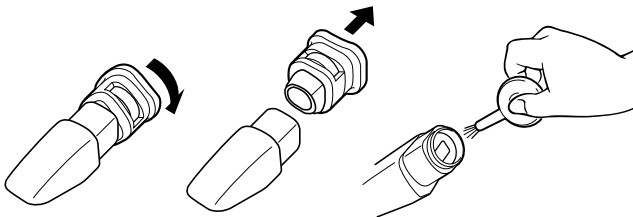

1. Turn the eyepiece counterclockwise and pull it out.
2. Remove dust using a blower brush.
3. Reattach the eyepiece and turn it clockwise until it clicks.

Care and Maintenance

Proper Care and Storage

- Keep dust and grit from entering the camcorder's cassette door. Dust and grit are abrasive and will cause excessive wear to both the camcorder's recording/playback heads and cassettes.
- Always replace the lens cap when the camcorder is not in use.
- Before handling your camcorder, make sure your hands and face are free from any chemical products such as suntan lotion, as it may damage the finish.
- The camcorder can be damaged by improper storage or handling. Do not subject the camcorder to swinging, shaking, or dropping.
- Do not store the camcorder in temperatures below -22°F (-30C) or above 149°F (65C).
- When the camcorder is not in use, always remove the cassette and AC adapter or battery.
- Retain the original carton for future storage or shipping purposes.

Things to Avoid

- Do not attempt to disassemble your camcorder. There are no user-serviceable parts inside.
- Avoid operating your camcorder immediately after moving it from a cold location to a warm location. Give the camcorder 1-1/2 to 2 hours to reach a stable temperature before inserting a cassette. When the camcorder is moved from cold to warm, condensation may cause the tape to stick to the headwheel and damage the headwheel or tape.
- Do not aim your camcorder at the sun or other bright objects.
- Do not leave your camcorder in direct sunlight for extended periods of time. The resulting heat buildup could permanently damage the camcorder's internal parts.
- Do not operate the camcorder in extremely humid environments.
- Do not operate the camcorder near the ocean as salt water or salt water spray may damage the internal parts of the camcorder.
- Do not operate the camcorder for extended periods in temperatures below 40°F (4C) or above 95°F (35C).
- Do not expose the camcorder or adapter to rain or moisture. If either component becomes wet, turn off the power and take the unit to an Authorized RCA Camcorder Servicer.
- Do not use an adapter, adapter/charger, or batteries other than the ones specified for the camcorder. Use of the wrong accessories may cause damage to the camcorder.

Trouble Checks

Troubles sometimes are caused by simple “faults” that you can easily correct without the help of a service technician by first checking a few basic remedies.

Before you call or take your camcorder to an Authorized RCA Camcorder Servicenter, look below for the type of trouble you are experiencing. Then perform the simple checks and adjustments listed for that trouble.

If service should be necessary, the warranty information lists what your warranty covers and explains how to get service.

Trouble	Checks and Adjustments
No power	<ul style="list-style-type: none"> • Slide the <i>POWER</i> switch upward to turn on the camcorder. • If using rechargeable battery, it may need to be recharged. • If using AC adapter or AC adapter/charger, make sure it is plugged into a working outlet. • If using “AA” batteries, they may need to be replaced.
Won't record or playback	<ul style="list-style-type: none"> • If the dew indicator () flashes in the viewfinder, there is moisture in the camcorder. Wait until the dew indicator no longer appears before operating the camcorder. • Make sure <i>VCR(PLAY)/CAM</i> button is in the <i>CAM</i> (camera) or <i>VCR(PLAY)</i> mode. (See page 5.) • There may not be a cassette in the camcorder. • Try ejecting and reinserting the cassette. • The cassette tape may be broken, try another cassette. • You may have reached the end of the cassette, try rewinding it.
Won't playback	<ul style="list-style-type: none"> • <i>VCR(PLAY)/CAM</i> button must be in <i>VCR(PLAY)</i> mode.
Won't record	<ul style="list-style-type: none"> • Safety tab has been closed. (See page 18.) • <i>VCR(PLAY)/CAM</i> button must be in <i>CAM</i> (camera) mode.
No picture	<ul style="list-style-type: none"> • Remove lens cap.
Camcorder turns itself off	<ul style="list-style-type: none"> • Slide <i>POWER</i> switch upward to turn the camcorder back on. If camcorder is left in record pause or play pause for three minutes, it will turn itself off to prevent tape wear.

Trouble Checks

Trouble	Checks and Adjustments
Camcorder does not respond to remote control	<ul style="list-style-type: none"> • Aim remote at camcorder's remote control sensor. • Remote's lithium cell battery may be installed incorrectly. <i>See page 14.</i> • Remote control's lithium cell battery may need replacing. • Remote control sensor on camcorder exposed to direct sunlight or strong artificial light.
Tape stops during rewind or fast forward	<ul style="list-style-type: none"> • Time-counter memory may be on. Whenever an "M" appears with the time-counter display, the camcorder will stop rewinding (or fast forwarding) when counter reads <i>M 0:00:00</i>. Press <i>REW</i> or <i>FFWD</i> again to continue rewinding or fast forwarding, or press <i>COUNTER MEMORY</i> on the remote to turn off the memory-stop feature.
Camcorder remains in pause mode	<ul style="list-style-type: none"> • Press <i>PLAY</i> or <i>PAUSE</i> to return to normal playback.
Sound is too low or distorted	<ul style="list-style-type: none"> • Subject was too far from camcorder. • Model Pro848 Only: Attach an external microphone. <i>See "Specifications" on page 56 for proper type.</i>
Poor auto-focus operation	<ul style="list-style-type: none"> • Subject is not in center of viewfinder or two subjects are at different distances. Use the focus lock feature. <i>See page 26.</i>
Viewfinder displays are out of focus	<ul style="list-style-type: none"> • Lens is smudged, and image appears unfocused. • Eyepiece focus control is misadjusted. • The small controls (<i>B</i> and <i>C</i> or <i>F</i>) on the bottom of the viewfinder control the brightness and color (models Pro848/Pro847) or focus (model Pro842) of the viewfinder. These controls have been set at the factory and should require no adjustment. If the brightness or color (models Pro848/Pro847)/focus (model Pro842) of the viewfinder ever does require adjustment, carefully use a plastic screwdriver. Make the adjustments with caution to prevent damaging the miniature controls.

(continued on next page)

Trouble Checks

Trouble	Checks and Adjustments
Date and/or time were recorded on tape	<ul style="list-style-type: none">• Displays will be recorded on tape whenever they appear in the viewfinder. Remove them from viewfinder when recording. <i>See page 29.</i>
Date and/or time are incorrect	<ul style="list-style-type: none">• When <i>AUTO DATE</i> is selected, display will automatically be recorded when you begin recording or change the cassette. <i>See page 29.</i>• Clock lithium cell battery may need replacing. <i>See page 27.</i>• Date or time may need to be set. <i>See page 28.</i>
Vertical white lines appear when shooting bright object	<ul style="list-style-type: none">• This may occur when background extremely contrasts with the subject.
Rechargeable battery runs down sooner than expected	<ul style="list-style-type: none">• If battery has not been used for some time, completely drain the battery's power and then recharge it.• Battery run times are measured when the camcorder is recording continuously. You can check your battery by first fully charging it and then aiming the camcorder at a clock and recording the picture of the clock. When the recording stops, play the last recorded section, and note the clock time. A one-hour battery should give you about 60 minutes of recording time. In practical use, you may not be able to record for the full time because the camera uses battery current when it is waiting between recordings (record pause) and while you focus and zoom.

Customer Assistance and Service

You can reach Thomson at the following number:

800-283-6503

(Toll free inside U.S.A.)

Our toll-free Camcorder number operates from 8 a.m. to 5 p.m., CST Monday – Friday for U.S. customers only

Thomson provides a toll-free telephone number to help you with any problems you may encounter with your camcorder. Many can be diagnosed over the phone, and if necessary, a replacement unit can be shipped to you. Please have your camcorder model/serial number and date of purchase ready when you call. If your unit is out of warranty, we will quote the cost of an exchange unit to you.

Returning equipment to Thomson for repair or exchange

If we are unable to resolve your problem over the phone, we will gladly service your unit or exchange it for a new or refurbished camcorder. Refer to the limited warranty on the reverse side to learn about your specific rights and responsibilities.

Always consult Thomson and get a Return Authorization number before returning anything! Obtain a Return Authorization (RA) number from the telephone representative before returning your equipment to avoid delays, accounting errors, or even loss of your unit.

Important information to customers who ship defective equipment to Thomson Consumer Electronics

The Thomson representative who authorized the return of your equipment will give you an RA number over the phone. They will also provide you with instructions on where and how to return your camcorder. Write the number in large, clear characters on the outside of the box. To avoid confusion and misunderstandings, shipments without an RA number clearly visible on the outside of the box will be returned to you at your expense.

Include a brief note describing the problem and any conversations about the problem you have had with Thomson personnel. Include your name, address and model/serial number of your

camcorder. These numbers are located on the bottom of your unit. If your camcorder is within the warranty period, please provide a copy of the bill of sale to verify purchase date. Use the original box and packing material to protect the equipment from damage in shipment.

For your protection, insure all shipments for full replacement value and use a reliable shipper. Thomson assumes no responsibility for warranty shipments from the customer to the factory if not shipped in the manner prescribed by Thomson.

Limited Warranty

What your warranty covers:

- Any defect in materials or workmanship.

For how long after your purchase:

- 90 days for labor charges.
- One year for parts.

(The warranty period for rental units begins with the first rental or 45 days from date of shipment to the rental firm, whichever comes first.)

What we will do:

During the initial 90 days

- Exchange your camcorder with a new or refurbished unit, or repair your camcorder. The option will be ours. There will be no cost to you.

After the 90 days and within one year

- Exchange your camcorder with a new or refurbished unit, or repair your camcorder. The option will be ours. Parts will be provided at no charge, but you will be responsible for the cost of labor required for the repair.

How you get service:

- Call 1-800-283-6503 and have your unit's date of purchase and model/serial number ready. The model/serial number information is on the bottom of your camcorder.
- A representative will troubleshoot your problem over the phone. If the representative determines that you should receive a replacement unit, you will be provided with a Return Authorization (RA) number and the location of a nearby exchange point if one exists. No returns will be accepted without the RA number.

To receive a replacement camcorder before you return yours:

If you are located near an exchange point:

1. We will send a replacement unit to the exchange point next business day delivery in the continental USA.
2. The exchange location will notify you of its arrival.

3. Take your unit, including all accessories, and your evidence of purchase date, such as a bill of sale, to the exchange location and you will be provided the new or refurbished unit.
4. If the repairs were covered by your warranty, you will not be billed.

If you are not located near an exchange point:

1. Provide your Discover, MasterCard or Visa account number and expiration date to our phone representative. This is for security purposes. If we receive your unit including all accessories within 14 days from the date you were provided a Return Authorization number, only items not covered by warranty will be charged to your account. **IF YOUR UNIT INCLUDING ALL ACCESSORIES IS NOT RECEIVED WITHIN 14 DAYS, THE SUGGESTED RETAIL VALUE OF THE CAMCORDER AND/OR ACCESSORIES WILL BE CHARGED TO YOUR CREDIT CARD.** This amount will be credited if the unit is subsequently received.
2. We will send you a replacement unit next business day delivery in the continental USA.
3. You will receive an invoice packed with the replacement product, but will not be charged for the unit portion of the invoice amount if we receive your unit including all accessories within 14 days from the date you were provided the RA number. Any labor and parts charges not covered by the warranty will be included and charged against your account.
4. Ship the unit back to us along with all accessories included with your camcorder using the replacement unit's carton. Shipping instructions will be included in the carton along with your RA number, which will

Limited Warranty

allow you to easily ship the unit back to us. **Make sure you insure your shipment in case of damage or loss.**

Include with the shipment:

- Evidence of purchase date, such as a bill of sale, to verify your unit's warranty eligibility.
- A brief note describing your camcorder's problem.
- Your name, address and phone number.

Return transportation, storage, handling and insurance costs are your sole responsibility. We accept no liability in case of damage or loss.

To receive a replacement unit after we have received your unit:

1. Write the RA number on the outside of the carton used to return the unit.

Make sure you insure your shipment in case of damage or loss.

2. Carefully pack the unit along with all accessories included with your camcorder, using the original box and packing material if possible.
3. Include with the shipment:
 - Evidence of purchase date, such as a bill of sale, to verify your unit's warranty eligibility.
 - A brief note describing your camcorder's problem.
 - Your name, address and phone number.

Return transportation, storage, handling and insurance costs are your sole responsibility. We accept no liability in case of damage or loss.

4. Include a cashier's check or money order for payment if there are any out of warranty labor or parts charges which were indicated by the representative, and you elected not to use your credit card.
5. Upon receipt of your product, a new or refurbished unit will be shipped to you next day delivery in the continental USA.

To have your Camcorder repaired by an Authorized RCA Camcorder Servicenter:

- Check with your dealer or call 1-800-336-1900 for the Authorized RCA Camcorder Servicenter nearest you.
- Take your unit to the Authorized RCA Camcorder Servicenter of your choice.
- Show the Authorized RCA Camcorder Servicenter representative evidence of purchase date, such as a bill of sale.
- Pick up your camcorder when repairs are complete.

What your warranty does not cover:

- Adjustment of customer controls.
- Damage from misuse or neglect.
- A unit that has been modified or incorporated into other products or is used for institutional or other commercial purposes.
- Batteries.
- Cleaning of video/audio heads.
- Camcorders purchased or serviced outside the U.S.A.
- Return transportation, storage and handling costs of your unit, including insurance for loss or damage.
- Acts of God, such as but not limited to lightning damage.

Product Registration:

- Please complete and mail the *Product Registration Card* packed with your camcorder. It will make it easier to contact you should it ever be necessary. The return of the card is not required for warranty coverage.

How State Law relates to warranty:

- This warranty gives you specific legal rights and you may have other rights that vary from state to state.

If you purchased your Camcorder outside the United States:

- This warranty does not apply. Contact your dealer for warranty information.

Specifications

Camcorder

Television system:	NTSC, EIA
Video recording system:	Rotating 2-head, helical-scan system
Audio recording system:	Rotating head Pro842/Pro847: FM system Pro848: FM stereo system
Cassette type:	8 mm video cassette tape
Tape speed:	SP mode - Approx. 14.345 mm/sec.
Maximum recording time:	120 minutes (P6-120 cassette)
Fast forward/Rewind time:	Approximately 6.5 minutes (P6-60 cassette)
Image Sensor:	CCD solid-state type (270,000 pixels)
Viewfinder:	Pro842: 0.6 inch electronic B/W viewfinder Pro847/Pro848: 0.55 inch electronic color viewfinder
Lens:	15x zoom F1.4-2.6 (f = 4.0 to 60mm)
Focus:	Fuzzy logic auto focus
White balance:	Fuzzy logic auto white balance
Iris:	Fuzzy logic auto iris
Power supply:	6V Ni-Cd battery pack 6.5V - Optional AC adapter/charger (CPS801C) 9V - Alkaline batteries (6 - "AA"), AC adapter (221424)
Power consumption:	Pro842: 4.8W, Pro847: 5.4W, Pro848: 5.6W (during recording)
Operating temperature range:	32°F to 104°F (0°C to 40°C)
Storage temperature range:	-4°F to 140°F (-20°C to 60°C)
Dimensions (W x H x D):	Approx. 225 x 106 x 108 mm
Weight (excluding battery and tape):	Pro842 and Pro848: Approx. 0.79Kg Pro847: Approx. 0.78Kg
External microphone jack:	Pro848 Only: -66dBs, stereo mini jack
Video output terminal:	Video output 1 Vp-p, 75 ohms unbalanced, negative sync
Audio output terminal:	Audio output -7dBs, 2.2 kohms or less

AC Adapter

Rated output:	9V, 0.8A
Power requirement:	AC 100V - 240V, 50/60 Hz
Power consumption:	10W
Dimensions (W x H x D):	Approx. 65 x 32 x 49 mm
Weight:	Approx. 100g

All specifications are subject to change without notice.

Information to User

This equipment has been tested and found to comply with the limits for a Class B digital device and RF lighting device, pursuant to Part 15 and Part 18 of the FCC Rules. These limits are designed to provide reasonable protection against harmful interference in a residential installation. This equipment generates, uses, and can radiate radio frequency energy and, if not installed and used in accordance with the instructions, may cause harmful interference to radio communications. However, there is no guarantee that interference will not occur in a particular installation. If this equipment does cause harmful interference to radio or television reception, which can be determined by turning the equipment off and on, the user is encouraged to try to correct the

interference by one or more of the following measures:

- Reorient or relocate the receiving antenna.
- Increase the separation between the equipment and receiver.
- Connect the equipment into an outlet on a circuit different from that to which the receiver is connected.
- Consult the dealer or an experienced radio/TV technician for help.

Alterations or modifications carried out without appropriate authorization may invalidate the user's FCC right to operate the equipment.

This Class B digital apparatus meets all requirements of the Canadian Interference — Causing Equipment Regulations.

Cet appareil numérique de la classe B respecte toutes les exigences du Règlement sur le matériel brouilleur du Canada.

— A —

- A/V (Audio/Video)
 - Jacks6,32-33,36,38,40
- AV IN/OUT Switch (Model
 - Pro848 Only)6,32-33,36,40
- Accessories, Included2,45-47
- Accessories, Optional42-47
- Accessory, Order Form45-47
- Adapter, Using4,7
- Adapter/Charger, Optional ...12-13,43
- Adjusting Handstrap3
- Adjusting the Viewfinder22
- AE (Auto Exposure)
 - Indicators20-21,25
- AE (Automatic Exposure) Control .25
- Assistance2,53,Back Cover
- Attaching Lens Cap and Cord3
- AUTO DATE Indicator20-21,29
- Automatic White Balance and Iris ...23

— B —

- B (Bright) and C (Color) Controls
 - (Models Pro847 and Pro848 Only)6,51
- B (Bright) and F (Focus) Controls
 - (Model Pro842 Only)6,51
- Batteries, Using “AA”4,11
- Battery (AA) Safety Precautions ...11
- Battery (Rechargeable)
 - Safety Precautions8
- Battery Care and Storage10
- Battery Level Indicator10,20-21
- BLANK Button6,24
- BLANK Indicator20,24
- Blank Search Feature24

— C —

- CAM/VCR(PLAY) Button and
 - Indicators5,6,19,24,26,30
 -34-35,37,39,41
- Camcorder, Cleaning48
- Camcorder Controls6
- Camcorder, Turning On5
- Camcorder, Unpacking2
- Camera Edit24
- Care and Maintenance48-49
- Care and Storage, Battery10
- Care and Storage, Camcorder49
- Cassette Compartment5,6,18
- Cassettes, Inserting and Removing .5,18
- CautionsInside Front Cover
- Cell, Installing in Remote14
- Charging the Battery9
- Checking Problems50-52
- Cleaning the Camcorder48
- Cleaning the Camcorder Lens48
- Cleaning the Viewfinder48
- Clock Cell, Installing and
 - Removing27
- Contents1
- Controls on Camcorder6
- Controls, Remote16-17
- Copying Tapes
 - (Model Pro848 Only) ...32-33,37
- Copying Tapes (Models Pro842 and
 - Pro847 Only)39
- Correcting the Date and Time28
- COUNTER MEMORY
 - Button16,30,37,39
- COUNTER RESET Button16,30
- Customer Assistance .2,53,Back Cover

— D —

Date and Time Display20-21,29
Date and Time, Recording29
Date and Time, Setting28
DATE/TIME Button6,28-29
DC IN Jack4,6,7,9
Design Specifications56
Dew Indicator ()20
DISPLAY Button6,16,23,37,39,41
Displays, Viewfinder20-21

— E —

EJECT Button6,18,19,34
Elapsed Time Counter20-21
Erase Protection, Cassettes18
External *MIC* (Microphone)
 Jack (Model Pro848 Only)6,23
Eyepiece Focus Control6,19,22
Eyepiece, Removing48

— F —

Fast Forward Operation35
Features, Recording22-31
Features, Playback34-35
FF Indicator20
F FWD (Fast Forward)
 Button6,16-17,19,24,34-35
First Recording5
First-Time Operation2-6
Flying Erase Head23
FOCUS LOCK Button6,26,28
Focusing26
FOCUSLOCK Indicator20-21,26
Function Buttons, Remote16-17

— H —

Handstrap3,6,19
Handstrap, Adjusting3

— I —

Important Safety Information
 Inside Front Cover
IN/OUT Switch (Model
 Pro848 Only)6,32-33,36,40
Included Accessories2,45-47
Inserting and Removing Cassettes .5,18
Install Clock Cell27
Install Cell in Remote14
Iris, Automatic23

— L —

Lens6,48
Lens Cap3,19
Lens Cap Cord, Attaching3
Lens, Cleaning48
Limited Warranty54-55

— M —

M (Memory Stop) Indicator . .20-21,30
Maintenance and Care48-49
Memory Stop Feature30
Microphone6,23

— N —

No Cassette Indicator ()20
Note to Cable TV Installer41

(continued on next page)

— O —

Operation, First-Time 2-6
Optional Accessories 42-47
Optional Plug Adapter 7,13
Order Form, Accessory 45-47

— P —

PAUSE Button 16-17,35
PAUSE Indicator 5,19,20
Pause, Stop-Action 35
Picture Search 35
PLAY
 Button .5,6,16-17,30,34-35,37,39,41
PLAY/CAM Button and
 Indicators 5,6,19,24,26,30
 34-35,37,39,41
Playback Features 34-35
Playback on a TV With *AUDIO/*
 VIDEO IN Jacks (Model
 Pro848 Only) 36-37
Playback on a TV With *AUDIO/*
 VIDEO IN Jacks (Models
 Pro842 and Pro847 Only) . . . 38-39
Playback on a TV Without
 Audio/Video Jacks 40-41
Playback, Viewfinder 34
Plug Adapter, Optional 7,13
Positioning the Tape 35
POWER Switch
 5,6,9,19,28,33,34-35,37,39
Powering Your Camcorder 7-14
Problem Solving 50-52
Product Registration
 Inside Front Cover
PUSH Button 6,7,8,11,13

— Q —

Quick Review Feature 24

— R —

REC (Record) Button, Remote . . 16-17
REC Button (Model Pro848 Only) .6,33
REC Indicator 19,20
REC START/STOP Button . . .5,6,19,24
Rechargeable Nickel Cadmium
 Battery 8-10
Recording Features 22-31
Recording, First 5
Recording, Making a 19
Recording on the Camcorder
 (Model Pro848 Only) 32-33
Recording Over Your Tapes 18
Recording the Date and Time 29
Recording Times 18
Recording Tips 31
Registration Card
 Inside Front Cover
Remote Control 14-17
Remote Function Buttons 16-17
Remote Sensor 6,15
Remote, Storing in Camcorder 15
Removing the Eyepiece for Cleaning 48
REW (Rewind) Button
 5,6,16,19,24,30,34-35
REW Indicator 20
Rewind Operation 35
RF OUT Jack 6,40
RF Output Adapter 40,43

— S —

Safety Information . . Inside Front Cover

Index

Safety Precautions, AA Batteries . . . 11
Safety Precautions, Rechargeable
 Battery 8
Safety Tab 18
Searching, Visual 35
Sensor, Remote 15
Set the Time and Date 27
Shoulder Strap 2,3
Shoulder Strap Holders 3,6
Shutter Speed Control, Automatic . . . 25
Solving Problems 50-52
SP Speed 18
Specifications 56
Status Displays 20
STOP Button
 5,6,16,30,33,34-35,37,39,41
STOP Indicator 20
Stop-Action Pause 35
Storage and Care 49
Storing the Remote 15

— T —

Tape Copying (Model Pro848 Only)
 33,37
Tape Copying (Models Pro842 and
 Pro847 Only) 39
TAPE END Warning 20,23
Tape Positioning 35
Tape Time Remaining
 Display 20-21,23
TAPE Warning 20
Things to Avoid 49
Thumb Trigger 5,6
Time and Date Display 29
Time and Date, Recording 29
Time and Date, Setting 28
Time Counter Display 20-21,30
Time Remaining (Tape)
 Display 20-21,23
Times, Recording 18
Tips, Recording 31

Tips, Traveling 31
Traveling Tips 31
Tripod, Using 44
Trouble Checks 50-52
Turn Off the Camcorder 5

— U —

Unpacking the Camcorder 2
Using "AA" Batteries 4,11
Using Optional AC Adapter/
 Charger 12-13,43
Using the Adapter 4,7

— V —

VCR(PLAY)/CAM Button and
 Indicators 5,6,19,24,26,30
 34-35,37,39,41
Video Cassettes 18
Viewfinder 6,19,20-21,22,34,48
Viewfinder, Cleaning 48
Viewfinder Displays 20-21
Viewfinder Operation 22
Viewfinder Playback 34-35
Visual Search 35

— W —

Warranty, Limited 54-55
White Balance, Automatic 23

— Z —

ZOOM Buttons 16,25
Zoom Control 6,19,25
Zoom Indicator 20,25
Zooming 25

Need Assistance? We want to help!

U.S. Consumers:

Camcorder Exchange Warranty	800-283-6503
Customer Service	800-336-1900
Accessories	800-338-0376

Canadian Consumers:

English	800-522-0338
French	800-522-0445

If your camcorder needs service, please contact your dealer or the nearest Servicenter from the yellow pages. Please do not send any products to the Indianapolis address listed in this manual or on the carton. This will only add delays in service for your product.

 **THOMSON CONSUMER ELECTRONICS**
10330 N Meridian Street
Indianapolis, IN 46290

©1996 Thomson Consumer Electronics, Inc.
Trademark(s)[®] Registered
Marca(s) Registrada(s)

Part Number 96-Pro842/Pro847/Pro848-1

Free Manuals Download Website

<http://myh66.com>

<http://usermanuals.us>

<http://www.somanuals.com>

<http://www.4manuals.cc>

<http://www.manual-lib.com>

<http://www.404manual.com>

<http://www.luxmanual.com>

<http://aubethermostatmanual.com>

Golf course search by state

<http://golfingnear.com>

Email search by domain

<http://emailbydomain.com>

Auto manuals search

<http://auto.somanuals.com>

TV manuals search

<http://tv.somanuals.com>