

Pro845

USER'S GUIDE

Table of Contents	.5
Optional Accessories	6
First-Time Operation	10
Remote Control	16
Powering Your Camcorder	19
Recording Features	23

8

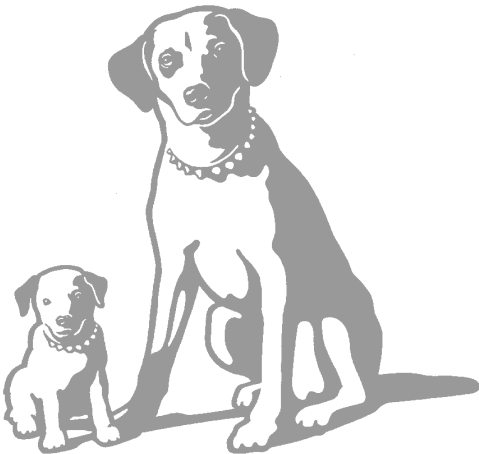

PRO8 CAMCORDER

PRO8

Product Registration

Please fill out the product registration card and return it immediately. Returning this card allows us to contact you if needed.

Keep your sales receipt to obtain warranty parts and service and for proof of purchase. Attach it here and record the serial and model numbers in case you need them. The numbers are located on the bottom of your camcorder.

Model No. Pro845

Serial No. _____

Purchase Date: _____

Purchased From: _____

IMPORTANT SAFETY INSTRUCTIONS

AC Adapter/Charger

Before using the AC adapter/charger, read all instructions and cautionary markings on

- (1) AC adapter/charger,
- (2) battery, and
- (3) product using battery.

Caution: To reduce risk of injury, charge only rechargeable batteries type AV608 or AV8MM. Other types of batteries may burst causing personal injury and damage.

Do not expose the adapter/charger to moisture of any kind.

Use of an attachment not recommended or sold by the battery charger manufacturer may result in a risk of fire, electric shock, or injury to persons.

To reduce risk of damage to electric plug and cord, pull out the cord with the plug rather than the cord when disconnecting the adapter/charger from the wall outlet.

Make sure the cord is located so that it will not be stepped on, tripped over, or otherwise subjected to damage or stress.

Use of an improper extension cord could result in a risk of fire and electric shock. If an extension cord must be used, make sure that:

1. Pins on the plug of the extension cord are the same number, size, and shape as those of the plug on the adapter/charger.

2. Extension cord is properly wired and in good electrical condition, and

3. Wire size below is met:

Minimum AWG Size	Length of Extension Cord (Feet)
18	Equal to or less than 100
16	Equal to or less than 150

Do not operate adapter/charger with a damaged cord or plug. Replace it immediately.

Do not operate adapter/charger if it has received a sharp blow, been dropped, or otherwise damaged in any way. Take it to an Authorized RCA Camcorder Servicer.

Do not disassemble the adapter/charger. Take it to an Authorized RCA Camcorder Servicer when service or repair is required. Incorrect reassembly may result in a risk of electric shock.

To reduce risk of electric shock, unplug adapter/charger from outlet before attempting any maintenance or cleaning.

Be sure to save these operating instructions for future reference.

SAFETY PRECAUTIONS

Your video camcorder's AC adapter/charger will operate on 100-240 volts AC, 50/60 Hz, and has a polarized plug. Because one blade of the plug is wider than the other, the plug fits in the wall socket only one way. Do not defeat the safety feature of this plug. If you need an extension cord, use a polarized extension cord.

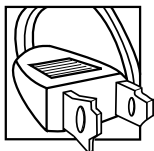

CAUTION: TO REDUCE THE RISK OF ELECTRIC SHOCK, MATCH WIDE BLADE OF PLUG TO WIDE SLOT, FULLY INSERT.

MISE EN GARDE: POUR PRÉVENIR LES CHOC ÉLECTRIQUES, INTRODUIRE LA LAME LA PLUS LARGE DE LA FICHE DANS LA BORNE CORRESPONDANTE DE LA PRISE ET POUSSER JUSQU'AU FOND.

CAUTION: TO REDUCE THE RISK OF ELECTRIC SHOCK, DO NOT REMOVE THE COVER (OR BACK). NO USER-SERVICEABLE PARTS ARE INSIDE. IF YOU SPILL LIQUID ON THE CAMCORDER OR ADAPTER/CHARGER, DISCONNECT THE AC ADAPTER/CHARGER'S POWER CORD TO PREVENT POSSIBLE FIRE OR SHOCK HAZARD AND CONSULT AUTHORIZED SERVICE PERSONNEL. MOISTURE CAN DAMAGE INTERNAL PARTS. REFER ALL SERVICE TO AUTHORIZED RCA CAMCORDER SERVICENTER PERSONNEL ONLY.

CAUTION: READ "IMPORTANT SAFETY INSTRUCTIONS FOR AC ADAPTER/CHARGER" ON THE PREVIOUS PAGE BEFORE USING THE AC ADAPTER/CHARGER.

CAUTION: MAINTAIN ELECTRICAL SAFETY. POWERLINE-OPERATED EQUIPMENT OR ACCESSORIES CONNECTED TO THIS UNIT SHOULD BEAR THE UL LISTING MARK OR, IF PURCHASED IN CANADA, THE CSA CERTIFICATION MARK ON THE ACCESSORIES THEMSELVES AND SHOULD NOT HAVE BEEN MODIFIED SO AS TO DEFEAT THE SAFETY FEATURES. THIS WILL HELP AVOID ANY POTENTIAL HAZARD FROM ELECTRIC SHOCK OR FIRE. IF IN DOUBT, CONTACT QUALIFIED SERVICE PERSONNEL.

WARNING: TO REDUCE THE RISK OF FIRE OR SHOCK HAZARD, DO NOT EXPOSE CAMCORDER OR AC ADAPTER/CHARGER TO RAIN OR MOISTURE.

CAUTION: AVOID OPERATING YOUR CAMCORDER IMMEDIATELY AFTER MOVING IT FROM A COLD LOCATION TO A WARM LOCATION. GIVE THE CAMCORDER 1-1/2 TO 2 HOURS TO REACH A STABLE TEMPERATURE BEFORE INSERTING A VIDEO CASSETTE. WHEN MOVED FROM A COLD AREA TO A WARM LOCATION, MOISTURE MAY CONDENSE ON THE HEAD DRUM INSIDE THE MACHINE. THIS MOISTURE COULD CAUSE THE TAPE TO STICK TO THE HEADWHEEL AND DAMAGE THE HEADWHEEL OR TAPE.

CAUTION

RISK OF ELECTRIC SHOCK
DO NOT OPEN



AVIS

RISQUE DE CHOC ÉLECTRIQUE
NE PAS OUVRIR



The symbol of a lightning flash within a triangle is intended to alert the user to the presence of uninsulated "dangerous voltage" within the product's enclosure and which may be of sufficient magnitude to constitute a risk of electric shock.



An exclamation point within a triangle is intended to alert the user to the presence of important operating and maintenance (service) instructions in the literature accompanying the product.

CAUTION: FCC REGULATIONS STATE THAT ANY UNAUTHORIZED CHANGES OR MODIFICATIONS TO THIS EQUIPMENT MAY VOID THE USER'S AUTHORITY TO OPERATE IT.

IMPORTANT SAFEGUARDS

In addition to the careful attention devoted to quality standards in the manufacture of your product, safety is a major factor in the design of every instrument. However, safety is your responsibility too.

These pages list important information that will help to assure your enjoyment and proper use of a camcorder, adapter/charger, and accessory equipment. Please read them carefully before operating your products.

Installation

- 1. Read and Follow Instructions**—All the safety and operating instructions should be read before the product is operated. Follow all operating instructions.
- 2. Retain Instructions**—The safety and operating instructions should be retained for future reference.
- 3. Heed Warnings**—Comply with all warnings on the product and in the operating instructions.
- 4. Polarization**—This product is equipped with a polarized alternating-current line plug (a plug having one blade wider than the other). This plug will fit into the power outlet only one way. This is a safety feature. If you are unable to insert the plug fully into the outlet, try reversing the plug. If the plug still fails to fit, contact your electrician to replace your obsolete outlet. To prevent electric shock, do not use this polarized plug with an extension cord, receptacle, or other outlet unless the blades can be fully inserted without blade exposure. If you need an extension cord, use one with a polarized plug.
- 5. Power Sources**—This product should be operated only from the type of power source indicated on the marking label. If you are not sure of the type of power supply to your home, consult your dealer or local power company. For products intended to operate from battery power, or other sources, refer to the operating instructions.
- 6. Overloading**—Do not overload wall outlets, extension cords, or integral convenience receptacles as this can result in a risk of fire or electric shock. Overloaded AC outlets, extension cords, frayed power cords, damaged or cracked wire insulation, and broken plugs are dangerous. They may result in a shock or fire hazard. Periodically examine the cord, and if its appearance indicates damage or deteriorated insulation, have it replaced by your service technician.
- 7. Power-Cord Protection**—Power-supply cords should be routed so that they are not likely to be walked on or pinched by items placed upon or against them, paying particular attention to cords at plugs, convenience receptacles, and the point where they exit from the product.

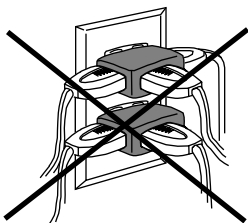

- 8. Ventilation**—Slots and openings in the products are provided for ventilation to ensure reliable operation of the product and to protect them from overheating. These openings must not be blocked or covered. The openings should never be blocked by placing the product on a bed, sofa, rug, or other similar surface. This product should not be placed in a built-in installation such as a bookcase or rack unless proper ventilation is provided or the product manufacturer's instructions have been followed.
- 9. Attachments**—Do not use attachments unless recommended by the product manufacturer as they may cause hazards.
- 10. Water and Moisture**—Do not use this product near water—for example, near a bath tub, wash bowl, kitchen sink or laundry tub, in a wet basement, or near a swimming pool and the like.
- 11. Accessories**—Do not place this product on an unstable cart, stand, tripod, bracket, or table. The product may fall, causing serious injury to a child or adult as well as serious damage to the product. Use this product only with a cart, stand, tripod, bracket, or table recommended by the manufacturer or sold with the product. Any mounting of the product should follow the manufacturer's instructions and use a mounting accessory recommended by the manufacturer.

Caution: Maintain electrical safety. Powerline operated equipment or accessories connected to this unit should bear the UL listing mark or CSA certification mark on the accessory itself and should not be modified so as to defeat the safety features. This will help avoid any potential hazard from electrical shock or fire. If in doubt, contact qualified service personnel.

- 11A** A product and cart combination should be moved with care. Quick stops, excessive force, and uneven surfaces may cause the product and cart combination to overturn.



IMPORTANT SAFEGUARDS (continued)

- 12. Outdoor Antenna Grounding**—If an outside antenna or cable system is connected to the product, be sure the antenna or cable system is grounded so as to provide some protection against voltage surges and built-up static charges. Article 810 of the National Electrical Code, ANSI/NFPA No. 70 (Section 54 of Canadian Electrical Code, Part 1) provides information with respect to proper grounding of the mast and supporting structure, grounding of the lead-in wire to an antenna-discharge unit, size of grounding conductors, location of antenna-discharge unit, connection to grounding electrodes, and requirements for the grounding electrode. See example below as per National Electrical Code, ANSI/NFPA 70.

Example of Antenna Grounding

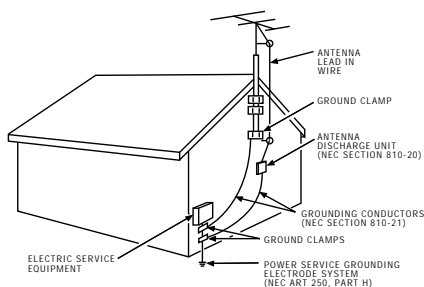

- 13. Power Lines**—An outside antenna system should not be located in the vicinity of overhead power lines, other electric light or power circuits, or where it can fall into such power lines or circuits. When installing an outside antenna system, extreme care should be taken to keep from touching or approaching such power lines or circuits as contact with them might be fatal. Installing an outdoor antenna can be hazardous and should be left to a professional antenna installer.

Use

- 14. Cleaning**—Unplug this product from the wall outlet before cleaning. Do not use liquid cleaners or aerosol cleaners. Use a damp cloth for cleaning.
- 15. Object and Liquid Entry**—Never push objects of any kind into this product through openings as they may touch dangerous voltage points or “short-out” parts that could result in a fire or electric shock. Never spill liquid of any kind on the product.
- 16. Lightning**—For added protection for this product during a lightning storm, or when it is left unattended and unused for long periods of time, unplug it from the wall outlet and disconnect the antenna or cable system. This will prevent damage to the product due to lightning and power line surges.

Service

- 17. Servicing**—Do not attempt to service this product yourself as opening or removing covers may expose you to dangerous voltage or other hazards. Refer all servicing to qualified service personnel.
- 18. Conditions Requiring Service**—Unplug this product from the wall outlet and refer servicing to qualified service personnel under the following conditions.
- A. When the power-supply cord or plug is damaged.
 - B. If liquid has been spilled, or objects have fallen into the product.
 - C. If the product has been exposed to rain or water.
 - D. If the product does not operate normally by following the operating instructions, adjust only those controls that are covered by the operating instructions. Improper adjustment of other controls may result in damage and will often require extensive work by a qualified technician to restore the product to its normal operation.
 - E. If the product has been dropped in any way.
 - F. When the product exhibits a distinct change in performance—this indicates a need for service.
- 19. Replacement Parts**—When replacement parts are required, have the service technician verify that the replacements he uses have the same safety characteristics as the original parts. Use of replacements specified by the product manufacturer can prevent fire, electric shock, or other hazards.
- 20. Safety Check**—Upon completion of any service or repairs to this product, ask the service technician to perform safety checks recommended by the manufacturer to determine that the product is in safe operating condition.
- 21. Wall or Ceiling Mounting**—The product should be mounted to a wall or ceiling only as recommended by the manufacturer.
- 22. Heat**—The product should be situated away from heat sources such as radiators, heat registers, stoves, or other products (including amplifiers) that produce heat.

Note to Cable TV Installer

This reminder is provided to call your attention to Article 820-40 of the National Electrical Code (Section 54 of Canadian Electrical Code, Part I), that provides guidelines for proper grounding and, in particular, specifies that the cable ground shall be connected to the grounding system of the building as close to the point of cable entry as practical.

Recording Tips

- Make a video recording of your home and contents to store in a safe place in case of fire or theft.
- Practice recording under a variety of lighting conditions. This will help you respond quickly.
- Do not move the camcorder rapidly from side-to-side while recording. A steady, gradual “pan” avoids blurring and “jitter”.
- Use the viewfinder to make sure the camcorder is level while recording or your scenes will appear “tilted”.
- Do not bump or tap the camcorder’s microphone while recording because this sound will be recorded.
- Be aware of video and audio backgrounds. Background details barely noticed while you are taping may show up as visual “clutter”. Background noises (especially TV sets, radios, household appliances, traffic sounds, etc.) can detract from the sound you want to record.
- Check the focus before you start recording. Use your camcorder’s zoom to help you focus manually. Zoom in on your subject and adjust the focus until you see a clear image in the viewfinder. Then zoom back to where you want to record. If the subject-to-camcorder distance does not change, the subject will remain in sharp focus over the entire zoom range.
- Avoid long “still” shots of landmarks and scenic attractions. Recordings are more interesting if they include people and details. “Local color” gives travel videos lasting appeal. Consider recording a familiar or landmark scene from an unfamiliar vantage point for added interest. Check the lighting before starting to record.
- Try to make sure indoor scenes are well-lit. This improves picture quality and color reproduction.
- Include close-up shots of individuals when taping family outings or group functions.

Holding The Camcorder

- To film at different angles, raise the viewfinder 75°.
- Standing against a wall may give your recordings more stability.
- Use an optional tripod or monopod for stable images.
- Hold the camcorder horizontally. Keep your feet slightly apart and upper arms close to your body.
- When possible, rest your elbows on a table or other stable surface to help keep the camcorder steady.

Traveling Tips

- Write down your camcorder’s serial number and keep it separate from the camcorder when traveling. If your camcorder is lost or stolen, you will be able to identify it.
- Use extra care to avoid damage to your camcorder and accessories when operating them at a beach or pool. Spray, sand, and dust should be avoided. If your lens has been exposed to the elements, clean it only with proper lens cleaning supplies.
- Carry your camcorder in a carrying case when traveling. *See page 6* for a case especially designed for this camcorder. An ordinary suitcase or carry bag does not offer the protection your camcorder needs. Treat your camcorder as carry-on luggage to protect it from rough handling.
- Make sure you have any plug adapters you may need before taking your camcorder to other countries. Consult your dealer for advice.

Table of Contents

Product Registration	Inside Front Cover
Safety Precautions	1-3
Recording Tips	4
• Holding the Camcorder	4
• Traveling Tips	4
Optional Accessories	6-9
• Accessory Order Form	7-8
• Using a Tripod.....	9
First-Time Operation	
• Unpack the Camcorder and Accessories	10
• Attach the Shoulder Strap.....	11
• Attach Adapter/Charger or Charged Battery	11
• Attach the Lens Cap Cord and Adjust the Hand Strap	12
• Insert a Cassette in the Camcorder.....	12
• Set <i>SCENE SELECT</i> control to <i>AUTO</i>	13
• Turn On Camcorder and Place <i>ON/POWER SAVE</i> lever to <i>ON</i>	13
• Adjust Viewfinder and Eyepiece Focus Control	13
• Start and Stop Recording.....	13
• Play Back What You Have Recorded	14
• Review the Camcorder Controls	14-15
Remote Control	
• Functions of Remote Buttons.....	16-17
• Remote Control Sensor.....	17
• Replace Remote Battery Cell	18
Powering Your Camcorder	
• Adapter/Charger	19
• Rechargeable Battery	
• Refresh and Charge the Battery	20
• Using the Battery	21
• Battery Level Indicators	21
• Optional Car Cord Adapter/Charger	22
Video Cassettes	
• Insert and Remove Cassette.....	23
• Erase Protection — Safety Tab	23
• Recording and Playback Speeds and Times	23
Recording Features	
• Date and Time Display	
• Install Lithium Cell.....	24
• Set and Record Time and Date	24
• Viewfinder	25
• Eyepiece Focus Control	25
• Tilt Adjustment	25
• Displays in Viewfinder	26-27
• Quick Review	28
• Camera Edit	28
• Microphone.....	28
• Tally Light	28
• Automatic Head Cleaner	28
• Auto Mode.....	29
• Tape Positioning	29
• <i>MIC</i> (Microphone) Jack	29
• Flying Erase Head	29
• Focusing Your Camcorder	30
• <i>SCENE SELECT</i> Modes	31
• Zooming and Fading.....	32
• Time Counter with Memory Stop and Tape Remaining	33
• Recording from a TV or VCR	34
Playback Features	
• Viewfinder Playback	35
• Playback Features	
• Stop-Action Pause	35
• Frame Advance	35
• Slow-Motion Playback	35
• Visual Search	35
• See Viewfinder Displays on TV	35
• Playback on TV or VCR Using <i>AUDIO/VIDEO IN</i> Jacks	36-37
• Playback on TV Without Audio/Video Inputs.....	38-39
Care and Maintenance	
• Camcorder Care and Storage.....	40
• Rechargeable Battery Care and Storage	40
• Cassette Care and Storage	40
• Cleaning the Camcorder	41
• Cleaning the Lens	41
• Cleaning the Viewfinder.....	41
Trouble Checks	42-43
Design Specifications	44
Information to User	44
Consumer Assistance and Service	45
Limited Warranty	46-47
Index (Alphabetical)	48-49

Optional Accessories

To order accessories, contact your local dealer, call toll free, or use the order form *on the next page*.

AC025A Soft Carrying Case

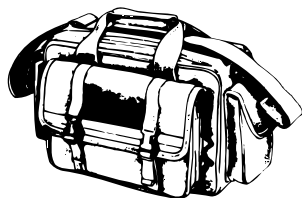

Custom compact soft case designed especially to provide protection and utility for your 8mm camcorder and most accessories. Rugged fabric lined with soft

non-abrasive material and generous padding. Has three outside pockets with storage for lens filters, adapters, batteries, and tapes.

Rechargeable Batteries

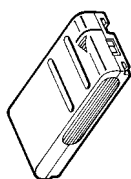

AV608

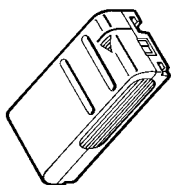

AV8MM

These rechargeable nickel-cadmium batteries are specifically designed for long life. The AV608 can power your camcorder up to one hour, and the

AV8MM up to two hours (depending on how much you use zoom and pause). Both can be recharged with the AC adapter/charger that came with your camcorder.

DCC05 Car Cord Adapter/Charger

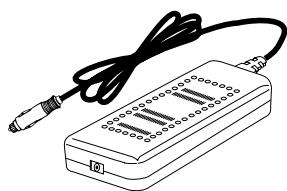

This car cord adapter/charger enables you to operate your camcorder from your car, truck, or RV by plugging the car cord directly into the vehicle's cigarette lighter socket. It will

also charge the AV608 battery supplied with the camcorder or the AV8MM long play battery. The DCC05 is specially designed to convert power from a 24-volt or 12-volt battery to a 6.5-volt output.

Caution: Do not use any other car cord with this camcorder. It may damage the camcorder.

VDC88 Color Enhancement Light

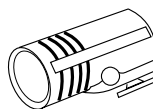

This ultra compact 15-watt video light is cordless, light in weight, and includes a rechargeable battery. It mounts on the top of the camcorder and fits on a standard accessory shoe. The VDC88 provides excellent soft, lush fill light. It uses one 15-watt (VDC090) replacement bulb. The rechargeable battery BP1000 can be charged with the VDC085 battery charger.

VCC1000 Video Color Control Center

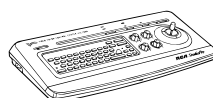

The VCC1000 is two accessories in one. The color control center lets you adjust the color intensity, tint, white balance, and sharpness of tapes being dubbed. This is especially helpful when the original tape was produced in poor lighting conditions or poor color settings. The second feature, the character generator, lets you create titles that can be recorded on your tapes. This lets you add a professional and/or personal touch to your home videos.

CRF800 RF Output Adapter

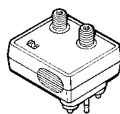

This adapter is used with coaxial RF cable (AH065G or AH066G) to connect your camcorder to a standard TV (one without audio/video input jacks) for playback. If your antenna cable is the flat twin-lead type attached by two screws, you will also need a 300-75 ohm transformer, such as 193983. If your TV has 300 ohm VHS screw terminals, you will need an optional 75-300 ohm transformer, such as AH011.

Coaxial RF Cables

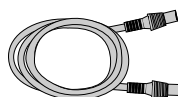

AH065G (6-ft)

AH066G (10-ft)

These RF cables are used with the CRF800 RF output adapter to connect your camcorder to a standard TV (one without audio/video input jacks) for playback.

If your antenna cable is the flat twin-lead type attached by two screws, you will also need a 300-75 ohm transformer such as 193983.

If your TV has 300 ohm VHS screw terminals, you will need an optional 75-300 ohm transformer such as AH011.

Accessory Order Form

193983 Cable Transformer

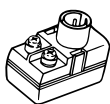

This 300-to-75 ohm transformer is used to connect a standard 300-ohm antenna

twin-lead to a standard round 75-ohm connector.

AH011 Cable Transformer

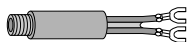

This 75-to-300 ohm transformer is used

to connect a standard 75-ohm antenna cable, such as AH065G or AH066G, to the 300-ohm screw terminals on a TV.

Audio/Video Cables

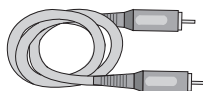

AH069G (3-ft)

AH070G (5-ft)

These cables are shielded for connecting *AUDIO* and *VIDEO* jacks. They have RCA-type phono plugs on each end.

Monaural VCR Dubbing Cable

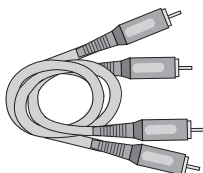

AH075G (6-ft)

This is a double cable that lets you connect the *AUDIO* and *VIDEO* jacks of monaural components. It can be used to connect your camcorder to a TV monitor (or VCR). The cable is color coded and shielded with RCA-type phono plugs on each end.

All specifications and descriptions of accessories are subject to change without notice.

Detach Here



Order Form for Pro845

Description	Part No.	Price	Qty.	Total
Soft Camcorder Case	AC025A	\$ 59.95		
Tripod	AC088	\$ 39.95		
Cable Transformer	AH011	\$ 1.90		
RF Coaxial Cable (6-ft.)	AH065G	\$ 6.99		
RF Coaxial Cable (10-ft.)	AH066G	\$ 8.99		
Audio/Video Cable (3-ft.)	AH069G	\$ 5.99		
Audio/Video Cable (5-ft.)	AH070G	\$ 7.99		
Dubbing Cable (6-ft.)	AH075G	\$ 10.99		
Rechargeable Battery (1 Hour)	AV608	\$ 49.95		
Rechargeable Battery (2 Hour)	AV8MM	\$ 59.95		
AC Adapter/Charger	CPS801A	\$189.95		
RF Output Adapter	CRF800	\$ 49.95		
Car Cord Adapter/Charger	DCC05	\$169.95		
DC Cable for Adapter/Charger	DCC100	\$ 14.95		
Video Control Center	VCC1000	\$349.90		
Color Enhancement Light	VDC88	\$ 79.95		
Replacement Bulb (15 watt) for VDC88	VDC090	\$ 12.95		
Extra Battery for VDC88	BP1000	\$ 29.95		
Charger for BP1000	VDC085	\$ 18.95		
Cable Transformer	193983	\$ 6.95		
Replacement Remote Control	218501	\$ 39.95		
Shoulder Strap	218555	\$ 13.95		
Audio/Video Cable	217496	\$ 7.99		

Prices are subject to change without notice.

Total Merchandise (\$10 Minimum Order) \$ _____

Sales Tax \$ _____

We are required by law to collect the appropriate sales tax for each individual state, county, and locality to which the merchandise is being sent.

Shipping, Handling, and Insurance \$ 5.00

Total Amount Enclosed \$ _____

Use VISA or MasterCard preferably. Money order or check must be in U.S. currency only. No COD or CASH.

- Allow eight weeks for delivery.
- All accessories are subject to availability.
- Where applicable, we will ship a superseding model.

Please complete other side also

Accessory Order Form (continued)

Charge your order on your VISA
or MasterCard by
filling in below

USE YOUR CREDIT CARD

IMPORTANT: Copy complete account number
from your VISA card



My card expires:

IMPORTANT: Copy complete account number
from your MasterCard



Copy Number
above your
name on
MasterCard My card
expires:

AUTHORIZED SIGNATURE

Prices are subject to change without notice.



Print or type your name and
address clearly. This will be
your mailing label.

A complete and correct
order will save you days
of waiting.

Name: _____

Street: _____

_____ Apt: _____

City: _____

State: _____ Zip: _____

Please make sure that both sides of this form
have been filled out completely.

Detach Here 

To order accessories, contact your local Dealer.

If a dealer is not nearby, you can also
follow the directions below to order by
telephone or direct-by-mail.

United States and Canada Orders

To place your order by phone, have your
Visa or MasterCard ready and call the
toll-free number listed below between
8AM and 8PM Eastern Standard Time.

**Use this number only to place an
order for accessory items listed on this
order form.**

1 – 800 – 338 – 0376

Most times your order will be shipped
UPS within 72 hours of receipt. If ever
it is not possible to ship within 30 days,
we will notify you with an update on
your order and an option to cancel.

To place your order by mail, detach and
mail the completed order form with
credit card information, money order, or
check in U.S. currency (made payable to
Thomson Consumer Electronics, Inc.) to
the following address:

Video Accessories
PO Box 8419
Ronks, PA 17573

**For more information on these
accessories (or current prices), write
to the following address:**

Video Accessories Customer Service
Thomson Consumer Electronics, Inc.
Distributor & Special Products
2000 Clements Bridge Rd
Deptford, NJ 08096-2088

International Orders

This offer is valid only in the 50 United
States and Canada. For international
orders, please send your request for a
price quotation (not an order) to:

International Customer Service
Thomson Consumer Electronics, Inc.
Distributor & Special Products
2000 Clements Bridge Rd
Deptford, NJ USA 08096-2088

Optional Tripod or Monopod

AC088 Tripod

This tripod's fluid-effect head provides smooth camera pan and tilt. The grooved, tubular 3-section leg design folds down to 26" when not in use and weighs only 4 lbs. Rubber feet allow for sure footing.

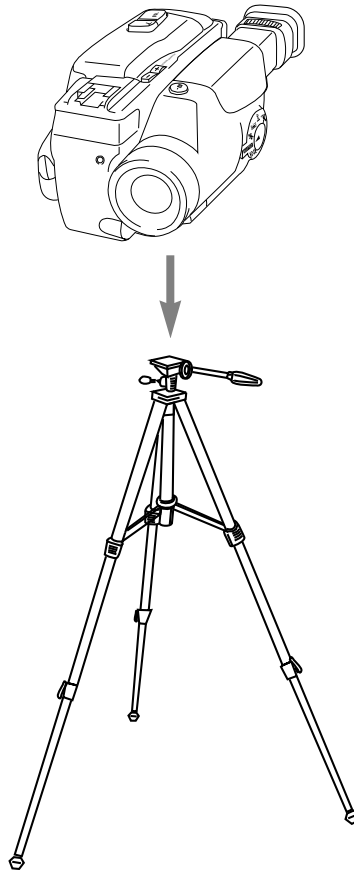

Cautions: Before using a tripod, make sure it is stable enough to hold the camcorder without falling over. When attaching your camcorder to a tripod, be careful not to force its screw into the camcorder's mounting hole.

The tripod screw should not protrude into the camcorder more than approximately three-eighth ($3/8$) inch. Forcing the screw could damage the mounting hole on the bottom of the camcorder.

All specifications and descriptions of accessories are subject to change without notice.

First-Time Operation

1. Unpack the camcorder and accessories.

- Save the packing materials and box in case you ever need to ship or store your camcorder.
- The items shown below are packed with your camcorder. If any are missing or appear damaged, contact your dealer immediately.

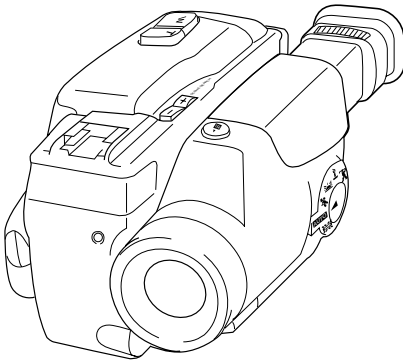

Camcorder
Model Pro845

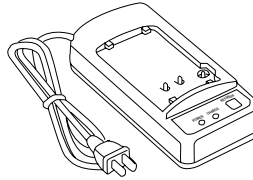

AC Adapter/Charger
Part No. CPS801A



DC Connecting Cord
Part No. DCC100

Caution: Do not use this adapter/charger for any other purpose other than charging the AV608 or AV8MM battery pack or supplying power to the camcorder.

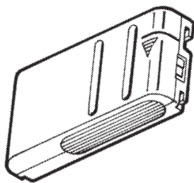

Rechargeable Battery
Part No. AV608

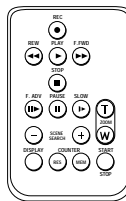

Remote Control with Lithium
Cell Battery Installed
Part No. 224175

Note: Before using – remove plastic film covering cell.

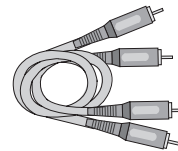

Audio/Video Output Cable
Part No. 217496

**WARNING: NICKEL
CADMIUM BATTERY
MUST BE DISPOSED
OF PROPERLY.**

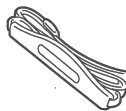

Shoulder Strap
Part No. 218555



Lens Cap Cord
Part No. 224176



Clock and Remote Batteries
(Remote Battery Installed in Remote): 3-Volt Micro Lithium Cell Batteries. Replace only with – Duracell No. DL2025 – available from most local drug stores. Use of another cell may present a risk of fire or explosion.

Cautions: Lithium cell batteries. Must be disposed of properly. Never handle punctured or leaking cells. May cause burns or personal injury. Keep out of the hands of children. Can cause death or injury if swallowed. If swallowed, consult a physician immediately for emergency treatment. The lithium cell used in this device may explode resulting in a fire or chemical burn if mistreated. Do not recharge, disassemble, heat above 212°F (100° C), or incinerate. Never use metallic tweezers to hold the cell, and never short circuit the + and – sides of the battery.

First-Time Operation (continued)

2. Attach the shoulder strap.

A. Unfasten one end of the shoulder strap from the buckle. Leave the buckle on the strap.

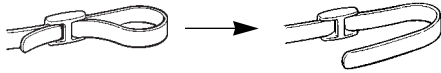

B. Thread one end of the shoulder strap through one of the shoulder strap rings.

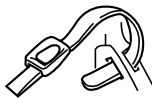
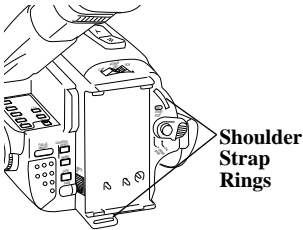

C. Thread the strap back into the buckle. Pull on the strap and make sure it is securely fastened before using it to support the camcorder.



D. Repeat steps A-C for the other end of the shoulder strap.

3. Attach adapter/charger or charged battery.

A. Adapter/Charger

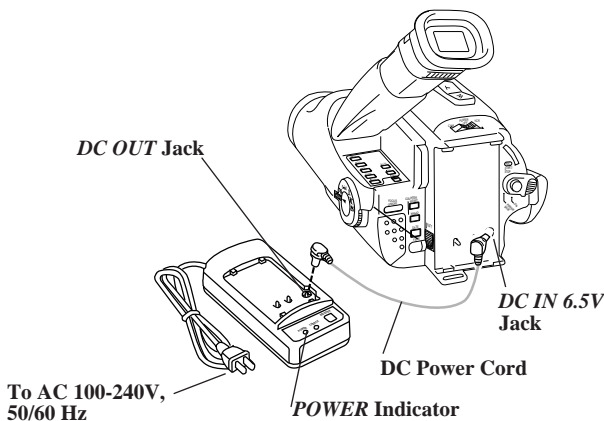

1. Connect one end of the DC power cord to the *DC OUT* jack on the adapter/charger and the other end to the *DC IN 6.5V* jack on the camcorder.
2. Plug in the adapter/charger. The adapter/charger's *POWER* indicator will light.

Details are on page 19.

B. Charged Battery*

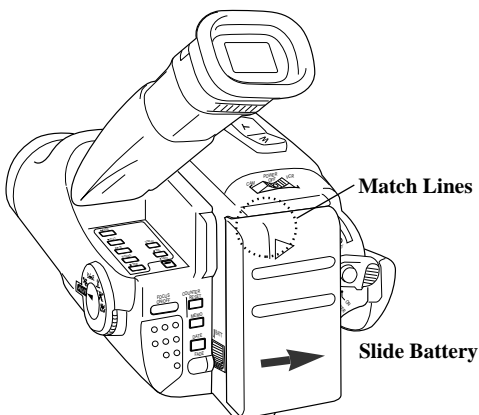

1. Make sure the camcorder's *POWER* switch is *OFF*.
2. Match the lines on the battery and camcorder.
3. Hold the battery flush against the camcorder, and slide it in the direction of the arrow until it locks into place.

* The battery must be charged before it can be used the first time. *Details are on page 20.*

(continued on next page)

First-Time Operation (continued)

4. Attach the lens cap cord and adjust the handstrap.

A. Press on both sides of the lens cap to remove it.

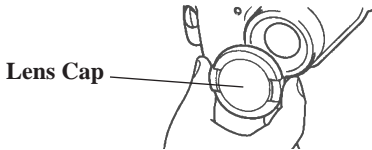

B. Attach the lens cap cord to the lens cap.

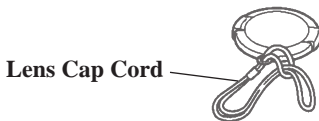

C. Unsnap the handstrap flap and open the adjustment strap.

D. Put the lens cap cord through the holder and over the adjustment strap.

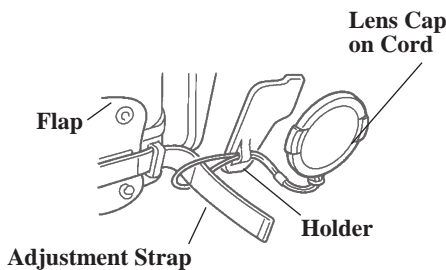

E. Put your hand in the handstrap.

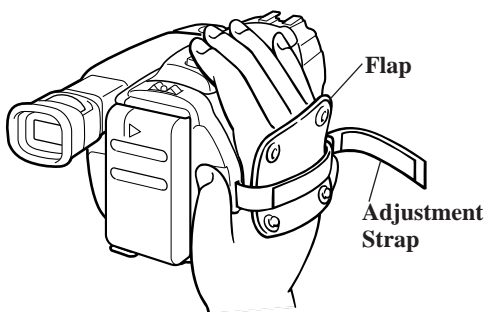

F. Pull adjustment strap to tighten and close.

G. Snap the flap shut.

H. Attach the lens cap to the handstrap.

5. Insert a cassette in the camcorder.

A. Press *EJECT* to open the cassette compartment.

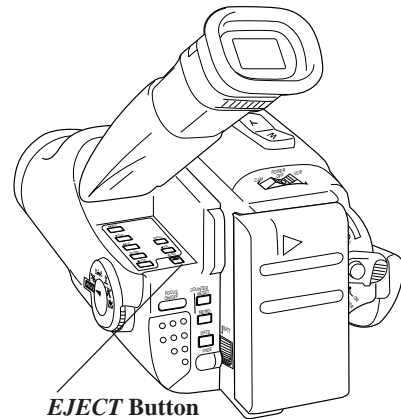

B. Insert a cassette with the safety tab facing up and the tape window facing out.

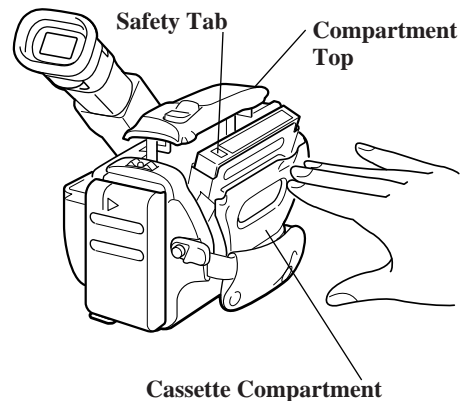

C. Gently press on the compartment where it is labeled *PUSH* until it locks into place. The top will close automatically.

Caution: Do not press down on the top or you may damage your camcorder.

First-Time Operation (continued)

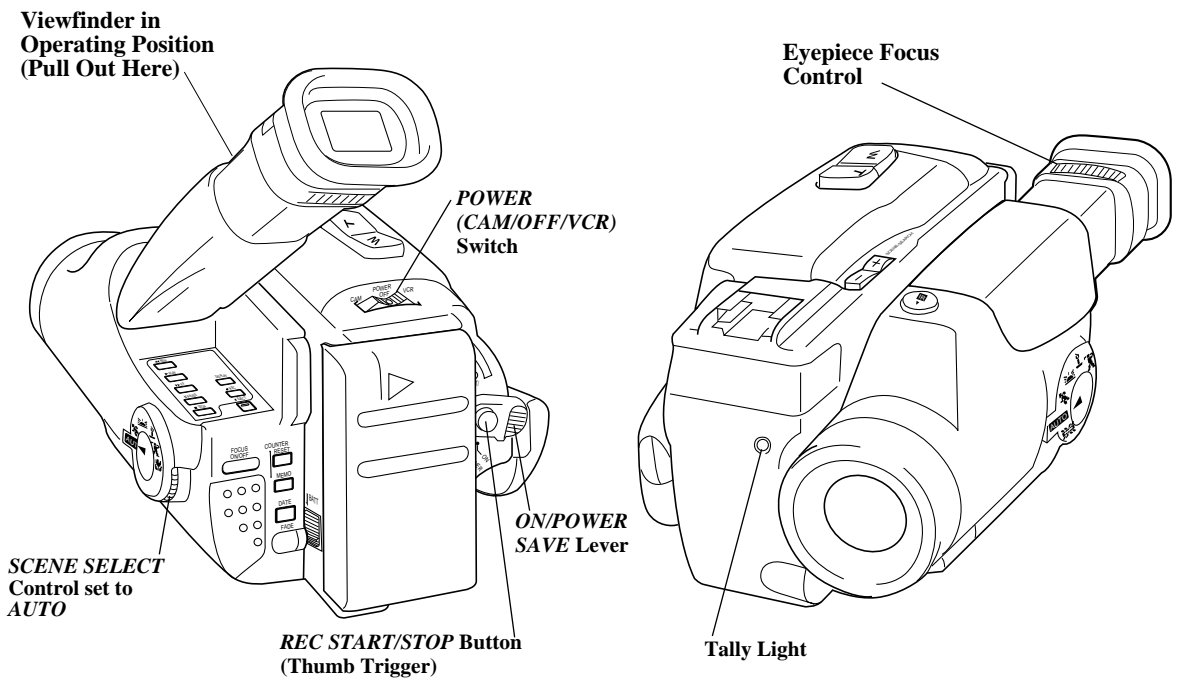

6. Set *SCENE SELECT* to *AUTO*.

7. Turn on camcorder and place *ON/POWER SAVE* lever *ON*.

- A. Press and hold the small button on the *POWER* switch while placing it in *CAM* (camera).

The position of the *POWER* switch tells the camcorder whether you want to record (*CAM*), play back tapes (*VCR*), or turn off the camcorder's power (*OFF*).

- B. Place *ON/POWER SAVE* lever *ON*. This lever must be *ON* for the camcorder to record.

Place *ON/POWER SAVE* lever in *POWER SAVE* position during recording breaks to conserve battery power. The camcorder will enter record pause.

- * If the dew indicator  appears in the viewfinder, there is excessive moisture in the camcorder. Remove the cassette from the camcorder, and let it dry naturally.

8. Adjust viewfinder and eyepiece focus control.

- A. Pull the viewfinder out and raise into a comfortable operating position.
- B. If the viewfinder picture is blurry, adjust the eyepiece focus control for your vision.

Details are on page 25.

9. Start and stop recording.

- A. Press and release *REC START/STOP* (thumb trigger) to start and stop recording. *REC* appears in the viewfinder during recording.

If you do not record within five minutes, the camcorder will automatically turn off.

The tally light flashes during record pause and turns off when the camcorder is recording or the *ON/POWER SAVE* lever is in *POWER SAVE*.

First-Time Operation (continued)

10. Play back what you have recorded.

- A. Press thumb trigger to stop recording.
- B. Press and hold the small button while you place *POWER* in *VCR*.
- C. Press *REW* to rewind the tape.
- D. Press *PLAY* to play back the tape in the viewfinder.
- E. Press *STOP* when you are finished playing back the tape.

Details on viewfinder playback are on page 35.

11. Review the camcorder controls.

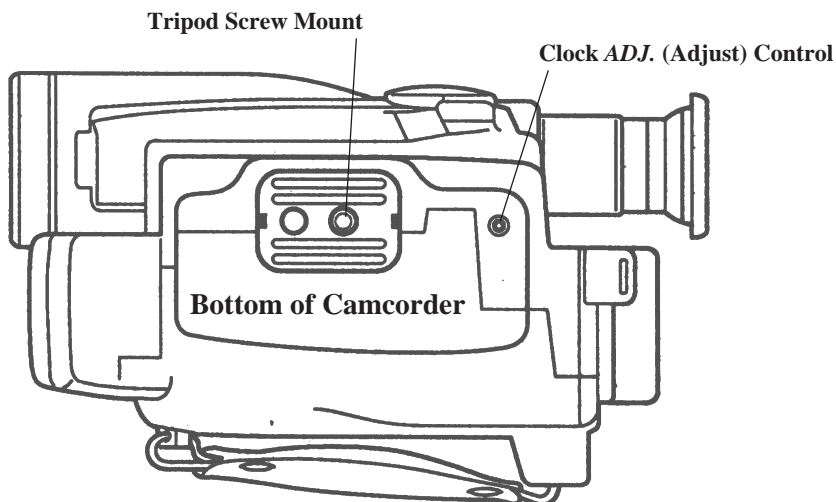
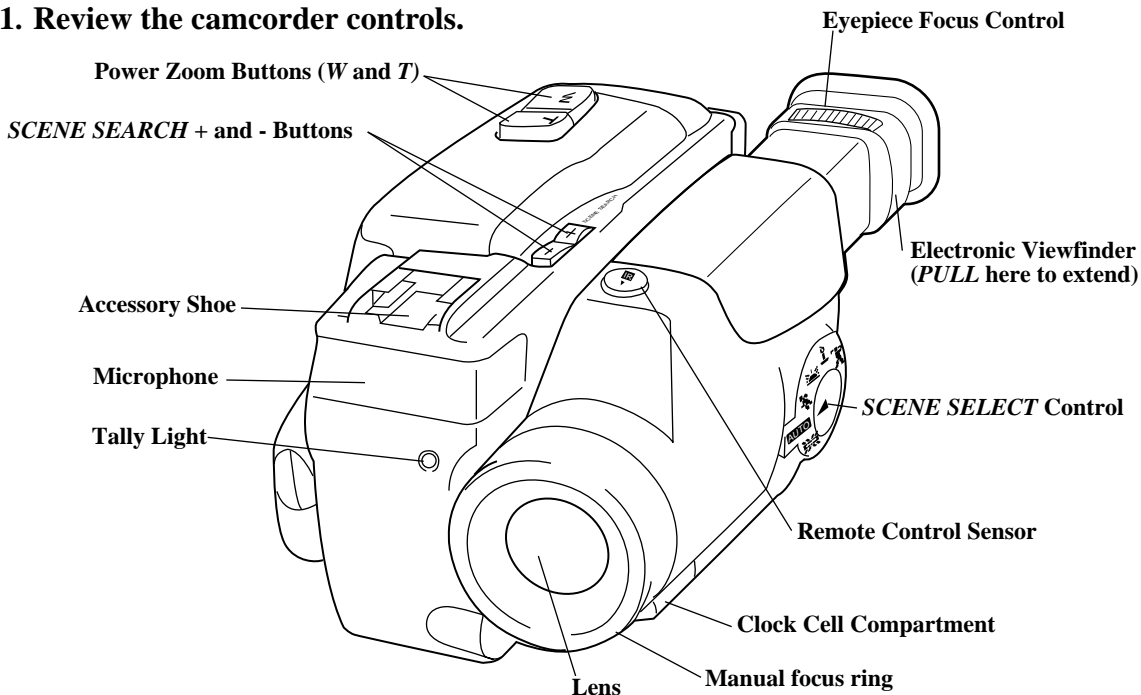

First-Time Operation (continued)

11. Review the camcorder controls. (continued)

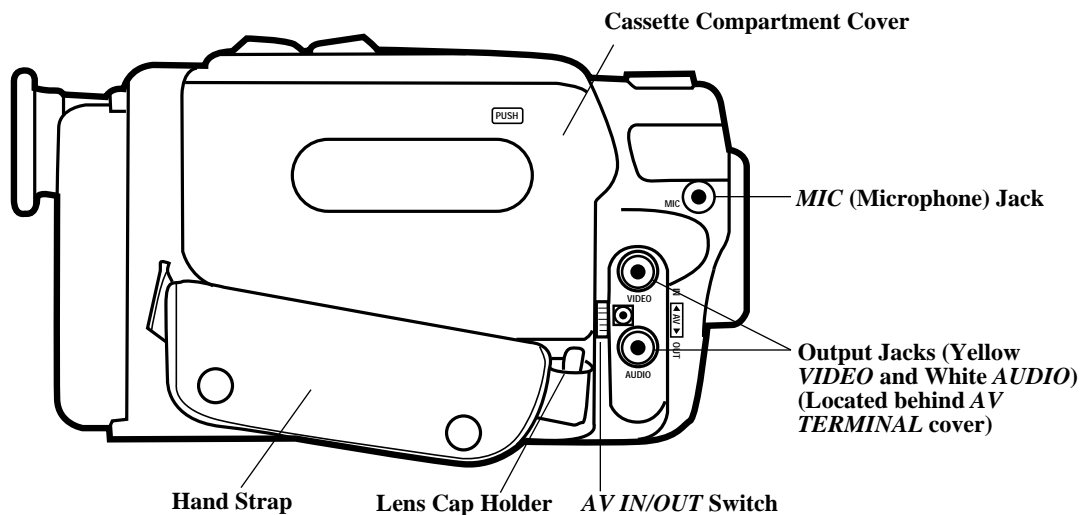
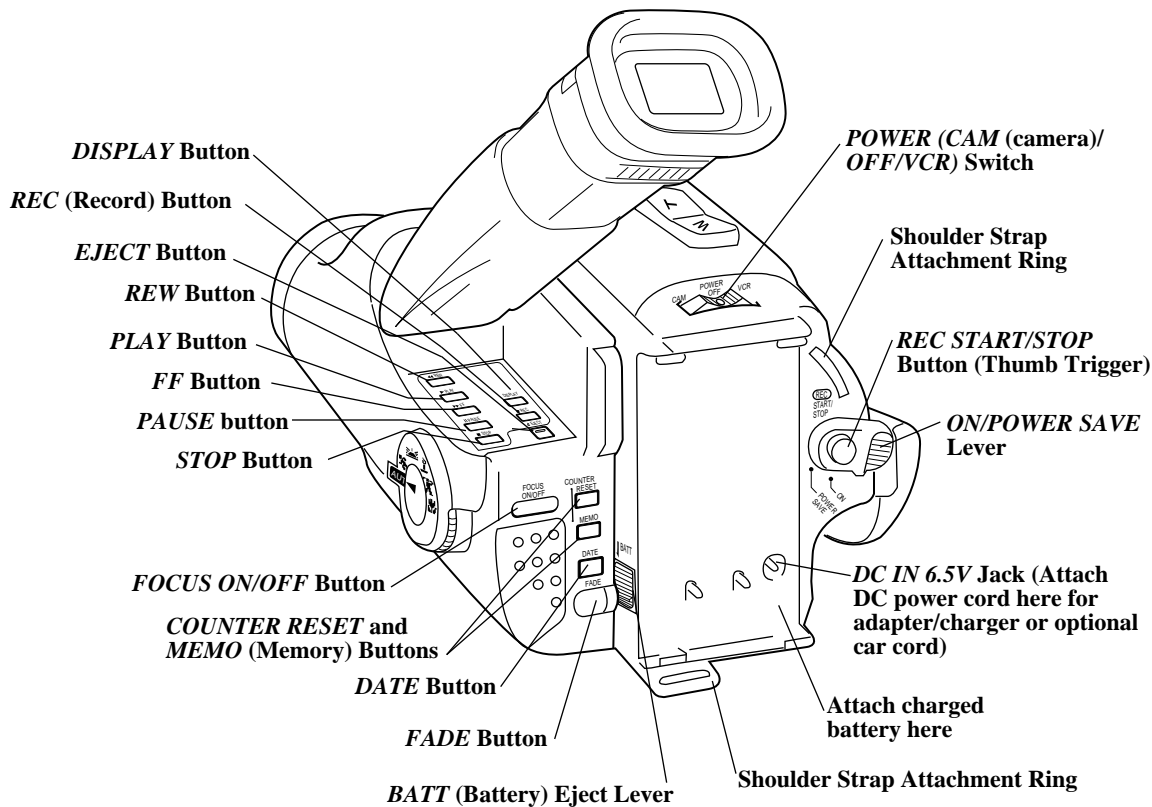

Remote Control

Functions of Remote Buttons

Most of the remote control buttons perform the same function as the corresponding controls on the camcorder. You can use whichever are more convenient at the time.

Note: Before using the remote for the first time, remove the plastic film covering the battery cell.

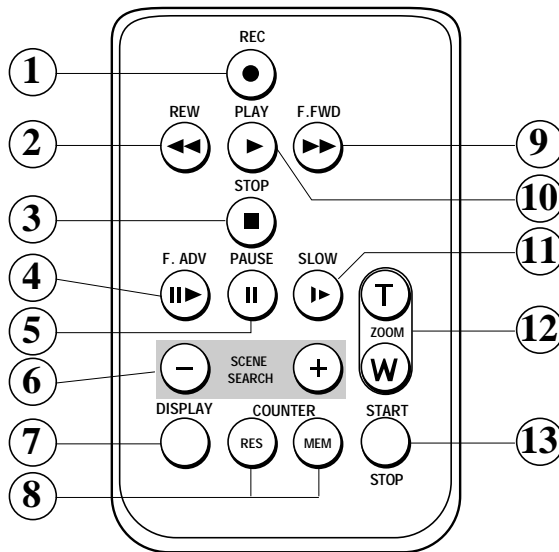

1 REC (Record) Button

- Press and release *REC* when *POWER* is in *VCR* to record from the *AUDIO/VIDEO IN* jacks on the camcorder.
- The tally light will light continuously during recording.
- This button has no effect when *POWER* is in *CAM* (camera). To start recording, press *START/STOP* 13.

2 REW (Rewind) Button

- Press *REW* when the camcorder's *POWER* switch is in *VCR* to rewind the tape.
- During playback or rewind, press and hold *REW* to visually search the tape in reverse. Release *REW* to return to normal playback or rewind.

3 STOP Button

- Press *STOP* when the camcorder's *POWER* switch is in *VCR* to stop playback, rewind, or fast forward.
- The *STOP* button has no effect when the *POWER* switch is in *CAM*. To stop recording, press *START/STOP* 13.

4 F.ADV (Frame Advance) Button

During playback, press *PAUSE*, then *F.ADV* to view one frame at a time. Press *PAUSE* again (or *PLAY*) to return to normal playback.

5 PAUSE Button

During playback, press *PAUSE* to produce a stop-action picture. Press *PAUSE* again (or *PLAY*) to return to normal playback.

6 SCENE SEARCH - and + Buttons

- During record pause, press and release *SCENE SEARCH -* to review the last few seconds of recorded material.
- During record pause, press and hold *SCENE SEARCH +* or *-* to visually search the tape in forward or reverse. Release the button to return to record pause at that point on the tape.

7 DISPLAY Button

Press *DISPLAY* when the camcorder is connected to a TV to see the viewfinder's displays on the TV screen. Press *DISPLAY* again to remove them.

Remote Control (continued)

8 COUNTER RES (Reset) and MEM (Memory) Buttons

- Press *COUNTER RES* to reset the time counter to "0:00:00".
- Press *COUNTER MEM* during recording to display amount of recording time left on the tape.
- Press *COUNTER MEM* during playback to turn memory stop on and off.
- *Details are on page 33.*

9 F.FWD (Fast Forward) Button

- Press *F.FWD* when *POWER* is in *VCR* to fast forward the tape.
- During playback or fast forward, press and hold *F.FWD* to visually search forward on the tape. Release *F.FWD* to return to normal playback or fast-forward operation.

10 PLAY Button

Press *PLAY* when the camcorder's *POWER* switch is in *VCR* to begin playback.

11 SLOW Button

During playback, press *SLOW* to begin slow-motion playback. Press *PLAY* to return to normal playback.

12 ZOOM "W" and "T" Buttons

Camcorder's *POWER* switch in *CAM*:

- Press "T" to move the lens in the telephoto (close-up) direction.
- Press "W" to move the lens in the wide-angle direction.

13 START/STOP Button (Same as Thumb Trigger)

- Press and release *START/STOP* when *POWER* is in *CAM* (camera) to start and stop recording.
- The tally light will light continuously during recording.

Remote Control Sensor

The remote control operates the camcorder by infrared light, so it is protected from electrical and sound interference. Aim the remote directly at the camcorder's remote control sensor. There cannot be any obstructions between them. The remote should operate the camcorder up to approximately 13 feet away.

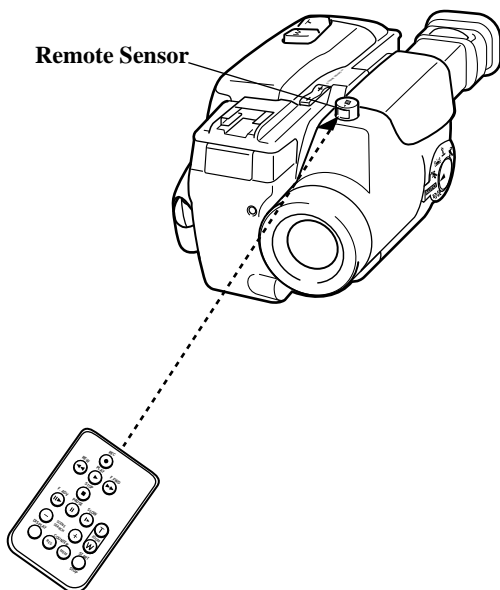

1. Press on the remote sensor (labeled *IR*) to expose it. Point the arrow on top of the sensor in the direction of the remote. The sensor will face in any direction.
2. Aim the remote at the remote sensor.
3. When you are finished, press the remote sensor back down until it locks into place.

Notes: An RCA VCR that responds to the *VCR 2* button on the VCR's remote may respond to this remote control.

The camcorder may not respond to the remote if the camcorder's remote sensor is exposed to direct sunlight or strong artificial light.

Remote Control (continued)

Replace Remote Battery Cell

1. Turn the remote over. Insert a pencil or paper clip in the small hole and slide it in the direction of the arrow while removing the battery cell holder.

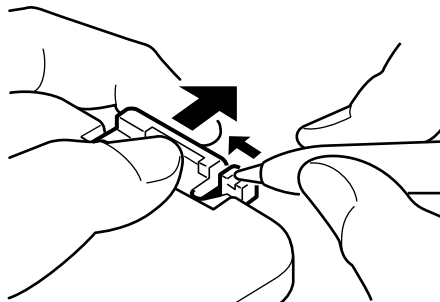

2. Remove the old battery by pushing it to the front and then up.

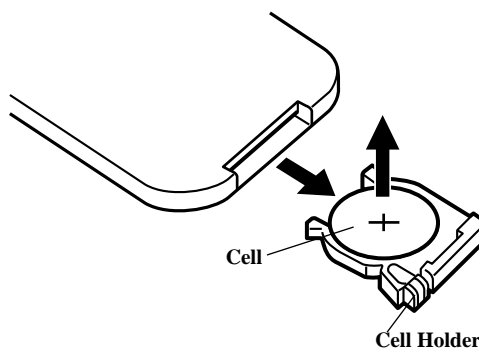

3. Insert the lithium cell into cell holder so its positive (+) terminal faces up.
4. Slide the holder back into the remote until it clicks into place.

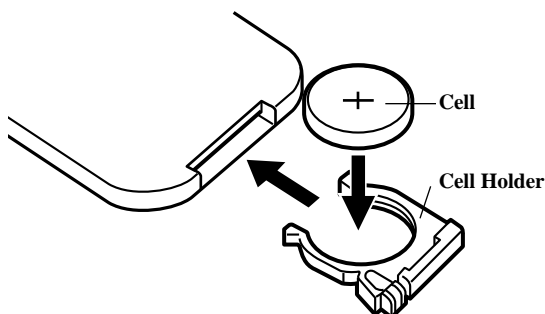

Notes: Never place anything heavy on top of the remote or lay it upside down.

Replace the cell when the camcorder fails to respond to the remote.

Remove the cell from the remote if it will not be used for a month or more. This will prevent possible damage from leakage. If leakage occurs, wipe up the liquid inside the compartment, and replace the cell with a new one.

Cautions: Lithium cell battery. Replace only with 3-Volt micro lithium cell—Duracell No. DL2025. Use of other cells present a risk of fire or explosion. Must be disposed of properly. Never handle punctured or leaking cells. May cause burns or personal injury.

Keep out of the hands of children. Can cause death or injury if swallowed. If swallowed, consult a physician immediately for emergency treatment.

The lithium cell used in this device may explode resulting in a fire or chemical burn if mistreated.

Do not recharge, disassemble, heat above 212°F (100° C), or incinerate.

Never use metallic tweezers to hold the cell, and never short circuit the + and - sides of the battery.

Powering Your Camcorder

Adapter/Charger

The adapter/charger lets you power your camcorder directly from standard household power. It operates on 100-240 volts, 50/60 Hz, so it can be used virtually anywhere in the world to power the camcorder or recharge the battery. You may need a plug adapter in some countries. Consult your dealer.

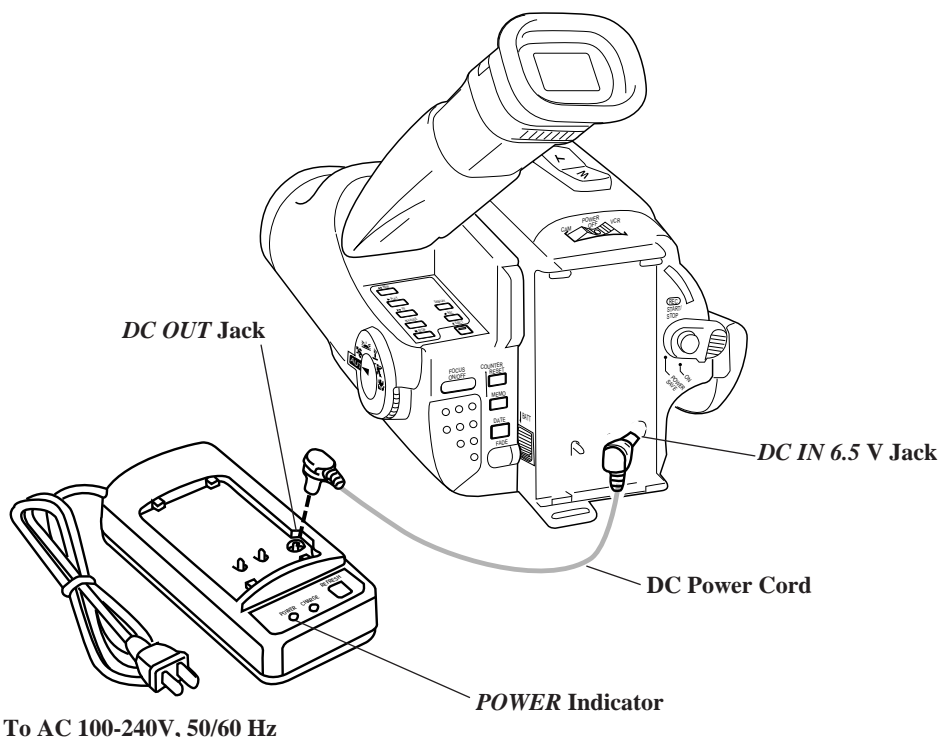

Use the Adapter/Charger

1. Plug one end of the DC power cord into the *DC OUT* jack on the adapter/charger and the other end to the *DC IN 6.5V* jack on the back of the camcorder.
2. Plug the adapter/charger's plug into the nearest AC outlet (100-240V, 50/60Hz). The *POWER* indicator will light.

Note: The battery level indicator has no meaning when you power the camcorder with the adapter/charger.

Remove the Adapter/Charger

1. Unplug the adapter/charger from the wall outlet.
2. Disconnect the DC power cord from the camcorder and adapter/charger.

Using an Optional Plug Adapter

An optional plug adapter may be required in some countries.

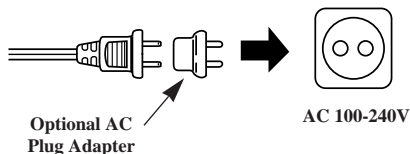

1. Plug the adapter/charger's plug into the AC plug adapter.
2. Plug the AC plug adapter into an AC outlet (100-240V, 50/60Hz).

Powering Your Camcorder

Rechargeable Battery

The battery must be charged before it can be used the first time. Initial charging will take approximately one hour. When fully charged, the battery should supply about 45-65 minutes of operating time (depending on how much you use zoom and pause, auto focus, and record pause).

Place *ON/POWER SAVE* in *POWER SAVE* during recording breaks to conserve power. Place it back in *ON* when you are ready to resume recording.

Refresh and Charge the Battery

The nickel cadmium battery will provide longer operation time if it is refreshed (completely discharged) before every charging. Refreshing a battery will take approximately 3-1/2 hours.

Use the small marker switch on the top of the battery to help you remember to recharge the battery. It has no other function.

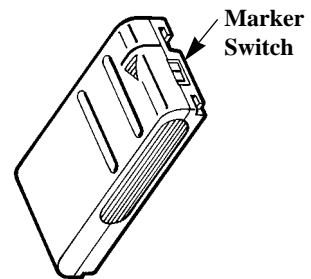
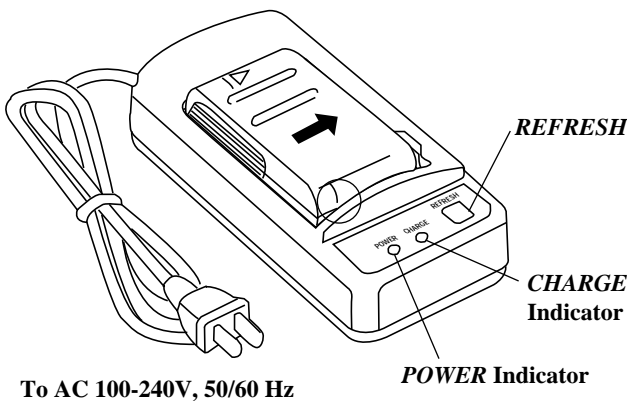

Caution: When a battery is attached to the adapter/charger, do not turn the adapter/charger upside down. The battery may fall off and be damaged or cause injury.

1. If the DC power cord's plug is connected to the adapter/charger, remove it.
2. Plug the adapter/charger into the nearest AC outlet (100-240V, 50/60Hz). The *POWER* indicator will light.
3. Align the reference marks on the battery and adapter/charger.
4. Hold the battery flush against the adapter/charger, and slide it in the direction of the arrow until it locks into place. The *CHARGE* indicator will light.
5. Press *REFRESH* to discharge the battery. After a few seconds, the *CHARGE* indicator will flash slowly. It will stop flashing when the battery has been discharged. The *CHARGE* indicator will light and the battery will automatically recharge.
6. Slide the charged battery off the adapter/charger to remove it. Unplug the AC power cord.

Note: If the *CHARGE* indicator starts flashing rapidly, remove the battery from the adapter/charger and try attaching it again.

Battery Safety Precautions

Throwing the battery into a fire or exposing the battery to excessive heat – over 149°F (65°C) – could be hazardous.

Do not short the battery's terminals.

Do not attempt to disassemble or modify the battery. There are no user-serviceable parts inside.

Use the battery only with specified adapter/chargers and camcorders.

Powering Your Camcorder

Rechargeable Battery (continued)

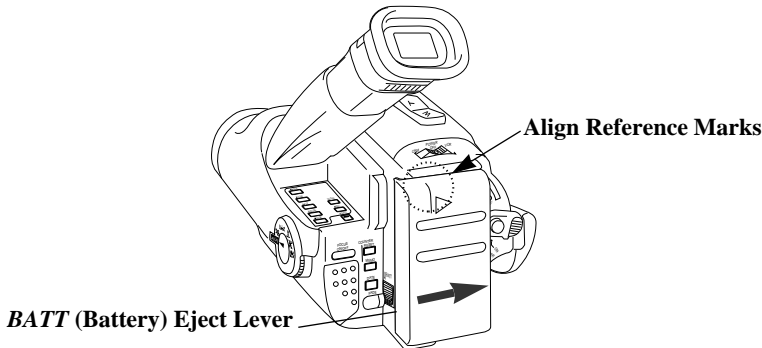

Attach the Charged Battery



1. If the DC power cord's plug is attached to the camcorder, remove it.
2. Align the reference marks on the battery and camcorder.
3. Hold the battery flush against the camcorder, and slide it in the direction of the arrow.

Remove the Battery

1. Slide and hold the *BATT* (battery) eject lever on the camcorder while sliding the battery to the left and off the camcorder.

Check Battery Power (Battery Level Indicator)

The battery level indicator () appears in the camcorder's viewfinder to show how much battery power is left in the rechargeable battery. This indicator is not recorded on the tape.

- This display  shows the amount of power in the battery.
- When the battery is almost empty,  appears.
When the battery reaches empty,  will start flashing.
Recharge the battery or attach the adapter/charger before continuing to use the camcorder.

Note: The battery level indicator has no meaning when you power the camcorder with the adapter/charger or optional car cord.

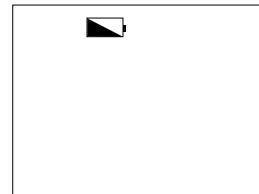

**Battery Level Indicator
Display in Viewfinder**

Caution: The camcorder will shut off when the battery reaches empty. The battery should still eject the cassette when you press the *EJECT* button. If it does not, do not attempt to force the cassette compartment open. This will damage the camcorder.

ATTENTION: THE PRODUCT THAT YOU HAVE PURCHASED USES A RECHARGEABLE BATTERY. AT THE END OF ITS USEFUL LIFE, UNDER VARIOUS STATE AND LOCAL LAWS, IT MAY BE ILLEGAL TO DISPOSE OF THIS BATTERY INTO THE MUNICIPAL WASTE STREAM. CHECK WITH YOUR LOCAL SOLID WASTE OFFICIALS FOR DETAILS IN YOUR AREA FOR RECYCLING OPTIONS OR PROPER DISPOSAL.

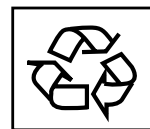

Ni - Cd

Powering Your Camcorder

Optional Thomson DCC05 Car Cord Adapter/Charger

This adapter/charger allows you to power your camcorder from the cigarette lighter socket of a car, truck, or RV. It converts 24- and 12-volts to a 6.5-volt output. It can also charge the battery that came with your camcorder and the AV8MM (long play) battery.

Consult the instructions enclosed with the DCC05 for complete operation information.

Using DCC05 Car Cord Adapter/Charger to Power the Camcorder

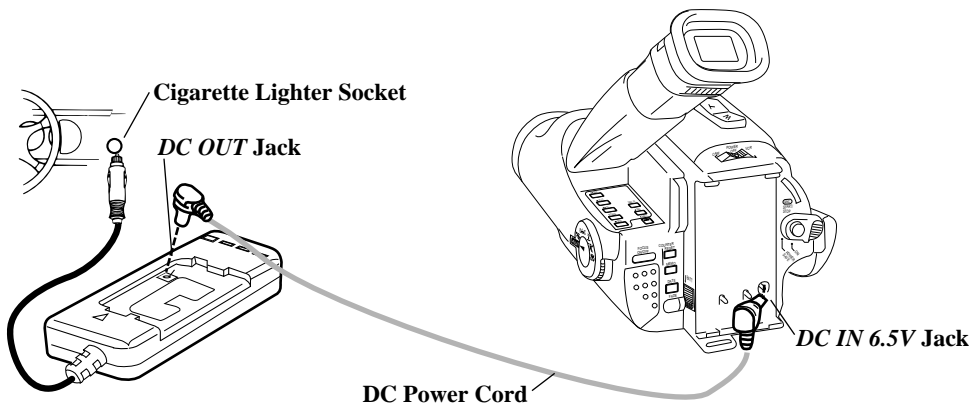

1. Remove battery if it is attached to the camcorder or car cord adapter/charger.
2. Plug one end of the DC power cord into the *DC OUT* jack on the car cord adapter/charger and the other end into the *DC IN 6.5V* jack on the back of the camcorder.
3. Insert the DCC05's plug into the vehicle's cigarette lighter socket. The *POWER* indicator on the DCC05 will light.

Note: The battery level indicator has no meaning when you power the camcorder with the optional car cord adapter/charger.

Cautions: The DCC05 is designed to be used only with vehicles having negative ground electrical systems.

Do not use any other car cord with this camcorder. Other car cords may damage your camcorder.

Using DCC05 Car Cord Adapter/Charger to Charge the Battery

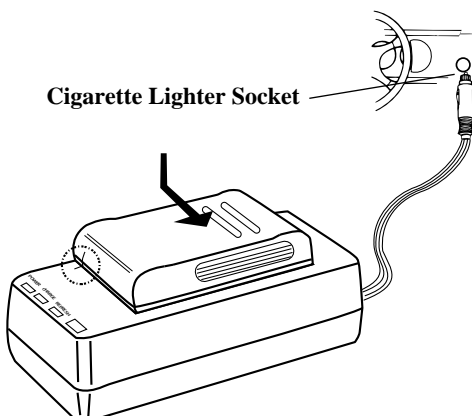

1. Remove DC power cord if it is attached.
2. Attach the battery *as shown*.
3. Insert the DCC05's plug into the cigarette lighter socket. The *POWER* indicator on the DCC05 should light.

RCA Video Cassettes

We recommend our cassettes be used with your camcorder. Use of poor quality or damaged tapes can contaminate the video heads, resulting in snow or no picture during playback. Head cleaning is not covered under warranty. It is considered normal maintenance. The automatic head cleaning system minimizes the need for accessory cleaners or cleaning by a Servicenter. This system is activated whenever you insert or remove a cassette.

Insert and Remove Cassettes

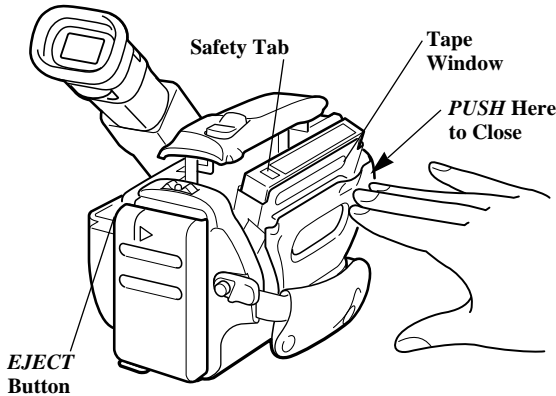

- A. Attach a power supply.
- B. Press *EJECT* to open the cassette compartment.
- C. Insert a cassette.

Caution: Insert the cassette with the safety tab facing up and the tape window facing out. The cassette should slide easily in the compartment. Do not force the cassette.

- D. Gently press on the compartment where it is labeled *PUSH* until it locks into place. The top will close automatically.

Do not press down on the top or you may damage your camcorder.

Erase Protection — Safety Tab

You can use your video cassettes over and over again. To erase a previous recording, just record over it.

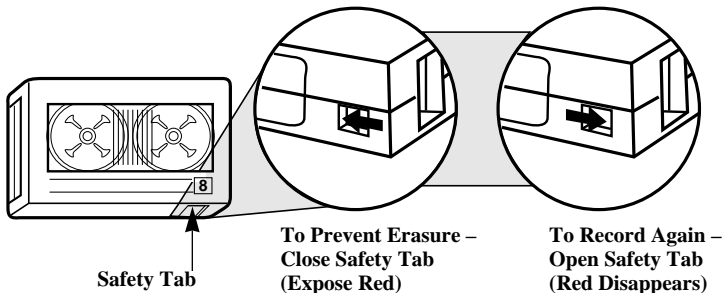

Recording and Playback Speeds and Times

The camcorder records in standard speed (SP). The chart shows the maximum SP recording times for some popular 8mm cassettes.

The camcorder can play back tapes in standard speed (SP) or long play (LP) speed. The playback speed is automatically selected by the camcorder. The *LP* indicator appears in the electronic viewfinder when the camcorder is playing back a tape recorded in LP.

Cassette	Recording Time
P6-15	15 Minutes
P6-20	20 Minutes
P6-45	45 Minutes
P6-60	60 Minutes
P6-90	90 Minutes
P6-120	2 Hours
P6-150	2 1/2 Hours

Date and Time Display

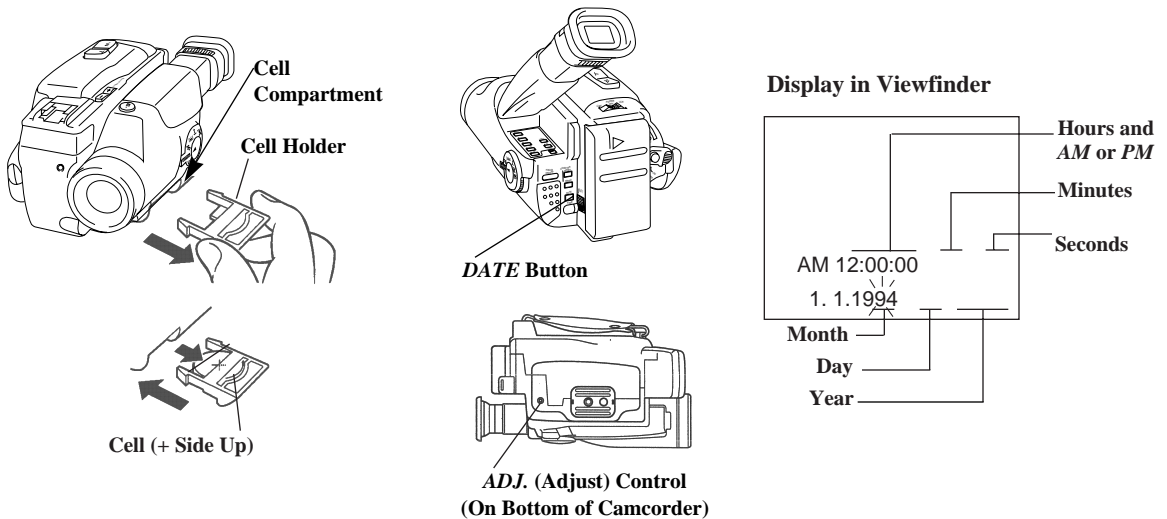

Install the Lithium Cell for Time and Date Display

1. Pull out the cell holder.
2. Insert the cell into the cell holder with the “+” terminal up.
3. Replace the cell holder.

Note: The lithium cell should last about one year. When it expires, the date display shows “88:88”. Reset the date and time after replacing the cell.

Cautions: Lithium cell battery. Replace only with 3-Volt micro lithium cell—Duracell No. DL2025. Use of other cells present a risk of fire or explosion. Must be disposed of properly. Never handle punctured or leaking cells. May cause burns or personal injury. Keep out of the hands of children. Can cause death or injury if swallowed. If swallowed, consult a physician immediately for emergency treatment. The lithium cell used in this device may explode resulting in a fire or chemical burn if mistreated. Do not recharge, disassemble, heat above 212°F (100° C), or incinerate. Never use metallic tweezers to hold the cell, and never short circuit the + and – sides of the battery.

Set (or Correct) the Time and Date

1. Install the lithium cell *as described above*.
 2. Attach a power supply to the camcorder. Press and hold the small button on *POWER* while you slide it to *CAM*. Place *ON/POWER SAVE* in *ON*.
 3. Use a straightened paper clip or pen to press and hold *ADJ.* (adjust) for about one second. The reset date (1. 1. 1994) and time (AM 12:00:00) will appear in the viewfinder.
 4. The month will flash. Repeatedly press *DATE* until the correct month appears.
 5. Then, press *ADJ.* The flashing cursor will move to the next part of the display.
 6. Repeat steps 4 and 5 until you have entered the correct month, day, year, hour including *AM* or *PM*, and minutes.
 7. After setting the minutes, press *ADJ.* to start the seconds. The seconds counter will start with “00”.
- To correct the date or time after the clock has been started, repeat steps 3-7.

Record the Time and Date

Whenever the date or time and date display appears in the viewfinder, it will be recorded on the tape. Press *DATE* to display and remove the time and date.

Press <i>DATE</i> Button	To Display in Viewfinder and Record on the Tape
Press Once	Date Only
Press Again	Date and Time
Press Again	Neither Date nor Time

Viewfinder

The camcorder's viewfinder is a miniature color LCD monitor that displays the picture seen by the camcorder. The viewfinder can also be used for viewing the tape during playback.

Caution: When carrying the camcorder with the shoulder strap, rotate the viewfinder down. This helps prevent possible damage to the viewfinder from bumping against your body as you move.

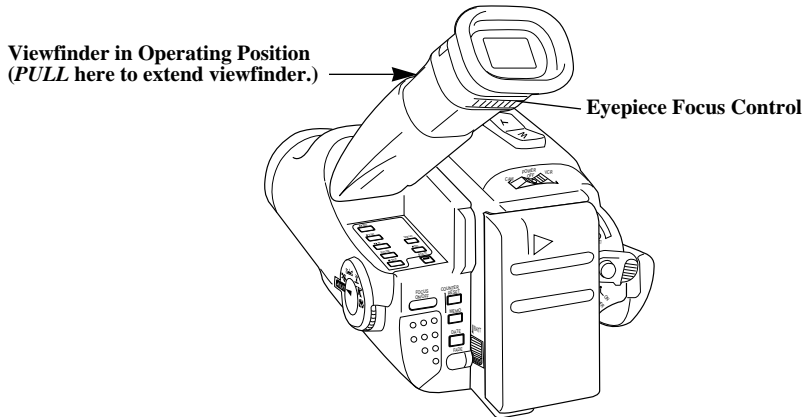

Eyepiece Focus Control

The eyepiece focus control lets you set the focus of the viewfinder for your personal vision. If you wear eyeglasses, you can probably operate the camcorder without them.

The eyepiece focus control does not affect the focus of the picture actually recorded by the camcorder.

1. Pull the viewfinder out into operating position.
2. Turn the eyepiece focus control until you clearly focus on one of the viewfinder displays (such as the time counter).

Tilt Adjustment

For convenient viewing, the viewfinder can be raised approximately 75°.

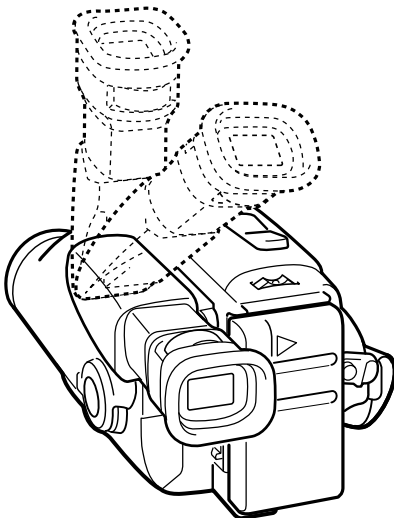

Caution: Do not force the viewfinder to rotate completely around. This will damage the viewfinder and/or the camcorder.

Displays in Viewfinder

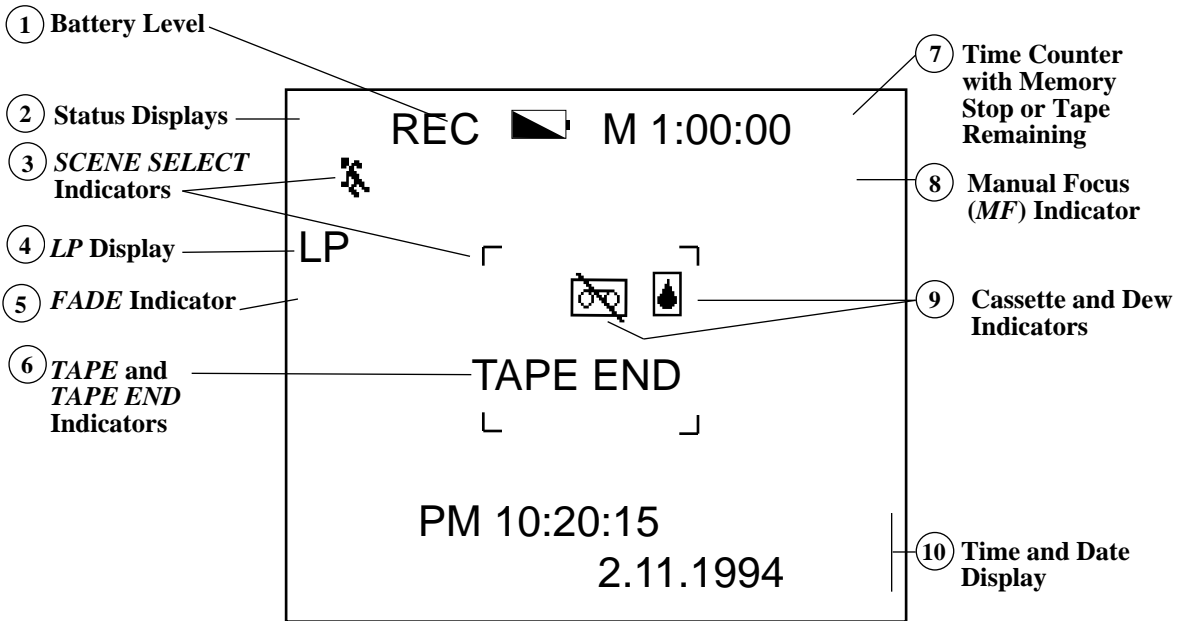

Displays in Viewfinder

1 Battery Level Indicator

- The battery level indicator displays the amount of power left in the rechargeable battery. It flashes when the battery is almost empty.
- This indicator is not recorded on the tape.

2 Status Displays

- *REC* appears when the camcorder is recording.
- *PAUSE* flashes when the camcorder is in record pause.
- *FF* appears when the tape is fast forwarding, and *REW* appears when the tape is rewinding.
- *STOP* appears when the camcorder is stopped during playback.
- *PLAY* appears when the camcorder is playing back a tape.
- A larger *REC* or *PAUSE* briefly appears below the status display area when you

start or stop recording to let you know that the *SCENE SELECT* control is set to *AUTO*.

- These displays are not recorded on the tape.

3 SCENE SELECT Indicators

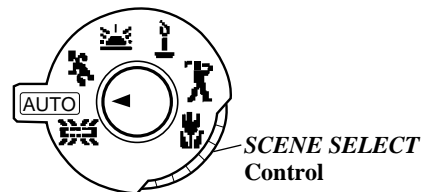

- Turn the preset program control to select one of the preset program modes.
- The indicator for the mode selected will appear in the viewfinder. No indicator appears when *AUTO* is selected.
- The indicator is not recorded on the tape.
- *Details are on page 31.*

(continued on next page)

Displays in Viewfinder (continued)

4 LP Indicator

LP appears when you play back a tape recorded in LP speed.

5 FADE Indicator

- *FADE* appears when you turn on the fading feature.
- *FADE* flashes while the camcorder is fading in or out.

6 TAPE and TAPE END Indicators

- *TAPE* appears when approximately five minutes of recording time is left on the tape.
- *TAPE END* appears when the end of the tape is reached during recording.

7 Time Counter with Memory Stop or Tape Time Remaining Display

The time counter appears here during recording or playback.

- Press *COUNTER RESET* to reset the counter to “0:00:00” when you start recording or playing back a tape.

POWER set to VCR:

- Press *COUNTER MEM* (memory) to turn the time counter’s memory stop feature on or off.

An *M* appears in front of the time counter when memory stop is on.



POWER set to CAM:

- During recording, press *COUNTER MEM* (memory) to change the time counter display to the tape time remaining display. After a few seconds, the display returns to the time counter.
- These displays are not recorded when they appear.
- *Details are on page 33.*

8 Manual Focus Indicators

- Press *FOCUS ON/OFF* to turn off auto focus and focus manually. The *MF* indicator will appear in the viewfinder during manual focus.
- Press *FOCUS ON/OFF* again to return to auto focus. No indicator appears when using auto focus.
- This display is not recorded when it appears.

9 Dew and Cassette Indicators

- The dew indicator appears when excessive moisture is in the camcorder or cassette. The camcorder’s buttons will not operate except to eject the cassette. Press *EJECT* and remove the cassette from the camcorder. Place the camcorder in a warm, dry area until the  indicator disappears (approximately one hour). When it disappears, the camcorder will operate.
-  appears if there is no cassette in the camcorder or if you try to record on a cassette that has its safety tab closed.
-  may appear if there is moisture in the camcorder or cassette.

10 Time and Date Display

- Press *DATE* to display or remove the date or time and date from the viewfinder after they are set. *POWER* switch must be in *CAM*.
- This display will be recorded on the tape whenever it appears.
- “88:88” appears if the time and date have not been set or when the clock battery is not installed correctly or needs replacing.
- *Details are on page 24.*

Special Features

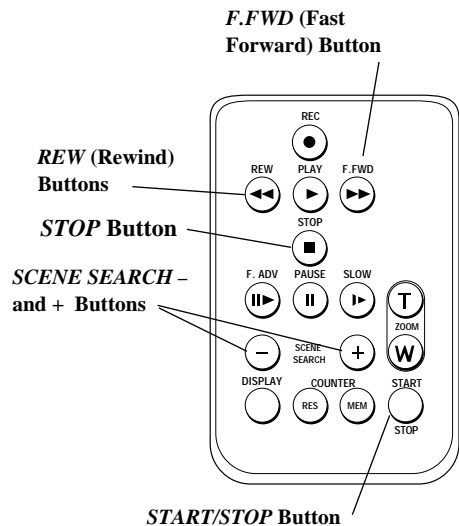
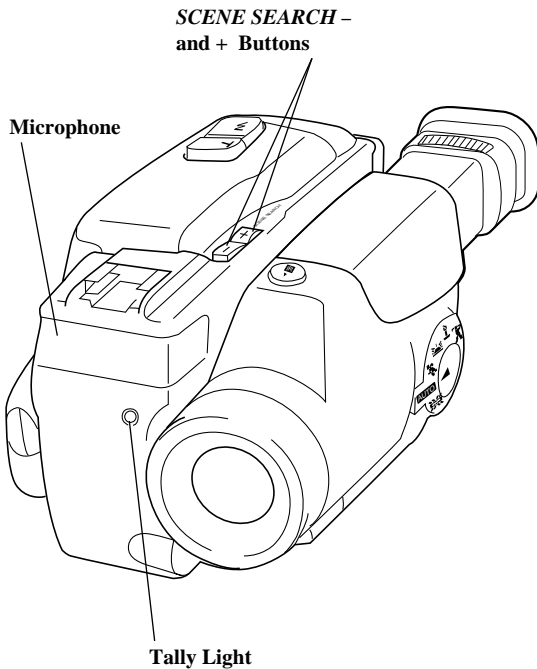

Quick Review

When the camcorder is in record pause, press and release *SCENE SEARCH -* to review the last few seconds of recorded material. The camcorder will return to record pause.

Note: Do not hold *SCENE SEARCH -*, or the camcorder will go into camera edit.

Camera Edit

This feature lets you position the tape while the camcorder is in record pause.

- Press and hold *SCENE SEARCH -* to visually search the recorded tape in reverse.
- Press and hold *SCENE SEARCH +* to visually search forward on the recorded tape.

Release the button to have the camcorder return to record pause at that point on the tape.

Microphone

The microphone picks up the sound during a recording. It is more sensitive to sounds coming from the direction the lens is pointed.

Tally Light

The tally light flashes when the camcorder is in record pause.

- The tally light will turn off if you start recording with the thumb trigger on the camcorder or place *ON/POWER SAVE* in *POWER SAVE*.
- The tally light will light continuously if you start recording with *START/STOP* on the remote.

Automatic Head Cleaner

The camcorder has an automatic head cleaning system. Whenever a cassette is inserted or removed, head cleaning is activated. This system minimizes the need for accessory cleaners or cleaning by a Servicer.

Special Features (continued)

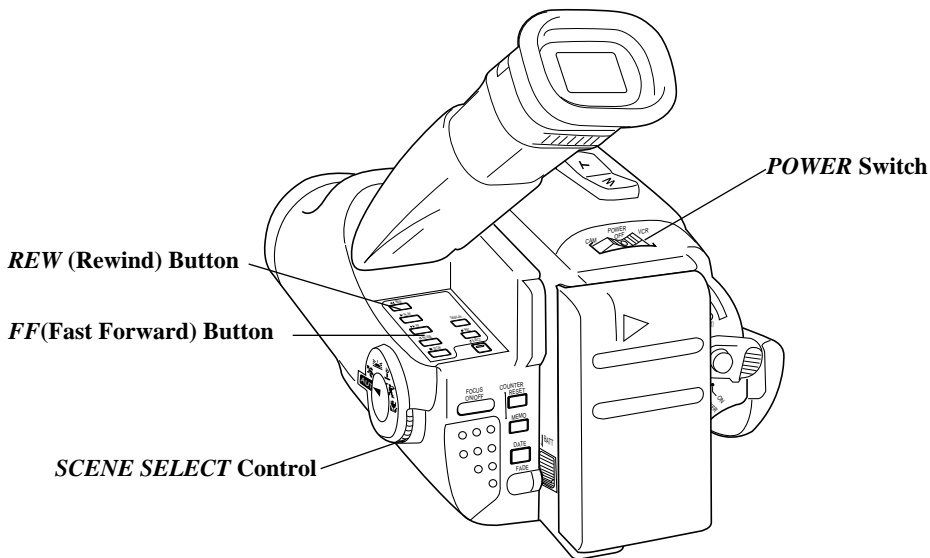

Auto Mode

Place the *SCENE SELECT* control to *AUTO* to have the camcorder control focus and set the shutter speed to 1/60 second.

When you begin recording, the *REC* and *PAUSE* indicators appear briefly in the viewfinder twice their normal size.

Tape Positioning

Place *POWER* in *VCR*, and make sure the camcorder is stopped.

- Press *FF* (fast forward) on camcorder or *F.FWD* on remote to fast forward the tape.
- Press *REW* (rewind) to rewind the tape.
- Press and hold *FF* (fast forward) on camcorder or *F.FWD* on remote (or *REW*) during tape positioning to visually search the tape. Release the button to return to fast forward or rewind operation.
- Press *STOP* to stop fast forward or rewind.

MIC (Microphone) Jack

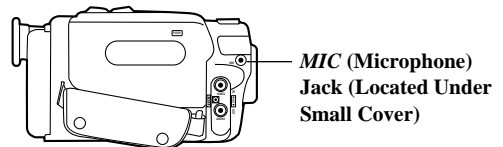

Plug an optional external microphone into the *MIC* jack located behind the *AV TERMINAL* cover. When a microphone is plugged into this jack, the camcorder's microphone is automatically turned off.

Flying Erase Head

A separate erase head is mounted on the spinning headwheel (hence the term "flying"). This allows you to make clean edits without the "glitches" or "rainbow noise" that may occur at the beginning and end of each recording.

Focusing Your Camcorder

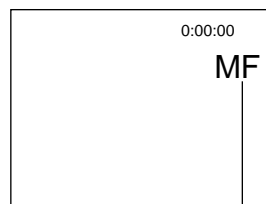
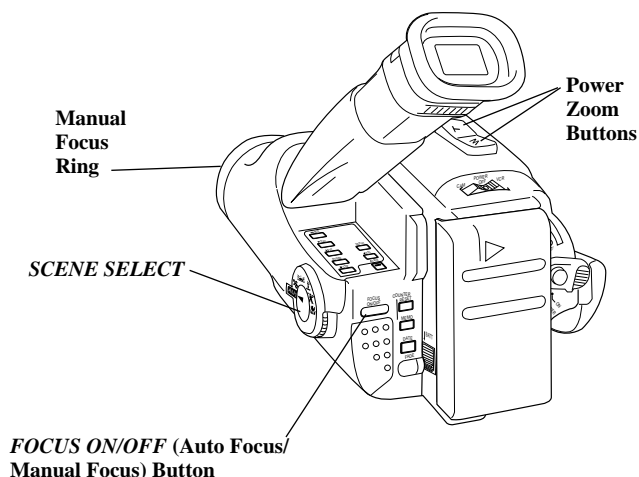

Manual Focus Display
in Viewfinder

Auto Focus

If you want the camcorder to focus for you automatically, set the *SCENE SELECT* control to *AUTO*.

The camcorder will automatically focus on any subject three feet or more from the lens. For a subject closer than three feet, press “W” to change to wide angle where the subject will be in focus.

Manual Focus

Certain conditions require manual focusing.

- When taping two subjects – one near and one distant.
- When taping subjects in very low light.
- When taping a horizontally striped subject.
- When taping subjects with little or no contrast.

To focus manually.

1. Press *FOCUS ON/OFF* (auto focus/manual focus) to select manual focus. *MF* will appear in the viewfinder.
2. Press power zoom button “T” and zoom in on the subject.
3. Turn the focus ring to adjust the focus.
4. Use the power zoom buttons to select desired zooming range.

Note: When the *POWER* switch is *OFF*, focus will reset to auto when power is restored. Manual focus will remain selected when you place *ON/POWER SAVE* in *POWER SAVE* and then restore power by placing it *ON*.

SCENE SELECT Modes

The camcorder has several *SCENE SELECT* modes for particular recording situations. It will automatically set shutter speed, white balance, and iris. Manual or auto focus can be used during any of these modes.

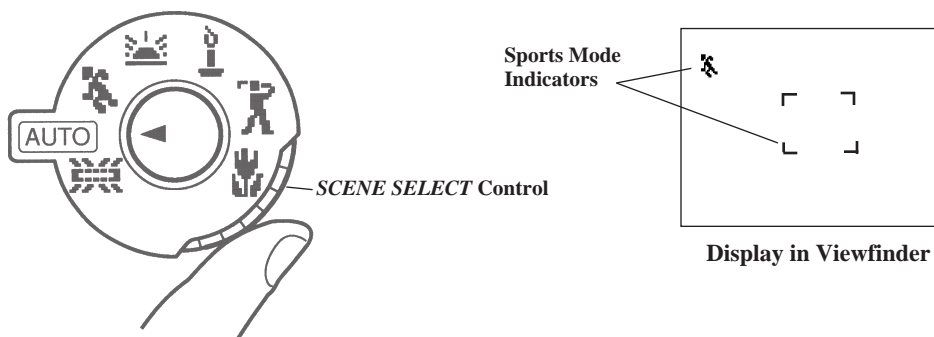

To select a *SCENE SELECT* mode

1. Place the camcorder in record pause.
2. Turn the *SCENE SELECT* control to align the arrow with the mode that best fits the recording conditions. See the chart below to decide which mode to use.

Note: Auto focus will automatically reset whenever you select a new *SCENE SELECT* mode.

Mode	Shutter Speed	Indicator	Auto-Focus Area	Recording Conditions
Flickerless	1/100 second		Normal	When recording in a foreign country under fluorescent lighting that uses 50 Hz. electric current (some parts of Europe and Asia).
AUTO mode	1/60 second.	None	Normal	Use under normal conditions.
Sports	1/60 ~ 1/250 second. (depending on brightness)		Center Frame Area Only (9 feet and farther)	For filming sporting events, football games, etc. • Colors may change if this mode is used indoors with fluorescent lighting.
Twilight	1/60 second		Normal	For capturing the colors of sunrises and sunsets.
Low Light	1/60 second		Normal	For best results indoors – low light conditions. • If the camcorder makes too many focus adjustments, this may indicate that the subject is too bright. In this case, select the <i>AUTO</i> mode or use manual focus.
Auto high speed shutter	1/250 ~ 1/10,000 second (depending on brightness)		Normal	For capturing fast movements such as a golf swing, tennis swing, etc. • Colors may change if this mode is used indoors with fluorescent lighting.
Close-up	1/60 second		2/5 inch~78 inches	For filming subjects, such as flowers or insects, at a short distance. • This mode automatically sets the zoom to the wide-angle position and focus to about 2 inches from the lens. The focus can then be adjusted on any subject in a range of 2/5 inch to 78 inches from the lens.

Zooming and Fading

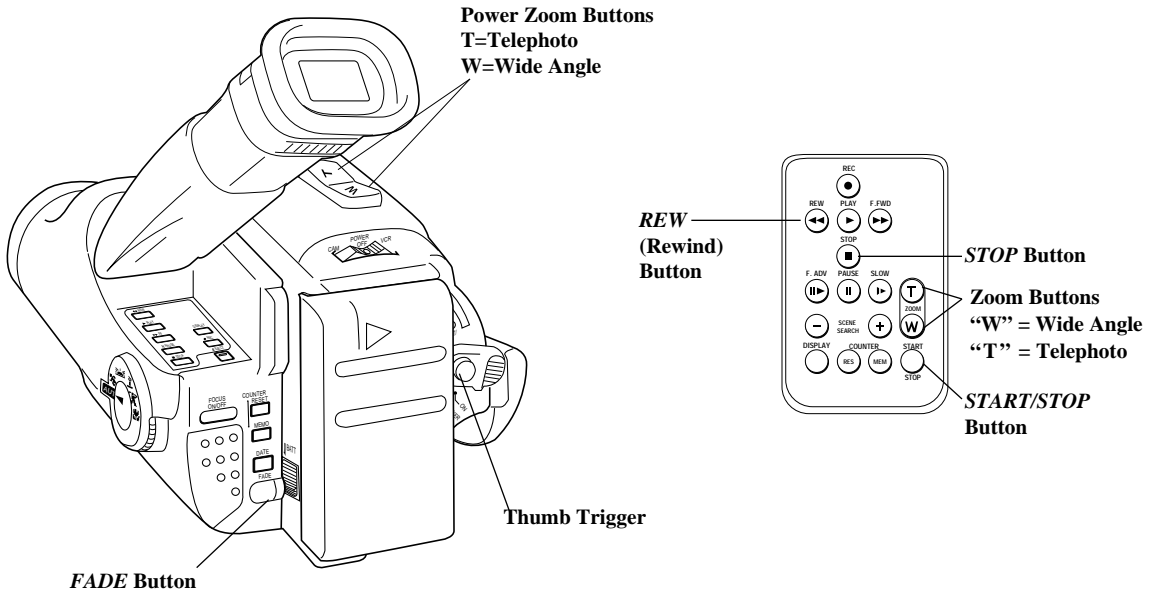

Power Zooming

The motorized zoom lens allows you to zoom in and out for close ups or wide angle shots by pressing one of the power zoom buttons.

- Press the button labeled “T” to move the lens in the telephoto (close-up) direction.
- Press the button labeled “W” to move the lens in the wide-angle direction.

Notes: Image vibration is more noticeable when zooming in to film close-up shots. If possible use a tripod or make sure the camcorder is kept steady.

When you place the *ON/POWER SAVE* lever in *POWER SAVE* and then back in *ON*, the zoom ratio will remain the same as before you put it in *POWER SAVE*.

Fading in and Out

Add a professional touch to your recordings. Both the picture and sound will gradually appear or disappear. The speed of the fade is automatically controlled by the camcorder.

Fading in

1. Place the camcorder in record pause.
2. Press *FADE*. *FADE* appears in the viewfinder.
3. Press the thumb trigger (*START/STOP* on remote) to start recording. *FADE* will flash in the viewfinder and the picture and sound will gradually fade in.

Fading Out

1. During recording, press *FADE*. *FADE* appears in the viewfinder.
2. Press the thumb trigger (*START/STOP* on remote) to stop recording. *FADE* and *PAUSE* will flash in the viewfinder and the picture and sound will gradually fade out.

To Cancel *FADE*

Press *FADE* again to cancel fading. *FADE* will disappear from the viewfinder.

Time Counter with Memory Stop

Time Counter

The time counter display shows the actual time elapsed when recording or playing back a tape. The time counter quickly locates the end of recorded segments. Note the reading when you are finished recording or playing back a tape. Before you start to record or playback a tape, press the *COUNTER RESET* button to set the counter to "0:00:00".

For example, you recorded a 10-minute segment. Later, you want to locate the end of your recording. Insert the cassette and fast-forward the tape until the time counter reads "0:10:00".

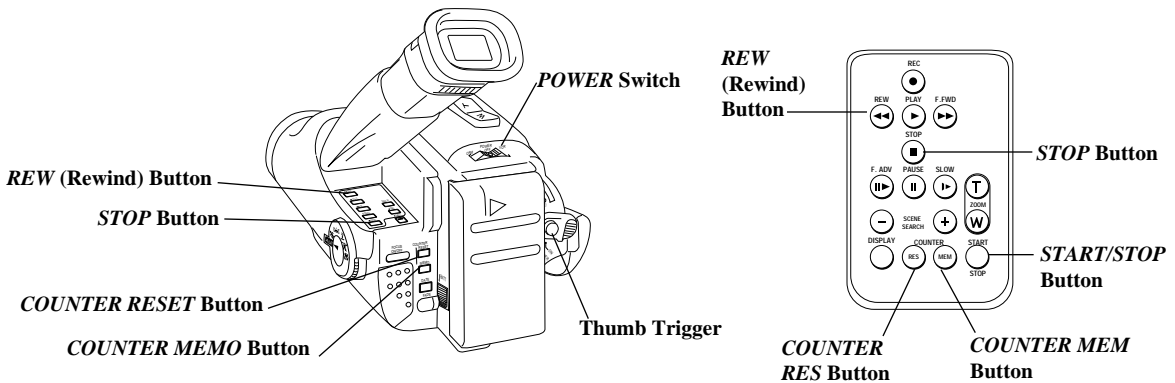

Memory-Stop Feature

The memory-stop feature helps you locate a certain point on the tape during playback. When memory stop is turned on, the tape will stop automatically during rewind or fast forward when the time counter reaches "M 0:00:00".

1. Press and hold the small button on *POWER* while you place it in *VCR*.
2. Press *COUNTER MEMO* (memory) to turn on memory stop. An "M" appears in front of the time counter.

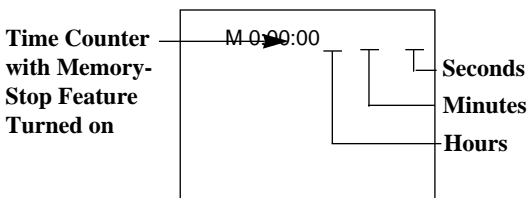

3. Locate the place on the tape you want to return to and press *COUNTER RESET* (*COUNTER RES* on remote) to set the time counter to "M 0:00:00".
4. Continue to play the tape. When you want to return to the place you marked, press *STOP*.
5. Press *REW* (rewind). The tape will rewind to the time counter reading of "M 0:00:00".

Note: If you rewind the tape farther back than "0:00:00", a minus will appear in front of the counter.

Tape Remaining Display

The tape remaining display tells you how much recording time you have left on the tape.

1. Press and hold the small button on *POWER* while you place it in *CAM*. Press the thumb trigger (*START/STOP* on remote) to start recording.
2. Press *COUNTER MEMO* to change the time counter to the tape remaining display. After a few seconds the arrows appear to indicate the amount of tape remaining on the cassette in the camcorder.

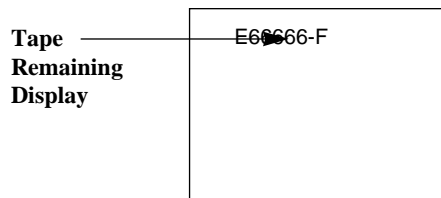

3. After a few seconds the tape remaining display will switch to the time counter again.

Notes: Once tape remaining has been calculated, it can be displayed quickly by pressing *COUNTER MEMO*. The tape remaining display only operates during recording.

Ejecting the cassette or placing *POWER* in *OFF* or *VCR* cancels tape remaining.

Recording from a TV or VCR

To record on your camcorder from a TV or VCR having *AUDIO/VIDEO OUT* jacks, use the audio/video cable that came packed with the camcorder.

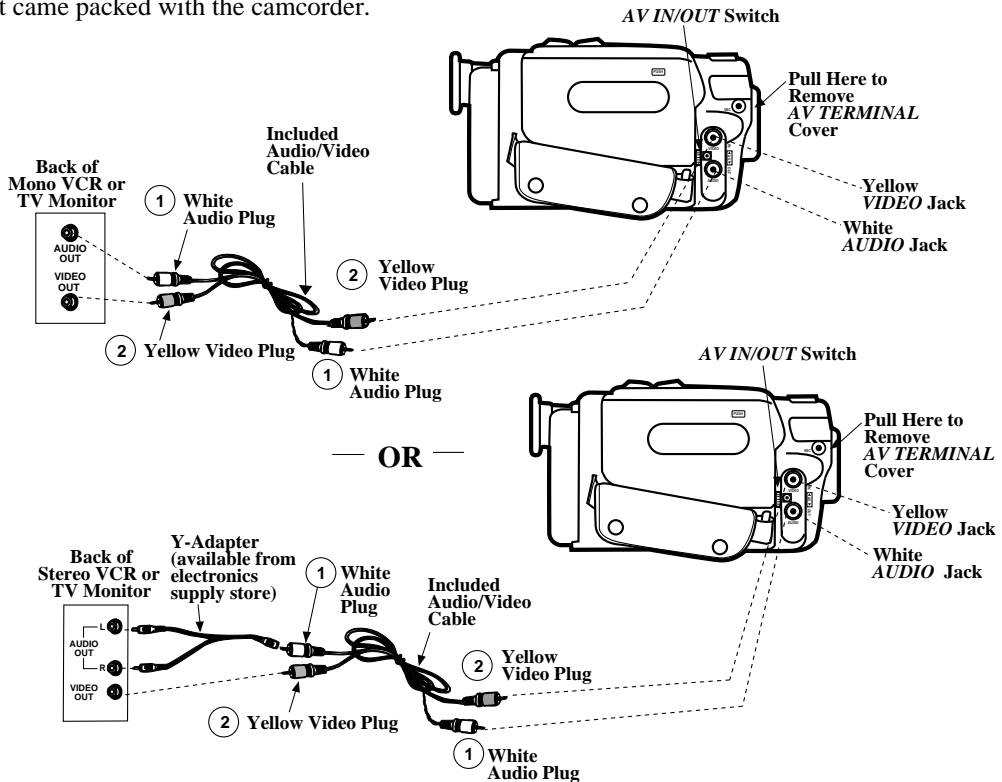

Installation

1. Attach the white plug on one end of the included audio/video cable to the *AUDIO OUT* jack on the TV or VCR and the other white plug to the white *AUDIO* jack located under the *AV TERMINAL* cover on the side of the camcorder.
2. Attach the yellow video plug on one end of the included audio/video cable to the *VIDEO OUT* jack on the TV or VCR and the other yellow plug to the yellow *VIDEO* jack located under the *AV TERMINAL* cover on the side of the camcorder.

Note: If your TV or VCR has stereo *AUDIO* jacks, attach the *AUDIO* plug to the one labeled *MONO*. If one is not labeled *MONO*, you may need a Y-adapter to hear sound from both channels.

Caution: The unauthorized recording of television programs and other recorded material may infringe the rights of others.

Operation

1. A. Camcorder connected directly to TV monitor: Turn on the TV and tune it to the channel you want to record.
B. Camcorder connected to VCR that is already connected to TV: Turn on VCR and tune it to the channel you want to record (or place the cassette you want to copy in the VCR).
Note: If you want to see what is being recorded, turn on the TV and tune it to the channel that you normally use to see the signal from the VCR.
2. Place the camcorder's *AV IN/OUT* switch to *IN*.
3. Attach a power supply and slide the camcorder's *POWER* switch to *VCR*. Insert a blank cassette with the safety tab intact.
4. Press the small red *REC* (record) button located under the viewfinder on the camcorder (*REC* on remote) to begin recording.
If you are copying a tape, press *PLAY* on the VCR when you are ready to start copying.
5. Press *STOP* when you are finished.

Viewfinder Playback and Playback Features

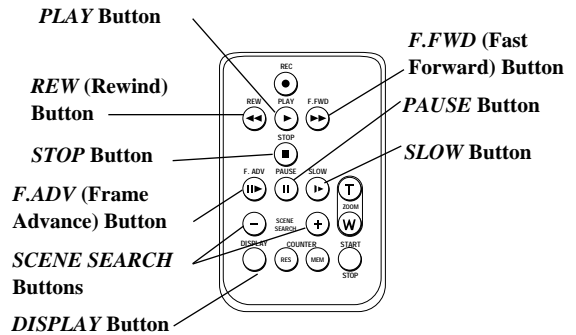
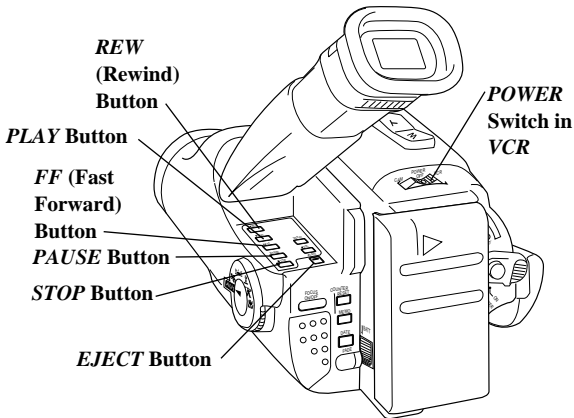

Viewfinder Playback

Viewfinder playback lets you watch tapes in the viewfinder.

1. Slide *POWER* to *VCR*.
2. Insert the cassette you want to play back.
3. Press *PLAY*.
4. Press *STOP* when you are finished.

Playback Features

Stop-Action Pause

- During playback, press *PAUSE* to “stop the action” and view one frame of the tape.

Caution: Pause is designed for momentary interruptions and should not be used for an extended period of time. If the camcorder remains in the pause mode for more than five minutes, it will automatically move the tape away from the spinning heads to prevent excessive tape wear.

- During stop-action pause, press *REW* or *FF* (*F.FWD* on remote) to visually search the picture. Release the button to return to stop-action pause.
- Press *PAUSE* again (or *PLAY*) to return to normal playback.

Frame Advance

- During playback, press *PAUSE* to “stop the action” and view one frame of the tape. Press *F.ADV* (frame advance) on the remote to advance the tape one frame at a time.
- Press *PAUSE* (or *PLAY*) to return to normal playback.

Notes: During pause and search operations, it is normal for streaks to appear in the picture. The sound is muted during special playback operations.

Slow-Motion Playback

- During playback or stop-action pause, press *SLOW* on the remote to start slow-motion playback.
- Press *PLAY* to return to normal playback or *PAUSE* to return to stop-action pause.
- If noise bars appear during slow-motion playback, repeatedly press one of the *SCENE SEARCH* buttons.

Visual Searching

- During playback, press and hold *F.FWD* (fast forward) or *REW* (rewind) if you want to visually search the tape in forward or reverse.
- Release the button to return to normal playback.

See Viewfinder's Displays on TV.

- Press *DISPLAY* on the remote to see the viewfinder displays on the TV screen.
- Press *DISPLAY* again to remove the displays.

Playback on TV or VCR Using *AUDIO/VIDEO IN* Jacks

To connect your camcorder to a TV or VCR using *AUDIO/VIDEO IN* jacks, use the audio/video cable that came packed with the camcorder. If your TV is already connected to a VCR, you can attach the camcorder to the VCR and watch what the camcorder is recording or playing on the TV.

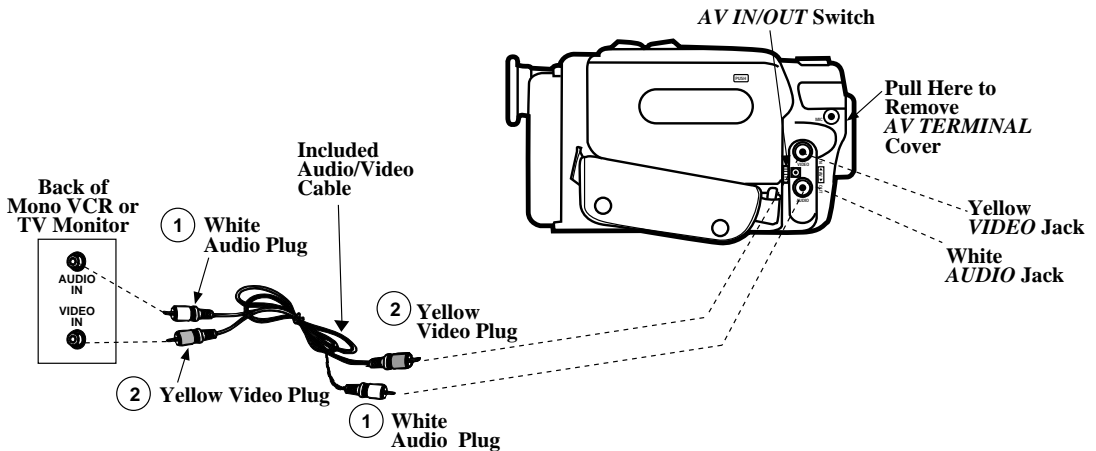

— OR —

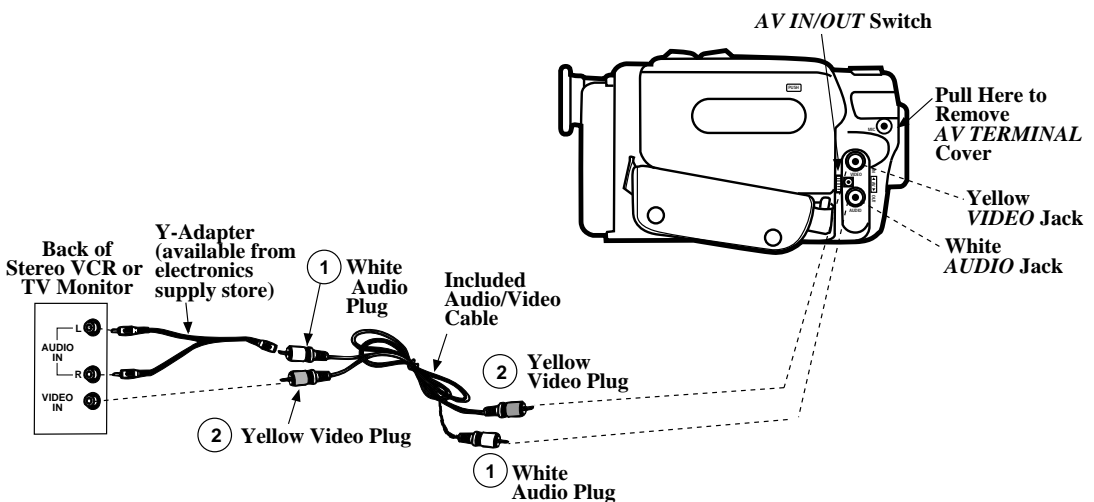

Playback on TV or VCR (continued)

Installation

- ① Attach the white plug on one end of the included audio/video cable to the *AUDIO IN* jack on the TV or VCR and the other white plug to the white *AUDIO* jack located under the *AV TERMINAL* cover on the side of the camcorder.
Note: If your TV or VCR has stereo *AUDIO* jacks, attach the *AUDIO* plug to the one labeled *MONO*. If one is not labeled *MONO*, you may need a Y-adaptor to hear sound from both channels.
- ② Attach the yellow video plug on one end of the included audio/video cable to the *VIDEO IN* jack on the TV or VCR and the other yellow plug to the yellow *VIDEO* jack located under the *AV TERMINAL* cover on the side of the camcorder.

Playback Operation and How to Copy Tapes on the VCR

1. A. Camcorder connected directly to TV monitor:
Turn on the TV and tune it to the video input channel.
B. Camcorder connected to VCR that is already connected to TV: Turn on VCR and place it in the “line” or “camera mode”. (If your VCR does not have a “line” or “camera mode”, consult the VCR owner’s manual.) Operate the TV as you normally do to see the signal coming from the VCR.
2. Place *AV IN/OUT* switch in *OUT*.
3. Attach a power supply, and press and hold the small button on the camcorder’s *POWER* switch while you place it in *VCR*. Insert the cassette you want to playback.
4. Press *PLAY* to begin playback.
During playback, use the features on page 35.
5. Press *STOP* when you are finished.

Notes: The corresponding buttons on the remote control will operate the camcorder.

Caution: The unauthorized recording of television programs and other recorded material may infringe the rights of others.

Viewing What the Camcorder is Seeing (or Recording)

1. A. Camcorder connected directly to TV: Turn on the TV, and tune it to the video input channel.
B. Camcorder connected to VCR that is already connected to TV: Turn on VCR and place it in the “line” or “camera mode”. (If your VCR does not have a “line” or “camera mode”, consult the VCR owner’s manual.) Operate the TV as you normally do to see the signal coming from the VCR.
2. Attach a power supply, and press and hold the small button on the camcorder’s *POWER* switch while you place it in *CAM*. Place *ON/POWER* *SAVE* in *ON*, and insert the cassette you want to record on.
Note: When the camcorder is used as a camera, turn the TV’s volume down to prevent a high-pitched squeal caused by feedback.
3. Place *AV IN/OUT* switch in *OUT*.
4. Press the camcorder’s thumb trigger (*START/STOP* on remote) to begin recording. You can watch what the camcorder is seeing (or recording) on the TV screen.

Playback on a TV without Audio/Video Inputs

To connect your camcorder to a TV without audio and video inputs, you need an optional CRF800 RF output adapter and an optional coaxial RF cable.

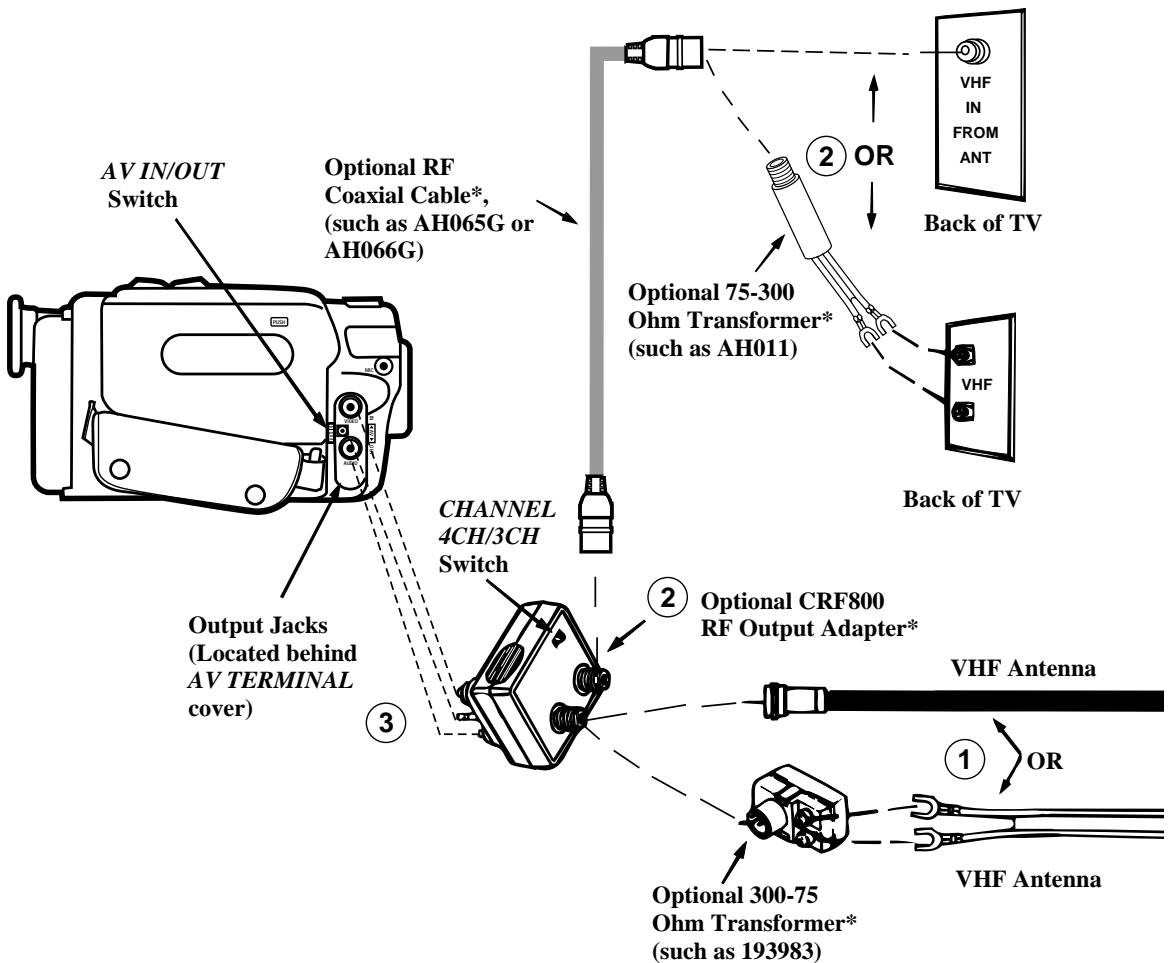

*Optional accessories are available from your dealer or electronics supply store. *Mail order form is on page 7.*

Playback on a TV without Audio/Video Inputs (continued)

Installation

- ① Disconnect the VHF antenna from your TV. Connect the antenna to the *VHF IN* connector on the RF output adapter if you leave the adapter connected to the TV.
Note: If your VHF antenna is the flat twin-lead type attached by two screws, you will need an optional 300-75 ohm transformer, such as 193983.
- ② Attach one end of the coaxial RF cable to the *VHF OUT* connector on the RF output adapter and the other end to the VHF input on your TV.
- ③ Attach the RF output adapter's plug to the output jacks located behind the *AV TERMINAL* cover on the side of the camcorder.

Playback Operation

1. Set *CHANNEL 4CH/3CH* on the RF output adapter to *4CH* or *3CH*.
2. Turn on the TV, and tune it to channel 3 or 4 – the same channel you selected with *4CH/3CH*.
3. Attach a power supply, and press and hold the small button on the camcorder's *POWER* switch while you place it in *VCR*. Insert the cassette you want to play back.
4. Place *AV IN/OUT* switch in *OUT*.
5. Press *PLAY* to begin playback.
During playback, use the features on page 35.
6. Press *STOP* when you are finished.

Note: The corresponding buttons on the remote control will operate the camcorder.

Viewing What the Camcorder Is Recording

1. Turn on the TV and tune it to channel 3 or 4.
Note: When the camcorder is used as a camera, turn the TV's volume down to prevent a high-pitched squeal caused by feedback.
2. Set *4CH/3CH* on the RF output adapter to the same channel you selected on the TV.
3. Attach a power supply and press and hold the small button on the camcorder's *POWER* switch while you place it in *CAM*. Insert the cassette you want to record on. Make sure the *ON/POWER SAVE* lever is *ON*.
4. Place the *IN/OUT* switch in *OUT*.
5. Press thumb trigger on the camcorder (*START/STOP* on remote) to start recording. You can watch what you are recording on the TV screen.

Normal TV Viewing

You can leave the RF output adapter hooked up to the TV. Disconnect the adapter's plug from the camcorder or turn off the camcorder's power.

Care and Maintenance

Camcorder Care and Storage

- Keep dust and grit from entering the camcorder's cassette door. They are abrasive and cause excessive wear both to the camcorder's recording/playback heads and cassettes.
- Always replace the lens cap on the lens when the camcorder is not in use.
- When the camcorder is not in use, always remove the cassette and AC adapter/charger or battery.
- The camcorder can be damaged by improper storage or handling. Do not subject the camcorder to swinging, shaking, or dropping.
- Do not touch the lens with your fingers. The oil from your skin can damage the lens. Always use lens-cleaning tissue and commercially prepared cleaning solution designed for use on camera lens. Improper cleaning may scratch the lens.
- Before handling your camcorder, make sure your hands and face are free from any chemical products such as suntan lotion, as it may damage the finish.
- Do not operate the camcorder for extended periods in temperatures below 40°F (4°C) or above 95°F (35°C). Do not store the camcorder in temperatures below -22°F (-30°C) or above 149°F (65°C).
- Do not operate the camcorder in extremely humid environments.
- Do not aim your camcorder at the sun or other bright objects.
- Do not leave your camcorder in direct sunlight. Doing so could permanently damage the camcorder's internal parts.

Rechargeable Battery Care and Storage

- Do not operate the battery at temperatures below 14°F (-10°C) or above 95°F (35°C). The battery may be damaged if operated at temperatures above 122°F (50°C). Operation time will decrease at extremely low temperatures.
- Store the battery at normal room temperature.
- The battery should be charged at a temperature of 41°F-95°F (5°C-35°C) to prevent damage.
- After repeated chargings and use, the operation time will gradually decrease. When operation time becomes too short to be useful, it is time to replace the battery.

Cassette Care and Storage

- When you are finished with a cassette, rewind it, remove it from the camcorder, and label it.
- Do not touch or cover the small holes in the cassette or use cassettes with damaged or spliced tape.
- Store cassettes vertically in their protective boxes at normal room temperatures. Excessive heat or cold may damage your cassettes.
- Keep the cassette away from strong magnetic fields such as electric motors and other devices.
- Do not use a cassette if it has been damaged or exposed to moisture.
- Close the safety tab to prevent accidental erasure.

Care and Maintenance

Cleaning the Camcorder

To clean the camcorder's exterior, remove any power source connected to the camcorder and gently wipe it with a clean soft cloth.

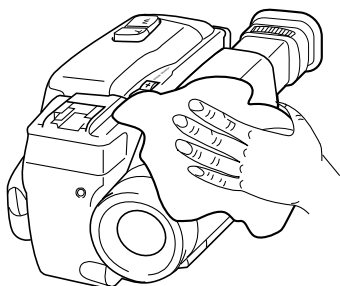

Caution: Use of strong cleaning products, such as those containing alcohol or benzene, may damage the camcorder.

Cleaning the Camcorder's Lens

To clean the camcorder's lens, blow it with a blower brush, and then gently wipe the lens with cleaning tissue and commercially prepared cleaning solution designed for use on camera lens. Improper cleaning may scratch the lens.

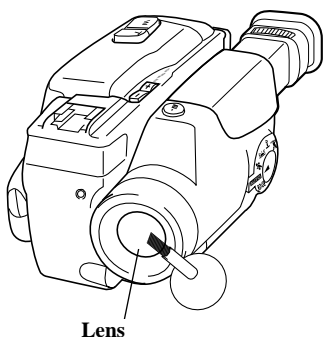

Caution: Do not touch the lens with your fingers. The oil from your skin can damage the lens.

Cleaning the Camcorder's Viewfinder

To clean the viewfinder, follow the steps below.

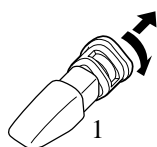

1. Turn the eyepiece counter clockwise and remove.

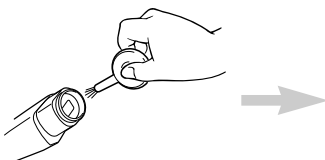

2. Use an optional air blower, available from most camera stores, to clean the viewfinder.

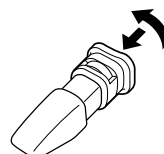

3. Replace the eyepiece.

Trouble Checks

Troubles sometimes are caused by simple “faults” that you can easily correct without the help of a service technician by first checking a few basic remedies.

Before you call or take your camcorder to an Authorized RCA Camcorder Servicenter, look below for the type of trouble you are experiencing. Then perform the simple checks and adjustments listed for that trouble.

If service should be necessary, the warranty information lists what your warranty covers and explains how to get service.

Trouble	Checks and Adjustments
No power	<ul style="list-style-type: none"> • <i>ON/POWER SAVE</i> lever in <i>POWER SAVE</i> position. Place lever in <i>ON</i> position. • If using battery, it may need to be recharged. • If using AC adapter/charger, make sure it is plugged into a working outlet.
Won't record or playback	<ul style="list-style-type: none"> • If using AC adapter/charger, make sure it is plugged into a working outlet. • If dew indicator () appears in the viewfinder, there is moisture in the camcorder. Remove the cassette from the camcorder and let it dry naturally. • There may be no cassette in the camcorder. • Try ejecting and reinserting the cassette. • The cassette tape may be broken, try another cassette. • You may have reached the end of the cassette, try rewinding it.
Won't playback	<ul style="list-style-type: none"> • <i>POWER</i> switch must be in <i>VCR</i> position.
Won't record	<ul style="list-style-type: none"> • Safety tab has been closed. (<i>See page 23.</i>) • <i>POWER</i> switch must be in <i>CAM</i> (camera) position. • <i>ON/POWER SAVE</i> lever must be in <i>ON</i> position.
No picture in viewfinder	<ul style="list-style-type: none"> • Remove lens cap. • <i>ON/POWER SAVE</i> lever must be in <i>ON</i> position when <i>POWER</i> switch is in <i>CAM</i> (camera) position.
Tape stops during rewind or fast forward	<ul style="list-style-type: none"> • Time-counter memory may be on. Whenever an “<i>M</i>” appears with the time-counter display, the camcorder will stop rewinding (or fast forwarding) when counter reads “<i>M 0:00:00</i>”. Press the <i>REW</i> or <i>F.FWD.</i> button again to continue rewinding or fast forwarding, or press <i>COUNTER MEMO</i> (memory) button to turn off memory-stop feature.
Camcorder remains in “stop action” (play-pause) mode	<ul style="list-style-type: none"> • Press <i>PAUSE</i> (or <i>PLAY</i>) to return to normal playback.

Trouble Checks (continued)

Trouble	Checks and Adjustments
Poor auto-focus operation	<ul style="list-style-type: none"> • Make sure <i>SCENE SELECT</i> control is in <i>AUTO</i>. See page 31. • Scene is dark. Auto-focus may not work under this condition. See page 30 for details on manual focus. • Lens is smudged, and image appears unfocused. • Viewfinder eyepiece focus is misadjusted. See page 25.
Picture is too dark or subject too dark.	<ul style="list-style-type: none"> • Select the best <i>SCENE SELECT</i> mode for the recording situation. See page 31.
Viewfinder displays are out of focus	<ul style="list-style-type: none"> • Try adjusting eyepiece focus control. See page 25. • Pull electronic viewfinder out to the extended operating position. • The delicate <i>B</i> and <i>C</i> controls on the side of the viewfinder may need adjustment. Carefully adjust these small controls with a plastic screwdriver.
Date and/time (or date) were recorded on tape	<ul style="list-style-type: none"> • Date and time or date will be recorded on tape whenever they appear in the viewfinder. • Press <i>DATE</i> button to remove them from viewfinder when recording.
Date and/or time are incorrect	<ul style="list-style-type: none"> • Clock cell may need replacing. See page 24. • Date and/or time may need to be set. See page 24.
Remote control will not operate camcorder	<ul style="list-style-type: none"> • Press on remote sensor to expose it and aim arrow on top toward remote. Aim remote at remote sensor on camcorder. See page 17. • Remote must be within 13 feet from the camcorder to operate it. • Remote control cell may need replacing. See page 18. • If <i>POWER</i> switch is in <i>CAM</i>, the <i>ON/POWER SAVE</i> lever must be in <i>ON</i> for camcorder to operate. • <i>POWER</i> switch must be in <i>CAM</i> or <i>VCR</i> for camcorder to operate. • Camcorder's remote control sensor is exposed to direct sunlight or strong artificial light. This may interfere with operation of camcorder by remote.
Camcorder will not record from <i>AUDIO/VIDEO IN</i> jacks.	<ul style="list-style-type: none"> • <i>POWER</i> switch must be in <i>CAM</i>. • If <i>POWER</i> switch is in <i>CAM</i>, the <i>ON/POWER SAVE</i> lever must be in <i>ON</i> for camcorder to operate. • To record from <i>AUDIO/VIDEO IN</i> jacks, <i>AV IN/OUT</i> switch located under <i>AV TERMINAL</i> cover must be in <i>IN</i> position. • To record from <i>AUDIO/VIDEO IN</i> jacks, press <i>REC</i> button under viewfinder on camcorder (or <i>REC</i> button on remote). Thumb trigger and <i>START/STOP</i> button will not operate camcorder.
Camcorder turns off during operation	<ul style="list-style-type: none"> • Camcorder remained in record pause for five minutes. Press thumb trigger or place <i>ON/POWER SAVE</i> lever to <i>POWER SAVE</i> and then to <i>ON</i>. • Battery needs recharging.

Design Specifications

General

Power requirement: 6V/6.5VDC
Power consumption: 6.0 W
Weight: (820g)
Dimensions: (119 x 111 x 210mm)

Video Recorder Section

Format: 8mm
Record/Playback System:
Two video record/playback heads
One flying erase head
Headwheel Cylinder Diameter: 40 mm
Video Signal: EIA Standard NTSC Color

Camera Section

Scanning: 525 Lines/60 Fields/30 Frames
Image Sensor: CCD Imager
Tripod Mount: One 1/4" threaded hole
Lens: f: 1.8 — 12:1 (5.5-66mm)
Diameter: 37 mm

Information to User

This device complies with Part 15 of the FCC Rules. Operation is subject to the following two conditions: (1) This device may not cause harmful interference, and (2) this device must accept any interference received, including interference that may cause undesired operation.

This equipment has been tested and found to comply with the limits for a Class B digital device, pursuant to Part 15 of the FCC Rules. These limits are designed to provide reasonable protection against harmful interference in a residential installation. This equipment generates, uses, and can radiate radio frequency energy and, if not installed and used in accordance with the instructions, may cause harmful interference to radio communications. However, there is no guarantee that interference will not occur in a particular installation. If this equipment does cause harmful interference to radio or television reception, which can be determined by turning the equipment off and on, the user is encouraged to try to correct the interference by one or more of the following measures:

- Reorient or relocate the receiving antenna.
- Increase the separation between the equipment and receiver.

- Connect the equipment into an outlet on a circuit different from that to which the receiver is connected.
- Consult the dealer or an experienced radio/TV technician for help.

Alterations or modifications carried out without appropriate authorization may invalidate the user's FCC right to operate the equipment.

This digital apparatus does not exceed the Class B limits for radio noise emissions from digital apparatus as set out in the interference-causing equipment standard entitled "Digital Apparatus", ICES-003 of the Department of Communications.

Cet appareil numérique respecte les limites de bruits radioélectriques applicables aux appareils numériques de Classe B prescrites dans la norme sur le matériel brouilleur: "Appareils Numériques", NMB-003 édictée par le ministre des Communications.

Consumer Assistance and Service – Pro845 Camcorder

You can reach Thomson at the following number:

1-800-283-6503

(Toll free inside U.S.A.)

Our toll-free camcorder number operates from 8:00 a.m. to 5:00 p.m. CST Monday – Friday.

Thomson provides a toll-free telephone number to help you with any problems you may encounter with your camcorder. Many can be diagnosed over the phone, and if necessary, a replacement unit can be shipped to you. Please have your camcorder model/serial number and date of purchase ready when you call. If your unit is out of warranty, we will quote the cost of an exchange unit to you.

Returning Equipment to Thomson for repair or exchange

If we are unable to resolve your problem over the phone we will gladly service your unit or exchange it for a new or refurbished camcorder. Refer to the limited warranty included in this booklet to learn about your specific rights and responsibilities.

Always consult Thomson and get a Return Authorization number before returning anything.

Obtain a Return Authorization (RA) number from the telephone representative before returning your equipment to avoid delays, accounting errors, or even loss of your unit.

Important Information to customers who ship defective equipment to Thomson Consumer Electronics

The Thomson representative who authorized the return of your equipment will give you an RA number over the phone. They will also provide you with instructions on where and how to return your camcorder. Write the number in large, clear characters on the outside of the box. To avoid confusion and misunderstandings, shipments without an RA number clearly visible on the outside of the box will be returned to you at your expense.

Include a brief note describing the problem and any conversations about the problem you have had with Thomson personnel. Include your name, address

and model/serial number of your camcorder. These numbers are located on the bottom of your unit. If your camcorder is within the warranty period, please provide a copy of the bill of sale to verify purchase date. Use the original box and packing material to protect the equipment from damage in shipment. ***For your protection, insure all shipments for full replacement value and use a reliable shipper.*** Thomson assumes no responsibility for warranty shipments from the customer to the factory if not shipped in the manner prescribed by Thomson.

Limited Warranty – Pro845 Camcorder

What your warranty covers:

- Any defect in materials or workmanship.

For how long after your purchase:

- 90 days for labor charges.
- One year for parts.

What we will do:

During the initial 90 days

- Exchange your camcorder with a new, or at our option, refurbished unit at no cost to you.

After the 90 days and within one year

- Exchange your camcorder with a new, or at our option, refurbished unit and bill you a flat exchange charge which covers the labor cost for the repair.

How you get service:

- Call 1-800-283-6503 and have your unit's date of purchase and model/serial number ready. The model/serial information number is on the bottom of your camcorder.
- A representative will troubleshoot your problem over the phone. If the representative determines that you should receive a replacement unit, you will be provided with a Return Authorization (RA) number and the location of a nearby exchange point if one exists. No returns will be accepted without the RA number.

To receive a replacement camcorder before you return yours:

- If you are located near an exchange point:
 1. We will send a replacement unit to the exchange point next day delivery.
 2. The exchange location will notify you of its arrival.
 3. Take your unit, including all accessories, and your bill of sale which validates date of purchase to the exchange location and you will be provided the new or refurbished unit.
 4. If the repairs were covered by your warranty, you will not be billed.

If you are not located near an exchange point:

1. Provide your Discover, MasterCard or Visa account number and expiration date to your phone representative. This is for security purposes. If we receive your unit including all accessories within 14 days from the date you were provided a Return Authorization number, only items not covered by warranty will be charged to your account. **IF YOUR UNIT INCLUDING ALL ACCESSORIES IS NOT RECEIVED WITHIN 14 DAYS, THE SUGGESTED RETAIL VALUE OF THE CAMCORDER AND/OR ACCESSORIES WILL BE CHARGED TO YOUR CREDIT CARD.** This amount will be credited if the unit is subsequently received.
2. We will send you a replacement unit next day delivery.
3. You will receive an invoice packed with the replacement product, but will not be charged for the unit portion of the invoice amount if we receive your unit including all accessories within 14 days from the date you were provided the RA number. Any labor and parts charges not covered by our warranty will be included and charged against your account.
4. Ship the unit back to us along with all accessories included with your camcorder using the replacement unit's carton. Shipping instructions will be included on the carton along with your RA number which will allow you to easily ship the unit back to us. Make sure you insure your shipment in case of damage or loss. Include with the shipment:
 - A copy of your dated bill of sale to verify your unit's warranty eligibility.
 - A brief note describing your camcorder problem.
 - Your name, address and phone number.Return transportation storage, and handling costs, including insurance, are your sole responsibility. We accept no liability in case of damage or loss.

Limited Warranty – Pro845 Camcorder (continued)

To receive a replacement unit after we have received your unit:

1. Write the RA number on the outside of the carton used to return the unit. **Make sure you insure your shipment in case of damage or loss.**
2. Carefully pack the unit along with all accessories included with your camcorder, using the original box and packing material if possible.
3. Include with the shipment:
 - A copy of your dated bill of sale to verify your unit's warranty eligibility.
 - A brief note describing your camcorder problem.
 - Your name, address, and phone number.Return transportation, storage, handling costs, and insurance are your responsibility. We accept no liability in case of damage or loss.
4. Include a cashier's check or money order for payment if there are any out of warranty labor or parts charges which were indicated by the representative, and you elected not to use your credit card.
5. Upon receipt of your product a new or refurbished unit will be shipped to you next day delivery.

What your warranty *does not* cover:

- Adjustment of customer controls.
- Damage from misuse or neglect.
- A unit that has been modified or incorporated into other products or is used for institutional or other commercial purposes.
- Battery for clock and other features.
- Cleaning of video/audio heads.
- Camcorders purchased or serviced outside the U.S.A.
- Return transportation, storage, and handling costs of your unit, including insurance for loss or damage.

Product Registration:

- Please complete and mail the *Product Registration Card* packed with your camcorder. It will make it easier to contact you should it ever be necessary. The return of the card is not required for warranty coverage.

How state law relates to warranty:

- This warranty gives you specific legal rights and you may have other rights that vary from state to state.

If you purchased your camcorder outside the United States:

- See your dealer for details.

Index

- Accessories, Included10
- Accessories, Optional6-9
- Accessory Shoe14
- Accessory, Order Form7-8
- Adapter/Charger, Safety
 - InstructionsInside Front Cover
- Adapter/Charger, Using11,19
- ADJ. (Adjust) Clock Control14,24
- Assistance and Service45
- Attaching the Shoulder Strap11
- AUDIO/VIDEO Jacks15,34,36-37,38-39
- AUTO Mode29,31
- Auto High-Speed Shutter Mode31
- Automatic Head Cleaner28
- AV IN/OUT Switch15,34,36-37,38-39
- AV TERMINAL COVER15,34,36-37,38-39
- BATT (Battery) Eject Lever15,21
- Battery Care and Storage40
- Battery Level Indicator21,26
- Battery Marker Switch20
- Battery Safety Precautions20
- Battery, Clock24
- Battery, Using Rechargeable11,20-21
- Buttons, Remote16-17
- Camcorder Care and Storage40-41
- Camcorder Cleaning41
- Camcorder, Holding4
- Camcorder, Powering19-22
- Camcorder, Turning On13
- Camcorder, Unpacking10
- Camera Edit28
- Car Cord, Optional22
- Care and Maintenance40-41
- Cassette Care and Storage40
- Cassette Compartment Cover15,23
- Cassette Indicator26-27
- Cassettes, Inserting and Removing12,23
- Cell, Replacing Remote18
- Charging the Battery20
- Checking Problems42-43
- Cleaning, Camcorder41
- Cleaning, Lens41
- Cleaning, Viewfinder41
- Clock Cell Compartment14,24
- Clock Cell, Inserting24
- Clock Control ADJ. Button14,24
- Close-Up Mode31
- Consumer Assistance and Service45
- Contents, Table of5
- Controls, Camcorder14-15
- Copying Tapes34,37
- COUNTER MEM (Memory) Button16-17,27,33
- COUNTER MEMO (Memory) Button15,27,33
- COUNTER RES (Reset) Button16-17,27,33
- COUNTER RESET Button15,27,33
- DATE Button15,24,27
- Date and Time Display24,26-27
- Date and Time, Setting24
- DC Car Cord, Optional22
- DC IN 6.5 V Jack11,15,19,22
- DC Power Cord11,19
- Design Specifications44
- Dew Indicator13,26-27
- DISPLAY Button15,16,35
- Displays in Viewfinder26-27
- EJECT Button12,15,23
- Electronic Viewfinder, Adjusting25
- Erase Protection23
- Eyepiece Focus Control13,14,25
- Eyepiece Focus Control, Adjusting25
- F.ADV (Frame Advance) Button16,35
- F.FWD (Fast Forward) Button16-17,28-29,35
- FADE Button15,26-27,32
- Fading32
- FF (Fast Forward) Button15,29,35
- FF (Fast Forward) Display26
- First-Time Operation10-15
- Flickerless Mode31
- Flying Erase Head29
- FOCUS ON/OFF Button15,30
- Focus, Auto and Manual30
- Frame Advance35
- Hand Strap12,15
- Hand Strap, Adjusting12
- Important Safeguards2-3
- Important Safety InstructionsInside Front Cover
- Inserting a Cassette12,23
- Inserting and Removing Cassettes23
- Lens14
- Lens Cap, Attaching12
- Lens, Cleaning41
- Limited Warranty46-47
- Low Battery Warning21
- Low Light Mode31
- LP Indicator23,26-27
- Maintenance and Care40-41
- Manual Focus (MF) Indicators26,27,30
- Manual Focus Ring14,30
- Memory Stop Feature33
- Memory Stop Indicator26-27,33
- MF (Manual Focus) Indicator26-27,30
- MIC (Microphone) Jack15,29
- Microphone14,28
- ON/POWER SAVE Lever13,15,24,28,32

Index (continued)

Operation, First-Time	10-15	Setting the Time and Date	24
Optional Accessories	6-9	Shoulder Strap Attachment Rings	11,15
Order Form, Accessory	7-8	Shoulder Strap, Attaching.....	11
<i>PAUSE</i> Button	15,16,35	<i>SLOW</i> Button.....	16-17,35
<i>PAUSE</i> Display.....	26	Slow-Motion Playback	35
Pause, Stop-Action	35	Solving Problems	42-43
<i>PLAY</i> Button.....	14,15,16-17,34,35,37,39	Specifications.....	44
<i>PLAY</i> Display.....	26	Speed, Recording and Playback	23
Playback	35-39	Sports Mode.....	31
Playback Features	35	<i>START/STOP</i> Button	16-17,28,32
Playback on a TV Using Antenna		Status Displays.....	26
Connection.....	38-39	<i>STOP</i> Button.....	14,15,16,28-29,32,33,34,35,37,39
Playback on a TV Using		<i>STOP</i> Display	26
<i>AUDIO/VIDEO IN</i> Jacks.....	36-37	Stop-Action Pause	35
Playback Speeds	23	Table of Contents.....	5
Playback, First	14	Tally Light	13,14,28
Playback, Viewfinder	35	<i>TAPE END</i> Indicator	26-27
Plug Adapter	19	<i>TAPE</i> Indicator.....	26-27
<i>POWER (CAM/OFF/VCR)</i>		Tape Copying.....	34,37
Switch	11,13,14,15,27,29,33	Tape Positioning	29
Powering the Camcorder	19-22	Tape Time Remaining Display.....	26-27,33
Problem Solving.....	42-43	Telephoto (<i>T</i>) Zoom Button	14,16-17,32
Product Registration	Inside Front Cover	Thumb Trigger.....	14,15,32,33
Quick Review	28	Tilt Adjustment.....	25
<i>REC</i> (Record) Button.....	15,16,34	Time and Date Display.....	24,26-27
<i>REC</i> Display	13,26	Time and Date, Recording.....	24
<i>REC START/STOP</i> Button.....	13,15	Time and Date, Setting	24
Recording on the Camcorder	34	Time Counter Display	26-27,33
Recording Speed.....	23	Time Counter with Memory Stop Feature.....	33
Recording Tips.....	4	Tips, Recording.....	4
Recording, First	13	Tips, Traveling.....	4
Refreshing the Battery	20	Tripod Screw Mount.....	14
Registration Card.....	Inside Front Cover	Tripod, Using	9
Remote Control	16-17	Trouble Checks.....	42-43
Remote Control Battery, Replacing.....	18	Twilight Mode	31
Remote Control Sensor.....	14,17	Unpacking the Camcorder	10
Replacing Battery Cell, Remote Control	18	<i>VIDEO/AUDIO</i> Jacks	15,34,36-37,38-39
<i>REW</i> (Rewind) Button.....	14,15,16,28-29,32,33,35	Video Cassettes.....	23
<i>REW</i> Display.....	26	Viewfinder.....	13,14,26-27,35,41
Safeguards, Important	2-3	Viewfinder Displays.....	26-27
Safety Instructions	Inside Front Cover	Viewfinder Playback	35
Safety Instructions, AC Adapter/ Charger	Inside Front Cover	Viewfinder, Cleaning.....	41
Safety Precautions	1	Visual Searching.....	35
Safety Tab.....	23	Warranty, Limited	46-47
<i>SCENE SEARCH</i> + and – Buttons	14,16,28,35	Wide Angle (<i>W</i>) Zoom Button	14,16-17,32
<i>SCENE SELECT</i> Control.....	13,14,26,29,30,31	Zoom Buttons	14,16-17,32
<i>SCENE SELECT</i> Indicators	26,31	Zooming, Power	32
<i>SCENE SELECT</i> Modes	31		
Searching, Visual.....	35		
Sensor, Remote Control.....	17		
Service and Assistance	45		



For your nearest Home
Entertainment Dealer
or Authorized Servicenter
call toll-free in the U.S.A.

1-800-336-1900

Canadian Consumers –
Your toll-free numbers are:

English: 1-800-522-0338

French: 1-800-522-0445

Thomson Consumer Electronics
600 N Sherman Dr, PO Box 1976
Indianapolis, IN 46206

© 1994 Thomson Consumer Electronics, Inc.

Trademark(s)[®] Registered

Marca(s) Registrada(s)

Printed in Japan

Part Number 94-Pro845-1



Free Manuals Download Website

<http://myh66.com>

<http://usermanuals.us>

<http://www.somanuals.com>

<http://www.4manuals.cc>

<http://www.manual-lib.com>

<http://www.404manual.com>

<http://www.luxmanual.com>

<http://aubethermostatmanual.com>

Golf course search by state

<http://golfingnear.com>

Email search by domain

<http://emailbydomain.com>

Auto manuals search

<http://auto.somanuals.com>

TV manuals search

<http://tv.somanuals.com>