

# RYOBI®

105r, 132r, & 137r

*Electric Trimmers*

## **OPERATOR'S MANUAL**

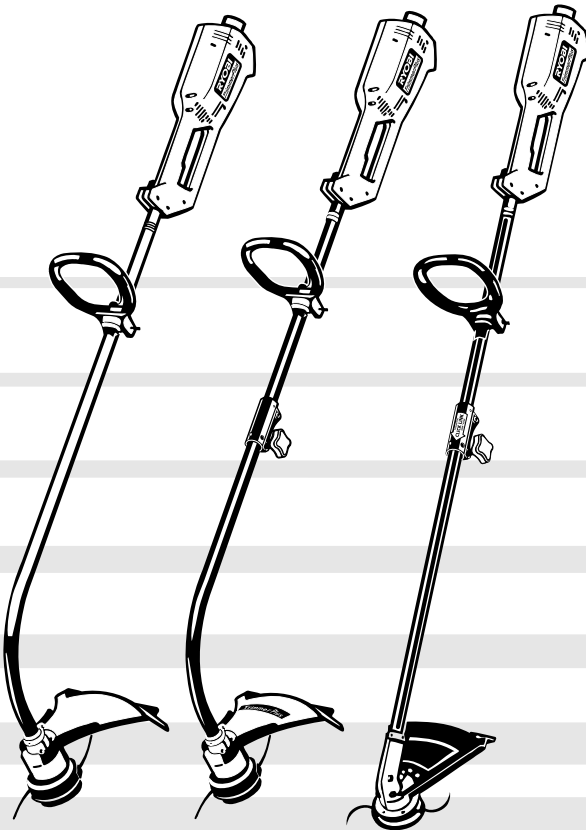

FOR QUESTIONS, CALL 1-800-345-8746 in U.S. or  
1-800-265-6778 in CANADA  
[www.ryobi.com](http://www.ryobi.com)

**IMPORTANT MANUAL**

**DO NOT THROW AWAY**

Download from [Www.Somanuals.com](http://Www.Somanuals.com). All Manuals Search And Download.

# INTRODUCTION

## THANK YOU

Thank you for purchasing this quality product. This modern outdoor power tool is designed to provide many hours of useful service. You will find it to be a great labor-saving device.

This operator's manual provides you with easy-to-understand operating instructions. Read the entire manual and follow all of the instructions to keep your new outdoor power tool in top operating condition.

The other manual that came with your power tool, the parts manual, contains all of the information that you need to order parts.

## PRODUCT REFERENCES, ILLUSTRATIONS AND SPECIFICATIONS

All information, illustrations and specifications in this manual are based on the latest product information available at the time of printing. We reserve the right to make changes at any time without notice.

Copyright © 1998 Ryobi Outdoor Products, Inc. All Rights Reserved.

Click-Link® is a registered trademark of Ryobi Outdoor Products, Inc.

SpeedSpool® is a registered trademark of Ryobi Outdoor Products, Inc.

**NOTE:** PROOF OF PURCHASE WILL BE REQUIRED FOR WARRANTY SERVICE.

**THIS PRODUCT IS COVERED BY ONE OR MORE OF THE US PATENTS: 5,076,149; 4,779,405; 4,651,422; 4,505,040; 4,463,498; 4,369,742; 4,342,236; 4,223,441; 2,125,688; D-249,012; D-239,329; OTHER PATENTS PENDING.**

### SERVICE INFORMATION

Service on this unit both within and after the warranty period should be performed only by an authorized and approved service dealer.

Dial 1-800-345-8746 in the United States and 1-800-265-6778 in Canada to obtain a listing of the authorized service dealer nearest you.

**Do not return the unit to the retailer.**

# TABLE OF CONTENTS

I.	Safety Warnings . . . . .	3-6
	A. Safety and International Symbols . . . . .	6
II.	Assembly Instructions . . . . .	7-8
	A. Installing the D-Handle . . . . .	7
	B. Adjusting the D-Handle . . . . .	7
	C. Installing the String Guard Models 105r and 132r . . . . .	7
	D. Installing the String Guard Model 137r . . . . .	8
III.	Operating Instructions . . . . .	8-10
	A. Connecting the cord . . . . .	8
	B. Starting the trimmer . . . . .	8
	C. Holding the trimmer . . . . .	8
	D. Operating two-speed switch Models 132r and 137r . . . . .	9
	E. Operating the Click-Link System . . . . .	9
	F. Adjusting the trimming line length . . . . .	10
	G. Decorative trimming . . . . .	10
IV.	Maintenance and Repair Instructions . . . . .	11-14
	A. Line installation . . . . .	11
	B. Winding the existing reel . . . . .	11
	C. Cleaning the SpeedSpool® . . . . .	12
	D. Installing a prewound reel . . . . .	13
	E. Cleaning the trimmer . . . . .	14
V.	Specifications . . . . .	14
VI.	Troubleshooting . . . . .	14
VII.	Notes . . . . .	15
VIII.	Warranty . . . . .	16

**Make sure this manual is carefully read and understood before starting or operating this equipment.**

## CONTENTS OF CARTON

This carton includes the following:

- For completely assembled models:
  - Trimmer
  - Operator's manual
  - Owner's registration card
- For unassembled models - hardware pack containing:
  - D-Handle and hardware
  - String guard and screws
  - Operator's manual
  - Owner's registration card

# SAFETY WARNINGS

THE PURPOSE OF SAFETY SYMBOLS IS TO ATTRACT YOUR ATTENTION TO POSSIBLE DANGERS. THE SAFETY SYMBOLS, AND THE EXPLANATIONS WITH THEM, DESERVE YOUR CAREFUL ATTENTION AND UNDERSTANDING. THE SAFETY WARNINGS DO NOT BY THEMSELVES ELIMINATE ANY DANGER. THE INSTRUCTIONS OR WARNINGS THEY GIVE ARE NOT SUBSTITUTES FOR PROPER ACCIDENT PREVENTION MEASURES.

SYMBOL	MEANING
--------	---------



<b>SAFETY ALERT SYMBOL:</b>
-----------------------------

Indicates danger, warning or caution. May be used in conjunction with other symbols or pictographs.
-----------------------------------------------------------------------------------------------------

<b>NOTE:</b> Advises you of information or instructions vital to the operation or maintenance of the equipment.
-----------------------------------------------------------------------------------------------------------------



**DANGER:** Failure to obey a safety warning will result in serious injury to yourself or to others. Always follow the safety precautions to reduce the risk of fire, electric shock, and personal injury.



**WARNING:** Failure to obey a safety warning can result in serious injury to yourself or to others. Always follow the safety precautions to reduce the risk of fire, electric shock, and personal injury.



**CAUTION:** Failure to obey a safety warning may result in property damage or personal injury to yourself or to others. Always follow the safety precautions to reduce the risk of fire, electric shock, and personal injury.

## • IMPORTANT SAFETY INFORMATION •



**WARNING:** When using electric gardening appliances, basic safety precautions should always be followed to reduce the risk of fire, electric shock, and personal injury. Carefully read and understand the entire Operator's Manual before using your trimmer. Pay close attention to the Operating Instructions and Safety Warnings.

- To reduce the risk of electrical shock, this unit has a polarized plug (one blade is wider than the other) and will require the use of a polarized extension cord. This unit plug will fit into a polarized extension cord only one way. If the plug does not fit fully into the extension cord, reverse the plug. If the plug still does not fit, obtain a correct polarized extension cord. A polarized extension cord will require the use of a polarized wall outlet. This plug will fit into a polarized wall outlet only one way. If the plug does not fit fully into the wall outlet, reverse the plug. If the plug still does not fit, contact a qualified electrician to install the proper wall outlet. Do not change the unit plug, extension cord receptacle, or extension cord plug in any way.
- Ground Fault Circuit Interrupter (GFCI) protection should be provided on the circuit(s) or outlet(s) to be used for this unit. Receptacles are available having built-in GFCI protection and may be used for this measure of safety.

## READ ALL INSTRUCTIONS

### ELECTRICAL SAFETY WARNINGS

- This tool is double-insulated. Use only identical replacement parts when servicing. Repair or replace damaged cords.
- WARNING:** To reduce the risk of electrical shock, use only extension cords approved for outdoor use, such as an extension cord of cord type SW-A, SOW-A, STW-A, STOW-A, SJW-A, SJOW-A, SJTW-W or SJTOW-A. A 2-wire extension cord (an extension cord without a ground) may be used because the tool is double insulated. However, a 3-wire extension cord (an extension cord with a ground) that uses a NEMA type connector (parallel blade, U ground) may also be used. Extension cords are available from your local retailer. Use only round-jacketed extension cords approved for outdoor use.

# SAFETY WARNINGS

- **CORD SETS:** Make sure your cord set is in good condition. When using a cord set, be sure to use a cord that is heavy enough to carry the current that your unit will draw. An undersized cord set will cause a drop in line voltage resulting in loss of power and overheating. The table shows the correct size to use depending on the cord length and nameplate amperage rating. If in doubt, use the next heavier size line gauge. The smaller the gauge number, the heavier the cord. To reduce the possibility of disconnection of the unit cord from the cord set during operation, see Fig. 9.
- Thoroughly inspect the trimmer for loose or damaged parts before each use. Do not use until adjustments or repairs are made.
- All guards and safety attachments must be installed properly before operating the unit.
- Use the unit only in daylight or good artificial light.
- Keep all bystanders, especially children and pets, at least 30 feet (9.2 m) away from the unit during operation.
- Before starting, adjust the handle to your size and make sure that the cutting head is not in contact with anything.

## MINIMUM WIRE SIZE FOR EXTENSION CORDS FOR 120 VOLT APPLIANCES USING 0-6 AMPS

Cord length (ft)	25	50	100	150
Wire size (AWG)	16	16	16	14

- A nameplate on your unit indicates what voltage it uses. Never connect the unit to an AC voltage that differs from this voltage.
- Inspect all extension cords and the unit power connection periodically. Look closely for deterioration, cuts or cracks in the insulation. Also inspect the connections for damage. Repair or replace the cords if any defects appear.
- Avoid dangerous environments. Never operate your unit in damp or wet conditions. Moisture is a shock hazard.
- Do not use the unit in the rain.
- Do not handle the plug or the unit with wet hands.

### BEFORE OPERATING

- Read the instructions carefully. Be familiar with the controls and proper use of the unit.
- Children and adolescents must not manipulate units, except for adolescents in training and under the supervision of a specialist.
- Before each use, check that the cutting head is correctly fixed and that the trigger returns automatically in neutral position.

- Be aware of the risk of injury to the head, hands and feet.
- Carefully inspect the areas to be cut. Remove all debris that could become entangled in the string or blade. Also remove any objects that could be thrown during cutting.

### WHILE OPERATING

- Use the right tool. Do not use this trimmer for any job except that for which it is intended.
- Avoid accidental starting. Do not carry plugged-in unit with your finger on the switch. Be sure switch is off when plugging in.
- Do not abuse the power cord. Never carry the unit by the cord or yank the plug out of the receptacle. Keep the cord away from heat, oil and sharp edges.
- Always remain alert. To prevent injury to yourself and others, do not operate this trimmer if you are fatigued.
- Do not operate the unit while under the influence of drugs, alcohol or medication.
- Wear safety glasses or goggles at all times when operating this trimmer.
- Use a face mask or dust mask if operation is dusty.
- Do not overreach. Keep proper footing and balance at all times.
- Dress properly. Do not operate this trimmer when barefoot or wearing open sandals. Always wear sturdy, rubber-soled footwear. The use of gloves, ear/hearing protection and long pants are recommended.

# SAFETY WARNINGS

- Do not wear loose fitting clothing or articles such as scarves, strings, chains, ties, etc., because they could get caught in moving parts. Also make sure long hair does not get caught in moving parts. Long hair must be pulled back and secured off shoulders and neck.
- Keep hands, face, and feet away from all moving parts. Do not attempt to touch or stop the string when it is rotating.
- Always hold the trimmer with both hands when operating. Keep a firm grip on both the front and rear handles or grips.
- Frequently inspect the condition of the cutting head. All damaged parts must be replaced immediately. Follow all the required precautions when undertaking replacement.
- If you strike or become entangled with a foreign object, stop the engine immediately and check for damage. Repair any damage before further operation is attempted. Do not operate the trimmer with loose or damaged parts.
- Do not operate the unit faster than the speed necessary to cut, trim or edge. Do not run the unit at high speed when not cutting.
- Do not force the unit. It will do the job better and with less likelihood of a risk of injury at the rate for which it was designed.
- The string guard must be in place at all times while operating the trimmer. Failure to use the string guard may cause the unit to overheat. **DO NOT OPERATE WITHOUT THE GUARD IN PLACE.**
- Do not extend the trimming line beyond the length of the guard specified in this manual.
- Do not operate trimmer without both trimming lines extended, and the proper line installed.
- Never use metal-reinforced or monofilament line that is not specifically designed for use with your model.
- Keep trimmer clean of vegetation and other materials.
- Always stop the unit when cutting is delayed or when walking from one cutting location to another.
- All interventions, whether for maintenance, repair or for changing cutting head or safety attachments, must be undertaken with the unit disconnected from the power supply.
- Use only genuine replacement parts when servicing this trimmer. These parts are available from your authorized dealer. The use of non-standard parts, or other accessories or attachments not designed for this trimmer, could result in serious injury to the user or damage to the trimmer and void your warranty.

## OTHER SAFETY WARNINGS









- Disconnect the unit from the power supply when not in use, before servicing, when changing accessories such as cutting head, and the like.
- Maintain trimmer with care. Keep the unit clean and serviced for the best and safest performance. Follow the maintenance instructions. Always use a clean cloth when cleaning. Never use strong detergents, gasoline, petroleum-based products, or any strong solvents to clean the unit.
- Keep your unit in good working condition. Follow instructions for servicing and changing accessories. Inspect unit periodically, and if damaged, have it repaired by an authorized service facility. Inspect extension cords periodically and replace if damaged. Keep handles dry, clean, and free from oil and grease.
- Store unit indoors. When not in use, appliances should be stored indoors in a dry, and high or locked-up place, out of the reach of children.
- Keep these instructions. Refer to them frequently and use them to instruct other users. If you loan someone this unit, also loan them these instructions.

## SAVE THESE INSTRUCTIONS

# SAFETY WARNINGS

## SAFETY AND INTERNATIONAL SYMBOLS

This operator's manual describes safety and international symbols and pictographs that may appear on this product. Read the operator's manual for complete safety, assembly, operating and maintenance and repair information.

SYMBOL	MEANING
	<ul style="list-style-type: none"> <li>• <b>SAFETY ALERT SYMBOL</b> Indicates danger, warning, or caution. May be used in conjunction with other symbols or pictographs.</li> </ul>
	<ul style="list-style-type: none"> <li>• <b>READ OPERATOR'S MANUAL</b> Failure to follow operating instructions and safety precautions in operator's manual can result in serious injury. Read operator's manual before starting or operating this unit.</li> </ul>
	<ul style="list-style-type: none"> <li>• <b>FOR SERVICE INFORMATION CALL:</b> <b>USA: 1-800-345-8746</b> <b>CANADA: 1-800-265-6778</b></li> </ul>
	<ul style="list-style-type: none"> <li>• <b>WEAR EYE AND HEARING PROTECTION</b> <b>WARNING:</b> Thrown objects and loud noise can cause severe eye injury and hearing loss. Wear eye and hearing protection when operating this unit.</li> </ul>
	<ul style="list-style-type: none"> <li>• <b>THROWN OBJECTS AND ROTATING CUTTER CAN CAUSE SEVERE INJURY</b> <b>WARNING:</b> Do not operate without guard in place. Keep away from rotating cutter.</li> </ul>
	<ul style="list-style-type: none"> <li>• <b>KEEP BYSTANDERS AWAY</b> <b>WARNING:</b> Keep all bystanders, especially children and pets, at least 30 feet (9.2 m) away from the trimming area.</li> </ul>
	<ul style="list-style-type: none"> <li>• <b>SHARP BLADE</b> Sharp blade on guard! Can cause injury. Do not touch blade.</li> </ul>
	<ul style="list-style-type: none"> <li>• <b>SPEED SWITCH OR THROTTLE SWITCH</b> Indicates "HIGH" or "FASTEST" speed.</li> </ul>
	<ul style="list-style-type: none"> <li>• <b>SPEED SWITCH OR THROTTLE SWITCH</b> Indicates "LOW" or "SLOWEST" speed.</li> </ul>

# ASSEMBLY INSTRUCTIONS

If the D-Handle on your unit is not assembled, use the following instructions.

## INSTALLING THE D-HANDLE

1. Push the D-Handle down over the boom (Fig. 1).
2. Install the bolt, washer, and wing nut, and tighten (Fig. 2).

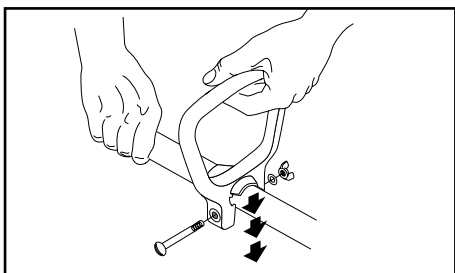

Fig. 1

If the D-Handle on your unit is assembled, use the following instructions.

## ADJUSTING THE D-HANDLE

1. Loosen the wing nut. It is not necessary to remove the wing nut, washer and bolt.
2. Rotate the D-Handle 180° (top of the boom) to the correct operating position.
3. Position the D-Handle as desired and tighten the wing nut (Fig. 2).

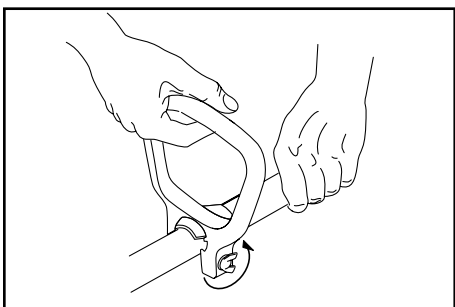

Fig. 2

If the string guard on your unit is not installed, use the following instructions.

## INSTALLING THE STRING GUARD - MODELS 105r AND 132r



**WARNING:** To avoid serious personal injury, never operate the trimmer without the string guard in place.

1. Place the string guard onto the boom above the clamp assembly (Fig. 3).

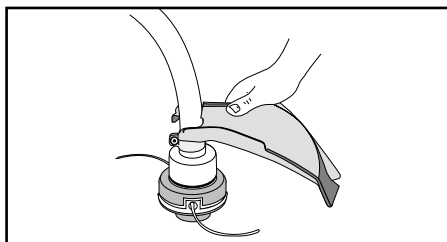

Fig. 3

2. Push the string guard down to the top of the string head assembly and then rotate the string guard to the proper position (Fig. 4).

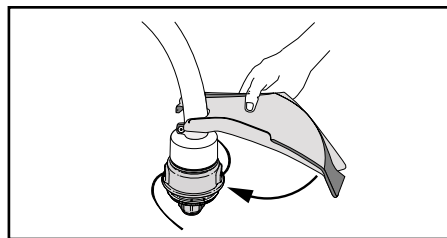

Fig. 4

3. Install the screws with a Phillips screwdriver (Fig. 5).

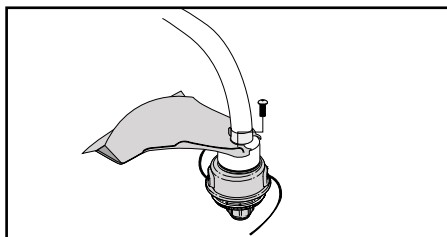

Fig. 5

# ASSEMBLY INSTRUCTIONS

If the string guard on your unit is **not** installed, use the following instructions.

## INSTALLING THE STRING GUARD - MODEL 137r



**WARNING:** To avoid serious personal injury, never operate the trimmer without the string guard in place.

1. Slide the string guard onto the guard mount above the string head assembly. Align the screw holes in the string guard with the screw holes in the string assembly (Fig. 6).

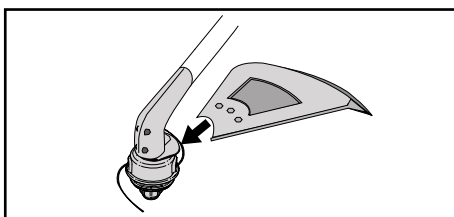

Fig. 6

2. Place the three hex nuts into the recessed holes on top of the guard (Fig. 7).

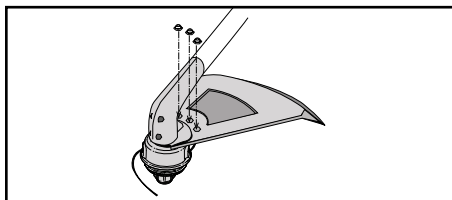

Fig. 7

3. Install the screws into the holes from the bottom of the guard (Fig. 8).

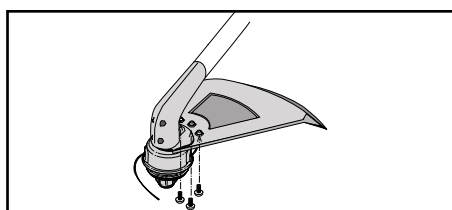

Fig. 8

# OPERATING INSTRUCTIONS

This trimmer has been designed and built to withstand normal use. It will provide many hours of service provided the operating instructions are closely followed.



**WARNING:** Always wear eye, hearing, foot and body protection to reduce the risk of injury when operating this unit.

## CONNECTING THE CORD

1. Use the cord hook when you connect the extension cord to the power cord to prevent disconnection (Fig. 9). Use only an outdoor-approved extension cord as specified in the **SAFETY WARNINGS** section.

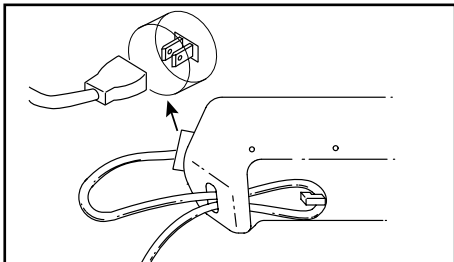

Fig. 9

## STARTING THE TRIMMER

Squeeze the trigger to start the trimmer.

## STOPPING THE TRIMMER

Release the trigger to stop the trimmer.

## HOLDING THE TRIMMER

While operating unit, hold the trimmer as shown in Fig. 10.

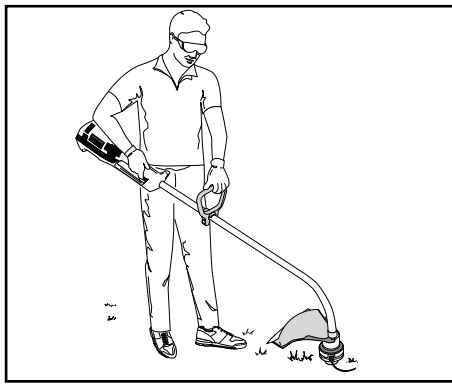

Fig. 10



# OPERATING INSTRUCTIONS

## OPERATING THE TWO-SPEED SWITCH - MODELS 132r AND 137r ONLY

This unit is equipped with a two-speed switch - a powerful high speed for demanding yard work, and a precision low speed for light-duty yard work.

Push the switch up for high speed trimming.  
Push the switch down for low speed trimming (Fig. 11).

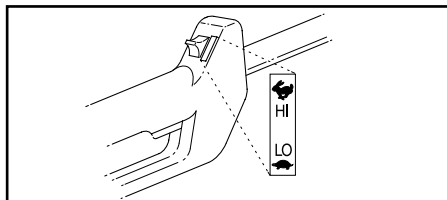

Fig. 11

## OPERATING THE CLICK-LINK® SYSTEM - MODELS 132r AND 137r

Models 132r and 137r are equipped with a Click-Link System, which enables optional attachments to be installed on this unit.

The optional attachments are:

Sweeper/Blower .....	SB720r
Vacuum .....	LV720r
Edger .....	LE720r
Cultivator .....	GC720r
Straight Shaft Trimmer .....	SS670r or SS725r
Tree Pruner .....	TP720r
Snow Thrower .....	ST720r
Hedge Trimmer .....	HS720r
Blower/Vacuum .....	BV720r
Blower .....	TB720r

## Removing the Lower (Attachment) Boom

**NOTE:** To make removing the boom easier, place the unit on the ground or on a table.

1. Loosen the knob **counterclockwise** (Fig. 12).
2. Push the release button **in** (Fig. 12).
3. Pull the lower boom straight out of the Click-Link (Fig. 13).

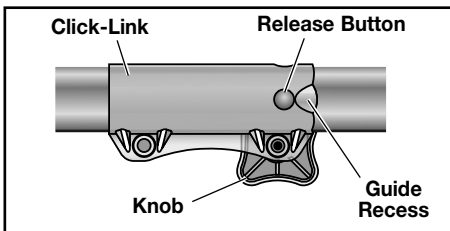

Fig. 12

If your unit **is not** assembled, or you have more than one attachment, use the following instructions:

## Installing the Lower (Attachment) Boom

1. Remove the hanger from the lower (attachment) boom. Hold the release button down while pushing the lower (attachment) boom into the Click-Link (Fig. 13).
2. **FOR BASIC TRIMMING OR USING OTHER RYOBI ATTACHMENTS** - Locate and lock the release button into the primary hole in the Click-Link (Fig. 13).

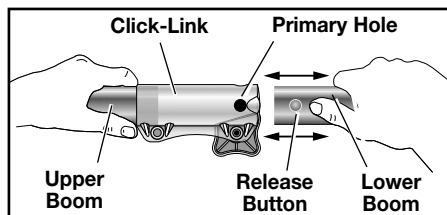
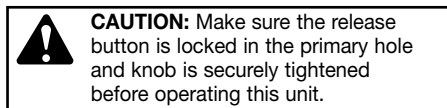

Fig. 13

3. Tighten the knob securely **clockwise** before using the unit (Fig. 14).

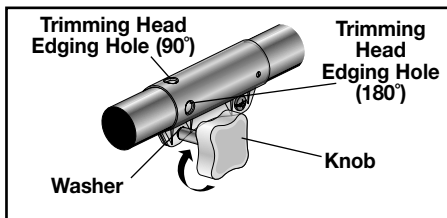
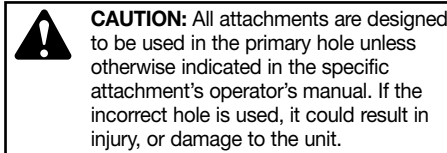

Fig. 14

# OPERATING INSTRUCTIONS

## ADJUSTING THE TRIMMING LINE LENGTH

Your trimmer is equipped with a bump head, which allows the operator to release more trimming line without stopping the motor. As the line becomes frayed or worn, additional line can be released by lightly tapping the trimming head on the ground (Fig. 15a - Models 105r and 132r; Fig. 15b - Model 137r) while operating the trimmer at **high speed**.

**NOTE:** Always keep the trimming line fully extended. Line release becomes more difficult as cutting line becomes shorter.

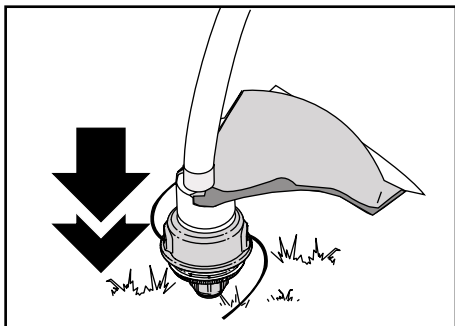

Fig. 15a

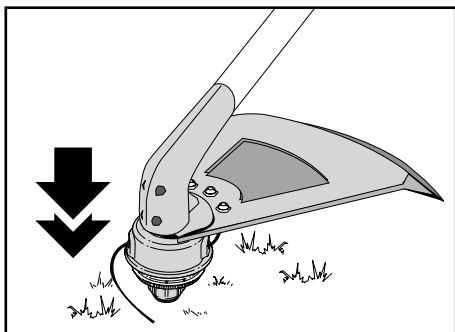

Fig. 15b

Each time the head is bumped, approximately 1 in (25.4 mm) of trimming line is released. A blade in the string guard will cut the line if excess line is released.

For best results, tap the head on bare ground or hard soil. If line release is attempted in tall grass, the motor may overheat. Always keep the trimming line fully extended. Line release becomes more difficult as the cutting line becomes shorter.



**WARNING:** Do not remove or alter the lead cutting blade assembly. Excessive line length will cause the motor to overheat and may result in serious personal injury.

## DECORATIVE TRIMMING

Decorative trimming is accomplished by removing all vegetation around trees, posts, fences, etc. Use a 30-degree angle when trimming with this method (Fig. 16a - Models 105r and 132r; Fig. 16b - Model 137r).

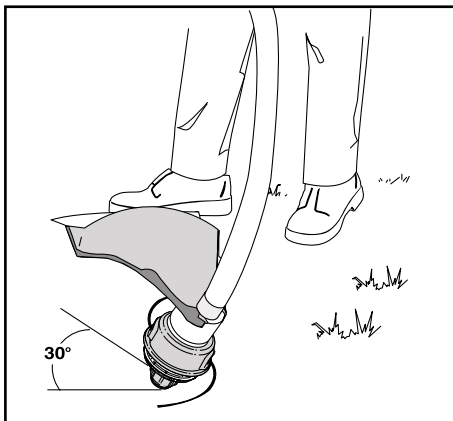

Fig. 16a

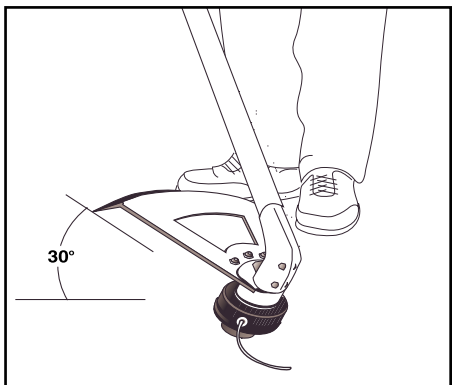

Fig. 16b

## EDGING - MODELS 132r AND 137r

For edging with the trimming head attachment on Models 132r and 137r, locate and lock the release button into the second hole (90 degrees) or third hole (180 degrees) in the Click-Link system (Fig. 14).

# MAINTENANCE AND REPAIR INSTRUCTIONS

## LINE INSTALLATION FOR THE SPEEDSPOOL®

The trimming line in the speed spool may be replaced by two different methods.

- Winding the existing inner reel with new line
- Installing a prewound inner reel

## THE CORRECT LINE TO USE



**WARNING:** Always use genuine Monoflail® replacement line. Do not use metal-reinforced line.

It is very important to use the correct size line. Line with a diameter of 0.60 in (1.52 mm) must be used on Model 105r; 0.080 in (2.03 mm) for Models 132r and 137r. The motor may overheat and fail if you use a larger line.

**TO INSTALL NEW TRIMMING LINE, IT IS NOT NECESSARY TO REMOVE THE BUMP KNOB.**

## Winding the existing inner reel with new line

**NOTE:** Before installing new trimming line onto the existing inner reel, remove any old line from the SpeedSpool by pulling the line out of the line loading or locking holes (See Figs. 18 and 19 for location of holes).

1. Line up the arrow on the inner reel with the arrow on the outer spool (Fig. 17).

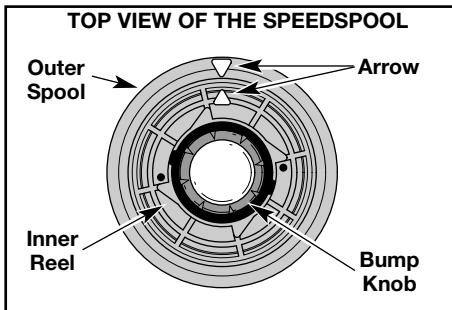

Fig. 17

**NOTE:** Do not wind the inner reel before the second line is installed into the reel.



**WARNING:** Always use the correct line length when installing trimming line on the unit. If longer line is used than specified in this manual, the line may not release properly.

2. Insert **10 feet (2.5 m)** for models with **.080 in (2.03 mm)** of trimming line and **15 ft (4.5 m)** for models with **.060 in (1.52 mm)** line into one of the two eyelets and push it up through the line loading hole in the inner reel (Fig. 18). Do not bend the line when inserting it into the eyelet.

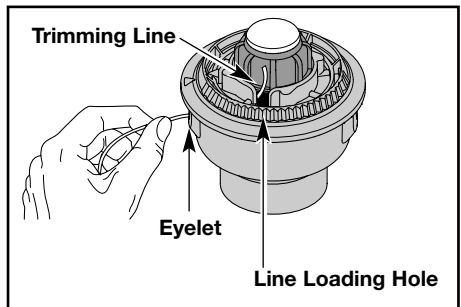

Fig. 18

3. Insert the line into the locking hole (Fig. 19) no more than 1/2 inch (12.7 mm). Do not push the line too far into the inner reel. A small loop is formed when the line is inserted correctly (Fig. 19).

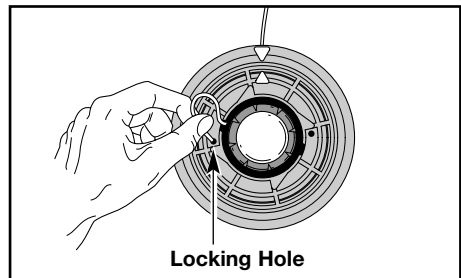

Fig. 19

# MAINTENANCE AND REPAIR INSTRUCTIONS

4. Pull the line away from the spool until the line is tight against the inner reel (Fig. 20).

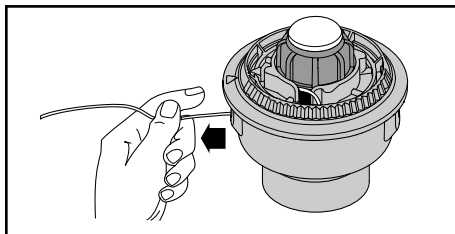

Fig. 20

5. Repeat the procedure with the second eyelet and use the same amount of line as specified in Step 2.
6. Wind the inner reel counterclockwise until approximately four (4) inches of line remains outside of the eyelets in the outer spool (Fig. 21).

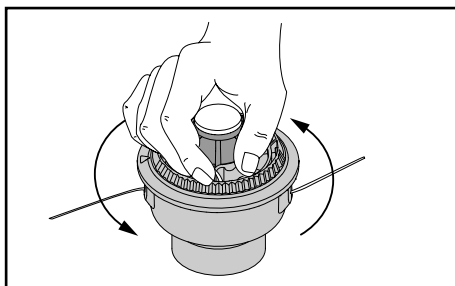

Fig. 21

7. If winding the line becomes difficult or the line jams, pull the ends of the line away from the spool and continue winding the inner reel counterclockwise (Fig. 22).

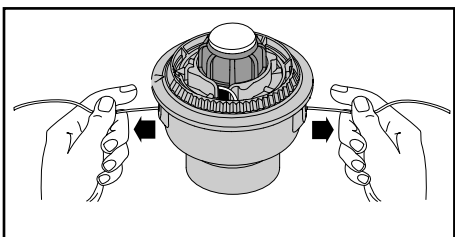

Fig. 22

## RELEASING THE INNER REEL

If the speed spool does not operate correctly when bumping the head on the ground, use the following instructions.

1. Pull the ends of the line firmly away from the spool to release the inner reel (Fig. 23). If this procedure does not release the inner reel, follow the "Cleaning the SpeedSpool" instructions below.

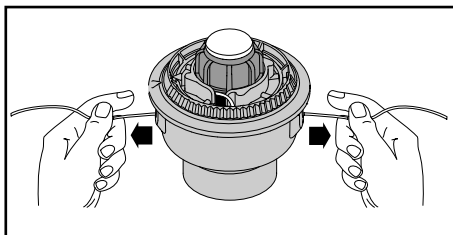

Fig. 23

## CLEANING THE SPEEDSPOOL

If the SpeedSpool becomes difficult to wind or does not operate correctly when bumping the head on the ground, use the following instructions.

1. If you need to remove the Bump Knob to clean the spool or remove jammed, excess line, hold the outer spool, and unscrew the Bump Knob counterclockwise (Fig. 24).

**TO INSTALL NEW TRIMMING LINE, IT IS NOT NECESSARY TO REMOVE THE BUMP KNOB.**

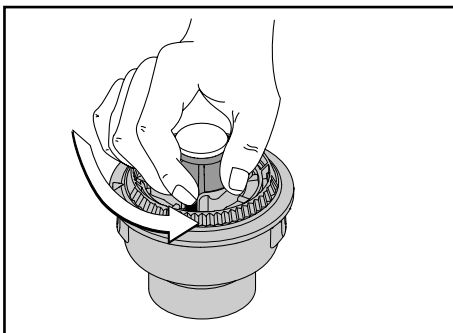

Fig. 24

# MAINTENANCE AND REPAIR INSTRUCTIONS

2. Remove the Bump Knob, foam seal, spring, inner reel, and trimming line from the outer spool (Fig. 25).

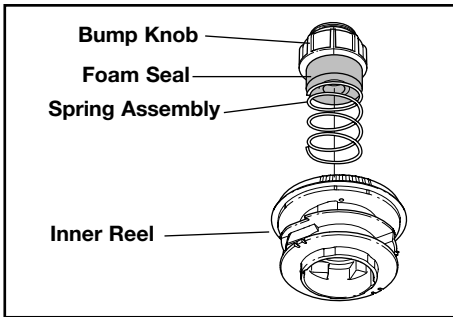

Fig. 25

3. Remove any debris or grass from the knob, spring, inner reel, and foam seal. Remove any existing line from the inner reel before cleaning. Wash the inner reel with warm soapy water (Fig. 26).

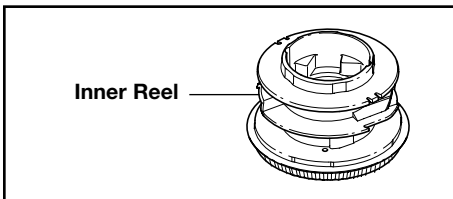

Fig. 26

**NOTE:** The inner reel must be completely dry before reinstalling it into the outer spool. Do not lubricate the inner reel or outer spool assembly.

4. Clean the shaft and the inner surface of the outer spool. To clean the shaft underneath the plunger, press down on the plunger (Fig. 27). Remove any dirt and/or debris from the shaft.

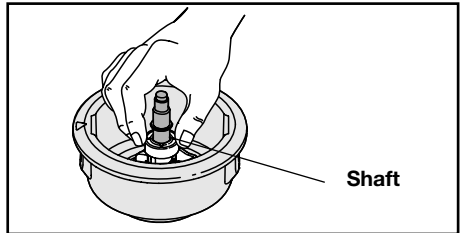

Fig. 27

5. Install the inner reel, spring, foam seal, and Bump Knob into the outer spool (Fig. 25).
6. Tighten the Bump Knob clockwise.
7. Install new line as described on pages 11 and 12.

## INSTALLING A PREWOUND REEL

1. Insert the ends of the two trimming lines into the eyelets in the outer spool (Fig. 28), then grasp the ends and pull firmly to release the line from the holding slots in the outer spool.
2. Hold the inner reel in place and install the Bump Knob, spring and foam seal in the counterclockwise direction. Line installation is now complete.

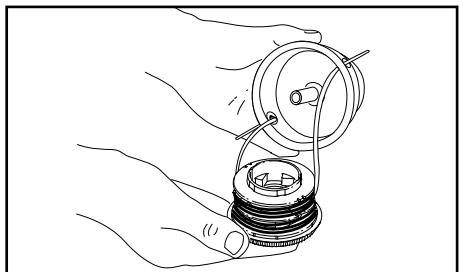

Fig. 28



# NOTES

## LIMITED TWO-YEAR WARRANTY

RYOBI OUTDOOR PRODUCTS warrants each new RYOBI Product for two (2) years according to the following terms.

This warranty extends to the original retail purchaser only and commences on the date of original retail purchase.

Any part of the RYOBI Product manufactured or supplied by RYOBI and found in the reasonable judgement of RYOBI to be defective in material or workmanship will be repaired or replaced by an authorized RYOBI service dealer without charge for parts and labor.

The RYOBI Product including any defective part must be returned to an authorized service dealer within the warranty period. The expense of delivering the RYOBI Product to the dealer for warranty work and the expense of returning it back to the owner after repair or replacement will be paid for by the owner. RYOBI's responsibility in respect to claims is limited to making the required repairs or replacements and no claim of breach of warranty shall be cause for cancellation or rescission of the contract of sale of any RYOBI Product. Proof of purchase will be required by the dealer to substantiate any warranty claim. All warranty work must be performed by an authorized RYOBI service dealer.

This warranty is limited to ninety (90) days from the date of original retail purchase for any RYOBI Product that is used for rental or commercial purposes, or any other income-producing purpose.

This warranty does not cover any RYOBI Product that has been subject to misuse, neglect, negligence, or accident, or that has been operated in any way contrary to the operating instructions as specified in the RYOBI Operator's Manual. This warranty does not apply to any damage to the RYOBI Product that is the result of improper maintenance or to any RYOBI Product that has been altered or modified so as to adversely affect the product's operation, performance or durability or that has been altered or modified so as to change its intended use. The warranty does not extend to repairs made necessary by normal wear or by the use of parts or accessories which are either incompatible with the RYOBI Product or adversely affect its operation, performance or durability.

RYOBI reserves the right to change or improve the design of any RYOBI Product without assuming any obligation to modify any product previously manufactured.

ALL IMPLIED WARRANTIES ARE LIMITED IN DURATION TO THE TWO (2) YEAR WARRANTY PERIOD OR NINETY (90) DAYS FOR PRODUCTS USED FOR ANY COMMERCIAL PURPOSE. ACCORDINGLY, ANY SUCH IMPLIED WARRANTIES INCLUDING MERCHANTABILITY, FITNESS FOR A PARTICULAR PURPOSE, OR OTHERWISE, ARE DISCLAIMED IN THEIR ENTIRETY AFTER THE EXPIRATION OF THE APPROPRIATE TWO-YEAR OR NINETY DAY WARRANTY PERIOD. RYOBI'S OBLIGATION UNDER THIS WARRANTY, IS STRICTLY AND EXCLUSIVELY LIMITED TO THE REPAIR OR REPLACEMENT OF DEFECTIVE PARTS, AND ROP DOES NOT ASSUME OR AUTHORIZE ANYONE TO ASSUME FOR THEM ANY OTHER OBLIGATION. SOME STATES DO NOT ALLOW LIMITATIONS ON HOW LONG AN IMPLIED WARRANTY LASTS, SO THE ABOVE LIMITATION MAY NOT APPLY TO YOU.

RYOBI ASSUMES NO RESPONSIBILITY FOR INCIDENTAL, CONSEQUENTIAL OR OTHER DAMAGES INCLUDING, BUT NOT LIMITED TO EXPENSE OF RETURNING THE RYOBI PRODUCT TO AN AUTHORIZED SERVICE DEALER AND EXPENSE OF DELIVERING IT BACK TO THE OWNER, MECHANIC'S TRAVEL TIME, TELEPHONE OR TELEGRAM CHARGES, RENTAL OF A LIKE PRODUCT DURING THE TIME WARRANTY SERVICE IS BEING PERFORMED, TRAVEL, LOSS OR DAMAGE TO PERSONAL PROPERTY, LOSS OF REVENUE, LOSS OF USE OF THE PRODUCT, LOSS OF TIME, OR INCONVENIENCE. SOME STATES DO NOT ALLOW THE EXCLUSION OR LIMITATION OF INCIDENTAL OR CONSEQUENTIAL DAMAGES, SO THE ABOVE LIMITATION OR EXCLUSION MAY NOT APPLY TO YOU.

This warranty gives you specific legal rights, and you may also have other rights which vary from state to state.

This warranty applies to all RYOBI Products manufactured by RYOBI and sold in the United States and Canada.

To locate your nearest service dealer dial 1-800-345-8746 in the United States or 1-800-265-6778 in Canada.

# RYOBI®

**RYOBI OUTDOOR PRODUCTS**

550 N. 54th Street  
Chandler, AZ 85226 U.S.A.

**RYOBI CANADA INC.**

275 Industrial Rd  
Cambridge, Ontario N1R 6K2 CANADA

**SAVE THESE INSTRUCTIONS FOR FUTURE REFERENCE.**

**FOR QUESTIONS CALL 1-800-345-8746 IN U.S.  
OR 1-800-265-6778 IN CANADA**

**OPERATOR'S MANUAL PART NO. 181674  
PRINTED IN U.S.A.**

**REV. B (51449)  
10/98**



## Free Manuals Download Website

<http://myh66.com>

<http://usermanuals.us>

<http://www.somanuals.com>

<http://www.4manuals.cc>

<http://www.manual-lib.com>

<http://www.404manual.com>

<http://www.luxmanual.com>

<http://aubethermostatmanual.com>

Golf course search by state

<http://golfingnear.com>

Email search by domain

<http://emailbydomain.com>

Auto manuals search

<http://auto.somanuals.com>

TV manuals search

<http://tv.somanuals.com>