

SanDisk

STORE YOUR WORLD IN OURS[®]

SanDisk Sansa[™] e200R Rhapsody[®]

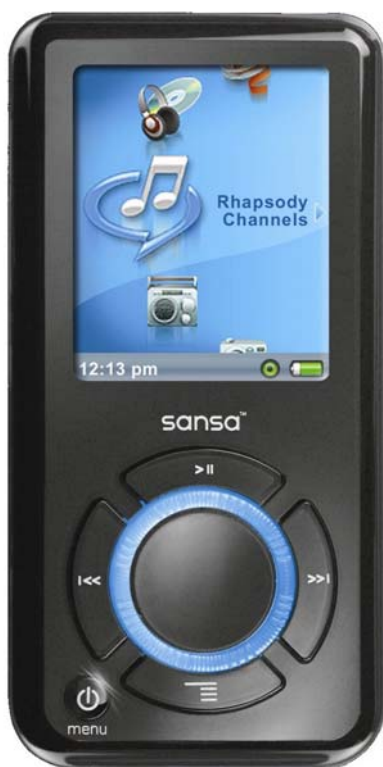

User Guide

Table of Contents

Safety Instructions	5
Introduction	6
Package Contents	8
Getting Started	9
Overview Of Features	9
Music Screen Features	10
Playback Screen Features	11
Li-ion Battery Charge	12
Battery Level Indicator	13
Battery Replacement	14
Hold Switch (Factory set to the locked position)	14
Minimum System Requirements	14
Firmware Upgradeable	15
Connecting to Your Computer	15
Rhapsody and PlaysForSure Modes	15
Connect to your computer	16
Transferring Files	16
Transfer Music	16
Transfer Playlists	17
Delete Music Files	18
Synchronize Files	19
Photo/Video Transfer-Sansa Media Converter	20
Supported Import media types	21
Transfer Photos and Video	21
Delete Photos and Video	22
Safely Removing Sansa e200R Rhapsody from the Computer	23
Basic Usage	24
Power On	24
Using Thumbwheel	25
Main Menu	25
Using Navigation Buttons	26
Using Submenu Button	26
Power Off	26
Music Mode	26

▪ Music/Voice/FM Playback.....	26
▪ Setting Repeat Mode.....	27
▪ Setting Shuffle Mode.....	28
▪ Setting Music EQ.....	28
▪ Remove Songs from Playlist.....	29
▪ Scan Through Song.....	30
▪ Rate This Song.....	30
▪ View Artist Info.....	31
▪ Rhapsody Channels.....	31
▪ Add Track to Library.....	32
▪ Ban Track.....	32
▪ Purchase.....	33
Photo Mode.....	34
▪ Viewing Photos.....	34
Slideshow.....	35
▪ Slideshow Options.....	35
Video Mode.....	36
▪ Playing Video.....	36
FM Radio Mode.....	37
▪ FM Radio.....	37
▪ FM Preset.....	38
Recording Mode.....	39
▪ Voice Recording.....	39
▪ FM Radio Broadcast Recording.....	40
Settings Mode.....	41
▪ Set Music Options.....	41
▪ Set Radio Options.....	42
▪ Set Slideshow Options.....	42
▪ Best Buy Digital Music Store Account.....	43
▪ Set Backlight.....	43
▪ Set Language.....	44
▪ Set Date and Time.....	44
▪ Set Brightness.....	44
▪ Set Volume.....	45
▪ Reset All.....	45
▪ Info.....	46

- Set Auto Shut-Off 46
- Set USB Mode 46
- Set Record Button 47
- Set Press and Hold 47
- Tips, FAQ, and Troubleshooting 48**
- Service and Warranty Information 52**
 - Getting Technical Support 52
 - Learn More 52
- 1-YEAR SanDisk Limited Warranty..... 53**
- USER NOTICE 55**
- End User License Agreement 56**
- FCC Regulation..... 61**
- Important - Safe Hearing Level Info 62**

Safety Instructions

1. **Read the safety instructions carefully before using your Sansa e200R Rhapsody MP3 Player.**
2. Read this entire manual to ensure proper usage.
3. Keep this User Guide for future reference.
4. Do not use **Headphones/Earphones** while driving, cycling, or operating any motorized vehicle. This may create a traffic hazard and may be illegal in some areas. It can also be dangerous to play your music with **Headphones/Earphones** at high volume while walking, or engaged in other activities. You should exercise extreme caution and discontinue use in potentially hazardous situations.
5. Avoid using **Headphones/Earphones** at high volume. Hearing experts advise against continuous loud and extended music play. Keep the volume at a moderate level, so that you are better able to hear outside sound, and to be considerate of the people around you. Refer to section on **Safe Hearing Level Info** for more details.
6. Keep your player away from sinks, drinks, bathtubs, showers, rain, and other sources of moisture. Moisture can cause electric shocks with any electronic device.
7. Follow these tips to keep your player working well for a long time:
 - Clean your player with a soft lint-free cloth used on glass lenses.
 - Do not allow young children to use your player unsupervised.
 - Never force any connector into the ports of your player or your computer. Make sure your connectors are the identical shape and size before you connect.
8. Do not disassemble, crush, short-circuit or incinerate battery as it may cause fire, injury, burns or other hazards.

Introduction

Congratulations on your purchase of a **SanDisk Sansa™ e200R Rhapsody® MP3 Player**.

The Sansa e200R Rhapsody is a high performance portable digital audio/video player with a large 1.8” TFT color screen, digital FM tuner, voice recorder, microSD™ card expansion slot, and a replaceable and rechargeable Lithium Ion battery.

The Sansa e200R Rhapsody is optimized to work seamlessly with the Best Buy Digital Music Store powered by Rhapsody subscription service and media player. The device display includes current subscription status. This player comes pre-loaded with a wide selection of Rhapsody Channels and playlists.

The Sansa e200R Rhapsody provides superior sound playback and enables users to play MP3, AAC, RAX, WMA, and secure WMA audio files. This device records FM radio broadcasts, and has a voice recorder function. It also supports Microsoft PlaysForSure subscription music.

The Sansa e200R Rhapsody plays video, and displays photos that are transferred to the player through the Sansa Media Converter software. The converter supports most image formats allowing you to enjoy photos and personal videos anywhere you go.

The Sansa e200R Rhapsody is available in the following capacity points:

2GB (e250R), 4GB (e260R), 6GB (e270R), 8GB (e280R)

		2GB	4GB	6GB	8GB
MP3	Hours of Music Content	32	64	96	128
	Number of Songs	500	1000	1500	2000

Note: Approximation based on 4 minute songs at 128 kbps MP3 (3,932,160 bytes/song)

1 megabyte (MB) = 1 million bytes; 1 gigabyte (GB) = 1 billion bytes. Some of the listed capacity is used for formatting and other functions, and thus is not available for data storage.

Features:

- **Digital Audio Player** – supports MP3, AAC, RAX, WMA, and secure WMA audio files. Convert and transfer other file types automatically with the included Best Buy Digital Music Store Media Player.
- **Video Player** – supports video files converted and transferred to the device through the included Sansa Media Converter software.
- **Photo Browser** – supports photo files converted and transferred to the device through the included Sansa Media Converter software.
- **FM Radio** – includes an integrated FM radio for listening to live-broadcast FM radio stations.
- **Voice Recorder** – supports voice recording function with built-in microphone.
- **FM Radio Program Recording** – provides synchronous recording function for FM recorded files.
- **EQ effect** – you are able to select an EQ mode to personalize your music experience.

- **microSD™ Slot** – supports read or write of Music Files from external microSD cards.
- **Internal Memory** – allows users to store data on the internal memory

Package Contents

Please unpack your **Sansa e200R Rhapsody** and check that the following were included.

- Earphones
- USB 2.0 Travel Cable
- Installation CD (User Guide, Best Buy Digital Music Store Media Player, Best Buy Digital Music Store Preview, and Sansa Media Converter included)
- End User License Agreement Insert in CD Sleeve
- Loud Music Warning Insert
- Quick Start Guide
- Travel Pouch
- Lanyard

Getting Started

Overview Of Features

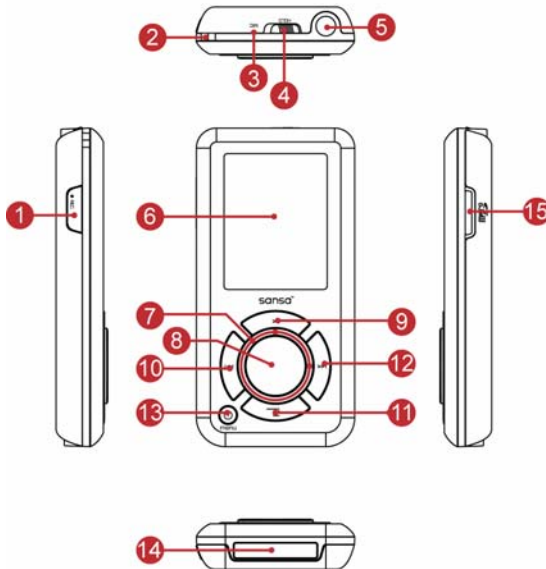

- | | |
|--------------------------|---|
| 1. Record | Voice Record Button. |
| 2. Strap Eyelet | Lanyard connection. |
| 3. MIC | Internal Microphone. |
| 4. Hold | Factory set to locked position (orange color visible). Slide to unlock controls. When locked all controls are disabled. Lock to prevent accidental activation of controls. |
| 5. Earphone Port | Connect earphones here to listen to player. |
| 6. Display Window | Read status and information here. |

- 7. **Thumbwheel** Rotate to select menu items or adjust volume.
- 8. **Select Button** Press to select the item.
- 9. **Up/Pause/Resume** Press to move up one item, pause, or resume.
- 10. **Left/Previous/Rewind** Press for previous track, rewind, or move left.
- 11. **Down/Submenu** Press to move down or to options menu.
- 12. **Right/Forward** Press for next track, fast forward, or move right.
- 13. **Power/Menu/Reset** Press to power on/off, enter menu, or hold 15 seconds to reset your Sansa e200R Rhapsody. When the player is locked using the Hold switch, described above, the player will not power on or off. All controls will be disabled.
- 14. **Dock Connector Port** Plug the Dock Connector Cable here.
- 15. **microSD Card Slot** Insert microSD, or gruvi™ content cards.

Music Screen Features

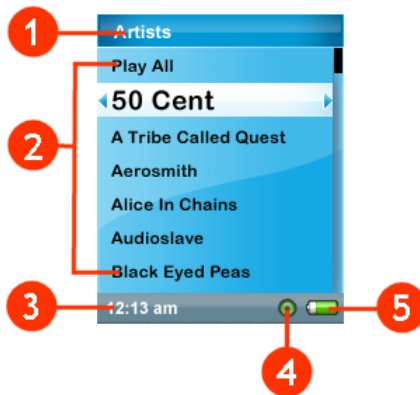

- 1. **Menu Title** Displays the title of the current menu.
- 2. **Items** Displays items for selection.
- 3. **Time** Indicates the current time.

4. **Subscription Status** Indicates the Best Buy Digital Music Store subscription status.
5. **Battery** Indicates the Battery Charge status.

Playback Screen Features

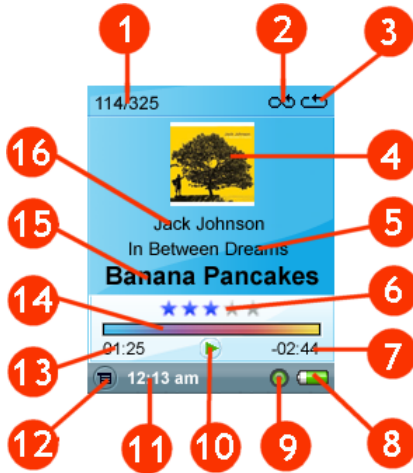

1. **Track Number** Display the current track number and the total number of tracks on the device.
2. **Shuffle** Indicates when Shuffle function is enabled.
3. **Repeat** Indicates when Repeat function is enabled.
4. **Album Art** Displays the current playback track album art, if available.
5. **Album Name** Displays the album name of the current playback track.
6. **Track Rating** Displays the rating of the current playback track.
7. **Track Timer** Displays the time remaining in the current playback track.
8. **Battery** Indicates the battery status.

- 9. **Subscription Status** Indicates the Best Buy Digital Music Store subscription status.
- 10. **Play/Pause/Stop** Displays the music or voice file's playback status.
- 11. **Clock** Displays current time.
- 12. **Submenu** Indicates that there is a Submenu available.
- 13. **Track Length** Displays the elapsed time of current playback track.
- 14. **Progress Meter** Displays the percentage of the track that has played.
- 15. **Song Name** Displays the current playback track song name.
- 16. **Artist Name** Displays the current playback track artist name.

Li-ion Battery Charge

The Sansa e200R Rhapsody comes with a replaceable Li-ion rechargeable battery. To use the device for the very first time, remember to fully charge the Li-ion battery. You can charge your Sansa e200R Rhapsody through the USB port of your computer, a car adapter (not included) USB port, or AC adapter (not included) USB port.

Computer USB charging instructions below:

1. Connect the small connector of the USB Cable to the USB port on the computer, and then plug the larger end in to the Sansa e200R Rhapsody Dock Connector. The computer must be on for most USB ports to charge your battery. Your Sansa e200R Rhapsody will show connected and the yellow charging indicator will appear. The battery level indicator will blink while charging. You will not be able to play while connected to the computer USB.



2. To stop recharging, disconnect the cable.

If you are using an AC adapter (not included) or Car Adapter (not included), you will be able to play your device while charging.

The Li-ion rechargeable battery will reach approximately 70% charge in 2.5 hours and full charge in about 3.5 hours. It is recommended that you fully charge your Sansa e200R Rhapsody before first use.

Note: Some low-power USB ports may not be able to provide enough charge power. Also note that rechargeable batteries may eventually need to be replaced as they have limited charge cycles (which vary with use and settings).

Battery Level Indicator

Battery is Half Full



Battery is Low



Battery Replacement

The Li-ion rechargeable battery is replaceable. To purchase a replacement battery, visit your local retailer or www.sandisk.com.

Follow the instructions provided with the replacement battery.

Battery Warning



CAUTION: *Do not disassemble, crush, short-circuit or incinerate your battery as it may cause fire, injury, burns or other hazards.*

Hold Switch (Factory set to the locked position)

The Sansa e200R Rhapsody Hold Switch is located on the top of the device, and is used to prevent any accidental operation. When the Hold Switch is moved to the lock position (orange color visible), buttons on the Sansa e200R Rhapsody will not operate.



Minimum System Requirements

- Windows XP SP1
- Intel Pentium class computer or higher
- CD-ROM drive

- USB 2.0 port required for high speed transfer

Firmware Upgradeable

SanDisk occasionally releases firmware updates, which includes bug fixes and performance enhancements. When you connect your Sansa e200R Rhapsody to the Best Buy Digital Music Store Media Player, the firmware is checked and required updates are installed. If you are not using the Best Buy Digital Music Store, to make sure your Sansa e200R Rhapsody series player has the latest firmware please visit <http://www.sandisk.com/e200Rseries/fwupgrade> and follow the instructions.

Connecting to Your Computer

Rhapsody and PlaysForSure Modes

Your Sansa e200R Rhapsody can operate in two different USB modes, Rhapsody (Mass Storage Class) and PlaysForSure (Media Transfer Protocol). The default setting is Rhapsody mode. From your Sansa e200R Rhapsody's main menu, go to Settings/USB Modes/Rhapsody or PlaysForSure to change the mode.

Note: Rhapsody mode supports all the optimized features of the Best Buy Digital Music Store Media Player, including PlaysForSure tracks. You must use Rhapsody mode to transfer Rhapsody Channels and track ratings using the Best Buy Digital Music Store Media Player.

In Rhapsody mode your device will show under your computer's "My Computer" as Removable Drives. One drive for your Sansa e200R Rhapsody

MP3 player and one drive for the microSD card if inserted into the expansion card slot. Rhapsody mode is needed to get the most out of the Best Buy Digital Music Store.

In PlaysForSure mode the device will show up as “Sansa e200R Rhapsody” and no microSD card will be displayed. PlaysForSure mode is needed when using your device with some software and monthly music subscription services.

Connect to your computer

1. Connect the small USB Cable end to the computer USB port and plug the larger Cable Dock Connector to your **Sansa e200R Rhapsody port**.
2. The Sansa e200R Rhapsody will show connected and your computer will show the device.



Transferring Files

Transfer Music

Your Sansa e200R Rhapsody is optimized to work with the included Best Buy Digital Music Store software. Insert your Install CD into your computer’s CD-ROM drive and select Best Buy Digital Music Store Media Player.

Tip: for a quick overview of Best Buy Digital Music Store, check out the Best Buy Digital Music Store Preview movie on the Install CD.

Follow these steps to transfer music files or files organized in directories to your Sansa e200R Rhapsody.

Using the Best Buy Digital Music Store powered by Rhapsody:

1. Connect to your computer and select “Manage the device using Best Buy Digital Music Store.”
2. The Best Buy Digital Music Store opens and the Sansa e200R Rhapsody device icon appears in the Sources list.
3. Drag and drop tracks from My Library and the Music Guide, channels from My Channels and the Channel Guide, or playlists from Playlist Central and Playlists onto the device icon.

Other methods:

In Rhapsody mode, connect to your computer and drag and drop files from your computer to Removable Disk/Music directory or a second Removable Disk (microSD).

In PlaysForSure mode, drag and drop files from your computer to the Sansa e200R Rhapsody /Media/Music folder after selecting “NO ACTION” on initial connection to the computer.

In either mode, you can also select from a variety of music software programs to transfer/synchronize your files.

Note: For correct Album Art functionality, the art and associated music file may need to be located in the same folder.

Transfer Playlists

To transfer playlists to your Sansa e200R Rhapsody using the Best Buy Digital Music Store Media Player follow these steps:

1. Open the Best Buy Digital Music Store Media Player, and create a playlist or

open Playlist Central.

2. Connect the player to your computer. The Sansa e200R Rhapsody device icon appears in the Sources list.
3. Select the playlist(s) you wish to transfer to the player.
4. Drag and drop the playlist(s) from the Playlists area or Playlist Central onto the device icon.

You can set your Device Options to transfer the playlists of your choice automatically. See the Best Buy Digital Music Store Media Player Help for details.

Note: If you need further assistance with creating playlists in the Best Buy Digital Music Store Media Player open Help from the Help menu and select "Playlists" in the Table of Contents.

Delete Music Files

Using the Best Buy Digital Music Store:

1. Connect the player to your computer and open the Best Buy Digital Music Store. The Sansa e200R Rhapsody device icon appears in the Sources list.
2. Click on the Sansa e200R Rhapsody device icon to open the portable device view.
3. To delete tracks, open the Tracks tab, select tracks, and press the delete key or right-click and select Delete. To delete Rhapsody Channels or Playlists, open the Rhapsody Channels or Playlists tab and click Remove in the Action column.

Other methods:

In Rhapsody mode (without the Best Buy Digital Music Store), connect to your computer, go to My Computer, and delete the music file(s) in Removable Disk/Music directory or the second Removable Disk (microSD).

In PlaysForSure mode, connect to your computer, select NO ACTION, go to My Computer and delete the music file(s) in Sansa e200R Rhapsody/Media/Music folder after selecting “NO ACTION” on initial connection to the computer.

You can also select from a variety of music software programs to transfer/synchronize your files.

Synchronize Files

Using the Best Buy Digital Music Store:

1. Connect the player to your computer and open the Best Buy Digital Music Store. The Sansa e200R Rhapsody device icon appears in the Sources list.
2. Click on the Sansa e200R Rhapsody device icon to open the portable device view.
3. Click **Options** to open the “Device Options” dialog. Select Library Transfer and click **OK**.

Note: Selecting Library Transfer will synchronize the contents of your Library, Playlists, and My Channels. You must have the appropriate subscription for transfer of channels and subscription tracks.

Photo/Video Transfer-Sansa Media Converter

You will need to use Sansa Media Converter to transfer photos and video to your Sansa e200R Rhapsody. Insert your Install CD and select Sansa Media Converter to install it to your computer. Then you can load your personal photos and video onto your Sansa e200R Rhapsody by using Sansa Media Converter. Your Sansa e200R Rhapsody will only display photos in portrait orientation.

Note: Once you have your photos and video converted to the correct format, you can also use the Best Buy Digital Music Store Media Player to transfer your files. See the Best Buy Digital Music Store Media Player Help for details.

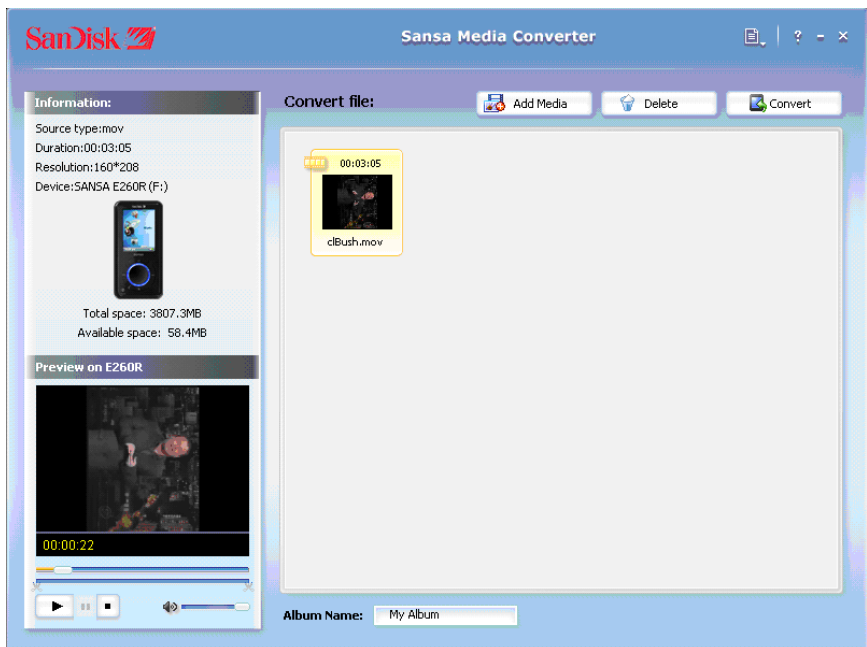

Supported Import media types

- Still Image Files: JPEG, TIFF, PNG, BMP, GIF.
- Video Files: AVI, MPEG-1 & MPEG-2 in MPEG, MPG, MPE or VOB (unprotected) formats. MPEG-4 in AVI format, DAT, ASF, QuickTime MOV, and WMV. Please Note: QuickTime 6.5 or higher and Windows Media Player 9 or 10.0 are required for QuickTime MOV file. Error message will appear if not installed.

Transfer Photos and Video

To transfer photos and video to your **Sansa e200R Rhapsody**:

1. Open Sansa Media Converter on your computer.
2. Connect **Sansa e200R Rhapsody** to the computer.



The detected **Sansa e200R Rhapsody** will list the available space and total space on the device. If more than one device is inserted, only the first device will be supported.

3. Add the media files to be converted  to browse for files or drag and drop files onto the display.

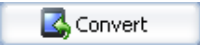
4. The Sansa Media Converter will place all files in My Album unless you type in a new Album Name at the bottom of the screen. Use this option to organize your files and slide shows.
5. Press  to start the conversion process. A status box will appear showing which file(s) are being converted.

Photos and Video cannot be transferred to the microSD card.

Do not move your photo or video files from the location the Sansa Media Converter places them.

See Safely removing your Sansa e200R Rhapsody from the Computer instructions below.

Delete Photos and Video

Your photos are stored in two locations on your Sansa e200R Rhapsody: My Album and Thumbnails.

Using Rhapsody mode:

1. To delete a photo in Rhapsody mode, connect your Sansa e200R Rhapsody to your computer and go to My Computer and delete the photo in Removable Disk/Photo/My Album and in Removable Disk/Photo/Thumbnails/My Album.
2. To delete a video in Rhapsody mode, go to My Computer and delete the video stored in Removable Disk/Video.

Using PlaysForSure mode:

1. To delete a photo in PlaysForSure mode, connect your Sansa to your computer and go to My Computer and delete the photo stored in Sansa e200R Rhapsody/Data/Photo/My Album and Sansa e200R Rhapsody/Data/Photo/Thumbnail/My Album
2. To delete a video in PlaysForSure mode go to My Computer and delete the video stored in Sansae200R/Data/Video.

The player database will refresh after deleting files when you disconnect from your computer.

Safely Removing Sansa e200R Rhapsody from the Computer

Disconnect Sansa e200R Rhapsody after you have completed charging, transferring, firmware upgrade, or synchronizing files.

Using the Best Buy Digital Music Store:

From the portable device view, click Disconnect.

OR

Right-click on the Sansa e200R Rhapsody icon in the Sources list and select Disconnect.



The device screen will show Disconnected.

Other methods:

In PlaysForSure mode, disconnect the USB cable.

Rhapsody mode (without the Best Buy Digital Music Store) requires some

additional steps to safely remove the **Sansa e200R Rhapsody**:

1. On your computer's task bar (usually bottom right corner of your computer screen), click on the Safely Remove Hardware icon  or Player icon .
2. Wait until "**Safe to Remove Hardware or Mass Storage Device**" message is displayed.
3. You can now disconnect the player from the computer.

Basic Usage

Power On

For initial power-up you must unlock the controls by moving the HOLD switch to the un-locked position (no orange color visible). Press the Power/Menu button once. The Thumbwheel will light up and the main menu will appear.

Using Thumbwheel

Turn the wheel **clockwise** to **scroll down** through menu items rapidly or increase the volume during playback.

Note: when you use the wheel the blue LED under the wheel should light automatically.

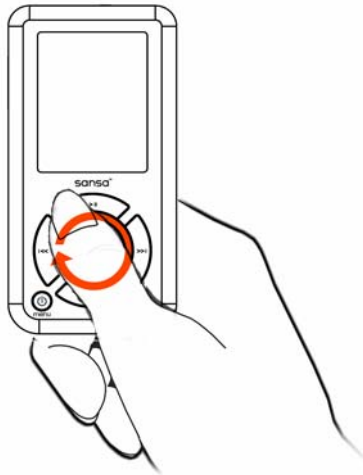

Turn the wheel counterclockwise to scroll up through menu items rapidly or decrease the volume during playback.

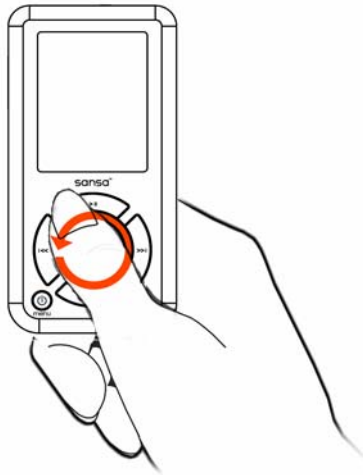

Main Menu



- Music
- Rhapsody Channels
- FM Radio

- Photo
- Settings
- Voice
- Video

Using Navigation Buttons

Use Navigation Buttons, described in “Getting Started,” to navigate though menus, play music, play video, browse photos and arrange files.

Using Submenu Button

When a submenu is available, the submenu icon  will display on the bottom left of the Sansa e200R Rhapsody screen. Press the Submenu button  to enter submenu.

Power Off

Press the Power/Menu button and hold for two seconds or until “**Goodbye**” is displayed. To prevent accidental power on, move the HOLD switch to the locked position.

Music Mode

▪ Music/Voice/FM Playback

1. To play music stored in the internal memory or microSD card, recorded FM or Voice recording, select **Music** in Main Menu.



2. Select **Artists, Albums, Songs, Genres, Playlists, Rhapsody Channels, Recordings** (FM/Voice), **My Top Rated**, or **Music Options**.

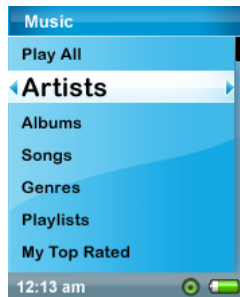

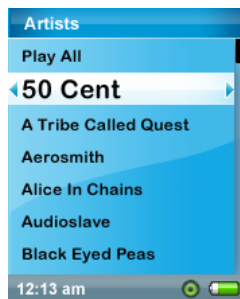

3. Highlight and Select the desired track or file to play. You can browse other areas of your player (music lists, settings, and photos) while your music is playing. You can return to the playback display at any time by tapping the Menu button twice.



Note: Use the center Select button to start play, and the Up/Pause/Resume button to Pause and Resume play.

▪ Setting Repeat Mode

1. In playback mode, press submenu .
2. Highlight and Select **Repeat**.
3. Select one of the following:
 - **Off:** No repeat of tracks
 - **Song:** Repeat the current track
 - **All:** Repeat all selected tracks
- Press submenu  again to exit Music Options.

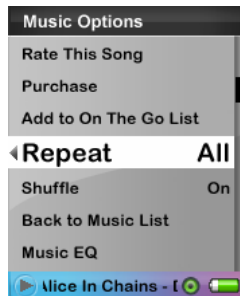

▪ Setting Shuffle Mode

1. In playback mode, press submenu .
2. Select the **Shuffle** item. To play songs in random order, set Shuffle to **On**.
3. Press |<< button for previous screen.

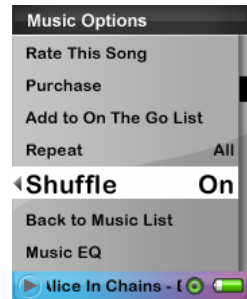

▪ Setting Music EQ

Sansa e200R Rhapsody provides various **EQ** modes, such as **Classical, Pop, and Rock**.

1. In playback mode, press submenu .
2. Scroll and Select the **Music EQ** item.
3. Scroll and Select a **Music EQ** mode.
4. Press the |<< button to return to Music Menu.

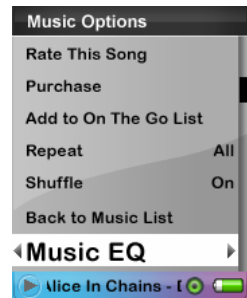

Add songs to Playlist

1. Play a song.



2. In playback mode, press submenu  .
3. Select **Add to On the Go List**.

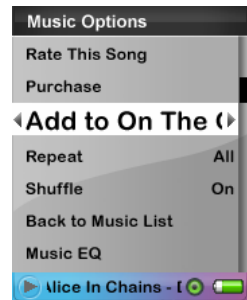

Remove Songs from Playlist

1. Select Playlist and play a song.
2. In playback mode, press submenu  .
3. Select the **Remove Song from On the Go List**.

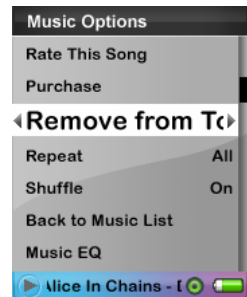

▪ Scan Through Song

1. In playback mode, press submenu .
2. Select the **Scan Through Song** item.
3. Use the Thumbwheel to scan the song.
 - 3 seconds of inactivity exits Scan mode.
4. Press the |<< button for previous menu.

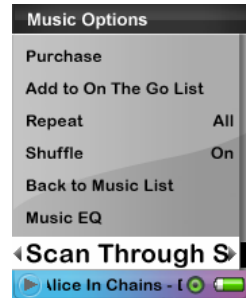

▪ Rate This Song

1. In playback mode, press submenu .
2. Select the **Rate This Song** item.

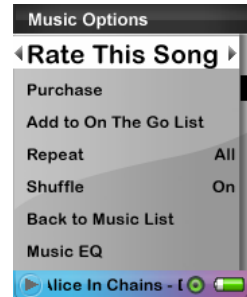

3. Use Thumbwheel to rate the song (1 to 5 stars) and press |<< button to exit back to Music Options menu. My Top Rated Songs can be viewed in MUSIC menu.



Note: Rhapsody Channels have an extra Ratings feature. See page 34 for details.

▪ View Artist Info

1. In Playback mode, press Select.
 - Press again to view EQ display, Album Art, Artist Info, and the next song. Not all songs have complete information.



▪ Rhapsody Channels

With the appropriate Best Buy Digital Music Store subscription, you can load Rhapsody Channels. The individual tracks will not appear as part of your Library. You can rate tracks as they play, add ones you like to your device Library and On the Go List, and even ban tracks you don't want to hear again. You can also mark tracks to be added to your Purchase Bin the next time you connect to the Best Buy Digital Music Store. Your ratings and purchases will transfer to your Best Buy Digital Music Store account when you connect your Sansa e200R Rhapsody to the computer and sign in.

• Add Track to Library

1. In playback mode, press submenu .
2. Select the **Add Track to Library** item.

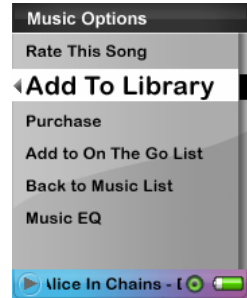

3. You will see a confirmation message “Song has been added to your Library.”

This song will now be a part of your device Library.

• Ban Track

1. In playback mode, press submenu .
2. Select the **Rate This Song** item.

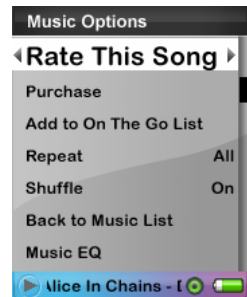

- Use Thumbwheel to scroll to the left and activate the red “ban” rating. Press |<< button to exit back to Music Options menu. Banned tracks will not play again, or be selected for your Rhapsody Channels when you sync.

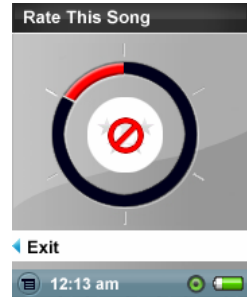

• Purchase

- In playback mode, press submenu .
- Select the **Purchase This Song** item.

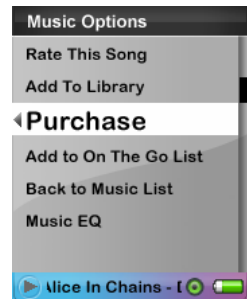

- When you connect the player to the Best Buy Digital Music Store, the track will be added to your Purchase Bin. You can decide if you would like to purchase it at your leisure.

Photo Mode

• Viewing Photos

Your Sansa e200R Rhapsody will only display photos in portrait orientation. You can crop your pictures with a photo editing software package prior to converting if you wish to display in full screen. The Sansa Media Converter converts the files and will transfer your photos to the player's internal memory.

1. To view photos stored on your Sansa e200R Rhapsody, select **Photo** in the main menu.

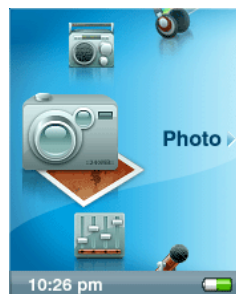

2. Select **Photo List** or **Thumbnails**.

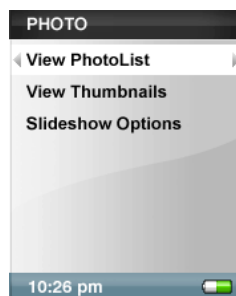

3. If you selected Thumbnails you will see the browser screen. Scroll through the photos and select the one of interest.
4. Use the |<< and >>| buttons to backup or advance to another photo.

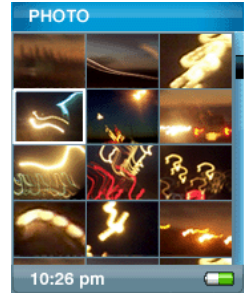

Slideshow

To play slideshow, Press Select button while viewing one of your slideshow photos. Press the Select button again to Pause the slide show, set your slideshow options below, like using the current song or your On the Go List for background music.

- **Slideshow Options**

1. Select **Slideshow Options** in **Photo** menu.

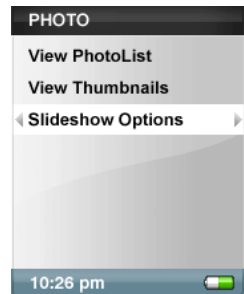

2. Personalize your **Slideshow Options**.

- Select the **Shuffle**: Select **On** for random order.
- Select **Loop**: Select **On** to set nonstop slideshow.
- Select the **Slide time** each photo view time.
- Select the **Music** for background music and select **Current Song** or **On the Go List** in the Music submenu.

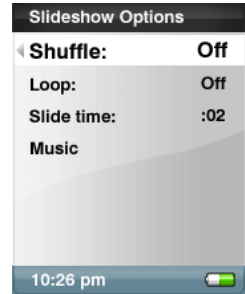

3. Press |<< to move to **Photo** menu.
4. Select **View Photo List**
5. Select the folder you desire for the Slideshow
6. Press select button when the list of photos is displayed
7. Press Select to start and pause the show.
8. Use Thumbwheel to control volume.
9. Press submenu  to go back to **View Photo List**.

Video Mode

Your Sansa e200R Rhapsody will only play videos that are loaded through the Sansa Media Converter. The Converter transfers the files to the player's internal memory.

▪ **Playing Video**

1. To play video select **Video** in Main Menu.



2. Select a **Video** to play.
3. Press Select to pause or resume the video.
4. Press and hold |<< and >>| buttons to advance and rewind the video.
5. Press submenu  to move to **Video** list

FM Radio Mode

▪ FM Radio

1. To listen to the radio broadcast, select **FM Radio** in Main Menu.

Note: To set your **FM Radio Region: USA, Japan, or World** select **Radio Options** under **Settings** main menu.



- When the radio frequency appears on the screen, press the << and >> buttons to adjust and search for the desired frequency, or select preset by pressing Select. For fast search hold down the << and >> buttons. You can browse other areas of the player, like Settings and Photos, while listening to the Radio.



• FM Preset

When Radio Mode is selected for the very first time, **Sansa e200R Rhapsody** will run an auto station search and store the searched stations as the preset favorite stations.

To set Radio options, press submenu  in **Radio** mode.

- Select **Add Preset** to save current frequency into presets.
- Select **Delete Preset** to remove current frequency from presets.
- Select **Delete All Preset** to clear all presets, and next time when you enter Radio Mode, **Sansa e200R Rhapsody** will search automatically.
- Select **View All Presets** to view all preset frequencies. The autoscan option will replace existing presets.

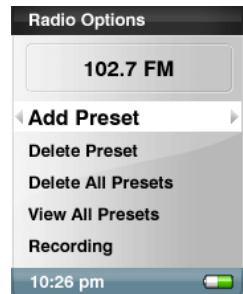

Recording Mode

• Voice Recording

Use your **Sansa e200R Rhapsody** for Microphone Recording. You can record your own voice, an interview, or a speech via internal microphone.

1. Press the **Record** button to start recording.
2. To pause recording, select **Pause** in Record mode.
3. On the Display, a recording file should be generated and placed under the folder of [/RECORD/VOICE/].
4. To stop recording, select **Stop** in record mode, and then a pop-up window will appear on the screen. Select **Yes** to save recording. The recording will be saved in the **RECORD** folder. The file list will appear.
5. Press |<< button to return to the Record, Listen, or Delete Recording Menu.

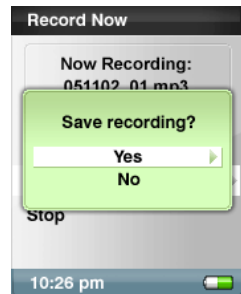
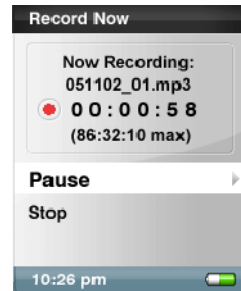

FM Radio Broadcast Recording

1. Select a radio broadcast channel that you want to record.
2. Press the **Record** button to start recording.
3. To pause recording, select **Pause** in Record mode.

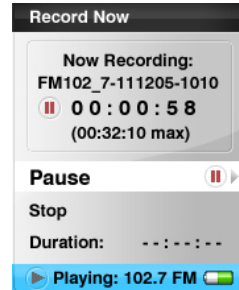

4. To set the duration of recording, select **Duration** and use the Thumbwheel to adjust the time. Press Select.

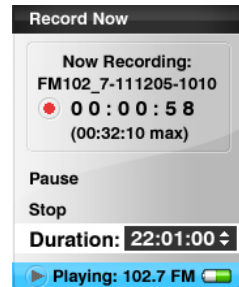

5. On the Display, a recording file should be generated and placed under the folder of [/RECORD/FM/].

6. To stop recording, select **Stop** and the **Save Recording?** window will appear. Select **Yes** to save recording. It will be saved in the **RECORD** folder. The file list will appear.

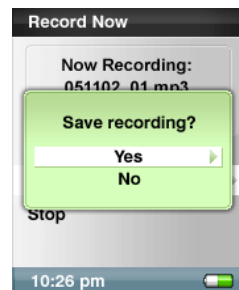

Settings Mode

You can personalize your Sansa e200R Rhapsody settings by selecting **Settings** in the main menu.

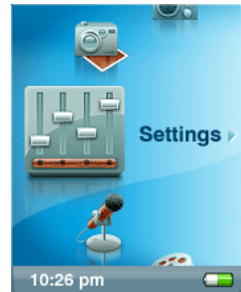

1. Scroll the Settings Menu and make a selection.

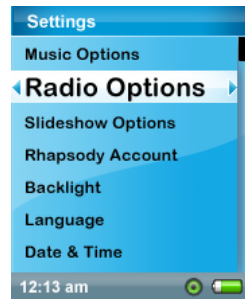

■ Set Music Options

1. Select **Settings** in Main Menu.
2. Select the **Music Options** item.
3. Select the Music Options setting that you want.
 - More information about Music Options is available on page 26.

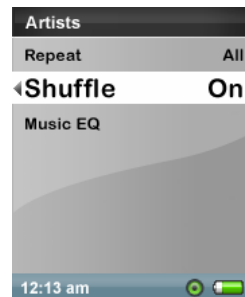

▪ Set Radio Options

1. Select **Settings** in Main Menu.
 2. Select the **Radio Options** item.
 3. Select the Radio Options setting that you want.
- More information about Radio Options is available on page 37.

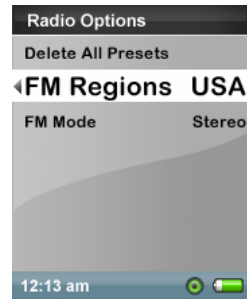

▪ Set Slideshow Options

1. Select **Settings** in Main Menu.
 2. Select the **Slideshow Options** item.
 3. Select the Slideshow Options setting that you want.
- More information about Slideshow Options is available on page 35.

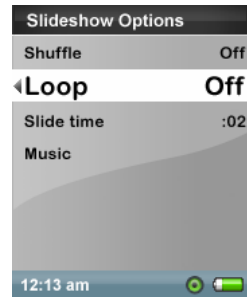

▪

▪ Best Buy Digital Music Store Account

View your Best Buy Digital Music Store account status and days remaining to renew your track licenses.

1. Select **Settings** in Main Menu.
2. Select the **Best Buy Digital Music Store Account** item.
3. You can read your Best Buy Digital Music Store Account status on the screen.

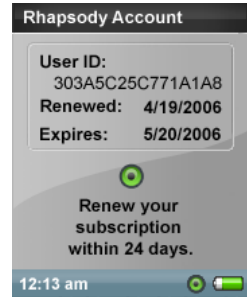

▪ Set Backlight

Backlight timer program can adjust the backlight setting from the default. (Default: turn off backlight after 2 seconds idle time.) Press any button to turn on the backlight.

1. Select **Settings** in Main Menu.
2. Select the **Backlight** item.
3. Select the Backlight **Off** setting that you want.

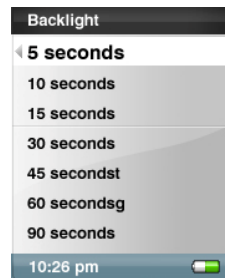

▪

▪ Set Language

1. Select **Settings** in Main Menu.
2. Select the **Language** item.
3. Select a language you want to use.



▪ Set Date and Time

1. Select **Settings** in Main Menu.
2. Select the **Time** item.
3. Set the time or date.
4. Press the |<< button for the previous screen.

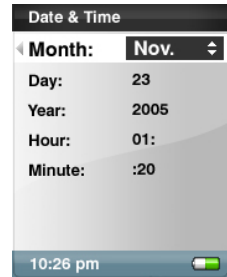

▪ Set Brightness

1. Select **Settings** in Main Menu.
2. Select the **Brightness** item.
3. Use the wheel to adjust the brightness setting, and then press Select to confirm and exit.

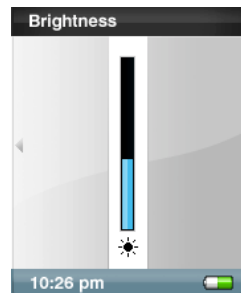

▪

▪ Set Volume

1. Select **Settings** in Main Menu.
2. Select the **Volume** item.
3. Select the Volume setting that you want.
 - **High**
 - **Normal**

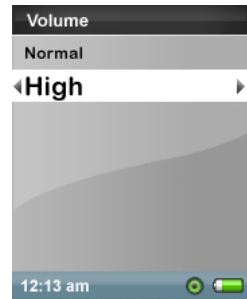

▪ Reset All

This option restores all settings to factory defaults.

THIS IS AN ADVANCED OPERATION. THIS OPERATION IS NOT RECOMMENDED FOR NORMAL USERS!

1. Select **Settings** in Main Menu.
2. Select the **Reset** item.
3. Select the **Yes** item.

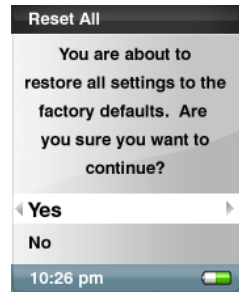

If your device freezes up press the Menu button and hold for 15 seconds.

This is like a power down of the device. Once you perform the reset, the adjustments you made during last operation will be gone.

▪ Info

The Info item displays your device information.

1. Select **Settings** in Main Menu.
2. Select the **Info** item.
3. You can read device information on the screen.

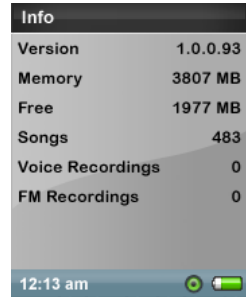

▪ Set Auto Shut-Off

1. Select **Settings** in Main Menu.
2. Select the **Auto Shut-Off** item.
3. Select the setting you want.



▪ Set USB Mode

1. Select the **Setting** item in Main Menu.
2. Select the **USB Mode** item.

You can select PlaysForSure or Rhapsody mode.

Note: *Rhapsody mode best supports the Best Buy Digital Music Store Media Player.*

▪ Set Record Button

1. Select **Settings** in Main Menu.
2. Select the **Record Button** item.
3. Select the Record Button setting that you want.
 - **Start Recording** begins recording when the button is pressed.
 - **Ask First** lets you confirm if you would like to record each time the button is pressed
 - **Off** disables the record button.

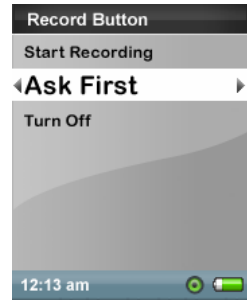

▪ Set Press and Hold

The Select button can be set to perform tasks when you press and hold it down while a track is playing.

1. Select **Settings** in Main Menu.
2. Select the **Press and Hold** item.
3. Select the Press and Hold setting that you want.
 - **Add to Library** adds the track to the device Library.
 - **Purchase Song** adds the song to the Purchase Bin the next time the device is connected to the Best Buy Digital Music Store.
 - **Rate Song** lets you rate the song.

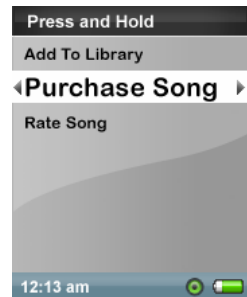

Tips, FAQ, and Troubleshooting

This chapter provides answers to common questions you may have.

Question: How do I reset my Sansa e200R Rhapsody?

Answer: Hold the Menu/Power button down for 15 seconds.

Question: How do I copy files to the Sansa e200R Rhapsody?

Answer: Follow these steps to transfer music files or files organized in directories to your Sansa e200R Rhapsody.

Using the Best Buy Digital Music Store:

1. Connect to your computer and select “Manage the device using Best Buy Digital Music Store.”
2. The Best Buy Digital Music Store opens and the Sansa e200R Rhapsody device icon appears in the Sources list.
3. Drag and drop tracks from My Library and the Music Guide, channels from My Channels and the Channel Guide, or playlists from Playlist Central and Playlists onto the device icon

Other methods:

In Rhapsody mode, connect to your computer and drag and drop files from your computer to Removable Disk/Music directory or a second Removable Disk (microSD).

In PlaysForSure mode, drag and drop files from your computer to the Sansa e200R Rhapsody /Media/Music folder after selecting “NO ACTION” on initial connection to the computer.

In either mode, you can also select from a variety of music software programs to transfer/synchronize your files.

Question: Why won't my album art display?

Answer: For correct Album Art functionality, the album art and associated music file may need to be located in the same folder. See preloaded content as an example.

Question: What music file formats does the Sansa e200R Rhapsody support?

Answer: The Sansa e200R Rhapsody supports MP3, AAC, RAX, WMA, and secure WMA audio files. Convert and transfer other file types automatically with the included Best Buy Digital Music Store Media Player.

Question: What is PlaysForSure mode?

Answer: PlaysForSure mode, also known as Media Transfer Protocol (MTP) is a protocol and accompanying set of drivers developed by Microsoft to connect portable devices to a Windows XP computer and synchronize digital media content between those devices and the computer.

Question: Some of my music files are on my player, but cannot be played. When I select them, another song begins to play. What is wrong?

Answer: You may not have purchased the rights to play the song on an additional device. To test this, try to play a song that you have copied from an older CD and converted to MP3 format. If you can play that song, but not the song that will not play, then you need to purchase the rights to play the song.

Question: Some of my songs are grayed out and cannot be played. What is

wrong?

Answer: Check your Best Buy Digital Music Store account status. These songs need to have their licenses renewed. Connect to the Best Buy Digital Music Store while signed in to a Best Buy Digital Music Store account to renew them. If you do not have the appropriate level of Best Buy Digital Music Store subscription, these songs will not play. Your pre-loaded content will eventually enter this state if you do not have an account.

Question: Why does my photo not display in full screen?

Answer: Try cropping your pictures to 128x64 with a photo editing software package prior to converting if you wish to display in full screen.

Question: Why should I update the firmware?

Answer: You should always update the player to the latest firmware to ensure that it functions correctly and has all the latest features. This is especially important if you are using a music subscription service.

Question: How do I access the player microSD card from my computer?

Answer: There is no need to change any settings. To access the card from the computer ensure the Sansa e200R Rhapsody is set to Rhapsody USB mode (in settings), open up My Computer, and your card should show up as a Removable Disk.

Question: How can I use non-supported file types with my player?

Answer: First you must convert the songs to a supported format. Then you can transfer the songs to the player. The Best Buy Digital Music Store Media Player will do this automatically, or you can use the Sansa Media Converter to convert

the files manually.

Question: In PlaysForSure mode, how do I drag files to the player?

Answer: As long as the files are a supported file type, they can be dragged into the Sansa e200R Rhapsody /Media/Music folder. An alternative is to switch the player to Rhapsody mode. Then the files can be dragged/copied to the Removable Disk/Music directory.

Question: Is the player compatible with podcasts?

Answer: As long as the podcasts are in a supported file format and an appropriate bit rate (32-320 kbps), then the player should be capable of playing the files.

Question: Why does my player say unknown artist/album?

Answer: Normally this is because the ID3 tags are missing information. In the Best Buy Digital Music Store, open My Library, right-click the song and select Edit Track Info to enter Artist, Album, Song Title, Track Number, Genre, and Year and other information.

OR

On the computer, right-click the song and choose Properties, then the Summary tab and click Advanced. Then you can input the data such as Artist, Album, Song Title, Track Number, Genre, and Year.

Service and Warranty Information

This chapter provides information about how to get support for your player and the terms of your warranty.

Getting Technical Support

Before you contact Technical Support, we encourage you to read the **Tips, FAQ, and Troubleshooting** section.

If you have questions about the use or features of your player, please call the SanDisk Technical Support Center at 1-866-SanDisk (1-866-726-3475), or fill out an on-line support request at <http://www.sandisk.com/retail/support.asp>.

If you have questions about our partner services, please call their Technical Support Center.

When you call or contact us for support, please include as much information as you can from your packaging material. This will allow us to help you more quickly.

Learn More

You also can visit us on the web at <http://www.sandisk.com> to learn more about your player as well as other SanDisk products.

1-YEAR SanDisk Limited Warranty

SanDisk warrants that this product will be free from material defects in design and manufacture and will substantially conform to the published specifications under normal use for one year from your date of purchase, subject to the conditions below. This warranty is provided to the original end user purchasing from SanDisk or an authorized reseller, and is not transferable. Proof of purchase may be required. SanDisk is not responsible for any failure or defect caused by any third party product or component, whether authorized or not. This warranty does not apply to any third party software provided with the product and you are responsible for all service and repair needed for such software. This warranty is void if the product is not used in accordance with the product instructions, or if it is damaged as a result of improper installation, misuse, unauthorized repair, modification or accident.

To obtain warranty service contact SanDisk at 1-866-SanDisk or send an email to: support@SanDisk.com. You must return the product in tamper resistant packaging, freight prepaid, as instructed by SanDisk. You must obtain a tracking confirmation number, which you may be required to provide to SanDisk. SanDisk will, at its option, repair or replace the product with new or refurbished product of equal or greater capacity and functionality, or refund the purchase price. The warranty duration on replaced product will be that time period remaining on the original product. THIS CONSTITUTES SANDISK'S ENTIRE LIABILITY AND YOUR EXCLUSIVE REMEDY FOR BREACH OF THIS WARRANTY.

SanDisk does not warrant, and shall not be responsible for, any lost data or

information contained in any product (including in any returned product), regardless of the cause of the loss. SanDisk's products are not warranted to operate without failure. SanDisk products should not be used in life support systems or other applications where failure could threaten injury or life. This warranty gives you specific legal rights, and you may also have other rights which vary by jurisdiction.

THE FOREGOING IS SANDISK'S SOLE WARRANTY. SANDISK DISCLAIMS ALL OTHER EXPRESS AND IMPLIED WARRANTIES TO THE FULLEST EXTENT PERMITTED BY APPLICABLE LAW. THE IMPLIED WARRANTIES OF MERCHANTABILITY AND FITNESS FOR A PARTICULAR PURPOSE ARE LIMITED TO THE DURATION OF THE EXPRESS WARRANTY. SOME JURISDICTIONS DO NOT ALLOW LIMITATION ON HOW LONG AN IMPLIED WARRANTY LASTS, SO THE ABOVE LIMITATION MAY NOT APPLY TO YOU. IN NO EVENT SHALL SANDISK OR ANY AFFILIATED OR SUBSIDIARY COMPANY BE LIABLE UNDER ANY CIRCUMSTANCES FOR ANY DIRECT, INDIRECT, OR CONSEQUENTIAL DAMAGES, ANY FINANCIAL LOSS OR ANY LOST DATA OR IMAGE, EVEN IF SANDISK HAS BEEN ADVISED OF THE POSSIBILITY OF SUCH DAMAGE. SOME JURISDICTIONS DO NOT ALLOW THE EXCLUSION OR LIMITATION OF INCIDENTAL OR CONSEQUENTIAL DAMAGES, SO THE ABOVE LIMITATION OR EXCLUSION MAY NOT APPLY TO YOU. IN NO EVENT WILL SANDISK'S LIABILITY EXCEED THE AMOUNT PAID BY YOU FOR THE PRODUCT.

SanDisk, the SanDisk logo, and Store Your World In Ours are trademarks of SanDisk Corporation, registered in the U.S. and other countries. Sansa,

TrustedFlash, and gruvi are trademarks of SanDisk Corporation. SanDisk is an authorized licensee of the microSD trademark. The PlaysForSure logo is a trademark or registered trademark of Microsoft Corporation in the United States and/or other countries. BEST BUY, and the BEST BUY logo are trademarks of Best Buy Enterprise Services, Inc. © 2006 Best Buy. Rhapsody and the Rhapsody logo are trademarks and registered trademarks of RealNetworks, Inc.

© 2006 SanDisk Corporation. All rights reserved.

Made in China

USER NOTICE

This product is protected by certain intellectual property rights of Microsoft Corporation. Use or distribution of such technology outside of this product is prohibited without a license from Microsoft or an authorized Microsoft subsidiary.

Content providers are using the digital rights management technology for Windows Media contained in this device (“WM-DRM”) to protect the integrity of their content (“Secure Content”) so that their intellectual property, including copyright, in such content is not misappropriated. This device uses WM-DRM software to play Secure Content (“WM-DRM Software”). If the security of the WM-DRM Software in this device has been compromised, owners of Secure Content (“Secure Content Owners”) may request that Microsoft revoke the WM-DRM Software’s rights to acquire new licenses to copy, display and/or play

Secure Content. Revocation does not alter the WM-DRM Software's ability to play unprotected content. A list of revoked WM-DRM Software is sent to your device whenever you download a license for Secure Content from the Internet or from a computer. Microsoft, may, in conjunction with such license, also download revocation lists onto your device on behalf of Secure Content Owners.

End User License Agreement

SANDISK CORPORATION

END USER LICENSE AGREEMENT

DO NOT USE OR LOAD THIS SOFTWARE until you have carefully read the following terms and conditions. The firmware, computer programs, device drivers, data or information ("Software") distributed or bundled with the product is provided to you under the terms and conditions of this End User License Agreement, and may be subject to additional terms and conditions in an agreement between you and SanDisk's third party licensors. By downloading, installing or using the accompanying Software, you agree to all of the terms of this End User License Agreement between SanDisk Corporation ("SanDisk," "we," or "us") and each person who downloads, installs or uses the Software ("you" or "your"). The Software is owned by SanDisk or by others including Portal Player Inc. ("Licensors") who permit SanDisk to distribute their Software. If you do not agree to the following terms and conditions, do not install or use the Software. The Software is protected by copyright laws and

international copyright treaties, as well as other intellectual property laws and treaties.

1. Software License. Subject to the terms and conditions contained herein, SanDisk grants to you a limited, non-exclusive, non-sub licensable, transferable in accordance with these terms, royalty-free right and license under SanDisk's intellectual property rights to use the Software in executable form for SanDisk products and services solely for your personal use on a single computer (the "License"). For each Software licensee, the Software can be "in use" on only one computer or hardware device at any given time. The Software is "in use" when it is either downloaded, copied, loaded into RAM or installed into the hard disk or other permanent memory of a computer or other hardware device. SanDisk and its Licensors retain all right, title and interest in and to the Software.
2. Restrictions. SanDisk or its Licensors retain all rights in the Software not expressly licensed to you. You may not modify, create derivative works (new versions) of, adapt or translate the Software. No source code is provided under this Agreement. You may not reverse engineer, disassemble, decompile, rent, or lease the Software, or re-create or discover the source code version of the Software. The Software contains proprietary and confidential information of SanDisk or its Licensors, which you agree not to discover or reveal to others. Any and all permitted copies of the Software that you make or distribute must be unmodified, must contain all of the original Software's

proprietary notices, and must include or be accompanied by this Agreement. You may not separate the Software into component parts for sublicense, distribution or transfer to a third party. You may not embed the Software within any other software product or modify the Software in whole or in part in any manner.

3. DISCLAIMER OF WARRANTIES. TO THE MAXIMUM EXTENT PERMITTED BY APPLICABLE LAW, THE SOFTWARE IS PROVIDED “AS IS” AND “AS AVAILABLE” WITH NO WARRANTIES. NEITHER SANDISK NOR ITS LICENSORS MAKE ANY REPRESENTATION OR WARRANTY, STATUTORY OR OTHERWISE, IN LAW OR FROM THE COURSE OF DEALING OR USAGE OF TRADE, EXPRESS OR IMPLIED, INCLUDING WITHOUT LIMITATION ANY WARRANTIES OF MERCHANTABILITY, FITNESS FOR A PARTICULAR PURPOSE, NON-INTERFERENCE, OR NON-INFRINGEMENT OF ANY THIRD PARTY INTELLECTUAL PROPERTY RIGHTS, OR EQUIVALENTS UNDER THE LAWS OF ANY JURISDICTION. YOU ASSUME THE ENTIRE RISK AS TO THE QUALITY AND PERFORMANCE OF THE SOFTWARE. SHOULD THE SOFTWARE PROVE DEFECTIVE, YOU, AND NOT SANDISK, ITS LICENSORS OR RESELLERS, ASSUME THE ENTIRE COST OF NECESSARY SERVICING, REPAIR, OR CORRECTION.
4. LIMITATION OF LIABILITY. IN NO EVENT WILL

SANDISK OR ITS LICENSORS, OR THEIR RESPECTIVE DIRECTORS, OFFICERS, EMPLOYEES, CONSULTANTS, LICENSORS, LICENSEES OR AFFILIATES, BE LIABLE FOR ANY INDIRECT, INCIDENTAL, SPECIAL, CONSEQUENTIAL, OR EXEMPLARY DAMAGES, ARISING OUT OF OR IN CONNECTION WITH THE DOWNLOAD, USE OR PERFORMANCE OR NON-PERFORMANCE OF THE SOFTWARE. THE FOREGOING LIMITATIONS OF LIABILITY SHALL APPLY NOTWITHSTANDING ANY FAILURE OF ANY REMEDY PROVIDED FOR HEREUNDER IN ITS ESSENTIAL PURPOSE. IN NO EVENT WILL SANDISK'S OR ITS LICENSORS' TOTAL LIABILITY TO YOU EXCEED THE AMOUNT YOU PAID TO US FOR THE USE OF THE SOFTWARE.

5. The Software is provided with "RESTRICTED RIGHTS." Use, duplication or disclosure by the Government is subject to restrictions as set forth in FAR 52.227-14 and DFARS 252.227-7013 et seq. Use of the Software by the Government constitutes acknowledgement of SanDisk's proprietary rights therein. Contractor or Manufacturer is SanDisk Corporation, 140 Caspian Court, Sunnyvale, CA 94089.
6. Termination. We may terminate this Agreement and the license if you violate this Agreement at any time. Upon termination of this Agreement, you must delete or destroy all copies of the Software.
7. High Risk Activities. The Software is not fault-tolerant and is

not designed or intended for use in hazardous environments requiring fail-safe performance, or any other application in which the failure of the Software could lead directly to death, personal injury, or severe physical or property damage (collectively, “High Risk Activities”). SANDISK DISCLAIMS ANY EXPRESS OR IMPLIED WARRANTY OF FITNESS FOR HIGH RISK ACTIVITIES AND SHALL NOT BE LIABLE FOR ANY LIABILITIES OR DAMAGES ARISING FROM SUCH USE.

8. General. This Agreement contains the entire understanding between the parties with respect to your use of the Software. If any part of this Agreement is found void and unenforceable, it will not affect the validity of the balance of this Agreement, which shall remain valid and enforceable according to its terms. This Agreement is governed by and construed under the laws of the State of California and the Federal laws of the United States of America without regard to conflicts of laws provisions thereof. The U.N. Convention on Contracts for the International Sale of Goods shall not apply to this Agreement. Any action or proceeding arising from or relating to this Agreement shall be adjudicated in the state or federal courts of Santa Clara County, California, and the parties hereby agree to the exclusive jurisdiction and venue of such courts. You will not remove or export from the United States or reexport from anywhere any part of the Software or any direct product thereof to any country in violation of U.S. Export Administration Regulations, or a successor thereto, or otherwise except in

compliance with and with all licenses and approvals required under applicable export laws and regulations including, without limitation, those of the U.S. Department of Commerce. Any waivers or amendments of this Agreement shall be effective only if made in writing and signed by an authorized representative of each party. The provisions of Sections 3, 4, 5, 6, 7 and 8 shall survive the termination or expiration of this Agreement.

FCC Regulation

This device complies with part 15 of the FCC Rules.

Operation is subject to the following two conditions:

1. This device may not cause harmful interference, and
2. This device must accept any interference received, including interference that may cause undesired operation.

This equipment has been tested and found to comply with the limits for a Class B digital device, pursuant to Part 15 of the FCC Rules. These limits are designed to provide reasonable protection against harmful interference in a residential installation. This equipment generates, uses, and can radiate radio frequency energy and, if not installed and used in accordance with the instructions,

may cause harmful interference to radio communications. However, there is no guarantee that interference will not occur in a particular installation. If this equipment does cause interference to radio or television reception, which can be determined by turning the equipment off and then on, the user is encouraged to try to correct the interference by one or more of the following measures:

1. Increase the separation between the equipment and receiver.
2. Correct the equipment to a different outlet so that the equipment and receiver are on different branch circuits.
3. Consult the dealer or an experienced radio / TV technician for help.

Important - Safe Hearing Level Info

IMPORTANT INFORMATION

YOU MUST READ THIS BEFORE USING YOUR SANSA e200R
RHAPSODY MP3 PLAYER

Congratulations on the purchase of your Sansa™ media player!

Your media player is equipped with a variety of features. To help you maximize your listening pleasure, SanDisk would like to advise you that it is important to use your headphones with your media player at a safe hearing level.

- Exposure or repeated exposure for an extended period of time to music and other sounds that are too loud can cause damage to your hearing resulting in temporary or even permanent “noise induced hearing loss”.
- Symptoms of hearing loss increase gradually with prolonged exposure at high levels of loudness.

Initially, you may not even be aware of the loss unless detected with a hearing test.

HEARING LEVELS

To help you understand what may be considered a safe hearing level, the following examples are included for your reference.

Examples of Typical Approximate Sound level

Sound Levels in Decibels (dB)*

Refrigerator humming 40

Normal conversation 60

City traffic 80

Motorcycles and lawnmowers 90#

Rock concerts 110-120#

Firearms 120-140#

* dB -A decibel (dB) is a unit of relative measurement of the strength of sound wave. In decibels (dB), a measured signal level doubles with every additional 3 dB.

- These sound decibel levels are considered harmful under extended exposure.

Information courtesy of the National Institute of Deafness & Other Communication Disorders (NIDCD)

<http://www.nidcd.nih.gov/health/hearing/noise.asp>

FOR YOUR SAFETY!

- Your hearing may adapt to higher volumes of sound. In order to prevent any harmful impact to your hearing, you must control the sound emanating from your headphones and set the media player volume to a low setting where you can hear it clearly and comfortably.
- Studies, including one from NIDCD indicate that sounds of less than 80 decibels, even after long exposure, are unlikely to cause a hearing loss.
- Listen to your media player at such a level that you can still hear conversation and other people in your environment without shouting when you attempt to converse.
- It can also be dangerous to play your music with headphones/earphones at high volume while walking, or engaged in other activities. You should exercise extreme caution and discontinue use in potentially hazardous situations.
- Do not use headphones/earphones while driving, cycling, or operating any motorized vehicle. This may create a traffic hazard and may be illegal in some areas.

Free Manuals Download Website

<http://myh66.com>

<http://usermanuals.us>

<http://www.somanuals.com>

<http://www.4manuals.cc>

<http://www.manual-lib.com>

<http://www.404manual.com>

<http://www.luxmanual.com>

<http://aubethermostatmanual.com>

Golf course search by state

<http://golfingnear.com>

Email search by domain

<http://emailbydomain.com>

Auto manuals search

<http://auto.somanuals.com>

TV manuals search

<http://tv.somanuals.com>