

SHARP



1-BIT DIGITAL AUDIO SYSTEM

SD-CX1H

OPERATION MANUAL



Special Notes

NOTES FOR USERS IN THE U.K. AND IRELAND

The mains lead of this product is fitted with a non-rewireable (moulded) plug incorporating a 3A fuse. Should the fuse need to be replaced, a BSI or ASTA approved BS 1362 fuse marked ♡ or ♢ and of the same rating as above, which is also indicated on the pin face of the plug must be used.

Always refit the fuse cover after replacing the fuse. Never use the plug without the fuse cover fitted.

In the unlikely event of the socket outlet in your home not being compatible with the plug supplied, cut-off the mains plug and fit an appropriate type.

DANGER:

The fuse from the cut-off plug should be removed and the cut-off plug destroyed immediately and disposed of in a safe manner.

Under no circumstances should the cut-off plug be inserted elsewhere into a 13A socket outlet as a serious electric shock may occur.

To fit an appropriate plug to the mains lead, follow the instructions below:

IMPORTANT:

The wires in the mains lead are coloured in accordance with the following code:

Blue : Neutral
Brown : Live

As the colours of the wires in the mains lead of this product may not correspond with the coloured markings identifying the terminals in your plug, proceed as follows:

- The wire which is coloured blue must be connected to the plug terminal which is marked N or coloured black.
- The wire which is coloured brown must be connected to the plug terminal which is marked L or coloured red.

Ensure that neither the brown nor the blue wire is connected to the earth terminal in your three pin plug.

Before replacing the plug cover, make sure that:

- If the new fitted plug contains a fuse, its value is the same as that removed from the cut-off plug.
- The cord grip is clamped over the sheath of the mains lead and not simply over the lead wires.

IF YOU HAVE ANY DOUBT, CONSULT A QUALIFIED ELECTRICIAN.

SERVICE INFORMATION

In the unlikely event of your equipment requiring repair, please contact the dealer or supplier from whom it was purchased. Where this is not possible, please visit our web-site www.sharp.co.uk/support. Customers without internet access may telephone 08705 274277 during office hours (or (01) 676 0648 if telephoning from Ireland). Please note; all calls will be charged at local rate.

Certain replacement parts and accessories may be obtained from our main parts distributor.

WILLOW VALE ELECTRONICS LTD.
0121 766 5414

In the unlikely event of this equipment requiring repair during the guarantee period, you will need to provide proof of the date of purchase to the repairing company.

Please keep your invoice or receipt, which is supplied at the time of purchase.

■ WARNING

- When the ON/STAND-BY button is set at STAND-BY position, mains voltage is still present inside the unit. When the ON/STAND-BY button is set at STAND-BY position and the clock is displayed, the unit may be brought into operation by the timer mode or remote control.
- This unit contains no user serviceable parts. Never remove covers unless qualified to do so. This unit contains dangerous voltages, always remove mains plug from the socket before any service operation and when not in use for a long period.
- To prevent fire or shock hazard, do not expose this appliance to dripping or splashing. No objects filled with liquids, such as vases, shall be placed on the apparatus.

■ CAUTION

- Use of controls, adjustments or performance of procedures other than those specified herein may result in hazardous radiation exposure.
- As the laser beam used in this compact disc player is harmful to the eyes, do not attempt to disassemble the cabinet. Refer servicing to qualified personnel only.

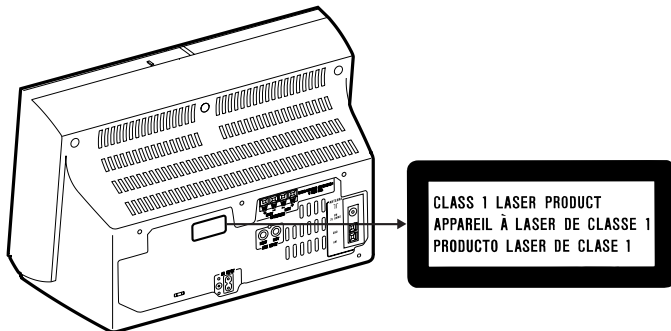

■ NOTES

- Recording and playback of any material may require consent, which SHARP is unable to give. Please refer particularly to the provisions of the Copyright Act 1956, the Dramatic and Musical Performers Protection Act 1958, the Performers Protection Acts 1963 and 1972 and to any subsequent statutory enactments and orders.
- This equipment complies with the requirements of Directives 89/336/EEC and 73/23/EEC as amended by 93/68/EEC.
- US and foreign patents licensed from Dolby Laboratories.
- The letters in brackets contained in the model number indicate the colour of the product only. Operation and specifications are unaffected.
- SD-CX1H 1-Bit Digital Audio System of SD-CX1H (main unit) and CP-CX1H (speaker system).

If you require any advice or assistance regarding your Sharp product, please visit our web-site www.sharp.co.uk/support. Customers without internet access may telephone 08705 274277 during office hours (or (01) 676 0648 if telephoning from Ireland).

Introduction

Thank you for purchasing this SHARP product. To obtain the best performance from this product, please read this manual carefully. It will guide you in operating your SHARP product.

Contents

	Page		Page
■ Important Instruction		■ Radio	
Special Notes	2 - 3	Listening to the Radio	26 - 27
■ General Information		■ RDS Radio	
Precautions	5 - 6	Using the Radio Data System (RDS)	28 - 34
Accessories	6	■ MD Recording	
Controls and Indicators	7 - 10	Before Recording to a MiniDisc	35
■ Preparation for Use		Recording to a MiniDisc from a CD	36 - 39
Remote Control	11	Recording to a MiniDisc from the Radio	40
System Connections	12 - 14	Checking Displays	41
■ Basic Operation		■ MD Editing	
General Control	15	Titling a MiniDisc	42 - 44
Sound Control	16	Editing a Recorded MiniDisc	44 - 48
Setting the Clock	17	■ Advanced Features	
■ CD Playback		Timer and Sleep Operation	49 - 53
Listening to a CD	18 - 20	Enhancing Your Stereo System	54 - 55
■ MD Playback		■ References	
Listening to a MiniDisc	21 - 23	What is a MiniDisc?	56
■ Advanced CD/MD Playback		MiniDisc System Limitations	56
Direct Play	24	Error Messages	57
Repeat or Random Play	24	Troubleshooting Chart	58 - 59
Programmed Play	25	Maintenance	60
		Specifications	60 - 61
		TERMS OF GUARANTEE Back cover	

Precautions

■ General

- Please ensure that the equipment is positioned in a well-ventilated area and ensure that there is at least 10 cm (4") of free space along the sides, top and back of the equipment.

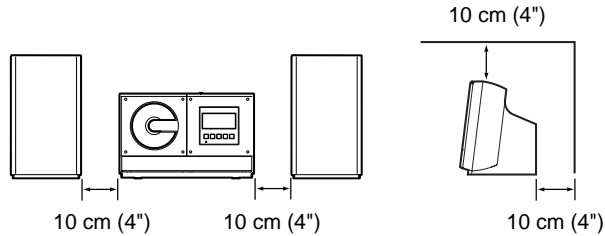

- Use the unit on a firm, level surface free from vibration.

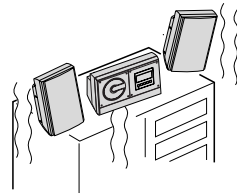

- Keep the unit away from direct sunlight, strong magnetic fields, excessive dust, humidity and electronic/electrical equipment (home computers, facsimiles, etc.) which generates electrical noise.

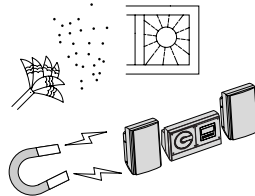

- Do not place anything on top of the unit.
- Do not expose the unit to moisture, to temperatures higher than 60°C (140°F) or to extremely low temperatures.
- If your system does not work properly, disconnect the AC power lead from the wall socket. Plug the AC power lead back in, and then turn on your system.

- In case of an electrical storm, unplug the unit for safety.

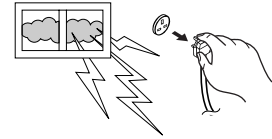

- Hold the AC power plug by the head when removing it from the wall socket, as pulling the lead can damage internal wires.

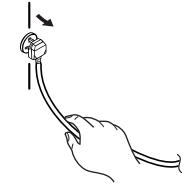

- Do not remove the outer cover, as this may result in electric shock. Refer internal service to your local SHARP service facility.

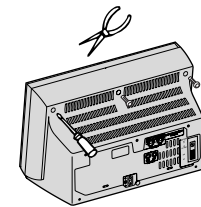

- The ventilation should not be impeded by covering the ventilation openings with items, such as newspapers, tablecloths, curtains, etc.



- No naked flame sources, such as lighted candles, should be placed on the apparatus.
- Attention should be drawn to the environmental aspects of battery disposal.
- The apparatus is designed for use in moderate climate.
- This unit should only be used within the range of 5°C - 35°C (41°F - 95°F).

Precautions (continued)

Warning:

- The voltage used must be the same as that specified on this unit. Using this product with a higher voltage other than that which is specified is dangerous and may result in a fire or other type of accident causing damage. SHARP will not be held responsible for any damage resulting from use of this unit with a voltage other than that which is specified.
- CD players use a laser pickup which can damage the eyes if viewed directly. Do not look at the pickup, and do not touch the pickup directly.
- This product is equipped with a cooling fan on its back for better heat radiation.

■ Volume control

The sound level at a given volume setting depends on speaker efficiency, location, and various other factors. It is advisable to avoid exposure to high volume levels, which occurs whilst turning the unit on with the volume control setting up high, or whilst continually listening at high volumes.

■ Care of compact discs

Compact discs are fairly resistant to damage, however mistracking can occur due to an accumulation of dirt on the disc surface. Follow the guidelines below for maximum enjoyment from your CD collection and player.

- Do not write on either side of the disc, particularly the non-label side from which signals are read. Do not mark this surface.
- Keep your discs away from direct sunlight, heat, and excessive moisture.
- Always hold the CDs by the edges. Fingerprints, dirt, or water on the CDs can cause noise or mistracking. If a CD is dirty or does not play properly, clean it with a soft, dry cloth, wiping straight out from the centre, along the radius.

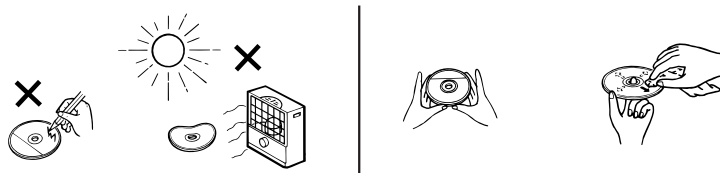

Accessories

Please confirm that the following accessories are included.

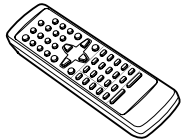
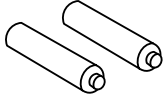
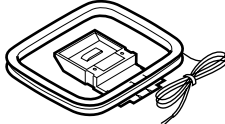
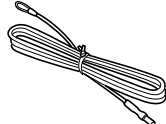
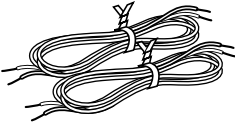
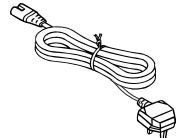
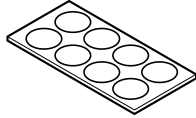
 <p>Remote control × 1</p>	 <p>"AA" size batteries (UM/SUM-3, R6, HP-7 or similar) × 2</p>
 <p>AM loop aerial × 1</p>	 <p>FM aerial × 1</p>
 <p>Speaker wire × 2</p>	 <p>AC power lead × 1</p>
 <p>Non-slip sheet for speakers × 8</p>	

Note:

Only the above accessories are included.

Controls and Indicators

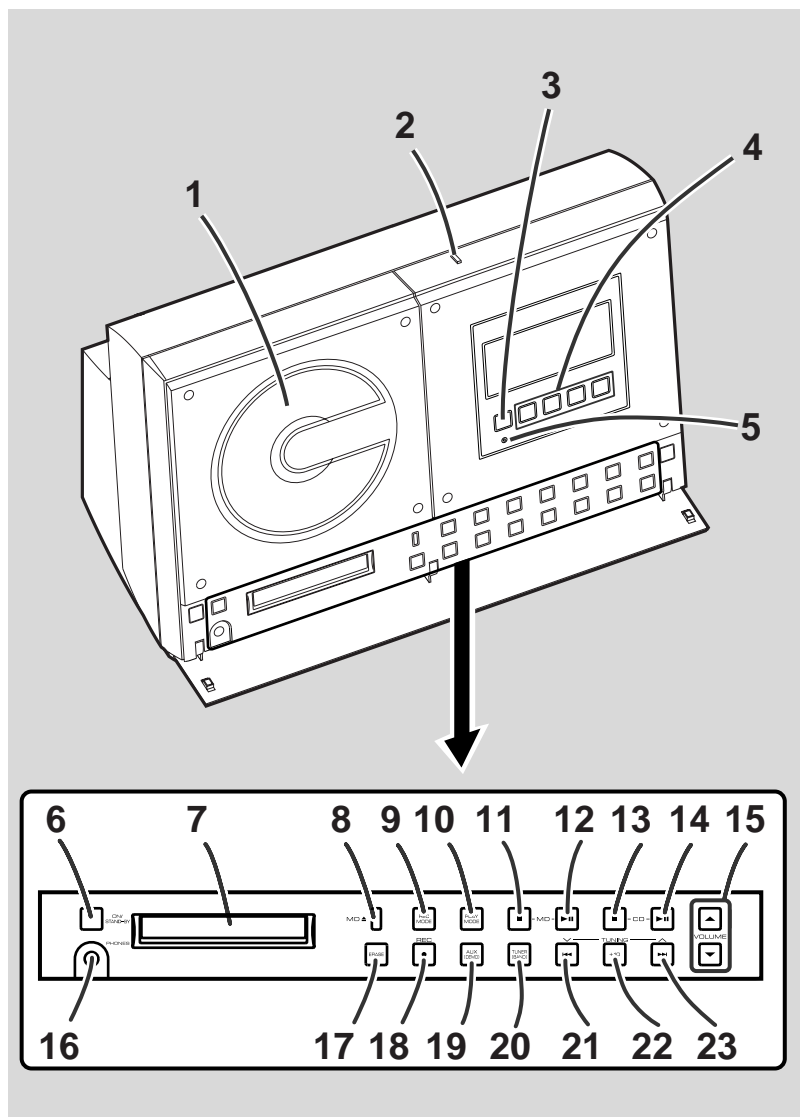

■ Front panel

	Reference page
1. CD Cover	18
2. CD Cover Open/Close Button	18
3. Remote Sensor	11
4. Function Indicator	
5. Timer Indicator	50
6. On/Stand-by Button	18
7. MD Compartment	21
8. MD Eject Button	22
9. MD Record Mode Button	39
10. CD/MD Play Mode Select Button	24
11. MD Stop Button	22
12. MD Play/Pause Button	21
13. CD Stop Button	18
14. CD Play/Pause Button	18
15. Volume Up or Down Button	16
16. Headphone Socket	54
17. Erase Button	48
18. MD Record Button	39
19. Auxiliary/Demo Button	14, 55
20. Tuner (Band) Button	26
21. CD/MD Fast Reverse, Tuning Down Button	19, 22, 26
22. MD +10 Track Up Button	22
23. CD/MD Fast Forward, Tuning Up Button	19, 22, 26

Controls and Indicators (continued)

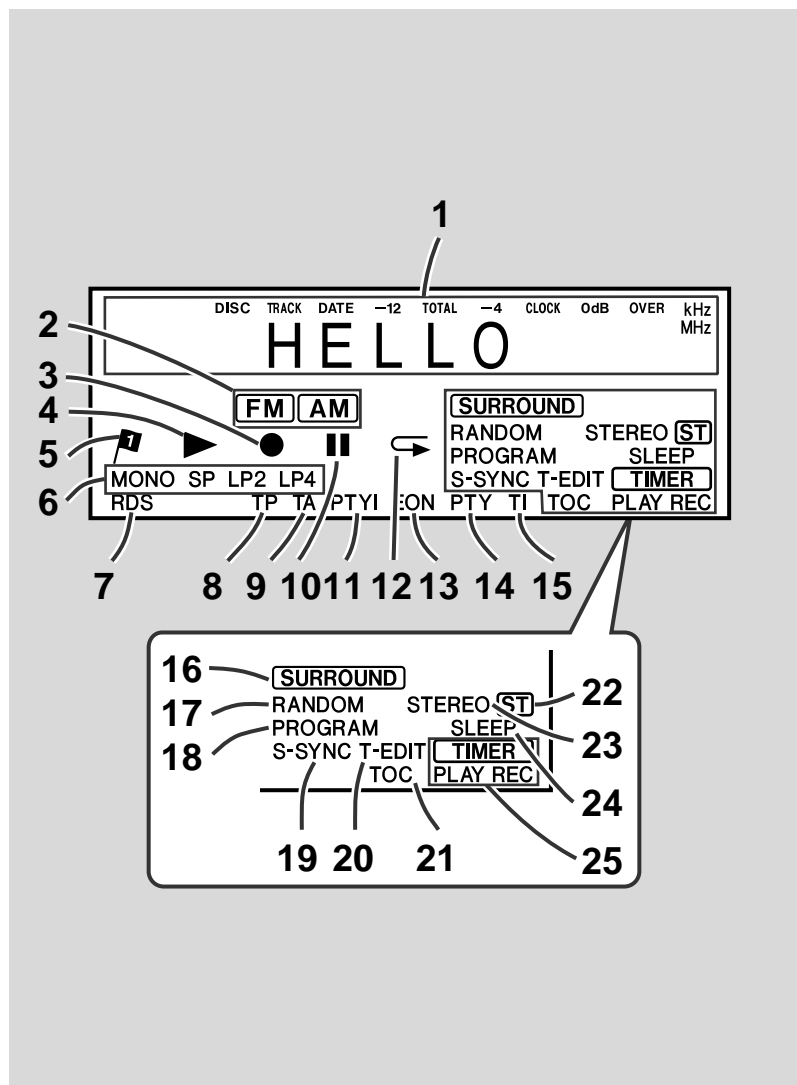

■ Multi-function LCD display

1. Level Meter/Character Information/Frequency Indicator
2. Band Selector Indicator
3. Record Indicator
4. CD/MD Play Indicator
5. Top Position Indicator
6. Record Mode Indicator
7. RDS Indicator
8. Traffic Programme Indicator
9. Traffic Announcement Indicator
10. MD Record Pause Indicator
11. Dynamic PTY Indicator
12. CD/MD Repeat Indicator
13. EON Indicator
14. Programme Type Indicator
15. Traffic Information Indicator
16. Surround Indicator
17. Random Play Indicator
18. Programme Play Indicator
19. Sound Synchronised Recording Indicator
20. Track Edit Indicator
21. TOC Indicator
22. FM Stereo Indicator
23. FM Stereo Mode Indicator
24. Sleep Indicator
25. Timer Play/Recording Indicator

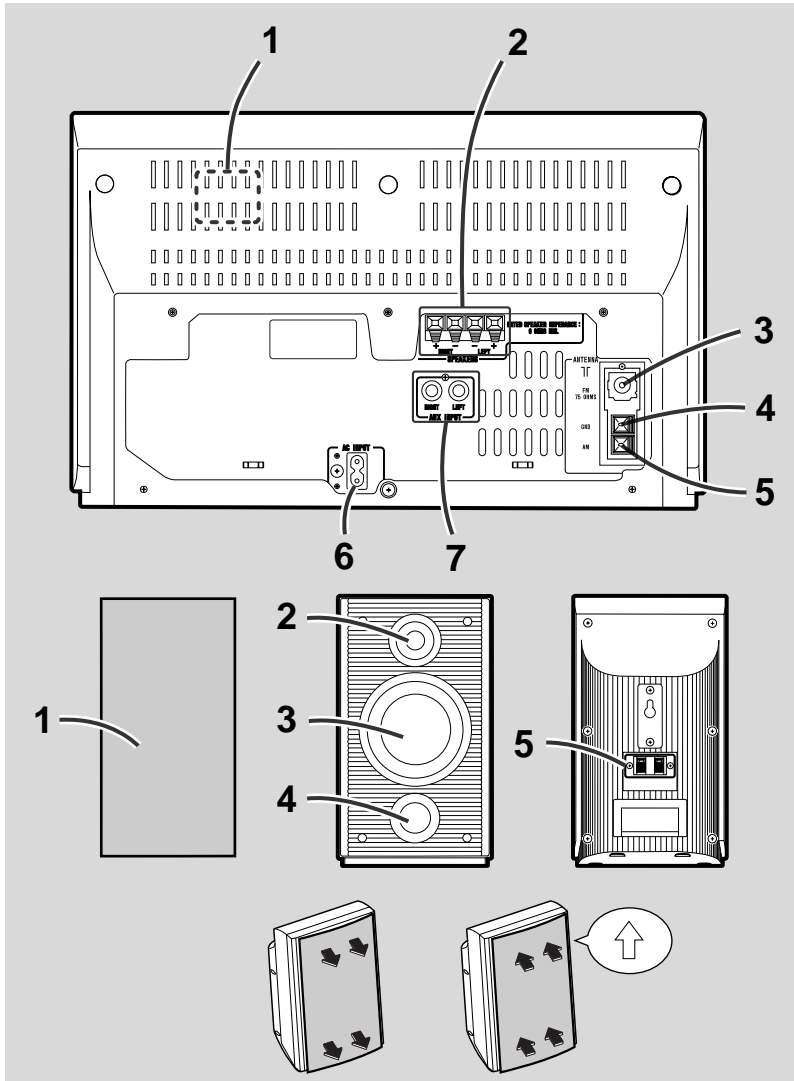

■ Rear panel

Reference page

1. Cooling Fan	13
2. Speaker Terminals	13
3. FM 75 Ohms Aerial Socket	13
4. Aerial Earth Terminal	13
5. AM Loop Aerial Socket	13
6. AC Input Socket	12
7. Auxiliary Input Sockets	54

■ Speaker system

1. Speaker Grille	
2. Tweeter	
3. Woofer	
4. Bass Reflex Duct	
5. Speaker Terminals	13

Placing the speaker system:

There is no distinction between the right and the left speakers.

Speaker grilles are removable:

Make sure nothing comes into contact with the speaker diaphragms when you remove the speaker grilles.

The arrow on the back of the net must face upward.

Controls and Indicators (continued)

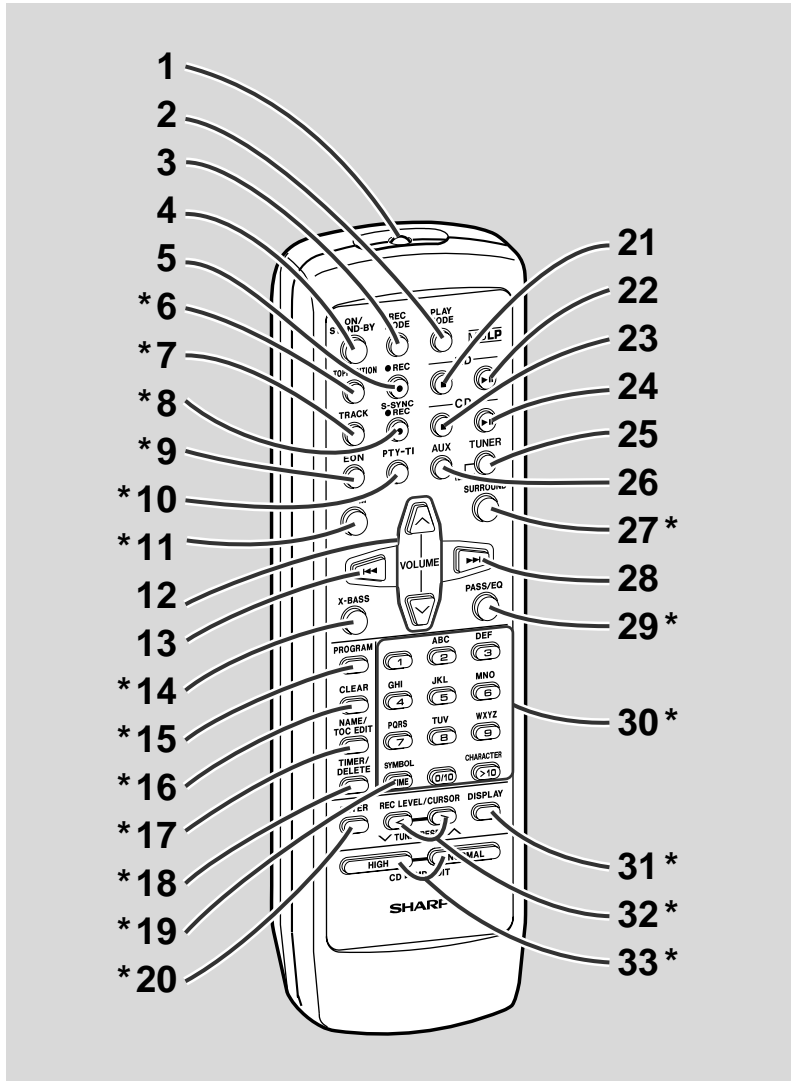

■ Remote control

Reference page

1. Remote Control Transmitter	11
2. CD/MD Play Mode Select Button	
3. MD Record Mode Button	
4. On/Stand-by Button	
5. MD Record Button	
6. Top Position Button	39
7. Track Edit Button	38
8. Sound Synchronise Record Button	55
9. RDS EON Button	28, 32
10. RDS Programme Type/Traffic Information Search Button ...	28, 31
11. RDS ASPM (Auto Station Programme Memory) Button	28
12. Volume Up or Down Button	
13. CD/MD Fast Reverse, Tuning Down Button	
14. Extra Bass Button	16
15. CD/MD Programme Button	25
16. Clear Button	25
17. Name/TOC-Edit Button	42
18. Timer/Delete Button	17, 49
19. Time Button	20, 23
20. Enter Button	17
21. MD Stop Button	
22. MD Play/Pause Button	
23. CD Stop Button	
24. CD Play/Pause Button	
25. Tuner (Band) Button	
26. Auxiliary Button	
27. Surround Button	16
28. CD/MD Fast Forward, Tuning Up Button	
29. Preset Equalizer Button	16
30. Character Input/CD, MD, Tuner Direct Buttons	24, 42
31. Display Button	20, 23
32. Recording Level/Cursor/Tuner Preset Button	26, 39, 42
33. CD/MD Edit Button	36

Buttons with "*" mark in the illustration can be operated on the remote control only. Other buttons can be operated both the main unit and the remote control.

Remote Control

■ Battery installation

- 1 Open the battery cover.
- 2 Insert the supplied batteries according to the direction indicated in the battery compartment.
 - When inserting or removing the batteries, push them towards the ⊖ battery terminals.
- 3 Close the battery cover.

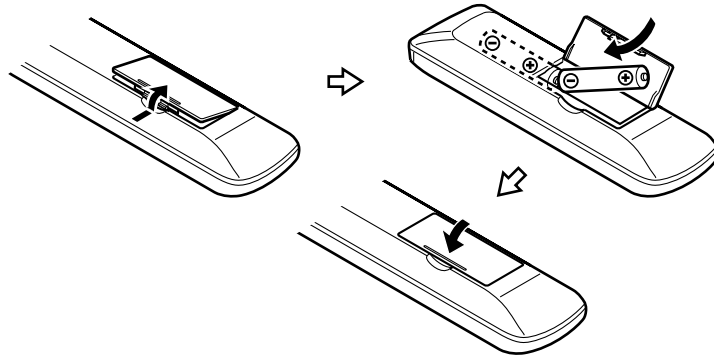

Precautions for battery use:

- Replace all old batteries with new ones at the same time.
- Do not mix old and new batteries.
- Remove the batteries if the unit will not be used for long periods of time. This will prevent potential damage due to battery leakage.

Caution:

- Do not use rechargeable batteries (nickel-cadmium battery, etc.).
- Installing the batteries incorrectly may cause the unit to malfunction.

Notes concerning use:

- Replace the batteries if the operating distance is reduced or if the operation becomes erratic. Purchase 2 "AA" size batteries (UM/SUM-3, R6, HP-7 or similar).
- Periodically clean the transmitter on the remote control and the sensor on the stereo system with a soft cloth.
- Exposing the sensor on the stereo system to strong light may interfere with operation. Change the lighting or the direction of the stereo system.
- Keep the remote control away from moisture, heat, shock, and vibrations.

■ Test of the remote control

Check the remote control after checking all connections have been made correctly. (See pages 12 - 14.)

Face the remote control directly to the remote sensor on the unit.

The remote control can be used within the range shown below:

Press the ON/STAND-BY button. Does the power turn on? Now, you can enjoy the music.

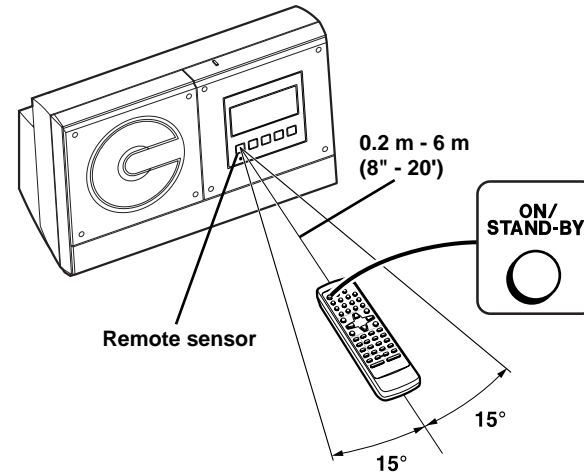

System Connections

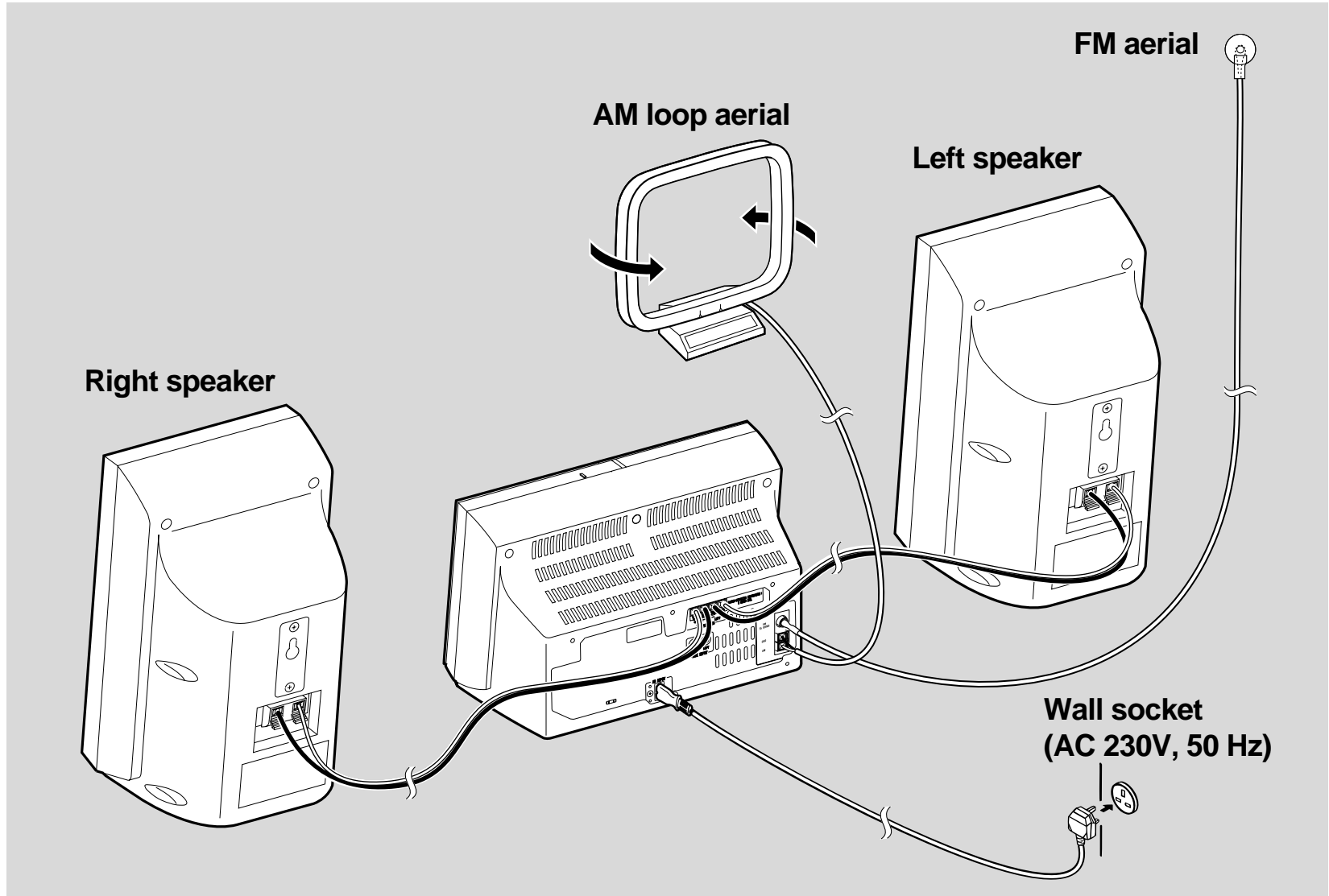

■ Aerial connection

Supplied FM aerial:

Connect the FM aerial wire to the FM 75 OHMS socket and position the FM aerial wire in the direction where the strongest signal can be received.

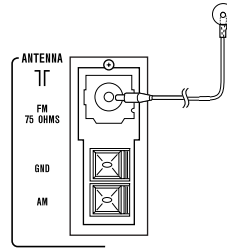

Supplied AM loop aerial:

Connect the AM loop aerial wire to the AM and GND terminals. Position the AM loop aerial for optimum reception. Place the AM loop aerial on a shelf, etc., or attach it to a stand or a wall with screws (not supplied).

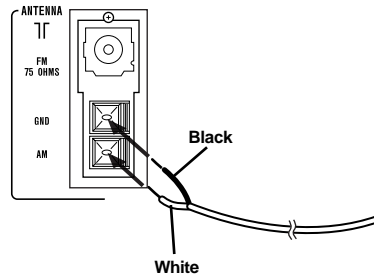

Note:

Placing the aerial on the stereo system or near the AC power lead and speaker wires may cause noise pickup. Place the aerial away from the stereo system for better reception.

Installing the AM loop aerial:

< Assembling >

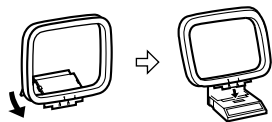

< Attaching to the wall >

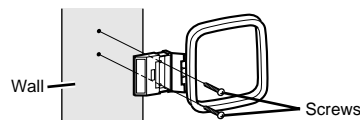

■ External FM or AM aerial

Use an external FM or AM aerial if you require better reception. Consult your dealer.

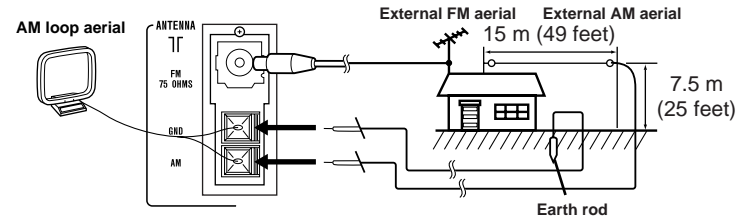

Notes:

- When an external FM aerial is used, disconnect the supplied FM aerial wire from the FM 75 OHMS socket.
- When using an external AM aerial, be sure to keep the wire of the AM loop aerial connected.

■ Speaker connection

Connect the wire with the black line to the (-) and transparent one to the (+).

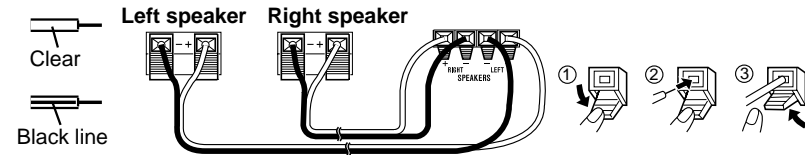

Caution:

- **Connect the speaker wires to the speakers first, then to the unit.**
- Use speakers with an impedance of 6 ohms or more, as lower impedance speakers can damage the unit.
- Do not mistake the right and the left channels. The right speaker is the one on the right side when you face the unit.
- **Do not let the bare speaker wires touch each other.**



- Do not stand or sit on the speakers. You may be injured.

System Connections (continued)

■ To mount the speakers on the wall

The design of the speakers allows them to be hung on the wall. Be sure to use the type and size of screw that is shown below.

- 1 Make a hole in the wall using a drill.
- 2 Drive a wall mount plug into the hole using a hammer. Drive the wall mount plug in until it is flush with the wall surface.

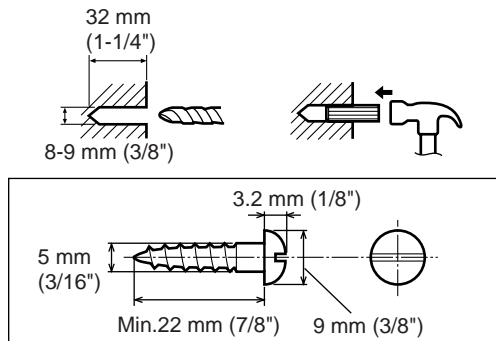

- 3 Drive one screw into the wall for each speaker as shown in the illustration.

- Drive the screws, so there is about a 5 mm (3/16") space between the wall and the head of the screw.

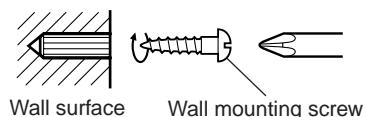

- 4 Mount the speaker on the wall so that the screw head is inserted into the slot on the speaker.

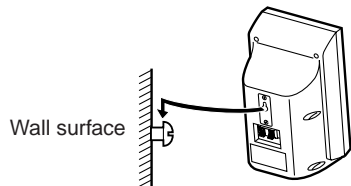

■ How to apply non-slip sheets

Adhere the non-slip sheets to the bottom of the speaker.



Adhere the non-slip sheets on the lower back of the speaker, and then mount it to the wall.



■ Connecting the AC power lead

After checking all the connections have been made correctly, plug the unit into the mains. If you plug the unit first, the unit will enter the demonstration mode.

Note:

Unplug the unit if it will not be used for a prolonged period of time.

■ Demonstration mode

The first time the unit is plugged in, the unit will enter the demonstration mode. You will see words scroll.

DEMO ON

To cancel the demonstration mode:

When the unit is in the power stand-by mode (demonstration mode), press the AUX (DEMO) button. The unit will enter the low power consumption mode.

To return to the demonstration mode:

When the unit is in the power stand-by mode, press the AUX (DEMO) button again.

General Control

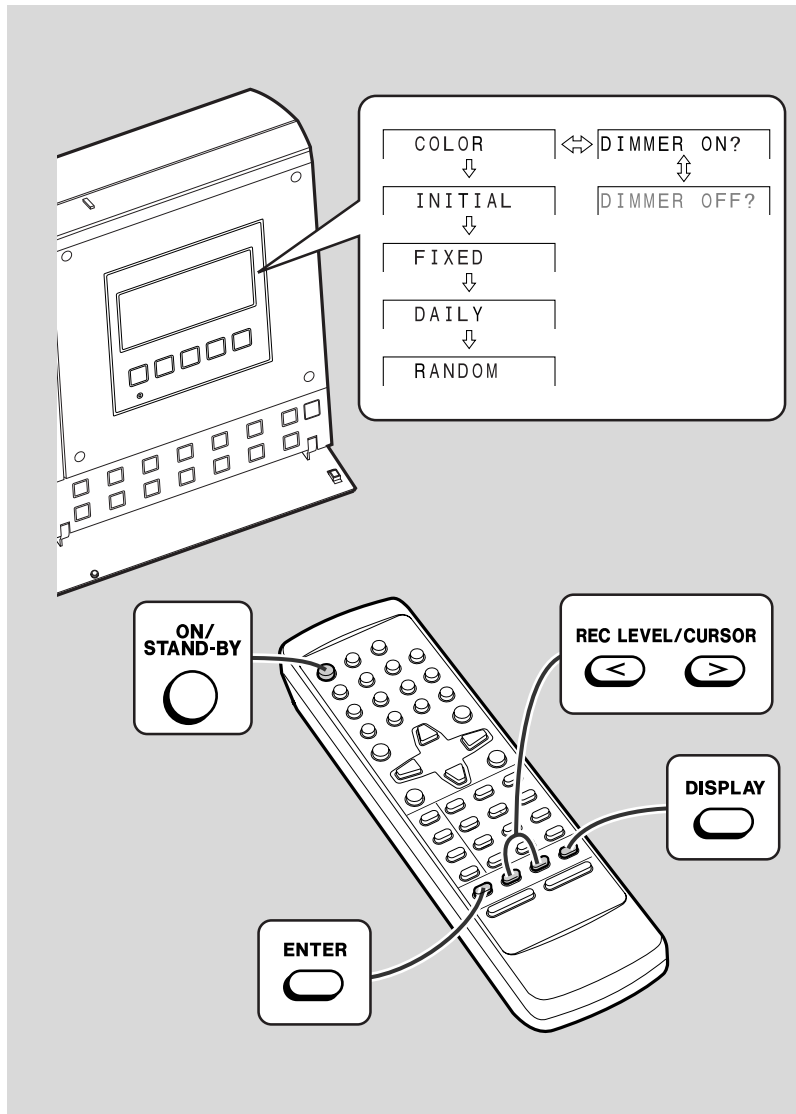

■ You can select and change to the colour you like from 7 different colours.

- 1 Press the ON/STAND-BY button to turn the power on.
- 2 Press the DISPLAY button for 2 seconds or more.
- 3 Press the REC LEVEL/CURSOR < or > button to select "COLOR".
- 4 Press the ENTER button.
- 5 Press the REC LEVEL/CURSOR < or > button.

INITIAL	The colour changes automatically along with the operation.
FIXED	You can select a colour you like.
DAILY	The colour changes according to the day of the week.
RANDOM	The colour changes at random.

- 6 Press the ENTER button.
- 7 When FIXED or DAILY is selected:
 - Press ENTER button after selecting your favourite colour with the REC LEVEL/CURSOR < or > button.
 - You can select the colour you like from 7 colours (COLOR 1 to COLOR 7).

■ To change the display illumination brightness

To dim:

- 1 Press the ON/STAND-BY button to turn the power on.
- 2 Hold the DISPLAY button down for 2 seconds or more.
- 3 Press the REC LEVEL/CURSOR < or > button to select "DIMMER ON?".
- 4 Press the ENTER button.
 - The light goes out and characters are dimmed.

To brighten:

- 1 Hold the DISPLAY button down for 2 seconds or more.
- 2 Press the ENTER button.

Sound Control

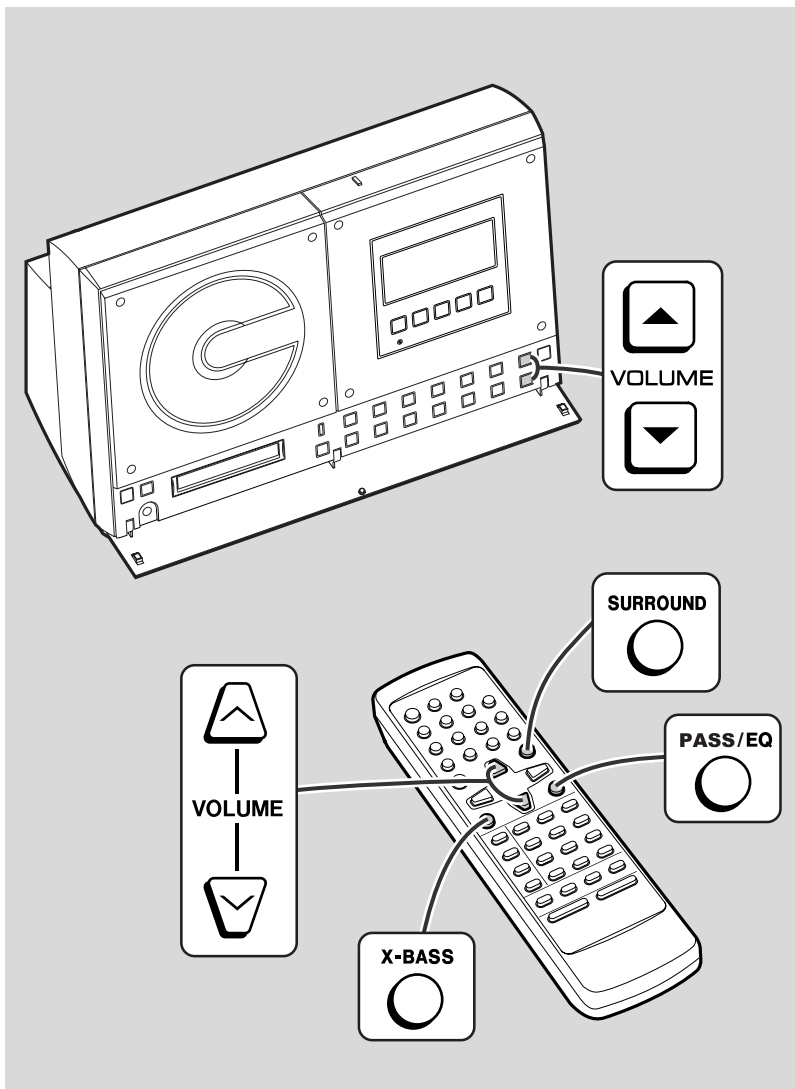

■ Volume control

Press the VOLUME ^ button to increase the volume and the VOLUME v button for decreasing.

VOLUME 20

■ Bass control

When the X-BASS button is pressed, the unit will enter the extra bass mode which emphasises the bass frequencies. To cancel the extra bass mode, press the X-BASS button.

X-BASS ON



X-BASS OFF

Bass is emphasised.

Cancelled.

■ Surround

Press the SURROUND button to allow you to enjoy music that seems to surround you. "SURROUND" will appear. Press the SURROUND button again to cancel the surround mode. "SURROUND" will go out.

1 2:13
(SURROUND)



1 2:13

■ Equalizer

Press the PASS/EQ button repeatedly until the desired sound mode appears.

BY-PASS

The sound is not modified.



HEAVY

Bass and treble are emphasised.



SOFT

Treble is reduced.



VOCAL

Vocals (midrange tones) are emphasised.

Setting the Clock

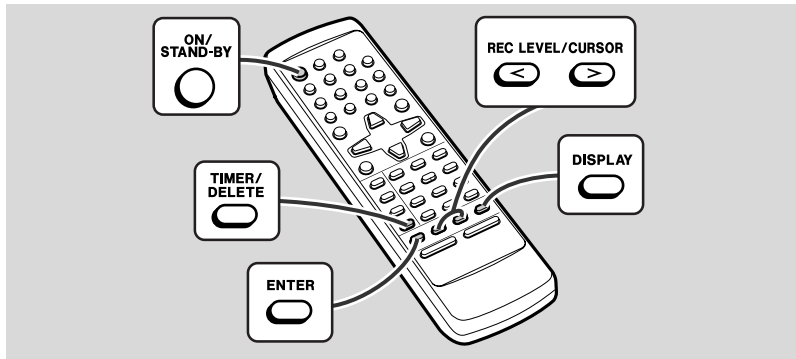

In this example, the clock is set for 9:30 15. 02 '01 .

- 1** Press the ON/STAND-BY button to turn the power on.
- 2** Press the TIMER/DELETE button.
- 3** Within 10 seconds, press the REC LEVEL/CURSOR < or > button to select the "TIME ADJUST".

TIME ADJUST
- 4** Within 10 seconds, press the ENTER button.
- 5** Press the REC LEVEL/CURSOR < or > button to adjust the year, and then press the ENTER button.

01 . 01' 01
- 6** Press the REC LEVEL/CURSOR < or > button to adjust the month, and then press the ENTER button.

01 . 02' 01

- 7** Press the REC LEVEL/CURSOR < or > button to adjust the date, and then press the ENTER button.

15 . 02' 01

- 8** Press the REC LEVEL/CURSOR < or > button to adjust the hour, and then press the ENTER button.

9 : 00

- 9** Press the REC LEVEL/CURSOR < or > button to adjust the minutes, and then press the ENTER button.

9 : 30

- The hour will not advance even if minutes advance from "59" to "00".
- The clock starts from "0" second. (Seconds are not displayed.) The time display will disappear after a few seconds.

To confirm the time display:

[When the unit is in the stand-by mode]

Press the DISPLAY button on the remote control.
The time display will appear for about 5 seconds.

[When the power is on]

Press the TIMER/DELETE button.
Within 10 seconds, press the REC LEVEL/CURSOR < or > button.
The time display will appear for about 10 seconds.

Note:

The clock setting will be cleared when the unit is unplugged or the power failure occurs.

To reset the clock:

Perform "Setting the Clock" from the beginning.

Listening to a CD

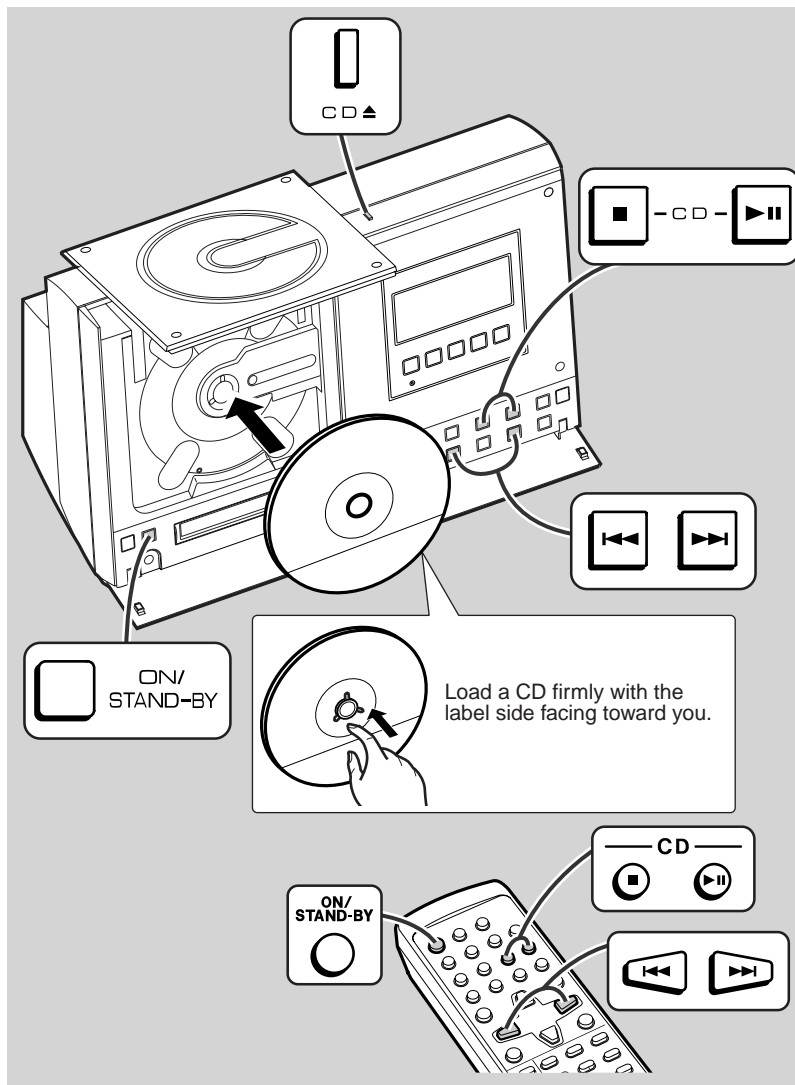

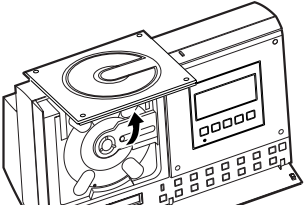
- 1** Press the ON/STAND-BY button to turn the power on.
 - 2** Press the CD ■ button.
 - 3** Press the CD ▲ button to open the CD cover.
- 
- 4** Set a CD and press the CD ▲ button.
- | | |
|--|------------------|
| DISC
12 | TOTAL
53 : 24 |
| | |
| Total number of tracks Total playing time | |
- 5** Press the CD ►|| button to start playback.
 - When the last track has finished playing, the CD player will stop automatically.

To interrupt playback:

Press the CD ►|| button.

To resume playback from the same point, press the CD ►|| button again.

To stop playback:

Press the CD ■ button.

To remove the CD:

Whilst in the stop mode, press the CD ▲ button.
Press the CD eject button and remove the CD.

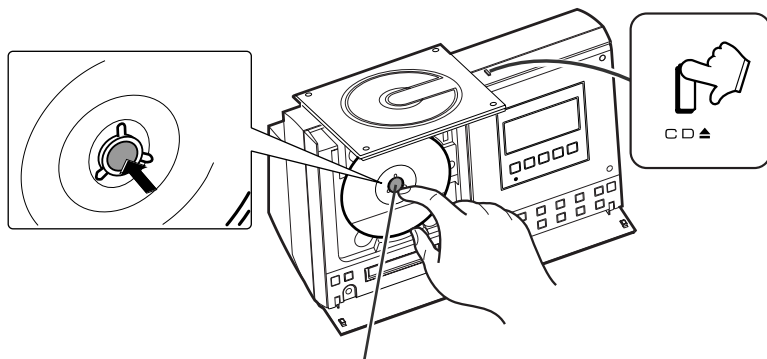

CD Eject Button

After use:

- Press the CD ▲ button and close the CD cover.
- When the unit enters the stand-by mode, the opened CD cover will be closed automatically.

Caution:

- **Be careful not to jam your fingers with the CD cover when opening and closing it.**
- **Do not stop or move the CD cover manually. It may cause malfunctions to the unit.**
- Keep foreign objects out of the CD compartment.
- Subjecting the unit to shock or vibration may cause mistracking.
- When the unit is not being used, be sure to close the CD cover. If it is left open, the lens may be covered with dust and the unit may not function properly.
- Playing certain compact discs at a high volume may cause mistracking. In this case, listen at a lower volume.
- If TV or radio interference occurs during CD operation, move the unit away from the TV or radio.
- If an error message is displayed during CD operation, see "Error Messages" on page 57.

■ To locate the beginning of a track

To move to the beginning of the next track:

Press the ►► button during playback.

- You can skip to any track by pressing the ►► button repeatedly until the desired track number appears.

To restart the track being played:

Press the ◀◀ button during playback.

- You can skip to any track by pressing the ◀◀ button repeatedly until the desired track number appears.

■ To locate the desired portion

For audible fast forward:

Press and hold down the ►► button during playback.

For audible fast reverse:

Press and hold down the ◀◀ button during playback.

Notes:

- Normal playback will resume when the ◀◀ or ►► button is released.
- When the end of the last track is reached during fast forward, "END" will appear in the display and CD operation will be paused. When the beginning of the first track is reached during fast reverse, the unit will enter the playback mode.

Listening to a CD (continued)

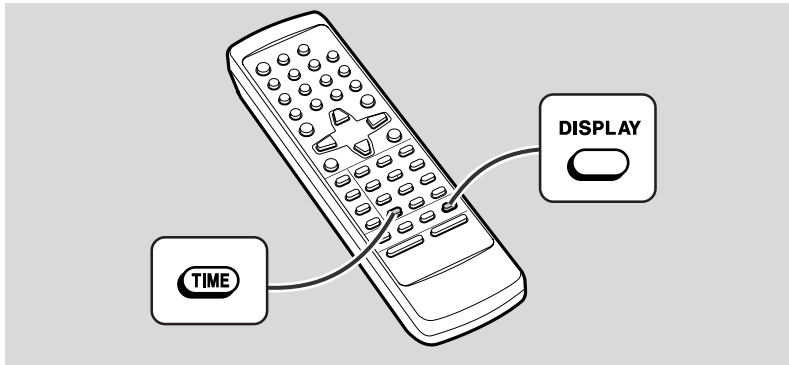

■ Switching the time display

Each time the TIME button on the remote control is pressed during playback, the display will change.

The elapsed playing time for the current track will be displayed.	<p>1^{TRACK} 0 : 03</p>
The remaining playing time for the current track will be displayed.	<p>1^{TRACK} - 3 : 12</p>
The total remaining playing time for the disc will be displayed.	<p>1^{TRACK} - 27 : 29^{TOTAL}</p>

Notes:

- During random play, the total remaining playing time will not be displayed.
- Depending on the CD, the playing time display may not match the total playing time which is indicated on the CD jacket, as the time between tracks is not included.

■ Switching to the level meter

Each time the DISPLAY button on the remote control is pressed during playback, the display will change.

The elapsed playing time for the current track will be displayed.	<p>1^{TRACK} 0 : 03</p>
The level meter will be displayed.	<p>L R [meter] -12 -4 OVER OVER</p>

Listening to a MiniDisc

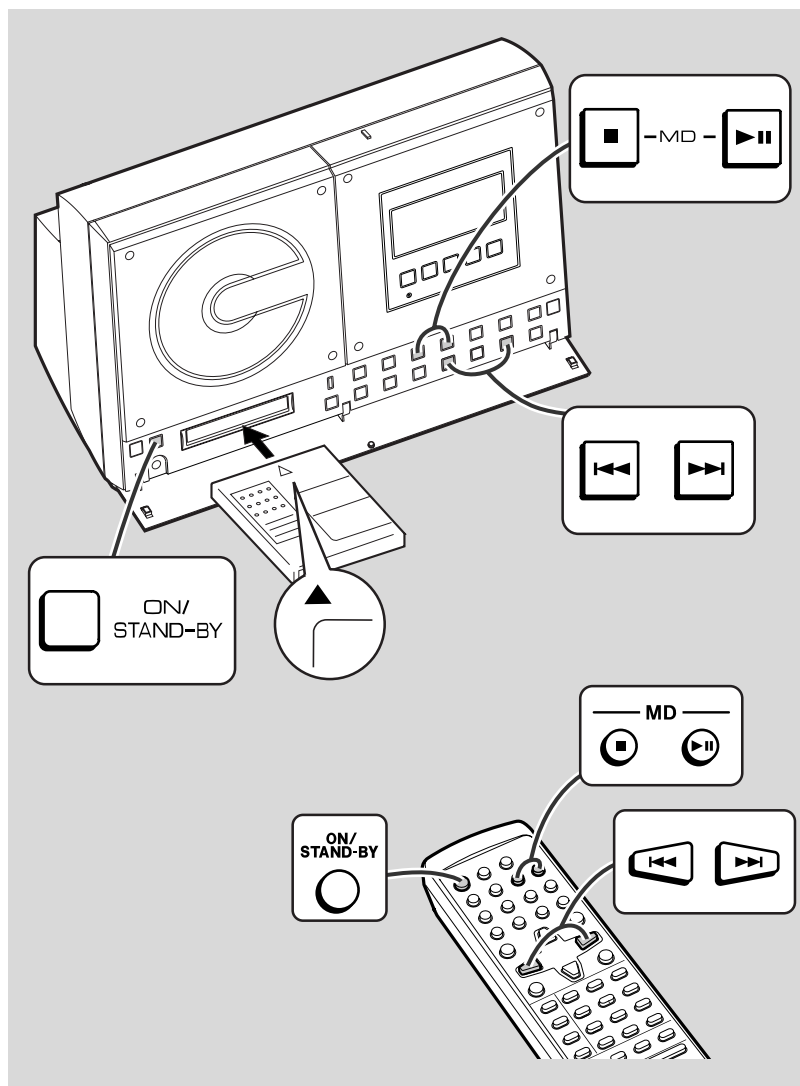

A track can be played in the mode it is recorded: monaural or 2 times or 4 times long recording (stereo) mode.

1 Open the control panel cover.



Control panel cover

2 Press the ON/STAND-BY button to turn the power on.

3 Press the MD button.

4 Load a MiniDisc into the MD compartment, label side up.

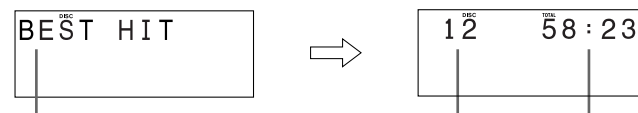

Disc name

Total number of tracks Total playing time

- If the MiniDisc is loaded in a wrong way, "? MD DISC" or "Can't READ" appears on the display. In that case, press the MD ▲ button.
- The disc name will be displayed only when it has been programmed, and then the total number of tracks and the total playing time on the MiniDisc will be displayed.

5 Press the MD button to start playback.

- If the MiniDisc has a track name, it will appear and scroll across the display. Then, the elapsed playing time will appear.
- If the MiniDisc has no track names, the elapsed playing time will appear.
- When the last track has finished playing, the MD player will stop automatically.

Listening to a MiniDisc (continued)

To interrupt playback:

Press the MD ►|| button.

To resume playback from the same point, press the MD ►|| button again.

To stop playback:

Press the MD ■ button.

To remove a MiniDisc:

Whilst in the stop mode, press the MD ▲ button.

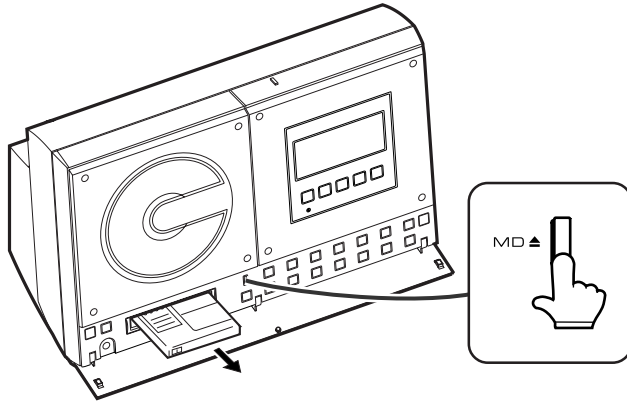

Caution:

- When loading a MD, make sure to turn the power on. If the MD is inserted forcibly without turning the power on, it may cause malfunctions.
- When transporting the unit, take out the MD. It may be jammed inside and cause malfunctions.
- If TV or radio interference occurs during MiniDisc operation, move the unit away from the TV or radio.
- Although MiniDiscs will not normally skip due to vibration, you may hear skipping in the sound if there is continuous vibration. If the volume is turned up too high, sound skipping may occur depending on the contents of the MiniDisc. If this happens, turn the volume down and the skipping should stop.
- If an error message is displayed during MiniDisc operation, see "Error Messages" on page 57.

■ To locate the beginning of a track

To move to the beginning of the next track:

Press the ►| button during playback.

- You can skip to any track by pressing the ►| button repeatedly until the desired track number appears.

To restart the track being played:

Press the ◀◀ button during playback.

- You can skip to any track by pressing the ◀◀ button repeatedly until the desired track number appears.

■ To locate the desired portion

For audible fast forward:

Press and hold down the ►| button during playback.

For audible fast reverse:

Press and hold down the ◀◀ button during playback.

Notes:

- Normal playback will resume when the ◀◀ or ►| button is released.
- When the end of the last track is reached during fast forward, "END" will appear in the display and MiniDisc operation will be paused. When the beginning of the first track is reached during fast reverse, the unit will enter the playback mode.

■ To select a track more than 10 tracks ahead

Whilst in the stop mode or playback:

- 1 Press the +10 button to forward by 10 tracks.
- 2 Press the ◀◀ or ►| button to move forward or backward by 1 track.

For example, to move to the 27th track when listening to the 5th track:

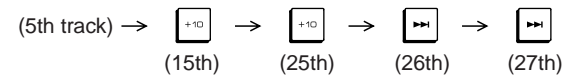

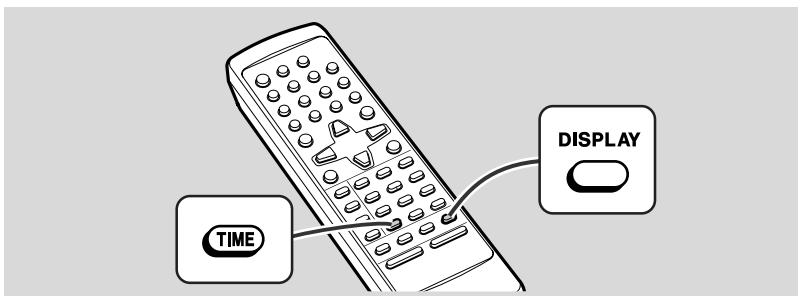

■ Switching the time display

Each time the TIME button on the remote control is pressed during playback, the display will change.

The elapsed playing time for the current track will be displayed.	1 ^{TRACK} 0 : 03
The remaining playing time for the current track will be displayed.	1 ^{TRACK} - 3 : 12
The total remaining playing time for the disc will be displayed.	1 - ^{TOTAL} 27 : 29

Notes:

- During random play, the total remaining playing time will not be displayed.
- Depending on the MiniDisc, the playing time display may not match the total playing time which is indicated on the MiniDisc jacket, as the time between tracks is not included.

■ Switching the track name or level meter etc.

Each time the DISPLAY button on the remote control is pressed during playback, the display will change.

The elapsed playing time for the current track will be displayed.	1 ^{TRACK} 0 : 03
The track name will be displayed.	1 ^{TRACK} : LOVE SO
"NO NAME" is displayed if the track is not named.	
The level meter is displayed.	L R [Level Meter] [OVER]
Tracks recorded in monaural is indicated as "M".	
Remaining recording time is displayed.	SP - 022 : 20
Date of recording is displayed.	15 . 02 ' 01
Time of recording is displayed.	12 : 42

Notes:

- When the level meter is displayed, it remains unchanged during playback.
- It returns to normal when the MD is removed.
- The remaining recording time, and the date and the time of recording are not displayed for playback-only MD.

Direct Play

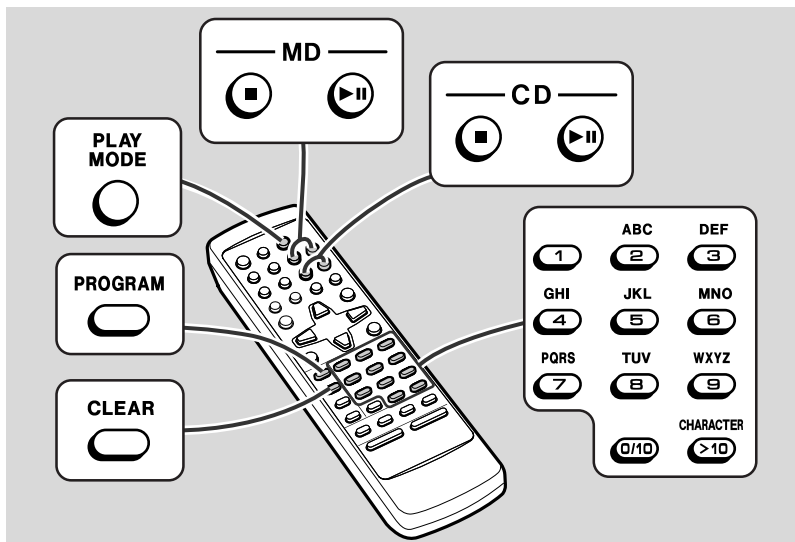

When in the CD or MD mode, press the direct buttons to select the desired tracks.

To select a track between the 11th and 99th tracks:

Select the track after pressing the > 10 button.

A. For example, to choose 28

- 1 Press the "> 10" button.
- 2 Press the "2" button.
- 3 Press the "8" button.

To select a track beyond the 100th track (MD only):

Select the track after pressing the > 10 button twice.

B. For example, to choose 105

- 1 Press the "> 10" button twice.
- 2 Press the "1" button.
- 3 Press the "0/10" button.
- 4 Press the "5" button.

Repeat or Random play

You can select the CD or MD playback mode; "Repeat play", "Random play" and "Normal play".

- 1 When in the CD or MD mode, press the PLAY MODE button repeatedly to select the playback mode.

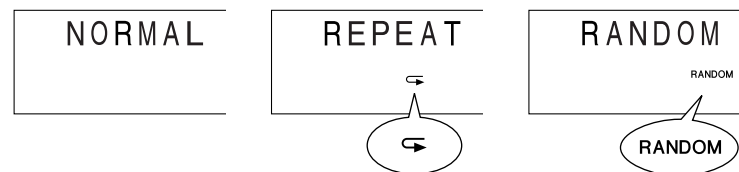

- 2 Press the CD ►|| or MD ►|| button to start playback.

To repeat a programmed sequence:

Perform steps 1 - 5 in the "Programmed Play" section and then select the repeat playback.

Notes:

- You can select the playback mode by pressing the PLAY MODE button on the main unit.
- During programme operation, random play is not possible.
- After using repeat play, be sure to press the ■ button. Otherwise, the disc(s) will play continuously.
- The random play will stop automatically when all tracks are played once. (The same track will not be played back twice.)
- In random play, the CD or MiniDisc player will select and play tracks automatically. (You cannot select the order of the tracks.)

To cancel repeat or random play:

Press the PLAY MODE button repeatedly to select the normal play mode.

Programmed Play

Up to 20 CD tracks or 20 MD tracks can be programmed.
You cannot programme CD and MiniDisc tracks together at the same time.

1 Whilst in the stop mode, press the CD ■ or MD ■ button.

2 Press the PROGRAM button to enter the programming save mode.

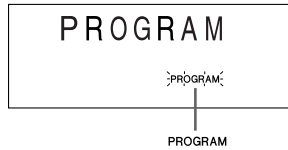

3 Press the direct buttons to select the desired track.

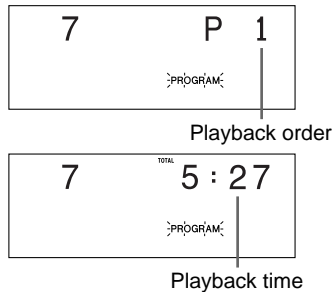

4 Repeat step 3 for any other track. Up to 20 tracks can be programmed.

If the total programmed playback time exceeds 400 minutes, "--:--" is displayed. However, it is properly memorised.

5 Press the CD ■ or MD ■ button.

6 Press the CD ►|| or MD ►|| button to start playback.

To clear the programmed selections:

Press the CLEAR button whilst the "PROGRAM" indicator is flashing.

- Each time the button is pressed, one track will be cleared, beginning with the last track programmed.

To cancel the programmed play mode:

Whilst in the stop mode, press the CLEAR button. The "PROGRAM" indicator will disappear and all the programmed content will be cleared.

Adding tracks to the programme:

If a programme has been previously stored, the "PROGRAM" indicator will be displayed. Then follow steps 1 - 5 to add tracks. The new tracks will be stored after the last track of the original programme.

To check which tracks are programmed:

Whilst the unit is stopped in the programmed play mode, press the ◀◀ or ▶▶ button.

Notes:

- Ejecting a CD or MiniDisc automatically cancels the programmed sequence.
- Even if you press the ON/STAND-BY button to enter the stand-by mode or change the function from CD or MD to another function, the programmed selections will not be cleared.
- During programme operation, random play is not possible.

Listening to the Radio

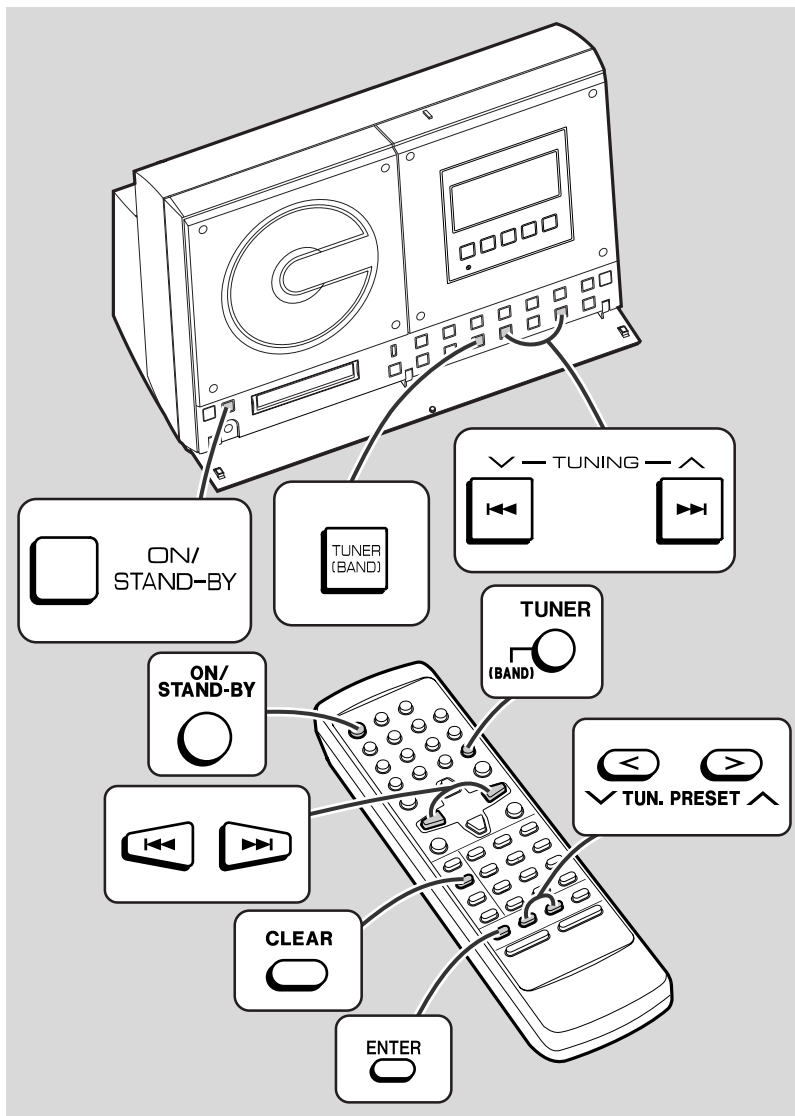

■ Tuning

- 1** Press the ON/STAND-BY button to turn the power on.
- 2** Press the TUNER (BAND) button repeatedly to select the desired frequency band (FM STEREO, FM or AM).

- 3** Press the TUNING ∇ or \blacktriangle button to tune in to the desired station.

Manual tuning:

Press the TUNING ∇ or \blacktriangle button as many times as required to tune in to the desired station.

Auto tuning:

When the TUNING ∇ or \blacktriangle button is pressed for more than 0.5 seconds, scanning will start automatically and the tuner will stop at the first receivable broadcast station.

You can tune in to the desired station by pressing the \lll or \ggg button on the remote control.

Notes:

- When radio interference occurs, auto scan tuning may stop automatically at that point.
- Auto scan tuning will skip weak signal stations.
- When an RDS (Radio Data System) station is tuned in, the frequency will be displayed first, and then the RDS indicator will light. Finally, the station name will appear.
- Full auto tuning can be achieved for RDS stations "ASPM", see page 30.

- 4** To receive an FM stereo transmission, press the TUNER (BAND) button. The "STEREO" indicator lights up.

- "ST" will appear when an FM broadcast is in stereo.
- If the FM reception is weak, press the TUNER (BAND) button. The "STEREO" indicator goes out. The reception changes to monaural, and the sound becomes clearer.

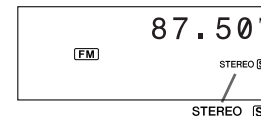

After use:

Press the ON/STAND-BY button to enter the stand-by mode.

■ Preset tuning

(Remote control operation)

You can store 40 AM and FM stations in memory and recall them at the push of a button.

1 Perform steps 1 - 4 in the "Tuning" section on page 26.

2 Press the ENTER button to enter the preset tuning saving mode.

3 Within 5 seconds, press the TUN. PRESET \vee or \wedge button to select the preset channel number.

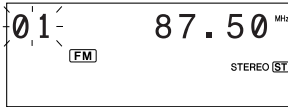

- Store the stations in memory, in order, starting with preset channel 1.

4 Within 5 seconds, press the ENTER button to store that station in memory.

- If the preset number indicator goes out before the station is memorised, repeat the operation from step 2.

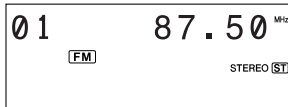

5 Repeat steps 1 - 4 to set other stations, or to change a preset station.

- When a new station is stored in memory, the station previously memorised will be erased.

Note:

The backup function protects the memorised stations for a few hours should there be a power failure or the AC power lead disconnection.

■ To recall a memorised station

(Remote control operation)

Press the TUN. PRESET \vee or \wedge button to select the desired station.

The direct buttons allow you to recall a memorised station.

To select a preset station between the 11 and 40:

For example, to choose 28

- 1 Press the "> 10" button.
- 2 Press the "2" button.
- 3 Press the "8" button.

■ To erase all the contents of the preset memory

(Remote control operation)

- 1 Press the TUNER (BAND) button.
- 2 Hold the CLEAR button down for 3 seconds or more.
- 3 Press the ENTER button.

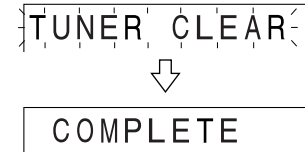

Using the Radio Data System (RDS)

RDS is a broadcasting service which a growing number of FM stations provide. These FM stations send additional signals along with their regular programme signals. They send their station names, and information about the type of programme such as sports or music, etc.

When tuned to an RDS station, "RDS" and the station name will be displayed.

"TP" (Traffic Programme) will appear on the display when the received broadcast carries traffic information, and "TA" (Traffic Announcement) will appear whilst a traffic information is on air (see page 34).

"EON" will appear whilst the EON (Enhanced Other Networks information) data is broadcast.

"PTYI" (Dynamic PTY Indicator) will appear whilst the Dynamic PTY station is received.

You can control the RDS by using the remote control only.

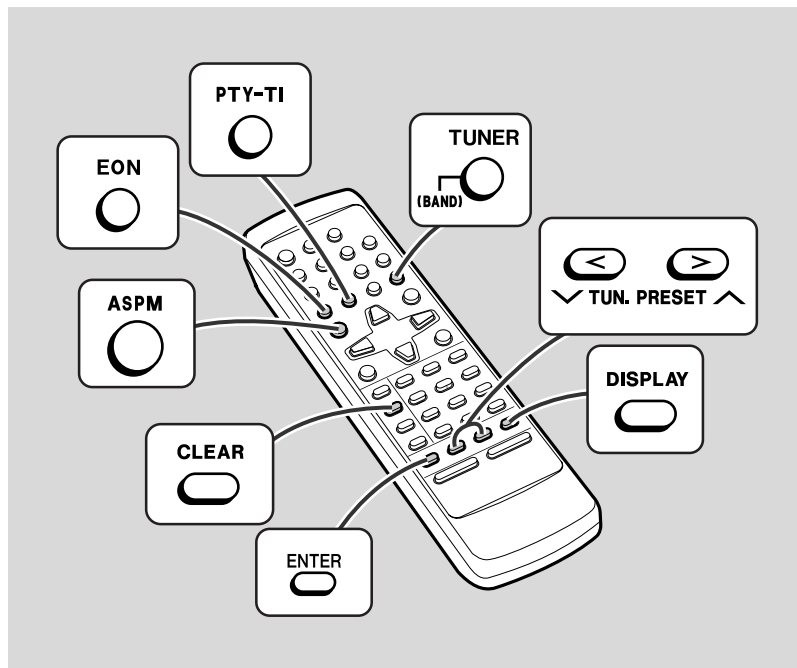

Information provided by RDS

Each time the DISPLAY button is pressed, the display will switch as follows:

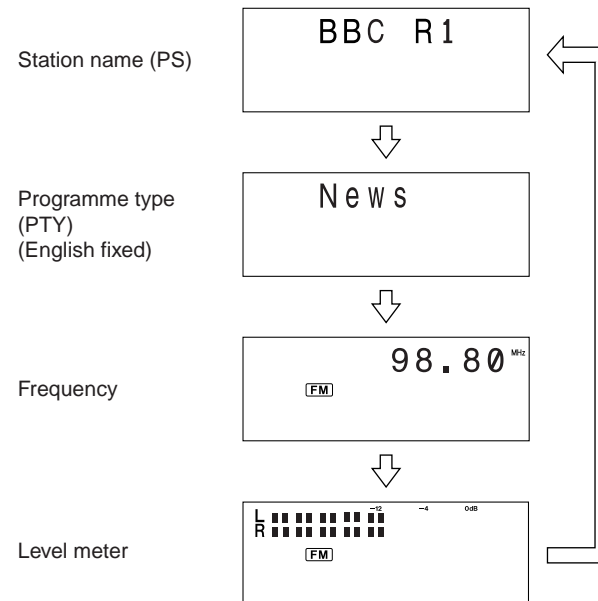

When you are tuning in to a station other than an RDS station or to an RDS station which sends weak signal, the display will change in the following order:

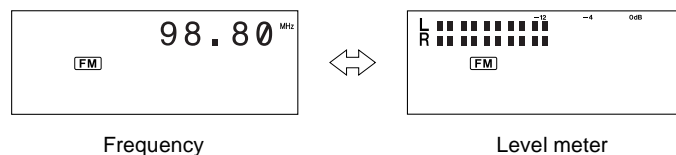

Descriptions of the PTY (Programme Type) codes, TP (Traffic Programme) and TA (Traffic Announcement).

You can search for and receive the following PTY, TP and TA signals.

News	Short accounts of facts, events and publicly expressed views, reportage and actuality.
Affairs	Topical programme expanding or enlarging upon the news, generally in different presentation style or concept, including debate, or analysis.
Info	Programmes whose purpose is to impart advice in the widest sense.
Sport	Programme concerned with any aspect of sport.
Educate	Programme intended primarily to educate, of which the formal element is fundamental.
Drama	All radio plays and serials.
Culture	Programmes concerned with any aspect of national or regional culture, including language, theatre, etc.
Science	Programmes about the natural sciences and technology.
Varied	Used for mainly speech-based programmes usually of light-entertainment nature, not covered by other categories. Examples include: quizzes, panel games, personality interviews.
Pop M	Commercial music, which would generally be considered to be of current popular appeal, often featuring in current or recent record sales charts.
Rock M	Contemporary modern music, usually written and performed by young musicians.
Easy M	Current contemporary music considered to be "easy-listening", as opposed to Pop, Rock or Classical, or one of the specialised music styles, Jazz, Folk or Country. Music in this category is often but not always, vocal, and usually of short duration.
Light M	Classical music for general, rather than specialist appreciation. Examples of music in this category are instrumental music, and vocal or choral works.
Classics	Performances of major orchestral works, symphonies, chamber music, etc., and including Grand Opera.
Other M	Musical styles not fitting into any of the other categories. Particularly used for specialist music of which Rhythm & Blues and Reggae are examples.
Weather	Weather reports and forecasts and meteorological information.
Finance	Stock Market reports, commerce, trading, etc.
Children	For programmes targeted at a young audience, primarily for entertainment and interest, rather than where the objective is to educate.

Social	Programmes about people and things that influence them individually or in groups. Includes: sociology, history, geography, psychology and society.
Religion	Any aspect of beliefs and faiths, involving a God or Gods, the nature of existence and ethics.
Phone in	Involving members of the public expressing their views either by phone or at a public forum.
Travel	Features and programmes concerned with travel to near and far destinations, package tours and travel ideas and opportunities. Not for use for announcements about problems, delays, or roadworks affecting immediate travel where TP/TA should be used.
Leisure	Programmes concerned with recreational activities in which the listener might participate. Examples include, Gardening, Fishing, Antique collecting, Cooking, Food & Wine, etc.
Jazz	Polyphonic, syncopated music characterised by improvisation.
Country	Songs which originate from, or continue the musical tradition of the American Southern States. Characterised by a straightforward melody and narrative story line.
Nation M	Current Popular Music of the Nation or Region in that country's language, as opposed to International 'Pop' which is usually US or UK inspired and in English.
Oldies	Music from the so-called "golden age" of popular music.
Folk M	Music which has its roots in the musical culture of a particular nation, usually played on acoustic instruments. The narrative or story may be based on historical events or people.
Document	Programme concerned with factual matters, presented in an investigative style.
TEST	Broadcast when testing emergency broadcast equipment or receivers.
Alarm !	Emergency announcement made under exceptional circumstances to give warning of events causing danger of a general nature.
None	No programme type (receive only).
TP	Broadcasts which carry traffic announcements.
TA	Traffic announcements are being broadcast.

Note:

When you select a programme in the EON stand-by mode, the unit will display "TI" instead of "TA".

Using the Radio Data System (RDS) (continued)

■ Using the Auto Station Programme Memory (ASPM)

Whilst in the ASPM operation mode, the tuner will automatically search for new RDS stations. Up to 40 stations can be stored.

If you have already stored some stations in memory, the number of new stations you can store will be less.

1 Press the TUNER (BAND) button to select the FM band.



2 Press and hold down the ASPM button for at least 3 seconds.

After "ASPM" has flashed for about 4 seconds, scanning will start (87.50 - 108.00 MHz).

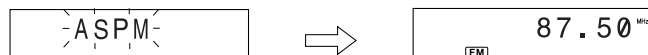

When an RDS station is found, "RDS" will appear for a short time and the station will be stored in memory.

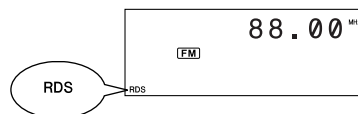

After scanning, the number of stations stored in memory will be displayed for 4 seconds, and then "END" will appear for 4 seconds.

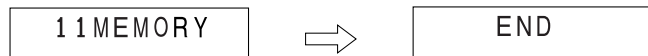

To stop the ASPM operation before it is complete:

Press the ASPM button whilst it is scanning for stations.
The stations which are already stored in memory will be kept there.

Notes:

- If the same station is broadcasting on different frequencies, the strongest frequency will be stored in memory.
- Any station which has the same frequency as the one stored in memory will not be stored.
- If 40 stations have already been stored in memory, the scan will be aborted. If you want to redo the ASPM operation, erase the preset memory.
- If the RDS signals are very weak, station names may not be stored in memory.

To erase all of the contents of preset memory:

- 1 Press the TUNER (BAND) button.
- 2 Hold the CLEAR button down for 3 seconds or more.
- 3 Press the ENTER button.

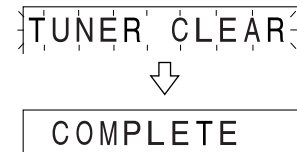

To store a station name again if the wrong name was stored in memory:

It may be impossible to store station names in memory using the ASPM function if there is lots of noise or if the signal is too weak. In this case, perform as follows.

- 1 Press the TUN. PRESET \vee or \wedge button to check whether the names are correct.
 - 2 If you find a wrong name during receiving the station. Wait until the correct name will be displayed. And then press the ENTER button.
 - 3 Within 5 seconds, press the TUN. PRESET \vee or \wedge button to display the preset channel to be corrected again.
 - 4 Within 5 seconds, press the ENTER button.
- The new station name has been stored in memory correctly.

Notes:

- The same station name can be stored in different channels.
- In a certain area or during certain time periods, the station names may temporarily be different.

■ To recall stations in memory

To specify programme types and select stations (PTY search):

You can search a station by specifying the programme type (news, sports, traffic programme, etc. ... see page 29) from the stations in memory.

1 Press the TUNER (BAND) button to select the FM band.



2 Press the PTY-TI button.



- "PTY TI" and "SELECT" will appear alternately for about 6 seconds.

3 Within 6 seconds, press the TUN. PRESET ∇ or \wedge button to select the programme type you want.



- Each time the button is pressed, the programme type will appear. If the button is held down for more than 0.5 seconds, the programme type will appear continuously.

4 Whilst the selected programme type is flashing (within 4 seconds), press the ENTER button.



- After the selected programme type has been lit for 2 seconds, "SEARCH" will appear, and the search operation will start.



Notes:

- If the display has stopped flashing, start again from step 2. If the unit finds out a desired programme type, corresponding the station name will flash for 10 seconds and remain lit.
- If you want to listen to the same programmed type of another station, press the PTY-TI button whilst the channel number and station name are flashing. The unit will look for the next station.
- If no station can be found, "NOT FOUND" will appear for 4 seconds.

If you select the traffic programme:

If you select the traffic programme (TP) in step 4, "TP" will appear. (This does not mean that you can listen to the traffic information at that time.) When a traffic information is broadcast, "TA" will appear.

To specify station names and select stations manually:

You can select a station by specifying the name (BBC R1, BBC R2, etc.) from the stations stored in memory.

Before starting this operation, you must store one or more station names in memory.

- 1 Press the TUNER (BAND) button to select the FM band.
- 2 Press the TUN. PRESET ∇ or \wedge button to select the desired station.

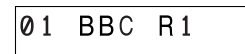

- 3 The station name will be displayed for 3 seconds. Then the display will change as follows.



Using the Radio Data System (RDS) (continued)

■ To automatically play the desired programme (EON-PTY)

When the desired type of programme is broadcast, the radio switches to it automatically.

1 Tune in to an RDS station (when a station name is displayed).



2 Press the EON button when "EON" appears.



- "PTY TI" and "SELECT" will appear alternately for about 6 seconds.
- If the EON button is pressed when "EON" is not displayed, "NO EON" will appear for 5 seconds to indicate that the unit cannot enter the EON stand-by mode.

3 Whilst they are displayed, select the desired programme type by pressing the TUN. PRESET \vee or \wedge button.



- The selected programme type will flash.

4 Within 4 seconds, press the ENTER button.

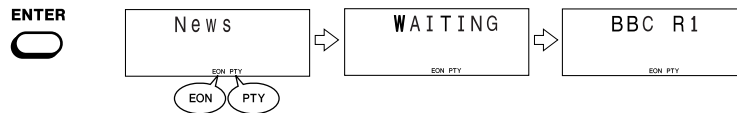

- The selected programme type and "WAITING" will be displayed for 2 seconds each.
- "PTY" will appear, and the unit will enter the EON-PTY stand-by mode.

5 When the specified programme starts on an ON (other network) station, the unit will automatically switch to the station and "PTY" will flash.

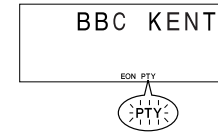

6 When the programme is over, the unit will automatically return to the original station.

Checking the stand-by mode setting:

When in the EON stand-by mode, press the EON button. ("Programme type" \rightarrow "WAITING")

To cancel the EON stand-by mode:

When in the EON stand-by mode, press the EON button. Within 4 seconds, press it again. ("PTY" will go out.)

About the PTYI (Dynamic PTY Indicator):

"PTYI" (Dynamic PTY Indicator) will appear whilst the Dynamic PTY station is received. Dynamic PTY indicates that the PTY for the station tuned in, or the PTY referenced in the EON data, is assessed whenever the programme changes and may be changed.

PTYI	Meaning
Lights up	Tuned in to a dynamic PTY station.
Goes out	Tuned in to a static PTY.

- When "PTYI" appears, press the DISPLAY button to check the type of the current programme.

■ To automatically play the traffic information (EON-TI)

When the traffic information is broadcast, the radio switches to it automatically.

1 Tune in to an RDS station (when a station name is displayed).



2 Press the EON button when "EON" appears.



- "PTY TI" and "SELECT" will appear alternately for about 6 seconds.
- If the EON button is pressed when "EON" is not displayed, "NO EON" will appear for 5 seconds to indicate that the unit cannot enter the EON stand-by mode.

3 Whilst they are displayed, select the TI (Traffic Information) by pressing the TUN. PRESET \vee or \wedge button.



4 Within 4 seconds, press the ENTER button.

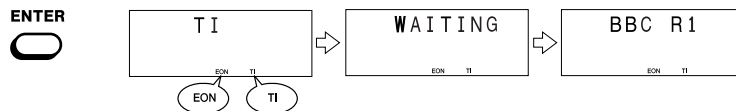

- "TI" and "WAITING" will appear for 2 seconds each.
- "TI" will appear, and the unit will enter the EON-TI stand-by mode.

5 When a TA specified starts on an ON (other network) station, the unit will automatically switch to that station, and "TI" will flash.

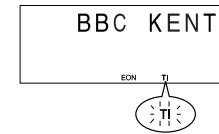

6 When the traffic announcement is over, the unit will automatically return to the original station you were tuned to.

Checking the stand-by mode setting:

When in the EON stand-by mode, press the EON button. ("TI" → "WAITING")

To cancel the EON stand-by mode:

When in the EON stand-by mode, press the EON button. Within 4 seconds, press it again. ("TI" will go out.)

Using the Radio Data System (RDS) (continued)

■ Notes for RDS operation

If any of the following events occur, it does not mean that the unit is faulty:

- "PS", "NO PS" and a station name appear alternately, and the unit does not operate properly.
- If a particular station is not broadcasting properly or a station is conducting tests, the RDS reception function may not work properly.
- When you receive an RDS station whose signal is too weak, information like the station name may not be displayed.
- "NO PS" or "NO PTY" will flash for about 5 seconds, and then the frequency will be displayed.

About the "TP" and "TA" indicators:

"TP"	"TA"	Meaning
Not lit	Not lit	Does not carry traffic announcements nor does it refer, via EON, to a programme that does.
Not lit	Lit	Carries EON information about another programme which gives traffic information.
Lit	Not lit	Carries traffic announcements but not at present and may also carry EON information about other traffic announcements.
Lit	Lit	A traffic information is currently on air.

In the following cases, the EON stand-by mode will be cancelled.

- When you press the ON/STAND-BY button to enter the stand-by mode.
- When the unit is switched to another band in the EON stand-by mode.
- When you change the FM station whilst in the EON stand-by mode.
- When a preset call is made.

Notes:

- Whilst the same programme as the specified PTY (or TA) is being broadcast, the unit will not switch to an ON (other network) station.
- If there are more than two other network stations, compare the strength of signal and tune in to the station with the strongest signal (EON-AF). If other network station has been stored in the preset channel memory, the unit will switch to that channel.
- If you want to leave an ON (other network) station tuned in by the EON and return to the station you were receiving, press the EON button.
- After the unit returns to the original station, the stand-by mode will still be active. (The "TI" or "PTY" will remain lit.)
- The unit does not switch between ON stations. It returns to the original station.
- If there is any problem with the ON station the unit switched to, "WEAK SIG" will appear and the unit will return to the original station.
- If the signal from the ON station the unit switched to is very weak, the unit will search for another station with the strongest signal. However, if the signals from all stations are weak or not good (due to electrical noise), the unit displays "WEAK SIG" and returns to the original station.

Before Recording to a MiniDisc

■ Disc writing (TOC)

The TOC (Table of Contents) is information on track numbers and recording areas to allow the unit to recognise musical selections or sounds. The entire MiniDisc is controlled depending on this TOC, which enables the unit to find the beginning of a track quickly or to automatically record in a vacant area.

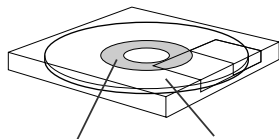

Area for TOC (recording track numbers, track names, etc.)
Area for recording the sound

When you start recording or editing, "TOC" will appear on the display. This indicates that information in the TOC is now being changed according to the recording or editing being performed. (The changed TOC is not yet recorded on the MiniDisc at this time.)

The TOC is recorded when

- You stop recording.
- You switch to another input source.
- You eject the MiniDisc.
- You set the unit to the stand-by mode.

Do NOT unplug the power lead whilst the TOC is being recorded ("TOC" is flashing) and do NOT impart shock to the unit. Otherwise, TOC will not be correctly recorded, and consequently proper playback may not be possible.

Recordings cannot be made in the following situations.

- If you try recording on a playback-only MiniDisc (commercially available music MiniDisc).
- If a MiniDisc is protected against accidental erasure. (See page 56.)
- If there is no more recording time left on the disc. (See page 57.)
- When the "TOC FULL" message appears. (See page 57.)
- If a disc's TOC has been damaged.

■ Notes for recording

- SHARP is not liable for damage or loss of your recording arising from malfunction of this unit.
- When recording important selections, be sure to make a preliminary test to ensure that the desired material is being properly recorded.
- The VOLUME, SURROUND, X-BASS and PASS/EQ controls can be adjusted with no effect to the recorded signal (Variable Sound Monitor).

■ About ATRAC

The ATRAC (Adaptive TRansform Acoustic Coding) system compresses the sound data into 1/5 by cutting out the inaudible sound. Since the sound is selected based on psychoacoustics masking, the sound quality is not impaired.

This unit is equipped with the ATRAC3 compressing system that can reduce the sound data to 1/10 or 1/20 of its original size.

By employing this system, 2 times and 4 times long recording is enabled in stereo mode.

Recording to a MiniDisc from a CD

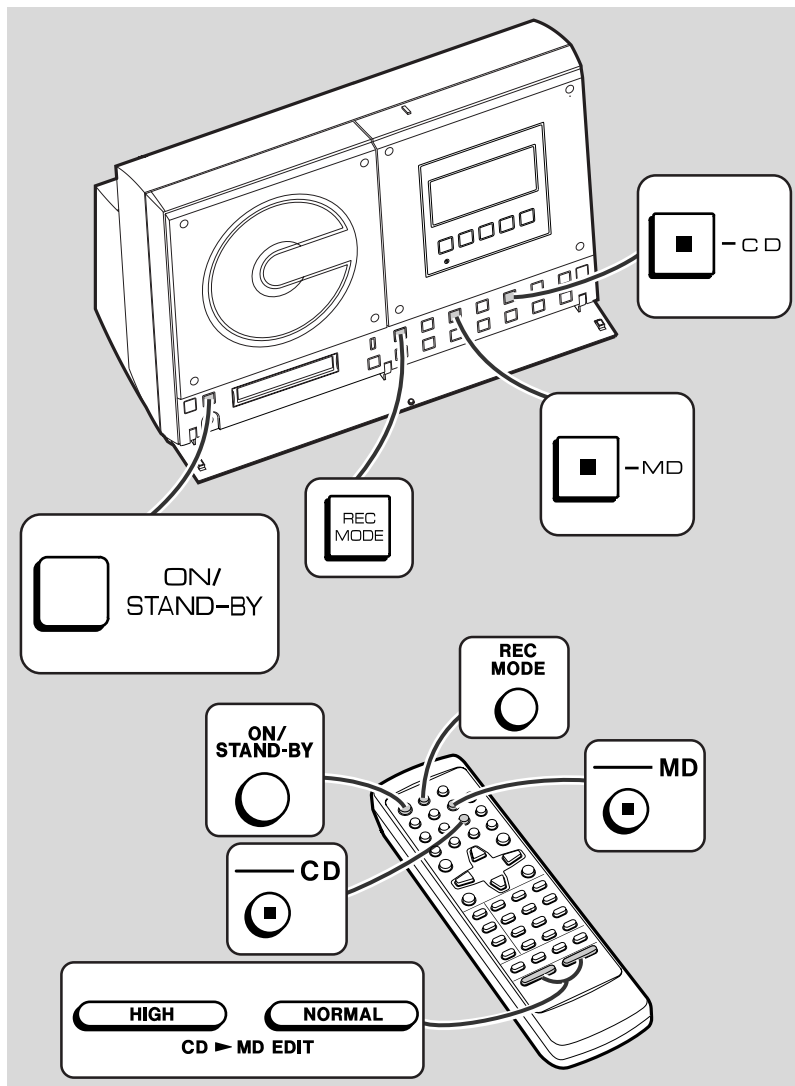

- 1** Press the ON/STAND-BY button to turn the power on.
- 2** Press the CD ■ button and load the desired CD.
- 3** Load a recordable MiniDisc into the MD compartment.
- 4** Press the REC MODE button to select the recording mode.

Stereo recording	SP	Monaural recording	MONO
2 times long recording (stereo)	LP2	4 times long recording (stereo)	LP4
Indication	Recording mode		Recording (to record on 80-minute MD)
SP	Stereo recording		Maximum 80 minutes
LP2	2 times long recording (stereo)		Maximum 160 minutes
LP4	4 times long recording (stereo)		Maximum 320 minutes
MONO	Monaural recording		Maximum 160 minutes

 - The recording mode cannot be changed whilst recording.
 - The recording mode remains unchanged until it is changed.
- 5** Press the CD ► MD EDIT (HIGH/NORMAL) button to start recording.
 - HIGH : High speed recording.
 - NORMAL : Normal speed recording.
 - Recording is performed digitally.

Note:

- Recording from a CD to a MiniDisc starts even if all the tracks on the CD cannot fit in the MiniDisc. In that case, both the CD and MD stop when the MD becomes full.
- When the CD reaches its end, recording to MD will stop simultaneously.
- You can record from a CD you programmed.
- Recording can be performed in repeat playback mode. The repeat playback can be switched during recording.

To stop recording:

Press the CD ■ or MD ■ button.
The CD and MiniDisc will stop.

After use:

Press the ON/STAND-BY button to enter the power stand-by mode.

<p>About track numbers:</p> <p>New track numbers will be created automatically according to the original tracks (Synchro mark function).</p> <ul style="list-style-type: none"> ● When you record from a CD to a MiniDisc, the track numbers recorded on the MiniDisc may not match the track numbers on the CD. 	CD		
	First track	Second track	Third track
	Track A	Track B	Track C
	↓		
	MiniDisc		
	First track	Second track	Third track
	Track A	Track B	Track C

Notes for long recording mode:

- Tracks recorded in 2 times long recording or 4 times long recording mode cannot be played with units that do not support these modes.
- On such a unit, "LP :" is displayed at the beginning of the track and no sound is heard. (The operation and the display may vary depending on the unit.)

Note for high speed recording:

Due to the scratch, dirt, or the recorded condition, the sound may be cut in pieces or the noise is heard from the MD recorded in high speed. If this occurs, record the MD at the normal speed.

Caution for 4 times long recording (LP4):

Special compressing method allows the 4 times long recording to realize long-time stereo recording. Therefore, some noise is recorded occasionally. If sound quality is the main requirement, stereo recording or 2 times long recording is recommended.

Recording to a MiniDisc from a CD (continued)

■ Recording the desired tracks of the CD

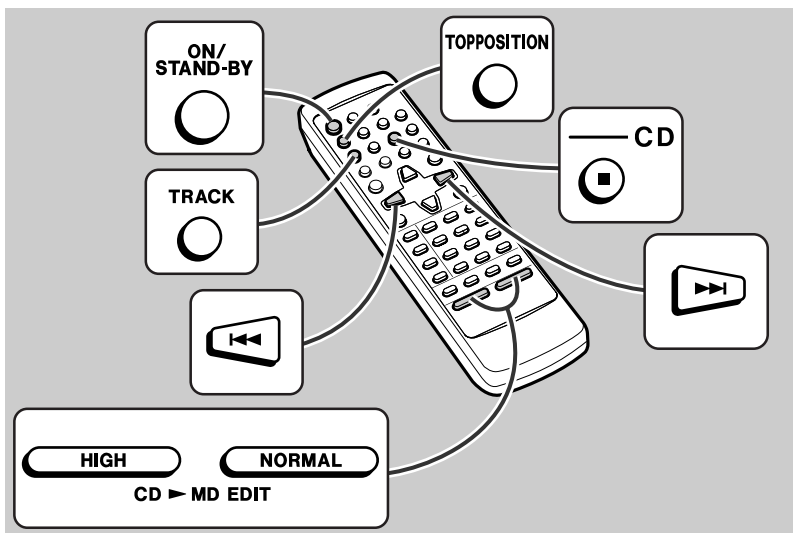

- 1** Press the ON/STAND-BY button to turn the power on.
- 2** Press the CD ■ button and load the desired CD.
- 3** Load a recordable MiniDisc into the MD compartment.
- 4** Press the ◀◀ or ▶▶ button to select the desired track.
- 5** Press the TRACK button to programme the track number.

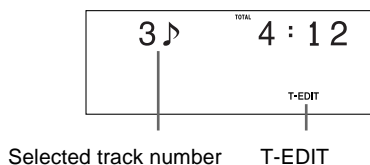

6 Repeat steps 4 - 5 for other tracks. Up to 20 tracks can be programmed.

- If more than 20 tracks are selected, "EDIT OVER" is displayed and the 21st track will not be memorised.

7 Press the CD ► MD EDIT (HIGH/NORMAL) button to start recording.

When the recording is finished, the selected tracks will be cleared.

To memorise a track whilst listening to it:

- 1 When you hear a track you want to record during playback, press the TRACK button.
- The track is memorised. (Maximum 20 tracks can be memorised.)
- 2 After the track is memorised, press the CD ■ button to stop playback.
- 3 Press the HIGH or NORMAL button to start recording.

To clear the memorised tracks:

Press the CD ■ button whilst in the stop mode.

■ Recording on the top position of a recorded MiniDisc

1 Prepare for recording.

To record from a CD: Load the desired CD and a recordable MiniDisc.	To record from the radio: Tune in to the desired station and load a recordable MiniDisc.
---	--

2 Press the TOP POSITION button.

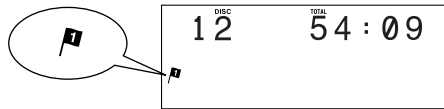

One more press will cancel the top position mode.

3 Start recording.

To record from a CD: Press the HIGH or NORMAL button.	To record from the radio: Press the MD ► button after pressing the REC ● button.
---	--

When the recording is finished, the top position mode will be cancelled.

The recorded track will be the first track on the MiniDisc.

All the tracks previously recorded will be renumbered.

Note:

- Whilst in the pause mode or recording, the top position mode cannot be set or cancelled.

■ Adjusting the recording level

You can adjust the recording level depending on the recording source by watching the level meter.

1 Press the CD ■ button.

2 Press the ◀◀ or ▶▶ button to select the desired track.

3 Press the REC MODE button to select the recording mode.

4 Press the CD ►|| button to start playback.

5 Press the REC ● button to pause recording.

6 Press the REC LEVEL/CURSOR < or > button to adjust the recording level.

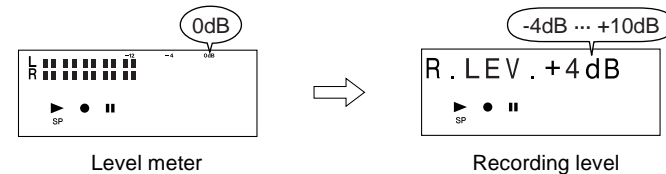

- Maximum level should not exceed "0dB".
- The recording level can be adjusted in 2dB intervals between -4dB and +10dB.

7 Press the CD ■ button.

8 Press the ◀◀ or ▶▶ button again to select the desired track to be recorded.

9 Press the CD ►|| button again to start recording.

To stop recording:

Press the MD ■ button.

The MiniDisc will stop.

The CD will continue playback.

Checking Displays

■ To check the recording mode and remaining recording time



Whilst in the stop mode in MD function, press the REC MODE button.

Each time the button is pressed, the display will change as follows.

SP -022 : 20	Remaining time in stereo recording mode
↓	
LP2 -044 : 40	Remaining time in 2 times long recording mode
↓	
LP4 -089 : 20	Remaining time in 4 times long recording mode
↓	
MONO -044 : 40	Remaining time in monaural recording mode

- After the remaining recording time is displayed, the display will return to normal.
- When resuming recording, it will be started in the recording mode that is confirmed in this procedure.

■ To check the display whilst in the recording mode

Whilst in the recording mode, press the DISPLAY button.

Each time the button is pressed, the display will change as follows.

1 ^{TRK} 0 : 03 ▶ ● <small>SP TOC</small>	Elapsed playing time
↓	
12 ^{TRK} NO NAME ▶ ● <small>SP TOC</small>	"NO NAME" appears.
↓	
L R [Level Meter] -4 0dB ▶ ● <small>SP TOC</small>	Level meter
↓	
12 ^{TRK} -022 : 20 ▶ ● <small>SP TOC</small>	Remaining recording time

- When recording is finished, the display will return to normal.
- Even if the recording mode is monaural, the level meter is displayed in stereo.

Titling a MiniDisc

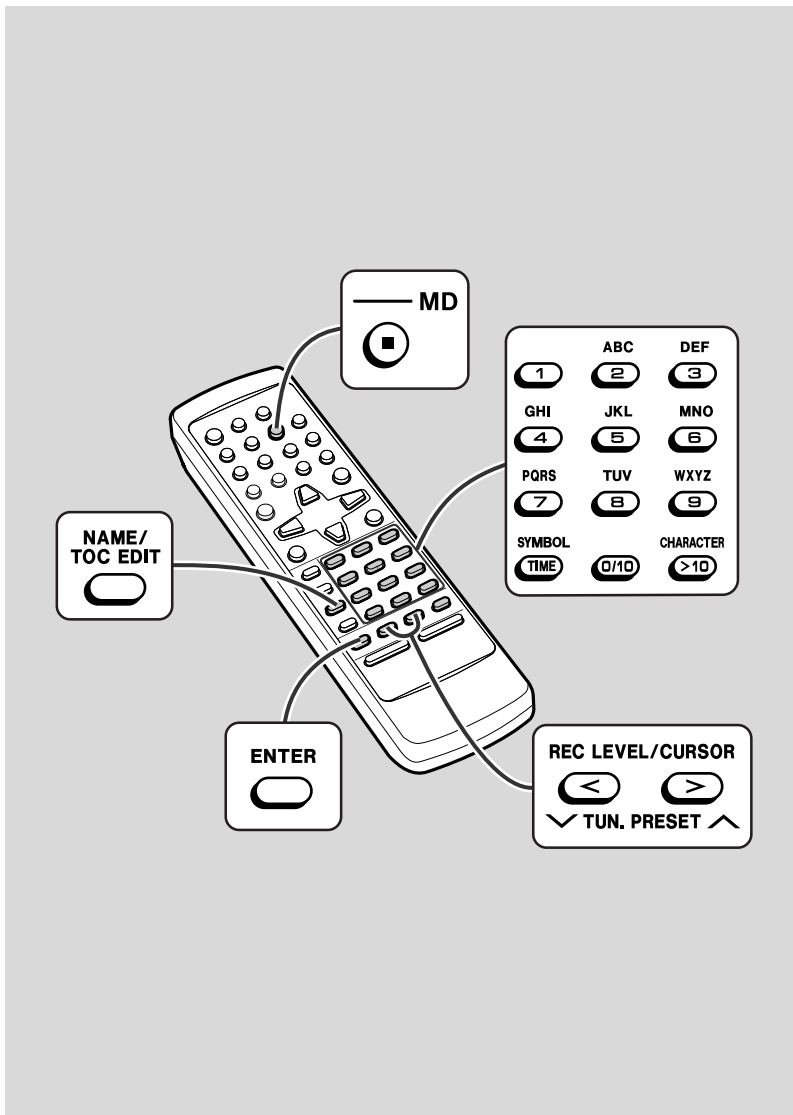

■ Creating disc and track names

You can give a name to discs and tracks.

One disc name and up to 255 track names can be created per disc (a maximum of 40 characters for the disc and each track name and a total of 1,700 characters can be entered).

- Playback-only MiniDisc cannot be edited.

1 Press the MD ■ button and load a MiniDisc. (See page 21.)

2 Select either "DISC NAME" or "TRACK NAME".

To create a disc name:

Whilst in the stop mode of MiniDisc, press the NAME/TOC EDIT button, and within 10 seconds, press the REC LEVEL/CURSOR < or > button to select "DISC NAME".

To create a track name:

During playback or in the pause mode of MiniDisc, press the NAME/TOC EDIT button to select "TRACK NAME".



3 Within 10 seconds, press the ENTER button.

- To cancel the operation, press the NAME/TOC EDIT button.

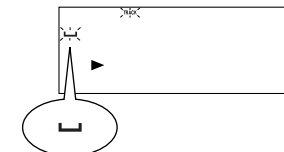
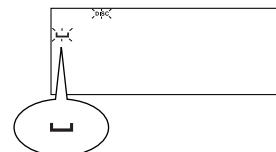

- The unit will enter the character input mode.

4 Press the 1 - 10, SYMBOL and CHARACTER buttons to enter the characters.



- The CHARACTER button allows switching between capital and small letters.
- You can enter the following symbols by pressing the SYMBOL button.

5 When the name has been completely entered, press the ENTER button.



Characters (symbols):

CHARACTER	1	ABC	DEF	GHI	JKL	MNO	PQRS	TUV	WXYZ	0/10
Capital letters	1	ABC 2	DEF 3	GHI 4	JKL 5	MNO 6	PQRS 7	TUV 8	WXYZ 9	0 []
Small letters	1	abc 2	def 3	ghi 4	jkl 5	mno 6	pqrs 7	tuv 8	wxyz 9	0 []

SYMBOL	TIME
- . , / : ? & () ! " # \$ % * ; < = > @ _ ` + ' []	

[] : indicates a space.

To erase disc and track names:

- 1 Perform steps 1- 2 in the "Creating disc and track names" section on page 42.
- 2 Press the TIMER/DELETE button for 3 seconds or more.
 - "NAME CLEAR?" will appear.
- 3 Press the ENTER button to finish.

To delete a character:

- 1 Perform steps 1- 3 in the "Creating disc and track names" section on page 42.
- 2 Press the REC LEVEL/CURSOR < or > button on the remote control to flash the character to be deleted.
- 3 Press the TIMER/DELETE button.
- 4 Press the ENTER button to finish.

To add a character:

- 1 Perform steps 1- 3 in the "Creating disc and track names" section on page 42.
- 2 Press the REC LEVEL/CURSOR < or > button on the remote control to flash the character before which you want to add a new character.
- 3 Select a character to enter, press the ENTER button.

Titling a MiniDisc (continued)

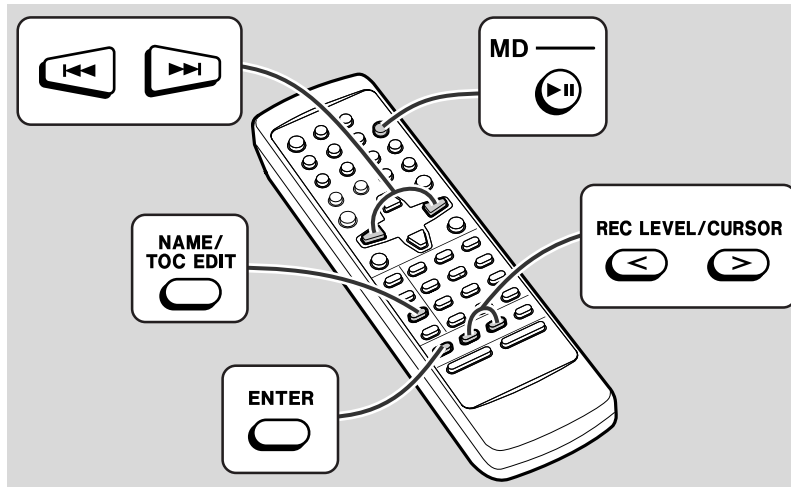

To change a character:

Example) To change "LAVE" to "LOVE"

- 1 Perform steps 1-3 in the "Creating disc and track names" section on page 42.
- 2 Press the REC LEVEL/CURSOR < or > button on the remote control to flash the character to be changed.

LAVE SONG

- 3 Press the TIMER/DELETE button.

LVE SONG

- 4 Enter a new character.

LOVE SONG

- 5 Press the ENTER button.

1:LOVE SO

Editing a Recorded MiniDisc

■ To divide a track

- 1 Play the track which you want to divide into two, and press the MD ►|| button at the point where you want to divide the track.

- 2 Press the NAME/TOC EDIT button, and within 10 seconds, select "DIVIDE" by pressing the REC LEVEL/CURSOR < or > button.

DIVIDE

- 3 Within 10 seconds, press the ENTER button.

DIVIDE OK?

- To cancel the operation, press the NAME/TOC EDIT button.

- 4 Press the ENTER button again.

- The track is divided, and the unit is stopped at the beginning of the second of the two tracks.
- The numbers of the tracks which come after the divided track are automatically increased by one.

Notes:

- If you divide a track that has a name and the date of recording, the two new tracks will have the same name and the date of recording.
- However, if there is not enough space to memorise the characters in "TOC", the second track will not be named.
- Each disc can hold up to 255 tracks. However, even if the number of assigned tracks has not reached 254, it might not be possible to make any further divisions of tracks.

■ To combine tracks

- 1 Whilst in the stop mode, select the second of the two adjacent tracks you want to combine by pressing the ◀◀ or ▶▶ button. Or start playing the second of the two tracks you want to combine, and then press the MD ▶|| button.



3^{TRACK} 4 : 12

- 2 Press the NAME/TOC EDIT button, and within 10 seconds, select "COMBINE" by pressing the REC LEVEL/CURSOR < or > button.



COMBINE

- 3 Within 10 seconds, press the ENTER button.

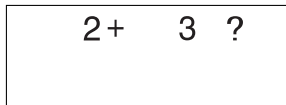

2+ 3 ?

- To cancel the operation, press the NAME/TOC EDIT button.

- 4 Press the ENTER button again.

- The two tracks are combined, and the unit is stopped at the beginning of the combined track.
- The numbers assigned to the tracks following the combined track are automatically decreased by one.

Notes:

- First, put the two tracks next to each other in the order you want using the MOVE function. Then combine them using the COMBINE function.
- This function cannot be used in the random play mode and programmed play mode.
- If both tracks to be combined have a name, or only the first track has a name, the first track name will be used.
- When the first track does not have a name, the combined track will be named as follows.
The second track name will be used for tracks recorded in monaural or stereo.
No name will be given to tracks recorded in 2 times or 4 times long recording mode.

In the following cases, tracks may not be combined.

- Digital recorded track and analogue recorded track.
- Tracks recorded in different recording modes (monaural, stereo, 2 times long recording, 4 times long recording) cannot be combined.
- Short tracks may not be combined (8 seconds for stereo, 16 seconds for monaural and 2 times long recording, 32 seconds for 4 times long recording).

Editing a Recorded MiniDisc (continued)

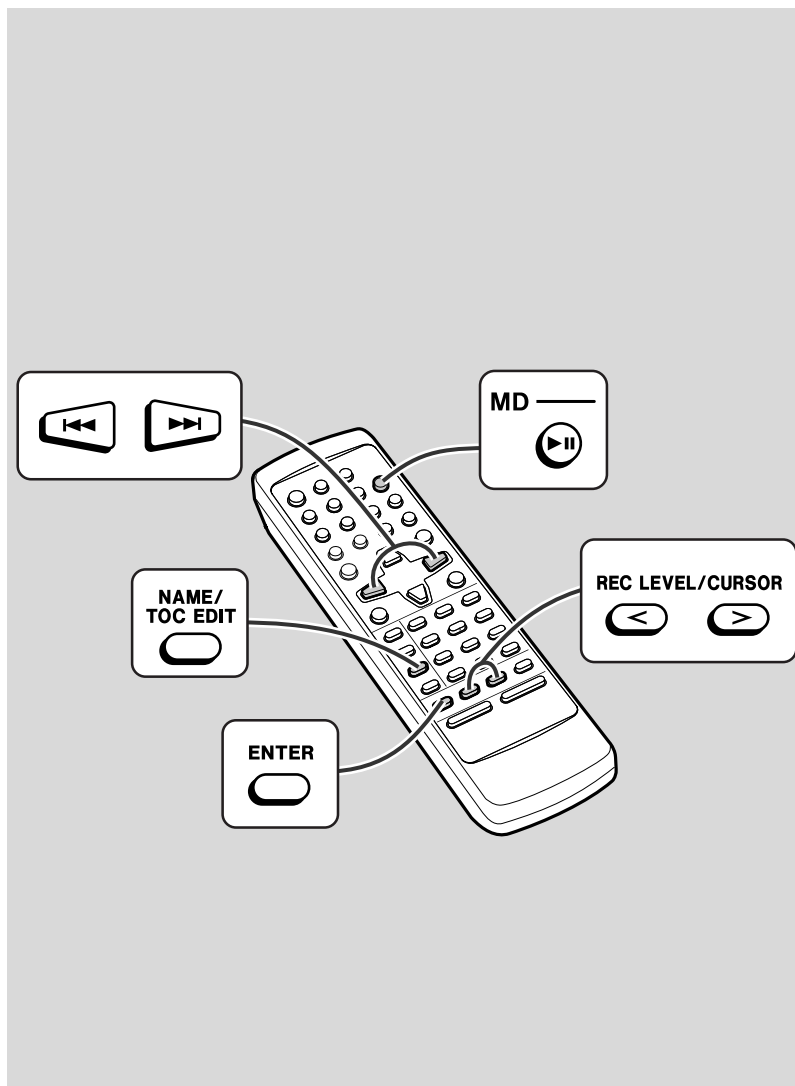

■ To move a track

- 1 Whilst in the stop mode, select the track you want to move by pressing the **⏮** or **⏭** button. Or start playing the track to be moved, and then press the **MD** **⏮** button.

4^{TRACK} 4 : 27

- 2 Press the **NAME/TOC EDIT** button, and within 10 seconds, select "MOVE" by pressing the **REC LEVEL/CURSOR** < or > button.

MOVE

- 3 Within 10 seconds, press the **ENTER** button.

4 → 1 ?

- 4 Select the new track position by pressing the **⏮** or **⏭** button.



4 → 1 ?

- To cancel the operation, press the **NAME/TOC EDIT** button.

- 5 Press the **ENTER** button again.

- The track is moved, and the unit is stopped at the beginning of the track selected in step 4.



■ To move the programmed tracks

- 1 Programme the tracks you want to move. (See page 25.)
- 2 Press the NAME/TOC EDIT button.

- 3 Within 10 seconds, press the ENTER button.

 - To cancel the operation, press the NAME/TOC EDIT button.
- 4 Press the ENTER button again.
 - Tracks are rearranged.
 - The programmed tracks will come to the top of the disc.

Note:

- If a track is programmed twice or more, the first instruction will precede to the others.

■ To erase one track

- 1 Whilst in the stop mode, select the track you want to erase by pressing the \lll or \ggg button. Or start playing the track to be erased, and then press the MD \ggg button to enter the pause mode.
- 2 Press the ERASE button.

 - To cancel the operation, press the MD \blacksquare button.
- 3 Press the ERASE button for 2 seconds or more.

 - The track is erased, and the unit is stopped at the beginning of the next track.

Caution:

Once a track has been erased, it cannot be recovered. Check the track number before erasing it.

Notes:

- When a track is erased, the numbers assigned to the tracks following the erased track will be automatically decreased by one.
- When a track is erased, the track name will be erased at the same time.
- It is also possible to erase tracks by selecting either menu of "ERASE" or "ALL ERASE" with the NAME/TOC EDIT button on the remote control.

Editing a Recorded MiniDisc (continued)

■ To erase all the tracks at once

- 1** Press the MD ■ button.
- 2** Press the ERASE button.

ERASE

ERASE OK?

 - To cancel the operation, press the MD ■ button.
- 3** Press the ERASE button for 3 seconds or more.

COMPLETE
TOC

➔

BLANK MD
TOC

 - All the track numbers and track names are erased.

■ To erase the programmed tracks at once

- 1** Programme the tracks you want to erase. (See page 25.)
 - Up to 20 tracks can be programmed.
- 2** Press the NAME/TOC EDIT button on the remote control.
- 3** Within 10 seconds, press the REC LEVEL/CURSOR < or > button on the remote control to select the "PRGM ERASE".

PRGM ERASE
PROGRAM
- 4** Within 10 seconds, press the ENTER button on the remote control.

PRGM ERASE?
PROGRAM

 - To cancel the operation, press the MD ■ button.
- 5** Press the ENTER button on the remote control.

COMPLETE
TOC

 - The programmed tracks are erased.

Timer and Sleep Operation

Timer playback:

The unit turns on and plays the desired source (CD, MD, TUNER, AUX) at the preset time. At the end time, the unit enters the power stand-by mode automatically.

Timer recording:

The unit turns on and starts recording from the desired source (TUNER, AUX) at the preset time. At the end time, the unit enters the power stand-by mode automatically.

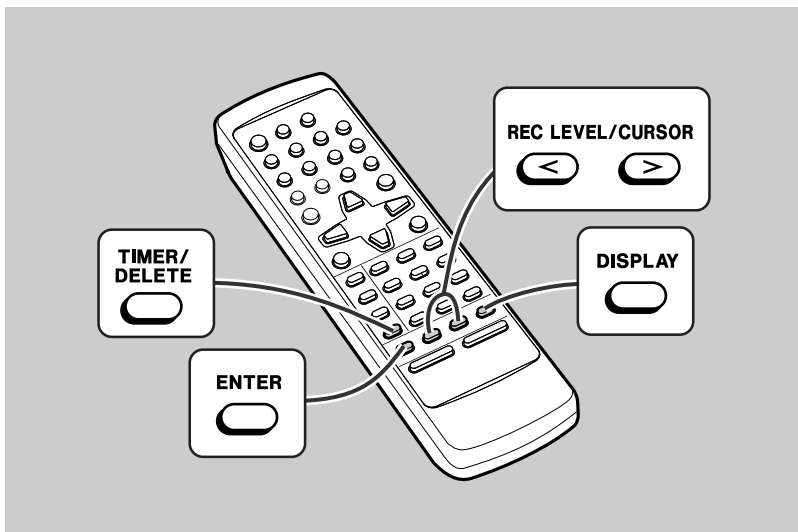

■ Timer playback/Timer recording

Before setting timer:

Whilst the power is in the stand-by mode, press the DISPLAY button on the remote control to check that the clock is on time.

10:00



1 Press the ON/STAND-BY button to turn the power on.

2 Press the TIMER/DELETE button.

STANDBY

3 Within 10 seconds, press the REC LEVEL/CURSOR < or > button to select "TIMER SET".

TIMER SET

4 Within 10 seconds, press the ENTER button.

TIMER PLAY

Continued to the next page

Timer and Sleep Operation (continued)

5 Press the REC LEVEL/CURSOR < or > button to select "TIMER PLAY" or "TIMER REC" mode.

For timer playback:

For timer recording:

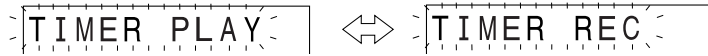

6 Press the ENTER button.

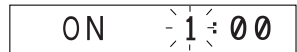

7 Press the REC LEVEL/CURSOR < or > button to specify the hour to start, and press the ENTER button.



8 Press the REC LEVEL/CURSOR < or > button to specify the minutes, and press the ENTER button.

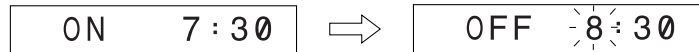

- Unless the timer setting is changed, the ending time will automatically be set for one hour after the starting time.

9 Press the REC LEVEL/CURSOR < or > button to specify the hour to stop, and press the ENTER button.

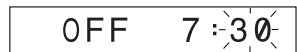

10 Press the REC LEVEL/CURSOR < or > button to specify the minutes, and press the ENTER button.

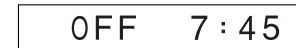

11 Press the REC LEVEL/CURSOR < or > button to select the desired function.

To select the timer playback source: CD, MD, TUNER or AUX.

To select the timer recording source: TUNER or AUX.

12 Press the ENTER button.

13 Press the REC LEVEL/CURSOR < or > button to adjust the volume.

- Be careful not to turn the volume up too high.

14 Press the ENTER button.

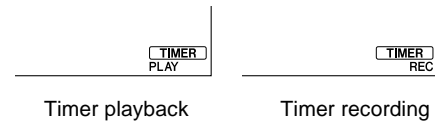

- The timer setting is displayed in order.
- The unit will enter the stand-by mode and then the playback or recording stand-by mode automatically.

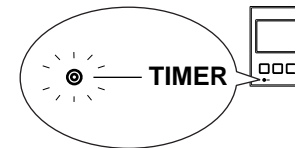

When the preset time is reached, playback or recording will start.

- In timer playback, the volume will increase gradually. In timer recording, it will start with the volume you set.

When the timer end time is reached, the system will enter the power stand-by mode automatically.

■ Using the same timer setting

Once memorised, the timer setting can be used as follows.

1 Press the **TIMER/DELETE** button.

2 Within 10 seconds, press the **REC LEVEL/CURSOR < or >** button to select "STANDBY".



STANDBY

If "STANDBY" is not displayed, the clock setting has been cleared.

In this case, reset the clock and the timer.

3 Within 10 seconds, press the **ENTER** button.

The timer setting is displayed in order.

The unit will enter the stand-by mode and then the playback or recording stand-by mode automatically.

Notes:

- The timer setting will be cleared when the unit is unplugged or the power failure occurs.
- The timer playback is possible with a CD or MD even if the repeat, random, or programmed playback is set.
- When performing timer playback or recording using another unit connected to the AUX INPUT sockets, select "AUX" in step 11. At this time, only this stereo system will be turned off automatically. (Another unit will not be turned off.)

To check the timer setting:

- 1 Whilst in the timer playback or timer recording stand-by mode, press the **TIMER/DELETE** button.
- 2 Within 10 seconds, press the **REC LEVEL/CURSOR < or >** button to select "TIMER CALL".



TIMER CALL

3 Press the **ENTER** button.

- After the timer setting is displayed in order, the display will return to normal.

To change the timer setting:

Perform "Timer playback/Timer recording" from the beginning. (See pages 49 -50).

To cancel the timer playback/timer recording:

- If the power is turned on whilst in the playback or recording stand-by mode, the timer setting will be cancelled.
- Proceed as follows to cancel without turning the power on.

- 1 Press the **TIMER/DELETE** button.
- 2 Within 10 seconds, press the **REC LEVEL/CURSOR < or >** button to select "CANCEL".



CANCEL

3 Press the **ENTER** button.

Timer and Sleep Operation (continued)

■ Sleep operation

The radio, CD, and MiniDisc can all be turned off automatically.

1 Play back the desired sound source.
2 Press the TIMER/DELETE button.
3 Within 10 seconds, press the REC LEVEL/CURSOR < or > button to select "SLEEP". <div style="text-align: center; border: 1px solid black; padding: 5px; width: fit-content; margin: 0 auto;">SLEEP 1 : 00</div>
4 Within 10 seconds, press the ENTER button. <div style="text-align: center; border: 1px solid black; padding: 5px; width: fit-content; margin: 0 auto;">SLEEP 1 : 00</div>
5 Press the REC LEVEL/CURSOR < or > button to specify the sleep time. <div style="text-align: center; border: 1px solid black; padding: 5px; width: fit-content; margin: 0 auto;">SLEEP 30</div> <p style="text-align: center; font-size: small;">(Maximum: 2 hours - Minimum: 1 minute)</p>
6 Press the ENTER button. <div style="text-align: center; border: 1px solid black; padding: 5px; width: fit-content; margin: 0 auto;">SLEEP 30 ▶ SLEEP SLEEP</div>
7 Your system will enter the power stand-by mode automatically after the preset time has elapsed. ● The volume will be turned down 1 minute before the sleep operation finishes.

To confirm the remaining sleep time:

- 1 Press the **TIMER/DELETE** button whilst the sleep timer is set.
- 2 Within 10 seconds, press the **REC LEVEL/CURSOR < or >** button to select "SLEEP".



Remaining sleep time

- The display will return to normal after approximately 10 seconds.
- You can change the sleep time.
- Press the **ENTER** button whilst the sleep remaining time is displayed (see steps 5 - 6 on the left).

To cancel the sleep operation:

The sleep timer is cancelled when the unit enters the stand-by mode.

To cancel only the sleep timer without setting the unit to the stand-by mode, proceed as follows.

- 1 Press the **TIMER/DELETE** button whilst the sleep timer is set.
- 2 Within 10 seconds, press the **REC LEVEL/CURSOR < or >** button to select "SLEEP OFF".



- 3 Within 10 seconds, press the **ENTER** button.

■ To use sleep and timer playback in combination

You can fall asleep to the radio and wake up with the sound from a CD.

1 Set the sleep time (steps 1 - 6, page 52).

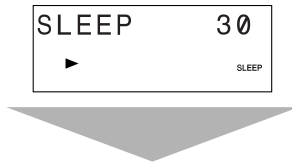

2 Set the timer playback (steps 1 - 14, pages 49 - 50).

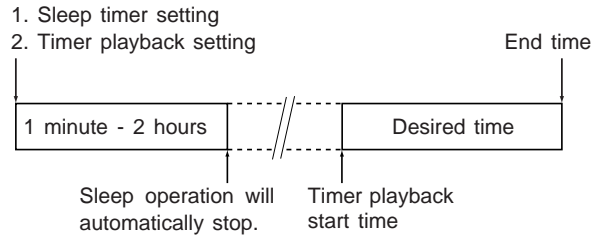
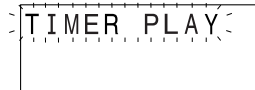

■ To use sleep and timer recording in combination

You can fall asleep to the sound from a CD and record the desired station whilst you are sleeping.

1 Set the sleep time (steps 1 - 6, page 52).



2 Set the timer recording (steps 1 - 14, pages 49 - 50).

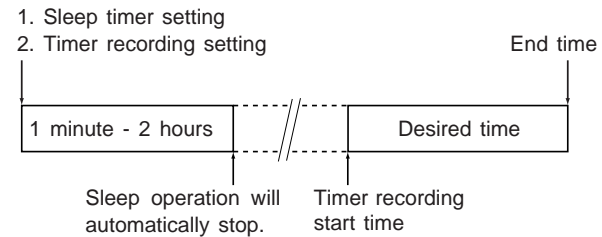

Enhancing Your Stereo System

Before connecting external units, set this unit to the stand-by mode and turn off the power of the external units.

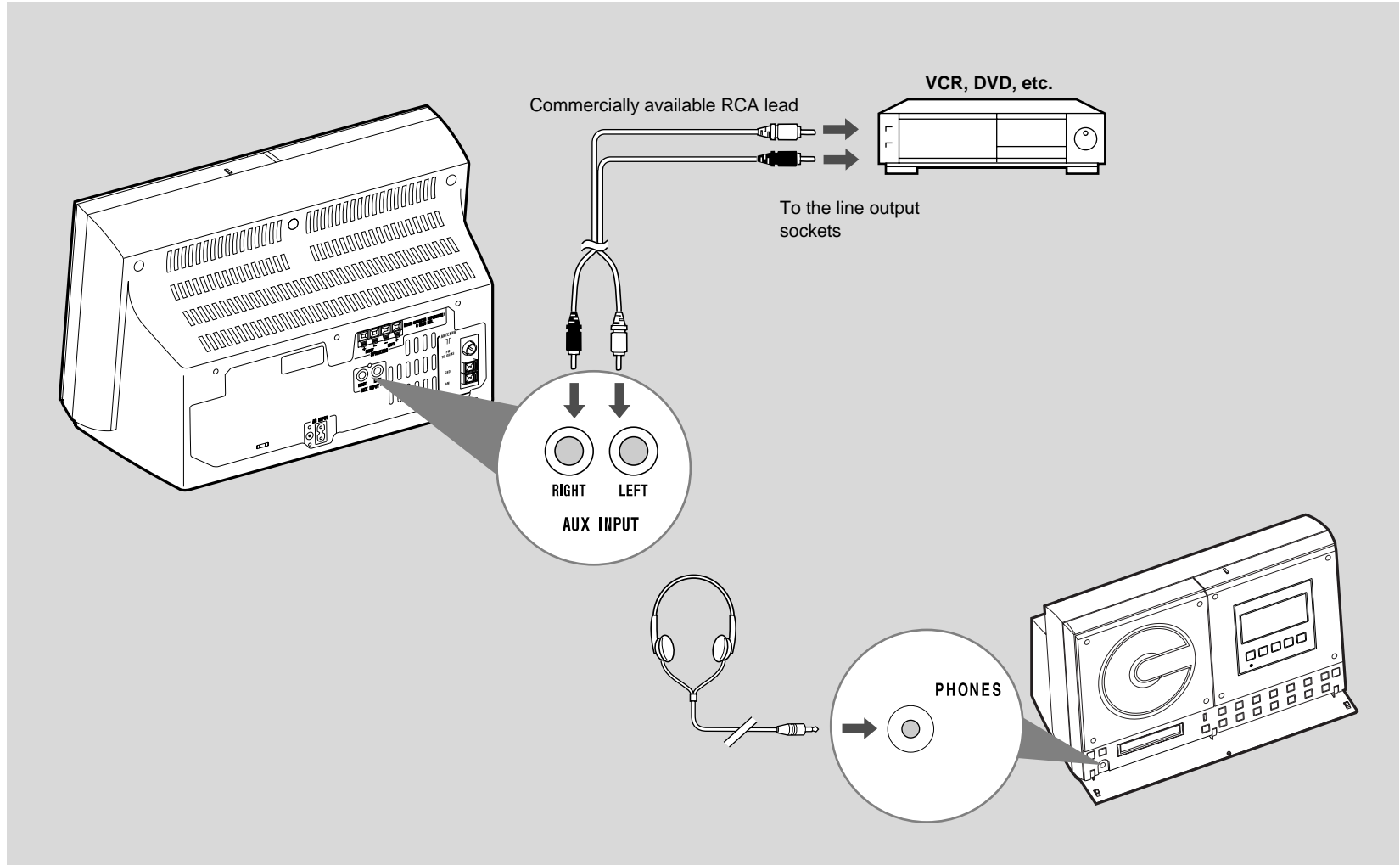

■ Listening to the playback sounds from VCR, DVD, etc.

- 1 Press the AUX (DEMO) button.
- 2 Play the connected equipment.
- 3 Adjust the volume using the VOLUME buttons.

■ Recording on a MiniDisc (Sound synchronised recording)

- 1 Press the AUX (DEMO) button.
- 2 Load a recordable MiniDisc into the MD compartment, label side up.
- 3 Press the S-SYNC ● REC button on the remote control.
- 4 Play the connected equipment.
 - Recording will start automatically.
 - The recording level is the level adjusted in the previous recording. (This level can also be adjusted whilst recording.)

■ Recording on a MiniDisc (Normal recording)

- 1 Press the AUX (DEMO) button.
- 2 Load a recordable MiniDisc into the MD compartment, label side up.
- 3 Press the REC ● button.
- 4 Play the connected equipment.
- 5 Press the < or > button to adjust the recording level.

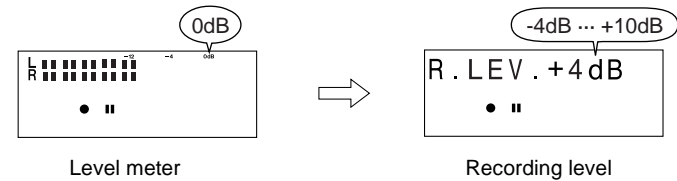

- Maximum level should not exceed "0dB".
 - The recording level can be adjusted in 2dB intervals between -4dB and +10dB.
 - If the recording level is too low, the sound volume will be decreased. If it is too high, the sound will be distorted.
- 6 Press the MD ►II button.

■ Headphones

- Before plugging in or unplugging the headphones, reduce the volume.
- Be sure your headphones have a 3.5 mm (1/8") diameter plug and are between 16 ohms and 50 ohms impedance. The recommended impedance is 32 ohms.
- Plugging in the headphones disconnects the speakers automatically. Adjust the volume using the VOLUME buttons.

What is a MiniDisc?

The disc is stored in a cartridge. You can handle it easily without worrying about dust, fingerprints, etc. However, dust entering the opening of the cartridge, dirt on the cartridge, warping, etc. may cause malfunctions. Please note the following.

■ To prevent recorded MiniDiscs from being erased accidentally

Slide the accidental erase prevention tab, located on the side of the MiniDisc, in the direction indicated by the arrow.

- The MiniDisc is then be protected against accidental erasure.

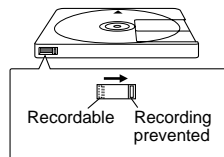

To add a recording to such a MiniDisc, slide the accidental erase prevention tab back to its original position.

■ Helpful tip when attaching a label

When attaching a label to a MiniDisc cartridge, be sure to note the following. If the label is not attached properly, the MiniDisc may jam inside the unit and it may not be possible to remove it.

- If the label peels off or partially lifts away, replace it with a new one.
- Do not put a new label on top of an existing one.
- Attach the label only in the specified location.



■ Types of discs

There are two types of discs: playback-only and recordable types.

● Playback-only MiniDisc:

This type of MiniDisc is used for commercially available prerecorded music. This is the same kind of optical disc as CDs. Playback is performed using an optical pickup. (Recording and editing are not possible.)

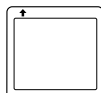

A Shutter will be used on only one side (back).

● Recordable MiniDisc:

This is a "raw disc" on which recording can be performed. A magneto optical disc is used. Recordings are made using a laser and magnetic field. Repeated recording is possible.

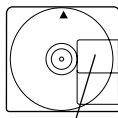

Shutters will be used on both sides.

MiniDisc System Limitations

Even if the maximum recording time of a MiniDisc has not been reached, "TOC FULL" may be displayed.	In the MD system, the delimiter of the recording area on a MiniDisc is programmed in a TOC. If partial erasing, recording and editing are repeated several times, TOC information will fill up, even though the number of tracks has not reached the limit (255 tracks), and further recording will be impossible. (If you use the all erase function, this MiniDisc can be used from the beginning.)
Even if the maximum recording time of a MiniDisc has not been reached, "DISC FULL" may be displayed.	If there is any flaw on the MiniDisc, that part is automatically excluded from the space available for recording. Therefore, the recording time becomes shorter.
Even if several short tracks are erased, the remaining recording time may not show an increase.	When the remaining recording time of a disc is displayed, short tracks less than 12 seconds long may not be included in the total.
Two tracks may not be combined in editing.	For MiniDiscs on which repeated recording and editing operations were performed, the COMBINE function may not work. A track recorded from a CD (digital recording) and a track recorded from a radio or other equipment (analogue recording) cannot be combined.
The total of the recorded time and time remaining on a disc may not add up to the maximum possible recording time.	A cluster (about 2 seconds) is normally the minimum unit of recording. So, even if a track is less than 2 seconds long, it will use about 2 seconds of space on the disc. Therefore, the time actually available for recording may be less than the remaining time displayed. If there are scratches on discs, those sections will be automatically avoided (no recording will be placed in those sections). Therefore, the recording time will be reduced.
If recorded tracks are fast reversed or fast forwarded, the sound may skip.	A MiniDisc which has been recorded or edited repeatedly may skip during fast reverse or fast forward.

Error Messages

When an error message is displayed, proceed as follows:

Error messages	Meaning	Remedy
BLANK MD	<ul style="list-style-type: none"> Nothing is recorded. (Neither music nor disc name is recorded.) 	<ul style="list-style-type: none"> Replace it with another disc.
Can't COPY	<ul style="list-style-type: none"> You tried to record from a copy prohibited CD. 	<ul style="list-style-type: none"> Replace the CD.
Can't EDIT	<ul style="list-style-type: none"> A track cannot be edited. 	<ul style="list-style-type: none"> Change the stop position of the track and then try editing it.
Can't READ* (*: Number or symbol)	<ul style="list-style-type: none"> The disc is damaged. TOC information cannot be read. MiniDisc not specified. 	<ul style="list-style-type: none"> Replace it with another disc. Erase the disc and try recording again.
Can't REC	<ul style="list-style-type: none"> Recording cannot be performed correctly due to vibration or shock in the unit. 	<ul style="list-style-type: none"> Re-record or replace the MiniDisc.
Can't T REC	<ul style="list-style-type: none"> Timer recording is impossible or there is no available space on the MD. The disc is out of recording space. 	<ul style="list-style-type: none"> Replace it with another recordable disc.
Can't WRITE	<ul style="list-style-type: none"> The TOC information could not be created properly due to a mechanical shock or to scratches on the disc. 	<ul style="list-style-type: none"> Set this unit to the stand-by mode and try to write the TOC again. (Remove any source of shock or vibration whilst writing.)
CD NO DISC	<ul style="list-style-type: none"> A CD has not been loaded. The CD data cannot be read. 	<ul style="list-style-type: none"> Load a CD. Reload the CD.
DISC FULL	<ul style="list-style-type: none"> The disc is out of recording space. 	<ul style="list-style-type: none"> Replace the disc with another recordable disc.
EDIT OVER	<ul style="list-style-type: none"> You chose 21 or more tracks for track editing. 	<ul style="list-style-type: none"> Decrease the number of tracks.
Er - MD ** (**: Number or symbol)	<ul style="list-style-type: none"> A MiniDisc is not working properly. 	<ul style="list-style-type: none"> Press the MD \blacktriangle button. Set this unit to the stand-by mode and turn the power on again.

Error messages	Meaning	Remedy
MD NO DISC	<ul style="list-style-type: none"> A MiniDisc has not been loaded. The MiniDisc data cannot be read. 	<ul style="list-style-type: none"> Load a MiniDisc. Reload the MiniDisc.
NAME FULL	<ul style="list-style-type: none"> The number of characters for the disc name or track name exceeds 40. 	<ul style="list-style-type: none"> Shorten the disc or track name.
NOT AUDIO	<ul style="list-style-type: none"> The data recorded on this disc is not audio data. 	<ul style="list-style-type: none"> Replace the disc.
PLAYBACK MD	<ul style="list-style-type: none"> You tried to record on a playback-only disc. 	<ul style="list-style-type: none"> Replace it with another recordable disc.
POWER ?	<ul style="list-style-type: none"> A MiniDisc is not working properly. 	<ul style="list-style-type: none"> Set this unit to the stand-by mode and turn the power on again.
PROTECTED	<ul style="list-style-type: none"> The disc is write protected. 	<ul style="list-style-type: none"> Move the write protection tab back to its original position.
TEMP OVER	<ul style="list-style-type: none"> The temperature is too high. 	<ul style="list-style-type: none"> Set this unit to the stand-by mode and wait for a whilst.
TOC FORM ** (**: Number or symbol)	<ul style="list-style-type: none"> TOC information recorded on the MD does not match the MiniDisc specifications or it cannot be read. 	<ul style="list-style-type: none"> Replace it with another disc. Erase the disc and try recording again.
TOC FULL	<ul style="list-style-type: none"> There is no space left for recording track numbers. 	<ul style="list-style-type: none"> Replace it with another recordable disc.
TOC FULL 1	<ul style="list-style-type: none"> There is no space left for recording character information. 	<ul style="list-style-type: none"> Replace it with another recordable disc. Erase the needless characters.
? MD DISC	<ul style="list-style-type: none"> The data contains an error. MiniDisc not specified. 	<ul style="list-style-type: none"> Press the MD \blacktriangle button. Replace it with another disc.

Troubleshooting Chart

Many potential "problems" can be resolved by the owner without calling a service technician.

■ General

Symptom	Possible cause
● "TIME ADJUST" appears when the clock time is checked.	● Did a power failure occur? Reset the clock. (Refer to page 17.)
● When a button is pressed, the unit does not respond.	● Set this unit to the power stand-by mode and then turn it back on.
● No sound is heard.	● Is the volume level set to "0"? ● Are the headphones connected? ● Are the speaker wires disconnected?
● The picture on the TV screen is distorted.	● When a radio or TV which uses an indoor aerial is placed near the unit, the picture on the TV screen may be distorted or the radio may not function properly. ● It is recommended that you use an external aerial.

■ CD player

Symptom	Possible cause
● Even though a disc has been loaded, "CD NO DISC" or "Can't READ" is displayed.	● The disc is very dirty. ● Is the unit located near excessive vibrations? ● Has condensation formed inside the unit?
● Playback does not start.	● The disc is loaded upside down.
● Playback stops in the middle or is not performed properly.	● The disc does not satisfy the standards. ● The disc is distorted or scratched.
● Playback sounds are skipped, or stopped in the middle of a track.	● Is the unit located near excessive vibrations? ● The disc is very dirty. ● Has condensation formed inside the unit?

■ MiniDisc

Symptom	Possible cause
● A recording cannot be made.	● Is the MiniDisc protected against accidental erasure? ● Did you try to make recording on a playback-only MiniDisc? ● Can you see the "DISC FULL" or "TOC FULL" message in the display?
● Even though a disc has been loaded, "MD NO DISC" or "Can't READ" is displayed.	● The disc is very dirty. ● Is the unit located near excessive vibrations?
● Playback sounds are skipped.	● Has condensation formed inside the unit?

■ Tuner

Symptom	Possible cause
● Radio makes unusual noise consecutively.	● The stereo system is placed near the TV or computer. ● FM/AM loop aerial is not placed properly. Move the AC power lead away from the aerial if located near.
● The preset channel cannot be recalled.	● Did a power failure occur? ● Preset the channel again.

■ Remote control

Symptom	Possible cause
● The remote control does not operate.	● Is the AC power lead of the stereo system plugged in? ● The battery polarity is not correct. ● The batteries are dead. ● Incorrect distance or angle. ● Does the remote control sensor receive strong light?

■ If trouble occurs (reset)

When this product is subjected to strong external interference (mechanical shock, excessive static electricity, abnormal supply voltage due to lightning, etc.) or if it is operated incorrectly, it may malfunction.

If such a problem occurs, do the following:

Unplug the power lead from the AC socket. Then, plug it in again and retry the operation.

Caution:

This operation will erase all data stored in memory including clock, timer settings, tuner preset, and CD or MiniDisc programme.

■ Condensation

Sudden temperature changes, storage or operation in an extremely humid environment may cause condensation inside the cabinet (CD pickup, MD pickup, etc.) or on the transmitter on the remote control.

Condensation can cause the unit to malfunction. If this happens, leave the power on with no disc in the unit until normal playback is possible (about 1 hour). Wipe off any condensation on the transmitter with a soft cloth before operating the unit.

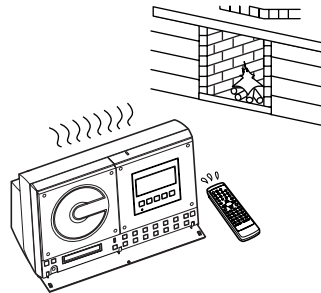

■ Before transporting the unit

Remove the CD and MiniDisc from the unit. Your unit checks whether there are any discs inside. "CD NO DISC" and "MD NO DISC" appear if no disc is inside. Then, set the unit to the power stand-by mode. Carrying the unit with discs left inside can damage it.

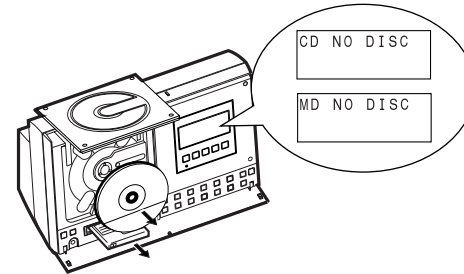

Maintenance

■ Cleaning the CD pickup lens

- Do not touch the CD pickup lens. If fingerprints or dust accumulate on the pickup, clean it gently with a dry cotton swab.

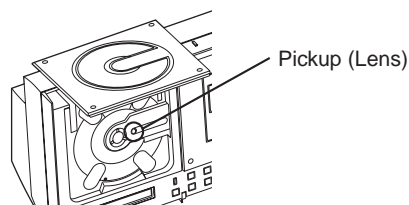

■ Cleaning the cabinet

Periodically wipe the cabinet with a soft cloth and a diluted soap solution, then with a dry cloth.

Caution:

Do not use chemically treated cleaning cloths or other chemicals.

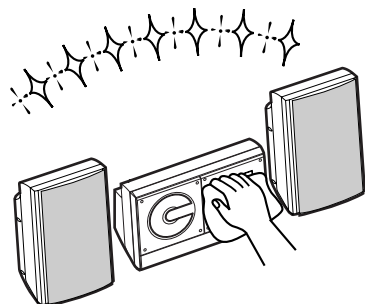

Specifications

As part of our policy of continuous improvement, SHARP reserves the right to make design and specification changes for product improvement without prior notice. The performance specification figures indicated are nominal values of production units. There may be some deviations from these values in individual units.

■ General

Power source	AC 230 V, 50 Hz
Power consumption	Power on: 42 W Power stand-by: 0.6 W (*)
Dimensions	Width: 330 mm (13") Height: 208 mm (8-3/16") Depth: 190 mm (7-1/2")
Weight	5.0 kg (11 lbs.)

(*) This power consumption value is obtained when the demonstration mode is cancelled in the power stand-by mode. Refer to page 14 to cancel the demonstration mode.

■ Amplifier

Amplification system	64fs 1-bit switching (Remarks: fs = 44.1 kHz)
Rated output power	RMS: 40 W (20 W + 20 W) (DIN 45 324)
A/D noise shaping	7th-order $\Delta\Sigma$ (delta - sigma) modulation
Output terminals	Speakers: 6 ohms Headphones: 16 - 50 ohms (recommended: 32 ohms)
Input terminals	Auxiliary: 500 mV/47 kohms

■ CD player

Type	1-disc vertical compact disc player
Signal readout	Non-contact, 3-beam semiconductor laser pickup
D/A converter	1-bit D/A converter
Frequency response	20 - 20,000 Hz
Dynamic range	90 dB (1 kHz)

■ MiniDisc

Type	MiniDisc Recorder
Signal readout	Non-contact, 3-beam semiconductor laser pickup
Rotation speed	400 - 900 rpm CLV, Approx.
Error correction	ACIRC (Advanced Cross Interleave Reed-Solomon Code)
Quantization	20-bit linear (A/D converter)
Coding	ATRAC (Adaptive TRansformed Acoustic Coding), ATRAC 3
Sampling frequency	44.1 kHz
Recording method	Magnetic modulation overwrite method
Frequency response	20 - 20,000 Hz
D/A converter	1-bit D/A converter
Wow and flutter	Unmeasurable (less than 0.001% W. peak)
Signal/noise ratio	95 dB (1 kHz)
Dynamic range	90 dB (1 kHz)
Audio channel	Stereo: 2 channels (SP, LP2, LP4) Monaural: 1 channel (MONO)

■ Tuner

Frequency range	FM: 87.5 - 108 MHz AM: 522 - 1,620 kHz
------------------------	---

■ Speaker

Type	2-way type speaker system 2 cm (13/16") Tweeter 12 cm (4-3/4") Woofer
Maximum input power	40 W
Rated input power	20 W
Impedance	6 ohms
Dimensions	Width: 170 mm (6-3/4") Height: 300 mm (11-13/16") Depth: 186 mm (7-3/8")
Weight	2.0 kg (4.4 lbs.)/each

MEMO

MEMO

TERMS OF GUARANTEE

Sharp Electronics (UK) Ltd. ("Sharp") guarantees to provide for the repair, or at its option the replacement, of this product subject to the conditions listed below:-

1. This guarantee shall only apply to faults which are due to inferior workmanship or materials. It does not cover faults or damage caused by accident, misuse, fair wear and tear, neglect, tampering with the product, or repair other than by a Service Facility appointed by Sharp.
2. As this product is intended for private domestic use only, the guarantee will not apply if the product is used in the course of a business, trade or profession.
3. To benefit from this guarantee, any fault which occurs must be notified to Sharp, or its appointed Service Facility within one year from the date this product was purchased. Proof of purchase must be provided.
4. The guarantee does not cover carriage costs, jewelled styli, audio tapes, compact discs or batteries.
5. In the unlikely event of this product requiring repair, please contact the supplier from whom it was purchased. Where this is not possible, please contact the Sharp Customer Information Centre on the telephone number given below.
6. No person has any authority to vary the terms or conditions of this guarantee.
7. This guarantee is offered as an additional benefit to your statutory rights, and does not affect these rights in any way.

If you have any difficulty operating this product, or would like information on other Sharp products, please telephone the Sharp Customer Information Centre on the number given below.

Sharp Customer Information Centre - Telephone 08705 274277

SHARP

SHARP ELECTRONICS (U.K.) LTD.

Sharp House, Thorp Road, Newton Heath, Manchester, M40 5BE

SHARP CORPORATION

TINSE0352AWZZ
A0012.YT

Free Manuals Download Website

<http://myh66.com>

<http://usermanuals.us>

<http://www.somanuals.com>

<http://www.4manuals.cc>

<http://www.manual-lib.com>

<http://www.404manual.com>

<http://www.luxmanual.com>

<http://aubethermostatmanual.com>

Golf course search by state

<http://golfingnear.com>

Email search by domain

<http://emailbydomain.com>

Auto manuals search

<http://auto.somanuals.com>

TV manuals search

<http://tv.somanuals.com>