

# SHARP®

LIQUID CRYSTAL DISPLAY CAMCORDER

MODEL

**VL-Z1H**

■ OPERATION MANUAL ■

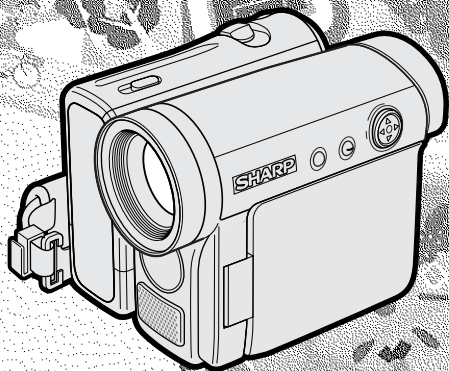

**Viewcam Z**

**CG Silicon**

Mini **DV**

• The **Mini DV** logo is a trademark.

Please read this operation manual carefully before using the camcorder.

If you require any advice or assistance regarding your Sharp product, please visit our web-site [www.sharp.co.uk/customersupport](http://www.sharp.co.uk/customersupport). Customers without Internet access may telephone 08705 274277 during office hours (or (01)676 0648 if telephoning from Ireland).

This equipment complies with the requirements of Directives 89/336/EEC and 73/23/EEC as amended by 93/68/EEC.

Dieses Gerät entspricht den Anforderungen der EG-Richtlinien 89/336/EWG und 73/23/EWG mit Änderung 93/68/EWG.

Ce matériel répond aux exigences contenues dans les directives 89/336/CEE et 73/23/CEE modifiées par la directive 93/68/CEE.

Dit apparaat voldoet aan de eisen van de richtlijnen 89/336/EEG en 73/23/EEG, gewijzigd door 93/68/EEG.

Dette udstyr overholder kravene i direktiv nr. 89/336/EEC og 73/23/EEC med tillæg nr. 93/68/EEC.

Quest' apparecchio è conforme ai requisiti delle direttive 89/336/EEC e 73/23/EEC, come emendata dalla direttiva 93/68/EEC.

Η εγκατάσταση αυτή ανταποκρίνεται στις απαιτήσεις των οδηγιών της Ευρωπαϊκής Ένωσης 89/336/ΕΟΚ και 73/23/ΕΟΚ, όπως οι κανονισμοί αυτοί συμπληρώθηκαν από την οδηγία 93/68/ΕΟΚ.

Este equipamento obedece às exigências das directivas 89/336/CEE e 73/23/CEE, na sua versão corrigida pela directiva 93/68/CEE.

Este aparato satisface las exigencias de las Directivas 89/336/CEE y 73/23/CEE, modificadas por medio de la 93/68/CEE.

Denna utrustning uppfyller kraven enligt riktlinjerna 89/336/EEC och 73/23/EEC så som kompletteras av 93/68/EEC.

Dette produktet oppfyller betingelsene i direktivene 89/336/EEC og 73/23/EEC i endringen 93/68/EEC.

Tämä laite täyttää direktiivien 89/336/EEC ja 73/23/EEC vaatimukset, joita on muutettu direktiivillä 93/68/EEC.

**WARNING**

**To prevent fire or shock hazard, do not expose this apparatus to dripping or splashing. No objects filled with liquids, such as vases, should be placed on the apparatus.**

This equipment should be used with the recommended AC adapter or battery pack.

**CAUTION**

To prevent electric shocks and fire hazards, do NOT use any other power source.

**Important:**

Recording and playback of any material may require consent. Please refer particularly to the provisions of the Copyright Act 1956, the Dramatic and Musical Performers Protection Act 1958, the Performers Protection Acts 1963 and 1972 and to any subsequent statutory enactments and orders.

**CAUTION**



To prevent shock, do not open the cabinet. No user serviceable parts inside. Refer servicing to a qualified dealer or service centre.

**Power supply:**

**WARNING: THIS AC ADAPTER IS NOT FOR USE WITH TOYS. THIS AC ADAPTER IS FOR USE WITH SHARP CAMCORDER MODEL VL-Z1H ONLY.**

This unit can be operated by connecting it to either the AC adapter or battery pack. The AC adapter incorporates the AUTO VOLTAGE (AC 110–240 V, 50/60 Hz) function.

## SPECIAL NOTE FOR USERS IN THE U.K.

The mains lead of this product is fitted with a non-rewireable (moulded) plug incorporating a 3A fuse. Should the fuse need to be replaced, a BSI or ASTA approved BS 1362 fuse marked  or  and of the same rating as above, which is also indicated on the pin face of the plug, must be used.

Always refit the fuse cover after replacing the fuse. Never use the plug without the fuse cover fitted.

In the unlikely event of the socket outlet in your home not being compatible with the plug supplied, cut-off the mains plug and fit an appropriate type.

**DANGER:** The fuse from the cut-off plug should be removed and the cut-off plug destroyed immediately and disposed of in a safe manner.

Under no circumstances should the cut-off plug be inserted elsewhere into a 13A socket outlet, as a serious electric shock may occur.

To fit an appropriate plug to the mains lead, follow the instructions below:

**IMPORTANT:** The wires in the mains lead are coloured in accordance with the following code:

**Blue: Neutral**  
**Brown: Live**

As the colours of the wires in the mains lead of this product may not correspond with the coloured markings identifying the terminals in your plug, proceed as follows:

- The wire which is coloured blue must be connected to the plug terminal which is marked N or coloured black.
- The wire which is coloured brown must be connected to the plug terminal which is marked L or coloured red.

Ensure that neither the brown nor the blue wire is connected to the earth terminal in your three- pin plug.

Before replacing the plug cover make sure that:

- If the new fitted plug contains a fuse, its value is the same as that removed from the cut-off plug.
- The cord grip is clamped over the sheath of the mains lead and not simply over the lead wires.

IF YOU HAVE ANY DOUBT, CONSULT A QUALIFIED ELECTRICIAN.

**NOTE:**

The LCD panel of this camcorder is a very high technology product with more than 215,000 thin-film transistors\*, giving you fine picture detail. Occasionally, a pixel may appear on the screen as a fixed point of blue, green, red, or black. Please note that this does not affect the performance of your camcorder.

\*Specifications are subject to change without notice.

# Contents

Supplied Accessories .....	ix
Optional Accessories .....	ix
Precautions .....	x

<b>Operation References</b>	Part Names .....	1
	Warning Indicators .....	4

<b>Preparation</b>	Attaching and Removing the Battery Pack .....	5
	Charging the Battery Pack .....	7
	Powering the Camcorder from an AC Outlet .....	8
	Inserting and Removing a Cassette .....	9
	Installing the Lithium Batteries .....	10
	Setting the Date and Time .....	12
	Using the Lens Cap .....	13
	Adjusting the Hand Strap .....	14
	Using the Grip .....	14
	Detaching the Lens Hood .....	15
	Using the Viewfinder .....	15
	Using the LCD Monitor .....	17
	Tips on Recording Positions .....	18

<b>Basic Operations</b>	<b>Camera Recording</b>	
	Easy Camera Recording in Full Auto Mode .....	19
	Zooming .....	20
	Power Standby Mode .....	21
	Turning on/off the Backlight .....	21
	Auto Focus .....	22
	Macro Shots .....	22
	Remaining Recording Time Display .....	23
	Remaining Battery Power Display .....	23
	<b>Playback</b>	
	Playback .....	24
	Volume Control .....	25
	Still .....	25
	Video Search .....	25
	Watching Playback on a TV .....	26

---

## **Useful Features**

Control Buttons .....	27
Using the Mode Screens .....	27
Using the Menu Screens .....	28

### **Camera Recording**

Setting the Digital Zoom .....	29
Backlight Compensation (BLC) .....	30
Gain-up .....	31
Fade in and Fade out .....	32
Quick Return .....	33
Edit Search .....	34
Still Recording .....	34
Digital Image Stabilization (DIS) .....	35
Self Recording .....	36
Wide Screen (16:9) .....	38
Recording in LP (Long Play Recording) Mode .....	39
Windbreak .....	40
Selecting the 16-bit Audio Recording Mode .....	41

### **Playback**

Using the Remote Control (Not supplied) .....	42
Playback Functions with the Remote Control (Not supplied) .....	43
Selecting the Date and Time of Recording Display .....	44
Picture Effect Playback .....	45
Rotate Playback .....	46

## **Advanced Features**

### **Camera Recording**

Manual Focus .....	47
Returning to Auto Focus .....	48
Displaying the Manual Setting Screen .....	48
White Balance Lock .....	49
Manual Iris .....	50
Manual Gain .....	51
Setting the Camcorder to Full Auto Mode .....	52
Scene Menu (Program AE) .....	53

# Contents

---

## **Advanced Features**

### **Playback**

Using the Time Code .....	54
Editing .....	55
Editing with the DV Terminal (IEEE1394) .....	56
Audio Dubbing Feature .....	57
Selecting the Audio Playback Mode .....	59

## **Appendix**



Picture/Backlight Adjustments .....	60
Turning off the Confirmation Sound .....	62
Setting the Camcorder to Factory Presettings .....	63
Demonstration Mode .....	64
Useful Information .....	65
<b>Troubleshooting .....</b>	<b>70</b>
Specifications .....	73
On-screen Display Index .....	74

### **Note:**

- Before requesting service, please read “Troubleshooting” carefully. (See pages 70–72.)

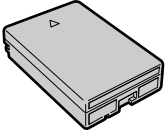
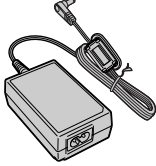
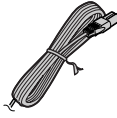
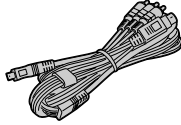

# Supplied Accessories

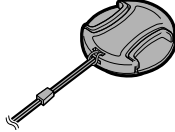
 <p>Battery pack BT-L226</p>	 <p>AC adapter</p>	 <p>Power cord</p>	 <p>Audio/video/S-video cable</p>
 <p>CR1216 type lithium battery</p>	 <p>Lens cap</p>		

# Optional Accessories

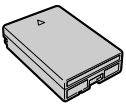
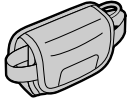
 <p>Standard-life battery pack BT-L226</p>	 <p>External battery with hand strap BT-LCA1</p>
---	---

# Precautions

- **Before recording an important scene, please perform the recording test, then playback to check if the scene was recorded properly. If noise occurs, use a commercially available cleaning tape to clean the video heads (see page xii).**

- **When the camcorder is not in use, remember to remove the cassette tape, turn off the power, and disconnect the camcorder from the power source.**

- **Do not aim the lens at the sun.**  
Do not allow direct sunlight to strike the camcorder lens, whether or not recording is in progress, as it may damage the CCD sensor. Be particularly careful when recording outside.

- **Avoid magnetic sources.**

Using the camcorder near strong fluorescent lights, motors, televisions, or other magnetic sources may adversely affect recorded images.

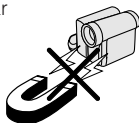

- **Using the camcorder near a broadcasting station or other powerful transmission source may cause buzzing or picture deterioration.**

- **Avoid shocks and dropping.**

Do not drop or otherwise subject the camcorder to hard shocks or strong vibrations. Bumping or striking the unit during recording will generate noise in the recorded image.

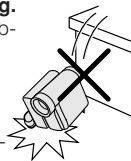

- **Avoid placing the camcorder in close proximity to lighting equipment.**

The heat from incandescent lights may deform the camcorder, or cause it to malfunction.



- **Always respect prohibitions or restrictions on the use of electronic equipment on commercial flights or in other sensitive areas.**

- **Be aware of the temperature and humidity.**

You can use your camcorder at 0°C to +40°C, and at 30% to 80% relative humidity. Do not store the unit in an unventilated car in the summer, in direct sunlight, or near strong heat sources; this can result in severe damage to the unit casing and circuitry.



- **Avoid situations where water, sand, dust or other foreign matter could get on or inside the camcorder, and do not use or leave your camcorder in areas with excessive smoke, steam or moisture.**

Such environments can cause malfunctions or cause mildew to form on the lenses. Be sure to keep the unit in a well-ventilated location.

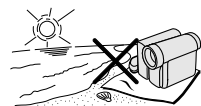

- **Some small, portable tripods may be difficult to attach and may not be sturdy enough to support your camcorder. Be sure to use only a strong, stable tripod.**

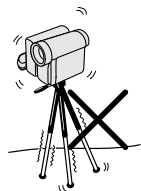

- **When using your camcorder in a cold environment, the LCD monitor screen often appears less bright immediately after the power is turned on. This is not a malfunction. To prevent the camcorder from becoming too cold, wrap it in a thick cloth (a blanket, etc.).**

## Dew Formation

### • What is “dew formation”?

When cold water is poured into a glass, dew drops form on the glass. This clinging of water drops is called dew formation.

### • When dew forms in your camcorder.

Dew will gradually form on the head drum of your camcorder and make the video tape stick to the head. This causes damage both to the head and the tape. When dew forms, recording and playback may not function properly.

Dew is likely to form in the following circumstances:

- When moving the camcorder from a cold place to a warm place.
- When placing the camcorder in a cold room which is then heated rapidly.
- When moving the camcorder outdoors from an air conditioned room or car.
- When placing the camcorder in the direct path of air blowing from an air conditioner.
- When placing the camcorder in a humid room.



### • How to prevent trouble.

When using the camcorder in a place where dew is likely to form, allow the camcorder and the video tape to acclimatise to the surroundings for about one hour.

For example, when bringing the camcorder indoors after skiing, place it in a plastic bag.

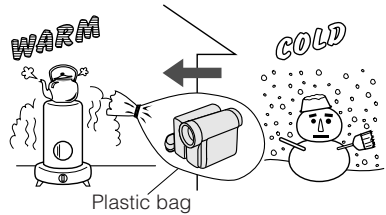

- ① Be sure to tightly seal the plastic bag containing the camcorder.
- ② Remove the bag when the air temperature inside it reaches the temperature of the room.

### • “Dew” warning feature

If dew forms, the word “DEW” flashes on the screen, and the power will automatically turn off in approximately 10 seconds.

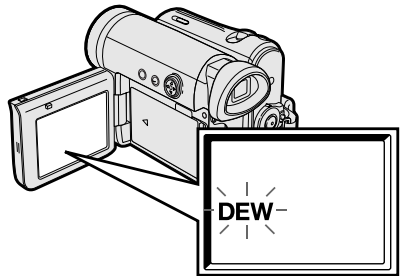

- ① If “DEW” flashes, remove the cassette, leave the cassette compartment open, and wait for a few hours to allow the camcorder to acclimatise to the surrounding temperature.
- ② To use the camcorder again, turn on the power after waiting for a few hours. Be sure that “DEW” has disappeared.
- ③ Do not insert a cassette while “DEW” is flashing; this may result in damage to the tape.
- ④ Since dew forms gradually, it may take 10 to 15 minutes before the dew warning feature engages.

## Precautions

### Dirty Video Heads

When the video heads have become clogged with dirt (dust and tape coating particles),

Striped noise



Mosaic noise

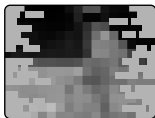

- mosaic-like noise appears on the playback picture. (see illustrations above)
- playback pictures do not move.
- during playback, the whole screen becomes blue.

### Causes of video head clogging

- High-temperature and high-humidity environment
- A lot of dust in the air
- Damaged tape
- Worn tape
- Long-time use
- Dew formation

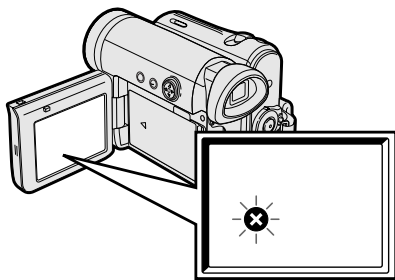



If the video heads become clogged, the  indicator appears on the screen. Contact your SHARP dealer for further advice or refer to page 70 "Troubleshooting".

### Using a Cleaning Tape (Commercially Available)

You can clean the video head with a commercially available cleaning tape.

#### Notes:

- Excessive use of the cleaning tape may cause damage to the video heads. Please read the instructions accompanying the cleaning tape carefully before using it.
- The fast forward and rewind functions cannot be used when the cleaning tape is in the camcorder.
- If the video heads again become clogged with dirt soon after cleaning, this might be caused by a damaged tape. In this case, stop using that cassette immediately.

- 1 Insert a cleaning tape into the camcorder.
- 2 Hold down the Lock button and set the Power switch to .
- 3 Press  on the Operation button to begin video head cleaning.
  - "NOW CLEANING" flashes during cleaning.

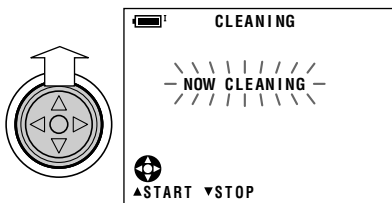

- After about 20 seconds, video head cleaning automatically finishes, and "EJECT THE CASSETTE." displays.

- 4 Remove the cleaning tape.

To cancel cleaning, press .

# Operation References

## Part Names

For details on the use of each part, refer to the page number indicated in parentheses.

### Front view

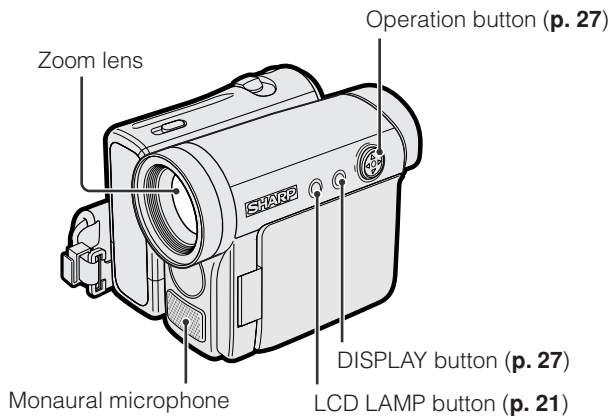

## Left view

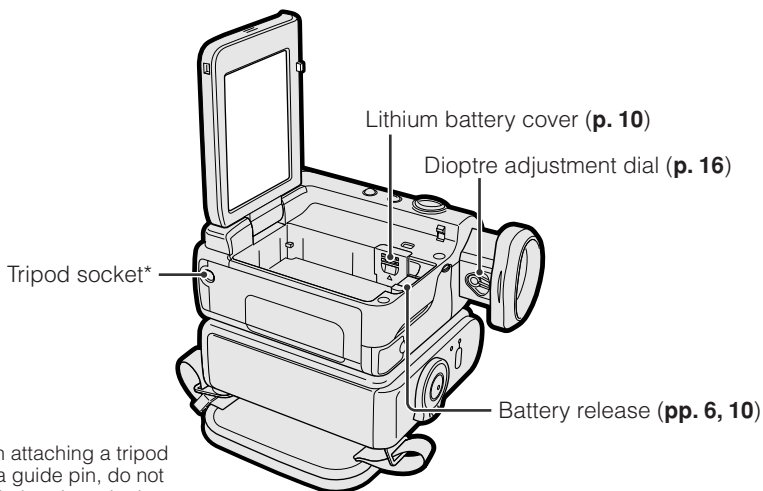
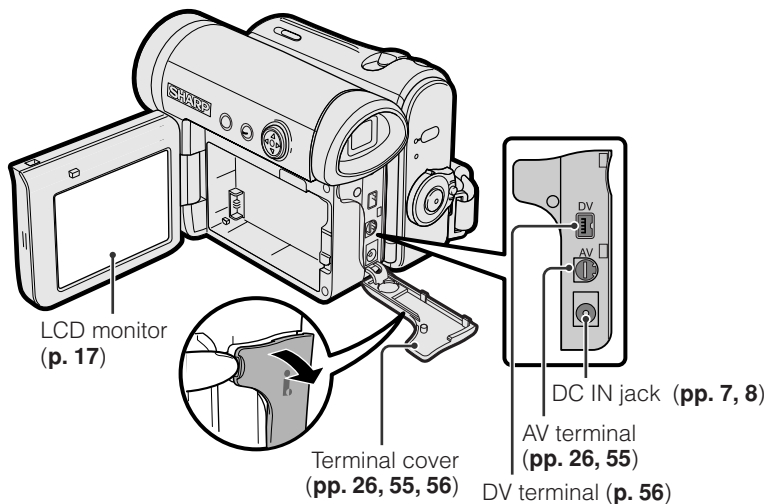

\* When attaching a tripod with a guide pin, do not attach the pin to the bottom of the camcorder.

## Right view

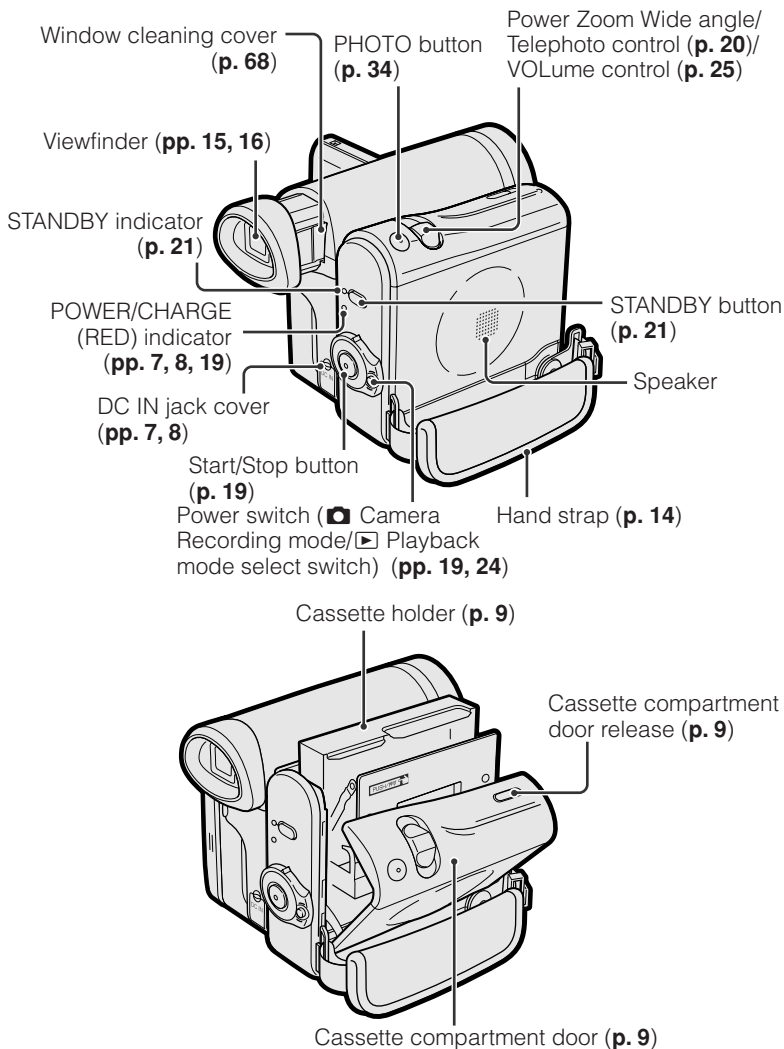

### Warning Indicators

If a warning indicator appears on the screen, follow the specified instructions.

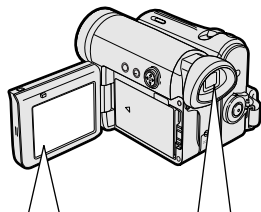

Displayed for the first 3 seconds	Displayed after 3 seconds	Description of warning
<b>INSERT A CASSETTE.</b>		There is no video cassette in the camcorder. Insert a cassette (see <b>page 9</b> ).
<b>EJECT THE CASSETTE.</b>	<b>EJECT THE CASSETTE.</b>	The video cassette is defective and should be removed (see <b>page 9</b> ).
<b>CASSETTE NOT RECORDABLE.</b>		The erasure protect tab on the video cassette has been slid to the record-protect position, preventing recording (see <b>page 66</b> ).
<b>THE TAPE ENDS SOON.</b>		The tape is about to end. Prepare a new cassette.
<b>CHANGE THE CASSETTE.</b>	<b>TAPE END</b>	The tape has reached the end. Replace it with a new cassette (see <b>page 9</b> ).
<b>BATTERY IS TOO LOW.</b>		The battery is almost depleted. Replace it with a fully charged battery pack (see <b>pages 5, 6</b> ).
<b>DEW</b>		Dew has formed inside the camcorder. Wait a few hours for the dew to dry away (see <b>page xi</b> ). About 10 seconds after this warning appears, the camcorder automatically turns off.
		The video heads are clogged and should be cleaned (see <b>page xii</b> ).
<b>LAMP</b>	<b>LAMP</b>	The fluorescent lamp behind the LCD monitor is close to the end of its service life. Call your local authorized Sharp dealer to have it replaced.

**Note:**

- indicates a flashing display.



# Preparation

## Attaching and Removing the Battery Pack

### Attaching

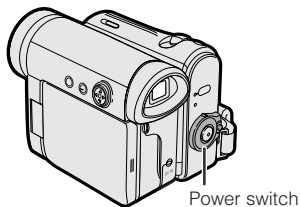

- 1 Make sure that the Power switch is set to OFF.

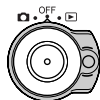

- 2 Open the LCD monitor to a 90° angle to the camcorder body.

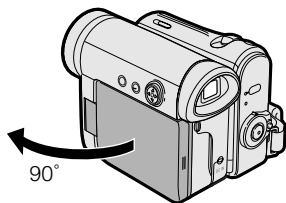

- 3 Slide the battery pack in the direction of the arrow with the "Δ" mark facing out.

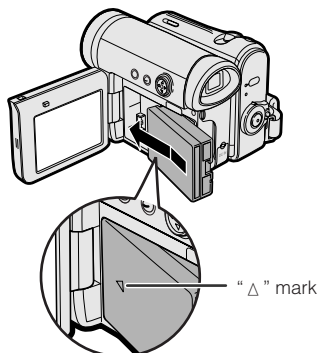

- 4 Push the battery pack in the direction of the arrow until it clicks.

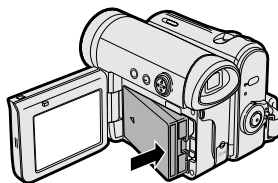

## Preparation

### Removing

- 1 Make sure that the Power switch is set to OFF, then open the LCD monitor to a 90° angle to the camcorder body.

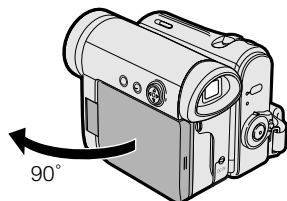

- 2 Slide the battery release in the direction of the arrow.

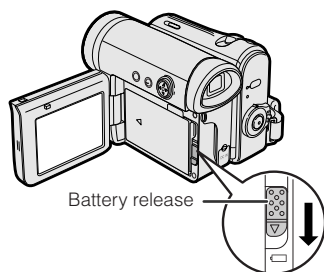

- 3 Take the battery pack out.

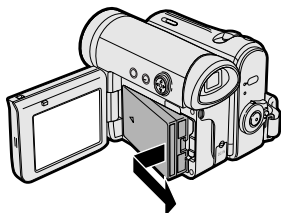

#### Notes:

- **BEFORE REMOVING THE BATTERY PACK, ALWAYS STOP RECORDING OR PLAYBACK AND TURN THE POWER OFF.**

Removing the battery pack while shooting or during playback may damage the tape by causing it to wrap around the video head drum.

- Remove the battery pack from the camcorder if you will not use the camcorder for a long period of time.
- Make sure that the battery pack is firmly attached during operation. If it is not, the battery pack may come off or camcorder operation may fail because of the poor contact pressure.
- To prevent damage to the battery pack when removing, be sure to firmly hold the battery pack while pressing the release.
- Use only SHARP model BT-L226 battery packs with this camcorder. Use of other batteries may create a risk of fire or explosion.
- Before closing the LCD monitor, make sure the battery pack is properly attached to the camcorder, otherwise the monitor may be damaged.

## Charging the Battery Pack

- 1 Attach the battery pack on the camcorder, and make sure that the Power switch is set to OFF.
- 2 Open the DC IN jack cover.

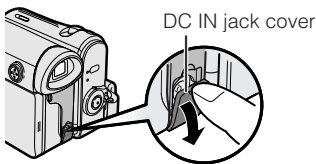

- 3 Connect the supplied power cord to the AC power socket on the AC adapter, and insert the AC plug into a power outlet.

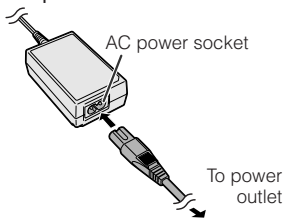

- 4 Insert the DC plug into the DC IN jack of the camcorder.

- The POWER/CHARGE (RED) indicator lights up red.

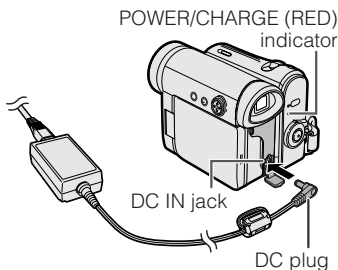

- The POWER/CHARGE (RED) indicator turns off when the battery is charged.

- 5 Remove the DC plug from the DC IN jack, then remove the AC adapter from the power outlet.

## Charging time and maximum continuous recording and playback times

Battery pack	Charging time	Max. continuous recording time		Max. continuous playback time on LCD
		LCD closed	LCD open	
BT-L226	120	120	105	105

- The chart specifies the approximate times in minutes.

### Notes:

- Charge the battery pack between 10°C and 30°C. The battery pack may not charge properly at temperatures too low or too high.
- The battery pack and AC adapter become warm during charging. This is not a malfunction.
- Using the zoom (see page 20) and other functions or turning the power on and off frequently will increase power consumption. This may result in a decrease in the actual recording time compared to the maximum continuous recording time listed above.
- The charging time and recording time may vary depending on the ambient temperature and the condition of the battery pack.
- See pages 67 and 68 for more information on using the battery pack.
- Charge only SHARP model BT-L226 battery packs. Other types of battery packs may burst, causing personal injury and damage.
- When attaching the supplied audio/video/S-video cable, remove the DC plug, open the terminal cover and connect it.

## Preparation

### Powering the Camcorder from an AC Outlet

You can also power the camcorder from a power outlet by using the supplied AC adapter.

#### Note:

- The supplied AC adapter is specially designed for use with this camcorder, and should not be used as a power supply for other camcorders.

- 1 Make sure that the Power switch is set to OFF.
- 2 Open the DC IN jack cover.

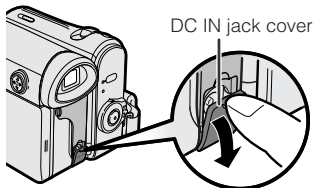

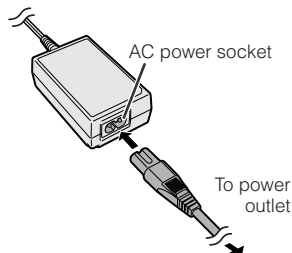

- 3 Connect the supplied power cord to the AC power socket on the AC adapter, and insert the AC plug into a power outlet.

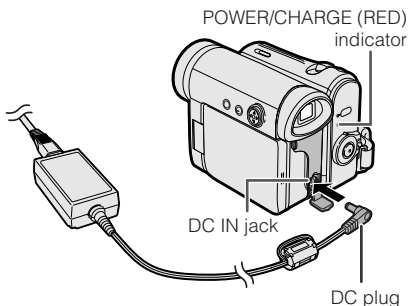

- 4 Insert the DC plug into the DC IN jack of the camcorder.



- 5 Hold down the Lock button and set the Power switch to  or .
  - The POWER/CHARGE (RED) indicator lights up green.

#### Notes:

- **BEFORE REMOVING THE DC PLUG, ALWAYS STOP RECORDING OR PLAYBACK AND TURN THE POWER OFF.** Removing the DC plug while shooting or during playback may damage the tape by causing it to wrap around the video head drum.
- Disconnect the AC adapter from the camcorder if you will not use the camcorder for a long period of time.

## Inserting and Removing a Cassette

### Inserting

- 1 Attach the power source to the camcorder, then slide and hold the cassette compartment door release as you open the cassette compartment door.

- After confirmation sound, the cassette holder extends and opens automatically.

Cassette compartment door release

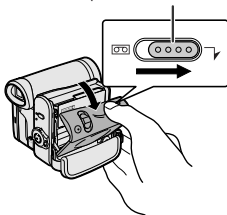

- 2 Insert a commercially available Mini DV cassette fully with the window facing outwards, and with the erasure protect tab facing upwards.

Erasure protect tab

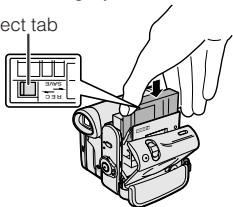

- 3 Press the "PUSH" mark gently until the cassette holder clicks into place.

- The cassette holder retracts automatically.

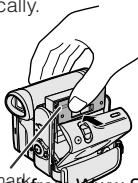

- 4 Wait for the cassette holder to fully retract. Close the compartment door by pressing its centre until it clicks into place.

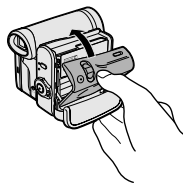

### Removing

Perform step 1 above, then take out the cassette.

#### Notes:

- Do not try to close the cassette compartment door while the cassette holder is extending or retracting.
- Be careful not to get your fingers caught in the cassette holder.
- Do not apply force to the cassette holder except when pressing the "PUSH" mark to close it.
- Do not tilt the camcorder or hold it upside down when you are inserting or removing a cassette. It may damage the tape.
- Remove the cassette if you will not use the camcorder for a long period of time.
- If you do not correctly close the cassette holder in step 3, the cassette protection mechanism of the camcorder might eject the cassette. If this happens, repeat the insertion procedure.
- Do not attempt to pick up the camcorder by the cassette compartment door.
- If the battery power is too low, you may not be able to eject the cassette. Replace the battery pack with a fully charged one.
- You can only use Mini DV cassettes. Large DV cassettes cannot be used. Be sure to use Mini DV cassettes with the **Mini DV** mark.
- See page 66 for more information on the video cassette tapes intended for use with this camcorder.

## Preparation

### Installing the Lithium Batteries

#### Installing the Memory Battery

The supplied CR 1216 type lithium battery is used to store the memory of the date and time settings.

- 1 Make sure that the Power switch is set to OFF.
- 2 Open the LCD monitor to a 90° angle to the camcorder body.
- 3 Slide the battery release in the direction of the arrow, then take the battery pack out.

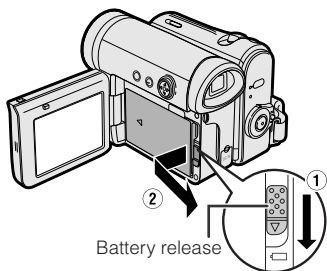

- 4 Pull out the lithium battery cover in the direction of the arrow.

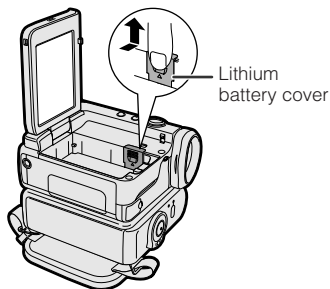

- 5 Insert the CR 1216 type lithium battery into the compartment with the + side of the battery facing out.

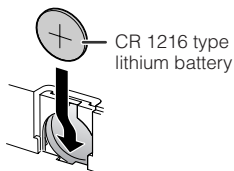

- 6 Close the lithium battery cover firmly until it clicks into place.

#### Removing the Memory Battery

Perform steps 1 to 4 above, then lift out the battery by using a pointed object such as the tip of a ballpoint pen.

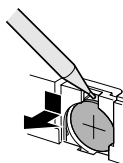

## Installing the Battery to Remote Control (Not Supplied)

The remote control (RRMCGA149WJSA) is not supplied with this camcorder. Contact the nearest SHARP service centre or your dealer for purchasing as specified part.

The CR 2025 type lithium battery is used to power the remote control unit.

- 1 Hold the remote control facing down, and pull out the battery holder while pressing the tab toward the centre.

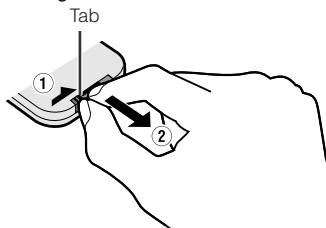

- 2 Insert the CR 2025 type lithium battery into the battery holder with the + side of the battery facing the ⊕ side of the holder.

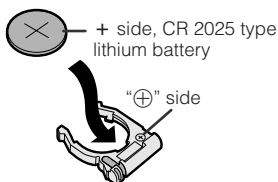

- 3 Insert the battery holder back into position.

## Notes on the Use of the Lithium battery

**CAUTION:** Danger of explosion if battery is incorrectly replaced. For camcorder, replace only with same or equivalent type CR1216, for remote control unit, replace only with same or equivalent type CR2025, both recommended by the equipment manufacturer.

**WARNING** KEEP THIS BATTERY AWAY FROM CHILDREN. IF SWALLOWED, CONSULT A PHYSICIAN IMMEDIATELY FOR EMERGENCY TREATMENT.

**CAUTION** BATTERY MAY EXPLODE IF MISUSED OR INSTALLED WITH POLARITY REVERSED. DO NOT RECHARGE, DISASSEMBLE OR DISPOSE OF IN FIRE.

- Do not short-circuit, recharge, disassemble, or heat the lithium battery.
- Should the lithium battery leak, wipe the battery compartment clean, and then insert a new battery.
- The lithium batteries will last about one year under normal usage.

## Setting the Date and Time

**Example:** Setting the date to 2 June 2004 (2. 6. 2004) and the time to 10:30 am (10:30).

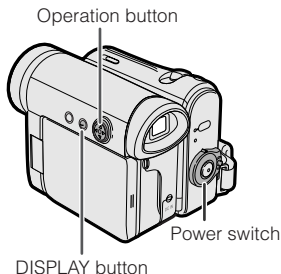

**Note:**

- Before performing the steps below, make sure that the CR1216 type lithium battery has been installed (see page 10).

- 1 Hold down the Lock button and set the Power switch to

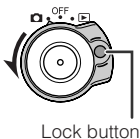

- 2 Press the DISPLAY button until the mode screen appears.



- 3 Press  $\nabla$  or  $\Delta$  on the Operation button to select “MENU”, then press the centre of the Operation button.



- 4 Press  $\Delta$  or  $\nabla$  to select “EXECUTE”, then press the centre of the Operation button.

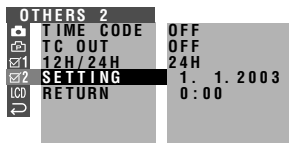

- 5 Press the centre of the Operation button.



- 6 Press  $\Delta$  or  $\nabla$  to select “2” (day), then press the centre of the Operation button.



- 7 Press  $\Delta$  or  $\nabla$  to select “6” (month), then press the centre of the Operation button.



- 8 Press  $\Delta$  or  $\nabla$  to select “2004” (year), then press the centre of the Operation button.



- 9 Press  $\Delta$  or  $\nabla$  to select “10” (hour), then press the centre of the Operation button.





- 10 Press  $\Delta$  or  $\nabla$  to select "30" (minute), then press the centre of the Operation button.

**SETTING** 2. 6. 2004  
10:30:00

- The internal clock now starts operating with the seconds display.

- 11 Press the DISPLAY button to turn off the menu screen.

**Note:**

- If the date and time have been set, the SETTING 1 screen (📺) appears in step 4. Select "SETTING" in the OTHERS 2 screen (📺) using the Operation button.

## Changing to the 12-hour Time Mode

- 1 After performing step 10 above, press  $\nabla$  or  $\Delta$  to select "12H/24H", then press the centre of the Operation button.

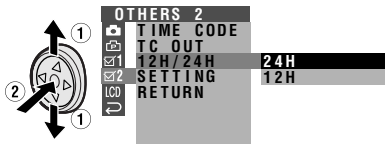

- 2 Press  $\nabla$  or  $\Delta$  to select "12H", then press the centre of the Operation button.

**12H/24H** 12H

- 3 Press the DISPLAY button to turn off the menu screen.

**Notes:**

- The date and time, once set, are internally recorded even when not displayed on the screen.
- The menu screen automatically turns off if no settings are made within 5 minutes.

## Using the Lens Cap

Attach the strap of the lens cap to the hand strap as shown below.

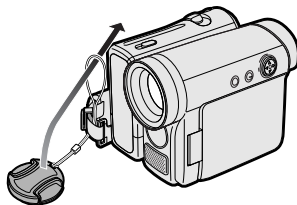

When attaching or removing the lens cap, grasp the indents on both sides of the cap.

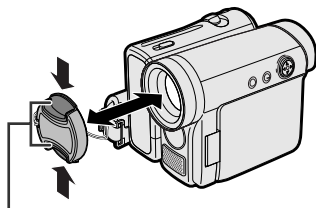

Indents

When recording, remove the lens cap and attach the lens cap cord to the fastener so that the cap will not get in the way.

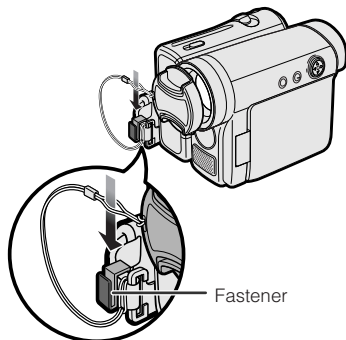

Fastener

**Note:**

- Always attach the lens cap over the lens when not using the camcorder.

## Preparation

### Adjusting the Hand Strap

- 1 Open the hand strap flap (①) and grip strap (②).

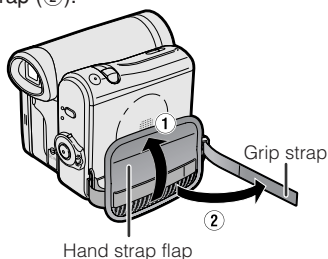

- 2 Loosen the grip strap, pass your right hand through the hand strap, and put your thumb close to the Start/Stop button and your index finger on the Power Zoom control. Then, pull the grip strap tight until it fits snugly.

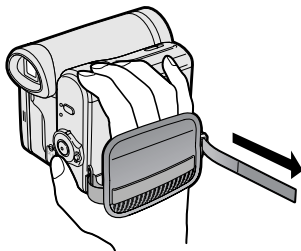

- 3 Seal the Velcro® fasteners of the grip strap and the hand strap flap.

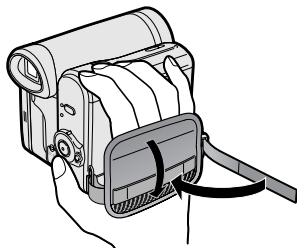

### Using the Grip

Rotate the grip 135° forward or 90° downward so that you can record images easily from high or low angle (see page 18).

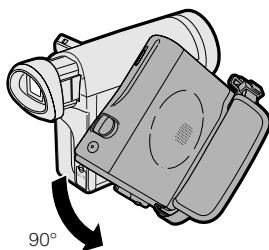
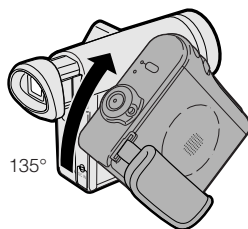

**Note:**

- The grip cannot rotate when a tripod is attached.

## Detaching the Lens Hood

Before using a commercially available conversion lens, detach the lens hood as shown below.

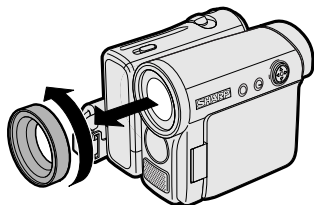

### Note:

- You cannot attach the supplied lens hood or lens cap to a conversion lens.

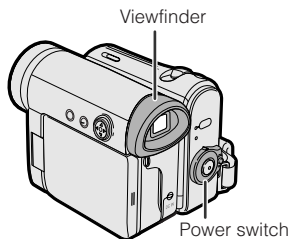

## Using the Viewfinder

You can record the subject using the electronic viewfinder. You can also watch playback through the viewfinder.

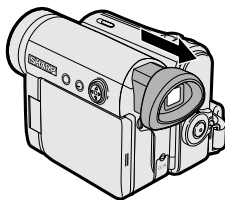

- Pull out the viewfinder completely.



- Hold down the Lock button and set the Power switch to  or .

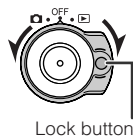

## Preparation

### Closing the viewfinder

Push in the viewfinder completely.

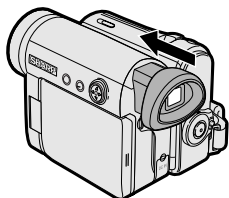

#### Notes:

- Do not use excessive force when moving the viewfinder.
- Do not pick up the camcorder by the viewfinder.
- The viewfinder automatically turns off when the LCD monitor is opened. If the vertical rotation of the monitor is 180° when in Camera mode, however, the viewfinder is on and the subject is displayed both in the viewfinder and on the monitor (see page 36).
- You can adjust the settings on the MENU screen through the viewfinder by using the Operation button (see page 27 for use of the Operation button).
- Be sure to close the viewfinder after use.

### Adjusting the dioptre

Adjust the dioptre according to your eyesight when the picture in the viewfinder or the characters on the on-screen display is not clear.

- 1 Pull out the viewfinder completely.
- 2 Hold down the Lock button and set the Power switch to .
- 3 While looking through the viewfinder, turn the dioptre adjustment dial until the indicators in the viewfinder are clearly visible.

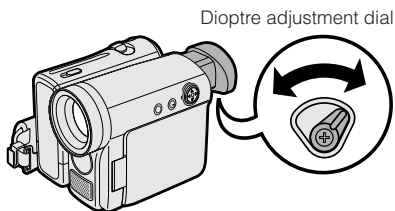

#### Note:

- For cleaning the viewfinder, see page 68.

## Using the LCD Monitor

You can use the LCD monitor to play back recordings that you have made or to watch the subject during recording.

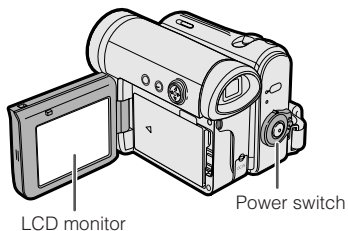

- 1 Open the LCD monitor to a 90° angle to the camcorder body.

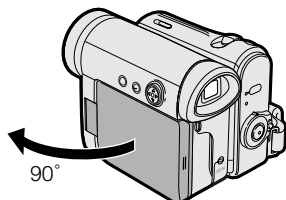

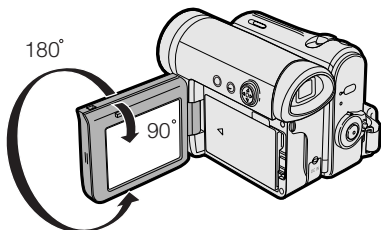

- 2 Adjust the LCD monitor to an angle that allow easy viewing of the on-screen picture.
  - The LCD monitor rotates 270° vertically.

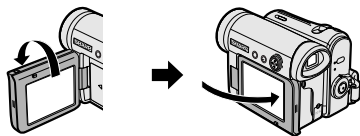

**Note:** Do not try to rotate the LCD monitor vertically until the monitor is completely opened.

- You can also fold the LCD monitor into the camcorder with the screen facing out for watching playback on the monitor.



- 3 Hold down the Lock button and set the Power switch to  or .

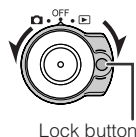

- A picture displays on the LCD monitor.

### Note:

- Battery consumption is larger when the LCD monitor is opened. Use the viewfinder instead of the LCD monitor when you want to save the battery power.

## Closing the LCD monitor

Return the LCD monitor to the vertical 90° position with the screen facing in, and fold it into the camcorder into place.

### Notes:

- Do not use excessive force when moving the LCD monitor.
- When closing the LCD monitor, do not tilt it; otherwise the monitor may not close properly and may become damaged.
- Do not pick up the camcorder by the LCD monitor.
- Do not place the camcorder with the LCD monitor screen facing down.
- Close the LCD monitor completely with the screen facing in when not in use.
- Before closing the LCD monitor, make sure the battery pack is properly attached to the camcorder, otherwise the monitor may be damaged.

### Tips on Recording Positions

To create images that are easy to watch during playback, try to record with an upright posture and steady hands to prevent a shaky image.

#### Holding the camcorder

Put your right hand through the hand strap, and place your left hand under the camcorder for support.

#### Basic posture

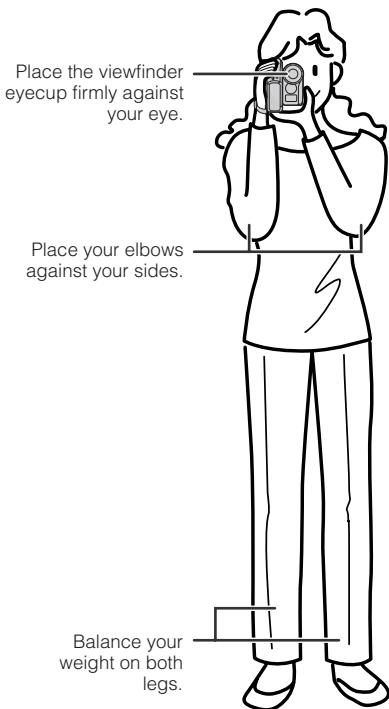

#### Shooting from a high angle

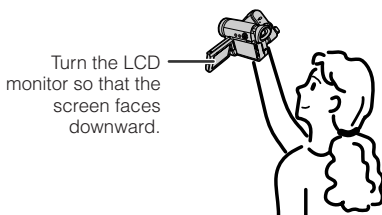

#### Shooting from a low angle

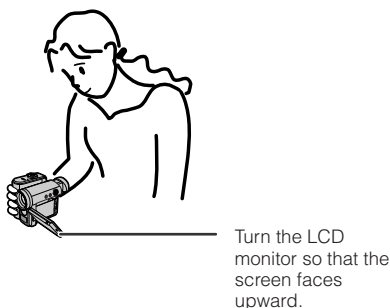

#### Note:

- Take care not to touch the microphone with your fingers during recording. It will cause noise on the audio track.

# Basic Operations

## Camera Recording

### Easy Camera Recording in Full Auto Mode

- Before you start recording, perform the operations described on pages 5 through 18 to prepare your camcorder for recording.

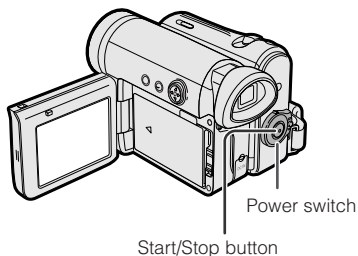

- 1 Remove the lens cap.
- 2 Hold down the Lock button and set the Power switch to .
  - The picture from the lens now displays and the POWER/CHARGE (RED) indicator lights up green.
  - The camcorder is now ready to record (Recording Standby mode).

POWER/CHARGE (RED) indicator

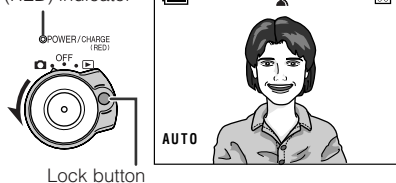

**Note:**

- If "AUTO" is not displayed at this time, set the camcorder to Full Auto mode (see page 52).

- 3 Press the Start/Stop button to begin recording.

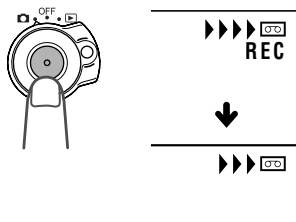

**Note:**

- Before recording an important scene, please perform the recording test, then playback to check if the scene was recorded properly. If noise occurs, use a commercially available cleaning tape to clean the video heads (see page xii).

### Maximum continuous recording and actual recording times

Battery pack	Max. continuous recording time		Actual recording time	
	LCD closed	LCD open	LCD closed	LCD open
BT-L226	120	105	60	55

**Note:**

- Using the zoom (see page 20) and other functions or turning the power on and off frequently will increase power consumption. This may result in a decrease in the actual recording time compared to the maximum continuous recording time listed above.

# Basic Operations

## Camera Recording

### To pause recording

Press the Start/Stop button again. Recording pauses, and the camcorder enters Recording Standby mode.

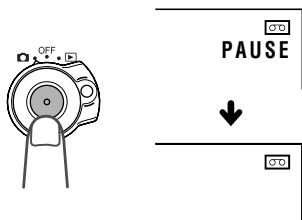

### To turn the power off

Set the Power switch to OFF without pressing the Lock button.

#### Note:

- If the camcorder remains in Recording Standby mode for more than 5 minutes, the power will automatically turn off to save battery power and to protect the tape from being damaged. To resume recording, set the Power switch to OFF and then back to ON. (The camcorder will make a confirmation sound when it is left in Recording Standby mode for about 4 minutes.)

### Zooming

Zooming allows you to move visually closer to or farther from a subject without physically changing your position.

When using the optical zoom, you can enlarge the subject up to 10x.

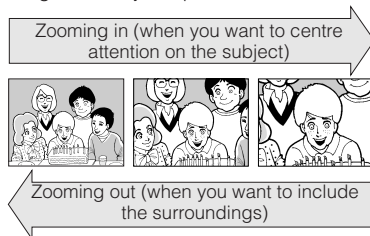

#### Zooming in

Push the Power Zoom control to the T (telephoto) side to get a close-up view (1).

#### Zooming out

Push the Power Zoom control to the W (wide angle) side to get a wide field of view (2).

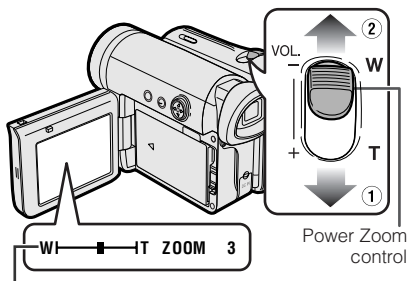

Zoom range indicator

- The zoom range indicator shows you the current zoom setting.
- The zoom speed depends on how far you push the Power Zoom control.

#### Notes:

- The camcorder is unable to focus when zooming in on subjects within 1.5 m.
- See page 29 for how to use the digital zoom.



## Power Standby Mode

Power Standby mode allows you to prevent accidental recording by locking all operations except cancelling the mode.

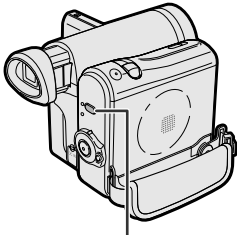

STANDBY button

Hold down the STANDBY button for more than 2 seconds when you pause recording.

- The screen turns off and the STANDBY indicator lights up.



STANDBY indicator

### To resume operation

Press the STANDBY button again to return to the Recording Standby mode.

- It takes about 2 seconds to be able to start recording.

#### Notes:

- Power Standby will cancel and the STANDBY indicator will turn off in these situations below:
  - When the camcorder remains in Power Standby mode more than 5 minutes
  - When the camcorder is set to Playback mode
  - When removing the battery pack
  - When removing a cassette
- The camcorder will turn off automatically in 5 minutes after setting Power Standby mode if it remains in Recording Standby mode after canceling Power Standby mode.
  - When Power Standby mode, for example, is cancelled after 3 minutes, the camcorder will turn off if recording is not started.

## Turning on/off the Backlight

You can see the on-screen display outdoors on a sunny day or in a location with bright lighting even when the backlight turns off. Also, this function is useful when watching playback on a TV.

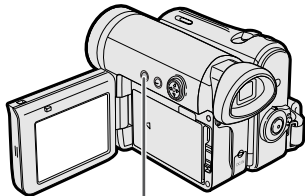

LCD LAMP button

Hold down the LCD LAMP button for more than 2 seconds to turn off the backlight.

- "BACKLIGHT OFF" will flash for two seconds, then  appears on the LCD screen.

### To turn on the backlight

Press the LCD LAMP button.

#### Note:

- The BACKLIGHT OFF mode will cancel when you close the LCD monitor.

### Auto Focus

The camcorder is preset to Auto Focus mode, which is designed to focus on most types of subjects. In Auto Focus mode, the camcorder automatically focuses on the subject in the centre of the scene. Always keep the subject in the centre of the scene.

#### Notes:

- If no subject is in the centre of the scene, the focus area will expand and the subject nearest the centre will be focused on.
- Auto Focus may not work in the situations described on page 47. In these situations, use the manual focus function.
- The camcorder may not be able to focus correctly if the subject is closer than approximately 1.5 m. Set the zoom control to wide angle, and try refocusing again.
- If the lens is dirty or fogged, the camcorder may not be able to focus correctly.

### Macro Shots

This camcorder lets you shoot close-up images of small objects such as flowers and insects, or make title frames for your videos. When you want to record a magnified image of a subject which is within approximately 1.5 m of the camcorder, do not zoom in on it. Instead, zoom out all the way by pushing the Power Zoom control to the W side, and then move the camcorder closer to the subject until you obtain the desired angle of view. The camcorder will automatically focus on the subject when the lens is set for the widest angle.

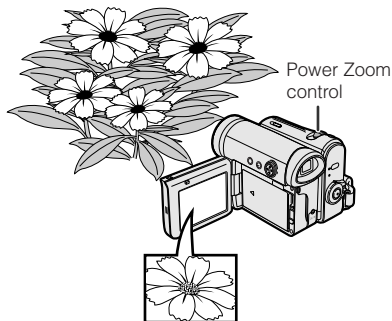

#### Note:

- When you are recording a macro shot, be sure that the subject receives sufficient illumination.

## Remaining Recording Time Display

When the camcorder is recording, an on-screen indicator displays the approximate remaining tape time in minutes.

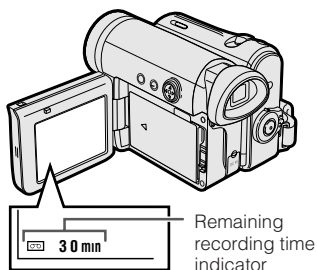

### Notes:

- The remaining recording time indicator appears when the on-screen indicators are turned on.
- The remaining recording time indicator appears 10 seconds after pressing the Start/Stop button to begin recording.
- The remaining recording time indicator only shows the approximate time left. Also, it varies slightly depending on the length of the tape used. (This function is based on the DVM60 tape standard.)

When the remaining recording time reaches 1 minute, a warning indicator will appear. Prepare a new cassette.

Warning indicator	Approx. remaining time
<p>THE TAPE ENDS SOON.</p> <p>↓</p> <p>⚡ TAPE END ⚡</p>	Less than 1 min.
<p>CHANGE THE CASSETTE.</p> <p>↓</p> <p>TAPE END</p>	The tape has reached the end.

## Remaining Battery Power Display

When using the camcorder with the battery pack as the power source, the remaining battery power indicator is displayed. If the battery power becomes very low, a warning indicator appears. Replace the battery pack.

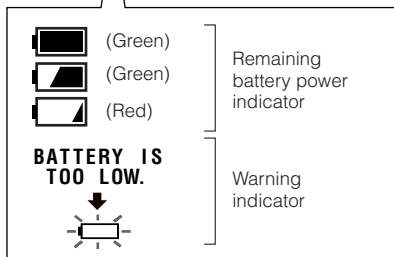
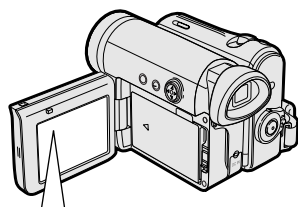

### Notes:

- The remaining battery power indicator appears when the on-screen indicators are turned on.
- Use the remaining battery power indicator only as an approximate indication.
- The remaining battery power indicator may change to either a higher or lower level if you set the Power switch to OFF and then back to or .
- In cold environments, the red remaining battery power indicator may appear sooner.
- Use of the zoom functions when the warning indicator is displayed may cause the camcorder to suddenly lose power.

# Basic Operations

## Playback

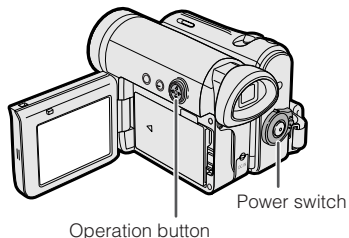

### Playback

The LCD monitor screen functions as a handy playback monitor. Nothing needs to be connected, allowing instant on-screen playback with the sound through the built-in speaker.

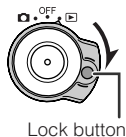

- 1 Hold down the Lock button and set the Power switch to .



- 2 Press  (or ) on the Operation button to rewind (or fast forward) the tape to the desired point.

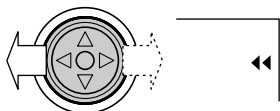

- 3 Press  to begin playback.

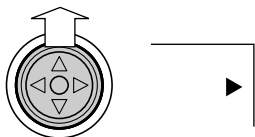

### To stop playback

Press .



### To turn the power off

Set the Power switch to OFF without pressing the Lock button.

#### Note:

- The tape automatically rewinds when playback reaches the end of the tape.

### Watching the playback in the viewfinder

You can also watch the playback in the viewfinder by closing the LCD monitor with the screen facing in. You cannot monitor the sound through the speaker when watching the playback in the viewfinder.

## Volume Control

When the camcorder is in Playback mode, push the Volume control to the + or - side to increase (①) or decrease (②) the volume.

The volume level indicator will appear on the LCD screen during adjustment only. Once the Volume control is released, the volume level indicator will disappear shortly afterwards.

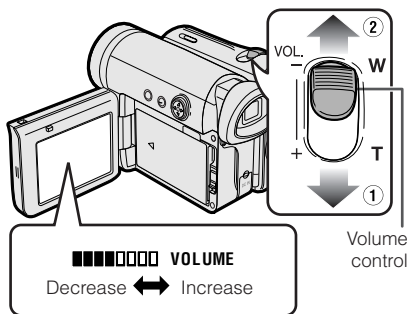

## Still

The still function allows you to pause playback.

During playback, press  $\Delta$  on the Operation button.

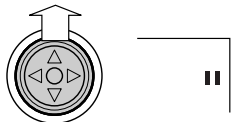

To return to normal playback, press  $\Delta$  again.

### Notes:

- The sound is off in Still mode.
- To protect the tape, the camcorder automatically returns to normal playback if it is left in Still mode for more than 5 minutes.

## Video Search

The video search function makes it easy to search for a desired scene on the tape.

### Searching for a Scene Near the Current Tape Position

- 1 During playback, press  $\triangleright$  (or  $\triangleleft$ ) on the Operation button.
  - The playback picture fast forwards (or reverses).

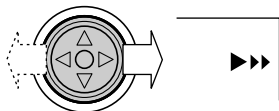

- 2 When you find the scene, press  $\Delta$  to return to normal playback.

### Searching for a Scene Far from the Current Tape Position

- 1 During fast forward (or rewind), press and hold  $\triangleright$  (or  $\triangleleft$ ) on the Operation button.
  - The fast forward (or rewind) picture displays.
- 2 If the scene is still rather far from the current tape position, release the Operation button to normal fast forward (or rewind).
- 3 Repeat steps 1 and 2 above until you find the scene.
- 4 Press  $\Delta$  to begin normal playback.

### Notes:

- The sound is off during search.
- You may experience picture noise during search. This is not a malfunction.

### Watching Playback on a TV

You can connect the camcorder to a TV to allow a larger audience to enjoy playback.

- 1 Open the terminal cover on the camcorder (see page 2).

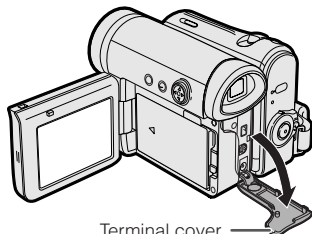

Terminal cover

- 2 Connect the camcorder to your TV (or VCR) with the supplied audio/video/S-video cable, as shown.

#### TV or VCR



Black: To S-video input socket  
Yellow: To video input jack  
White: To audio input (L) jack  
Red: To audio input (R) jack

Audio/video/S-video cable (supplied)

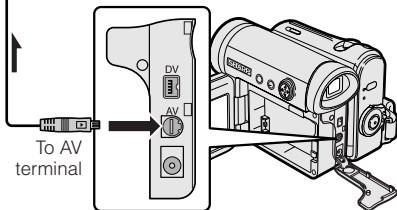

←: The arrow shows the signal flow.

#### Note:

- Check that the camcorder, TV, VCR and other equipment to be used are turned off before making any connections. Picture noise or malfunction may occur if any of the above is left on while making a connection.

- 3 Turn on the TV and set it to the "AV" or "VIDEO" channel. (See the operation manual of your TV.)
  - When connecting to a TV via a VCR, turn on the VCR and set it to the "AV" or "LINE" input channel. Operate the TV as you normally do to view the signal from the VCR. (See the operation manuals of your TV and VCR.)
- 4 Set the Power switch on the camcorder to , and begin playback (see page 24).

#### Notes:

- If your TV or VCR has a 21-pin Euro-SCART connector, use the RCA/21-pin Euro-SCART conversion connector (QSOCZ0033TAZZ) available from our main parts distributor detailed on page 70.

#### 21-pin Euro-SCART on TV or VCR

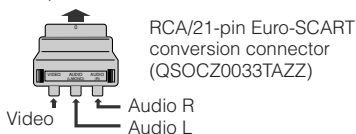

- If your TV or VCR has only one audio input jack, use the white plug for the audio connection on the TV or VCR.
- If your TV or VCR has an S-video input socket, you do not need to connect the yellow video plug.
- Close the terminal cover after use.

#### About the S-video socket

S-video sockets are used to separately pass the chroma (colour) and luminance (brightness) components of video signals. They serve to improve the picture quality in both recording and playback.

# Useful Features

## Control Buttons

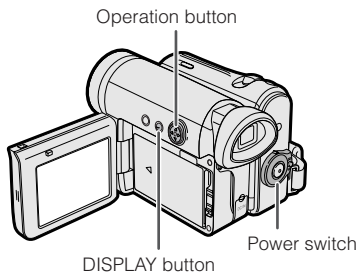

## Operation button

Use the Operation button to select and set the desired setting.



## DISPLAY button

Each time you press the DISPLAY button, the screen changes as shown below.

- The example screens shown are for Camera mode.

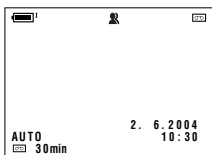

Information display on

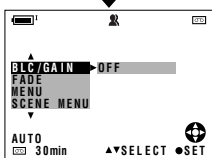

Mode screen



Information display off

## Using the Mode Screens

In the mode screens, you can adjust the camcorder settings by using the Operation button.

- 1 Hold down the Lock button and set the Power switch to or .
  - See pages 74 and 75 for the mode items you can select in each mode.
  - Steps 2 to 4 show how to change the SCENE MENU setting in Camera mode.
- 2 Press the DISPLAY button until the mode screen appears.



- 3 Press  $\nabla$  or  $\Delta$  on the Operation button to select the desired mode item (SCENE MENU), then press the centre of the Operation button.

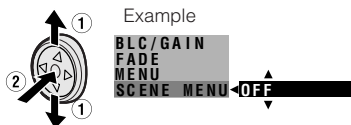

- 4 Press  $\nabla$  or  $\Delta$  to select the desired mode setting (DUSK), then press the centre of the Operation button.

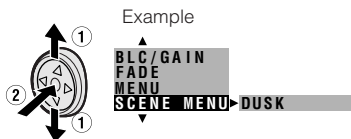

## To turn off the mode screen

Press the DISPLAY button.

### Note:

- Items that are not selectable are greyed out.

## Using the Menu Screens

Use the menu screens to adjust the various camcorder settings.

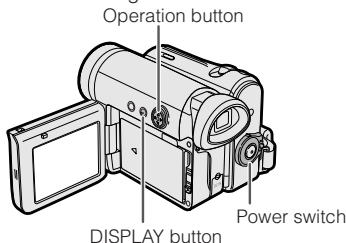

- 1 Hold down the Lock button and set the Power switch to or .
  - See pages 74 and 75 for the menu items you can select in each mode.
  - Steps 2 to 8 show how to change the DGTL ZOOM menu setting in Camera mode.

- 2 Press the DISPLAY button until the mode screen appears (see page 27).

- 3 Press  $\nabla$  or  $\Delta$  on the Operation button to select "MENU", then press the centre of the Operation button.

- 4 Press  $\nabla$  or  $\Delta$  to select "EXECUTE", then press the centre of the Operation button.

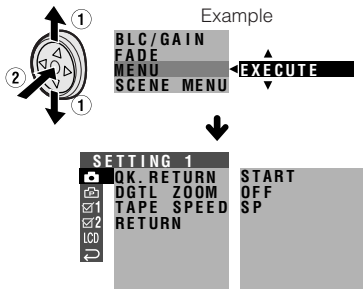

### Note:

- The menu screen does not appear during recording.

- 5 Press  $\nabla$  or  $\Delta$  to select the desired menu screen (), then press the centre of the Operation button.

Example

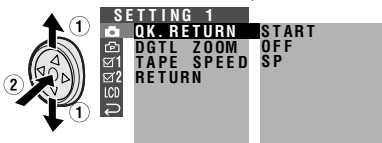

- You can press  $\triangleright$ , instead of the centre of the Operation button.

- 6 Press  $\nabla$  or  $\Delta$  to select the desired menu item (DGTL ZOOM), then press the centre of the Operation button.

Example

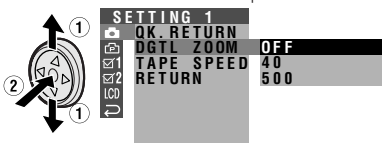

- You can press  $\triangleright$ , instead of the centre of the Operation button.

- 7 Press  $\nabla$  or  $\Delta$  to select the desired menu setting (40), then press the centre of the Operation button.

**DGTL ZOOM 40**

- You can press  $\triangleleft$ , instead of the centre of the Operation button.
- To adjust another menu item, press  $\nabla$  or  $\Delta$  to select "RETURN" and press the centre of the Operation button, then perform steps 5 to 7.

- 8 Press the DISPLAY button to turn off the menu screen.

### Notes:

- Certain menu items are common in both Camera and Playback modes. If the BEEP menu item, for example, is set to "OFF" in Camera mode, it will be automatically set to "OFF" in Playback mode.
- The menu screen automatically turns off if no settings are made within 5 minutes.
- Items that are not selectable are greyed out.



# Useful Features

## Camera Recording

### Setting the Digital Zoom

You can select three different zoom ranges: 1–10× (optical zoom), 10–40× (digital zoom) or 10–500× (digital zoom). The digital zoom allows you to record powerful close-up pictures with the same operation as normal zooming.

#### Notes:

- The digital zoom is in addition to the optical zoom giving a combined maximum zoom range of 1–500×.
- **As the image is enlarged digitally, the picture quality decreases when higher digital zoom settings are used.**

- 1 In Camera mode, press the DISPLAY button until the mode screen appears.



- 2 Press  $\nabla$  or  $\Delta$  on the Operation button to select "MENU", then press the centre of the Operation button.
- 3 Press  $\nabla$  or  $\Delta$  to select "EXECUTE", then press the centre of the Operation button.
- 4 Press  $\nabla$  or  $\Delta$  to select , then press the centre of the Operation button.

- 5 Press  $\nabla$  or  $\Delta$  to select "DGTL ZOOM", then press the centre of the Operation button.

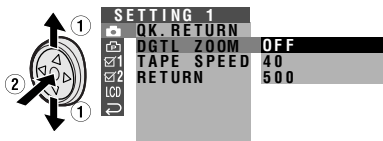

- 6 Press  $\nabla$  or  $\Delta$  to select "40" or "500", then press the centre of the Operation button.

**DGTL ZOOM 40**

- 7 Press the DISPLAY button to turn off the menu screen.

The "D" digital zoom indicator is displayed during digital zooming.

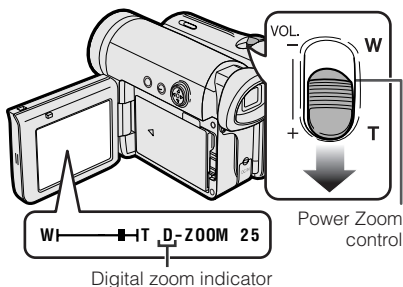

#### To use optical zoom only

Select "OFF" in step 6 above.

## Useful Features

### Camera Recording

#### Backlight Compensation (BLC)

When the subject is backlit, the image will appear dark if it is recorded normally. Use the backlight compensation (BLC) function to improve the picture.

- 1 In Camera mode, press the DISPLAY button until the mode screen appears.



- 2 Press  $\nabla$  or  $\Delta$  on the Operation button to select "BLC/GAIN", then press the centre of the Operation button.
- 3 Press  $\nabla$  or  $\Delta$  to select "ON ", then press the centre of the Operation button.



- 4 Press the DISPLAY button to turn off the mode screen.
  - "" appears when on-screen indicators are turned on, indicating that the backlight compensation is now working.

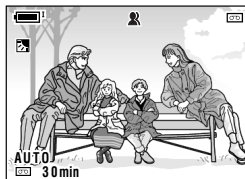

#### To cancel the backlight compensation function

Select "OFF" in step 3 above.

## Gain-up

When you are recording in a dark or poorly illuminated location, "LIGHT" is displayed on the screen. Use the gain-up function to record a brighter picture.

### Note:

- At locations where lighting is adequate, "LIGHT" will not appear. The gain-up function cannot be used in this case.

- In Camera mode, press the DISPLAY button until the mode screen appears.



- Press  $\nabla$  or  $\Delta$  on the Operation button to select "BLC/GAIN", then press the centre of the Operation button.
- Press  $\nabla$  or  $\Delta$  to select "ON  $\text{⏏}$ ", then press the centre of the Operation button.



- Press the DISPLAY button to turn off the mode screen.
  - " $\text{⏏}$ " appears when on-screen indicators are turned on, indicating that the gain-up function is now working.

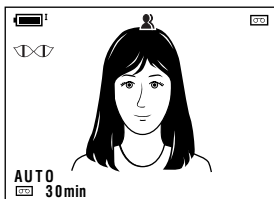

## To cancel the gain-up function

Select "OFF" in step 3 above.

### Notes:

- You may experience some picture noise in Gain-up mode, which increases when the  $\text{⏏}$  appears.
- When the  $\text{⏏}$  indicator appears, you may get a shadow image behind a subject that is moving around a lot.
- Fine brightness adjustments are possible when using manual iris (see page 50).
- The  $\text{⏏}$  indicator will disappear and Gain-up mode will cancel if you aim the camcorder in a bright location.

## Useful Features

### Camera Recording

#### Fade In and Fade Out

The fade function allows you to gradually bring the image and sound in or out at the beginning or end of a scene for creating scene transitions. This is especially effective in creating a dramatic change in scenery.

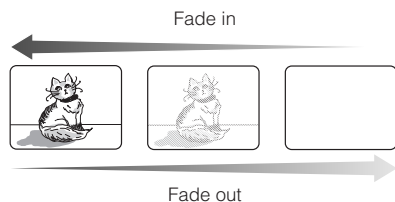
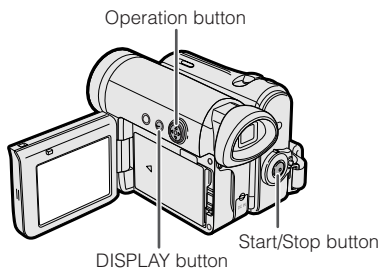

#### Using

- 1 In Camera mode, press the DISPLAY button until the mode screen appears.
- 2 Press  $\nabla$  or  $\Delta$  on the Operation button to select "FADE", then press the centre of the Operation button.



- 3 Press  $\nabla$  or  $\Delta$  to select "ON", then press the centre of the Operation button.

- 4 Press the DISPLAY button until on-screen indicators appear.
- 5 Press the Start/Stop button to begin recording.
  - The picture turns white, and the image and sound fade in.

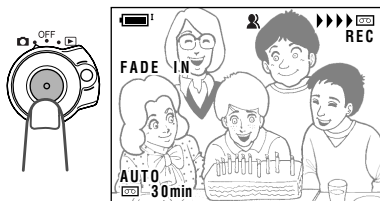

- 6 Press the Start/Stop button at the point where you wish to stop recording.
  - The image and sound fade out as the picture gradually turns white. The camcorder then returns to Recording Standby mode.

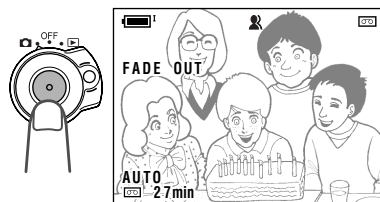

#### To cancel Fade mode

Select "OFF" in step 3 above.

#### To use Fade Out only

- 1 During camera recording, press the DISPLAY button until the mode screen appears.
- 2 Perform steps 2 and 3 in "Using".
- 3 Press the Start/Stop button at the point where you wish to stop recording.

#### Note:

- Fade mode automatically cancels after Fade

## Quick Return

If while playing back your tape you want to quickly return to the last recorded scene and start recording again, use the quick return function.

- 1 In Recording Standby mode, press the DISPLAY button until the mode screen appears.
- 2 Press  $\nabla$  or  $\Delta$  on the Operation button to select "MENU", then press the centre of the Operation button.
- 3 Press  $\nabla$  or  $\Delta$  to select "EXECUTE", then press the centre of the Operation button.
- 4 Press  $\nabla$  or  $\Delta$  to select , then press the centre of the Operation button.
- 5 Press  $\nabla$  or  $\Delta$  to select "QK. RETURN", then press the centre of the Operation button.

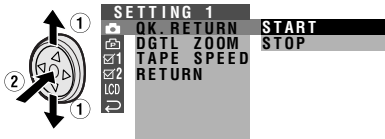

- 6 Press  $\nabla$  or  $\Delta$  to select "START", then press the centre of the Operation button.
  - "SEARCH" flashes, and the tape begins fast forwarding or rewinding to the end of the last recorded scene.



- When the tape reaches the end of the last recorded scene, "FINISHED" is displayed, and the camcorder enters Recording Standby mode.
- 7 Press the DISPLAY button to turn off the menu screen.

### Notes:

- To cancel the quick return function while "SEARCH" is flashing, press the centre of Operation button twice.
- Quick return will not work if you remove the cassette and reload it after recording or if nothing has been recorded since loading.

## Useful Features

### Camera Recording

#### Edit Search

The edit search function lets you search, without switching from Camera mode to Playback mode, for the point on the tape where you wish to start recording next.

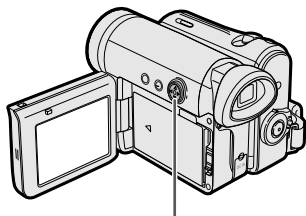

Operation button

- 1 In Recording Standby mode, press and hold down ◀ (reverse edit search) or ▶ (forward edit search) on the Operation button.

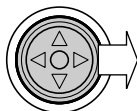
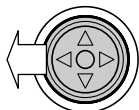

- 2 When you find the point where you want to begin recording, release the button.

#### Notes:

- The sound is off during search.
- Forward edit search is performed at the same speed as normal playback, and reverse edit search at 6.5 times the normal playback.
- You may experience picture noise during reverse edit search.

#### Still Recording

You can record continuous still images of subjects.

- 1 In Recording Standby mode, press the PHOTO button fully.

- A still image of the subject is displayed.



- 2 Press the Start/Stop button.

- The still image of the subject will be recorded.



#### To pause recording

Press the Start/Stop button.

#### To cancel the still image

Press the PHOTO button fully.

#### Notes:

- Still Recording can also be used during recording by pressing the PHOTO button fully.
- The picture quality in Still Recording function will be slightly lower than normal pictures.

## Digital Image Stabilization (DIS)

The digital image stabilization (DIS) function allows you to stabilize the image by electronically compensating for relatively minor image shaking that is often annoying in close-up shots.

- 1 In Camera mode, press the DISPLAY button until the mode screen appears.
- 2 Press  $\nabla$  or  $\Delta$  on the Operation button to select "MENU", then press the centre of the Operation button.
- 3 Press  $\nabla$  or  $\Delta$  to select "EXECUTE", then press the centre of the Operation button.
- 4 Press  $\nabla$  or  $\Delta$  to select , then press the centre of the Operation button.
- 5 Press  $\nabla$  or  $\Delta$  to select "DIS", then press the centre of the Operation button.

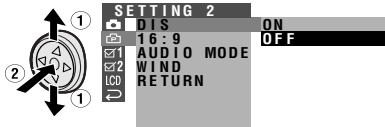

- 6 Press  $\nabla$  or  $\Delta$  to select "ON", then press the centre of the Operation button.

**DIS ON**

- 7 Press the DISPLAY button to turn off the menu screen.

- The DIS indicator only appears when the on-screen indicators are turned on.

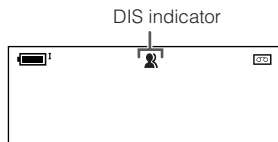

### To cancel DIS function

Select "OFF" in step 6 above. The  indicator will disappear.

#### Notes:

- The DIS function cannot compensate for excessive image shaking.
- When image shaking does not occur (e.g. when using the camcorder on a tripod), turn off the DIS function. The picture will appear more natural when the DIS function is off.

## Useful Features

### Camera Recording

#### Self Recording

##### Normal self recording

Open the LCD monitor and rotate it 180° vertically so that the screen faces the other way and the subject can monitor the shot while you are recording with the viewfinder.

If the camcorder is steadied, you can record yourself in the scene by watching yourself on the LCD monitor.



- 1 Pull out the viewfinder completely. Open the LCD monitor to a 90° angle to the camcorder body (①), and then rotate it 180° vertically (②).

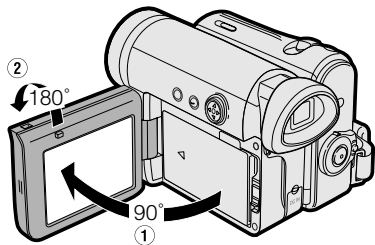

- 2 Set the Power switch to .
  - The subject is displayed in the viewfinder, and a mirror image of the subject is displayed on the LCD monitor.

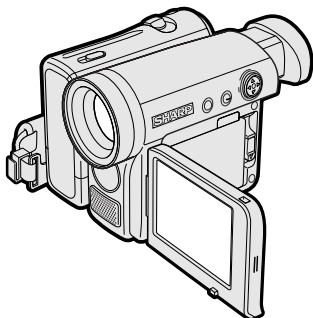

- 3 Press the Start/Stop button to begin recording.

**Note:**

- You can play back images while the monitor is in the self recording position. Set the camcorder to Playback mode.



## Self recording with reversed grip

Rotate the grip 90° and the LCD monitor 180° vertically so that you can record yourself while holding the grip.



- 1 Turn the camcorder downward as shown below.

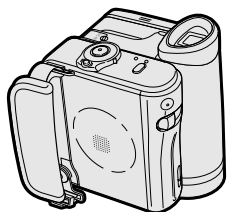

- 2 Rotate the lens section 90° vertically as shown below.

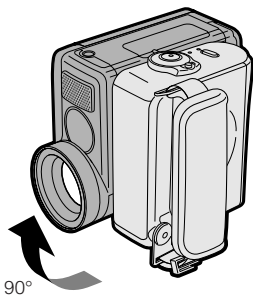

- 3 Open the LCD monitor to a 90° angle to the camcorder body (1), and then rotate it 180° vertically (2).

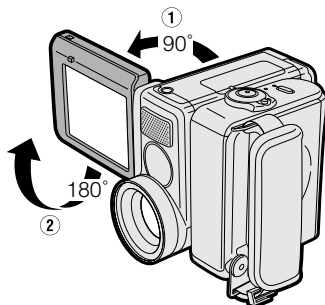

- 4 Set the Power switch to .
- 5 Press the Start/Stop button to begin recording.

### Notes:

- Do not rotate the monitor section to the self recording position during recording or playback.
- During self recording, the mode or menu screen cannot be displayed.
- All of the manual settings are set to AUTO and some other settings will set to OFF in self recording.
- You may experience image noise when using self recording.
- To operate self recording with reversed grip correctly, make sure to turn the grip and the lens section so that the Start/Stop button and the tripod socket face upward, and the lens faces toward you. The  indicator will appear.
- Be sure that the LCD monitor rotation is exactly 180°, otherwise the image recorded will be rotated 180° upside-down.
- The viewfinder does not work in self recording with reversed grip.

## Useful Features

### Camera Recording

#### Wide Screen (16:9)

The wide screen function lets you record scenes with the wide-screen feel of a movie shown in a theatre. The top and bottom of the picture are masked with black bands to produce an effective screen aspect ratio of 16:9.

Normal screen



Wide screen



- 1 In Camera mode, press the DISPLAY button until the mode screen appears.

DISPLAY



- 2 Press  $\nabla$  or  $\Delta$  on the Operation button to select "MENU", then press the centre of the Operation button.
- 3 Press  $\nabla$  or  $\Delta$  to select "EXECUTE", then press the centre of the Operation button.
- 4 Press  $\nabla$  or  $\Delta$  to select , then press the centre of the Operation button.

- 5 Press  $\nabla$  or  $\Delta$  to select "16:9", then press the centre of the Operation button.

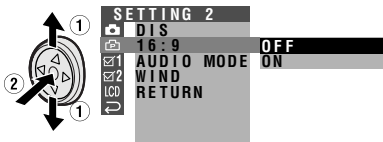

- 6 Press  $\nabla$  or  $\Delta$  to select "ON", then press the centre of the Operation button.

- The picture is displayed with the top and bottom portions masked.

**16:9** **ON**

- 7 Press the DISPLAY button to turn off the menu screen.

#### To return to normal screen

Select "OFF" in step 6 above.

## Recording in LP (Long Play Recording) Mode

This camcorder allows you to record in LP (Long Play Recording) mode for approximately 50% more recording time with the same picture quality as that in SP (Standard Play Recording) mode.

- 1 In Camera mode, press the DISPLAY button until the mode screen appears.



- 2 Press  $\nabla$  or  $\Delta$  on the Operation button to select "MENU", then press the centre of the Operation button.
- 3 Press  $\nabla$  or  $\Delta$  to select "EXECUTE", then press the centre of the Operation button.
- 4 Press  $\nabla$  or  $\Delta$  to select , then press the centre of the Operation button.
- 5 Press  $\nabla$  or  $\Delta$  to select "TAPE SPEED", then press the centre of the Operation button.

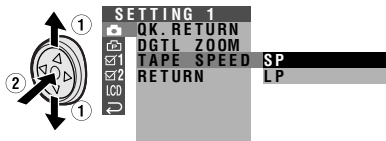

- 6 Press  $\nabla$  or  $\Delta$  to select "LP", then press the centre of the Operation button.

### TAPE SPEED LP

- 7 Press the DISPLAY button to turn off the menu screen.

- The long play recording mode indicator only appears when the on-screen indicators are turned on.

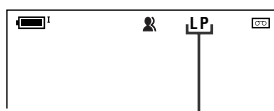

Long play recording mode indicator

### To return to SP mode

Select "SP" in step 6 above.

### Notes on the use of LP mode

- To record in LP mode, be sure to use a Mini DV cassette labelled for use with LP mode.
- Frozen images, mosaic-pattern picture noise, audio interruptions or audio loss may occur in the following cases:
  - When using a tape which is not designated for use with LP mode.
  - When a tape recorded in LP mode under high temperature conditions is played back.
  - When a tape recorded in LP mode with the camcorder is played back on a Mini DV player or camcorder from another manufacturer.
  - When a tape recorded in LP mode is played back on a Mini DV player or camcorder without an LP function.
- Audio dubbing is not possible with LP mode recording.

## Useful Features

### Camera Recording

#### Windbreak

The windbreak function allows you to reduce annoying noise from strong winds when recording.

- 1 In Camera mode, press the DISPLAY button until the mode screen appears (see page 27).
- 2 Press  $\nabla$  or  $\Delta$  on the Operation button to select "MENU", then press the centre of the Operation button.
- 3 Press  $\nabla$  or  $\Delta$  to select "EXECUTE", then press the centre of the Operation button.
- 4 Press  $\nabla$  or  $\Delta$  to select , then press the centre of the Operation button.
- 5 Press  $\nabla$  or  $\Delta$  to select "WIND", then press the centre of the Operation button.

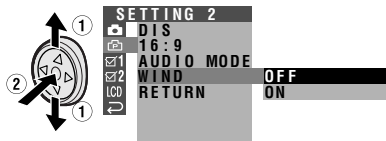

- 6 Press  $\nabla$  or  $\Delta$  to select "ON", then press the centre of the Operation button.

**WIND ON**

- 7 Press the DISPLAY button to turn off the menu screen.

#### To cancel Windbreak

Select "OFF" in step 6 above.

#### Note:

- Keep the windbreak function off during normal recording. If left on, the recorded audio may sound somewhat muffled when played back.

## Selecting the 16-bit Audio Recording Mode

The camcorder normally records audio in the 12-bit audio recording mode. For higher-quality audio recording, select the 16-bit audio recording mode.

- 1 In Camera mode, press the DISPLAY button until the mode screen appears (see page 27).
- 2 Press  $\nabla$  or  $\Delta$  on the Operation button to select "MENU", then press the centre of the Operation button.
- 3 Press  $\nabla$  or  $\Delta$  to select "EXECUTE", then press the centre of the Operation button.
- 4 Press  $\nabla$  or  $\Delta$  to select , then press the centre of the Operation button.
- 5 Press  $\nabla$  or  $\Delta$  to select "AUDIO MODE", then press the centre of the Operation button.

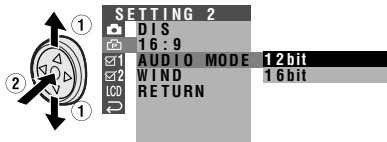

- 6 Press  $\nabla$  or  $\Delta$  to select "16bit", then press the centre of the Operation button.

### AUDIO MODE 16bit

- 7 Press the DISPLAY button to turn off the menu screen.
  - The 16-bit audio recording mode indicator only appears when the on-screen indicators are turned on.



16-bit audio recording mode indicator

### To return to 12-bit audio recording mode

Select "12bit" in step 6 above.

#### Note:

- When using Audio Dubbing with 16-bit audio recordings, both the dubbed and original sounds will be recorded in mono (see page 57).

# Useful Features

## Playback

### Using the Remote Control (Not supplied)

The remote control (RRMCGA149WJSA) is not supplied with this camcorder. Contact the nearest SHARP service centre or your dealer for purchasing as specified part.

### Activating

• The example screens shown are for Playback mode.

- 1 Press the DISPLAY button until the mode screen appears.
- 2 Press  $\nabla$  or  $\Delta$  on the Operation button to select "MENU", then press the centre of the Operation button.
- 3 Press  $\nabla$  or  $\Delta$  to select "EXECUTE", then press the centre of the Operation button.
- 4 Press  $\nabla$  or  $\Delta$  to select  $\checkmark$  1, then press the centre of the Operation button.
- 5 Press  $\nabla$  or  $\Delta$  to select "REMOTE", then press the centre of the Operation button.

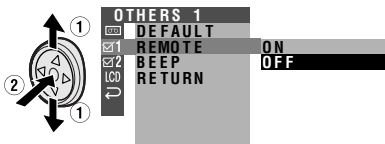

- 6 Press  $\nabla$  or  $\Delta$  to select "ON", then press the centre of the Operation button.

**REMOTE ON**

- 7 Press the DISPLAY button to turn off the menu screen.

### Operating

Aim the remote control at the remote sensor of the camcorder, and press the control buttons to operate.

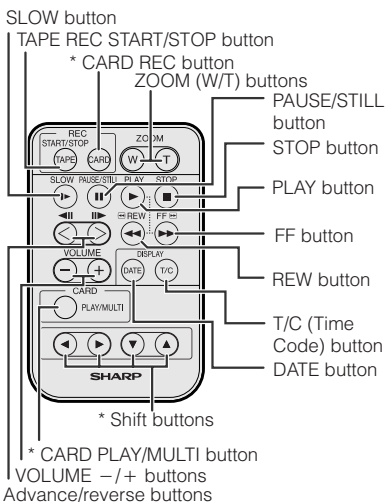
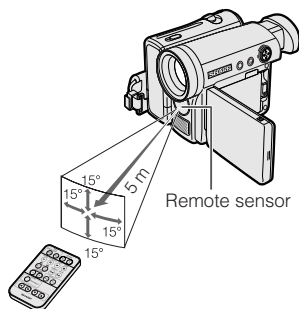

#### Notes:

- Be careful not to expose the remote sensor to direct sunlight or strong interior lighting, as this may prevent the remote control from operating properly.
- Be sure that there are no obstacles between the remote control and the remote sensor.
- **The buttons with an asterisk mark (\*) do not work with this camcorder.**

## Playback Functions with the Remote Control (Not supplied)

You can use the following playback functions with the remote control (not supplied), if you purchase it as a specified part by contacting the nearest SHARP service centre or your dealer. (See page 42 for use of the remote control.)

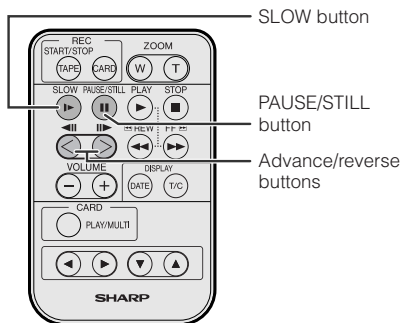

## Reverse Playback

The reverse playback function allows you to play back images in reverse.

During playback, press the ◀◀ button.



To return to normal playback, press the PLAY button (▶).

### Note:

- The camcorder automatically returns to normal playback if it is left in reverse playback for more than 30 minutes.

## Slow

The slow function allows you to play back images in slow motion.

During playback, press the SLOW button (▶).

Then, select the tape direction using the advance/reverse buttons (◀◀ or ▶▶).



To return to normal playback, press the PLAY button (▶).

### Note:

- To protect the tape, the camcorder automatically returns to normal playback if it is left in Slow mode for more than 10 minutes.

## Frame Advance

The frame advance function allows you to play back still images frame by frame.

1 During playback, press the PAUSE/STILL button (||) to pause playback.



2 Press the ▶▶ (or ◀◀) button.

- Each time you press the button, the picture advances one frame forward (or backward).

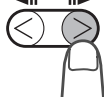

To return to normal playback, press the PLAY button (▶).

### Notes:

- The sound is off during reverse, slow, and frame advance playback.
- If you use the slow or frame advance function with the tape recorded in LP mode, the picture may advance several frames at a time.
- The reverse frame advance moves about 30 frames.

## Useful Features Playback

### Selecting the Date and Time of Recording Display

Follow the procedure below to select the date, or both the date and time, of recording display on the screen. You can display the date and time during both recording and playback.

- The example screens shown are for Playback mode.

- 1 Hold down the Lock button and set the Power switch to or .
- 2 Press the DISPLAY button until the mode screen appears.



- 3 Press  $\nabla$  or  $\Delta$  on the Operation button to select "DATE DISP", then press the centre of the Operation button.



- 4 Press  $\nabla$  or  $\Delta$  to select the desired setting, then press the centre of the Operation button.

**DATE DISP.**  $\blacktriangleright$  **DATE**

- Each time you press  $\nabla$  or  $\Delta$ , the setting changes as shown below.



- 5 Press the DISPLAY button until the date (or date and time) appears.



#### Notes:

- **The date (or date and time) appears when the on-screen indicators are turned on.**
- Before recording, make sure that the date and time have been correctly set. If they have not been set, the display will be left blank when playing back the recording. (The display will also be left blank for unrecorded or damaged portions of the tape.)
- In Playback mode, the current date and time are displayed when the tape is not being played back.



## Picture Effect Playback

These picture effects let you play back images with a more dramatic effect.

### Types

**B/W:** The picture is displayed in black-and-white.

**SEPIA:** The picture is displayed in sepia colour similar to that of an old photograph.

**SOLARI:** The contrast of the subject is enhanced, creating an unique artistic image.

**NEGA:** The blacks and whites of the image are reversed and colours of the image are inverted.

- 4 Press the DISPLAY button to turn off the mode screen.

### To cancel Picture Effect Playback

Select "OFF" in step 3 above.

#### Note:

- Video images in Picture Effect Playback mode cannot be transferred via DV cable to a personal computer.

- 1 During playback, press the DISPLAY button until the mode screen appears.
- 2 Press  $\nabla$  or  $\Delta$  on the Operation button to select "PIC. EFFECT", then press the centre of the Operation button.



- 3 Press  $\nabla$  or  $\Delta$  to select the desired picture effect, then press the centre of the Operation button.

**PIC. EFFECT**  $\blacktriangleright$  **B/W**

## Useful Features Playback

### Rotate Playback

This function allows you to play back images rotated 180°.

- 1 In Playback mode, press the DIS-PLAY button until the mode screen appears.
- 2 Press  $\nabla$  or  $\Delta$  on the Operation button to select "MENU", then press the centre of the Operation button.
- 3 Press  $\nabla$  or  $\Delta$  to select "EXECUTE", then press the centre of the Operation button.
- 4 Press  $\nabla$  or  $\Delta$  to select  $\square$ , then press the centre of the Operation button.
- 5 Press  $\nabla$  or  $\Delta$  to select "ROTATE PB", then press the centre of the Operation button.

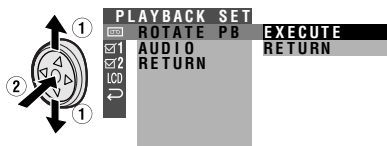

- 6 Press  $\nabla$  or  $\Delta$  to select "EXECUTE", then press the centre of the Operation button.
  - Rotate Playback indicator appears.

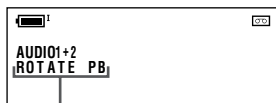

- 7 Press  $\Delta$  to begin Rotate Playback.
  - The image is rotated 180° upside down.

### To cancel Rotate Playback

Press the centre of the Operation button in step 7 above.

#### Notes:









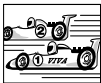

- When executing Rotate Playback during playback, playback will stop. Press  $\Delta$  to begin Rotate Playback.
- Even if the camcorder is in Rotate Playback mode, the image output via a DV connection will display as normal playback.
- The camcorder will stop and cancel Rotate Playback when the LCD monitor is closed.
- When you want to display the menu screen during Rotate Playback, press the centre of the Operation button.
- In Rotate Playback mode, you cannot perform frame advance, slow, or picture effect playback.

# Advanced Features

## Camera Recording

### Manual Focus

Auto Focus may not be able to focus on the subject in the situations shown below. In such situations, set the camcorder to Manual Focus mode and focus manually.

	
Subject is too dark.	Lack of contrast, e.g. snow scene.
	
Fast-moving subject.	Background is too bright.
	
Subject has horizontal stripes.	Subject is being shot through a dirty or wet window.
	
Light reflects off the subject.	Two subjects at different distances appear in the centre of the scene at the same time.
	
Subject has fine, repeated patterns.	
	
Fast-speed shutter being used under fluorescent lighting.	

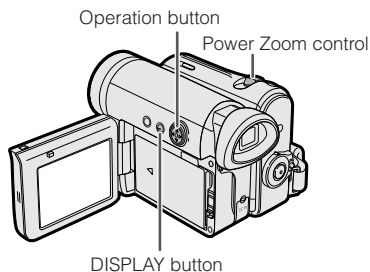

- In Camera mode, press the DISPLAY button until the mode screen appears.
- Press  $\nabla$  or  $\Delta$  on the Operation button to select "FOCUS", then press the centre of the Operation button.



- Adjust the Power Zoom control to frame the subject as you desire.
- Press  $\nabla$  or  $\Delta$  to focus on the subject.
  - $\Delta$ : To focus on a closer subject
  - $\nabla$ : To focus on a more distant subject
- Press the DISPLAY button to turn off the mode screen.
  - "MF" appears when the on-screen indicators are turned on.

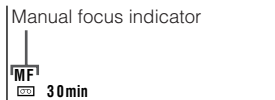

#### Note:

- When "MF" is displayed, you can manually adjust the focus by pressing  $\nabla$  or  $\Delta$ , even if the focus setting screen is not displayed.

### Returning to Auto Focus

You can set Manual Focus mode to Auto Focus mode with the operation below.

- 1 In Camera mode, press the DISPLAY button until the mode screen appears.
- 2 Press  $\nabla$  or  $\Delta$  on the Operation button to select "AUTO FOCUS", then press the centre of the Operation button.



- 3 Press  $\nabla$  or  $\Delta$  to select "EXECUTE", then press the centre of the Operation button.
  - The FOCUS setting returns to Auto Focus mode.
- 4 Press the DISPLAY button to turn off the mode screen.

### Displaying the Manual Setting Screen

You can manually adjust these settings as shown below in the manual setting screen.

- White Balance (see page 49)
- Manual Iris (see page 50)
- Manual Gain (see page 51)

- 1 In Camera mode, press the DISPLAY button until the mode screen appears.
- 2 Press  $\nabla$  or  $\Delta$  on the Operation button to select "MANUAL SET", then press the centre of the Operation button.



- 3 Press  $\nabla$  or  $\Delta$  to select "EXECUTE", then press the centre of the Operation button.

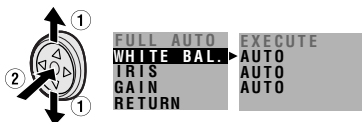

#### Note:

- Items that are not selectable are greyed out.

## White Balance Lock

The colour of the subject on the screen looks different depending on lighting conditions. Lock the White Balance if the Auto White Balance does not work properly.

- 1 In Camera mode, press the DISPLAY button until the mode screen appears.
- 2 Press  $\nabla$  or  $\Delta$  on the Operation button to select "MANUAL SET", then press the centre of the Operation button (see page 48).
- 3 Press  $\nabla$  or  $\Delta$  to select "EXECUTE", then press the centre of the Operation button.
- 4 Press  $\nabla$  or  $\Delta$  to select "WHITE BAL.", then press the centre of the Operation button.

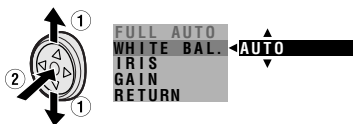

- 5 Press  $\nabla$  or  $\Delta$  to select "LOCK MODE".



- 6 Aim the lens at a white object.

White paper or white cloth

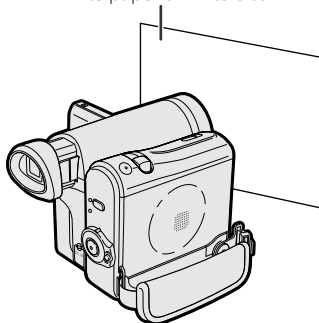

- Adjust the distance of the object so that the entire screen is white.
- 7 Press the centre of the Operation button to set the white balance lock.
    - "LOCK MODE" will change to "LOCK" after pressing the centre of the Operation button.
    - "LOCK" flashes during the locking procedure, and stops flashing after locking the white balance.

### Note:

- If you move the camcorder while "LOCK" is flashing, "LOCK" may not stop flashing. If this occurs, repeat step 7.
- 8 Press the DISPLAY button to turn off the MANUAL SET screen.

### To return to Auto White Balance mode

Press  $\triangleright$  in step 5 above, then press the centre of the Operation button.

### To return to Full Auto mode

Set the camcorder to Full Auto mode (see page 52).

### Note:

- **White Balance setting cannot be used when a scene setting is selected.**

### Manual Iris

The camcorder is preset to Auto Iris mode, which automatically selects the optimal aperture. However, when there is too much contrast in brightness between the subject and background, you may not be able to record a clear image. In this case, use the manual iris function to correct the iris value.

#### **Background is too bright and subject too dark (backlit subject).**

- Decrease the iris value to allow more light through the lens.

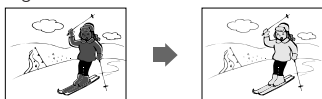

#### **Subject is too bright against background.**

- Increase the iris value to allow less light through the lens.



**1** In Camera mode, press the DISPLAY button until the mode screen appears.

**2** Press  $\nabla$  or  $\Delta$  on the Operation button to select "MANUAL SET", then press the centre of the Operation button (see page 48).

**3** Press  $\nabla$  or  $\Delta$  to select "EXECUTE", then press the centre of the Operation button.

**4** Press  $\nabla$  or  $\Delta$  to select "IRIS", then press the centre of the Operation button.

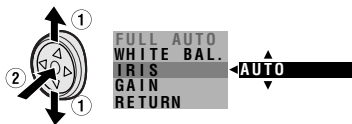

**5** Press  $\nabla$  or  $\Delta$  to select the desired iris value, then press the centre of the Operation button.

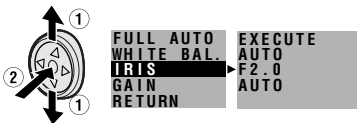

- The number shown is the selected iris value. The adjustment range is 15 steps from F1.8 (most light) to F19 (least light).

**6** Press the DISPLAY button to turn off the MANUAL SET screen.

#### **To return to Auto Iris mode**

Press  $\triangleright$  in step 5 above, then press the centre of the Operation button.

#### **To return to Full Auto mode**

Set the camcorder to Full Auto mode (see page 52).

#### **Note:**

- Manual Iris mode cannot be used when a scene setting is selected.

## Manual Gain

When recording in a dark or poorly illuminated location with Auto Gain mode, the light sensitivity of the camcorder (gain) will be automatically adjusted and the recorded image may be brighter than the subject actually is. If you want to faithfully record a dark scene in this case, use the manual gain function. You can also adjust the gain to record a backlit subject brighter.

### Example of use

#### Faithfully recording a dark scene

- Select a smaller gain value (to decrease the light sensitivity).

#### Background is too bright and subject is too dark (backlit subject)

- Select a larger gain value (to increase the light sensitivity).

- 1 In Camera mode, press the DISPLAY button until the mode screen appears.
- 2 Press  $\nabla$  or  $\Delta$  on the Operation button to select "MANUAL SET", then press the centre of the Operation button (see page 48).
- 3 Press  $\nabla$  or  $\Delta$  to select "EXECUTE", then press the centre of the Operation button.

- 4 Press  $\nabla$  or  $\Delta$  to select "GAIN", then press the centre of the Operation button.

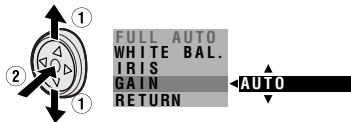

- 5 Press  $\nabla$  or  $\Delta$  to select the desired gain value, then press the centre of the Operation button.

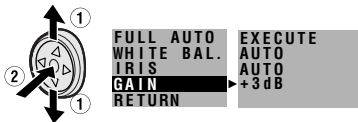

- The number shown is the selected gain value. The adjustment range is 7 steps from 0dB (lowest sensitivity) to +18dB (highest sensitivity).

**Note:** If you select a large gain value, the image may appear grainy.

- 6 Press the DISPLAY button to turn off the MANUAL SET screen.

### To return to Auto Gain mode

Press  $\triangleright$  in step 5 above, then press the centre of the Operation button.

### To return to Full Auto mode

Set the camcorder to Full Auto mode (see page 52).

#### Note:

- Manual Gain mode cannot be used when a scene setting is selected.

### Setting the Camcorder to Full Auto Mode

You can set all manual settings, including white balance, iris, gain, but not focus, to Full Auto mode in one operation.

- 1 In Camera mode, press the DISPLAY button until the mode screen appears.
- 2 Press  $\nabla$  or  $\Delta$  on the Operation button to select "MANUAL SET", then press the centre of the Operation button (see page 48).
- 3 Press  $\nabla$  or  $\Delta$  to select "EXECUTE", then press the centre of the Operation button.

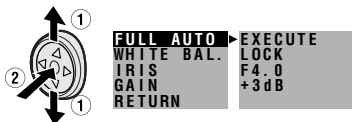

- 4 Press  $\nabla$  or  $\Delta$  to select "FULL AUTO", then press the centre of the Operation button.

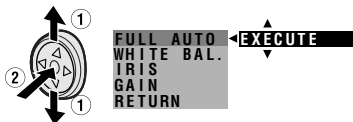

- 5 Press  $\nabla$  or  $\Delta$  to select "EXECUTE", then press the centre of the Operation button.

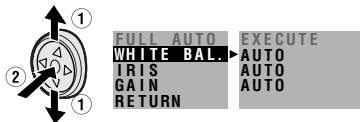

- 6 Press the DISPLAY button to turn off the MANUAL SET screen.

**Note:**

- You cannot select "FULL AUTO" when no manual settings are currently in use.



## Scene Menu (Program AE)

You can set the camcorder to a shooting mode that will create the best results for a specific situation. Just select one of the six scene settings shown below. The camcorder will automatically set the exposure, white balance, and shutter speed to produce the optimum picture quality for the selected situation.

### Types

**SPORT (⚡):** When you want to record a fast-moving subject.

**DUSK (🌇):** When you want to faithfully record the red of the setting sun, and the surrounding twilight.

**SUNLIGHT (☀):** When background is very bright.

**PARTY (🎉):** When the illumination is from a spotlight or candle.

**NIGHT LUMI (🌃):** When you want to record fireworks or an illuminated object in the dark.

**SLOW SHUT. (📷):** When you want to record an object in a dim place and make it emerge brightly.

- 1 In Camera mode, press the DISPLAY button until the mode screen appears.
- 2 Press  $\nabla$  or  $\Delta$  on the Operation button to select "SCENE MENU", then press the centre of the Operation button.



- 3 Press  $\nabla$  or  $\Delta$  to select the scene setting that best fits the recording situation, then press the centre of the Operation button.
  - The selected scene setting displays on the mode screen.

**SCENE MENU ▶ DUSK**

- 4 Press the DISPLAY button to turn off the mode screen.
  - The selected scene setting indicator displays when the on-screen indicators are turned on.

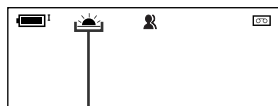

Scene setting indicator

### To cancel the scene setting

Select "OFF" in step 3 above.

#### Note:

- Scene settings cannot be used when using any manual setting except focus. Also not selectable when  $\nabla \nabla \nabla$  displays.

# Advanced Features

## Playback

### Using the Time Code

The time code shows the hour, minute and second of recording, and the frame number (1 frame = approx. 1/25 sec.). This is automatically recorded along with the subject when you are recording on the tape. You can display the time code on the screen as an accurate counter in both Playback and Camera modes.

### Display format

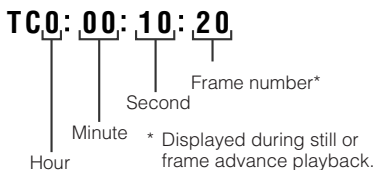

• The example screens shown are for Playback mode.

- 1 During playback or camera recording, press the DISPLAY button until the mode screen appears.
- 2 Select "MENU", then "EXECUTE" by using the Operation button (see page 28).
- 3 Press  $\nabla$  or  $\Delta$  to select  2, then press the centre of the Operation button.
- 4 Press  $\nabla$  or  $\Delta$  to select "TIME CODE", then press the centre of the Operation button.

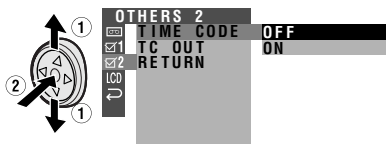

- 5 Press  $\nabla$  or  $\Delta$  to select "ON", then press the centre of the Operation button.

**TIME CODE ON**

- 6 Press the DISPLAY button to turn off the menu screen.
  - The time code appears when the on-screen indicators are turned on.

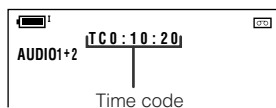

### To turn off the time code

Select "OFF" in step 5 above.

#### Note:

- When the tape reaches an unrecorded section, the time code returns to zero (TC0:00:00). Once recorded, the time code cannot be changed.

### Displaying the time code on a TV during playback

- 1 In Playback mode, press the DISPLAY button until the mode screen appears.
- 2 Select "MENU", then "EXECUTE" by using the Operation button (see page 28).
- 3 Press  $\nabla$  or  $\Delta$  to select  2, then press the centre of the Operation button.
- 4 Press  $\nabla$  or  $\Delta$  to select "TC OUT", then press the centre of the Operation button.

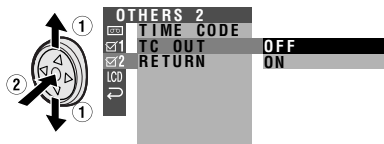

- 5 Press  $\nabla$  or  $\Delta$  to select "ON", then press the centre of the Operation button.

**TC OUT ON**

- 6 Press the DISPLAY button to turn off the menu screen.

## Editing

Video editing lets you refine your videos by removing unwanted sequences from your tape, or transposing one sequence with another.

This camcorder lets you monitor the source program on the built-in LCD monitor without having to connect it to an external TV or video monitor.

### Preparation

Connect the camcorder to a VCR with the supplied audio/video/S-video cable, as shown.

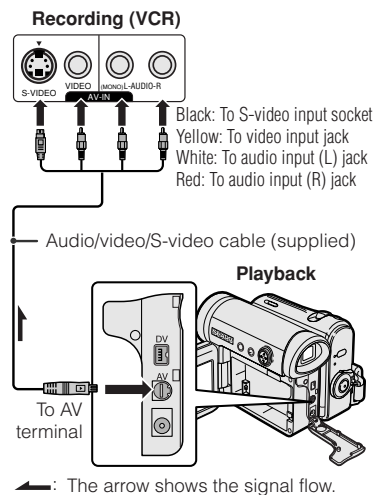

#### Notes:

- If your VCR has a 21-pin Euro-SCART connector, use the RCA/21-pin Euro-SCART conversion connector (QSOCZ0033TAZZ) available from our main parts distributor detailed on page 70.



- See page 2 for how to open the terminal cover.
- If your VCR has only one audio input jack, use the white plug for the audio connection on the VCR.
- If your VCR has an S-video input socket, you do not need to connect the yellow video plug.

### Cutting Unwanted Sequences

- 1 Play back the tape to be edited on the camcorder, and locate the beginning and end of the sequence you wish to cut. Write down the time code reading at the beginning and end of that sequence (see page 54). Then, rewind the tape to before the beginning of the portion that you wish to keep.
- 2 Load a video cassette into the recording VCR.
- 3 Press  $\Delta$  on the camcorder to begin playback, then press the Record button on the VCR to begin recording.
- 4 Press the Pause/Still button on the VCR to pause recording when the source tape reaches the beginning of the sequence to be cut.
- 5 Press the Pause/Still (or Record) button on the VCR to resume recording when the source tape reaches the end of the sequence to be cut.

### To stop editing

Press  $\nabla$  on the camcorder and press the Stop button on the VCR.

#### Notes:

- Some of the transitions between edited sequences may be slightly off.
- There may be picture noise during video search or still playback. This does not imply a defect in the camcorder.
- The time code display will be recorded along with the edited sequences if the TC OUT menu item is set to "ON". Set to "OFF" before editing (see page 54).

### Editing with the DV Terminal (IEEE1394)

This camcorder enables you to perform digital video editing. A DV cable transfers all dubbing signals including video and audio.

#### Preparation

Connect the camcorder to video equipment with a DV terminal using a commercially available DV cable.

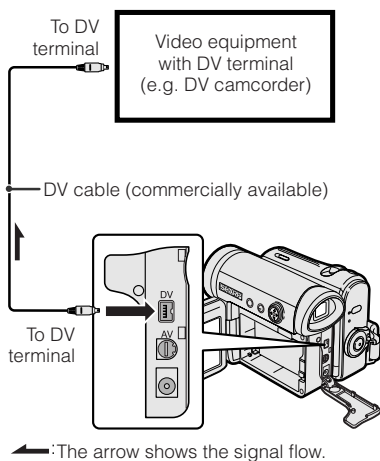

### Cutting Unwanted Sequences

See "Cutting Unwanted Sequences" on page 55, using the video equipment as the recording source.

#### Notes:

- Make sure that the video equipment to which you are recording can input dubbing signals via the DV terminal.
- When displaying the playback picture on the PC, you may find black bands around the image. This is caused by the differences of the image display sizes.
- "i.Link" refers to the IEEE1394-1995 industry specification and extensions thereof. The **i** logo is used for products compliant with the i.Link standard.

## Audio Dubbing Feature

You can add narration to recordings made with this camcorder, while preserving the original audio and video recordings.

### Microphone for Audio Dubbing

You can use the built-in monaural microphone to record narration.

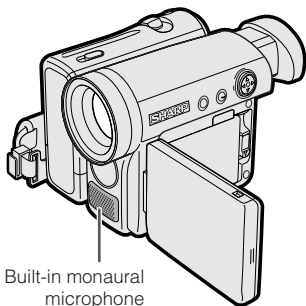

Built-in monaural microphone

#### Note:

- You cannot use audio dubbing with recordings made in LP mode.

## Audio Recording

### In normal recording mode

#### 12-bit audio recording

The audio is recorded in monaural on Audio 1.

**Audio 1:** Monaural sound

**Audio 2:** No audio

#### 16-bit audio recording

The audio is recorded in monaural on two separate channels.

**Audio 1:** Monaural sound

**Audio 2:** Monaural sound

### In Audio Dubbing mode

#### 12-bit audio recording

The dubbed audio is recorded on Audio 2.

**Audio 1:** Original monaural sound

**Audio 2:** Dubbed monaural sound

#### 16-bit audio recording

The dubbed audio is recorded on Audio 2 over the original monaural sound.

**Audio 1:** Original monaural sound

**Audio 2:** Dubbed monaural sound

#### Note:

- You can select the 12-bit or 16-bit audio recording mode by performing the procedure on page 41.

### Audio Dubbing

- 1 Play back the Mini DV cassette recorded in SP mode and locate the tape position where you wish to start audio dubbing.
- 2 Press  $\Delta$  on the Operation button to pause playback.
- 3 Press the DISPLAY button until the mode screen appears.
- 4 Press  $\nabla$  or  $\Delta$  to select "AUDIO DUB", then press the centre of the Operation button.



- 5 Press  $\nabla$  or  $\Delta$  to select "EXECUTE", then press the centre of the Operation button.
  - The audio dubbing screen appears.



- 6 Press  $\Delta$  to begin audio dubbing. Record your narration.

### To pause audio dubbing

Press  $\nabla$ . To resume audio dubbing, press  $\Delta$  again.

### To cancel audio dubbing

Press the centre of the Operation button in step 5. The audio dubbing screen disappears.

### If you wish to change the dubbed audio or dub additional scenes

- 1 Press the DISPLAY button to turn off the audio dubbing screen.
- 2 Repeat steps 1 to 6 above.

#### Notes:

- It is recommended that you use Audio Dubbing only with recordings made with this camcorder. Use of recordings made with other digital video equipment may result in poor audio quality.
- Audio dubbing will automatically pause if the original audio changes from 12-bit mode to 16-bit mode or vice versa. Press  $\Delta$  to resume operation.
- Audio dubbing will automatically stop if a portion recorded in LP mode or an unrecorded portion of the tape is encountered.
- You can play back the dubbed audio and the original audio together or separately (see page 59).
- "AUDIO DUB" cannot be selected when the Mini DV cassette is recorded in LP mode.

## Selecting the Audio Playback Mode

You can select any of the following audio playback modes.

### Audio 1+2

- 12-bit recording in mono (Audio 1 and Audio 2 channels)
- 16-bit recording in mono

### Audio 1

- 12-bit recording in mono (Audio 1 channel only)
- 16-bit recording in mono

### Audio 2

- 12-bit recording in mono (Audio 2 channel only)
- 16-bit recording in mono

### Note:

- This camcorder can output stereo sound when a tape is recorded in stereo.

- 1 Playback a Mini DV cassette with dubbed audio.
- 2 Press the DISPLAY button until the mode screen appears.
- 3 Select "MENU", then "EXECUTE" by using the Operation button (see page 28).

- 4 Press  $\nabla$  or  $\Delta$  to select  $\text{MENU}$ , then press the centre of the Operation button.

- 5 Press  $\nabla$  or  $\Delta$  to select "AUDIO", then press the centre of the Operation button.

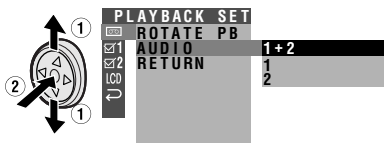

- 6 Press  $\nabla$  or  $\Delta$  to select the desired audio playback mode, then press the centre of the Operation button.

**AUDIO** 1+2

- 7 Press the DISPLAY button to turn off the menu screen.

- The selected audio playback mode indicator only appears when the on-screen indicators are turned on.

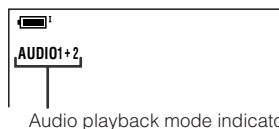

### Note:

- The audio playback mode indicator, "AUDIO", displays in different colours depending on the recording mode (12- or 16-bit) used for the recording being played back. A white display indicates 12-bit recording mode, while a green indicates 16-bit.

## Picture/Backlight Adjustments

If the picture is difficult to see due to ambient light or other factors, adjust the monitor picture settings.

- The example screens shown are for Camera mode.

### Adjusting the Picture

- 1 Press the DISPLAY button until the mode screen appears.
- 2 Press  $\nabla$  or  $\Delta$  on the Operation button to select "MENU", then press the centre of the Operation button.
- 3 Press  $\nabla$  or  $\Delta$  to select "EXECUTE", then press the centre of the Operation button.
- 4 Press  $\nabla$  or  $\Delta$  to select LCD, then press the centre of the Operation button.



- 5 Press  $\nabla$  or  $\Delta$  to select "LCD BRIGHT", "LCD COLOUR" or "VF BRIGHT", then press the centre of the Operation button.

- 6 Press  $\leftarrow$  or  $\rightarrow$  to adjust the item to the desired setting, then press the centre of the Operation button.



- 7 Press the DISPLAY button to turn off the menu screen.

#### Notes:

- When adjusting the colour, the picture on the LCD monitor may differ from the picture actually recorded. Do not change the colour setting unless necessary. (This adjustment only affects the monitor picture, not the recorded image.)
- The viewfinder turns on if you select "VF BRIGHT".



## Adjusting the Backlight

- 1 Press the DISPLAY button until the mode screen appears.
- 2 Press  $\nabla$  or  $\Delta$  on the Operation button to select "MENU", then press the centre of the Operation button.
- 3 Press  $\nabla$  or  $\Delta$  to select "EXECUTE", then press the centre of the Operation button.
- 4 Press  $\nabla$  or  $\Delta$  to select LCD, then press the centre of the Operation button.
- 5 Press  $\nabla$  or  $\Delta$  to select "BACK-LIGHT", then press the centre of the Operation button.



- 6 Press  $\nabla$  or  $\Delta$  to select "NORMAL" or "BRIGHT", then press the centre of the Operation button.

### BACK LIGHT BRIGHT

**NORMAL:** For use indoors or under moderate lighting conditions.

**BRIGHT:** For use outdoors under strong lighting conditions, such as bright daylight.

- 7 Press the DISPLAY button to turn off the menu screen.

### Turning off the Confirmation Sound

A confirmation sound is made when you turn on or off the Power switch, press the Start/Stop button, or perform other designated operations. Use the procedure below to turn off the confirmation sounds.

- The example screens shown are for Camera mode.

- 1 Press the DISPLAY button until the mode screen appears.
- 2 Press  $\nabla$  or  $\Delta$  on the Operation button to select "MENU", then press the centre of the Operation button.
- 3 Press  $\nabla$  or  $\Delta$  to select "EXECUTE", then press the centre of the Operation button.
- 4 Press  $\nabla$  or  $\Delta$  to select  1, then press the centre of the Operation button.
- 5 Press  $\nabla$  or  $\Delta$  to select "BEEP", then press the centre of the Operation button.

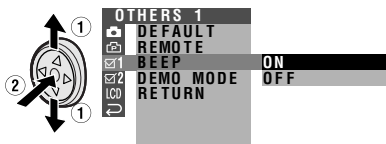

- 6 Press  $\nabla$  or  $\Delta$  to select "OFF", then press the centre of the Operation button.

**BEEP OFF**

- 7 Press the DISPLAY button to turn off the menu screen.

## Setting the Camcorder to Factory Presettings

You can set the camcorder to the factory presettings in one operation.

- The example screens shown are for Camera mode.

- 1 Press the DISPLAY button until the mode screen appears.
- 2 Press  $\nabla$  or  $\Delta$  on the Operation button to select "MENU", then press the centre of the Operation button.
- 3 Press  $\nabla$  or  $\Delta$  to select "EXECUTE", then press the centre of the Operation button.
- 4 Press  $\nabla$  or  $\Delta$  to select  $\boxtimes$ 1, then press the centre of the Operation button.
- 5 Press  $\nabla$  or  $\Delta$  to select "DEFAULT", then press the centre of the Operation button.

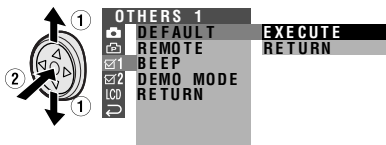

- 6 Press  $\nabla$  or  $\Delta$  to select "EXECUTE", then press the centre of the Operation button.

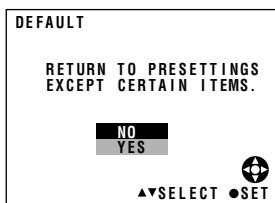

- 7 Press  $\nabla$  or  $\Delta$  to select "YES", then press the centre of the Operation button.
  - To cancel the setting, select "NO".
- 8 Press the DISPLAY button to turn off the menu screen.

### Note:

- Even when you perform the steps above, the clock setting maintains the memory.

### Demonstration Mode

You can watch a brief demonstration of the special camcorder features in Demo mode. If the demonstration appears on the screen when you turn on the camcorder for the first time, cancel the Demo mode to use your camcorder.

#### Watching

- 1 Remove the Mini DV cassette from the camcorder (see page 9).
- 2 In Camera mode, press the DISPLAY button until the mode screen appears.
- 3 Press  $\nabla$  or  $\Delta$  on the Operation button to select "MENU", then press the centre of the Operation button.
- 4 Press  $\nabla$  or  $\Delta$  to select "EXECUTE", then press the centre of the Operation button.
- 5 Press  $\nabla$  or  $\Delta$  to select  $\checkmark$  1, then press the centre of the Operation button.
- 6 Press  $\nabla$  or  $\Delta$  to select "DEMO MODE", then press the centre of the Operation button.

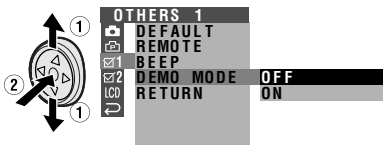

- 7 Press  $\nabla$  or  $\Delta$  to select "ON", then press the centre of the Operation button.

#### DEMO MODE ON

- 8 Set the Power switch to OFF, then hold down the Lock button and set the Power switch to  $\blacksquare$ .
  - The demonstration begins.

#### Cancelling

- 1 During the demonstration, press the centre of the Operation button to pause the demonstration.
- 2 Perform step 3 to 6 in "Watching", then select "OFF" in step 7.

#### Notes:

- The demonstration will pause if you press the centre of the Operation button. If you leave it for 60 seconds, or turn the power off temporarily and then set the Power switch to  $\blacksquare$ , the demonstration will begin again.
- Demonstration mode does not work in self recording with reversed grip.

## Useful Information

### Hints for Better Shooting

- Position the subject in the centre of the scene. When using auto focus, whatever is in the centre of the scene is kept in focus.



Position the subject in the centre.



Focus manually when you need to position the subject off centre (see page 47).

- Avoid backlit subjects. For the best picture, shoot with the light source behind you.

When the background is brighter than the subject, the subject often becomes too dark. If you have to record in this lighting, use Backlight Compensation or correct the iris value to improve the picture (see pages 30 and 50).

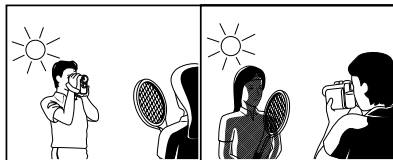

Light from behind

Backlighting

- Before zooming, think about how to best frame the shot. Frequent zooming produces unattractive pictures. It also runs down the battery more quickly.
- When image shaking is noticeable during zoomed-in telephoto shooting, use a tripod or push the Power Zoom control to the W side to zoom out.

- Horizontal panning (lateral movement) and tilting (vertical movement) should be done slowly to emphasize the wide expanse of a scene or the height of a building, and to make scenes easy to watch during playback.
- Use a wide-angle setting for fast-moving subjects.

#### Note:

- It may take longer to focus when zooming and panning are used frequently.

### Mini DV Cassette

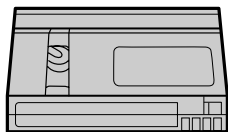

#### Precautions when using a Mini DV cassette

- Be sure to use only Mini DV cassettes with the **Mini DV** mark.
- This camcorder can record and play back using Mini DV cassettes with cassette memory, but it cannot record or play back this memory.
- To record in LP mode, use a Mini DV cassette labelled for use with LP mode.
- Do not insert anything into the holes on the bottom of the Mini DV cassette or block them in any way.
- Avoid placing the Mini DV cassette in areas conducive to dust or mold.
- Do not place the Mini DV cassette near magnetic sources such as electric clocks or magnetic devices as this may adversely affect recorded material.
- When a previously recorded Mini DV cassette is used again for recording, the previously recorded material will be automatically erased.
- The Mini DV cassette will not operate if inserted in the wrong direction.
- Do not repeatedly insert and eject the Mini DV cassette without running the tape as this may cause uneven tape winding and damage the tape.
- Do not place the Mini DV cassette in direct sunlight, near strong heat sources, or in areas with excessive steam.
- Store the Mini DV cassette in its case and stand it in an upright position.
- If the tape is not properly wound, rewind the tape.
- Do not drop the Mini DV cassette or subject it to excessive shocks.

#### To protect recordings against accidental erasure

Slide the protect tab on the rear of the Mini DV cassette to the "SAVE" position.

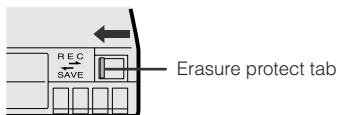

To record over a previously recorded tape, slide the protect tab to the "REC" position.

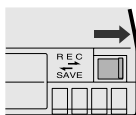

## Battery Pack

This camcorder uses a lithium-ion type battery pack.

### Charging

- Charge the battery pack immediately (or a day) before use. The battery pack gradually self-discharges even if stored in a fully charged state.
- Charge the battery pack between 10°C and 30°C.
- Fully charge the battery pack. Use of an insufficiently charged battery pack will shorten actual time of use.
- Refresh (discharging before charging) is unnecessary.

### Use

- To conserve battery power, be sure to turn off the camcorder power when not in use.
- Battery consumption may vary depending on the condition of use. Recording with many starts and stops, frequent zooming, and recording in low temperatures will shorten actual recording times.
- Use of a weak battery pack may cause loss of power while operating the camcorder. Use a fully charged battery pack to protect both the battery pack and the unit.
- It is recommended that you have enough battery packs on hand to handle two or three times your estimated recording time. See page 19 for the approximate times of actual recording for the battery packs.

Battery power is consumed even when the camcorder power is turned off. If you are not going to use your camcorder immediately, remove the battery pack (see page 6).

#### Note:

- Use only SHARP BT-L226 battery packs. These are designed specifically for use with this camcorder.

### Storage

- Store the battery pack in a fully discharged state.
- Store the battery pack in a dry, cool place.
- When storing the battery pack, put it in the original protective plastic bag.

#### Notes:

- Improper handling of the battery pack may present a risk of fire or explosion. Pay close attention to the following:
  - Do not allow metallic objects to come in contact with the terminals. This can cause a short circuit.
  - Do not disassemble or repair the battery pack by yourself.
  - Do not use any battery charging equipment other than that designed for use with these battery packs.
  - Do not place the battery pack under direct sunlight or in excessively hot places (over 60°C) such as the dashboard of cars.
  - Do not expose the battery pack to moisture or water.
  - Do not drop the battery pack or subject it to strong force.
  - Keep the battery pack out of reach of children.
  - Dispose of used battery packs promptly. Do not dispose of them in fire.
- To protect the terminals, put the cover on the battery pack when it is not in use.
- The battery pack will become warm during charging and use. This is not a malfunction.
- The battery pack has a limited service life. If the period of use becomes noticeably shorter with a normal charge, the battery pack is at the end of its service life. Replace it with a new battery pack.
- If the terminals of the battery pack are dirty, wipe the terminals with a soft, dry cloth.

### Extending battery pack life

Even when the battery pack is not used, the capacity of the battery pack will naturally deteriorate over time. To limit the deterioration of the capacity, it is recommended to perform the following procedure at least once every six months:

- ① Charge the battery pack until the POWER/CHARGE (RED) indicator turns off.
- ② Attach the battery pack to the camcorder, and set the Power switch to  without inserting a cassette. Allow the battery power to fully discharge by leaving it on the camcorder until the camcorder power automatically turns off.
- ③ Remove the battery pack and store it between 10°C and 20°C.

### AC Adapter

- The AC adapter may interfere with reception if used near a radio.
- Prevent flammables, liquids, and metal objects from entering the adapter.
- The adapter is a sealed unit. Do not attempt to open or modify it.
- Do not damage, drop, or subject the adapter to vibration.
- Do not leave the adapter in direct sunlight.
- Avoid using the adapter in humid or extremely hot places.

### Replacing the Fluorescent Lamp

This camcorder uses a fluorescent lamp to backlight the LCD monitor. If the monitor becomes dark or difficult to view, the fluorescent lamp may need to be replaced. Contact the nearest SHARP service centre or your dealer for further advice.

### Cleaning

- Many plastic parts are used in the camcorder casing. Do not use thinner, benzene or other strong chemical cleaners. These may cause discolouration and damage to the casing.
- Clean the casing with a soft, dry cloth. If the casing is particularly dirty, wipe the casing with a tightly wrung cloth dampened with a diluted, neutral detergent. Then wipe it again with a soft, dry cloth.
- Use a soft cloth to wipe finger marks and other smudges off the LCD screen.
- Use a soft cloth, or compressed air and lens paper designed for photographic lenses to clean the lens.
- Pull out the viewfinder and open the window cleaning cover as shown below so that you can clean up the inside of the viewfinder with a camera blower.

Window cleaning cover

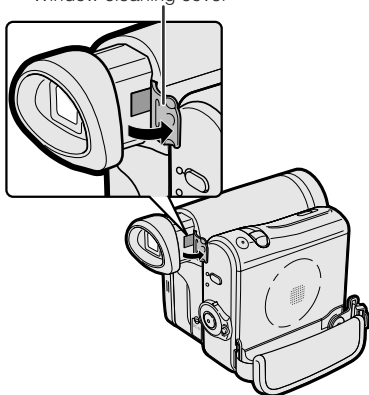

#### Note:

- After cleaning, close the window cleaning cover securely. Closing the viewfinder with the window cleaning cover opened may cause malfunction.



---

## Using Your Camcorder Abroad

Television signal standards and electrical voltages and frequencies vary substantially from country to country. When you are abroad, check the sections below before using the AC adapter or connecting the camcorder to a TV.

### AC Adapter (Supplied Accessory)

The supplied AC adapter is compatible with 50 Hz and 60 Hz electrical systems in the range of 110 V to 240 V AC.

### Television Signal Standards

In any country, you can always watch the video picture by using the LCD monitor screen. However, if you want to watch the picture on a TV screen, the TV must be PAL system compatible. PAL is used in the following areas:

Germany, United Kingdom, Ireland, Sweden, Denmark, Austria, Belgium, Switzerland, Italy, Spain, Holland, Finland, Portugal, Norway, Hong Kong, Thailand, Australia, New Zealand, Singapore, Kuwait, China, etc.

## Troubleshooting

The following conditions do not always denote trouble. Therefore, perform the checks described below before calling for service. If the problem cannot be corrected by the use of this guide, remove the main plugs from the wall socket, and contact the dealer or supplier from whom the unit was purchased in order to obtain service. Where this is not possible, please visit our web-site [www.sharp.co.uk/customersupport](http://www.sharp.co.uk/customersupport).

Customers without Internet access may telephone **08705 274277** during office hours (or **(01)676 0648** if telephoning from Ireland).

Certain replacement parts and accessories may be obtained from our main parts distributor, who can be contacted on the following numbers:

WILLOW VALE ELECTRONICS LTD.: **0121 766 5414**

In the unlikely event of this equipment requiring repair during the guarantee period, you will need to provide proof of the date of purchase to the repairing company. Please keep your invoice or receipt, which is supplied at the time of purchase.

	Symptom	Possible cause	Suggested solution
Power	No power.	Power source is not properly connected.	Connect power source properly (pp. 5, 8).
		Battery pack is not charged.	Charge battery pack sufficiently (p. 7).
		Dew in camcorder.	Wait until dew dries (p. xi).
		Safety function is in effect.	Set Power switch to OFF and remove battery pack. Wait for 2 seconds, then reinstall battery pack and turn on power (pp. 5, 6).
Camera mode	Start/Stop button does not work.	Erase-protect tab on video cassette is open.	Close tab or use a new cassette (p. 66).
	Power suddenly turns off.	Camcorder left in Recording Standby mode for 5 minutes in Camera mode.	Set Power switch to OFF and then back to Camera mode.
	Auto focus does not work.	Manual Focus mode is engaged.	Set to Auto Focus mode (p. 48).
		Zoom used on close subject.	Zoom out from subject (p. 20).
		Subject has little contrast in brightness, or is full of horizontal or vertical stripes.	Focus manually (p. 47).
	Bright subject produces wide vertical lines.	Occurs when shooting subject with strong contrast to the background. Does not indicate a malfunction.	—
Display automatically changes in Camera mode.	Camcorder is in Demo mode.	Set the DEMO MODE menu item to "OFF" (p. 64).	

	Symptom	Possible cause	Suggested solution
Playback mode	No image appears on connected TV screen.	Video input channel on TV or TV channel is not selected properly.	Select video input channel or TV channel properly (p. 26).
		Audio/video/S-video cable is not properly connected.	Connect audio/video/S-video cable properly (p. 26).
	Cannot rewind or fast forward tape.	Position at beginning or end of tape.	Rewind or fast forward tape to desired point (p. 24).
		Using a cleaning tape	The cleaning tape will automatically rewind after cleaning finishes (p. xii).
	Video noise in image.	Dirty video heads.	Call for service (p. 70) or use a commercially available cleaning tape (p. xii).
		Old or worn tape.	Use a new cassette.
	No sound.	Using a 12-bit recording tape with AUDIO menu item set to "AUDIO 2".	Set the AUDIO menu item to "AUDIO 1" or "AUDIO 1+2" (p. 59).
	Tape does not work.	Power switch is set to Camera mode.	Set the Power switch to Playback mode (p. 24).
Battery pack is depleted.		Charge battery pack or replace it with a fully charged one (pp. 5-7).	
Motion images are rotated 180° upside down.	Improper self recording.	Turn on Rotate Playback (p. 46).	
General	Battery pack is easily depleted.	Using camcorder in extremely cold environment.	Warm up battery pack, for example in your pocket, just before using it.
		Battery pack is not fully charged.	Charge battery pack sufficiently (p. 7).
	Clock has been reset.	Lithium battery is not properly installed.	Install lithium battery properly (p. 10).
		Lithium battery is depleted.	Replace new lithium battery (p. 10).
	Cassette will not eject.	Power source is not properly connected.	Connect power source properly (pp. 5, 8).
		Battery pack is not charged.	Charge battery pack sufficiently (p. 7).
		Camcorder is recording.	Stop recording and try again (p. 20).
	No image on monitor.	Backlight has been turned off.	Turn on backlight (p. 21).
Fluorescent lamp has burned out.		Call for service (p. 70).	

## Appendix

	Symptom	Possible cause	Suggested solution
General	Viewfinder picture is hard to see.	Viewfinder dioptre is not properly adjusted.	Adjust dioptre (p. 16).
		Inappropriate picture adjustments.	Adjust picture (p. 60).
	Monitor picture is hard to see.	Inappropriate picture adjustments.	Adjust picture (p. 60).
	POWER/CHARGE (RED) indicator flashes in red when charging battery pack.	AC adapter or battery pack may have malfunctioned.	Call for service (p. 70).
	Cannot edit to connected VCR.	Audio/video/S-video cable is not properly connected.	Connect audio/video/S-video cable properly (p. 55).
	"E007" is displayed on the screen, and unable to operate normally.	The camcorder may be damaged.	Do not take out a cassette, and call for service (p. 70).

### Notes:

- This unit is equipped with a microprocessor. Its performance could be adversely affected by external electrical noise or interference. If this should happen, turn off the power and disconnect the unit from any power sources, including the lithium battery, etc. Then reconnect the power sources to resume operation.
- If the characters displayed in the viewfinder or on the LCD monitor screen appear to malfunction, disconnect the power source and remove the lithium battery, then reconnect the power source, insert the lithium battery, and turn the power on again. The characters on the monitor should be normal. Set the date and time, then resume operation.

## Specifications

### Camcorder

Signal System:	PAL standard
Recording System:	2 rotary heads, helical scanning system
Cassette:	Digital VCR Mini DV video cassette
Recording/Playback Time:	90 minutes (DVM60, LP mode)
Tape Speed:	SP mode: 18.831 mm/second LP mode: 12.568 mm/second
Pickup Device:	¼" (6.4 mm, effective size: 4.5 mm) CCD image sensor (with approx. 800,000 pixels including optical black, effective pixels: approx. 414,000 pixels)
Lens:	10× optical zoom lens (F1.8, f=3.8–38 mm)
Lens Filter Diameter:	30 mm
Monitor:	2.5" (6.4 cm) CGSilicon
Built-in microphone:	Electret monaural microphone
Colour Temperature Compensation:	Auto white balance with white balance lock
Minimum Illumination:	2 lux* (with gain-up, F1.8)
Power Requirement:	DC 7.4 V
Power Consumption:	3.6 W (during camera recording in Camera mode using the viewfinder in Full Auto mode with the DIS function on) 4.2 W (during camera recording in Camera mode using the LCD monitor in Full Auto mode with the DIS function on and backlight in normal mode)
Operating Temperature:	0°C to +40°C
Operating Humidity:	30% to 80%
Storage Temperature:	-20°C to +60°C
Dimensions (W×H×D) (approx.):	82.8 mm × 82.2 mm × 101.5 mm
Weight (approx.):	475 g (without battery pack, lithium battery, video cassette and lens cap)

### AC Adapter (UADP-A016WJZZ)

Power Requirement:	AC 110–240 V, 50/60 Hz
DC Output:	10 V
Dimensions (W×H×D) (approx.):	49.0 mm × 27.5 mm × 79.0 mm
Weight (approx.):	125 g

Specifications are subject to change without notice.

\*Minimum illumination: Since there is no widely accepted testing procedure for determining minimum illumination capability, lux ratings are comparable only between models from the same manufacturer.

## On-screen Display Index

### Camera mode

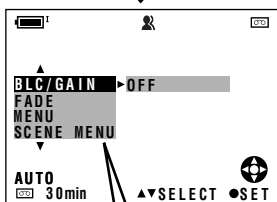
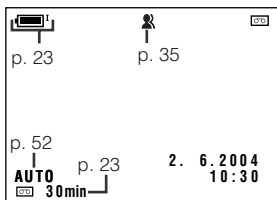

- pp. 30, 31
- p. 32 — BLC/GAIN
- p. 28 — FADE
- MENU
- p. 53 — SCENE MENU
- MANUAL SET
- p. 48 — FOCUS
- p. 47 — AUTO FOCUS
- p. 48 — DATE DISP.
- p. 44

- SETTING 1**
  - OK RETURN — p. 33
  - DGTL ZOOM — p. 29
  - TAPE SPEED — p. 39
  - RETURN
- SETTING 2**
  - DIS — p. 35
  - 16:9 — p. 38
  - AUDIO MODE — p. 41
  - WIND — p. 40
  - RETURN
- OTHERS 1**
  - DEFAULT — p. 63
  - REMOTE — p. 42
  - BEEP — p. 62
  - DEMO MODE — p. 64
  - RETURN
- OTHERS 2**
  - TIME CODE — p. 54
  - TC OUT — p. 54
  - 12H/24H — p. 13
  - SETTING — p. 12
  - RETURN
- LCD SET**
  - BACKLIGHT — p. 61
  - LCD BRIGHT — p. 60
  - LCD COLOUR — p. 60
  - VF BRIGHT — p. 60
  - RETURN

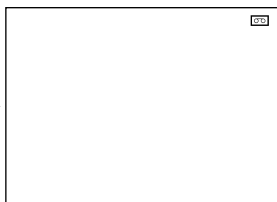

## Playback mode

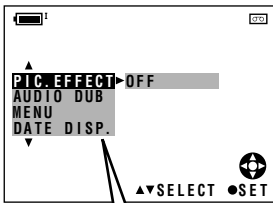
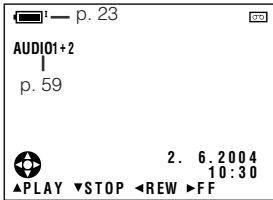

p. 45 — PIC.EFFECT  
 p. 58 — AUDIO DUB  
 p. 28 — MENU  
 p. 44 — DATE DISP.

PLAYBACK SET  
 ROTATE PB — p. 46  
 AUDIO — p. 59  
 RETURN

OTHERS 1  
 DEFAULT — p. 63  
 REMOTE — p. 42  
 BEEP — p. 62  
 RETURN

OTHERS 2  
 TIME CODE — p. 54  
 TC OUT — p. 54  
 RETURN

LCD SET  
 BACKLIGHT — p. 61  
 LCD BRIGHT — p. 60  
 LCD COLOUR — p. 60  
 VF BRIGHT — p. 60  
 RETURN



# **SHARP CORPORATION**

## **SHARP ELECTRONICS (U.K.) LTD.**

Sharp House, Thorp Road, Newton Heath  
Manchester M40 5BE

Printed in Japan  
TINSEA058WJZZ  
03P04-JKG



## Free Manuals Download Website

<http://myh66.com>

<http://usermanuals.us>

<http://www.somanuals.com>

<http://www.4manuals.cc>

<http://www.manual-lib.com>

<http://www.404manual.com>

<http://www.luxmanual.com>

<http://aubethermostatmanual.com>

Golf course search by state

<http://golfingnear.com>

Email search by domain

<http://emailbydomain.com>

Auto manuals search

<http://auto.somanuals.com>

TV manuals search

<http://tv.somanuals.com>