

SHARP®

MODEL

LC-32LE155X

LC-39LE155X

LED BACKLIGHT TV

OPERATION MANUAL

AQUOS



SRS
TruSurround HD

MHL
Mobile High-Definition Link

DIVX
HD

HDMI

DOLBY
DIGITAL PLUS

LED

DVB
Digital Video
Broadcasting

Dear SHARP customer

Thank you for your purchase of the SHARP LCD colour TV product. To ensure safety and many years of trouble-free operation of your product, please read the Important Safety Precautions carefully before using this product.

Contents

	Page		Page
Dear SHARP customer.....	1	Setup menu.....	12
Supplied accessories.....	1	Option menu.....	14
Important Safety Precautions.....	2	Programme Guide.....	16
Important information.....	3	Info.....	16
Trademarks.....	3	ATV/DTV/RADIO buttons.....	17
Attaching the stand.....	4	Switching the analogue audio format.....	18
Antenna connection.....	4	EPG.....	19
Connecting external devices.....	4	Colour adjustment and still image.....	20
Remote control unit.....	6	ECO mode.....	20
Part names.....	7	Using a Smartphone with the TV.....	20
Turning the TV on/off.....	7	Teletext function.....	21
Initial auto installation.....	8	PC compatibility chart.....	22
Checking Signal information.....	8	PC Control of the TV.....	22
Auto installation.....	8	RS-232C commands list.....	23
Programme setup.....	8	USB Media Player.....	24
Selecting a preset AV mode.....	10	Appendix.....	27
Menu operation.....	10	Specifications.....	28
Picture menu.....	10	Protection against overturning.....	29
Audio menu.....	11	Dimensional drawings.....	30
ECO menu.....	11	CLEARING THE PASSWORD.....	32

Supplied accessories

Remote control unit



"AAA" size battery (×2)



Operation manual



Stand unit

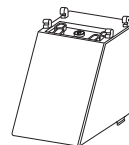
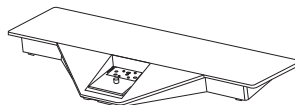

Stand base

Post

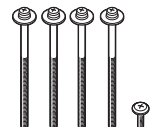

Screws (× 5)

Safety restrains



Screw for band



Screws for clamps



Clamps

Restraining band

(only for LC-32LE155X)

Important Safety Precautions

- Stand base must be attached to prevent the TV set from falling down and cause injuries.
- Cleaning — Unplug the AC cord from the AC outlet before cleaning the product. Use a soft damp cloth to clean the product. Do not use liquid cleaners, aerosol cleaners or chemical cloth to clean it, as such materials may damage the product.
- Water and moisture — Do not use the product near water, such as bathtub, washbasin, kitchen sink, laundry tub, swimming pool and in a wet basement.
- Do not place vases or any other water-filled containers on this product.
The water may spill onto the product causing fire or electric shock.
- Stand — Do not place the product on an unstable cart, stand, tripod or table. Doing so can cause the product to fall, resulting in serious personal injuries as well as damage to the product. Use only a cart, stand, tripod, bracket or table recommended by the manufacturer or sold with the product. When mounting the product on a wall, be sure to follow the manufacturer's instructions. Use only the mounting hardware recommended by the manufacturer.
- When relocating the product placed on a cart, it must be moved with utmost care. Sudden stops, excessive force and uneven floor surface can cause the product to fall from the cart.
- Ventilation — The vents and other openings in the cabinet are designed for ventilation. Do not cover or block these vents and openings since insufficient ventilation can cause overheating and/or shorten the life of the product. Do not place the product on a bed, sofa, rug or other similar surface, since they can block ventilation openings. This product is not designed for built-in installation; do not place the product in an enclosed place such as a bookcase or rack, unless proper ventilation is provided or the manufacturer's instructions are followed.
- The LCD panel used in this product is made of glass. Therefore, it can break when the product is struck forcefully or with a sharp object. If the LCD panel is broken, be careful not to be injured by broken glass.
- Heat sources — Keep the product away from heat sources such as radiators, heaters, stoves and other heat-generating products (including amplifiers).
- To prevent fire, never place any type of candle or naked flames on the top or near the TV set.
- To prevent fire or shock hazard, do not place the AC power cord under the TV set or other heavy items.
- Do not place heavy objects on this product or stand on it. Doing so could cause injury if the product overturns. Take special care near children and pets.
- The LCD panel is a very high technology product with 1,049,088 (only for LC-32LE155X)/2,073,600 (only for LC-39LE155X) pixels, giving you fine picture details.
Due to the very large number of pixels, occasionally a few non-active pixels may appear on the screen as a fixed point of blue, green or red.
This is within product specifications and does not constitute a fault.
- **Precautions when transporting the TV**
When transporting the TV, never carry it by holding or otherwise putting pressure onto the display. Be sure to always carry the TV by two people holding it with two hands — one hand on each side of the TV.
- Do not display a still picture for a long time, as this could cause an afterimage to remain.
- Install the product on the place where the AC cord can be unplugged easily from the AC outlet or from the AC INPUT terminal on the rear of the product.
- If a television is not positioned in a sufficiently stable location, it can be potentially hazardous due to falling. Many injuries, particularly to children, can be avoided by taking simple precautions such as:
 - Using cabinets or stands recommended by the manufacturer of the television.
 - Only using furniture that can safely support the television.
 - Ensuring the television is not overhanging the edge of the supporting furniture.
 - Not placing the television on tall furniture (for example, cupboards or bookcases) without anchoring both the furniture and the television to a suitable support.
 - Not standing the televisions on cloth or other materials placed between the television and supporting furniture.
 - Educating children about the dangers of climbing on furniture to reach the television or its controls.

Important information

This product qualifies for ENERGY STAR when "HOME" is selected for "TV location".

Setting "TV Location" to "HOME" allows the TV to achieve an energy-saving status for household use.

Trademarks

- The terms HDMI and HDMI High-Definition Multimedia Interface, and the HDMI Logo are trademarks or registered trademarks of HDMI Licensing LLC in the United States and other countries.
- TruSurround HD, SRS and the  symbol are trademarks of SRS Labs, Inc. TruSurround HD technology is incorporated under license from SRS Labs, Inc.
- SRS TruSurround HD™ creates an immersive, feature-rich surround sound experience from two speakers, complete with rich bass, high frequency detail and clear dialog.
- Manufactured under license from Dolby Laboratories. Dolby and the double-D symbol are trademarks of Dolby Laboratories.
- DivX®, DivX Certified® and associated logos are trademarks of Rovi Corporation or its subsidiaries and are used under license.
- ABOUT DIVX VIDEO: DivX® is a digital video format created by DivX, LLC, a subsidiary of Rovi Corporation. This is an official DivX Certified® device that has passed rigorous testing to verify that it plays DivX video. Visit divx.com for more information and software tools to convert your files into DivX videos.
- ABOUT DIVX VIDEO-ON-DEMAND: This DivX Certified® device must be registered in order to play purchased DivX Video-on-Demand (VOD) movies. To obtain your registration code, locate the DivX VOD section in your device setup menu. Go to vod.divx.com for more information on how to complete your registration.
- MHL, the MHL Logo, and Mobile High-Definition Link are trademarks or registered trademarks of MHL, LLC in the United States and other countries.

Attaching the stand

- Before attaching (or detaching) the stand, unplug the AC cord from the AC outlet.
- Before performing work spread cushioning over the base area to lay the TV on. This will prevent it from being damaged.

1 Confirm the screws supplied with the TV.

Screws (×5)
(used in step 2 and 3)



2 Insert and hook post guide into stand base slot holes. (①)

Fix the post using short screw. (②)

3 Insert the stand base to the stand post on the bottom of the TV. (③)

4 Insert and tighten the 4 long screws into the 4 holes on the bottom of the stand base. (④)

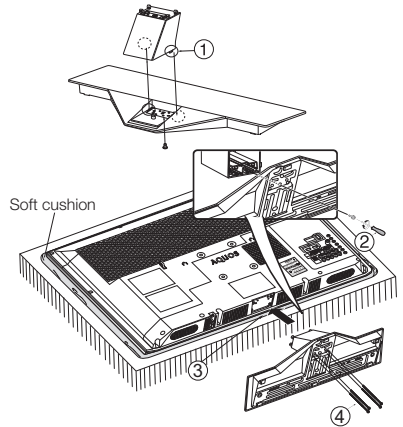

NOTE

- To detach the stand, perform the steps in reverse order.

CAUTION

- Do not attach or detach the stand without holding it. Doing so can cause the stand to fall, resulting in serious personal injuries as well as damage to the stand.

Antenna connection

Connecting the antenna cable

To enjoy a clearer picture, use an outdoor antenna.

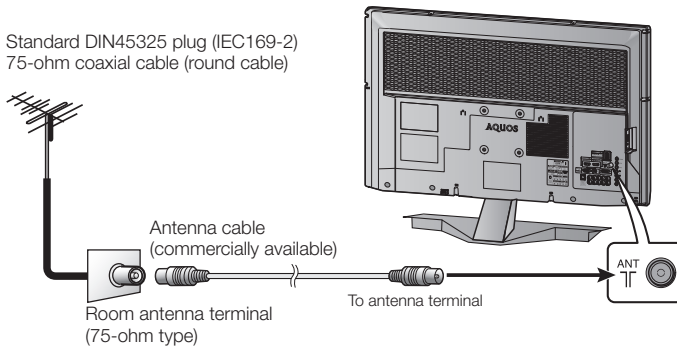

CAUTION

- **TO PREVENT RISK OF ELECTRIC SHOCK, DO NOT TOUCH UN-INSULATED PARTS OF ANY CABLES WITH THE AC CORD CONNECTED.**

NOTE

- Place the TV close to the AC outlet, and keep the power plug within reach.
- The illustration used throughout this manual are based on LC-32LE155X.

Connecting external devices

You can connect many types of external equipment to your TV, like a VCR, game console, camcorder, DVD player, Digital TV STB (Set Top Box) and PC. To view external source images, select the input source from **INPUT** on the remote control unit or **INPUT** on the TV.

CAUTION

- To protect all equipment, always turn off the TV before connecting to a VCR, game console, camcorder, DVD player, Digital TV STB (Set Top Box), PC or other external equipment.
- Refer to the relevant operation manual (VCR, DVD player, etc.) carefully before making connections.

Connecting external devices (Continued)

Connecting a VCR, game console or camcorder

A VCR, game console, camcorder and some other audiovisual equipment can be conveniently connected using the INPUT 4 or INPUT 5 terminals.

When using component cable (commercially available)

When using composite cable (commercially available)

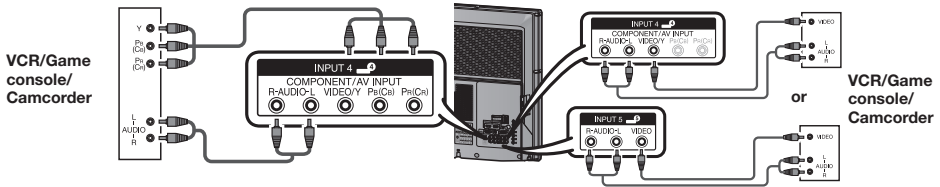

Connecting a DVD player/Digital TV STB (Set Top Box)

You can use the INPUT 1 (HDMI/ARC)/INPUT 2 (HDMI)/INPUT 3 (HDMI/MHL) or INPUT 4 terminals when connecting to a DVD player/Digital TV STB (Set Top Box) and other audiovisual equipment.

When using HDMI-certified cable (commercially available)

When using component cable (commercially available)

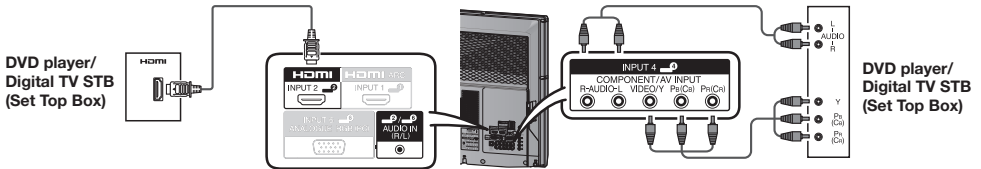

Connecting a PC

You can use the INPUT 6 PC terminals when connecting to a PC of ANALOGUE RGB terminal.

You can use the INPUT 2 (HDMI) terminal when connecting to a PC of DIGITAL DVI terminal.

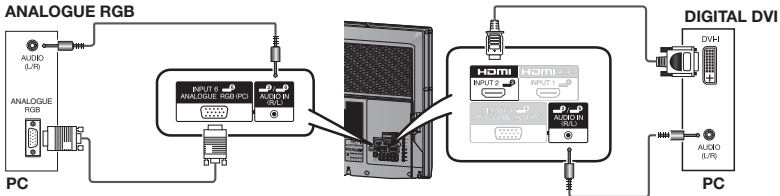

Connecting a USB device

Connect a USB device to the TV.

Using Digital Audio Output

It is possible to output audio through the DIGITAL AUDIO OUTPUT terminal. PCM audio outputs from the terminal.

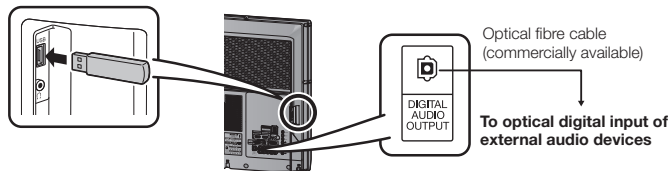

CAUTION

- Do not disconnect a USB device from the TV while transferring files, when a screen is in "USB" mode.

NOTE

- The DIGITAL AUDIO OUTPUT terminal usually outputs the same audio from the speakers. (The audio of the content you are viewing is output from the terminal.)
- The DIGITAL AUDIO OUTPUT terminal does not output some signals, depending on devices and software.

The illustration used throughout this manual are based on LC-32LE155X.

Remote control unit

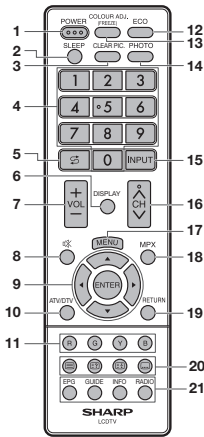

1 POWER (STANDBY/ON)

To switch the power on and off. (See page 7.)

2 SLEEP

Set the Sleep timer.

0 hr. 30 min. → 1 hr. 00 min. → 1 hr. 30 min.
 Off ← 2 hr. 30 min. ← 2 hr. 00 min.

3 CLEAR PIC.

Change the Clear picture processing mode. (See page 10.)

4 0-9

Set the channel.

TELETEXT mode: Set the page. (See page 21.)

5 Flashback

Press to return to the previous selected channel or external input mode.

6 DISPLAY

Display the channel or input information.

7 VOL + /VOL -

Set the volume.

(VOL +) Increase the volume.
 (VOL -) Decrease the volume.

8 Mute

Press → Mutes sound.

Press again → Restores sound.

Mute will be cancelled after 30 minutes. However, the TV will not suddenly output loud sound as the volume level will be set to 0 automatically. Increase the volume level by pressing VOL +.

9 ▲/▼/◀/▶ (Cursor)

Select a desired item on the setting screen.

ENTER

Execute a command.

10 ATV/DTV

Press to access analogue and digital TV mode. (See page 17.)

11 Colour (Red/Green/Yellow/Blue)

The coloured buttons are correspondingly used to select the coloured items on the screen.

TELETEXT mode: Select a page. (See page 21.)

12 ECO

Reduce overall power consumption based on user preferences. (See page 20.)

13 COLOUR ADJ. (FREEZE)

Freeze a motion picture on the screen and adjust the colour tone of the still image. (See page 20.)

14 PHOTO

Display your pictures directly on the TV screen. (See page 24.)

15 INPUT (INPUT SOURCE)

Select an input source.

16 CH ^ /CH v

TV input mode: Select the channel.

(CH ^) Increase the channel number.

(CH v) Decrease the channel number.

TELETEXT mode: Select a page. (See page 21.)

17 MENU

Display the menu screen.

18 MPX

Select the sound multiplex mode.

19 RETURN

MENU mode: Return to the previous menu screen.

20 (TELETEXT), (Reveal hidden for TELETEXT),

(Hold), (SUBTITLE for TELETEXT)

Use for TELETEXT mode. (See page 21.)

21 EPG

DTV mode: To display EPG (Electronic Programme Guide) screen. (See pages 19 to 20.)

GUIDE

DTV mode: Display the programme channel list. (See page 16.)

INFO

DTV mode: Display the programme information. (See page 16.)

RADIO

Press to access RADIO mode. (See page 17.)

Inserting the batteries

Before using the TV for the first time, insert two "AAA" size batteries (supplied). When the batteries become depleted and the remote control fails to operate, replace the batteries with new "AAA" size batteries.

1 Open the battery cover.

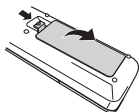

2 Insert the two supplied "AAA" size batteries.

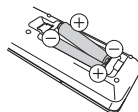

3 Close the battery cover.

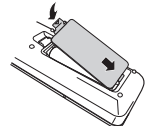

- Place batteries with their terminals corresponding to the (+) and (-) indications in the battery compartment.

CAUTION

- Batteries (battery pack or batteries installed) shall not be exposed to excessive heat such as sunshine, fire or the like.

Part names

TV (Front)

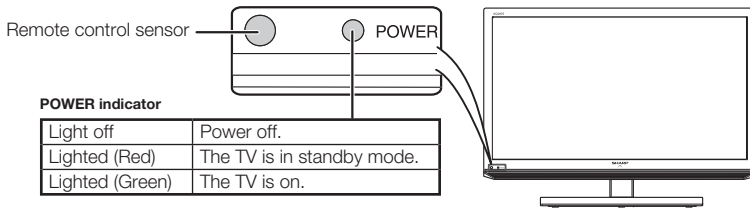

TV (Rear)

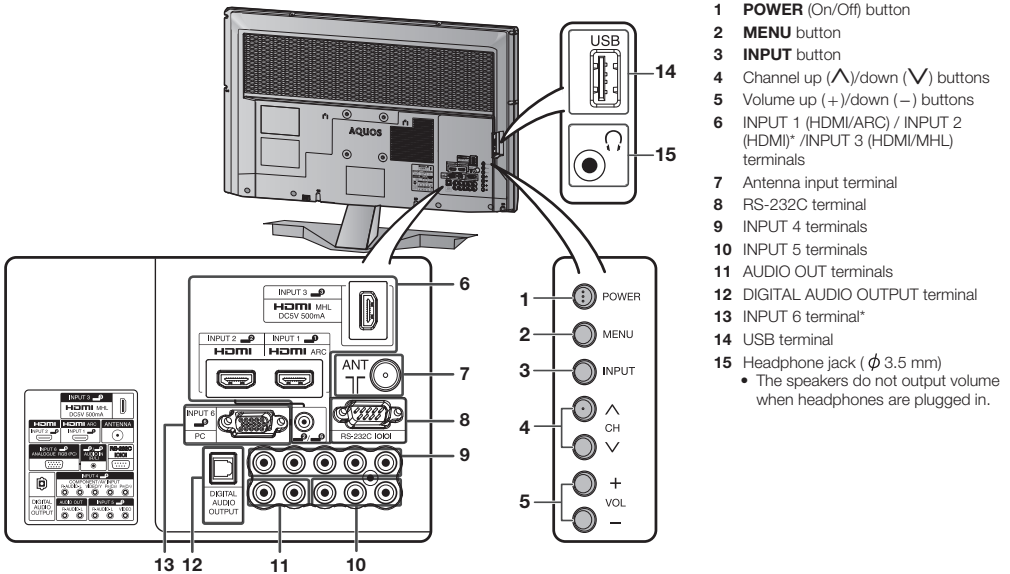

* The INPUT 2 and INPUT 6 terminals can both use the same analogue audio input terminal. However, the proper item must be selected in the "Audio select" menu. (See page 14.)

- The illustrations in this operation manual are for explanation purposes and may vary slightly from the actual operations.
- The illustration used throughout this manual are based on LC-32LE155X.

Turning the TV on/off

Turning on/off the power

- **To turn on the power**
Press **POWER** on the TV. (After a few seconds, an image appears with sound.)
- **To turn off the power**
Switch it off by pressing **POWER** on the TV.

NOTE

- If you are not going to use this TV for a long period of time, be sure to remove the AC cord from the AC outlet.
- Minor power is consumed when the unit is in standby mode.

Standby mode

- **To standby mode**
If the TV is switched on, you can switch it to standby by pressing **POWER** on the remote control.
- **Switching on from standby**
From standby, press **POWER** on the remote control.

Initial auto installation

When the TV powers on for the first time after purchase, the initial auto installation wizard appears. Follow the menu and make the necessary settings one after another.

- 1 Press **POWER** on the TV.
 - The initial auto installation wizard appears.
- 2 Press **▲/▼** to select your country channels listed on the screen, and then press **ENTER**.
Press **▲/▼** to select "HOME" or "STORE", and then press **ENTER**.
HOME:
 - "STANDARD" will be the default value for the "AV mode" setting.**STORE:**
 - "DYNAMIC (FIXED)" will be the default value for the "AV mode" setting. If the "AV mode" is changed, the TV will automatically switch back to "DYNAMIC (FIXED)" when there is no further change to TV setting for 30 minutes.
 - The confirmation screen appears only when selecting "STORE".
Press **▲/▼** to select "Yes" or "No".
 - To change the STORE mode to HOME mode, please refer to page 13 to reset the unit.Press **▲/▼** to select "DTV", "ATV" or "DTV + ATV", and then press **ENTER**.
 - Auto installation will be executed.
 - You do not need to do anything during the auto search.

Checking Signal information

If you install a DVB-T antenna for the first time or relocate it, you should adjust the alignment of the antenna to receive a good reception while checking the antenna setup screen.

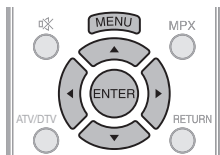

- 1 Press **MENU** and the MENU screen displays.
- 2 Press **◀/▶** to select "Programme setup".
- 3 Press **▲/▼** to select "Digital setting", and then press **ENTER**.
- 4 Press **▲/▼** to select "Signal Information", and then press **ENTER**.
 - The "Signal Information" screen will appear.

Auto installation

You can run auto installation again, even after setting up the preset channels.

- 1 Press **MENU** and the MENU screen displays.
- 2 Press **◀/▶** to select "Programme setup".
- 3 Press **▲/▼** to select "Auto installation", and then press **ENTER**.
If you have already set the password, enter it here.
 - See page 12 for setting a password.
- 4 Press **▲/▼** to select your country channels listed on the screen, and then press **ENTER**.
Press **▲/▼** to select "DTV", "ATV" or "DTV + ATV", and then press **ENTER**.
You do not need to do anything during the auto search. Press **MENU** to exit.

Programme setup

Digital setting

You can reconfigure DTV services settings automatically or manually.

- 1 Press **MENU** and the MENU screen displays.
- 2 Press **◀/▶** to select "Programme setup".
- 3 Press **▲/▼** to select "Digital setting", and then press **ENTER**. If you have already set the password, enter it here.
 - See page 12 for setting a password.
- 4 Press **▲/▼** to select the desired menu item, and then press **ENTER**.

Auto search

Use this menu to add new services automatically after auto installation has been completed.

Manual search

Add new services within a specified frequency band.

- Press **◀/▶** to select the frequency and then press **ENTER**.

Programme setup (Continued)

Analogue setting

You can reconfigure the TV channel settings automatically or manually using **Auto search**, **Manual adjust** or **Programme edit**.

■ Auto search

You can also automatically search by performing the procedure below. This is the same function as programme auto search in auto installation.

- 1 Press **MENU** and the MENU screen displays.
- 2 Press **◀/▶** to select “” (Programme setup).
- 3 Press **▲/▼** to select “Analogue setting”, and then press **ENTER**. If you have already set the password, enter it here.
 - See page 12 for setting a password.
- 4 Press **▲/▼** to select “Auto search”, and then press **ENTER**.
You do not need to do anything during the auto search. Press **MENU** to exit.

■ Manual adjust

You can set some channel items manually.

- 1 Repeat steps 1 to 3 in **Auto search**.
- 2 Press **▲/▼** to select “Manual adjust”, and then press **ENTER**.
- 3 Press **▲/▼** to select your desired item, and then press **◀/▶** to adjust the settings.

Item	Description
Storage to [1~99]	Save programme to your desired channel number. Press R to save.
Sound system	Select the optimum sound system (Broadcasting system) to receive. (B/G, D/K, I, M)
Colour system	Select the optimum colour system to receive. (PAL, SECAM, NTSC)
Current CH	Select the channel you want to edit. • Selected channel will be automatically reflected in the background.
Search	Start searching from current channel. • Instead of pressing ◀/▶ to adjust the frequency, you can set by directly entering the frequency number of the channel with 0 - 9 . Press R to save.
Fine-tune	Tune the frequency of the stored channel to your desired position. • Adjust while checking the background picture as a reference. Press R to save.

NOTE

- The frequency shown below the On-Screen Display shows the real-time frequency of the displayed channel.

■ Programme edit

Use this menu to set up a channel individually.

- 1 Repeat steps 1 to 3 in **Auto search**.
- 2 Press **▲/▼** to select “Programme edit”, and then press **ENTER**.
- 3 Press **▲/▼** to select the channel you want to edit, and then press **1 to 5** on the remote control if necessary or press **RETURN** to exit.
 - As you toggle down the channels, each channel is immediately reflected in the background when you press **ENTER**.

① (Erase programme)

Channels can be erased individually.
Press **1** to erase the selected channel.

② (Label)

You can change channel names individually.
Maximum 5 alphanumeric can be input.
Press **2** to start labelling.

Press **▲/▼/◀/▶** to select a character, and then press **2** again or **ENTER** to save.

③ (Sort)

Channel positions can be sorted freely.
Press **3** to select the channel you want to move.
Press **▲/▼** to move it to the desired position, and then press **3** again or **ENTER** to save.

④ (Skip)

Channels with “Skip” set to “On” are passed over when using **CH▲/▼** even if selected while watching the image from the TV.

Press **4** to skip the selected channel.
Press **4** again to cancel the skip.

⑤ (Lock)

You can block the viewing of any selected channel.
Password must be set first to allow “” to function.
• See page 12 for setting a password.
Press **5** to lock the selected channel.
Press **5** again to unlock the locked channel.

Selecting a preset AV mode

"AV mode" gives you several viewing options to choose from to best match the system environment, which can vary due to factors like room-brightness, type of programme watched or the type of image input from external equipment.

- 1 Press **MENU** and the MENU screen displays.
- 2 Press **◀/▶** to select "🖼️" (Picture) and "🔊" (Audio).
- 3 Press **▲/▼** to select "AV mode", and then press **ENTER**.

Selected item	Description
STANDARD	For a highly defined image in a normally bright room.
MOVIE	For a movie.
PC	For PC (Available only when inputting an HDMI or PC signal).
DYNAMIC	For a clear-cut image emphasising high contrast for sports viewing.
DYNAMIC (FIXED)	Changes the image and sound settings to the factory preset values. No adjustments are allowed.

NOTE

- You can select a different AV mode item for each input mode. (For example, select STANDARD for TV input and DYNAMIC for VIDEO input.)

Menu operation

- 1 Press **MENU** and the MENU screen displays.
- 2 Press **◀/▶** to select the desired menu. (Programme setup, Picture, Audio, ECO, Setup, Option)
- 3 Press **▲/▼** to select the desired menu item. Press **ENTER** to proceed if necessary.
- 4 Press **▲/▼** or **◀/▶** to select the desired item or adjust the item to the desired level. Press **ENTER** if necessary.



Picture menu

Picture adjust

Clear picture processing

Processes noise included in broadcast signals to improve picture quality.

Selected item	Description
High	Improves picture quality through Clear picture processing at a level above "Middle".
Middle	↑ ↓
Off	Turn Off the function for improving picture quality through Clear picture processing.

NOTE

- You can also select an item by pressing **CLEAR PIC.** on the remote control unit.
- This Clear picture processing effect may not have suitable effect on certain pictures. In that case, please change the setting to "Middle" or "Off".

Adjustment items

Selected item	◀ button	▶ button
Backlight	The screen dims	The screen brightens
Contrast	For less contrast	For more contrast
Brightness	For less brightness	For more brightness
Colour	For less colour intensity	For more colour intensity
Tint	Skin tones become reddish	Skin tones become greenish
Sharpness	For less sharpness	For more sharpness

NOTE

- "Picture adjust" cannot be changed during "DYNAMIC (FIXED)" mode.

DNR (Digital Noise Reduction)

Reduces noise on screen and produces a clearer video image. (Auto, High, Low, Off)

Picture menu (Continued)

■ Wide mode

You can manually select the size of a picture appeared on your screen.

Selectable picture size varies with the type of signal received.

Press ▲/▼ while the wide mode menu displays on the screen.

- As you toggle down the options, each mode is immediately reflected on the TV.

Selected item	Description
Normal/4:3	For 4:3 "standard" pictures. A side bar appears on each side.
Zoom 14:9	For 14:9 letterbox pictures. A thin side bar appears on each side, and you may also see bars on the top and bottom with some programmes.
Panorama	In this mode the picture is progressively stretched toward each side of the screen.
Full/16:9	For 16:9 squeeze pictures.
Cinema 16:9	For 16:9 letterbox pictures. Bars may appear on the top and bottom with some programmes.
Cinema 14:9	For 14:9 letterbox pictures. Bars may appear on the top and bottom with some programmes.
Dot by Dot	Displays an image with the same number of pixels on the screen (only when receiving a 1080i/1080p signal for LC-39LE155X).
Just scan	Keeps the original aspect ratio and enlarges the picture as much as possible.
Auto	Keeps the original aspect ratio based on source information and enlarge the picture as much as possible.
Underscan	Display with an Underscan image only when receiving a 720p/1080p/1080i signal (only for LC-32LE155X)/a 720p signal (only for LC-39LE155X). Display with the High-Definition image adjusted optimally. Noise may appear on the edge of the screen with some programmes.

NOTE

- Some picture sizes may not be displayable depending on the input signal.
- "Auto", "16:9", "4:3" and "Just scan" can be selected only during video playback in "Movie mode" of USB Media Player.
- For resetting all "Picture adjust" items to factory preset values, press ▲/▼ to select "Reset", press **ENTER**, press ▲/▼ to select "Yes", and then press **ENTER**.

Audio menu

■ Sound adjust

Selected item	◀ button	▶ button
Treble	For weaker treble	For stronger treble
Bass	For weaker bass	For stronger bass
Balance	Decrease audio from the right speaker	Decrease audio from the left speaker

■ SRS TruSurround (TS) HD™

You can enjoy SRS TruSurround HD™ sound, the same as you were in movie theatre.

Using SRS TS HD on the menu screen

You can produce SRS TruSurround HD™ effects from the "Audio" setting.

Selected item	Description
On	SRS TruSurround HD™ creates a high quality surround sound experience, when watching DVD movies and TV programmes broadcast in surround sound.
Off	Outputs the normal sound.

■ Bass enhancer powered by SRS Labs, Inc.

This function allows you to enjoy bass-enhanced sound.

Selected item	Description
On	Bass enhancer function is on.
Off	Outputs the normal sound.

■ Clear voice

This function emphasises speech against background noise for greater clarity. (On, Off)

NOTE

- Clear voice only work when SRS TS HD is "On".
- For resetting all "Sound adjust" items to the factory preset values, press ▲/▼ to select "Reset", press **ENTER**, press ▲/▼ to select "Yes", and then press **ENTER**.

ECO menu

■ No signal off

You can set the TV to automatically power off in about 15 minutes after the TV goes into a state of receiving no programme signals. (Enable, Disable)

- Five minutes before the power shuts down, the remaining time displays every minute.

NOTE

- When a TV programme finishes, and the TV receives signal input, this function may not operate.

■ No operation off

You can set the TV to automatically power off when no TV operation is performed for more than 3 hours.

(30 min., 3 hr., Disable)

- Five minutes before the power shuts down, the remaining time displays every minute.

Setup menu

Child lock (ATV and DTV input mode only)

Allows you to use a password to protect certain settings from being accidentally changed.

Setting a password

- Repeat steps 1 and 2 in **Menu operation**.
- Press ▲/▼ to select "Child lock", and then press **ENTER**.
- If you have already set the password, enter it here.
- Press ▲/▼ to select "Change password", and then press **ENTER**.
- Enter the 4-digit number as a password using **0 – 9**.
- Enter the same 4-digit number as in step 5 to confirm.

NOTE

- To view a locked channel, you must enter a password. When you select a locked channel, "Child lock has been activated" is displayed.
- Press **ENTER** to display the password input window.

Clearing the password

Allows you to clear your password.

- Repeat steps 1 to 3 in **Setting a password**.
- Press ▲/▼ to select "Clear password", and then press **ENTER**.
- Press ◀/▶ to select "Yes", and then press **ENTER**.

Parental rating

This function allows TV channels to be restricted. It prevents children from watching violent or sexual scenes that may be considered inappropriate.

- Repeat steps 1 to 3 in **Setting a password**.
- Press ▲/▼ to select "Parental rating", and then press **ENTER**.
- Press ▲/▼ to select your desired rating, and then press **ENTER**.

When the country setting is set to "Australia".

Selected item	Description
NO BLOCK (-)	Cancel the blocking.
General and above (G)	Content is not offensive to most viewers.
Parental guidance and above (PG)	Content is such that parents may not want their children to view the programme.
Mature and above (M)	Mature audience only. This programme is specifically designed to be viewed by adults and therefore may be unsuitable for children under 15.
Mature adult and above (MA)	Mature adult only. This programme is specifically designed to be viewed by adults and therefore may be unsuitable for children under 15.
Adult Violence and above (AV)	Not for children under age 15. Strong elements of sex and/or violence.

Selected item	Description
Restricted and above (R)	Not for children under age 18. Strong elements of sex and/or violence.
BLOCK ALL	Block all programmes.

When the country setting is set to "New Zealand".

Selected item	Description
NO BLOCK	Cancel the blocking.
General and above (G)	Content is not offensive to most viewers.
Parental guidance recommended and above (PGR)	Programme is suited to more mature viewers.
Adults only and above (AO)	Adults only. This programme contains material of an adult nature handled in such a way that is unsuitable for children.
BLOCK ALL	Block all programmes.

HDMI auto view (HDMI input mode only)

Selected item	Description
Enable/Disable	Set whether or not to use the Auto Selection of WIDE MODE based on signal recognition received from the HDMI signal.

Link operation

Using the HDMI CEC (Consumer Electronics Control) protocol, with Link operation you can interactively operate compatible system equipment (e.g. DVD), by connecting the link operation-compatible devices with HDMI-certified cables to the TV.

Link operation allows you to operate the HDMI-connected equipment and the TV by using a single remote control unit. (On, Off)

Audio return channel

If this function is set to "Auto", the TV can send audio data for video content shown on the TV to a connected audio device with just one ARC-compatible cable. Using this function eliminates the need to use a separate digital or analogue audio cable. (Auto, Off)

Connection for using "Audio return channel"

You need to use ARC-compatible cables/devices and connect to the INPUT 1 terminal to activate this function.

NOTE

- The ARC (Audio Return Channel) function works only when using the INPUT 1 terminal.
- When you use an audio system compatible with the ARC function of the TV, you do not need to connect an optical audio cable to the TV.

Auto wide (DTV input mode only)

The "Auto wide" allows the TV to switch automatically among the different picture size. (On, Off)

NOTE

- Use "Wide mode" if an image does not switch to the appropriate picture size. When the broadcast signal contains no aspect ratio information, the function will not work even if enabled.

Setup menu (Continued)

Quick start

You can reduce the TV's start-up time after turning on the power with the remote control unit.

Selected item	Description
On	The TV quickly starts up from standby, more of power consumption is required during standby.
Off	Power consumption is less than 1W.

Text language

Select from among 5 kinds of language: West Europe, East Europe, Cyrillic, Arabic and Farsi.

NOTE

- Teletext can display only when it is sent by a network. Not used to convert between languages.

Digital setup

Selecting the language

Set up to two preferred multi audio languages to display if the audio languages are available.

- Press **MENU** and the MENU screen displays.
- Press **◀/▶** to select "⚙️" (Setup).
- Press **▲/▼** to select "Digital setup", and then press **ENTER**.
- Press **▲/▼** to select "Digital audio language", and then press **ENTER**.
- Press **▲/▼** to select "1st language" or "2nd language".
- Press **◀/▶** to select the desired language.

NOTE

- If audio for the selected languages is not included in a received broadcast, audio will not be output for that language.

Displaying subtitles for the hearing impaired

You can display subtitles for the hearing impaired in the Teletext broadcast if the subtitle languages are available.

- Press **MENU** and the MENU screen displays.
- Press **◀/▶** to select "⚙️" (Setup).
- Press **▲/▼** to select "Digital setup", and then press **ENTER**.
- Press **▲/▼** to select "Subtitle", and then press **ENTER**.
- Press **▲/▼** to select "1st language" or "2nd language".
- Press **◀/▶** to select the desired language.

NOTE

- If subtitles for the selected language are not included in a received broadcast, subtitles will not be shown for that language.

Switching subtitle languages (DVB Subtitle)

Each time you press  on the remote control, the subtitle switches when the broadcast contains subtitle information.

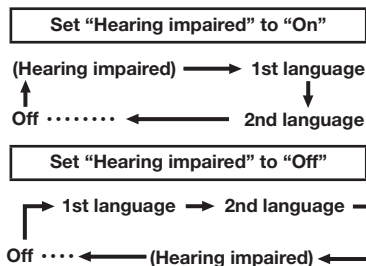

NOTE

- This function is valid only if broadcaster is transmitting multilingual subtitles.

Time zone

This function enables you to select your local time zone.

- Press **MENU** and the MENU screen displays.
- Press **◀/▶** to select "⚙️" (Setup).
- Press **▲/▼** to select "Digital setup", and then press **ENTER**.
- Press **▲/▼** to select "Time zone", and then press **ENTER**.
- Press **◀/▶** to select the desired time zone.

NOTE

- This function lets you select the right time zone in case the time displayed in the EPG does not match the local time of your area.

Identification

You can check the current version of the software on the screen.

Reset

If complex adjustments are made and the settings cannot be restored to normal, you can reset the settings to the factory preset values.

NOTE

- If you execute "Reset", all the settings such as "Picture", "Audio" and "Programme setup" will be reset to the factory preset values.

Option menu

Output volume select

Allows you to select what controls the audio output.

Selected item	Description
Fixed	<ul style="list-style-type: none"> Sound via speakers is adjusted with VOL + / - on the remote control unit or the TV. Sound via the AUDIO OUT terminal is not adjustable and constantly outputs.
Variable	<ul style="list-style-type: none"> Sound via the AUDIO OUT terminal is adjusted with VOL + / - on the remote control unit or the TV. Sound via speakers is muted.

NOTE

- When "Output volume select" is set to "Variable", all Audio menu item cannot be adjusted.

Input select

For setting the signal type of external equipment.

Input source	Selectable item
INPUT4	Component, Video

Audio select (HDMI input mode only)

You must select HDMI+Analogue if uses the AUDIO IN (R/L) jack for analogue audio input when using INPUT 2 (HDMI) terminal.

Option	Description
HDMI (Digital)	Select "HDMI (Digital)" if the Devices (DVD, Blu ray Player, Set Top Box or etc.) is connected using HDMI cable to INPUT 2 (HDMI) terminal.
HDMI+ Analogue	Select "HDMI+Analogue" if the Devices (PC or etc.) is connected using DVI/HDMI convert cable to INPUT 2 (HDMI) terminal and AUDIO IN (R/L) jack is used to input Analogue Audio Signals.

HDMI (Digital)

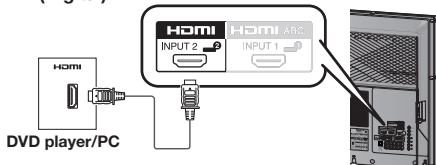

HDMI+Analogue

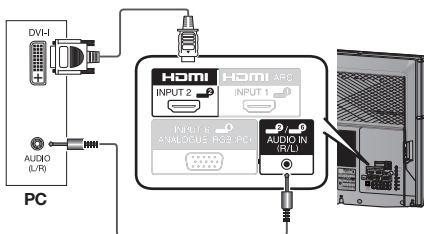

Auto volume

Different sound sources, fairly often do not have the same volume level, for example the changing from movie to the advertisements. Auto volume solves this problem and equalises the volume levels. (On, Off)

Digital audio output

This function allows you to select your favourite audio output system. (PCM, Auto, Off)

Speaker selection

You can choose to listen to the external amplifier audio only. (On, Off)

NOTE

- This function only available when "Link operation" is set to "On".
- You need to use CEC compatible amplifier to control external speaker volume.

Audio only

When listening to music from a music programme, you can set the display off and enjoy audio only.

Selected item	Description
On	Audio is output without screen image.
Off	Both screen images and audio are output.

NOTE

- When you make operations that change the picture on the TV such as by changing the input source, the "Audio only" function is set to "Off".

Colour system

You can change the colour system to one that is compatible with the image on the screen. (Auto, PAL, SECAM, NTSC 3.58, NTSC 4.43, PAL-60)

NOTE

- If "Auto" is selected, colour system for each channel is automatically set. If an image does not display clearly, select another colour system (e.g. PAL, NTSC 4.43).
- "Colour system" is selectable only when inputting a composite signal.

Fine sync. (PC input mode only)

Input signal

- Some input signals may have to be registered manually to display properly.
- The pairs of input signals (resolutions) in the list below are not distinguishable when received. In such case, you have to set the correct signal manually. After setting once, it will display when the same signal (resolution) is input again.

1280 × 768	1360 × 768
------------	------------

Option menu (Continued)

Adjusting the PC image automatically

Auto sync.

This function enables the screen to be automatically adjusted to its best possible condition when the analogue terminals of the TV and PC are connected with a commercially available RGB cable, etc.

NOTE

- Auto sync. is likely to succeed when an input PC image has wide vertical stripes (e.g. pattern with high contrast stripes, or cross-hatched). It may fail when an input PC image is solid (low contrast).

Adjusting the PC image manually

Ordinarily you can easily adjust the picture as necessary to change image position using Auto sync. In some cases, however, manual adjustment is needed to optimise the image.

Selected item	Description
H-Position	Centres the image by moving it to the left or right.
V-Position	Centres the image by moving it up or down.
Clock	Adjusts when the image flickers with vertical stripes.
Phase	Adjusts when characters have low contrast or when the image flickers.

NOTE

- For resetting all "Fine sync." items to the factory preset values, press ▲/▼ to select "Reset", press **ENTER**, press ▲/▼ to select "Yes", and then press **ENTER**.
- Images may not be displayed properly depending on the settings and/or input signals.

■ DivX (R) VOD

Please see USB Media Player on page 26.

■ Demo (store mode only)

When "Store mode" is set to "On", after all the settings are completed, the Feature demo screen is displayed if there is no operation for 30 seconds. If you want to have clear picture demo, you must select "Clear picture processing" in the Demo screen.

■ System data

USB data transfer

This function allows you to update the TV to the latest software using a USB device. You must update the software through the USB terminal.

Software update (OAD)

- This function is for automatically download the data for the version update software over digital broadcasts when the "OAD setup" is set to "On".
- To download, follow the instructions when the download message appears during a digital broadcast.

OAD scan

- This function is for manually download the data for the version update software over digital broadcasts.

CAUTION

- **Do not disconnect the AC cord when the software upgrade is in progress, as this may cause the upgrade to fail. If problem arises ask a qualified service personnel before the software upgrade period expires.**

Programme Guide

You can check the current channel list of DTV/ATV respectively.

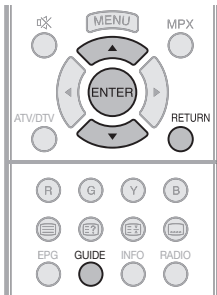

- 1 Press **GUIDE** to display the programme channel list.
- 2 Press **▲/▼** to select your desired programme, and then press **ENTER**.
- 3 Press **RETURN** or **GUIDE** to exit.

Info

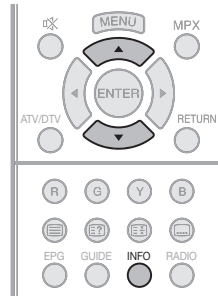

While watching DTV you can check the extended programme information on the screen using **INFO** on the remote control.

General INFO screen

- Station name
- Title
- Date
- Time for the current programme
- Video system
- Audio system
- Parental rating

NOTE

- If there is more information, pressing **▲/▼** allows you to go to the next page or return to the previous page.
- You can cancel this info by pressing **INFO**.

ATV/DTV/RADIO buttons

Use the following buttons on the remote control to operate the menu.

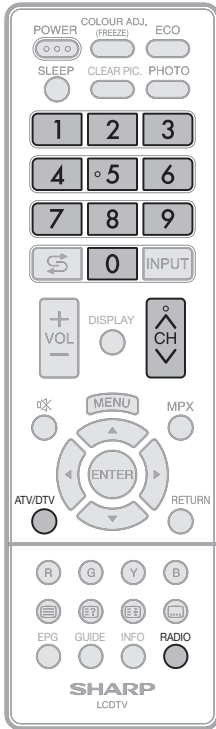

ATV (Analogue TV)

You can run the auto installation to set channels automatically.

- 1 To watch the analogue TV, select "ATV" from "Auto installation" in Programme setup menu. (See page 8.)
- 2 After setting the channels, you can select a channel using **CH** \wedge / \vee or **0-9** on the remote control unit. (See page 6.)

DTV (Digital TV)

When the TV accesses to DTV mode for the first time, you need to run the auto search. To scan all available services in your area, follow the procedures below.

- 1 To watch the DTV broadcasts, select "DTV" from "Auto installation" in Programmme setup menu. (See page 8.)
- 2 After setting the channels, you can select a channel using **CH** \wedge / \vee or **0-9** on the remote control unit. (See page 6.)

ATV/DTV: Press to switch between ATV and DTV mode. After switching from ATV or DTV, radio or external input mode to ATV and DTV mode, the TV jumps to the most recently viewed ATV and DTV channel.

RADIO: Press to switch from DTV to radio mode. The TV will jumps to the most recently tuned radio channel.

When you watch the TV for the first time

When the TV powers on for the first time after purchase, perform the auto installation.

Switching the analogue audio format

You can switch between multiple audio modes when watching a multiple audio or stereo broadcast programme.

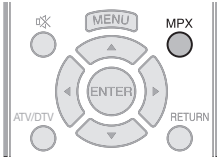

In the NICAM TV broadcasts When receiving a stereo signal

Each time you press **MPX**, the mode switches between NICAM STEREO and MONO.

Stereo mode



When receiving a bilingual signal

Each time you press **MPX**, the mode switches among NICAM CH A, NICAM CH B, NICAM CH AB and MONO.

Bilingual mode

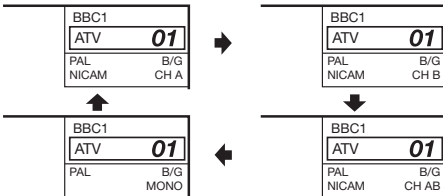

When receiving a monaural signal

Each time you press **MPX**, the mode switches between NICAM MONO and MONO.

Monaural mode

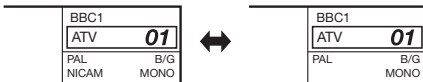

In the TV mode of A2 TV broadcasts

When receiving a stereo signal

Each time you press **MPX**, the mode switches between STEREO and MONO.

Stereo mode



When receiving a bilingual signal

Each time you press **MPX**, the mode switches among CH A, CH B and CH AB.

Bilingual mode

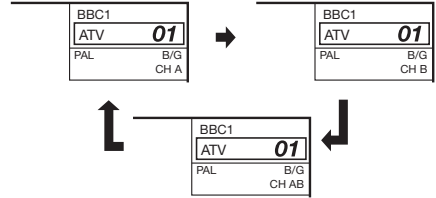

When receiving a monaural signal

When you press **MPX**, "MONO" displays.

Monaural mode

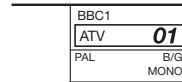

NOTE

- "BBC1", "01" and "PAL" are tentative network name, channel and colour system.

What is an EPG?

An "EPG (Electronic Programme Guide)" is a programme schedule, which is displayed on the TV screen. The EPG is broadcasted together with DTV. The TV screen shows the EPG when the viewer presses **EPG** on the remote control, provided that the TV is receiving the digital broadcasting signal. The EPG enables you to search for a programme, do timer view the programme schedule in detail.

Basic Operation

■ Display the EPG screen

- 1 Press **EPG**.

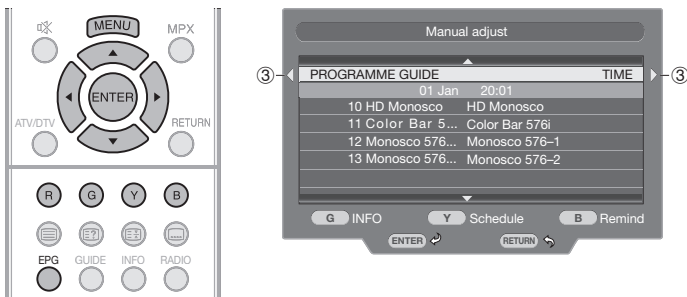

- 2 Press **▲** to select PROGRAMME GUIDE/TIME.
- 3 Press **◀/▶** to select the desired channel/time span.

■ Close the EPG screen

- 4 Press **EPG** again or **RETURN** to exit.

NOTE

- For "New Zealand delivery model", the EPG screen and operation differ due to the use of MHEG EPG. The EPG screen and operation vary depending on the broadcasts.

Reminder timer setting

You can schedule a reminder for future programmes. Channel will automatically change on time as scheduled.

- 1 Press **EPG**.
- 2 Press **▲/▼** to select the programme you want to watch.
- 3 Press **B** to set reminder time.
- 4 Press **ENTER** to save reminder timer.
 - "Timer Save Success" will display.

NOTE

- "Timer Overlap" will display if same time is set twice.
 - "Timer Past" will display if past time is set.
- 5 Press **ENTER** to display the reminder schedule list.
 - 6 Press **RETURN** or **EPG** to exit.

EPG (Continued)

Viewing the reminder schedule list

- 1 Press **EPG**.
- 2 Press **Y** to display the reminder schedule list.
- 3 Press **▲/▼** to display next or previous screen.
- 4 Press **RETURN** or **EPG** to exit.

Cancelling the reminder timer setting

- 1 Press **EPG**.
- 2 Press **Y** to display the reminder schedule list.
- 3 Press **▲/▼** to select a programme you want to cancel.
- 4 Press **R** to delete a programme from reminder list.
- 5 Press **RETURN** or **EPG** to exit.

Colour adjustment and still image

Allows you to adjust the colour tone of a still image.

- 1 Press **COLOUR ADJ. (FREEZE)**, the moving image will be captured and colour adjustment screen displays.
- 2 Press **▲/▼/◀/▶** to adjust the colour to your desired setting.

Button	Description
▲	White with greenish tone.
▼	White with reddish tone.
◀	White with bluish tone.
▶	White with yellowish tone.
R	Reveal/hide the setting screen.
G	Set adjustment to last user setting.
B	Close the setting screen and unfreeze image.
ENTER	Save/exit setting.

NOTE

- The colour adjustment screen and still image will automatically goes out after 30 minutes.
- Freeze/Colour adjustment function does not work in USB Photo/Movie playback. It works for HDMI, composite/component and VGA.

ECO mode

This function enables you to reduce the backlight brightness in order to decrease the power consumption and increase the backlight life span as shown in the following table.

Selected item	Description
ECO 1	Reduces the backlight brightness.
ECO 2	Reduces the backlight brightness more than "ECO 1".
ECO Off	Normal setting of backlight brightness.

ECO status will be displayed on the channel information window.

Using a Smartphone with the TV

This function enables you to connect the TV to a smartphone that supports Mobile High-Definition Link (MHL) using an MHL-compatible cable.

To connect the TV to your MHL-compatible smartphone, be sure to use an MHL-compatible cable (commercially available).

- You can view pictures and video on a large screen.
- You can play back music files.

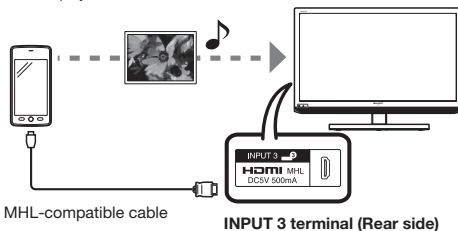

NOTE

- An MHL-compatible portable device is required to use this function. Connect the device to the INPUT 3 terminal.
- This production incorporates MHL I.

Auto power on

When an MHL-compatible device is connected to the TV, the TV turns on automatically.

- This function operates when "Link operation" is set to "On". (See page 12.)

Auto input selection

When an MHL-compatible device is connected while the TV is on, the input mode is selected automatically.

- This function operates when "Link operation" is set to "On". (See page 12.)

Operation using the remote control

The remote control of the TV can be used to operate a portable device.

- **▲/▼/◀/▶**, **ENTER**, **0 - 9**, etc.
- The operations vary depending on the connected equipment and content being viewed.
- **Colour (Red/Green/Yellow/Blue)** may be available to control play/pause/fast forward/back forward function.



• The illustration used throughout this manual are based on LC-32LE155X.

Teletext function

What is Teletext?

Teletext broadcasts pages of information and entertainment to specially equipped television sets. News, weather reports, sports information, stock exchange prices and programme previews are among the many services available.

Turning on and off Teletext





- 1 Select a TV channel or external input source providing the Teletext programme.
- 2 Press  to display the Teletext.
- 3 Each time you press , the screen switches as shown below.



NOTE

- If you select a programme with no Teletext signal, "No Teletext available." is displayed.
- The same message displays during other modes if no Teletext signal is available.
- New Zealand delivery model can receive MHEG data broadcasting.

Button functions

Buttons	Description
CH ( / )	Increase or decrease the page number.
Colour (Red/Green/Yellow/Blue)	You can select a group or block of pages displayed in the coloured brackets at the bottom of the screen by pressing the corresponding Colour (Red/Green/Yellow/Blue) on the remote control unit.
0 - 9	Directly select any page from 100 to 899 by using 0 - 9 .
 (Reveal hidden for TELETEXT)	To reveal hidden information such as an answer to a quiz.
 (Hold)	To stop updating Teletext pages automatically or release the hold mode.
 (Subtitle for TELETEXT)	Display the subtitle during Teletext page. <ul style="list-style-type: none"> • Subtitle will not be displayed when the service does not contain subtitle information.

NOTE

- Teletext can display only when it is sent by a network. Not used to convert between languages.

PC compatibility chart

Resolution		Horizontal Frequency	Vertical Frequency	VESA Standard	Analogue (D-Sub)	Digital (HDMI)
VGA	640 × 480	31.5 kHz	60 Hz	✓	✓	✓
SVGA	800 × 600	37.9 kHz	60 Hz	✓	✓	✓
XGA	1024 × 768	48.4 kHz	60 Hz	✓	✓	✓
WXGA	1360 × 768	47.7 kHz	60 Hz	✓	✓	✓
* 1080P	* 1920 × 1080	67.5 kHz	60 Hz		✓	✓

* : only for LC-39LE155X

DDC is a registered trademark of Video Electronics Standards Association.
 Power Management is a registered trademark of Sun Microsystems, Inc.
 VGA, SVGA, XGA and WXGA are registered trademarks of International Business Machines Corporation.

PC Control of the TV

- When a programme is set, the TV can be controlled from the PC using the RS-232C terminal.
 The input signal (PC/video) can be selected, the volume can be adjusted and various other adjustments and settings can be made, enabling automatic programmed playing.
- Attach an RS-232C cable cross-type (commercially available) to the Din/D-sub RS-232C for the connections.

NOTE

- This operation system should be used by a person who is accustomed to using PCs.

Communication conditions

Set the RS-232C communications settings on the PC to match the communications conditions of the TV. The communications settings of the TV are as follows:

Baud rate:	9,600 bps
Data length:	8 bits
Parity bit:	None
Stop bit:	1 bit
Flow control:	None

Communication procedure

Send the control commands from the PC via the RS-232C connector.

The TV operates according to the received command and sends a response message to the PC.

Do not send multiple commands at the same time. Wait until the PC receives the OK response before sending the next command.

Command format

Eight ASCII codes + CR

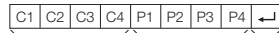

Command 4-digits Parameter 4-digits Return code

Command 4-digits: Command. The text of four characters.

Parameter 4-digits: Parameter 0 – 9, space, ?

Parameter

Input the parameter values, aligning left, and fill with space(s) for the remainder. (Be sure that four values are input for the parameter.)

When the input parameter is not correct, "ERR" returns. (Refer to "Response code format".)

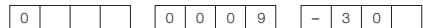

Response code format

Normal response



Return code (ODH)

Problem response (communication error or incorrect command)



Return code (ODH)

RS-232C commands list

Commands

- Commands not indicated here are not guaranteed to operate.

CONTROL ITEM	COMMAND	PARAMETER	CONTROL CONTENTS
POWER SETTING	P O W R 0	_ _ _	POWER OFF (STANDBY)
INPUT SELECTION A	I T G D	_ _ _	INPUT SWITCHING (TOGGLE)
	I T V D	_ _ _	ATV (CHANNEL FIXED)
	I D T V	_ _ _	DTV (CHANNEL FIXED)
	I A V D *	_ _ _	INPUT 1-7 (1-7)
CHANNEL	D C C H *	* _ _	ATV DIRECT CHANNEL (1-99)
	C H U P	_ _ _	ATV CHANNEL UP
	C H D W	_ _ _	ATV CHANNEL DOWN
	D T V D *	* * _	DTV DIRECT CHANNEL (1-999)
	D T U P	_ _ _	DTV CHANNEL UP
	D T D W	_ _ _	DTV CHANNEL DOWN
	AV MODE SELECTION	A V M D 0	_ _ _
A V M D 1		_ _ _	STANDARD
A V M D 2		_ _ _	MOVIE
A V M D 5		_ _ _	DYNAMIC
A V M D 6		_ _ _	DYNAMIC (FIXED)
A V M D 7		_ _ _	PC
VOLUME		V O L M *	* * _
POSITION	H P O S *	* * _	H-POSITION (PC) (000-180)
	V P O S *	* * _	V-POSITION (PC) (000-120)
	C L C K *	* * _	CLOCK (000-180)
	P H S E *	* * _	PHASE (000-015)

CONTROL ITEM	COMMAND	PARAMETER	CONTROL CONTENTS
WIDE MODE	W I D E 0	_ _ _	TOGGLE (AV)
	W I D E 1	_ _ _	NORMAL (AV)/4:3 (USB - MOVIE)
	W I D E 2	_ _ _	ZOOM 14:9 (AV)
	W I D E 3	_ _ _	PANORAMA (AV)
	W I D E 4	_ _ _	FULL (AV)/16:9 (USB - MOVIE)
	W I D E 5	_ _ _	CINEMA 16:9 (AV)
	W I D E 6	_ _ _	CINEMA 14:9 (AV)
	W I D E 7	_ _ _	NORMAL (PC)
	W I D E 9	_ _ _	FULL (PC)
	W I D E 1 0	_ _ _	DOT BY DOT (PC)
	W I D E 1 1	_ _ _	UNDERSCAN
	W I D E 1 2	_ _ _	AUTO (USB - MOVIE)
	W I D E 1 3	_ _ _	JUST SCAN (USB - MOVIE)
MUTE	M U T E 0	_ _ _	TOGGLE
	M U T E 1	_ _ _	MUTE ON
	M U T E 2	_ _ _	MUTE OFF
SRS TS HD	A C S U 0	_ _ _	SRS TS HD TOGGLE
	A C S U 1	_ _ _	SRS TS HD ON
	A C S U 2	_ _ _	SRS TS HD OFF
AUDIO CHANGE	A C H A	_ _ _	TOGGLE
SLEEP TIMER	O F T M 0	_ _ _	OFF
	O F T M 1	_ _ _	SLEEP TIMER 30 MIN
	O F T M 2	_ _ _	SLEEP TIMER 1 HOUR
	O F T M 3	_ _ _	SLEEP TIMER 1 HOUR 30 MIN
	O F T M 4	_ _ _	SLEEP TIMER 2 HOUR
	O F T M 5	_ _ _	SLEEP TIMER 2 HOUR 30 MIN
TEXT	T E X T 0	_ _ _	TEXT OFF
	T E X T 1	_ _ _	TEXT CHANGE TOGGLE

NOTE

- If an underbar (_) appears in the parameter column, enter a space.
- If an asterisk (*) appears, enter a value in the range indicated in brackets under CONTROL CONTENTS.

USB Media Player

Selecting modes

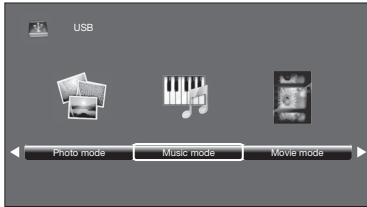

- 1 Press **INPUT** to select the "USB" mode or the TV will automatically switch to the USB mode when a USB device is connected to the TV.
- 2 Press **◀/▶** to select "Photo mode", "Music mode" or "Movie mode", and then press **ENTER**.
- 3 Press **◀/▶** to select your USB directory, and then press **ENTER**.
- 4 Press **▲/▼/◀/▶** to select the desired folder, and then press **ENTER**.

NOTE

- "Wide mode" is fixed during "Photo mode" and "Music mode".
- Depending on the USB device, the TV may not be able to recognise the contained data.
- Use only alphanumeric characters for naming files.
- A file name with more than 10 characters may not be displayed all (depending on the character set).
- Files in USB 1.1 devices may not be played properly.
- Operation using USB hubs is not guaranteed.
- The compatibility of USB HDDs may not be guaranteed.
- Multi drive USB is not supported.

PHOTO slideshow

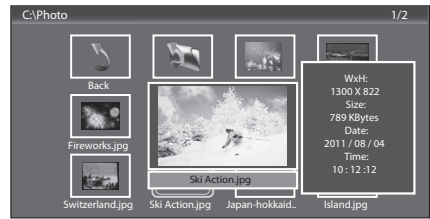

When you press **PHOTO**, the TV screen will automatically play the photo slideshow.

- If there is no USB drive, the TV will switch to **Selecting modes** screen.
- Photo slideshows will autoplay only for the photos located on the top layer of USB drive. To enable autoplay for photos located in a subfolder, you need to manually select the subfolder, and then press **PHOTO**.

You can select the duration for each photo to display, and also the duration for the slideshow to play.

Duration for photos to display

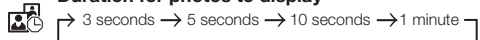

Duration for slideshow to play

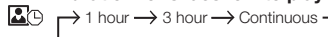

- The TV will automatically power off after the selected playtime ends.























NOTE

- Background music will autoplay during a slideshow only if the music file is located in the same folder with the photo files.
- If you want to stop the photo slideshows, press **RETURN** to exit.

USB Media Player (Continued)

Control panel for photo/music/movie mode operations

- Press **B** to display the control panel below.

Button/menu	Description	Photo	Music	Movie
ENTER	When selecting a folder icon: Enter this directory. When selecting a thumbnail: Play the selected file.	✓	✓	✓
	Play/Pause.	✓	✓	✓
	Rewind. Each time you press rewind, the speed will change (2x, 4x, 8x, 16x).	–	✓	✓
	Fast-forward. Each time you press fast-forward, the speed will change (2x, 4x, 8x, 16x).	–	✓	✓
	Play the previous file.	✓	✓	✓
	Play the next file.	✓	✓	✓
G / 	Stop playback and return to the list of files.	✓	✓	✓
	Loop. Each time you press ENTER , the mode will switch between Repeat 1 → Repeat All → Repeat None ↑	✓	✓	✓
	Play/cancel the background music.	✓	–	–
	Mute. Press ENTER to toggle between mute and unmute.	–	✓	–
	Two loop. Press ENTER to set the current playback time starting point. Press ENTER to set the loop end of the current playing time and start loop playback. Press ENTER button to cancel the loop.	–	–	✓
	Show playlists. Select a file from the playlists to start playback.	✓	✓	✓
	Display information about the file.	✓	✓	✓
	Slow-forward. Each time you press slow-forward, the speed will change.	–	–	✓
	Single frame-forward. Each time you press ENTER , the picture will change to the next still picture.	–	–	✓
	Set time for music/movie playback.	–	✓	✓
	Rotate clockwise 90°.	✓	–	–
	Rotate counterclockwise 90°.	✓	–	–
	Zoom in an image. Select to display larger image size.	✓	–	✓
	Zoom out an image. Select to display smaller image size.	✓	–	✓
	Pan image up, down, left or right after you zoom in. Press ENTER to exit.	✓	–	–
	Select playback length of a slideshow.	✓	–	–
	Select photo display interval.	✓	–	–
	Wide mode. You can manually select the size of a picture appeared on your screen.	–	–	✓

NOTE

- Files in folder which are not related to a selected mode cannot be accessed.
- "Unsupported file" alert will pops up for a selected file of invalid format.

USB Media Player (Continued)

DivX® setup

This is the function to confirm your registration code.

- 1 Press **MENU** and the MENU screen displays.
- 2 Press **◀/▶** to select “” (Option).
- 3 Press **▲/▼** to select “DivX (R) VOD”, and then press **ENTER**.
 - Copy the 10 digit code down.

DivX (R) VOD Register

You need to visit the DivX main page to register your TV. Please follow the online instruction to create DivX account and DivX registration video download.

Your registration is complete when you play the DivX registration video on TV.

DivX (R) VOD Deregister

You can find the deregistration code (8~10 digits). Please use this code to deactivate on DivX website.

NOTE

- Visit vod.divx.com for more information about DivX® VOD.

List of files compatible with USB mode

USB device/File system	USB Memory/FAT/FAT32/NTFS
Photo file format	JPEG (.jpg)/PNG/BMP
Music file format (Files may not be playable depending on the bitrate)	MP3 (.mp3) Bitrate: 32 k, 40 k, 48 k, 56 k, 64 k, 80 k, 96 k, 112 k, 128 k, 160 k, 192 k, 224 k, 256 k, 320 kbps Sampling frequency: 32 k, 44.1 k, 48 kHz

Video file format		
File extension	Container	Video
*.avi	AVI	DivX 3.11/4.12/ 5.x/6 H.264 MPEG4 Motion Jpeg
*.mkv	MKV	DivX 3.11/4.12/ 5.x/6 H.264 MPEG4
*.mp4 *.mov	MP4	DivX 3.11/4.12/ 5.x/6 H.264 MPEG4
*.vob	MPEG2 – PS	MPEG2
.mpg/.mpeg	MPG MPEG	MPEG2 MPEG1
.ts/.trp/*.tp	TS	H.264 MPEG2
*.asf	ASF	DivX 3.11/4.12/ 5.x/6 VC-1
*.divx	DivX	DivX 3.11/4/4.12/ 5.x/6

Appendix

Troubleshooting

The problems described below are not always caused by malfunctions. Check the TV again before having the TV serviced.

Problem	Possible Solution
<ul style="list-style-type: none"> No power. 	<ul style="list-style-type: none"> Check if you pressed POWER on the remote control unit. (See page 7.) If the indicator on the TV lights up red, press POWER. Is the AC cord disconnected? Has the power been turned on? (See page 7.)
<ul style="list-style-type: none"> Unit cannot be operated. 	<ul style="list-style-type: none"> External influences such as lightning, static electricity, etc., may cause improper operation. In this case, operate the unit after first turning the power off the TV or unplugging the AC cord and re-plugging it in after 1 or 2 minutes.
<ul style="list-style-type: none"> Remote control unit does not operate. 	<ul style="list-style-type: none"> Is battery inserted with polarity (+, -) aligned? (See page 6.) Is battery worn out? (Replace with new battery.) Are you using it under strong or fluorescent lighting? Is a fluorescent light shining on the remote control sensor?
<ul style="list-style-type: none"> Picture is cut off. 	<ul style="list-style-type: none"> Is the image position correct? (See page 15) Are screen mode adjustments such as picture size made correctly? (See pages 11 and 15.)
<ul style="list-style-type: none"> Strange colour, light colour, or dark, or colour misalignment. 	<ul style="list-style-type: none"> Adjust the picture tone. (See page 10.) Is the room too bright? The picture may look dark in a room that is too bright. Check the colour system setting. (See pages 9, 14.) Check the input signal setting. (See page 14.) Check the HDMI auto view setting. (See page 12.)
<ul style="list-style-type: none"> Power is suddenly turned off. 	<ul style="list-style-type: none"> The unit's internal temperature has increased. Remove any objects blocking the vent or clean. Check the ECO setting. (See page 11.) Is the sleep timer set? (See page 6.)
<ul style="list-style-type: none"> No picture. 	<ul style="list-style-type: none"> Is the connection to external equipment correct? (See pages 4 to 5.) Has the input signal setup been performed correctly after connection? (See page 14.) Is the correct input selected? Is the "Picture adjust" correct? (See page 10.) Is the antenna connected properly? (See page 4.) Is "On" selected in "Audio only"? (See page 14.)
<ul style="list-style-type: none"> No sound. 	<ul style="list-style-type: none"> Is the volume too low? (See page 6.) Make sure that headphones are not connected.
<ul style="list-style-type: none"> The TV sometimes makes a cracking sound. 	<ul style="list-style-type: none"> This is not a malfunction. This happens when the cabinet slightly expands and contracts according to changes in temperature. This does not affect the TV's performance.

Cautions regarding use in high and low temperature environments

- When the unit is used in a low temperature space (e.g. room, office), the picture may leave trails or appear slightly delayed. This is not a malfunction, and the unit will recover when the temperature returns to normal.
- Do not leave the unit in a hot or cold location. Also, do not leave the unit in a location exposed to direct sunlight or near a heater, as this may cause the cabinet to deform and the LCD panel to malfunction.
Storage temperature: -20°C to +60°C.

Specifications

Item		Model	LC-32LE155X	LC-39LE155X
LCD panel			80 cm	98 cm
Resolution			1,049,088 pixels (1366 × 768)	2,073,600 pixels (1920 × 1080)
Video colour system			PAL/SECAM/NTSC 3.58/NTSC 4.43/PAL 60	
TV function	TV-standard	Analogue	PAL: B/G, D/K, I SECAM: B/G, D/K, K/K _i	
		Digital	DVB-T	
	Receiving channel	VHF/UHF	44.25—863.25 MHz	
		CATV	S1—S41 ch (including Hyperband)	
	TV-tuning system		Auto Preset 99 ch	
STEREO/BILINGUAL			NICAM: B/G, I, D/K A2 stereo: B/G	
Viewing angles			H : 178° V : 178°	H : 176° V : 176°
Audio amplifier/Speakers			5 W × 2 / 3 × 10 cm 2pcs	
Terminals	Antenna input		UHF/VHF 75 Ω DIN type	
	INPUT 1 (HDMI/ARC)		HDMI (HDMI input)	
	INPUT 2 (HDMI)		HDMI (HDMI input), AUDIO in (φ 3.5 mm jack)	
	INPUT 3 (HDMI/MHL)		HDMI (HDMI input)	
	INPUT 4		VIDEO in, AUDIO in, COMPONENT in	
	INPUT 5		VIDEO in, AUDIO in	
	INPUT 6 (PC)		15 pin mini D-sub, AUDIO in (common use with INPUT 2) (φ 3.5 mm jack)	
	AUDIO OUT		AUDIO out	
	USB		USB	
	RS-232C		9 pin D-sub male connector	
	DIGITAL AUDIO OUTPUT		Optical Digital Audio Output	
Headphone		φ 3.5 mm stereo		
OSD language			English	
Power requirement			AC 110 — 240 V, 50/60 Hz	
Power consumption			50 W (0.5 W Standby)	60 W (0.5 W Standby)
Dimensions	without stand		745 (W) × 465 (H) × 81 (D) mm	898 (W) × 553 (H) × 81 (D) mm
	with stand		745 (W) × 545 (H) × 210 (D) mm	898 (W) × 633 (H) × 236 (D) mm
Weight without stand (with stand)			5.9 kg (6.5 kg)	6.7 kg (7.5 kg)
Operating temperature			0°C — 40°C	

- As a part of policy of continuous improvement, SHARP reserves the right to make design and specification changes for product improvement without prior notice. The performance specification figures indicated are nominal values of production units. There may be some deviations from these values in individual units.

CAUTION

- Installing the Liquid Crystal Television requires special skill that should only be performed by qualified service personnel. Customers should not attempt to do the work themselves. SHARP bears no responsibility for improper mounting or mounting that results in accident or injury.
- Carefully read the instructions that come with the bracket before beginning work.

Protection against overturning

There is a danger of the product overturning in the case of a disaster or sudden collision. Carry out the following tip-resistant measurement for your safety.

Anchoring the TV to the wall or a pillar

- 1 Fix the product with the 2 clamps (supplied), using the screws (supplied).
- 2 Fix the TV to the wall using extra strong ties (commercially available).

View from the top

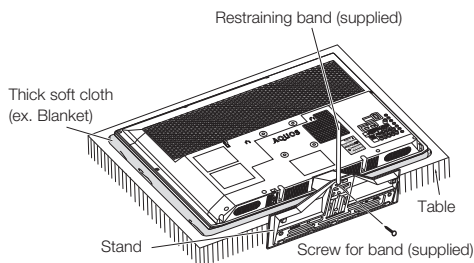
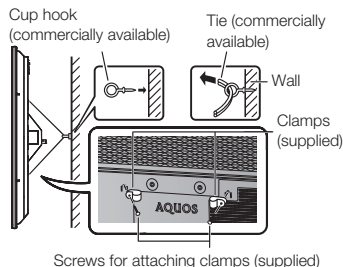

Fixing the TV to the table

LC-32LE155X

- 1 Lay the TV down on cushioning (such as a blanket) over a table.
- 2 Attach the band (supplied) to the bottom of the stand using the screw (supplied).
- 3 Transfer the product to the table where you intend to fix the TV.
- 4 Fix the TV to the table by the band with a screw (commercially available).
 - Use a screw (commercially available) whose shape is compatible with the band.

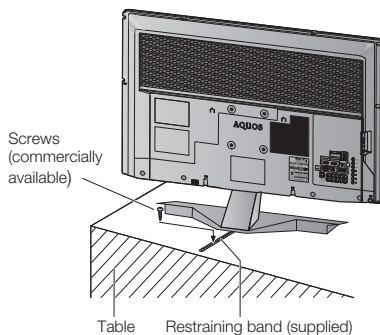

LC-39LE155X

- 1 Transfer the product to the table where you intend to fix the TV.
- 2 Fix the TV to the table by the prevent angle with the screws (commercially available).
 - Use the screws (commercially available) whose shape is compatible with the prevent angle.

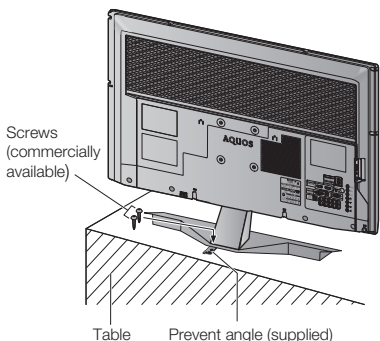

CAUTION

- As this product is heavy, use a table that is wide enough to support the product and capable of withstanding the product's weight. The table should be set where it will not be overturned.

Dimensional drawings

LC-32LE155X

Unit: mm

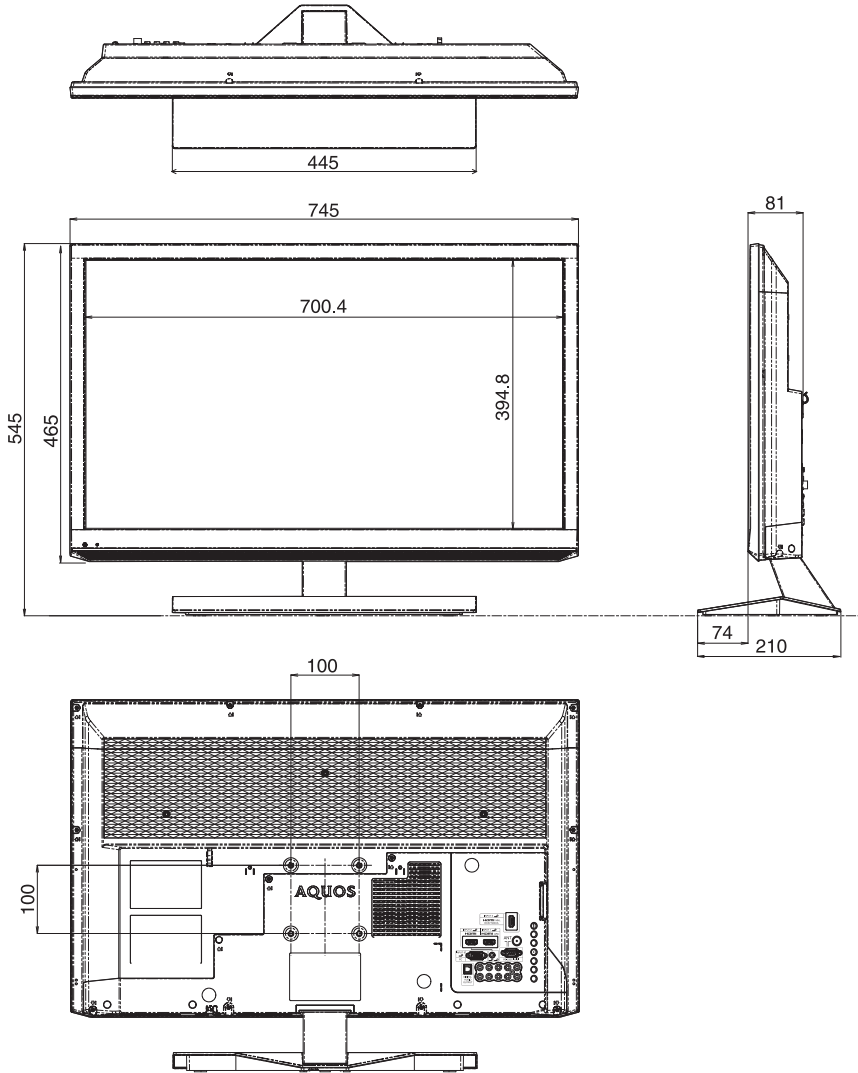

Dimensional drawings (Continued)

LC-39LE155X

Unit: mm

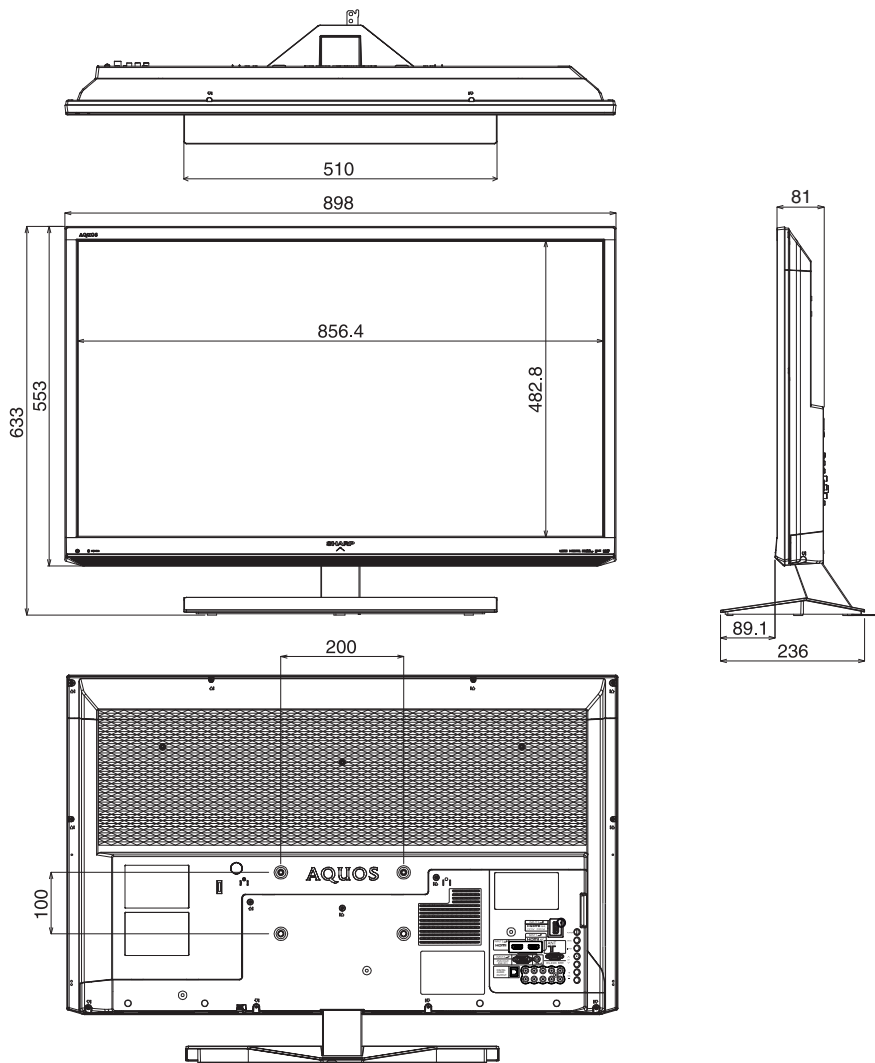

CLEARING THE PASSWORD

If you forget the password, clear the password using the following procedure.

- 1 Press **MENU** to display the MENU screen, and then press ◀▶ to select "⚙️" (Setup).
- 2 Press ▲/▼ to select "Child lock", and then press **ENTER** and the password input screen display.
- 3 If you enter "3001" using **0 – 9**, the "Child lock" setting menu will be displayed.
- 4 Enter the 4-digit number as a password using **0 – 9**. The new password is now set.



The Password is

--	--	--	--

NOTE

- As a precautionary measure, make a note of your password above, remove it from this manual, and keep it in a familiar place.

SHARP

FOR LOCATION ENQUIRIES WITHIN

AUSTRALIA

REGARDING YOUR LOCAL

SHARP APPROVED SERVICE CENTRE

VISIT OUR WEBSITE AT

www.sharp.net.au

OR CALL SHARP CUSTOMER CARE

1300 135 022

(LOCAL CALL COSTS APPLY WITHIN AUSTRALIA)

SHARP CORPORATION OF AUSTRALIA PTY LTD

SHARP

FOR LOCATION ENQUIRIES WITHIN

NEW ZEALAND

REGARDING YOUR LOCAL

SHARP APPROVED SERVICE CENTRE

VISIT OUR WEBSITE AT

www.sharp.net.nz

CONTACT YOUR SELLING DEALER/RETAILER

OR CALL

SHARP CUSTOMER SERVICES

TELEPHONE: 09 573 0111

FACSIMILE: 09 573 0113

SHARP CORPORATION OF NEW ZEALAND LIMITED

SHARP

WARRANTY

Consumer Electronic Products

Congratulations on Your Purchase!

This Sharp product is warranted against faults in material and manufacture for the period as stated in the table below.

If service is required during the warranty period, please contact your nearest Sharp Approved Service Centre. These repairs would be carried out at no charge to the owner, subject to the conditions specified herein.

This warranty does not extend to defects or injuries caused by or resulting from causes not attributable to faulty parts or the manufacture of the product, including but not limited to, defect or injury caused by or resulting from misuse, abuse, neglect, lack of maintenance, accidental damage, improper voltage, liquid spillage, vermin infestation, software, or any alterations made to the product which are not authorised by Sharp.

Please retain your sales documentation, as this should be produced to validate a warranty claim. This warranty is in addition to and in no way limits, varies or excludes any implied rights and remedies under any relevant legislation in the country of sale.

This warranty does not cover transportation to and from the Sharp Approved Service Centre. Goods presented for repair may be replaced by refurbished goods of the same type rather than being repaired. Refurbished parts may be used to repair the goods. The repair of your goods may result in the loss of user generated data, please ensure that you have saved this data elsewhere prior to repair.

Australian customers: Our goods come with guarantees that cannot be excluded under the Australian Consumer Law. You are entitled to a replacement or refund for a major failure and for compensation for any other reasonably foreseeable loss or damage. You are also entitled to have the goods repaired or replaced if the goods fail to be of acceptable quality and the failure does not amount to a major failure. The criteria of a major failure is defined in the Australian Consumer Law. Should you require any assistance with a major failure please contact Sharp Customer Care.

WARRANTY PERIODS

Home Theatre Projector	12 months (excluding lamps and air filters)
Audio/Home Theatre	12 months
Microwave Oven	12 months
Steam Oven	12 months
Refrigerator	24 months
DVD/Blu-ray	12 months
Air Conditioner	60 months
Portable Air Conditioner	12 months
LCD Television	12 months
Air Purifier	12 months
Vacuum Cleaner	24 months

SHARP
 SHARP CORPORATION OF AUSTRALIA PTY LIMITED
 ABN 40 093 039 485
 1 Huntington Drive
 Huntingwood NSW 2148
 SHARP CORPORATION OF NEW ZEALAND LIMITED
 89 Hupu Johnson Drive
 Pentress, Auckland

SPform 040 (JUNE 2012)

IMPORTANT NOTICE: This warranty applies only to products sold in Australia & New Zealand

SHARP®

SHARP CORPORATION

Printed in Malaysia
 TINS-G121WJZZ
 14P01-MA-NP

Free Manuals Download Website

<http://myh66.com>

<http://usermanuals.us>

<http://www.somanuals.com>

<http://www.4manuals.cc>

<http://www.manual-lib.com>

<http://www.404manual.com>

<http://www.luxmanual.com>

<http://aubethermostatmanual.com>

Golf course search by state

<http://golfingnear.com>

Email search by domain

<http://emailbydomain.com>

Auto manuals search

<http://auto.somanuals.com>

TV manuals search

<http://tv.somanuals.com>