

SHARP®

LC-90LE760X

LED BACKLIGHT TV

OPERATION MANUAL

AQUOS



Dear SHARP customer

Thank you for your purchase of the SHARP LCD colour TV product. To ensure safety and many years of trouble-free operation of your product, please read **Important safety precautions** carefully before using this product.

Contents

Introduction.....	3	AQUOS LINK.....	32
Precautions For Daily Use	3	Controlling HDMI devices using AQUOS LINK.....	32
Important safety precautions.....	3	AQUOS LINK connection.....	33
Supplied accessories.....	6	Regarding "Select recording device".....	33
Optional accessories	6	Operating an AQUOS LINK device.....	34
Preparation	7	Using a Smartphone with the TV.....	35
Protection against overturning	7	Basic adjustment.....	37
Attaching the Stand.....	8	Picture settings	37
Connecting the TV.....	9	Audio settings.....	39
Using the remote control unit.....	10	Power save settings.....	41
Inserting the batteries.....	10	Channel settings.....	42
Angle of the remote control unit.....	10	Digital setting (DTV only).....	42
Cautions regarding the remote control unit.....	10	Analogue setting	43
Part names and functions.....	11	Sort.....	44
TV (front view).....	11	Erase programme	44
TV (rear view).....	11	Useful viewing functions.....	44
Remote control unit	13	TV Start-up time setting	44
Quick guide	14	Individual setting – Password.....	45
Inserting the CA card into the CI module.....	14	Individual setting – Time.....	46
Recording CAM PIN setting	14	Individual setting – Language.....	46
CI plus 1.3 Standard.....	14	Optional features settings	47
What is the HOME?.....	15	Selecting the picture size manually	47
Basic operation	15	Selecting the picture size automatically.....	47
Initial auto installation	17	Setting audio input	48
Checking signal strength and channel strength		Skipping specified inputs.....	48
(DTV only).....	17	Selecting the HDMI picture size automatically... ..	49
Watching TV.....	18	Adjusting image position	50
Daily operation.....	18	Additional features	50
Turning on/off the power – using the control		Bluetooth setup	52
panel of the TV.....	18	Miracast setup.....	53
Turning on/off the power – using the remote		Network function.....	54
control unit.....	18	Playing Back Files from a Portable Device or PC... ..	54
Watching TV (DTV only).....	19	Easy share setting	54
CH list	19	Device name setting	54
Programme information (DTV only)	19	Connecting to the network.....	54
Selecting an external video source	19	Wired installation	54
Switching the digital audio format (DTV only)	20	Wireless installation	55
Switching the analogue audio format.....	20	Specifications (Wireless LAN).....	57
Favourite Channel Information.....	21	Specifications (Bluetooth).....	57
Operator profile.....	21	Using AQUOS.NET	58
Teletext	22	Clear browser setting.....	59
		About links.....	59
EPG (DTV only)	24	Other useful features	61
Useful settings for using EPG	24	USB-recording.....	61
Selecting a programme using EPG (DTV only)....	25	Connecting a USB HDD.....	61
Timer setup using EPG	27	USB HDD registration.....	61
Cancelling the timer setup	27	How to operate USB-recording.....	62
Connecting external devices.....	28	USB-recording	63
Video connections	29	USB-recording timer setting	63
HDMI connection	29	Timer list	63
Component connection.....	30	USB-recording playback	63
VIDEO connection.....	30	Time shift playback	64
Audio connections.....	31	Multimedia/Home network.....	65
Speaker/amplifier connection	31	Photo mode.....	66
		3D mode.....	66
		Music mode	67

Video mode.....	68
USB device/SD memory card compatibility.....	69
Home network server compatibility.....	69
Connecting a PC.....	70
Connecting a PC.....	70
Displaying a PC image on the screen.....	70
Selecting the picture size.....	70
Adjusting the PC image automatically.....	71
Adjusting the PC image manually.....	71
PC control of the TV.....	72
Command list.....	73
Enjoying 3D image viewing.....	74
Before using the 3D glasses.....	74
Preparing for the 3D glasses.....	75
Part Names.....	75
Using the 3D glasses.....	76
Before using the 3D Glasses.....	76
Attaching the Nose Pad.....	76
Using the 3D glasses.....	76
Usage Range of the 3D Glasses.....	76
Replacing the Battery.....	77
Cautions for 3D image viewing.....	78
Display format for 3D and 2D images.....	78
Viewing 3D images.....	79
Receiving a 3D image signal that can be detected automatically.....	79
Switching 3D to 2D mode.....	79
Receiving a 3D image signal that cannot be detected automatically.....	79
Watching 2D images in 3D.....	80
Switching to the previous mode.....	80
3D Menu.....	80
Configuring the TV settings to enhance 3D image viewing.....	80
3D picture adjustments.....	80
3D setup.....	81
Specifications — 3D glasses.....	82
Troubleshooting — 3D Images.....	83
Appendix.....	84
Troubleshooting.....	84
Troubleshooting — Digital broadcasting.....	84
Reset.....	85
Updating your TV via DVB-T (DTV only).....	85
Getting information.....	86
Updating your TV via USB/Network.....	86
Information on the software licence for this product.....	87
Software licence.....	87
Specifications.....	89
Removing the stand.....	90
Mounting the TV on a wall.....	91
Dimensional drawings.....	93
CLEARING THE PASSWORD.....	94

NOTE

- The illustration and on-screen displays in this operation manual are for explanation purposes and may vary slightly from the actual operation.

Introduction

Precautions For Daily Use

Observe the following items

Maintenance of the cabinet

- When cleaning the cabinet, use a soft cloth (made of cotton, floss, etc.) to clean gently.
- Do not use a dry or damp rag mixed with chemicals, as this could cause the ingredients of the cabinet body to deteriorate or crack.
- Be careful not to use an abrasive cloth for cleaning or clean with excessive force, as this could scratch the surface of the cabinet.
- If the cabinet is greatly soiled, clean with a soft cloth (made of cotton, floss, etc.) soaked with a small amount of diluted neutral detergent and wrung out, and then clean with a soft dry cloth.
- Solvents such as benzene or thinner could cause the cabinet to deteriorate, or make its coating come off. Therefore do not use such solvents to clean the cabinet.
- Because plasticizer is included in the plastics, deterioration or the coating peeling off could occur when the cabinet comes into contact with some substances. Therefore keep it away from volatile substances such as insecticide. In addition, do not let it come into contact with objects made of rubber, resin, etc. for a long time.

Maintenance of the LCD panel

- Before cleaning the LCD panel, be sure to turn off the TV set and unplug the power cord from the outlet.
- When cleaning the LCD panel, use a dry and soft cloth (made of cotton, floss, etc.) to clean the surface of the LCD panel gently. For protecting the LCD panel, do not clean with a dirty cloth, detergent, or a dry or damp rag mixed with chemicals, as this could cause peeling of the panel surface.
- Be careful not to clean with an abrasive cloth or with excessive force, as this could cause the panel surface to be scratched.
- If the LCD panel is greatly soiled, clean it gently with a soft cloth (made of cotton, floss, etc.) soaked with a small amount of water (Do not clean with excessive force, so as to avoid the scratch of the panel surface).
- If dust sticks on the surface of the LCD panel, clean the panel with a commercially available cleaning brush (anti-static brush).

Important safety precautions

Caring for the cabinet

- Use a soft cloth (cotton, flannel, etc.) and gently wipe the surface of the cabinet.
- Using a chemical cloth (wet/dry sheet type cloth, etc.) may deform the components of the main unit cabinet or cause cracking.
- Wiping with a hard cloth or using strong force may scratch the surface of the cabinet.
- If the cabinet is very dirty, wipe with a soft cloth (cotton, flannel, etc.) soaked in neutral detergent diluted with water and thoroughly wrung out, and then wipe with a soft dry cloth.
- The cabinet is primarily made of plastic. Avoid using benzene, thinner, and other solvents, as these may deform the cabinet and cause the paint to peel off.
- Do not apply insecticides or other volatile liquids.
- Also, do not allow the cabinet to remain in contact with rubber or vinyl products for a long period of time. Plasticizers inside the plastic may cause the cabinet to deform and cause the paint to peel off.

- When relocating the product placed on a cart, it must be moved with utmost care. Sudden stops, excessive force and uneven floor surface can cause the product to fall from the cart.



Caring for the front panel

- Turn off the main power and unplug the AC cord from the wall outlet before handling.
- Gently wipe the surface of the front panel with a soft cloth (cotton, flannel, etc.).
- To protect the front panel, do not use a dirty cloth, liquid cleaners, or a chemical cloth (wet/dry sheet type cloth, etc.). This may damage the surface of the front panel.
- Wiping with a hard cloth or using strong force may scratch the surface of the front panel.
- Use a soft damp cloth to gently wipe the front panel when it is really dirty (It may scratch the surface of the front panel when wiped strongly).
- If the front panel is dusty, use an anti-static brush, which is commercially available, to clean it.



- Water and moisture — Do not use the product near water, such as bathtub, washbasin, kitchen sink, laundry tub, swimming pool and in a wet basement.



Introduction

- Do not place vases or any other water-filled containers on this product. The water may spill onto the product causing fire or electric shock.



- Stand — Do not place the product on an unstable cart, stand, tripod or table. Doing so can cause the product to fall, resulting in serious personal injuries as well as damage to the product. Use only a cart, stand, tripod, bracket or table recommended by the manufacturer or sold with the product. When mounting the product on a wall, be sure to follow the manufacturer's instructions. Use only the mounting hardware recommended by the manufacturer.



- Ventilation — The vents and other openings in the cabinet are designed for ventilation. Do not cover or block these vents and openings since insufficient ventilation can cause overheating and/or shorten the life of the product. Do not place the product on a bed, sofa, rug or other similar surface, since they can block ventilation openings. This product is not designed for built-in installation; do not place the product in an enclosed place such as a bookcase or rack, unless proper ventilation is provided or the manufacturer's instructions are followed.

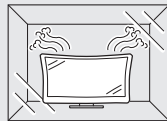

- In case the product is dropped and the cabinet is damaged, be sure to turn off the power of the product, and unplug the power cord. If you continue to use the product, it may cause fire or electric shock. Contact your dealer.



- Do not open the rear cover of the cabinet to reconstruct the circuits. There exists high voltage within the cabinet and it may cause electric shock and injury. If maintenance is required, contact your dealer.



- The LCD panel used in this product is made of glass. Therefore, it can break when the product is struck forcefully or with a sharp object. If the LCD panel is broken, be careful not to be injured by broken glass.



- Heat sources — Keep the product away from heat sources such as radiators, heaters, stoves and other heat-generating products (including amplifiers).



- To prevent fire, never place any type of candle or naked flames on the top or near the TV set.



- To prevent fire or shock hazard, do not place the AC power cord under the TV set or other heavy items.



- Do not place heavy objects on this product or stand on it. Doing so could cause injury if the product overturns. Take special care near children and pets.

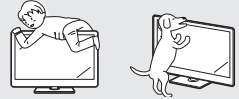

- Unplug the power cord before you move the TV set. If not unplugged beforehand, the power cord may become damaged and cause electric shock.



The LCD panel is a very high technology product with 2,073,600 pixels, giving you fine picture details. Due to the very large number of pixels, occasionally a few non-active pixels may appear on the screen as a fixed point of blue, green or red. This is within product specifications and does not constitute a fault.

Precautions when transporting the TV

- When transporting the TV, never carry it by holding or otherwise putting pressure onto the display. Be sure to always carry the TV by three people holding it with two hands.

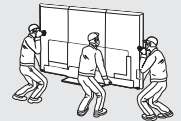

If a television is not positioned in a sufficiently stable location, it can be potentially hazardous due to falling. Many injuries, particularly to children, can be avoided by taking simple precautions such as:

- Using cabinets or stands recommended by the manufacturer of the television.
- Only using furniture that can safely support the television.
- Ensuring the television is not overhanging the edge of the supporting furniture.
- Not placing the television on tall furniture (for example, cupboards or bookcases) without anchoring both the furniture and the television to a suitable support.
- Not standing the televisions on cloth or other materials placed between the television and supporting furniture.
- Educating children about the dangers of climbing on furniture to reach the television or its controls.

- Do not display a still picture for a long time, as this could cause an afterimage to remain.

- Install the product on the place where the AC cord can be unplugged easily from the AC outlet, or from the AC INPUT terminal on the rear of the product.

NOTE

- The above are pictures for reference only; the actual item might be different.

3D Glasses

Prevention of accidental ingestion

- Keep the accessory out of the reach of small children. Small children can accidentally swallow these parts.
 - If a child accidentally swallows any of these parts, seek immediate medical attention.

Do not disassemble

- Do not disassemble or modify the 3D Glasses except when recycling the batteries. Do not modify the 3D Glasses.

Caution for lithium battery

- Do not expose the 3D Glasses to excessive heat, such as direct sunlight, fire or in an area with high humidity.
- Replace only with the same or equivalent type of battery. The battery may explode if improperly replaced.
- Take care not to reverse the battery poles (+ and -) when loading the battery. Loading the battery incorrectly may damage the battery or cause it to leak battery fluid, which could result in a fire, injury or damage.

Handling the 3D Glasses

- Do not drop, exert pressure on, or step on the 3D Glasses. Doing so may damage the glass section, which may result in the risk of injury.
- Be careful not to trap your finger in the hinge section of the 3D Glasses. Doing so may result in injury.
 - Pay special attention when children are using this product.

Using the 3D Glasses



- Use of the 3D Glasses should be limited to a maximum of 3 hours, and in any case no more than one movie.
- Use only the 3D Glasses recommended for this TV.
- Use the 3D Glasses only for the specified purpose.
- Do not move around while wearing the 3D Glasses. The surrounding area may appear dark, which may result in falling or other accidents that may cause injury.

Viewing 3D images

- If you experience dizziness, nausea, or other discomfort while viewing 3D images, discontinue use and rest your eyes.
- Do not use the 3D Glasses if they are cracked or broken.

Introduction

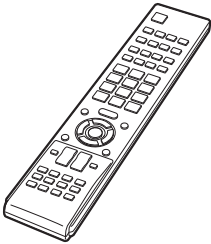
Supplied accessories

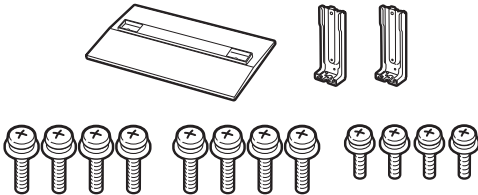
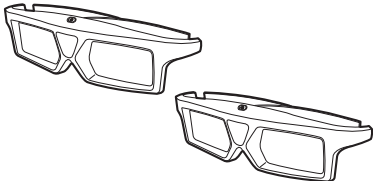
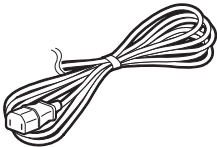
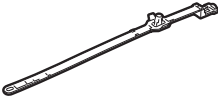
Remote control unit (x 1)	“AAA” size battery (x 2)	AV cable (x 1)
 <p>Pages 10 and 13</p>	 <p>Page 10</p>	 <p>Page 30</p>
Stand unit		3D glasses (x 2)
 <p>Page 8</p>		
AC cord (x 1)	Cable tie (x 1)	Other accessories
		<ul style="list-style-type: none"> • Operation manual

Optional accessories

Some of the listed optional accessories may not be available depending on the region. Please check with your nearest Sharp Authorised Dealer for current optional accessories as we may add more optional accessories from time to time.

Part name	Part number
3D glasses	AN-3DG20-B
	AN-3DG30

Preparation

Protection against overturning

There is a danger of the product overturning in the case of a disaster or sudden collision. Carry out the following tip-resistant measurement for your safety.

Anchoring the TV to the wall or a pillar

- 1 Affix the TV to the wall or a pillar using extra strong ties and cup hooks.

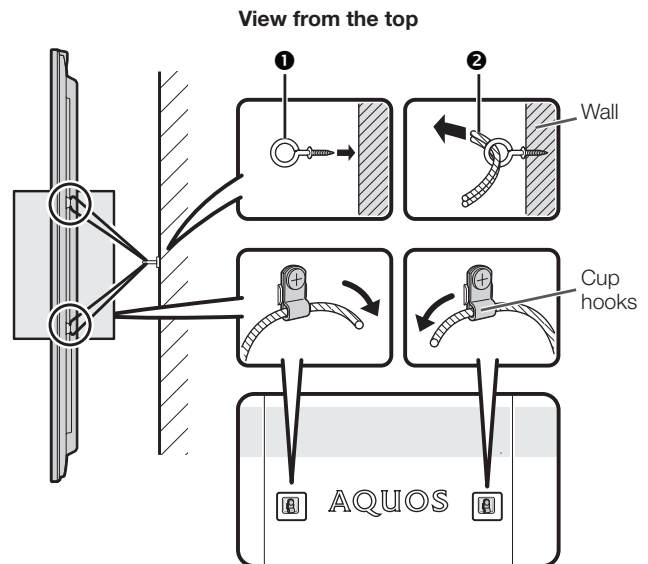

- 1 Cup hook (commercially available)
- 2 Tie (commercially available)

Fixing the TV to the table

- 1 Place the TV on the table.
- 2 Pull the attached restraining bracket out so that it is at a 90 degrees angle.
- 3 Insert commercially available screw in the hole of the restraining bracket and tighten the screw to secure the TV to the table.
 - Use commercially available screw to firmly secure the TV.

CAUTION

- As this product is heavy, use a table that is wide enough to support the product and capable of withstanding the product's weight. The table should be set where it will not be overturned.
- Be sure to use at least two people when moving the TV.

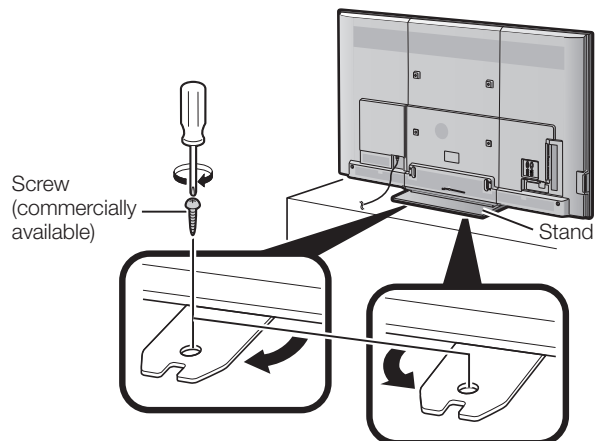

Attaching the Stand

- Before attaching (or detaching) the stand, unplug the AC cord.
- Before performing work spread cushioning over the base area to lay the TV on. This will prevent it from being damaged.

CAUTION

- **Be sure to follow the instructions. Incorrect installation of the stand may result in the TV falling over.**
- **After attaching the stand to the TV, do not hold the stand when you put up, set up, move or lay down the TV.**
- **Do not remove the stand from the TV unless using a wall mount bracket to mount it.**

Before attaching the stand to the TV, build a work table on which to rest the TV.

- To build the table, use the cushioning materials used in the packaging.

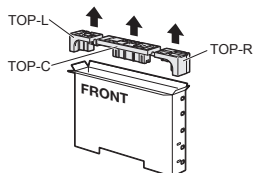

- Of the cushioning materials used, TOP-C is also used during stand unit assembly. Be sure to assemble the stand unit before building the work table.

■ Stand Unit Assembly

- 1 Confirm that there are 12 screws (8 long screws and 4 short screws) supplied with the stand unit.
- 2
 - ① Set the post for the stand unit onto the TOP-C.
 - ② Attach the base to the post.
 - ③ Insert and tighten the 8 screws into the 8 holes on the bottom of the base.
 - Hold the stand unit securely with one hand, and then tighten the screws.

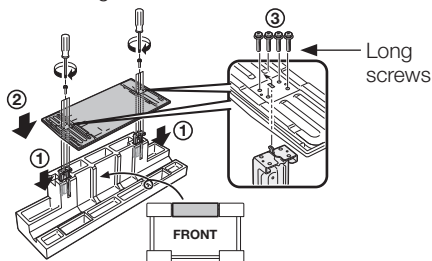

■ Building the Work Table

- 3 Attach the joints and close the case.
 - ① Insert a joint into the hole on the side of the case.
 - ② Pressing the tab, fix the joint into place.



- 4 Insert each of the cushioning materials in the respective directions shown in the figure.
 - Insert TOP-L and TOP-R into the left and right sides of the case respectively.
 - Insert TOP-C to fit between the lines on the other side of the case.

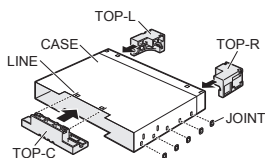

- 5 The case is equipped with push-in tabs to hold the cushioning materials in place. Push in the tabs (2 for each location) to secure the cushioning materials in the case.

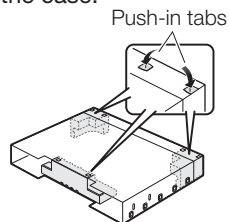

- 6 After you have built the work table, spread a blanket or similar soft cloth over the table and then lay the TV display down on the covered table.
 - Do not use a small table for this.

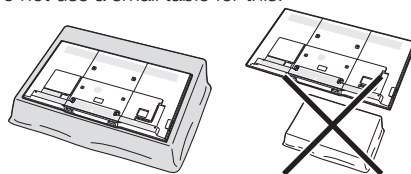

■ Attaching the Stand to the TV

- 7 Insert the stand into the openings on the bottom of the TV.
 - Make sure that the stand is firmly inserted into the TV. Improper installation may result in tilting of the TV set.

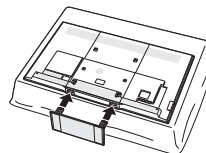

- 8 Insert and tighten the 4 screws into the 4 holes on the rear of the TV.

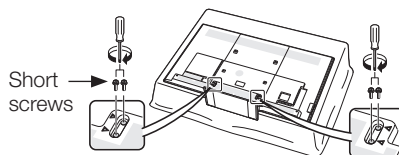

NOTE

- In the installation procedure, be careful not to catch your fingers between the TV set and the floor.

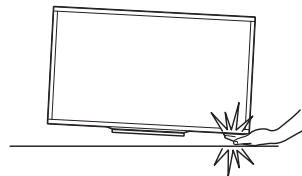

Connecting the TV

Notes on installing the TV

- Avoid direct sunlight and place the TV in a well-ventilated location.
- Place the TV in a level location.
- Do not turn on the power of the TV before connecting the AC cord.

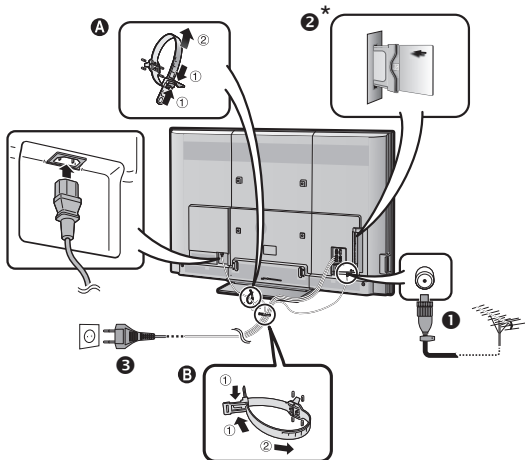

- 1 Plug the standard DIN45325 plug (IEC 169-2) 75-ohm coaxial cable.
- 2 Insert a CA card into the CI slot to watch scrambled broadcasts (Page 14).
- 3 Plug the AC cord in to the AC outlet (product shape varies in some countries).

NOTE

- * This function applicable for certain countries only.
- The cable tie can be moved from **A** to **B**.
 - Place the TV close to the AC outlet, and keep the power plug within reach.
 - Disconnect the AC cord from the AC outlet if the TV will not be used for a long period of time.

Preparation

Using the remote control unit

Inserting the batteries

Before using the TV for the first time, insert two supplied “AAA” size batteries. When the batteries become depleted and the remote control unit fails to operate, replace the batteries with new “AAA” size batteries.

- 1 Open the battery cover.
- 2 Insert the two supplied “AAA” size batteries.
- 3 Close the battery cover.

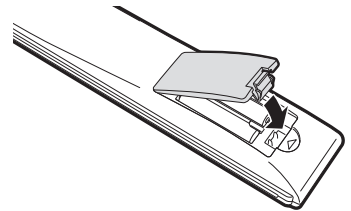
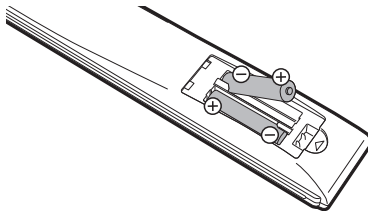
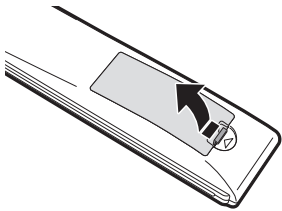

- Place batteries with their terminals corresponding to the (+) and (-) indications in the battery compartment.

CAUTION

Improper use of batteries can result in chemical leakage or explosion. Be sure to follow the instructions below.

- Do not mix batteries of different types. Different types of batteries have different characteristics.
- Do not mix old and new batteries. Mixing old and new batteries can shorten the life of new batteries or cause chemical leakage in old batteries.
- Remove batteries as soon as they have worn out. Chemicals that leak from batteries can cause a rash. If you find any chemical leakage, wipe thoroughly with a cloth.
- The batteries supplied with this product may have a shorter life expectancy due to storage conditions.
- If you will not be using the remote control unit for an extended period of time, remove the batteries from it.
- Batteries shall not be exposed to excessive heat such as sunshine, fire or the like.

Angle of the remote control unit

Use the remote control unit by pointing it towards the remote control sensor. Objects between the remote control unit and sensor may prevent proper operation.

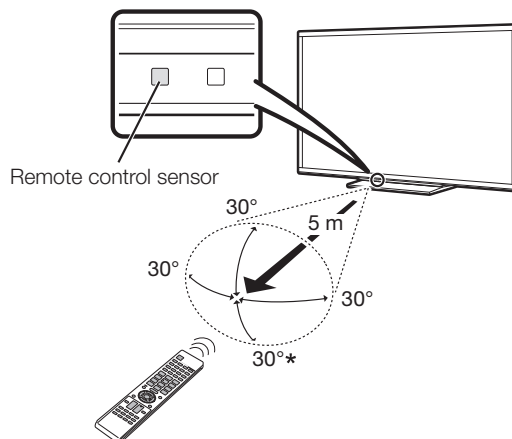

* When mounting the TV on the wall.

Cautions regarding the remote control unit

- Do not expose the remote control unit to shock. In addition, do not soak the remote control unit to liquids, and do not place in an area with high humidity.
- Do not install or place the remote control unit under direct sunlight. The heat may cause deformation of the unit.
- The remote control unit may not work properly if the remote control sensor of the TV is under direct sunlight or strong lighting. In such cases, change the angle of the lighting or the TV, or operate the remote control unit closer to the remote control sensor.

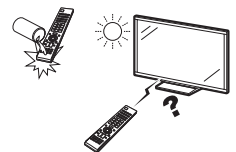

Part names and functions

TV (front view)

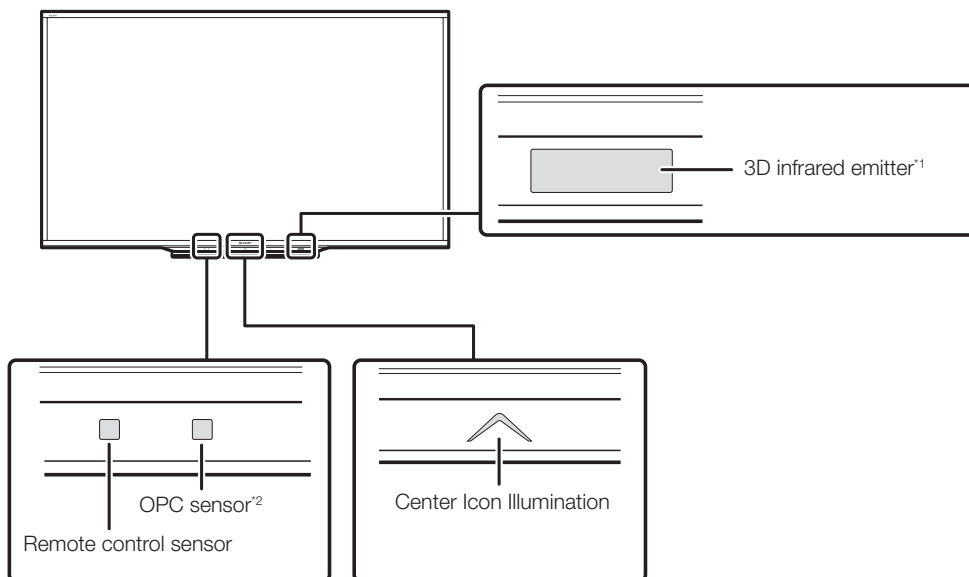
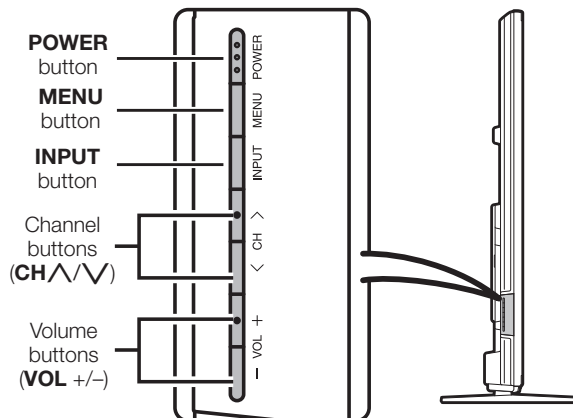

¹ This panel emits infrared signal towards the 3D glasses you wear when viewing 3D images. Do not place anything between the 3D infrared emitter on the TV and the infrared receiver on the 3D glasses. Refer to page 78 for details.

² OPC: Optical Picture Control (Page 37)

TV (rear view)

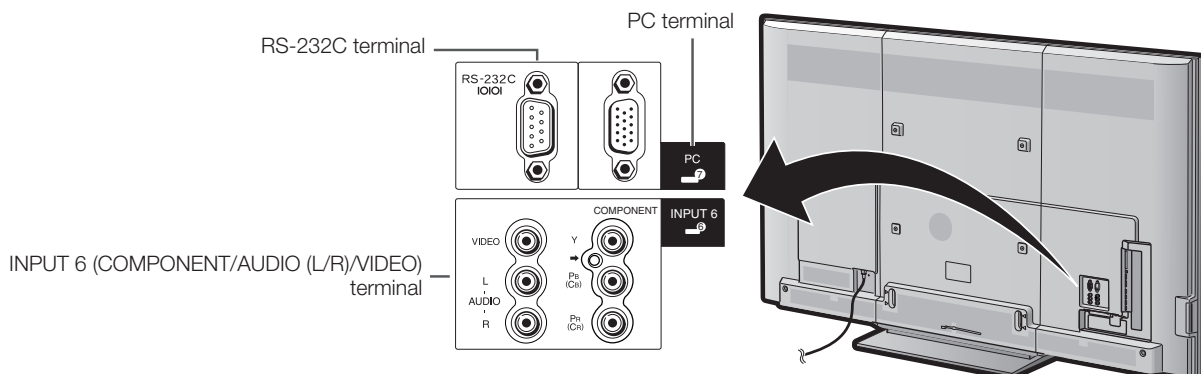

Part names and functions

TV (rear view) — continued

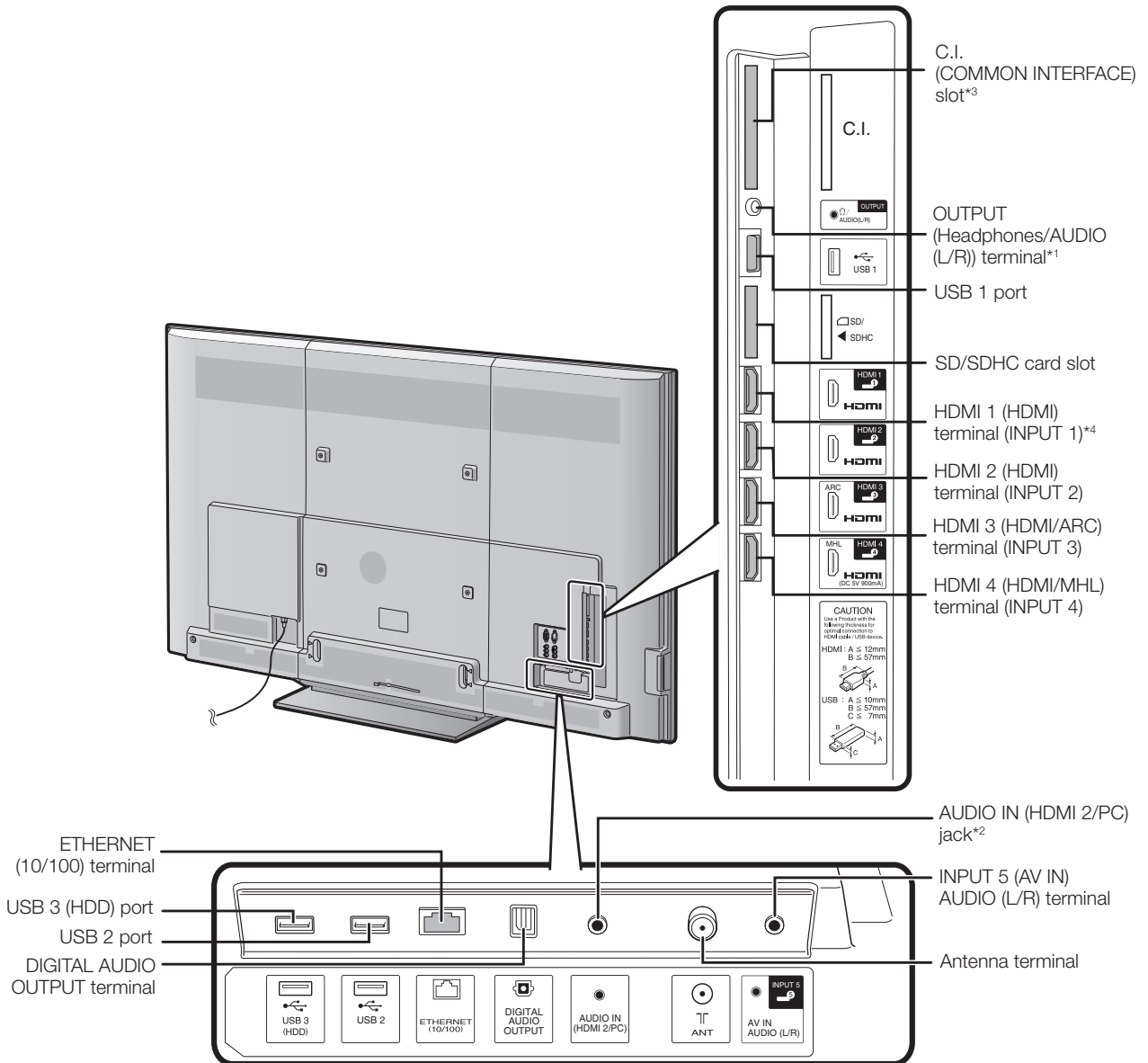

*¹ Refer to page 49 for details.

*² The HDMI 2 and PC terminals can both use the same audio input terminal (AUDIO IN (HDMI 2/PC)). However, the proper item must be selected in the "Audio select" menu (refer to page 48 for details).

*³ This function applicable for certain countries only.

*⁴ HDCP 2.2 copy protected signal can be viewed via HDMI 1 only.

WARNING

- Excessive sound pressure from earphones and headphones can cause hearing loss.
- Do not set the volume at a high level. Hearing experts advise against extended listening at high volume levels.

Remote control unit

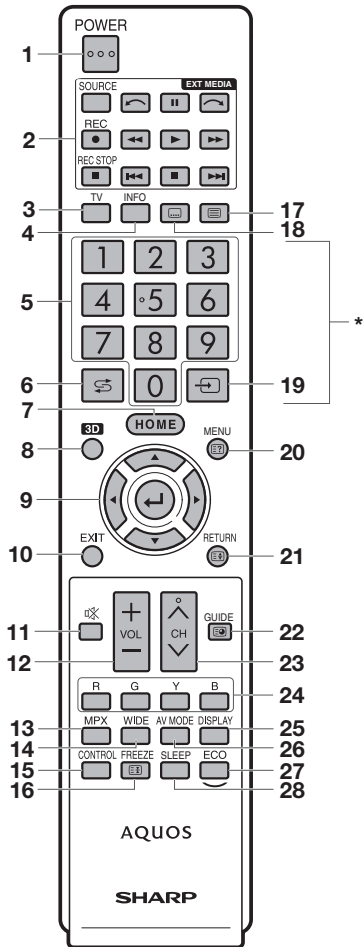

1 POWER (Standby/On)

To switch the power on and off (Page 18).

2 EXT MEDIA buttons

AQUOS LINK

If external equipment such as a AQUOS BD player is connected via HDMI cables and is AQUOS LINK compatible, you can use these EXT MEDIA buttons. See pages 32 and 35 for details.

USB-recording

Record a programme you are watching. (Pages 61–65).

3 TV

Press to access analogue and digital TV mode.

4 INFO

DTV : Display the programme information (Page 19).

ATV : Display the channel information.

5 0-9*

Set the channel (Page 18).

6 ↶ (Flashback)*

Press to return to the previously selected channel or external input.

7 HOME

Display the "HOME" screen to enjoy Internet connection and Home network function and to perform settings for the TV (Page 15).

8 3D

Select between 3D and 2D image viewing (Pages 74–83).

9 ▲/▼/◀▶ (Cursor)

Select a desired item on the setting screen.

↵ (ENTER)

Execute a command.

10 EXIT

Turn off the On-Screen Display (Page 15).

11 🔇 (Mute)

Mute the sound.

12 VOL +/-

Set the volume.

13 MPX

Select a sound multiplex mode (Page 20).

14 WIDE

Change a wide image mode (Pages 47, 68, 69 and 70).

15 CONTROL

Press to display the panel to operate some functions on the screen.

16 FREEZE/⏸ (Hold)

Freeze a motion picture on the screen.

Teletext mode : Stop updating teletext pages automatically.

Press again to release the hold mode (Page 22).

17 (Teletext)

Select the teletext mode (All TV image, all text image and TV/text image) (Page 22).

18 (Subtitle)

Switch subtitle languages on/off (Page 22).

19 (INPUT SOURCE)*

Select an input source (Pages 19, 29, 48, 49, 52, 53, 70 and 71).

20 MENU/⏮ (Reveal hidden teletext)

Displays the menu screen (Page 15).

Teletext mode: Display hidden characters (Page 22).

21 RETURN/⏪ (Top/Bottom/Full)

Menu mode : Return to the previous menu screen (Page 15).

Teletext mode : Set the area of magnification (Page 22).

22 GUIDE/⏮ (Subpage)

DTV : To display EPG (Electronic Programme Guide) screen (Pages 24–27).

ATV : Display the channel list.

Teletext mode : Display the teletext subpage directly (Page 22).

23 CH/▲/▼

TV input mode : Select the channel (Page 18).

AQUOS.NET : Select the page (Page 58).

24 R/G/Y/B (Colour) buttons

The coloured buttons are correspondingly used to select the coloured items on the screen (e.g., AQUOS LINK, Multimedia, Home network, teletext).

25 DISPLAY

Display the channel or input information.

Reveal/hide the guide display for Multimedia mode (Pages 66–68).

26 AV MODE

Select audio/video settings (Page 37).

27 ECO

Select "Energy save" setting (Page 41).

28 SLEEP

Set the sleep timer.

NOTE

* "0 - 9", "↶", "↵" are used by string input like a mobile phone.

Quick guide

Inserting the CA card into the CI module

In order to receive coded digital stations, a common interface module (CI module) and a CA card must be inserted in the CI slot of the TV.

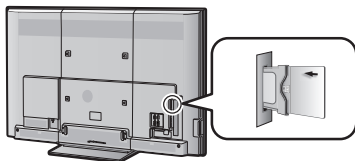

- 1 Carefully insert the CI module in the CI slot with the contact side forward.
- 2 The logo on the CI module must be facing outward from the rear of the TV.

● Checking CI module information

Go to “HOME” > “TV Menu” > “Setup” > “Option” > “CI setting” > “CI menu”.

- This menu is only available for digital stations.
- The content of this menu depends on the provider of the CI module.

Module

General information on CI module displays.

Menu

Adjustment parameters of each CA card displays.

Enquiry

You can input numerical values such as passwords here.

NOTE

- It takes a few minutes to certify the licence key when you insert a CA card into the CI+ compatible CI module for the first time. This process may fail when there is no antenna input or you have never run “Auto installation”.
- The CI+ compatible CI module sometimes upgrades its firmware. You may not receive any TV images before upgrading. You can only use the **POWER** during upgrading.
- Copy protected content may not be output or may be output with a copy control signal. The protect icon* is displayed when **INFO** is pressed while watching copy protected contents.
*Protect icon:
- If the TV displays an update confirmation message for the CA card while receiving CI+ compatible broadcasts, follow the screen prompts.
- Make sure that the CI module is properly inserted.
- If the old CAM is used, authentication may fail. In such cases, contact the contracted service provider.

Recording CAM PIN setting

When a CAM PIN code is required for recording a programme, it is necessary to enter the CAM PIN code in advance.

- 1 Go to “HOME” > “TV Menu” > “Setup” > “Option” > “CI setting” > “Recording CAM PIN setting”.
- 2 Enter the CAM PIN code.

NOTE

- If a PIN code is not entered or is entered incorrectly, the programme will not be able to be recorded/played back.
- Because recording is not possible when channel lock (page 44) and parental rating (page 45) settings are active, it is necessary to deactivate both of these settings.

CI plus 1.3 Standard

CI Plus is an advanced development of the DVB Common Interface Standard.

1 Regarding security

There are some regulations in recording functions. The playback of encrypted programmes is strongly dependent on which CA module is used. The playback of encrypted recordings may sometimes not be possible, or only during limited time. Programme providers, who use the CI Plus standard, can assign different rights for their broadcast programmes.

Exercise caution when using USB-recording to record broadcast programmes (Pages 51–65).

2 Operator service list management (Operator profile)

Under the 1.3 specification the CAM may provide the channel listing parameters (channel number, frequency etc.) and these can be updated while in use. Refer to “Operator profile” on page 21.

What is the HOME?

You can easily launch to enjoy Internet connection and Home network function and to perform settings for the TV from this "HOME" screen.

By connecting the TV to the internet you can enjoy a variety of broadband content.

Internet browsing on a TV behaves differently to a PC (Personal Computer). PC's have greater web browsing capabilities and memory plus support a wider range of functionalities and add ons – some PC viewing capability may not be possible on a TV. In such cases an application may close or an exclamation mark ("!") or an error message may be displayed.

To maximise the performance of YouTube content it is highly recommended that the user can access the content via the dedicated YouTube application on this TV.

Sharp recommends that from time to time you update your TV's software via the internet or by downloading updates onto a USB. Go to www.sharp.net.au and click on Customer Support, then follow the appropriate links.

Basic operation

1

Display/exit the HOME screen

Press **HOME** and the "HOME" screen displays. The operation will exit the "HOME" screen if you press **HOME** before it is completed.

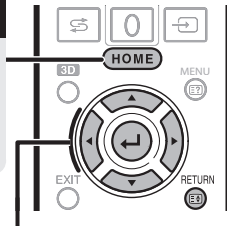

2

Select an item

Selecting in the HOME.

Press $\blacktriangle/\blacktriangledown/\blacktriangleleft/\blacktriangleright$ to select the desired service or menu, and then press \blacktriangleleft .

- AQUOS.NET**
By connecting the TV to the Internet (Page 58).
- Multimedia** (Page 65)
- Home network** (Page 65)
Record list (Page 63)
CH list (Page 19)
- Input change**
- YouTube™**
You can enjoy YouTube on your AQUOS.
- TV Menu**
Call up the OSD (On-screen Display) to perform settings for the TV. The OSD (On-screen Display) for the settings is called "TV Menu". The "TV Menu" enables various settings and adjustments.

NOTE: You can call up "TV Menu" screen by press **MENU**.



- Network setup** (Pages 54 – 56)
- IP Control** (Page 72)
- Display or Exit "LAN/Storage status"**
- Display or Exit "Menu status"**
- "LAN/Storage" or "Menu" status**

Regarding the instruction on the manual

On this manual, the following expression is often used in order to simplify instructions.

- Go to "HOME" > "TV Menu" > "Setup" > ...

This indicates how to navigate through the HOME screen using $\blacktriangle/\blacktriangledown/\blacktriangleleft/\blacktriangleright$ and \blacktriangleleft buttons.

Quick guide

Using software keyboard

Use the software keyboard when you need to input text.

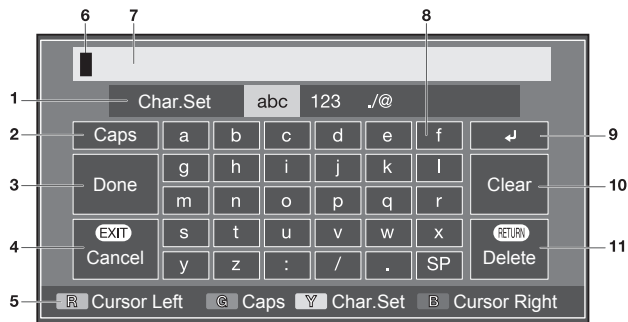

1 Char. Set

Changes character set into the alphabet, numbers, symbols, etc.

2 Caps

Changes characters to capital/lower case.

3 Done

Confirm the entry.

4 Cancel

Abort input and close the software keyboard.

5 R/G/Y/B (Colour) buttons

Selects the coloured items on the screen.

NOTE

- Depend on application, there might has a different software keyboard with above indication.

6 Input cursor

Press ◀▶ to move the cursor when highlighted.

7 Input field

The text you enter is displayed as you type it in.

8 Character

Input characters by using these buttons.

9

Put a line break.

10 Clear

Erases the character string.

- When the cursor is somewhere in a line: the character string to the right of the cursor will be erased.
- When the cursor is at the right end of a line: the entire line will be erased.

11 Delete

If the cursor is at the right end of a line, this erases text one character at a time.

- You can also delete text by pressing **RETURN** on the remote control unit.

Using software keyboard (Web browser)

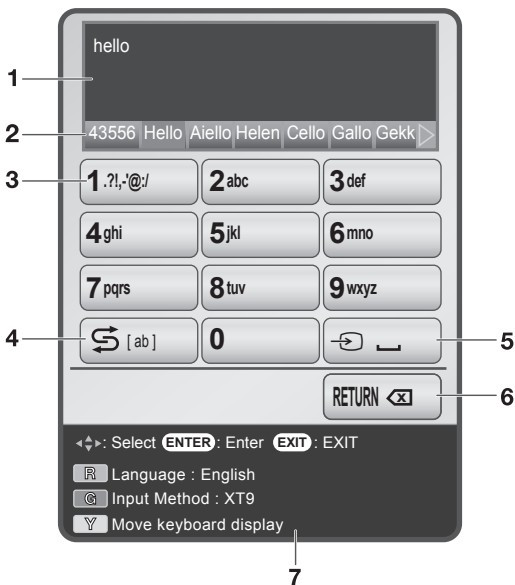

1 Input field

The text you enter is displayed as you type it in.

2 Input candidate

While you are entering text, likely input conversion candidates are displayed based on what you typed in.

- You can also enter text by pressing ▲/▼/◀▶ on the remote control unit.

3 0 – 9 keys

Input characters by using these buttons.

4 Shift key

Changes characters to capital/lower case by pressing ↺ on the remote control unit.

EXAMPLE

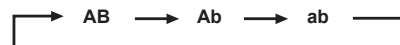

5 (space)

You can input a space by pressing ↵ on the remote control unit.

6 Back space key

Erases the character string by pressing **RETURN** on the remote control unit.

7 Key guidance

- Select the coloured item on the screen.

R : Language selection

G : Changes character set into the alphabet, numbers, symbol, etc.

Y : Changes the display position of the software keyboard.

NOTE

- If input method select to "XT9", a word can be inputted by few numbers with push a button.

For example input 「hello」

XT9 : 43556

ABC : 4433555 ▶ 555666

Watching TV

Daily operation

Turning on/off the power – using the control panel of the TV

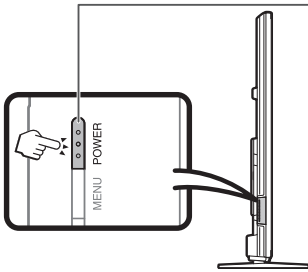

Turning on/off the power

- 1** Turn on the power.
Press **POWER** on the TV (after a few seconds, an image appears with sound).
 - Wait more than five seconds until you press **POWER** on the TV after inserting the power plug.
- 2** Turn off the power.
Switch it off by pressing **POWER** on the TV.

NOTE

- Weak electric power is still consumed even when the TV is turned off.

Turning on/off the power – using the remote control unit

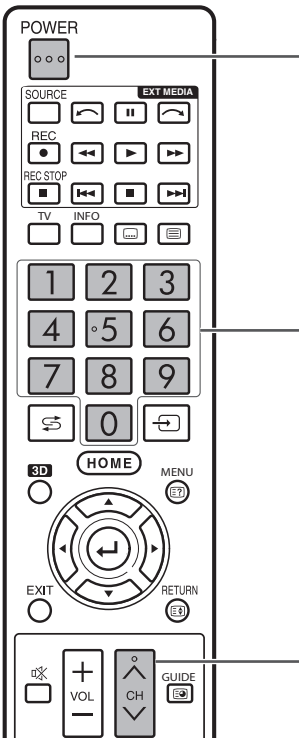

Standby mode

- 1** To standby mode.
If the TV is turn on, you can switch it to standby by pressing **POWER** on the remote control unit.
- 2** Switch on from standby.
From standby, press **POWER** on the remote control unit.

NOTE

- If you are not going to use this TV for a long period of time, be sure to remove the AC cord from the AC outlet.
- A small amount of electric power is still consumed even when the TV is turned off.

Changing channels

- 1** Turn on the power.
- 2** Select a programme using **0–9** numeric buttons or **CH** \wedge / \vee on the remote control unit.

NOTE

- You can also select a programme using **CH** \wedge / \vee on the TV control panel.

Operation without a remote control unit

You can operate the menu settings using the TV control panel.

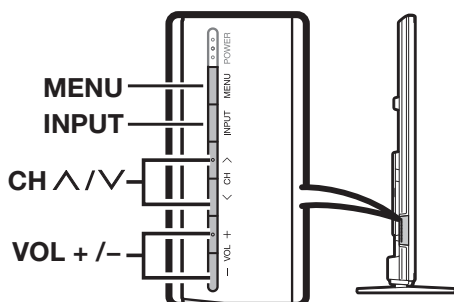

TV control panel buttons	Remote control buttons
MENU	MENU
INPUT	\leftarrow
CH \wedge / CH \vee	\blacktriangle / \blacktriangledown
VOL + / VOL -	\blacktriangleright / \blacktriangleleft

Watching TV

Watching TV (DTV only)



Press **TV** to change “DTV” or “ATV”.

NOTE

- When watching Digital Radio or Data broadcasting, the image is switched to DTV.
- When watching external video source, the image is switched to ATV or DTV, which was watched lastly.

CH list

You can check the CH list and view detailed information.

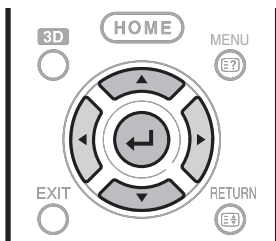

- 1 Press **↶** to display the CH list.
- 2 Press **▲/▼** to display your desired programme, and then press **↶**.
 - When you press **↶**, the TV jumps to the channel.

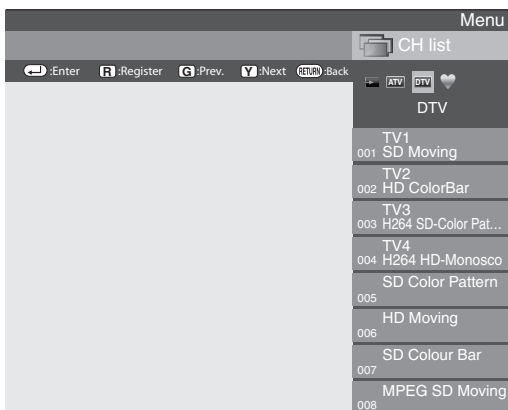

- 3 Press **↷** to switch broadcast or external video source.
 - Press **↶** to switch broadcast.
 - CH list, whose broadcast is watched, is displayed.

NOTE

- When you watch ATV, you can display channel list by **GUIDE**.

Programme information (DTV only)



While watching DTV you can check the extended programme information on the screen using **INFO** on the remote control.

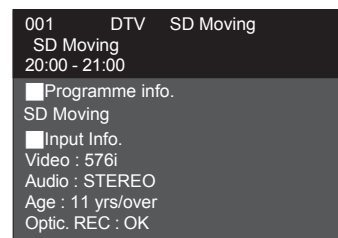

- If there is more information, pressing **↷** allows you to go to the next page or return to the previous page.
- You can cancel this info by pressing **INFO** again.

NOTE

- When you watch ATV, press **INFO** to display the channel information.

Using Info on the menu screen

Go to “HOME” > “TV Menu” > “Setup” > “Option” > “Option for view” > “Programme info.”.

Selecting an external video source

Once the connection is made, press **↷** to display the “INPUT” screen, and then press **↷** or **▲/▼** to switch over to the appropriate external source with **↶**.

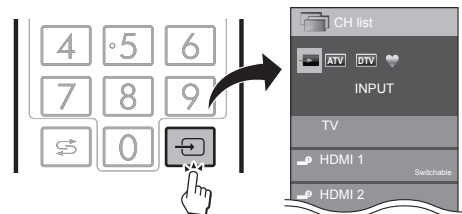

NOTE

- You can also select an external video source from “CH list” > “INPUT”.
- Only inputs which are not set for “Input skip” (Page 48) and properly connected inputs can be selected.

Watching TV

Switching the digital audio format (DTV only)

If multi sound modes are received, each time you press **MPX** the mode switches as follows.

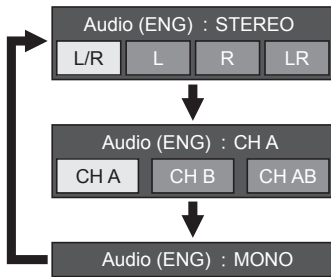

Press ◀▶ to select L or R sound when the STEREO or DUAL MONO screen is displayed.



NOTE

- The sound mode screen disappears in six seconds.
- Selectable items vary depending on the received broadcasts.
- The audio description sound is selected depending on the main audio.

Switching the analogue audio format

You can switch between multiple audio modes when watching a multiple audio or stereo broadcast programme.

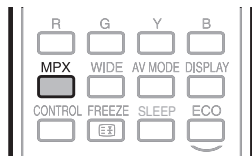

In the NICAM TV broadcasts

When receiving a stereo signal

Each time you press **MPX**, the mode switches between NICAM STEREO and MONO.

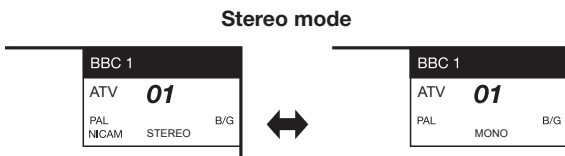

When receiving a bilingual signal

Each time you press **MPX**, the mode switches among NICAM CH A, NICAM CH B, NICAM CH AB and MONO.

Bilingual mode

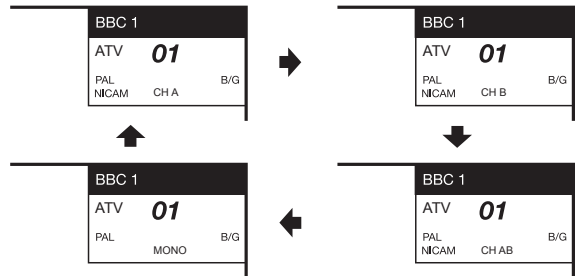

When receiving a monaural signal

Each time you press **MPX**, the mode switches between NICAM MONO and MONO.

Monaural mode

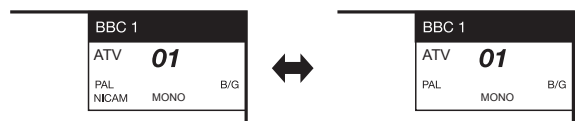

In the TV mode of A2 TV broadcasts

When receiving a stereo signal

Each time you press **MPX**, the mode switches between STEREO and MONO.

Stereo mode

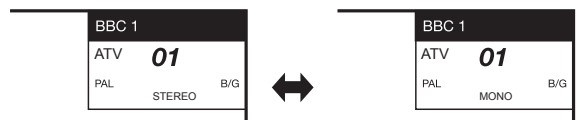

When receiving a bilingual signal

Each time you press **MPX**, the mode switches among CH A, CH B and CH AB.

Bilingual mode

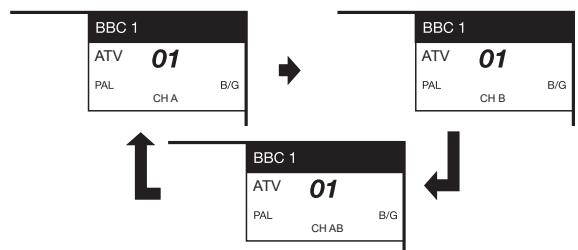

When receiving a monaural signal

When you press **MPX**, "MONO" displays.

Monaural mode

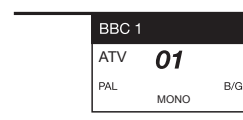

NOTE

- "BBC1", "01" and "PAL" are tentative network name, channel and colour system.

Favourite Channel Information

Before installation

This function allows you to group your favourite channels in a separate list. Pre-setting "My favourite" in advance allows you to select your favourite channels more conveniently.

NOTE

- "My Favourite" can only be used for DTV mode.
- The maximum number of channels you can register in "My favourite" is:
 - 50 for TV broadcast which will be allocated 001-050, as favourite channel numbers
 - 50 for Radio broadcast which will be allocated 051-100, as favourite channel numbers and
 - 50 for Data broadcast which will be allocated 101-150, as favourite channel numbers

How to add / remove / move your favourite channels

Press **←** to display the on-screen channel list.

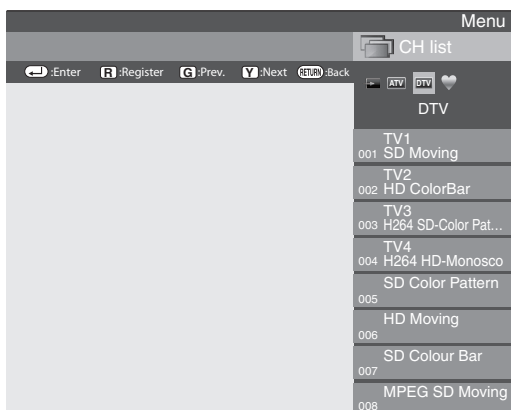

You can use the function buttons to edit highlighted channel from the channel list.

- If you have already set your favourite channels, you will be able to see "CH list" or "My favourite" depending on your previous selection.

Function buttons used to edit "My favourite"

Buttons	Description
R button	Add to "My favourite" list or remove from "My favourite" list. The "♥" mark will be added to or removed from the selected channel.
B button	Move channel position in "My favourite" list. ("My favourite" channel numbers will be sequentially allocated.)

NOTE

- If you delete a channel via the "Manual adjust" option ("HOME" > "TV Menu" > "Setup" > "View setting" > "Channel settings" > "Programme setup" > "Digital setting" > "Manual adjust"), this will be deleted from both the "CH list" and "My favourite" list.

Selecting channels from "My favourite" list

- 1 How to move between "My favourite" list and "CH list".
 - ① Press **←** when you watching DTV to bring up the "CH list".
 - ② Press **▶** and select ♥ "My favourite" list.
- 2 Move up and down the displayed channel list using **▲/▼** then press **←** to select the desired channel.

NOTE

- When watching your favourite channels via "My favourite" list, you can directly select other favourite channel by entering the favourite channel number on the remote control.
- Selecting the EPG function while using "My favourite" channel list, will only show details for the favourite channels you have added. (To view details of all available channels via the EPG, please switch back to "CH list" mode from "My favourite" by following the steps shown in 1 (①) and reselect "CH list" before pressing **GUIDE**.)

Operator profile

In case your CI Plus CAM supports Operator profile, your CAM will inform you and guide you through the Operator profile installation.

When operator's profile is added by the CAM, it will be displayed in the CH list menu. Each profile will be stored as an independent list in the TV.

You can delete operator profile you added.

Go to "HOME" > "TV Menu" > "Setup" > "View setting" > "Channel settings" > "Programme setup" > "Operator profile management".

NOTE



- The TV supports 2 operator profiles.
- Operator profile can have mixed services such as T/C/S1/S2/S3/S4, but will only be displayed based on the network and media type you select.

Teletext

What is teletext?

Teletext broadcasts pages of information and entertainment to specially equipped TV. Your TV receives teletext signals broadcast by a TV network, and decodes them into graphical format for viewing. News, weather and sports information, stock exchange prices and programme previews are among the many services available.

Turning teletext on/off

- 1 Select a TV channel or external source providing a teletext programme.
- 2 Press  to display the teletext.
- 3 Press  again to display the teletext on the right screen and the normal image on the left screen.
 - Many stations use the TOP operating system, while some use FLOF (e.g., CNN). Your TV supports both these systems. The pages are divided into topic groups and topics. After switching on the teletext, up to 2,000 pages are stored for fast access.
 - If you select a programme with no teletext signal, "No Teletext available" displays.
 - The same message displays during other modes if no teletext signal is available.









- Each time you press , the screen switches as shown above.

NOTE

- Teletext will not work in 3D mode.

Buttons for teletext operations

Buttons	Description
CH \wedge /V	Increase or decrease the page number.
Colour (R/G/Y/B)	Select a group or block of pages displayed in the coloured brackets at the bottom of the screen by pressing the corresponding colour (R/G/Y/B) on the remote control unit.
Numeric buttons 0-9	Directly select any page from 100 to 899 by using the 0-9 numeric buttons.
 (Reveal hidden teletext)	Reveal or hide hidden information such as an answer to a quiz.
 (Freeze/ Hold)	Stop updating teletext pages automatically or release the hold mode.
 (Subtitle for teletext)	Display the subtitle or exit the subtitle screen. Subtitles will not be displayed when the service does not contain subtitle information.
 (Subpage)	Reveal or hide subpages. Selects directly the desired subpage (0-9). <ul style="list-style-type: none"> • Move to the previous subpage (R). • Move to the following subpage (G). • These two buttons are shown on the screen by the symbols "+" and "-".
 (Top/ Bottom/Full)	Switch the Teletext image to Top, Bottom or Full.
	Display the top menu. <ul style="list-style-type: none"> • The top menu will not be displayed when the service does not support top menus.



View setting

Text language

If Teletext information does not display correctly, perform the procedure below.

Select from among six kinds of language tables: West Europe, East Europe, Greek/Turkish, Cyrillic, Arabic and Farsi.

Each table is compatible with the Teletext languages listed below.

- 1 Go to "HOME" > "TV Menu" > "Setup" > "View setting" > "Individual setting" > "Text language".



- West Europe — English, French, Scandinavian, Turkish, German, Spanish, Italian
- East Europe — Polish, French, Scandinavian, Czech, German, Slovenian/Croatian, Italian, Rumanian
- Greek/Turkish — English, French, Scandinavian, Turkish, German, Spanish, Italian, Greek
- Cyrillic — English, Russian, Estonian, Czech, German, Slovenian/Croatian, Ukrainian, Lettish
- Arabic — English, French, Scandinavian, Turkish, German, Hebrew, Italian, Arabic
- Farsi — English, French, Scandinavian, Turkish, German, Hebrew, Italian, Farsi

NOTE





- Teletext can be displayed only when it is sent by a network. Not used to convert between languages.



View setting

Initial teletext page (DTV only)

If you set the language of the initial page (this page is displayed for the first time after pressing ) for teletext in DTV mode, it will start from the selected language page.

- 1 Go to “HOME” > “TV Menu” > “Setup” > “View setting” > “Individual setting” > “Initial teletext page”.
- 2 Press /// to select the desired language, and then press .

NOTE

- This function is available for teletext in DTV mode. This is not available for teletext in ATV or external input mode.
- If the initial teletext page of the selected language in this function is not included in a received broadcast, the default initial page will be displayed.



View setting

MHEG-5 (EPG) (DTV only)

This function is set to enable MHEG-5 in DTV mode.

Go to “HOME” > “TV Menu” > “Setup” > “View setting” > “Individual setting” > “MHEG-5 (EPG)”.

Item	
Enable	MHEG-5 is displayed during DTV mode.
Disable	MHEG-5 is not displayed during DTV mode.

NOTE

- This function is only displayed for models for the New Zealand market. This function is not displayed for models for the other market than “New Zealand”.
- When the country setting is set to “New Zealand” in the initial auto installation, this function is available. When the country setting is set to countries other than “New Zealand”, then this item is grayed out and cannot be selected.
- The MHEG-5 is not displayed when there is no MHEG-5 information on broadcast in setting this function to “Enable”.
- When this function is set to “Enable”, subtitles may not be displayed. If this occurs, set to “Disable” and then display of subtitles will be possible.

Watching TV

EPG (DTV only)

EPG is a programme list that is displayed on the screen. With the EPG, you can check the schedule of DTV/RADIO/DATA, view detailed information about them, tune to an event currently on-air.

Useful settings for using EPG

Basic setting



View setting

EPG

If you want to use the EPG for digital stations, select "Yes". The EPG data must be automatically captured while the TV is in standby mode. After setting to "Yes", it may take some time to turn off the power using the remote control unit or the TV due to the data capture process.

Go to "HOME" > "TV Menu" > "Setup" > "View setting" > "Individual setting" > "Standby search" > "EPG".

- Selecting EPG to "Yes" will result in higher power consumption*.
- Selecting EPG to "No" will save power consumption.

NOTE

* Approximately 24W or more for 15-30 minutes (depending on number of channels tuned) after power off from remote control.

If you connect additional peripherals eg. USB / HDMI, the power consumption could rise to 50W.

- EPG data will not update if the TV is turned off from the power switch at the TV control panel.
- "EPG" cannot be selected when the country setting is set to "New Zealand".

EPG display settings



Option

Display range setup

The "Display range setup" allows you to select three types of time spans for display on the screen.

Go to "HOME" > "TV Menu" > "Setup" > "Option" > "EPG setup" > "Display range setup".

Item	
Mode 1 (Wide angle)	Displays six hours of programme information.
Mode 2 (Zoom)	Displays three hours of programme information.
Mode 3 (Vertical angle)	Changes to the EPG display format with a vertical time span.

NOTE

- "Display range setup" cannot be selected when the country setting is set to "New Zealand".



Option

Genre icon setup

You can grey out or place a mark on desired genres and smoothly search for programmes you frequently watch.

- 1 Go to "HOME" > "TV Menu" > "Setup" > "Option" > "EPG setup" > "Genre icon setup".
- 2 Press ▲/▼ to select the desired genre, and then press ←.

● Genre icon list

Genre icon list for Australia

Icon	Genre	Icon	Genre
	Movie		Current affairs
	News		Education/Information
	Entertainment		Infotainment
	Sport		Special
	Children's		Comedy
	Music		Drama
	Arts/Culture		Documentary

Genre icon list except Australia

Icon	Genre	Icon	Genre
	Movie/Drama		Music/Ballet/Dance
	News/Current affairs		Arts/Culture (without music)
	Show/Game show		Social/Political issues/Economics
	Sports		Education/Science/Factual topics
	Children's/Youth programmes		Leisure hobbies

- 3 Press ▲/▼ to select a level to pick out or search for programmes you want to watch ("Standard", "Light", "Remark").

Selecting a programme using EPG (DTV only)

Basic operation

● Display the EPG screen

Press **GUIDE**.

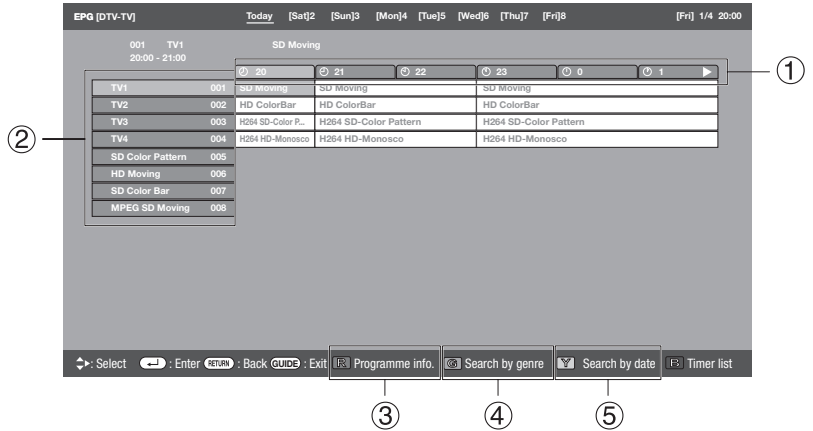
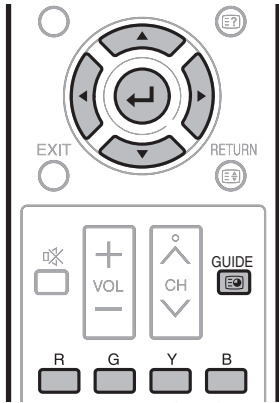

● Display the EPG screen

① Press ◀▶ to select the time span you want to search.

- Continue to press ▶ to display programmes in the next time span.

② Press ▲/▼ to select the desired programme.

- If ▲ or ▼ are displayed on the left of the services, continue to press ▲/▼ to display next or previous screen.

● Close the EPG screen

Press **GUIDE** again.

NOTE

- You can also display the EPG screen from "HOME" > "TV Menu" > "EPG" > "EPG".
- The time displayed on the EPG is information sent by the TV station.
- When the country setting is set to "New Zealand", the EPG screen and operation differ due to the use of MHEG-5 EPG. The EPG screen and operation vary depending on the broadcasts.
- When the country setting is set to "New Zealand", the EPG function is not available when MHEG-5 EPG is not broadcasted.
- MHEG-5 EPG may not be displayed properly in the 3D mode. If so, cancel the 3D mode and then MHEG-5 EPG will be available.
- The MHEG-5 EPG function is not available for models for the market other than New Zealand.

Selecting a programme

③ Check programme information

- 1 Press ▲/▼/◀▶ to select the programme you want to check.
- 2 Press R.

NOTE

- When the country setting is set to "New Zealand", this function is not available due to the use of MHEG-5 EPG.

Programme information



- 3 Press ◀ to tune to the selected programme.

Watching TV

④ Search a programme in a category

- 1 Press **G**.
- 2 Press **▲/▼** to select the desired genre, and then press **←.↓**.
- 3 Press **▲/▼** to select a programme you want to watch, and then press **←.↓**.

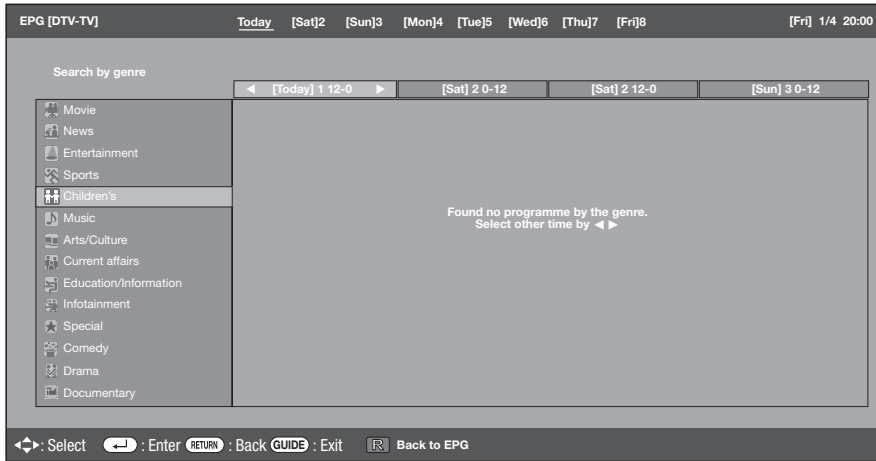

NOTE

- The genre information depends on the broadcasts.
- You can also display the EPG screen from "HOME" > "TV Menu" > "EPG" > "Search by genre".
- When the country setting is set to "New Zealand", this function is not available due to the use of MHEG-5 EPG.

⑤ Search for a programme by date/time

- 1 Press **Y**.
- 2 Press **◀/▶** to select the desired time span and then press **←.↓**.



- 3 Press **▲/▼** to select the desired programme, and then press **←.↓**.

NOTE

- When you select a programme outside of the current time span, the timer setting screen displays (Page 27).
- You can also display the EPG screen from "HOME" > "TV Menu" > "EPG" > "Search by date".
- When the country setting is set to "New Zealand", this function is not available due to the use of MHEG-5 EPG.

⑥ Display the timer list for TV programmes

Press **B**.

- Refer to page 27 for the timer setup.

Watching TV

Timer setup using EPG

The TV can be switched to a programme or start recording for USB-recording at the set time.

- 1 Press **GUIDE**.
- 2 Press **▲/▼/◀/▶** to select the programme you want to set, and then press **↵**.
- 3 Press **◀/▶** to select "Watch" or "Record", and then press **↵**.
 - If you select "No", the TV returns to the EPG screen.



- 4 Press **◀/▶** to select "Yes", and then press **↵**.
 - The selected TV programme is marked with an icon.
- 5 Press **↵** to select "Back".

NOTE

- You cannot select "Record" when the registered USB HDD is not connected to the USB port.
- A combined total of 16 timer settings ("Watch" and "Record") can be set.

*Important information:

A CAM (CI Plus v1.3) PIN code may be necessary to record broadcasts scrambled due to parental rate settings.

When a CAM PIN code is required for recording a programme, it is necessary to enter the CAM PIN code in advance (Page 14).

If a CAM PIN code is not entered or is entered incorrectly, the programme may not be able to be recorded/played back.

Cancelling the timer setup

- 1 Press **GUIDE**.
- 2 Press **▲/▼/◀/▶** to select the programme with timer setup, and then press **↵**.
- 3 Press **◀/▶** to select "Cancel", and then press **↵**.
- 4 Press **◀/▶** to select "Yes", and then press **↵**.













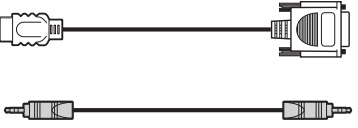

● Cancelling using B button on the remote control unit

- 1 Press **GUIDE**.
- 2 Press **B** to display the timer setup list.
- 3 Press **▲/▼** to select the programme you want to cancel timer setup, and then press **↵**.
- 4 Press **◀/▶** to select "Cancel", and then press **↵**.
- 5 Press **◀/▶** to select "Yes", and then press **↵**.

Connecting external devices

● Before connecting ...

- Be sure to turn off the TV and any devices before making any connections.
- Firmly connect a cable to a terminal or terminals.
- Carefully read the operation manual of each external device for possible connection types. This also helps you get the best possible audiovisual quality to maximise the potential of the TV and the connected device.
- Refer to page 70 for connecting a PC to the TV.

Connection cable (Connection code)	Image quality/ Audio quality	Connectable devices	Reference page
HDMI cable ※ 	Excellent in both image quality and audio quality	 Reproduction devices such as a DVD player	29
DVI/HDMI cable/3.5 mm stereo minijack cable 	Good image quality	 Game console	
Component cable  Audio cable 	Average in both image quality and audio quality	 Reproduction devices such as a DVD player	30, 48
AV cable (Supplied)  AV cable 	Average in both image quality and audio quality	 Reproduction devices such as a DVD player  Game console	30, 48
Optical audio cable 	Excellent in audio quality	 Audio equipment	31
Stereo conversion cable 	Average in audio quality		

※ NOTE

- When connecting 4K (3,840 x 2,160 (Ultra HD) 30Hz, 25Hz, 24Hz) equipment to the TV, use the HDMI 1,2,3,4 terminal and use HDMI cable of High speed type.

Connecting external devices

Video connections

HDMI connection

Example of connectable devices

- DVD player/recorder
- Blu-ray player/recorder
- Game console

The HDMI connections permit digital video and audio transmission via a connection cable from a player/recorder. The digital picture and sound data are transmitted without data compression and therefore lose none of their quality. Analogue/digital conversion is no longer necessary in the connected devices, which also would result in quality losses.

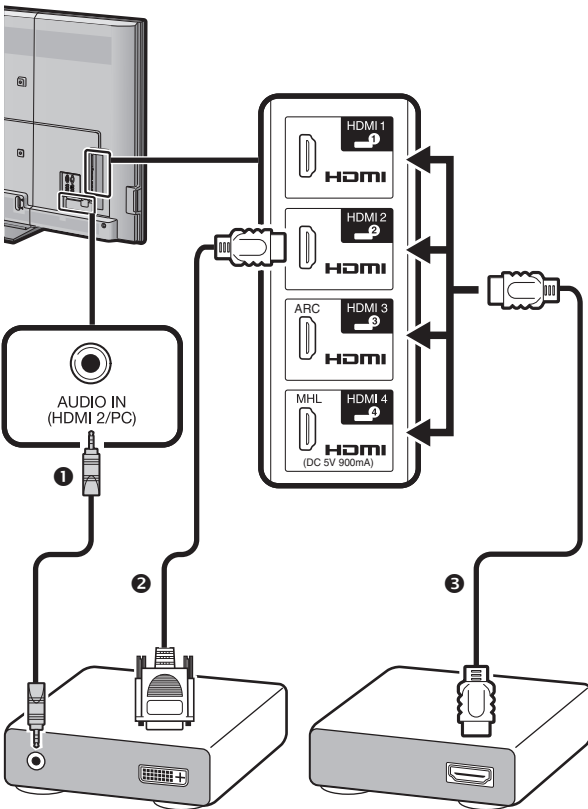

- 1 ϕ 3.5 mm stereo minijack cable (commercially available)
- 2 DVI/HDMI cable (commercially available)
- 3 HDMI-certified cable (commercially available)

DVI/HDMI conversion

Using a DVI/HDMI cable, the digital video signals of a DVD can also be played via the compatible HDMI connection. The sound must be fed in additionally.

- When connecting a DVI/HDMI cable to the HDMI terminal, the image may not come in clearly.
- Both HDMI and DVI use the same HDCP copy protection method.

When using the HDMI 2 terminal

You must set the audio signal input source depending on the type of HDMI cable connected (refer to page 48 for details).

HDMI-certified cable

- 1 Press \rightarrow to select "HDMI2" from the "INPUT" menu, and then press \leftarrow .
- 2 Go to "HOME" > "TV Menu" > "Setup" > "Option" > "Terminal setting" > "Audio select" > select "HDMI".

DVI/HDMI cable

- 1 Press \rightarrow to select "HDMI2" from the "INPUT" menu, and then press \leftarrow .
- 2 Go to "HOME" > "TV Menu" > "Setup" > "Option" > "Terminal setting" > "Audio select" > select "HDMI + Analogue".

NOTE

- If a connected HDMI device is AQUOS LINK compatible, you can take advantage of versatile functions (Pages 32-35).
- Video noise may occur depending on the type of HDMI cable used. Make sure to use a certified HDMI cable.
- When playing the HDMI image, the best possible format for the picture will be detected and set automatically.
- An ARC (Audio Return Channel) compatible audio receiver must be connected to the HDMI 3 terminal with an ARC-compatible cable.
- All HDMI terminals support 3D image signals.
- HDCP 2.2 copy protected signal can be viewed via HDMI 1 terminal only.

Supported video signal

576i, 576p, 480i, 480p, 1080i, 720p, 1080p, 2160p. See page 71 for PC signal compatibility.

NOTE

- When connecting 4K (3,840 x 2,160 (Ultra HD) 30Hz, 25Hz, 24Hz) equipment to the TV, use the HDMI 1,2,3,4 terminal and use HDMI cable of High speed type.

Supported audio signal

Linear PCM, sampling rate 32/44.1/48kHz. Dolby Digital, DTS.

Connecting external devices



Component connection

Example of connectable devices

- VCR
- DVD player/recorder

You will enjoy accurate colour reproduction and high quality images through the INPUT 6 terminal when connecting a DVD player/recorder or other device.

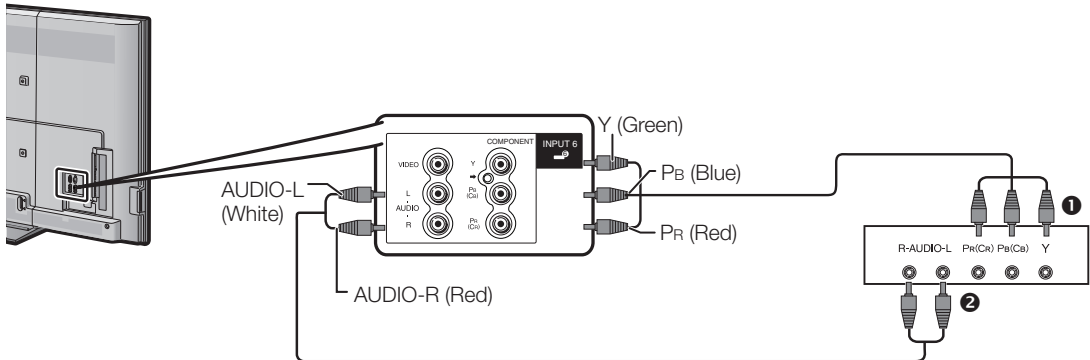

- ❶ Component cable (commercially available)
- ❷ Audio cable (commercially available)



VIDEO connection

Example of connectable devices

- VCR
- DVD player/recorder
- Game console
- Camcorder

You can use the INPUT 5 or INPUT 6 terminal when connecting to a game console, camcorder, a DVD player/recorder or other device.

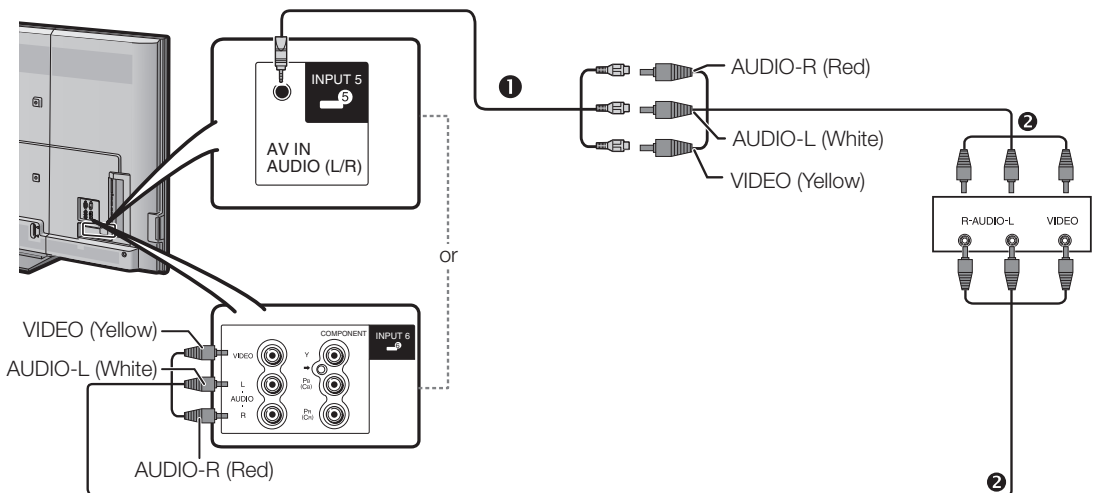

- ❶ AV cable (supplied accessory)
- ❷ AV cable (commercially available)

Connecting external devices

Audio connections

Speaker/amplifier connection

Connect an amplifier with external speakers as shown below.

● Connecting an amplifier with digital/analogue audio inputs

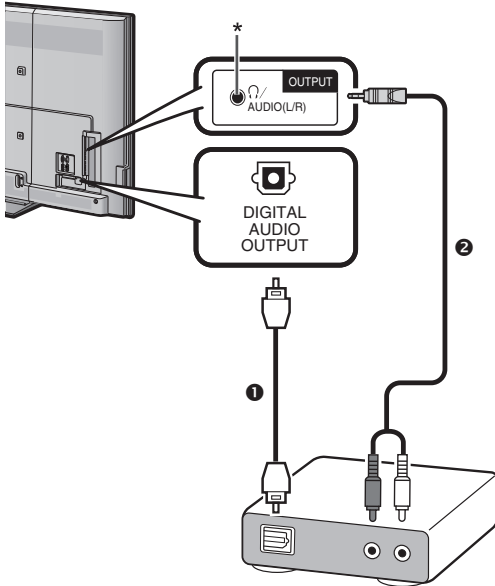

- ❶ Optical audio cable (for digital audio) (commercially available)
- ❷ Stereo conversion cable (for analogue audio) (commercially available)

* This terminal is also used for headphones. Reduce the volume before using headphones. Overwhelming sound may damage your hearing.

Notice

When connecting an optical audio cable to the DIGITAL AUDIO OUTPUT terminal, check the direction carefully, and insert it straight in while aligning the bottom side. Forcing it could cause damage to the terminal.

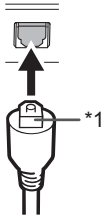

(*1)
Turn the flat surface aligning the jack shape and insert it straightly.

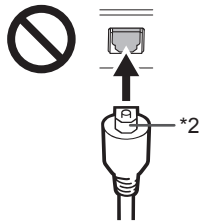

(*2)
Do not insert upside-down.

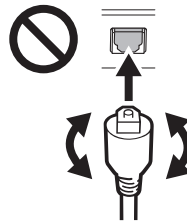

Do not twist when inserting.

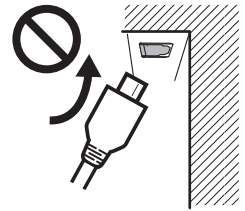

(Drawing from a side view)
Do not insert sideways.

NOTE

- If the image is not in sync with the audio, check the settings of the connected surround system.

● After connecting

Digital audio output setting

After connecting an amplifier with digital audio input and external speakers as shown, you should set an audio output format compatible with the programme you are watching or the device connected.

Go to "HOME" > "TV Menu" > "Setup" > "Option" > "Terminal setting" > "Digital audio output" > select "PCM" or "Bitstream".

NOTE

- When set to "Bitstream", Dolby Digital is output when the Dolby Digital or Dolby Digital Plus audio formats are received. When set to "PCM", PCM is output no matter what audio formats are received.
- When set to "Bitstream", HE-AAC audio formats can be output as Dolby Digital.
- When set to "Bitstream", Dolby Digital Plus can be output as Dolby Digital.

Controlling HDMI devices using AQUOS LINK

● What is AQUOS LINK?

Using the HDMI CEC protocol, with AQUOS LINK you can interactively operate compatible system devices (AV amplifier, DVD player/recorder, Blu-ray player/recorder) using a single remote control unit.

By connecting AQUOS LINK-compatible devices with HDMI-certified cables to the TV, you can control a recorder or AV amplifier using the remote control of the TV.

NOTE

- AQUOS LINK-compatible AQUOS AUDIO speaker system and AQUOS recorder are scheduled to be on sale after the release of this TV.
- AQUOS LINK does not work while using USB-recording functions.

● What you can do with AQUOS LINK

✓ One touch recording (DTV only)

You do not have to search for the remote control unit of your recording device. Press **REC** ● or **REC STOP** ■ to start/stop recording what you see on the recorder.

✓ One touch play

When the TV is in standby mode, it will automatically turn on and play back the image from the HDMI source.

✓ Operating title list of external devices

In addition to displaying the TV's own timer list (Page 26), you can also call up the external player's top menu or AQUOS BD player's/AQUOS recorder's title list provided that the devices support AQUOS LINK.

✓ Controlling the AQUOS LINK-compatible audio system

You can adjust the volume and select the sound mode of the AQUOS LINK-compatible audio system.

✓ Multiple control of HDMI devices

You can select which HDMI device to operate using the "Link operation" menu.

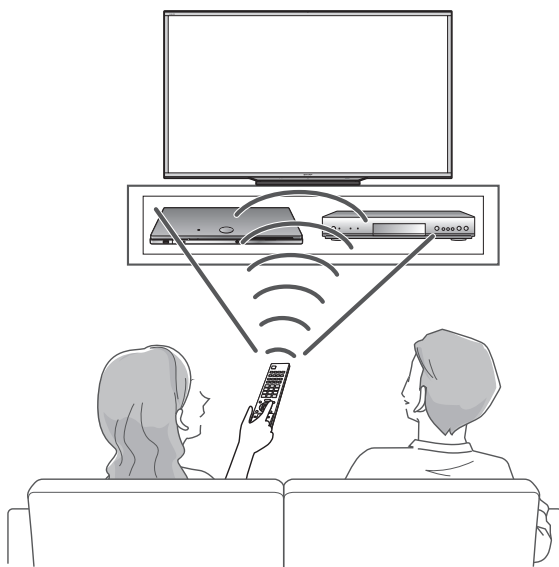

✓ Single remote control operation

AQUOS LINK automatically recognises connected HDMI devices and you can control the TV and the devices as if using a universal remote control unit.

NOTE

- When you use AQUOS LINK, make sure to use a certified HDMI cable.
- Point the remote control unit toward the TV, not to the connected HDMI device.
- Video noise may occur depending on the type of HDMI cable used. Make sure to use a certified HDMI cable.
- Up to three HDMI recording devices, one AV amplifier and three players can be connected using this system.
- These operations affect the HDMI device selected as the current external source. If the device does not operate, turn on the device and select the appropriate external source using .
- When you insert/remove HDMI cables or change connections, turn on all connected HDMI devices before turning on the TV. Confirm that picture and audio are correctly displayed/output by selecting "HDMI1", "HDMI2", "HDMI3" or "HDMI4" from the "INPUT" menu.

AQUOS LINK connection

First connect the AQUOS AUDIO speaker system or an AQUOS BD player/AQUOS recorder that supports the HDMI CEC protocol.

NOTE

- Refer to the operation manual of the device to be connected for further details.
- After unplugging connection cables or changing the connection pattern, turn on the power of the TV after all relevant devices' power have been turned on. Change the external input source by pressing , select the appropriate external source and verify the audiovisual output.

Connecting an AQUOS BD player/AQUOS recorder via the AQUOS AUDIO speaker system

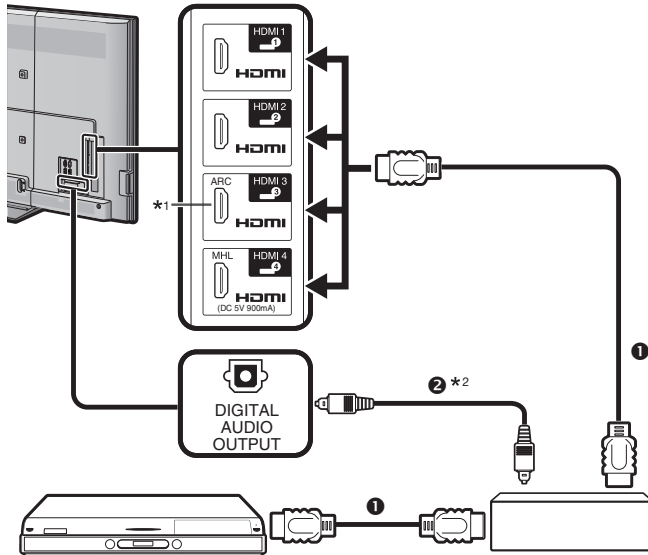

AQUOS BD player/AQUOS recorder

AQUOS AUDIO speaker system

① HDMI-certified cable
(commercially available)

② Optical audio cable
(commercially available)

*1 The ARC (Audio Return Channel) function works only when using the HDMI3 terminal.

*2 When you use an audio system compatible with the ARC function of the TV, you do not need to connect an optical audio cable to the TV.

Connecting an AQUOS BD player/AQUOS recorder only

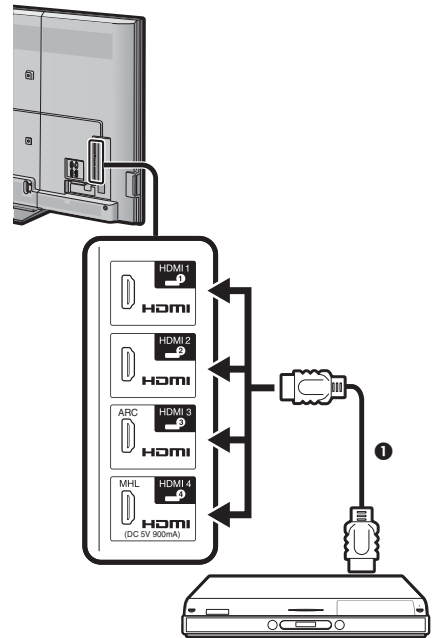

AQUOS BD player/AQUOS recorder

Regarding "Select recording device"

Select the device for recording from connected devices.

NOTE

- This function enables you to select either the USB HDD for USB-recording use or the HDMI device with CEC protocol.

- 1 Go to "HOME" > "TV Menu" > "Setup" > "View setting" > "Select recording device".
- 2 Select the device for recording using the **REC** ● on the remote control unit.
 - Select "USB-HDD" when using the **REC** ● for USB recording.
 - Select "HDMI device" when using the **REC** ● for recording to the HDMI device.
- 3 Press **RETURN** to end the operation.

Operating an AQUOS LINK device

AQUOS LINK allows you to operate the HDMI-connected device with a single remote control unit.

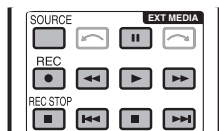

Use the following procedure to start playback.

- 1 Press **▶** to start playback of a title.
 - See the section **Top menu/title list** if you want to start playback using the list of the titles in the AQUOS BD player/AQUOS recorder.
- 2 Press **▶▶** to fast forward.
 Press **◀◀** to reverse.
 Press **■** to stop.
 Press **||** to pause.
 Press **◀◀◀** to skip to previous chapter.
 Press **▶▶▶** to skip to next chapter.
 Press **SOURCE** to turn the HDMI-connected device on/off.

Use the following procedure to start recording.

- Check the following items before recording.
- Make sure the antenna cable is connected properly.
 - Check if the recording media (HDD, DVD, etc.) has enough capacity for recording a programme.
 - Select the equipment for recording in Selecting Recorder.
- 1 After you selected recording media (HDD, DVD, etc.) in the menu, please make sure the recording menu in the ready condition.
 - 2 Press **REC** **●** to start recording.
 - 3 Press **REC STOP** **■** to stop recording.

AQUOS LINK menu

Go to "HOME" > "TV Menu" > "Link operation" > select the menu you want to set.

Link Operation	Description	Note
Recorder power on/off	This function is for turning of the CEC-compatible recorder on/off. Every time you press ↵ in "Recorder power on/off", the CEC-compatible recorder will be turned on/off.	<ul style="list-style-type: none"> • Refer to the operation manual of the recorder for details.
Top menu/title list	This section explains how to play back a title in the AQUOS BD player/AQUOS recorder. Press MENU to hide the menu screen to operate ▲/▼/◀▶ buttons. Select the title with ▲/▼/◀▶ , and then press ▶ (PLAY).	<ul style="list-style-type: none"> • The linked recorder now powers on and the TV automatically selects the appropriate external input source. • The title list data from the connected AQUOS BD player/AQUOS recorder displays.
Setup menu	You can call up the menu of an HDMI CEC-compatible external device (player, recorder, etc.) using the "Setup menu" function.	<ul style="list-style-type: none"> • If a connected device does not have this function or the device is in a status where the menu cannot be displayed (recording, entering standby, etc.), this function may not be available.
Media change	If your recorder has multiple storage media, select the media type here. Select the desired medium, such as DVD recorder or HDD. The media type changes every time you press ↵ .	
Recorder EPG	You can call up the CEC-compatible recorder's EPG and preset timer recordings using the TV's remote control. Select the programme to record.	<ul style="list-style-type: none"> • The external input source switches and the recorder's EPG is displayed. • You can use ▲/▼/◀▶, RETURN, EXIT and the coloured buttons. • Refer to the operation manual of the recorder for details.
Change audio output device	You can choose to listen to the TV sound only from the AQUOS TV speaker system.	
Sound mode change	You can manually change the AQUOS AUDIO speaker system's sound mode. The sound mode changes every time you press ↵ .	<ul style="list-style-type: none"> • Refer to the operation manual of the AQUOS AUDIO speaker system for details.
Model select	If multiple HDMI devices are connected in a daisy chain, you can specify which device to control here. The HDMI device changes every time you press ↵ .	
AQUOS LINK setup ➡	See page 35 for details.	

AQUOS LINK

AQUOS LINK control	Set to "On" to enable HDMI CEC functions.	
Auto power on	If this is activated, the one touch play function is enabled. While the TV is in standby mode, it automatically turns on and plays back the image from the HDMI source.	<ul style="list-style-type: none"> The factory default for this item is "Off".
Selecting recorder	Here, you can select a recorder for the recording from several connected recorders.	<ul style="list-style-type: none"> If you have connected the AQUOS AUDIO speaker system between the TV and an AQUOS recorder, the external source's indication changes (e.g., from "HDMI1" to "HDMI1 (Sub)").
Selecting channel key	This function allows you to select the channel of the connected HDMI device using the TV's remote control unit. Press ▲/▼ to select the input source of the connected HDMI device you want to control using the TV's remote control unit, and then press ←↓. Press ◀/▶ to select "On", and then press ←↓.	
Using genre info.	This function allows you to automatically switch to the appropriate sound mode depending on the genre information included the digital broadcast.	
Audio return channel	If this function is set to "Auto", the TV can send audio data for video content shown on the TV to a connected audio device with just one ARC-compatible cable. Using this function eliminates the need to use a separate digital or analogue audio cable.	<ul style="list-style-type: none"> The ARC (Audio Return Channel) function works only when using the HDMI 3 terminal.

Connection for using "Audio return channel"

- You need to use ARC-compatible cables/devices and connect to the HDMI3 terminal to activate this function. The connection method is the same as **Connecting an AQUOS BD player/AQUOS recorder via the AQUOS AUDIO speaker system** (Page 33).

Using a Smartphone with the TV

This function enables you to connect the TV to a smartphone that supports Mobile High-Definition Link (MHL) using an MHL-compatible cable.

To connect the TV to your MHL-compatible smartphone, be sure to use an MHL-compatible cable (commercially available).

- You can view pictures and video on a large screen.
- You can play back music files.

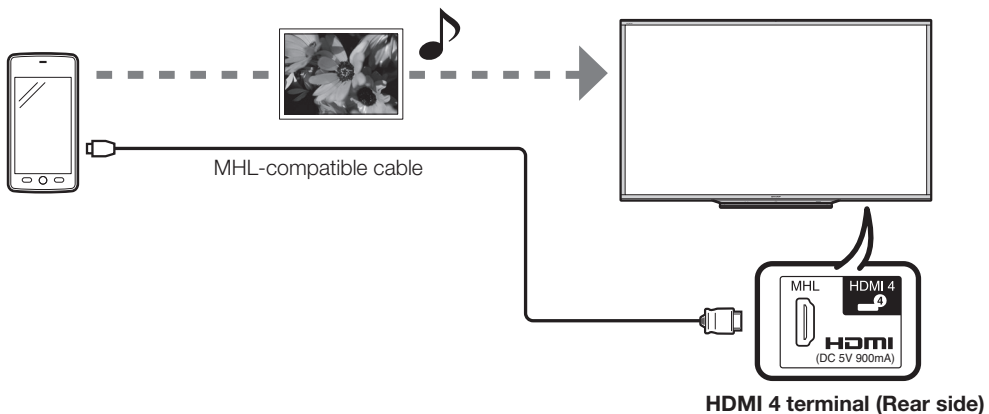

NOTE

- An MHL-compatible portable device is required to use this function. Connect the device to the HDMI 4 terminal.
- This production incorporates MHL 1.



● Auto power on

When an MHL-compatible device is connected to the TV, the TV turns on automatically.

- This function operates when "AQUOS LINK control" is set to "On". (See page 35.)

● Auto input selection

When an MHL-compatible device is connected while the TV is on, the input mode is selected automatically.

- This function operates when "AQUOS LINK control" is set to "On". (See page 35.)

● Operation Using the Remote Control

The remote control of the TV can be used to operate a portable device.

- ▲/▼/◀/▶, ←, EXIT, 0-9, etc.
- The operations vary depending on the connected equipment and content being viewed.

Basic adjustment

Picture settings

Go to "HOME" > "TV Menu" > "Setup" > "Picture".



NOTE

- After selecting a menu such as "AV mode", "Clear Picture Processing", "OPC", "Backlight", "Contrast", "Brightness", "Colour", "Tint" and "Sharpness", you can adjust while viewing more of the screen area by pressing \leftarrow to make the menu smaller.
- For resetting all adjustment items to factory preset values, press $\blacktriangle/\blacktriangledown$ to select "Reset", press \leftarrow , press $\blacktriangle/\blacktriangledown$ to select "Yes", and then press \leftarrow .

Picture AV mode

"AV mode" gives you several viewing options to choose from to best match the system environment, which can vary due to factors like room-brightness, type of programme watched or the type of image input from external equipment.

Press $\blacktriangle/\blacktriangledown$ to select the desired mode, and then press \leftarrow .

- You can also switch the mode on the "Picture" and "Audio" menu screen by pressing **AV MODE**.

Item	
AUTO	The TV automatically sets the appropriate selection from the "AV mode" menu depending on the lighting conditions and the type of programme watched.
STANDARD	For a highly defined image in a normally bright room.
MOVIE	For viewing a movie in a darkened room.
GAME	For playing of video games.
PC*1	For PC.
USER	Allows you to customise settings as desired. You can set the mode for each input source.
DYNAMIC	For a clear-cut image emphasising high contrast for sports viewing.
DYNAMIC (Fixed)	For a clear-cut image emphasising high contrast for sports viewing (the "Picture" and "Audio" settings cannot be adjusted).
STANDARD (3D)	Refer to page 80 for details.
GAME (3D)	

NOTE

- *1 "PC" is available only when selecting "HDMI1", "HDMI2", "HDMI3", "HDMI4" or "PC" from the "INPUT" menu.
- You can select a different "AV mode" item for each input mode (for example, select "STANDARD" for TV input and "DYNAMIC" for VIDEO input).
- If you select "AUTO", some selections in the "AV mode" menu may not be automatically set.

Picture Clear Picture Processing

Processes noise included in broadcast signals to improve picture quality.

Item	
High	Improves picture quality through Clear Picture Processing at a level above "Middle".
Middle	\updownarrow
Off	Turn OFF the function for improving picture quality through Clear Picture Processing.

Picture OPC

Automatically adjusts the brightness of the screen.

Item	
Off	The brightness is fixed at the value set in "Backlight".
On	Automatically adjusts.
On:Display	Displays the OPC effect on the screen while adjusting the brightness of the screen.

NOTE

- When set to "On", the TV senses the surrounding light and automatically adjusts the backlight brightness. Make sure no object obstructs the OPC sensor, which could affect its ability to sense surrounding light.
- When "Backlight" is adjusted, "OPC" is set to "Off".

Basic adjustment



Picture

Picture adjustments

Adjusts the picture to your preference with the following picture settings.

Adjustment items

Selectable items	◀ (Cursor)	▶ (Cursor)
Backlight	The screen dims	The screen brightens
Contrast	For less contrast	For more contrast
Brightness	For less brightness	For more brightness
Colour	For less colour intensity	For more colour intensity
Tint	Skin tones become reddish	Skin tones become greenish
Sharpness	For less sharpness	For more sharpness



Picture

Advanced

This TV provides various advanced functions for optimising the picture quality.

Go to "HOME" > "TV Menu" > "Setup" > "Picture" > "Advanced".

C.M.S.-hue

This function adjusts the hue of a selected colour using a six-colour adjustment system.

C.M.S.-saturation

This function increases or decreases the saturation of a selected colour using a six-colour adjustment system.

C.M.S.-value

This function adjusts the brightness of a selected colour using a six-colour adjustment system.

Colour temp.

Adjusts the colour temperature to give the best white image.

Item	
High	White with bluish tone.
Mid-High	Intermediate tone between "High" and "Middle".
Middle	Natural tone.
Mid-Low	Intermediate tone between "Middle" and "Low".
Low	White with reddish tone.
10 point setting*	Finely adjusts each colour temperature between 1 to 10 points.
R/G/B Gain (LO), R/G/B Gain (HI)	Adjusts the white balance by changing the value of each item.

* "10 point setting" is available only when selecting "STANDARD", "MOVIE" or "STANDARD (3D)" from the "AV mode" menu.

Motion enhancement

"Motion enhancement" technologies provide superior solutions for digital display picture quality removing motion blur ("AquoMotion 200/240", "High", "Low", "Off").

NOTE

- This effect is greater on fast moving images.
- This function will have no effect in the following cases.
 - 1) The type of signal received is a PC signal.
 - 2) An OSD is being displayed.
 - 3) Teletext is activated.
- If images appear blurred, set to "Off".

Gamma adjustment

Selects the tone difference of the brightness and darkness of the image according to the type of programme watched from a maximum of + 3 to a minimum of - 3.

Film mode

Automatically detects a film-based source (originally encoded at 24 or 25 frames per second, depending on the vertical frequency), analyses it and then recreates each still film frame for high-definition picture quality.

Item	
Advanced	Adjust effect to reduce judder from film contents. Select a desired level of judder reduction from 0 to +10.
Standard	Detects, analyses, converts film source.
Off	Normal viewing mode.

NOTE

- Film mode is not selectable depending on the input signal type.

Basic adjustment

Active contrast

Automatically adjusts the contrast of an image according to the scene. ("Advanced", "Standard", "Off").

NOTE

- "Active contrast" is not available in case of 4K input.

DNR (Digital Noise Reduction)

"DNR" produces a clearer image ("Auto", "High", "Middle", "Low", "Off").

NOTE

- This function may not be available depending on the input signal type.

Range of OPC

The brightness level range of the OPC sensor's automatic adjustments can be set according to your preferences. The adjustment range of the OPC sensor can be set to a maximum of + 16 and a minimum of - 16.

NOTE

- The maximum setting cannot be set to a smaller number than the minimum setting.
- The minimum setting cannot be set to a bigger number than the maximum setting.
- The maximum and minimum settings cannot be set to the same number.
- Depending on the brightness of the surrounding light, the OPC sensor might not operate if the adjustment range is small.

Audio settings

Go to "HOME" > "TV Menu" > "Setup" > "Audio".

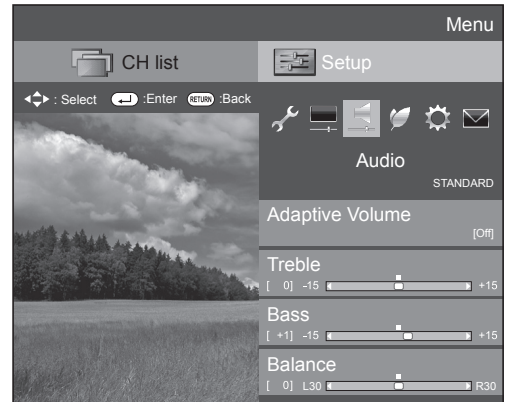

Audio Adaptive Volume

Adjust volume level automatically to lessen sudden volume change.

Item	
On	Adjust the volume gaps.
Off	Does not adjust the volume gaps.

Audio Audio adjustment

You can adjust the sound quality to your preference with the following settings.

Item	◀ (Cursor)	▶ (Cursor)
Treble	For weaker treble	For stronger treble
Bass	For weaker bass	For stronger bass
Balance	Decrease audio from the right speaker	Decrease audio from the left speaker

NOTE

- For resetting all adjustment items to factory preset values, press ▲/▼ to select "Reset", press ←, press ▲/▼ to select "Yes", and then press ←.

Basic adjustment

Audio Surround

This function produces a surround effect from the speakers.

Item	
3D Stadium	Reproducing lifelike experience of excitements such that live sports or concert performances in a stadium create.
3D Hall	Reproduces a concert hall experience with realistic live surround sound based on reverberant sounds measured in a concert hall.
3D Movie	Reproduces a movie theatre experience with realistic live surround sound based on reverberant sounds measured in a movie theatre.
3D Standard	Creates three-dimensional surround sound with detailed control of the signal phase.
Normal	Provides limited surround sound.
Off	Outputs normal sound.

Audio Harmonics enhancer extended

This function improves the sound quality by extending the selected range.

Item	
All range	The low range will be extended and the sounds in the medium and high ranges, which have been lost due to the data being compressed, will be restored. This setting is effective when playing back audio through a wireless interface such as when using Bluetooth playback.
Low range	The low range will be extended.
Off	No adjustment.

Audio Clear voice

This function emphasises speech against background noise for greater clarity.

Audio Audio description setting (DTV only)

This function allows you to enable output of audio description if the TV receives a signal including audio description.

NOTE

- The audio description sound is superimposed on the main audio when you select a broadcast compatible with audio description.
- If you do not clearly hear the sound for the visually impaired, go to "HOME" > "TV Menu" > "Setup" > "Audio" > "Audio description setting" > "Mix level", and select the upper level to turn up the volume.
- This function is available only for DTV broadcasts. This "Audio description setting" menu is not displayed for the ATV or the external inputs.
- The audio description sound is superimposed on the main audio only when the sound is output on the speaker sound output, headphone sound output and sound for audio out output. The sound is not output on the digital audio output and the HDMI sound output.
- This function is not available for the AQUOS Audio speaker system.
- This function does not work during USB-recording playback.

Basic adjustment

Power save settings

Go to "HOME" > "TV Menu" > "Setup" > "ECO".

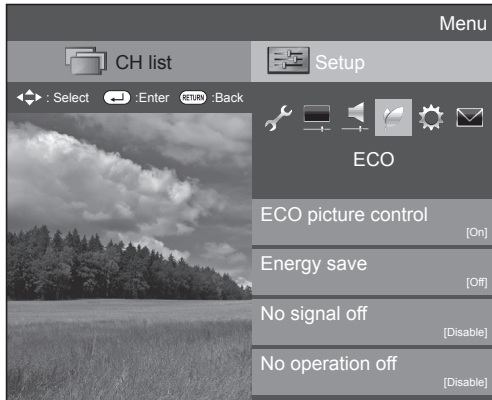

NOTE

- You can also select "ECO" by pressing **ECO**.

ECO picture control

This function automatically detects the image source and decreases the power consumption while keeping the brightness of the image unchanged.

NOTE

- This function does not work when "AV mode" is set to "DYNAMIC (Fixed)", "DYNAMIC" or "AUTO".
- This function does not work when "Energy save" is set to "Standard" or "Advanced".
- This function is greyed out in 3D mode.

ECO Energy save

This function enables you to reduce the backlight brightness in order to decrease the power consumption and increase the backlight life span as shown in the following table.

Item	
Standard	Reduces the backlight brightness.
Advanced	Reduces the backlight brightness more than "Standard".
Off	The backlight brightness is the same value of your settings in the selected "AV mode".

When "Energy save" is set to "Standard" or "Advanced", "Energy save" status icons appear in the "Picture" menu and channel information windows.

NOTE

- This function does not work when "AV mode" is set to "DYNAMIC (Fixed)".

ECO No signal off

When set to "Enable", the TV will automatically enter standby mode if there is no signal input for 15 minutes.

NOTE

- Even if a TV programme finishes, this function may not operate because of interference from other TV stations or other signals.

ECO No operation off

You can set the TV to automatically power off when no TV operation is performed for 30 minutes or 3 hours.

NOTE

- "Disable" is the factory preset value.

ECO Sleep timer

Allows you to set a time when the TV automatically enters standby mode. You can set the time span for entering standby mode after selecting "Change".

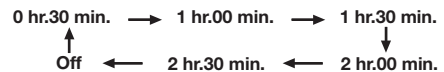

NOTE

- Select "Off" to cancel the sleep timer.
- When the time has been set, countdown automatically starts.
- Five minutes before the preset of time expires, the remaining time displays each minute.

Channel settings

Go to “HOME” > “TV Menu” > “Setup” > “View setting”.

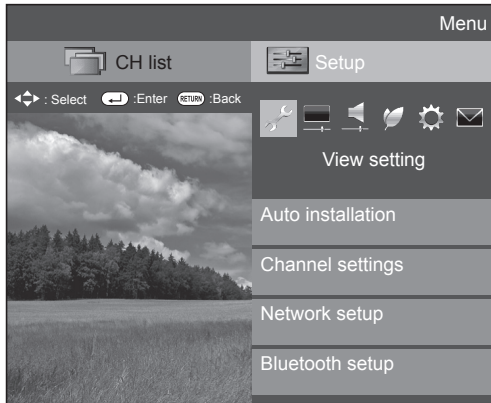

View setting

Auto installation

The TV automatically detects and stores all available services in your area. This function also allows you to perform the channel setting and reconfigure the settings after the initial auto installation has been completed.

- 1 Go to “HOME” > “TV Menu” > “Setup” > “View setting” > “Auto installation”.
- 2 If you have already set the password, enter it here.
 - See page 45 for setting a password.
- 3 Press ◀▶ to select “Yes”, and then press ↵.
- 4 Press ▲/▼/◀▶ to select the desired language, and then press ↵.
 - You do not need to do anything during the auto search.
- 5 Press ◀▶ to select “Digital Search” or “Analogue Search”, and then press ↵.
 - When the country setting is set to “Australia”, only “Digital Search” is available.

NOTE

- You cannot set the HOME/STORE setting and the country setting in “Auto installation” in the “Setup” menu. If you want to reconfigure those settings, automatically execute initial auto installation after executing “Reset” from the “Setup” menu.
- The current country setting is displayed on the screen.
- In the setting of some country, selecting of “Digital Search” or “Analogue Search” may not be shown.



View setting

Programme setup

You can run the auto search procedure again at any time by accessing the “Setup” menu and “Programme setup”. Channels can be tuned automatically or manually.

Digital setting (DTV only)

You can reconfigure the DTV channel settings automatically or manually.

- 1 Go to “HOME” > “TV Menu” > “Setup” > “View setting” > “Channel settings” > “Programme setup”.
- 2 If you have already set the password, enter it here.
 - See page 45 for setting a password.
- 3 The “Digital setting” screen displays, and then press ↵.
- 4 Press ▲/▼ to select the desired menu item, and then press ↵.
- 5 Press ◀▶ to select “Yes”, and then press ↵.

Additional search

Use this menu to add new services automatically after “Auto installation” has been completed.

- Start searching channels after selecting the colour system and sound system.

Manual search

Add new services within a specified frequency band.

- Enter the frequency using 0-9 numeric buttons.

Manual adjust

Configure various settings for each service using the **Colour (R/G/Y/B)** buttons.

Service No.	Service Name	Lock	CH skip	Old LCN
DTV 993	SIT 3			
DTV 994	SIT 2	✓		
DTV 995	SIT 1		✓	
DTV 999	HD Monesco			

Lock CH skip Delete Sort

- 1 Press ▲/▼ to select the desired service.
- 2 Press the **Colour** button on the remote control unit corresponding with the item you want to reconfigure.
 - The ✓ mark indicates the operation is set to on. Each time the **Colour** button is pressed, you can switch the corresponding operation on/off.

Basic adjustment

Buttons for “Manual adjust” operation

Lock Press **R** button.

When the service is locked, you must enter your password whenever you tune to the service.

CH skip Press **G** button.

Services with a ✓ mark are passed over when pressing **CH**▲/▼ on the TV or remote control unit.

Delete Press **Y** button.

The selected service is deleted. If you want to watch the service you deleted once again, perform “Auto installation”, “Additional search”, or “Manual search”.

Sort Press **B** button.

The item position of services can be sorted.

- ① Press ▲/▼ to select the service whose item position you want to move, and then press ←.

DTV 994	SIT 2	✓
DTV 995	SIT 1	✓

- ② Press ▲/▼ to move it to the desired position, and then press ←.

DTV 994	SIT 1	✓
DTV 995	SIT 2	✓

- ③ Repeat steps 1 and 2 until all desired service items are sorted.

Analogue setting

- 1 Go to “HOME” > “TV Menu” > “Setup” > “View setting” > “Channel settings” > “Programme setup”.
- 2 If you have already set the password, enter it here.
 - See page 45 for setting a password.
- 3 The “Analogue setting” screen displays, and then press ←.
- 4 Repeat steps 4 and 5 in **Digital setting**.

NOTE

- The “Analogue setting” menu is available only for watching TV in ATV mode.

Additional search

Use this menu to add new services automatically after “Analogue Search” in the “Auto installation” menu has been completed.

- Start searching channels after selecting the colour system and sound system.

Manual adjust

You can reconfigure the analogue TV channels settings automatically or manually.

After selecting “Yes” on the screen, press ▲/▼/◀/▶ to select the channel you want to set and then press ←.

Programme Setup “Manual adjust” menu

01	02	03	04	05
06	07	08	09	10
11	12	13	14	15
16	17	18	19	20
Next				

You can select one of the following settings.

Search

You can add a new channel within a specified frequency band.

Item	
Next	Search the next channel.
Store	Memorise the current display channel.
Cancel	Return to the previous screen (the search result will not be stored).

Fine

You can adjust the frequency to the desired position.

- 1 You can set by directly entering the frequency number of the channel with **0–9** numeric buttons.

EXAMPLE

- 179.25 MHz: Press **1 > 7 > 9 > 2 > 5**.
- 49.25 MHz: Press **4 > 9 > 2 > 5 > ←**.

NOTE

- Adjust while checking the background picture as a reference.
- When setting a frequency on the “Fine” screen, the last figure of the frequency needs to be “0” or “5”.

Colour sys.

Select the optimum colour system to receive (“Auto”, “PAL”, “SECAM”, “NTSC3.58”).

Sound sys.

Select the optimum sound systems (broadcasting systems) to receive (“B/G”, “D/K”, “I”, “M”).

NOTE

- Check the sound system if the sound output were not correct.

Label

When a TV channel sends its network name, the “Auto installation” detects the information and assigns a name to it. However, you can change channel names individually.

Select each character of the new name for the channel with using the software keyboard (see page 16).

NOTE

- The name can be five characters or less. Select “Cancel” to set the channel name.

Skip

Channels with “Skip” set to “On” are passed over when using **CH** even if selected while watching the image from the TV.

Lock

You can block the viewing of any channel.

NOTE

- See page 45 for setting a password.
- When “Lock” is set to “On” for a channel, “Child lock has been activated” displays, and the image and sound of the channel are blocked.
- When pressing **RETURN** while “Child lock has been activated” displays, the password input window will display. Inputting the correct password unlocks the “Password” temporarily until the power is turned off.

Sort

Channel positions can be sorted freely.

- 1 Press to select “Yes”, and then press .
- 2 Press to select the channel you want to move, and then press .
- 3 Press to move it to the desired position, and then press .
- 4 Repeat steps 2 and 3 until all desired channels are sorted.

Erase programme

Channels can be erased individually.

- 1 Press to select “Yes”, and then press .
- 2 Press to select the channel you want to erase, and then press .
 - A message window pops up.
- 3 Press to select “Yes”, and then press to erase the selected channel. All the subsequent channels move up.
- 4 Repeat steps 2 and 3 until all desired channels are erased.

TV Start-up time setting



Option

Quick start

You can reduce the TV’s start-up time after turning on the power with the remote control unit.

Go to “HOME” > “TV Menu” > “Setup” > “Option” > “Quick start”.

Item	
On	The TV quickly starts up from standby. 24W or more of power consumption is required during standby. If you connect additional peripherals eg. USB / HDMI, the power consumption could rise to 50W.
On (Wallpaper)	The TV enters wallpaper mode when in standby condition.
Off	Power consumption is small during standby.

Useful viewing functions

Individual setting – Password



View setting

Password

Allows you to use a password to protect certain settings from being accidentally changed.

Go to “HOME” > “TV Menu” > “Setup” > “View setting” > “Individual setting” > “Password”.

● Setting a password

Register a four-digit password number to use the “Password” function.

- 1 If you already set the password, enter it here.
- 2 Press ◀▶ to select “Yes”, and then press ↵.
- 3 Enter the four-digit number as a password using 0–9 numeric buttons.

Password
Setting Password. You can change or clear Password

Yes No

Enter your new password.
Use 4 digits

— — — —

Enter the password again to confirm

— — — —

- 4 Enter the same four-digit number as in step 3 to confirm.
- 5 Press ↵.

NOTE

- To view a locked channel, you must enter the password (see page 44 for locking channels password). When you select a locked channel, a password prompt message pops up. Press RETURN to display the password input window.

● Deleting the password

Allows you to reset your password.

- 1 Enter the password.
- 2 Press ◀▶ to select “No”, and then press ↵.
- 3 Press ◀▶ to select “Yes”, and then press ↵.

Password
Delete password?

Yes No

NOTE

- As a precautionary measure, make a note of your password on page 94, cut it out and keep it in a safe place that children cannot reach.
- This function is only available for TV input mode.
- To relock a channel which has been temporarily unlocked by inputting the correct password, turn power off and then on again.



View setting

Parental rating (DTV only)

This function allows DTV services to be restricted. It prevents children from watching violent or sexual scenes that may be harmful.

- 1 Go to “HOME” > “TV Menu” > “Setup” > “View setting” > “Individual setting” > “Parental rating”.
 - Repeat steps 1 to 5 in **Setting a password** to the left.

Selected item	Description
None	Cancel the blocking.
Age xx years	Select desired age to block. (Example) If age 14 is selected, programmes rated for ages of 15 or more are blocked.
General and above (G)	Content is not offensive to most viewers.
Parental guidance and above (PG)	Content is such that parents may not want their children to view the programme.
Mature and above (M)	Mature audience only. This programme is specifically designed to be viewed by adults and therefore may be unsuitable for children under 15.
Mature adult and above (MA)	Mature adult only. This programme is specifically designed to be viewed by adults and therefore may be unsuitable for children under 15.
Adult violence and above (AV)	Not for children under age 15. Strong elements of sex and/or violence.
Restricted and above (R)	Not for children under age 18. Strong elements of sex and/or violence.

Useful viewing functions

Individual setting – Time



View setting

Clock setup

Go to “HOME” > “TV Menu” > “Setup” > “View setting” > “Individual setting” > “Clock setup”.

Time adjustment

This function allows you to set the clock manually.

NOTE

- If you select “No”, the TV will try to get the time for the broadcast.

Time display

This function allows you to display the clock time in the lower-right corner of the screen.

Item	
On	Displays the clock time.
On (half-hourly)	Displays the clock time in 30-minute increments.
Off	Hides the clock time.

NOTE

- Time information is available when channel time information including the teletext information is obtained in the “TV” mode.

Time format

You can select the time format (either “24HR” or “AM/PM”) for the clock time.

NOTE

- The displayed time may differ depending on the programmes because of the programme information.

Clock type

You can select the clock type (either “Digital” or “Analogue”).



View setting

Time zone (DTV only)

This function enables you to select your local time zone.

Go to “HOME” > “TV Menu” > “Setup” > “View setting” > “Individual setting” > “Time zone”.

NOTE

- This function lets you select the right time zone in case the time displayed in the EPG does not match the local time of your area.
- When the country setting is set to “Australia” or “Indonesia”, this function is available. When the country setting is set to “another country”, this function is not available.
- Time zone differ depending on the selected country.
- When the manual clock is set up with “Time adjustment”, this function is not available.

Individual setting – Language



View setting

Digital audio language (DTV only)

Set up to three preferred multi audio languages to display if the audio languages are available.

Go to “HOME” > “TV Menu” > “Setup” > “View setting” > “Individual setting” > “Digital audio language”.

Switching the multi audio languages

Each time you press **MPX** on the remote control unit, the audio language switches.

NOTE

- This function depends on audio language information from broadcasters.
- If audio for the selected language is not included in a received broadcast, audio will not be output for that language.



View setting

Subtitle (DTV only)

Set up to two preferred subtitle languages (including subtitles for the hearing impaired) to display if subtitles are available.

Go to “HOME” > “TV Menu” > “Setup” > “View setting” > “Individual setting” > “Subtitle”.

Selectable items

- 1st language
- 2nd language
- For hearing impaired

Switching subtitle languages

Each time you press  on the remote control unit, the subtitle switches.

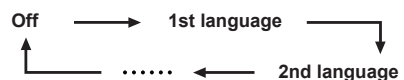

Set “For hearing impaired” to “Yes”

Subtitles for the hearing impaired have priority over each of the subtitle language settings (e.g., “1st language”, “2nd language”, etc.).

EXAMPLE

1st language → 1st language
(For hearing impaired)

NOTE

- Subtitles will not be displayed when the programme does not contain subtitle information.
- Subtitles may not be displayed in 3D mode.



View setting

Language

You can select an OSD language. Refer to the **OSD language** column in the specification table for the selectable languages (Page 89).

Go to “HOME” > “TV Menu” > “Setup” > “View setting” > “Language”.

Optional features settings

Go to “HOME” > “TV Menu” > “Setup” > “Option”.

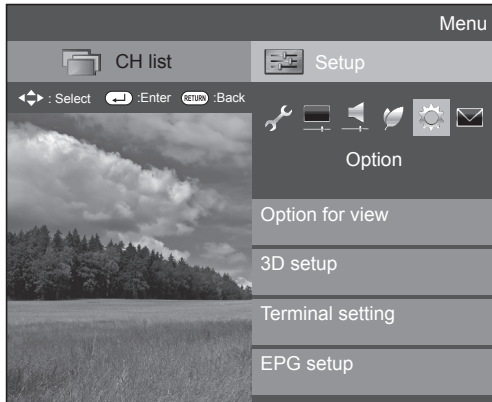

Selecting the picture size manually



You can select the picture size. Selectable picture size varies with the type of signal received.

- 1 Go to “HOME” > “TV Menu” > “Setup” > “Option” > “Option for view” > “Wide mode”.
 - You can also select an item by pressing **WIDE** on the remote control unit.
 - The menu lists the “Wide mode” options selectable for the type of video signal currently received.
- 2 Press **▲/▼** to select the desired item.
 - As you toggle the options, each is immediately reflected on the screen. There is no need to press **↵**.

Item (for SD [Standard-Definition] signals)	
Normal	Keeps the original aspect ratio in a full screen display.
Zoom 14:9	For 14:9 letterbox pictures. A thin side bar appears on each side, and you may also see bars on the top and bottom with some programmes.
Panorama	In this mode, the picture is stretched toward each side of the screen. The picture may appear similar to “Full” depending on broadcast signals.
Full	For 16:9 squeeze pictures.
Cinema 16:9	For 16:9 letterbox pictures. Bars may appear on the top and bottom with some programmes.
Cinema 14:9	For 14:9 letterbox pictures. Bars may appear on the top and bottom with some programmes.
Original	Keeps the original resolution, do not expand.

Item (for HD [High-Definition] signals)	
Full	Displays with an overscan image. Crops all sides of screen.
Underscan	Displays with an underscan image only when receiving a 720p/2160p signal. Displays with the High-Definition image adjusted optimally. Noise may appear on the edge of the screen with some programmes.
Dot by Dot	Displays an image with the same number of pixels on the screen when receiving 1080i/1080p signals only.

NOTE

- “Zoom 14:9” and “Cinema 14:9” will appear only for TV mode.
- Some items do not appear depending on the type of received signal.
- Refer to page 70 for PC signals inputs.
- The Wide mode is fixed to “Underscan” when 4K signal is input.

Selecting the picture size automatically



The “Auto wide” allows the TV to switch automatically among the different picture size.

Go to “HOME” > “TV Menu” > “Setup” > “Option” > “Auto wide”.

NOTE

- Use “Wide mode” if an image does not switch to the appropriate picture size. When the broadcast signal contains no aspect ratio information, the function will not work even if enabled.
- This function is available for 3D images converted from 2D images or normal 2D images.

Useful viewing functions

Option 4:3 mode (DTV only)

The 4:3 mode allows you to select between "Full" and "Normal".

Go to "HOME" > "TV Menu" > "Setup" > "Option" > "4:3 mode".

Item	
Full	Wide image without side bars.
Normal	Normal range keeping 4:3 or 16:9 aspect ratio.

4:3 screen types

4:3 mode "Full"



4:3 mode "Normal"



Setting audio input

Option Digital audio output

This function allows you to select the digital audio signal type.

Go to "HOME" > "TV Menu" > "Setup" > "Option" > "Terminal setting" > "Digital audio output".

Item	
PCM	To stereo audio system
Bitstream	To multi-channel Dolby Digital, DTS audio system

Option Audio select

When using the PC terminal or HDMI2 terminal, you must select which terminal uses the AUDIO IN jack for analogue audio input.

Go to "HOME" > "TV Menu" > "Setup" > "Option" > "Terminal setting" > "Audio select".

When selecting "HDMI2" from the "INPUT" menu

Item	
HDMI	When connecting devices (including a PC) with a HDMI cable to the HDMI2 terminal.
HDMI + Analogue	When connecting devices (including a PC) with a DVI/HDMI cable to the HDMI2 terminal and inputting analogue audio signals from the AUDIO IN jack.

When selecting "PC" from the "INPUT" menu

Item	
Video	When connecting devices with AV cable to the PC terminal, display images without audio.
Video + Audio	When connecting a PC to the PC terminal, and inputting analogue audio signals from the AUDIO IN jack.

Skipping specified inputs

Option Input skip

This setting allows you to skip the inputs on the input source selection operation.

Go to "HOME" > "TV Menu" > "Setup" > "Option" > "Terminal setting" > "Input skip".

NOTE

- If you connect external equipment to an HDMI terminal which you have set to be skipped, a notification message appears on the display when a signal is received from the connected external equipment. Press "←" to reset the related skipping setting so that the input terminal becomes available.

Option Input select

For setting the signal type of external equipment.

Go to "HOME" > "TV Menu" > "Setup" > "Option" > "Terminal setting" > "Input select".

Input source	Selectable item
Input 6	AUTO, COMPONENT, VIDEO

Useful viewing functions

Option Input label

You can label each input source with a custom description.

- 1 Press to select the desired input source from the "INPUT" menu, and then press .
- 2 Go to "HOME" > "TV Menu" > "Setup" > "Option" > "Terminal setting" > "Input label".
- 3 Press to display the software keyboard and select each character of the new name for the input source (page 16).
- 4 Repeat the above until the name is fully spelt out, and then press **MENU**.
 - The label can be six characters or less.
 - When you want to set an input source name of less than six characters, select "Cancel".

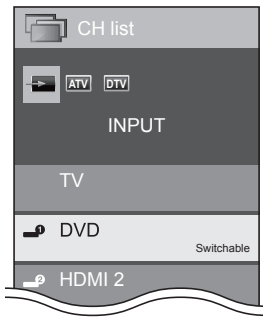

NOTE

- You cannot change labels if the input source is "TV", "Multimedia" or "Home network".

Selecting the HDMI picture size automatically

Option HDMI auto view

This function allows you to automatically change to the appropriate picture size when viewing an HDMI signal using the HDMI1, 2, 3 and 4 terminals.

- 1 Press to select the input source ("HDMI1", "HDMI2", "HDMI3" or "HDMI4") connected to your HDMI device, and then press .
- 2 Go to "HOME" > "TV Menu" > "Setup" > "Option" > "Terminal setting" > "HDMI auto view".

Item	
Enable/Disable	Set whether or not to use "Wide mode" based on signal recognition, including an HDMI signal.

NOTE

- Refer to your external equipment operation manual for the above settings.
- When connecting a DVI-HDMI conversion adaptor/cable to the HDMI terminal, the image may not come in clearly.

Option Headphone/Audio out select

You can select which device is used for outputting audio.

Go to "HOME" > "TV Menu" > "Setup" > "Option" > "Terminal setting" > "Headphone/Audio out select".

Item	
Headphone	Output audio through headphones.
Audio out	Output audio through an A/V receiver or surround audio controller.

Regarding the headphone jack

- Use headphones with a stereo mini plug (ϕ 3.5 mm).
- Be sure to unplug headphones from the jack when they are not in use.
- The speakers do not output volume when headphones are plugged in.
- The "Audio" menu cannot be operated when headphones are plugged in.
- You can set the volume to different levels for each input source.

Volume display when headphones are plugged in

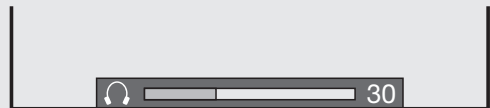

CAUTION

- This terminal is also used for headphones. Reduce the volume before using headphones. Overwhelming sound may damage your hearing.

NOTE

- If you select "Audio out" when a cable is inserted in the AUDIO IN terminal, the TV speakers are muted.
- When you select "Audio out", you can adjust the TV sound volume with the **VOL** $-/+$ buttons on the TV or the remote control unit.

Useful viewing functions



Option

Headphone out setting

You can select the headphone/speaker audio output when using the headphones.

Go to “HOME” > “TV Menu” > “Setup” > “Option” > “Terminal setting” > “Headphone out setting”.

Item	
Headphone	Audio output from headphones only.
Dual	Audio output from headphones and speakers.

NOTE

- This function does not work when “Change audio output device” (Page 34) is set to “By AQUOS audio SP” or “Headphone/Audio out select” is set to “Audio out”.
- Regarding the volume adjustment when “Dual” is set:
 - Adjust the speaker volume with the **VOL +/-** on the remote control unit.
 - Adjust the headphone volume with the **VOL +/-** on the TV.
 - The headphone volume is not muted even by pressing (Mute) on the remote control unit.
- When not using the headphones:
 - Audio outputs from the speakers regardless of the settings.



Option

Colour system (ATV only)

You can change the colour system to one that is compatible with the image on the screen.

Go to “HOME” > “TV Menu” > “Setup” > “Option” > “Colour system”.

NOTE

- The factory preset value is “Auto”.
- If “Auto” is selected, the colour system for each channel is automatically set. If an image does not display clearly, select another colour system (e.g., “PAL”, “SECAM”).



Option

Channel selecting effect

This function shows a screen effect when choosing or changing channels.

Go to “HOME” > “TV Menu” > “Setup” > “Option” > “Screen effect” > “Channel selecting effect”.



Option

Programme title display (DTV only)

This function allows you to display programme information such as the title and airtime by tuning a channel.

Go to “HOME” > “TV Menu” > “Setup” > “Option” > “Screen effect” > “Programme title display”.

NOTE

- This function is available only when the DTV mode is selected.

Adjusting image position



Option

Position

For adjusting a picture's horizontal and vertical position.

Go to “HOME” > “TV Menu” > “Setup” > “Option” > “Screen effect” > “Position”.

Item	
H-Pos.	Centres the image by moving it to the left or right.
V-Pos.	Centres the image by moving it up or down.

NOTE

- For resetting all adjustment items to the factory preset values, press / to select “Reset”, and then press .
- Adjustments are stored separately for each input source.
- Depending on the input signal type, “Wide mode” setting or “Video mode” for the Multimedia mode, a position setting may not be available.
- Images may not be displayed properly depending on the settings and/or signals.
- This function is available for 3D images converted from 2D images or normal 2D images.

Additional features



Option

Illumination

This function makes the LED on the front of TV illuminated in several ways.

Go to “HOME” > “TV Menu” > “Setup” > “Option” > “Illumination”.

NOTE

- The LED is illuminated in white for 2D mode.
- The LED is illuminated in blue for 3D mode.



Option

Wallpaper setting

This function is available only when “Quick start” is set to “On (Wallpaper)”.

Activating the function will display still images when the TV is in standby mode.

Go to “HOME” > “TV Menu” > “Setup” > “Option” > “Wallpaper setting”.

Data source

For the wallpaper, you can select either the still images pre-installed in the TV or your favourite still images stored in the USB device or SD/SDHC memory card.

Item	
Pre-installed	The images pre-installed in the TV will be displayed in a slideshow.
SD/USB	Images stored for the wallpaper will appear. If only a single still image is stored in the USB device or SD/SDHC memory card, that image will be displayed as the wallpaper. When there are multiple still images in the memory, all the images will be displayed in a slideshow.

NOTE

- Images are displayed as a slideshow in 3-minute intervals.
- As a USB device or SD/SDHC memory card cannot be detected immediately after the TV is turned on from standby mode, the wallpaper pre-installed in the TV may be displayed even when “Data source” is set to “SD/USB”. To display the SD/USB Wallpaper, turn on the power and wait 10 seconds before turning off the power.
- When in the wallpaper function, do not perform any OAD operations or EPG searches.
- A timer set for recording or watching a programme will take priority 2 minutes before the programme starts.

● When you display images by using the USB device or SD/SDHC memory card

- Create a folder named “WP” in the root directory of the USB device or SD/SDHC memory card (the first directory when the USB device or SD/SDHC memory card is opened), and store into the folder the still images you want to display for the wallpaper.
- You must insert the USB device or SD/SDHC memory card into the TV before turning off the TV.
- If there are images on the USB device or SD/SDHC memory card but they do not appear on the screen, switch to SD/USB mode and check whether the image files on the USB device or SD/SDHC memory card are shown correctly.

Timer setting

You can set the length of time the TV will remain in the Wallpaper mode (3 hours/6 hours/12 hours/24 hours).

NOTE

- Setting “Quick start” to “On” consumes more power.
- No buttons except for  work even while the still images are being displayed.
- If the ready-for-use USB device or SD/SDHC memory card is not inserted, the still images pre-installed in the TV will be displayed in a slideshow even when “Data source” is set to “SD/USB”.
- The still images will be displayed until the set time has elapsed.
- If you do not want to use the wallpaper as described above, set “Quick start” to “On” or “Off”.



Option

Boot picture

With this function activated, the SHARP logo will be displayed when you turn on the TV.

Go to “HOME” > “TV Menu” > “Setup” > “Option” > “Boot picture”.

NOTE

- This function is not available when the “Quick start” is set to “On”.



Option

Game play time

This function allows you to display the elapsed time on the screen when “AV mode” is set to “GAME”.

Go to “HOME” > “TV Menu” > “Setup” > “Option” > “Game play time”.

Item	
On	Under connecting a game console to the TV, the elapsed time is displayed in 30-minute increments after you start playing a game.
Off	Hides the time.

NOTE

- This function is displayed in the external input mode.
- This function is reset after performing the following operations:
 1. When toggling the input.
 2. When changing “AV mode”.

Useful viewing functions



Option

Key lock

This function allows you to lock the buttons on the TV or remote control unit in order to prohibit children from changing the channel or volume.

Go to "Home" > "TV Menu" > "Setup" > "Option" > "Key lock".

Item	
Off	Unlocks the buttons.
RC control lock	Locks all buttons on the remote control unit.
Button control lock	Locks the buttons on the TV except the power switch.

NOTE

- You cannot set both "RC control lock" and "Button control lock" at the same time.

● Cancelling the lock

Press **MENU** on the TV and set to "Off" to cancel the "RC control lock". Press **MENU** on the remote control unit and set to "Off" to cancel the "Button control lock".

NOTE

- See page 18 for the functions of the TV control panel buttons.
- To cancel "Button control lock", use the remote control.

Bluetooth setup

Set this function when using the Bluetooth devices with your TV.

It is possible to connect 3D glasses, a keyboard, mouse, tablet and smartphone.

NOTE

- When you use the Bluetooth device with your TV for the first time, you must make pairing between the device and the TV. Once the pairing is correctly carried out, the Bluetooth device will be registered on the TV.

Bluetooth devices

You can add, delete or select Bluetooth devices. If you connect a tablet or smartphone to the TV by Bluetooth, you can listen its sound through the TV.

● Addition of a Bluetooth device

Go to "HOME" > "TV Menu" > "Setup" > "View setting" > "Bluetooth setup" > "Pairing new device".

You can connect 3 kinds of Bluetooth devices listed below:

- Keyboard device
- Mouse device
- Audio input device

Connection / Selection Procedure

- 1 Press **▲/▼** to select the device you want to connect.
- 2 Press **◀/▶** to select "Search", and then press **↵**.
- 3 Model names of the detected devices will be displayed.
- 4 Select the device with the message "New", and then press **↵**.
- 5 Wait the message indicating "Pairing completed", and then press **↵**.

Before connecting the devices, press the connect button on the Bluetooth device you want to connect.

- Keyboard device: When pairing operation between keyboard and TV is completed, enter the PIN code by using the keyboard device.
- Mouse device: When pairing operation between mouse and TV is completed, the name will be displayed, then press **↵**.
- Audio input device:
 1. Change input source to Bluetooth by pressing **↻** on the remote control unit.
 2. In Bluetooth device (smartphone/tablet) enable Bluetooth function. The device starts to search Bluetooth standby TV.
 3. TV name will be shown in Bluetooth device, then select it.

NOTE

- See also the instruction manual supplied with the Bluetooth device.
- You can register up to 6 devices to the TV, but only one keyboard, mouse, audio output and audio input device can be used at a time.
- If a device for which "Selected" is displayed does not operate properly, try searching and selecting the device again.
- The keyboard or mouse may not operate properly depending on the application being used.
- The Bluetooth device may not operate properly depending on the device being used.

Useful viewing functions

Miracast setup

By Miracast technology you can enjoy the contents of Miracast compatible smartphone or tablet to this TV.

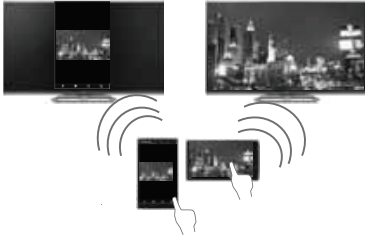

Using the Miracast device

When you connect a device such as a Miracast compatible smartphone or tablet to this TV, you can enjoy video and audio from the device on the TV's large screen and speakers.

- 1 Switch the TV input to "Miracast".
- 2 Enable the Miracast function on the Miracast device and connect to the TV. (The TV changes according to the behavior of the device).

NOTE

- When the TV is turned off or the connection is ended on the device, you must connect the device again.
- When connecting using a PIN code, first select the corresponding menu on the "Miracast" menu, and then perform the operations from step 1.
- If you want to specify the preferred band to use with this function, select the corresponding menu on the "Miracast" menu.
- For details about the operation of the Miracast compatible device, check the manual for that device.
- The Miracast function may not operate properly depending on the device being used.

Connection mode setting

Miracast function has two connection modes: "PUSH Button Mode" and "PIN Code Mode". User can select connection method in TV menu.

When the connection is made, device screen will be displayed in the TV.

● PUSH Button Mode

- 1 Change input source to Miracast by pressing  on the remote control unit.
- 2 In Miracast device (smartphone/tablet) enable Miracast function.
The device starts to search for the TV with Miracast in standby mode.
- 3 TV name will be shown, then select it.

When the connection is made, device screen will be displayed in the TV.

● PIN Code Mode

- 1 Change input source to Miracast by pressing  on the remote control unit.
- 2 In Miracast device (smartphone/tablet) enable Miracast function. The device starts to search for the TV with Miracast in standby mode.
- 3 TV name and PIN code will be shown (PIN code is created randomly.)
Enter the PIN code displayed on the TV.

When the connection is made, device screen will be displayed in the TV.

Failed connection

If connection is not established, the next message will appear:

"Connection failed"

Please repeat procedure "Connection mode setting".

Wireless Channel Setting

Configures Wireless Channel Setting.

NOTE

- Depending on the connected device, different channels may be assigned.
- You can use the Wireless Channel setting to specify the preferred channel. Select "Auto" to select the optimum channel for the usage conditions.

Network function

Playing Back Files from a Portable Device or PC

With the remote playback function, you can use your portable device to playback pictures, video and music on the home network server.

- The TV has obtained DLNA's Digital Media Renderer (DMR) certification.
- To use the remote playback function, your portable device or PC must be a DLNA Certified Digital Media Controller.
- Please ensure that the TV and portable device or PC are in the same network environment, and set portable device as the server of TV.

For the network setting of TV, please refer to pages 54 – 56.

Easy share setting

- 1 Go to "HOME" > "TV Menu" > "Setup" > "View setting" > "Network setup" > "Easy share setting".
- 2 Press ▲/▼ to select the item to be adjusted, and then press ← to set.

● Set easy share permission

Before this function can be used, you need to set the TV to the status of being able to receive contents.

Item	
On	Receiving and playing contents from portable device or PC are allowed.
Off	Receiving contents from portable device or PC is not allowed.

● Time out setting

This sets the time until the TV returns automatically to TV mode after remote playback ends.

Item	
10 sec./60 sec.	When the set time has elapsed after remote playback ends, the TV returns automatically to TV mode.
No	Select this to manually switch the TV after remote playback ends.

NOTE

- This function may not work while an Internet application is being used.
- Due to reasons including network environment, it may take some time for the TV to start playing after the dragging operation.
- If the wireless signals are too complicated, or multiple wireless access points are available, operations may not be performed properly due to signal interference.
- Some file formats may not match. For the file formats supported by this function, please see **Home network server compatibility** on page 69.

Device name setting

You can set up the name of this TV for displaying on external devices.

Go to "HOME" > "TV Menu" > "Setup" > "View setting" > "Network setup" > "Device name setting".

Connecting to the network

To enjoy internet services, you need to connect the TV to a router with a high speed connection to the internet. You can also connect the TV to your Home network server through a router or access point. The TV connection to the router can either be wired or wireless.

NOTE

- If you choose a wired connection to the router, you need an ETHERNET cable (commercially available).
- If you do not have a broadband internet connection, consult the store where you purchased your TV or ask your internet service provider or telephone company.
- An ETHERNET and wireless connection cannot be used at the same time. Use only one of the connection types.
- A stable connection speed is required to play back streaming content, otherwise you may not be able to watch normally.

Wired installation

Use an ETHERNET cable to connect the ETHERNET terminal on the TV to your broadcast router as shown below. This is recommended when enjoying services which require stable connection speeds, such as streaming media.

● Wired connection overview

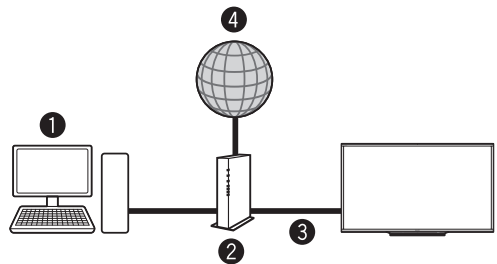

- 1 PC (home network server)
- 2 Router (commercially available)
- 3 ETHERNET cable (commercially available)
- 4 Network

Network function

● How to connect

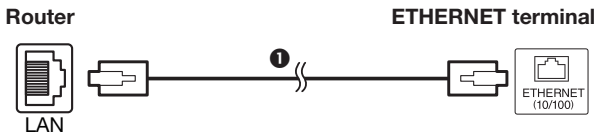

- ETHERNET cable (commercially available)
- 1 Switch on the router (commercially available). Refer to the router's operation manual for switching on.
- 2 Connect the ETHERNET terminal on the TV to the router (commercially available) with an ETHERNET cable (commercially available).

When using Easy setup function

- Refer to “How to connect”.
- 3 Go to “HOME” > “TV Menu” > “Setup” > “View setting” > “Network setup” > “LAN setting” > “Easy setup”.
- 4 Press ◀▶ to select “Yes”, and then press ←.
- 5 Press ▲/▼ to select “Wired”, and then press ←.
- 6 Please input according to direction of a screen, and finally input “Complete”.

When using Manual setup function

- Refer to “How to connect”.
- 3 Go to “HOME” > “TV Menu” > “Setup” > “View setting” > “Network setup” > “LAN setting” > “Manual setup” > select “Yes” > “Connection type”.
- 4 Press ◀▶ to select “Wired”, and then press ←.
- 5 Select “OK” to confirm.
 - The wired connection will be automatically established.
 - If you have failed to connect to the internet in the above operation, an error message will appear. In this case, press ↶ to return to the normal TV screen and check the relevant settings.

NOTE

- To change the settings manually, go to “HOME” > “Network setup” > “IP setup” and follow the on-screen instructions and the operation manual of the router.

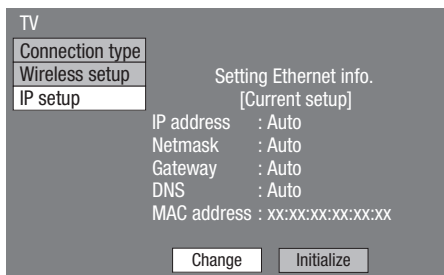

Wireless installation

This TV is equipped with a wireless LAN function.

● Wireless connection overview



- 1 PC (home network server)
- 2 Wireless LAN router/access point
- 3 Wireless LAN LCD TV
- 4 Network

NOTE

- When using the SHARP wireless LCD TV, try to provide as much free space around the device for best performance.
- A wireless LAN connection and performance cannot be guaranteed for all residential environments. In the following cases, the wireless LAN signal may be poor or drop, or the connection speed may become slower.
 - When used in buildings made with concrete, reinforced steel, or metal
 - When placed near objects that obstruct the signal
 - When used with other wireless devices that emit the same frequency
 - When used in the vicinity of microwave ovens and other devices that emit a magnetic field, electrostatic charge, or electromagnetic interference
- Make sure the firewalls in your network allows access to the TV wireless connection.
- Operations cannot be guaranteed when used with access points that do not have Wi-Fi® certification.
- A wireless LAN access point is required to connect the TV to the Internet using a wireless LAN. See the operation manual of your access point for setup.
- A stable connection speed is required to play back streaming content. Use an ETHERNET connection if the wireless LAN speed is unstable.
- Before transferring to a third party or disposal, be sure to initialise the wireless LAN settings.

● How to connect

- 1 Switch on your router before starting the network installation.

When using Easy setup function

- Refer to “How to connect”.
- 2 Go to “HOME” > “TV Menu” > “Setup” > “View setting” > “Network setup” > “LAN setting” > “Easy setup”.
- 3 Press ◀▶ to select “Yes”, and then press ←.
- 4 Press ▲/▼ to select “Wireless”, and then press ←.
- 5 Please input according to direction of a screen, and finally input “Complete”.

Network function

When using Manual setup function

- Refer to **“How to connect”**.
- 2 Go to “HOME” > “TV Menu” > “Setup” > “View setting” > “Network setup” > “LAN setting” > “Manual setup” > select “Yes” > “Connection type”.
- 3 Press ◀/▶ to select “Wireless”, and then press ↵.
- 4 Select “OK” to confirm.
- 5 Press ▲/▼ to select “Wireless setup”, and then press ↵.
- 6 Press ◀/▶ to select “Change”, and then press ↵.
- 7 Press ▲/▼ to select “WPS push button”, and then press ↵.

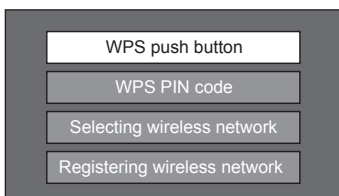

- To establish the connection manually, select “WPS PIN code”. Follow the on-screen instructions and the operation manual of the router/access point.
- 8 Select “Next” to proceed.
 - 9 Press the WPS button on the router/access point. When you press the WPS button, a progress bar will appear on the display. Wait until the connection is established.
 - 10 Select “OK” when the connection details are displayed.
 - If you have failed to connect to the internet in the above operation, an error message will appear. In this case, press ↵ to return to the normal TV screen and check the relevant settings.

NOTE

- To connect your TV to the internet, you must have a broadband internet connection.
- There is no need to enter the security key for subsequent connections to the wireless network.
- If your access point is set to a stealth mode (that prevents detection by other devices), you may not be able to establish a connection. In this case, disable the stealth mode on the access point.
- If you want to change the IP settings manually, go to “HOME” > “Network setup” > “IP setup” and follow the on-screen instructions and the operation manual of the router.
- See page 57 to check the wireless LAN specifications.

Network function

Specifications (Wireless LAN)

Standard	IEEE 802.11a/b/g/n
Frequency band	2412 – 2484 MHz 5150 – 5850 MHz
Security	Static WEP (64/128 bit, key index 1 only) WPA-PSK (TKIP) WPA2-PSK (AES)
Modulation	DBPSK@1 Mbps DQPSK@2 Mbps CCK@5.5/11 Mbps BPSK@6/9 Mbps QPSK@12/18 Mbps 16-QAM@24 Mbps 64-QAM@48/54 Mbps

Specifications (Bluetooth)

Ver. name	Bluetooth v3.0
Profile name	A2DP – SNK/SRC, HID

NOTE

- This TV has received the following certifications:
 - Wi-Fi CERTIFIED™ (certification programme from the Wi-Fi Alliance®)
 - Wi-Fi Protected Setup™ (certification programme from the Wi-Fi Alliance®)
- A wireless LAN connection and performance cannot be guaranteed for all residential environments in the following cases, the wireless LAN signal may be poor or drop, or the connection speed may become slower.
 - When used in buildings made with concrete, reinforced steel, or metal
 - When placed near objects that obstruct the signal
 - When used with other wireless devices that emit the same frequency
 - When used in the vicinity of microwave ovens and other devices that emit a magnetic field, electrostatic charge, or electromagnetic interference
- When there is significant interference in the 2.4 GHz frequency (such as from other wireless LAN devices, Bluetooth® devices, 2.4 GHz cordless telephones, and microwave ovens), it is recommended that you use a wireless LAN access point that supports IEEE802.11a/n (5 GHz) and set the access point to transmit at 5 GHz. For setup details, see the operation manual of your access point.
- Before transferring to a third party or disposal, be sure to initialise the wireless LAN settings.
- Wireless LAN supports WEP64, WEP128, TKIP and AES encryptions.
- This TV has a built-in wireless LAN function. Using a separate USB LAN adapter may result in radio communications that do not comply with regulations on radio communications. Therefore, do not use a separate wireless LAN adapter.

Network function

Using AQUOS.NET

By connecting the TV to the Internet, you can enjoy a variety of broadband content.

- 1 Press **HOME** to display the “HOME” screen.
- 2 Press **▲/▼/◀/▶** to select “AQUOS.NET” service, and then press **←**.



- 3 The screen for AQUOS.NET is displayed.

Example : The image shown below, which is only for explanation, is subject to change.

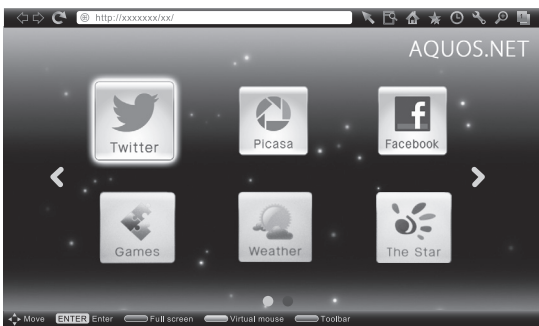

P&N (Twin Picture)

- Each time you press **WIDE** when a browser screen is shown, the display pattern toggles between a website-only screen and a TV+Web screen.

NOTE

- Additional applications will be available in the future.
- The delivery speed of applications varies depending on the network speed. Check the web site of the provider for details on application setup and other information.

- 4 Press **▲/▼/◀/▶** to select a function, and then press **←**.

Selected item	Description
	Go back to the previous page.
	Go to the next page.
	Refresh the page. Interrupt a page while it is loading.
	Switches between virtual mouse and spatial navigation modes. Switching modes also switches the display. Depending on the page displayed, switching this function may make it easier to use the browser.
	Opens a search window below the toolbar. You can use this to search for a word within the displayed page.
	Displays the Home Page. You can set the page displayed as your home page when the browser starts up.
	Displays the bookmarks list.
	Displays your browsing history.
	Configures browser settings such as your home page and browsing security.
	Zooms the display in or out.
	Restrictions apply to window display.

- 5 Press **▲/▼/◀/▶** to select the “address bar”, and then press **←**.

Example : The image shown below, which is only for explanation, is subject to change.



- 6 The software keyboard will pop up when you press **←**. After using the software keyboard to input the “URL”, press **←**.

Network function

Clear browser setting

You can clear browser setting, which includes cookies, bookmarks and caches.

Go to “HOME” > “TV Menu” > “Setup” > “View setting” > “Clear browser setting”.

NOTE

- Password input is required when executing “Clear browser setting” if Password is set.

CAUTION

- If you exercise this operation, browser setting will be completely initialised. If there is important information take notes before executing.

About links

- Web pages on the Internet often include “links” that allow you to jump to other web pages (or sites).
- “Links” can take various forms, including words or images, but they always work in the same way letting you jump to the link destination when you select them.
- You can jump from a “link” to the corresponding link destination.

CAUTION

- If the power is cut due to a power failure or the TV being unplugged while you are using the Internet, information such as bookmarks or cookies may not be saved correctly.

NOTE

To users who access the Internet from a PC:

- When you access the Internet from this TV, the procedures may not be the same as regular browser-based access on a PC.
- You cannot download files nor install programmes.
- Video and audio cannot be played, and text or images may not be displayed correctly.
- Depending on the data format, some formats may not be supported.
- As there are lot of formats in the internet, some formats may not be supported by this TV unit.

DISCLAIMERS

This Sharp device facilitates the access to content and services provided by third parties. The content and services accessible via this device belong to and may be proprietary to third parties. Therefore, any use of such third party content and services must be in accordance with any authorization or terms of use provided by such content or service provider. Sharp shall not be liable to you or any third party for your failure to abide by such authorization or terms of use. Unless otherwise specifically authorized by the applicable content or service provider, all third party content and services provided are for personal and non-commercial use; you may not modify, copy, distribute, transmit, display, perform, reproduce, upload, publish, license, create derivative works from, transfer or sell in any manner or medium any content or services available via this device.

Sharp is not responsible, nor liable, for customer service-related issues related to the third party content or services. Any questions, comments or service-related inquiries relating to the third party content or service should be made directly to the applicable content or service provider.

You may not be able to access content or services from the device for a variety of reasons which may be unrelated to the device itself, including, but not limited to, power failure, other Internet connection, or failure to configure your device properly. Sharp, its directors, officers, employees, agents, contractors and affiliates shall not be liable to you or any third party with respect to such failures or maintenance outages, regardless of cause or whether or not it could have been avoided.

ALL THIRD PARTY CONTENT OR SERVICES ACCESSIBLE VIA THIS DEVICE IS PROVIDED TO YOU ON AN "AS-IS" AND "AS AVAILABLE" BASIS AND SHARP AND ITS AFFILIATES MAKE NO WARRANTY OR REPRESENTATION OF ANY KIND TO YOU, EITHER EXPRESS OR IMPLIED, INCLUDING, WITHOUT LIMITATION, ANY WARRANTIES OF MERCHANTABILITY, NON-INFRINGEMENT, FITNESS FOR A PARTICULAR PURPOSE OR ANY WARRANTIES OF SUITABILITY, AVAILABILITY, ACCURACY, COMPLETENESS, SECURITY, TITLE, USEFULNESS, LACK OF NEGLIGENCE OR ERROR-FREE OR UNINTERRUPTED OPERATION OR USE OF THE CONTENT OR SERVICES PROVIDED TO YOU OR THAT THE CONTENT OR SERVICES WILL MEET YOUR REQUIREMENTS OR EXPECTATIONS.

SHARP IS NOT AN AGENT OF AND ASSUMES NO RESPONSIBILITY FOR THE ACTS OR OMISSIONS OF THIRD PARTY CONTENT OR SERVICE PROVIDERS, NOR ANY ASPECT OF THE CONTENT OR SERVICE RELATED TO SUCH THIRD PARTY PROVIDERS.

IN NO EVENT WILL SHARP AND/OR ITS AFFILIATES BE LIABLE TO YOU OR ANY THIRD PARTY FOR ANY DIRECT, INDIRECT, SPECIAL, INCIDENTAL, PUNITIVE, CONSEQUENTIAL OR OTHER DAMAGES, WHETHER THE THEORY OF LIABILITY IS BASED ON CONTRACT, TORT, NEGLIGENCE, BREACH OF WARRANTY, STRICT LIABILITY OR OTHERWISE AND WHETHER OR NOT SHARP AND/OR ITS AFFILIATES HAVE BEEN ADVISED OF THE POSSIBILITY OF SUCH DAMAGES.

- This product contains fonts provided by Monotype Imaging Inc.
- Monotype® is a trademark of Monotype Imaging Inc. registered in the United States Patent and Trademark Office and may be registered in certain jurisdictions.
- Tioga™ is a trademark of Monotype Imaging Inc. and may be registered in certain jurisdictions.
- Letter Gothic™ is a trademark of The Monotype Corp. and may be registered in certain jurisdictions.
- iType® is a trademark of Monotype Imaging Inc. registered in the United States Patent and Trademark Office and may be registered in certain jurisdictions.
- This product contains the iType® font engine from Monotype Imaging Inc.

powered
by  **espial**

<http://www.espial.com>

Other useful features

USB-recording

You can enjoy DTV recording or playback by connecting a commercially available USB HDD to the TV.

- USB-recording does not work for ATV, external inputs, data broadcasts, radio broadcasts or network applications.

Connecting a USB HDD

Connect a commercially available USB HDD to the USB port of the TV.

- USB storage device: USB HDD.
- Be sure to read the operation manual for the USB HDD.
- At least USB HDDs with memory between 100GB and 2TB and under are required for USB-recording to register.
- The USB 3 (HDD) port is compatible with portable USB HDD which can operate with the power supply from the USB port (bus powered drive).
- Refer to **Disconnect the USB HDD** when removing the USB HDD (do not remove the USB HDD during USB-recording operation).

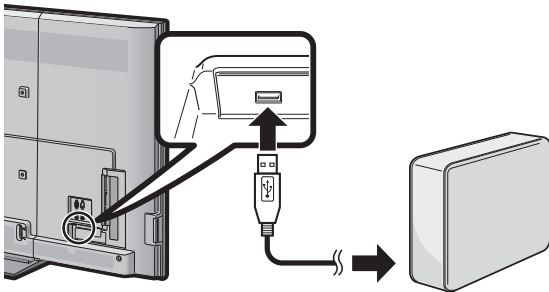

NOTE

- USB-recording may take a few moments to start after the TV is turned on.
- This function may not work properly for some USB HDDs.
- Do not connect and disconnect a USB HDD from the TV repeatedly.

USB HDD registration

It is necessary to first perform USB HDD registration for USB HDDs used for USB-recording.

Directly connect only one USB HDD to the USB port while registering the USB HDD (when two or more USB HDDs are connected, USB HDD registration is not available).

- The screen prompt pops up.

When the USB HDD is connected to the TV

Register the USB HDD. Follow the on-screen instructions to register the USB HDD. All the data on the USB HDD is deleted after USB HDD registration.

NOTE

- Only one USB HDD for USB-recording can be registered on the TV. Two or more USB HDDs for USB-recording cannot be used at the same time.
- When a USB HDD is registered, formatting may be performed. In that case, all data will be deleted.

Disconnecting the USB HDD

When you disconnect the USB HDD, be sure to the following steps.

Go to “HOME” > “TV Menu” > “Setup” > “View setting” > “USB-REC setting” > “Device removal”.

NOTE

- This menu item cannot be selected when a USB HDD for USB-recording is not registered.
- The USB HDD registration for USB-recording is cancelled in the following cases:
 - When the USB HDD is removed.
 - When another USB HDD is registered for USB-recording; only one USB HDD can be registered for USB-recording.

How to operate USB-recording

You can enjoy DTV recording or playback by connecting a commercially available USB HDD to the TV.

CAUTION

- Do not unplug the AC cord or turn off the MAIN POWER switch during USB-recording timer setting or USB-recording.
- When the AC cord is unplugged and the MAIN POWER switch is turned off:
 - The USB-recording timer setting is cancelled.
- USB-recording may be automatically stopped when signal reception is poor.
- Only this TV can playback the programme recorded on the USB HDD connected to this TV. The programmes cannot playback on other TV or PC.
- When a CAM PIN code is required for recording a programme, it is necessary to enter the CAM PIN code in advance (Page 14).

SHARP corporation bears no responsibility regarding compensation for content when recording cannot does not take place, loss of recorded data or other direct or indirect damages related to these matters. Please be forewarned.

Buttons for USB-recording operation

Remote control unit

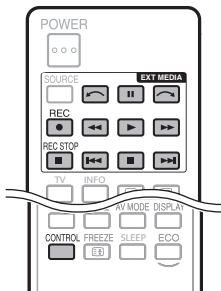

Control panel

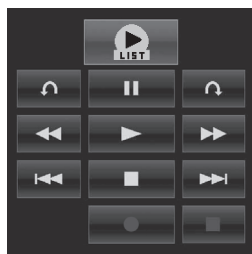

Buttons	Description
	<ul style="list-style-type: none"> • Displays the list of the programmes recorded by USB-recording.
	Start recording the programme you are watching. <ul style="list-style-type: none"> • You cannot playback the recorded programme until approximately three seconds after pressing REC to start recording.
	Stop recording.
	Playback the recorded programme.
	Stop the programme in playback and go back to the real time broadcast (live).
	Pause the programme in playback (USB-recording continues). <ul style="list-style-type: none"> • This function is released in 15 minutes.
	Reverse (each time you press this button, the reverse speed changes in three levels).
	Fast forward (each time you press this button, the fast forward speed changes in three levels).
	Jump backward to the previous chapter point*.
	Jump forward to the next chapter point*.
	Playback will resume after jumping backward by the time interval you set in "Jump time setting" (Page 64).
	Playback will resume after jumping forward by the time interval you set in "Jump time setting" (Page 64).

* Chapter points are fixed at 10 minute increments.

NOTE

- Refer to **Regarding "Select recording device"** (Page 33), when the buttons for USB-recording do not work.
- Instead of pressing buttons on the remote control unit, most of the operations shown to the left are also available on the screen with the control panel. You can call up this control panel by pressing **CONTROL** on the remote control unit or select "Control (USB-REC)" from "HOME" > "TV Menu" > "Setup" > "Option" > "Option for view".
- The "Audio description setting" menu does not work during USB-recording playback.
- USB-recording stops if no operation detected for three hours.
- When recording operations are not stopped manually, recording will automatically stop after six hours.
- To release USB-recording, press **REC STOP**, change the DTV channel or change "INPUT".
- Some functions do not work during USB-recording.
- USB-recording does not start automatically, but starts only when **REC** is pressed or when a USB-recording timer setting is started.
- The PIN is required when you use the buttons such as , , , , if you set the PIN and any options for "Parental rating" except "None" are selected.
- Do not disconnect the USB-HDD used for USB-recording during USB-recording operation.

Other useful features

USB-recording

You can record the programme you are watching to the registered USB HDD.



Starting USB-recording

- Press **REC** .
- The TV starts USB-recording.

NOTE

- You can also operate from the control panel by pressing **CONTROL**.
- You cannot switch the channel or the input source during USB-recording.
- During USB-recording, the TV cannot display photos or play music from the internet, Home network, or USB storage devices and SD/SDHC memory card.
- You may not record programmes.

Completing USB-recording

- Press **REC STOP** .
- Press  to select "Yes", and then press .

NOTE

- You can also operate from the control panel by pressing **CONTROL**.

USB-recording timer setting

You can set the USB-recording timer setting for programmes you want to record.

NOTE





- To prevent the first part of the programme from being cut, start recording the programme a few seconds earlier than time set to start recording.
- When recording/viewing timer settings are set continuously for multiple programmes, schedule the recording of the previous programme to end earlier than the end of the programme itself. Recording/viewing timer setting of the next programme will start after that.
- A message will be displayed when the scheduled time overlaps with an existing schedule. Make changes in accordance with the on-screen instructions.
- It is not possible to newly schedule a recording that overlaps with a timer setting that is currently running (recording). When urgent setting of a schedule is desired, stop recording before scheduling.
- A combined total of 16 timer settings ("Watch" and "Record") can be set.
- A CAM (CI Plus v1.3) PIN code may be necessary to record broadcasts scrambled due to parental rate settings. When a CAM PIN code is required for recording a programme, it is necessary to enter the CAM PIN code in advance (Page 14). If a CAM PIN code is not entered or is entered incorrectly, the programme will not be able to be recorded/played back.

EPG timer setup

You can select the programme you want to record and set the timer setting with EPG (Pages 25 to 27).

Manual timer setting

"Manual timer setting" enables you to set date, recording start/stop time and channel.

- Press **GUIDE**.
- Press **B** to display the timer list.
- Press **B** again to display the "Manual timer setting" screen.
- Set date, recording start/stop time and channel.
- Press  to select "Record", and then press .
- Press  to select "Yes", and then press .

NOTE

- When the country setting is set to "New Zealand", you may not display a Timer list screen in the above mentioned procedure. You can display the Timer list screen from "HOME" > "TV Menu" > "EPG" > "Timer list".

Manual clock setting

When the TV cannot receive the time via digital broadcast, perform "Manual timer setting" after setting the clock.

Go to "HOME" > "TV Menu" > "View setting" > "Individual setting" > "Clock setup" > "Time adjustment".

NOTE

- You cannot set the manual clock setting during USB recording.

Timer list

A list of programmes scheduled for recording can be displayed.



- Press **GUIDE**.
- Press **B** to display the timer list.

NOTE

- When the country setting is set to "New Zealand", you may not display a Timer list screen in the above mentioned procedure. You can display the Timer list screen from "HOME" > "TV Menu" > "EPG" > "Timer list".

USB-recording playback

To playback the recorded programmes, open the USB-recording list and select the desired programme.

- Go to "HOME" > "Record list".
- Press  button.
 - Press  to return the scene that is broadcasting.

NOTE

- You may not playback recorded programmes when the programme provider restricts or completely prevents recording or later watching of an encoded programme.
- Depending on the protection signal specified by a broadcast station, recorded broadcasts can only be played back for a certain period of time or cannot be played back at all (Page 14).

Other useful features

Time shift playback

Playback recorded scenes of the programme being recorded.

Press **▶** during recording.

- Press **■** to return the scene that is broadcasting.

NOTE

- You can also operate from the control panel by pressing **CONTROL**.
- Time shift playback may take a few moments to start.
- Time shift playback will stop and the TV will return to normal broadcasting when a programme is fast-forwarded to a scene that is near to the scene currently being broadcast. The timing at which it returns depends on the speed of fast-forwarding.
- Depending on the protection signal specified by a broadcast station, recorded broadcasts can only be played back for a certain period of time or cannot be played back at all (Page 14).

Display information regarding USB-recording

Channel display	
Channel information displays by pressing INFO on the remote control unit.	
1	The recording icon shows up when REC ● is pressed and the TV is recording the programme.
2	The status icon shows up depending on what is shown on the screen.

Counter	
The counter displays on the screen with the control panel.	
1	Current playback time <ul style="list-style-type: none"> • Hidden during recording
2	Total playback time of the content
3	The grey bar shows how much time has progressed. <ul style="list-style-type: none"> • Hidden during recording or playback-during-recording

NOTE

- You can also call up the information above by pressing **CONTROL** on the remote control unit or select "Control (USB-REC)" from "HOME" > "TV Menu" > "Setup" > "Option" > "Option for view".

View setting Auto input selection

You can choose whether or not to switch the input source automatically when receiving an AQUOS LINK compatible signal on the TV during USB-recording operations.

Go to "HOME" > "TV Menu" > "Setup" > "View setting" > "USB-REC setting" > "Auto input selection".

Item	
Enable	Release USB-recording when receiving an AQUOS LINK compatible signal. Switch input source automatically.
Disable	USB-recording continues to work. The TV does not switch input source automatically even when receiving an AQUOS LINK compatible signal.

View setting Jump time setting

You can set the time interval for playback to resume after jumping backwards/forward.

Go to "HOME" > "TV Menu" > "Setup" > "View setting" > "USB-REC setting" > "Jump time setting".

- A time interval from 10 sec. to 99 min. 50 sec can be selected.

NOTE

- You can use the time interval you set using the or buttons on the control panel.

View setting Device registration

You need to perform this function to register the USB HDD for the USB-recording.

Go to "HOME" > "TV Menu" > "Setup" > "View setting" > "USB-REC setting" > "Device registration".

- Refer to **USB HDD registration** (Page 61).

NOTE

- Only one USB HDD can be registered for USB-recording. Remove all USB HDDs except the one used for USB-recording.
- At least USB HDDs with memory between 100GB and 2TB and under are required for USB-recording to register.
- Some USB HDDs, such as ones which have multiple drives, etc., cannot be used for USB-recording.

Other useful features



View setting

Device format

You can format all data on the USB HDD.

Go to "HOME" > "TV Menu" > "Setup" > "View setting" > "USB-REC setting" > "Device format".

NOTE

- Once formatting has been completed, data cannot be restored.

Multimedia/Home network

Multimedia/Home network

In both modes, you can enjoy viewing photos, listening to music and watching videos from external USB devices (USB Memory, USB card reader (Mass Storage Class), USB HDD), SD/SDHC memory card or Home network server.

NOTE

- To connect a Home network server, refer to **Network function** (Pages 54 – 56).
- Some USB devices or SD/SDHC memory card may not work properly for this function.
- The corresponding file format is different between "Multimedia" and "Home network".
- You can select "Wide mode" from "Auto" or "Original" in "Photo mode" and "Full", "Auto" or "Original" in "Video mode".
- Depending on the Home network server, the TV may not be able to recognise the contained data.
- Use only alphanumeric characters for naming files.
- Do not disconnect a Home network server from the TV while transferring files, using the slide show function, when a screen is switching to another or before you exit "Home network" from the "INPUT" menu.

Selecting the mode

Common operation

Select "Multimedia" or "Home network" from the "HOME" screen to enter this mode.

Other operation

- You can select the mode from "INPUT" menu.
- Multimedia**
Select the Multimedia mode option on the screen when a USB device or SD/SDHC memory card is connected to the TV.

Selecting modes and drives/servers

1 Press B.

Multimedia mode (Example)

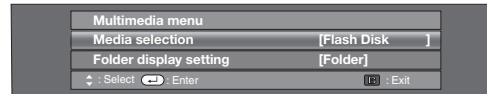

- Press ▲/▼ to select "Media selection", and then press ↵.
 - The available selections are "Media selection" and "Folder display setting".
- Press ▲/▼/◀/▶ to select the media where you want to find your files, and then press ↵.
 - You can select from "All" or "Folder" for the type of folder directory in the "Folder display setting".

Home network mode (Example)



Press ▲/▼ to select the server where you want to find your files, and then press ↵.

- Press Y to search for servers.

2 Press ◀/▶ to select "Photo mode", "Music mode" or "Video mode", and then press ↵.

NOTE

- The explanations for the buttons that can be used in each mode are the explanations when using Multimedia mode.**
Some operations may differ in Home network mode. Follow the on-screen instructions during operations.
- You do not need to select the drive/server in step 1 when there is only one drive in the connected USB device or SD/SDHC memory card or there is only one Home network server connected to the TV.
- 16 is the maximum number of drives that can be displayed in Multimedia mode.
- 10 is the maximum number of servers that can be displayed in Home network mode.
- You cannot enter these modes when there is no server connected to the TV in Home network mode.

Other useful features

Photo mode

Viewing thumbnails

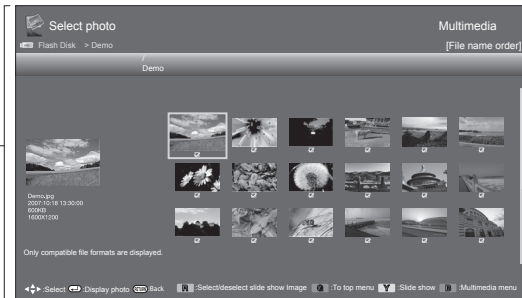

* This screen image is for the Multimedia mode. It may be slightly different in the Home network mode.

Buttons for thumbnail operations (When using Multimedia mode)

Buttons	Description
	When selecting a folder icon: Enter this directory. When selecting a photo thumbnail: Enlarge the photo.
	Select a desired item.
RETURN	Return to the previous operation.
R button	Select/deselect items (✓ mark appears on the selected items).
G button	All*: Select BGM for the slide show. Folder*: Move to the parent folder.
Y button	Start the slide show.
B button	Display "Multimedia menu". <ul style="list-style-type: none"> 3D display Select slide show interval Select slide show BGM Set all slide show image Reset all slide show image USB device or SD/SDHC memory card removal

* The mode selected in "Folder display setting".

NOTE

- When there are invalid photo files, the ✕ mark will be displayed for the file.
- The 3D mode icon appears on the thumbnails of 3D images. If you do not switch to 3D mode for the 3D images, they will be displayed in 2D.
- You can see the file name, shooting date, file size and pixel size of the selected photo on the left of the screen (shooting date is only available in the EXIF file format).

3D mode

You can view photos in 3D mode.

- Press **B** to display the "Multimedia menu" screen.
- Press **▲/▼** to select "3D display", and then press **←**.
 - See pages 74 to 83 for details on the 3D function.

NOTE

- In 3D mode, you cannot rotate the photos.
- You can select "3D display" from "Multimedia menu" only when the thumbnails screen for the photo mode in Multimedia mode is displayed on the screen.

Viewing enlarged photos

Buttons for enlarged photo display operation (When using Multimedia mode)

Buttons	Description
	Go to the previous/next photo in the same directory.
RETURN	Return to the thumbnail selection screen.
3D	Switch between 2D and 3D modes.
R button	Rotate the photo by 90 degrees to the left.
G button	Rotate the photo by 90 degrees to the right.
B button	Display "Multimedia menu". <ul style="list-style-type: none"> USB device or SD/SDHC memory card removal
DISPLAY	Reveal the guide display.

NOTE

- Rotating photos only applies to the temporarily selected item and this setting is not saved.

Selecting the picture size for Photo mode

You can select the picture size in "Photo mode".

- Select "Photo mode".
 - Refer to **Selecting modes and drives/servers** on page 65.
- Press **WIDE**.
 - The "Wide mode" menu displays.
- Press **WIDE** or **▲/▼** to select the desired item.
 - As you toggle the options, each is immediately reflected on the screen. There is no need to press **←**.

Item	Description
Auto	Keep the original aspect ratio in an enlarged screen display.
Original	Keeps the original aspect ratio and size.

NOTE

- For "Original" item, if the photo size is larger than 3840 x 2160 vertically or horizontally, the original aspect ratio is kept in full screen display.

Other useful features

Slide show

Selecting the BGM

Setup the slide show BGM from “Select slide show BGM” by pressing **B** when selecting photo thumbnails. This function is available only for the Multimedia mode.

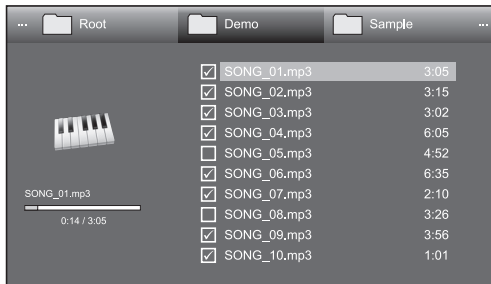

Buttons for slide show BGM select operation

Buttons	Description
↶	When selecting a music file: Play music.
▲/▼/◀/▶ (Cursor)	Select a desired item.
RETURN	When music is stopped: Return to the previous operation. When music is being played: Stop music.
R button	Select/deselect items (✓ mark appears on the selected items).
G button	All*: Stop music. Folder*: Move to the parent folder.
Y button	Play/pause music.
B button	Display “Multimedia menu”. • Set all BGM • Reset all BGM • USB device or SD/SDHC memory card removal

* The mode selected in “Folder display setting”.

NOTE

- Slide show BGM will be reset in the cases below.
 - Select “Reset all BGM” by pressing **B** during selecting music files.
 - Go back to the top menu.
 - Change the “INPUT”.
- When there are invalid music files, the **X** mark will be displayed for the file.
- The displayed play time may differ slightly from the actual play time depending on the files.

Slide show

Buttons for slide show operation (When using Multimedia mode)

Buttons	Description
RETURN	Return to the previous operation.
3D	Switch between 2D and 3D modes.
DISPLAY	Reveal/hide the guide display.
B button	Display the “Multimedia menu”. • Select slide show interval • USB device or SD/SDHC memory card removal

NOTE

- The selected BGMS are played repeatedly.
- The slide show continues until you press **RETURN**.
- Depending on the photo, the slide show interval per photo may be longer than the interval selected in the settings.

Music mode

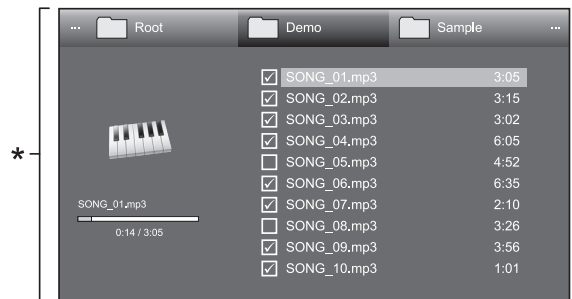

* This screen image is for the Multimedia mode. It may be slightly different in the Home network mode.

Buttons for music mode (When using Multimedia mode)

Buttons	Description
↶	When selecting a music file: Play music.
▲/▼/◀/▶ (Cursor)	Select a desired item.
RETURN	When music is stopped: Return to the previous operation. When music is being played: Stop music.
R button	Select/deselect items (✓ mark appears on the selected items).
G button	All*: Stop music. Folder*: Move to the parent folder.
Y button	Play/pause music.
B button	Display “Multimedia menu”. • Set all auto play • Reset all auto play • USB device or SD/SDHC memory card removal

* The mode selected in “Folder display setting”.

NOTE

- When there are invalid music files, the **X** mark will be displayed for the file.
- The displayed play time may differ slightly from the actual play time depending on the files.

Other useful features

Video mode



Buttons for file selecting operations (When using Multimedia mode)

Buttons	Description
←	When selecting a folder icon: Enter this directory. When selecting a video file: Play the video.
▲/▼/◀/▶ (Cursor)	Select a desired item.
RETURN	Return to the previous operation.
R button	Select/deselect items (✓ mark appears on the selected items).
G button	All*: - Folder*: Move to the parent folder.
Y button	Play from the beginning.
B button	Display the "Multimedia menu". <ul style="list-style-type: none"> • Set all auto play • Reset all auto play • USB device or SD/SDHC memory card removal

* The mode selected in "Folder display setting".

Viewing a video

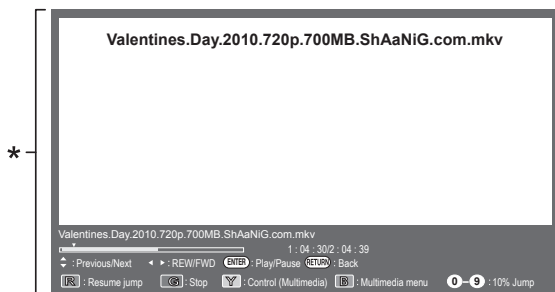

* This screen image is for the Multimedia mode. It may be slightly different in the Home network mode.

Buttons for playing mode (When using Multimedia mode)

Buttons	Description
←	When video is being played: Pause the video. When video is paused: Play the video.
▲ (Cursor)	Go to the beginning of a file by pressing ▲ once and the previous file by pressing ▲ twice.
▼ (Cursor)	Go to the next file.
◀/▶ (Cursor)	Reverse/fast forward a video.

Buttons	Description
RETURN	Go back to the file selection screen.
3D	Switch between 2D and 3D modes.
R button	Start playback from the previously stopped scene.*1
G button	Stop a video.
Y button	Display the Multimedia control panel.
B button	Display "Multimedia menu". <ul style="list-style-type: none"> • Title (edition) • Chapter • Show video information • USB device or SD/SDHC memory card removal
0-9	Jump to scenes at 10% increments (0%–90%). <ul style="list-style-type: none"> • Limited to files without chapters.
DISPLAY	Reveal/hide the guide display.

*1 This function is available only for the Multimedia mode.

Control panel

Press **CONTROL** and the control panel displays and operations for video playback will be available.*

* This screen image is for the Multimedia mode. It may be slightly different in the Home network mode.



◀◀	Video without chapters: Press one time to return to the previous playback point.* Press two times to return to the previous file. Video with chapters: Press one time to return to the previous chapter. Press two times to return to the previous file.
▶▶	Video without chapters: Press one time to advance to the next playback point.* Press two times to display the next file. Video with chapters: Press one time to return to the next chapter. Press two times to return to the next file.

NOTE

- * During playback of a file without chapters, playback points are set automatically. Playback points are set at intervals of a one-tenth of playback time.
- The key guide is shown when playback is resumed.
- You can also display the control panel by selecting "Control (Multimedia)" or "Control (Home network)" from "Option" > "Option for view".
- Reverse/fast forward continues from one file to another during continuous playback in the Multimedia mode. Jump forward/back may not be available depending on the files in the Home network mode.

Selecting the picture size for video mode

You can select the picture size in "Video mode".

- 1 Select "Video mode".
 - Refer to **Selecting modes and drives/servers** on page 65.
- 2 Press **WIDE**.
 - The "Wide mode" menu displays.
- 3 Press **WIDE** or ▲/▼ to select the desired item.
 - As you toggle the options, each is immediately reflected on the screen. There is no need to press ←.

Other useful features

EXAMPLE

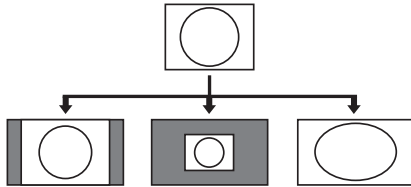

Item	
Auto	Keeps the original aspect ratio in an enlarged screen display.
Original	Keeps the original aspect ratio and size.
Full	An image fully fills the screen.



This is the function to confirm your registration code. You need to register the code at <http://vod.divx.com>.

Go to "HOME" > "TV Menu" > "Setup" > "View setting" > "DivX(R) setup".

● DivX(R) VOD registration

You can find your registration code on this menu. You need to register the TV at <http://vod.divx.com> before playing the DivX content.

● DivX(R) VOD deregistration

You can find your deregistration code on this menu. You need to deregister the TV at <http://vod.divx.com> to release the registration.

USB device/SD memory card compatibility

USB device	USB memory, USB card reader (Mass Storage class), USB HDD
SD card	SD/SDHC memory card
File system	FAT/FAT32/NTFS* (*USB hard drive only)
Photo file format	JPEG (.jpg) (DCF2.0 compliant), MP (.mpo) (CIPA DC-007)
Music file format	<ul style="list-style-type: none"> MP3 (.mp3) Bitrate: 32 k, 40 k, 48 k, 56 k, 64 k, 80 k, 96 k, 112 k, 128 k, 160 k, 192 k, 224 k, 256 k, 320 kbps Sampling frequency: 32 k, 44.1 k, 48 kHz FLAC (.flac) Bitrate: 128 kbps ~ 2304 kbps Sampling frequency: 8 k, 16 k, 22.05 k, 24 k, 32 k, 44.1 k, 48 k, 88.2 k, 96 kHz WMA (.wma) Bitrate: 32 kbps ~ 192 kbps Sampling frequency: 8 k, 11.025 k, 16 k, 22.05 k, 32 k, 44.1 k, 48 kHz
Subtitle file format	SRT/SUB/ASS/SSA/SMI

Video file format			
File extension	Container	Video	Audio
.avi	AVI	DivX 3.11/4.x/5.1/6.0 XviD H.264 MPEG4 Motion Jpeg	MP3 Dolby Digital LPCM ADPCM
.mkv	MKV	DivX 3.11/4.x/5.1/6.0 XviD H.264 MPEG4	MP3 Dolby Digital DTS LPCM ADPCM
.asf .wmv	ASF	DivX 3.11/4.x/5.1/6.0 XviD MPEG4 VC-1 Windows Media Video V9	MP3 Dolby Digital LPCM WMA
.mp4 .mov	MP4	H.264 MPEG4 Motion Jpeg	MP3 AAC Dolby Digital Dolby Digital Plus
.mpg .mpeg	PS	MPEG2 MPEG1	Dolby Digital MPEG LPCM
.flv	FLV	Sorenson H.264	MP3 AAC

NOTE

- Progressive format jpeg files are not supported.
- Files in USB 1.1 devices may not be played properly.
- Operation using USB hubs is not guaranteed.
- Some video file formats may not be played depending on the file.
- Files may not be playable depending on the bitrate.
- Some USB devices and SD/SDHC memory card may not work properly depending on the file system.
- If you insert any card other than the SD/SDHC (class 6 or higher), it will not work.

Home network server compatibility

Photo file format	JPEG
Music file format	LPCM, MP3
Video file format	MPEG2-PS, MPEG2-TS, WMV, ASF, MP4, MOV, AVI

NOTE

- Progressive format jpeg files are not supported.
- Some video file formats may not be played depending on the file and server.

Connecting a PC

Connecting a PC

HDMI connection

PC HDMI 1, 2, 3 or 4 terminals

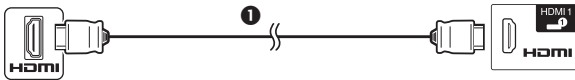

① HDMI-certified cable

PC HDMI 2 terminal*

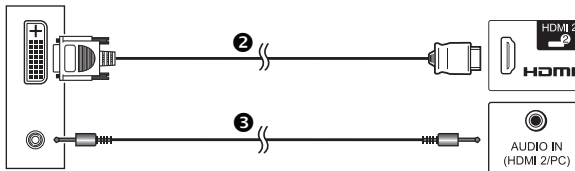

② DVI/HDMI cable

③ ϕ 3.5 mm stereo minijack cable

* When using the HDMI 2 terminal, you must select the proper item in the "Audio select" menu depending on the type of HDMI cable connected (refer to page 48 for details).

Analogue connection

PC PC terminal*

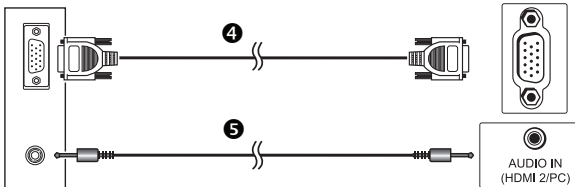

④ RGB cable

⑤ ϕ 3.5 mm stereo minijack cable

PC PC terminal*

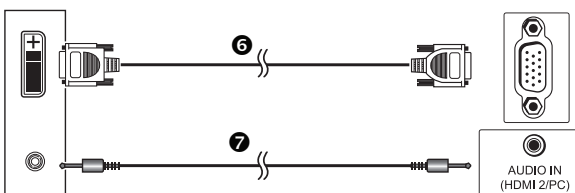

⑥ DVI/RGB conversion cable

⑦ ϕ 3.5 mm stereo minijack cable

* When using the PC terminal, you must select "Video + Audio" in the "Audio select" menu (refer to page 48 for details).

NOTE

- Refer to page 71 for a list of PC signals compatible with the TV.

Displaying a PC image on the screen

Selecting the picture size

You can select the picture size.

- Press **WIDE**.
 - The "Wide mode" menu displays.
- Press **WIDE** or **▲/▼** to select the desired item.

EXAMPLE

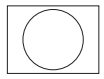
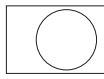
Input signal		
	1024 × 768	1360 × 768

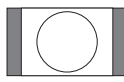
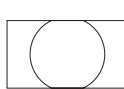
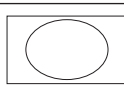
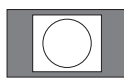

Normal		Keeps the original aspect ratio in a full screen display.
Cinema		For viewing wide screen programmes. The top and bottom of the image is slightly cropped (only 1024 × 768 signals).
Full		An image fully fills the screen.
Dot by Dot		Detects the resolution of the signal and displays an image with the same number of pixels on the screen.

NOTE

- You can also select an item from "HOME" > "TV Menu" > "Setup" > "Option" > "Option for view" > "Wide mode".
- Connect the PC before making adjustments.
- Selectable picture size may vary with input signal type.
- You may not be able to change the wide mode while in 3D mode.
- Refer to page 47 for AV signals.
HDMI: 480i/480p/576i/576p/720p/1080i/1080p
ANALOGUE RGB: 576p/720p (50 Hz)/1080i
- The PC terminal is not compatible with 480i/576i/1080p signals.

Connecting a PC

Adjusting the PC image automatically



Option

Auto sync.

This function enables the screen to be automatically adjusted to its best possible condition when the analogue terminals of the TV and PC are connected with a commercially available DVI/RGB conversion cable, etc.

- 1 Press to select "PC" from the "INPUT" menu, and then press .
- 2 Go to "HOME" > "TV Menu" > "Setup" > "Option" > "Terminal setting" > "PC signal setting" > "Auto sync."

NOTE

- When "Auto sync." is successful, "Auto Sync completed successfully" displays. If not, "Auto sync." failed.
- Auto Sync. is likely to succeed when an input PC image has wide vertical stripes (e.g. pattern with high contrast stripes, or cross-hatched). It may fail when an input PC image is solid (low contrast).
- "Auto sync." may fail even if "Auto Sync completed successfully" displays.
- "Auto sync." may fail if the PC image has low resolution, has unclear (black) edges, or is moved while executing "Auto sync."
- Be sure to connect the PC to the TV and switch it on before starting "Auto sync."
- "Auto sync." can be executed only when inputting analogue signals through the PC terminal.
- This function is available for 3D images converted from 2D images or normal 2D images.

Adjusting the PC image manually



Option

Fine sync.

Ordinarily you can easily adjust the picture as necessary to change image position using "Auto sync.". In some cases, however, manual adjustment is needed to optimise the image.

- 1 Press to select "PC" from the "INPUT" menu, and then press .
- 2 Go to "HOME" > "TV Menu" > "Setup" > "Option" > "Terminal setting" > "PC signal setting" > "Fine sync."
- 3 Press / to select the specific adjustment item.
- 4 Press / to adjust the item to the desired position.

Item	
H-Pos.	Centres the image by moving it to the left or right.
V-Pos.	Centres the image by moving it up or down.
Clock	Adjusts when the image flickers with vertical stripes.
Phase	Adjusts when characters have low contrast or when the image flickers.

NOTE

- For resetting all adjustment items to the factory preset values, press / to select "Reset", and then press .
- "Clock" and "Phase" in the "Fine sync." menu can be adjusted only when inputting analogue signals through the PC terminal.
- Images may not be displayed properly depending on the settings and/or input signals.
- This function is available for 3D images converted from 2D images or normal 2D images.

PC compatibility chart

Resolution		Horizontal frequency	Vertical frequency	Analogue (D-Sub)	Digital (HDMI)	VESA standard
VGA	640 x 480	31.5 kHz	60 Hz	✓	✓	✓
SVGA	800 x 600	37.9 kHz	60 Hz	✓	✓	✓
XGA	1,024 x 768	48.4 kHz	60 Hz	✓	✓	✓
WXGA	1,360 x 768	47.7 kHz	60 Hz	✓	✓	✓
SXGA	1,280 x 1,024	64.0 kHz	60 Hz	✓	✓	✓
SXGA+	1,400 x 1,050	65.3 kHz	60 Hz	✓	✓	✓
UXGA	1,600 x 1,200	75.0 kHz	60 Hz	✓	✓	✓
1080p	1,920 x 1,080	67.5 kHz	60 Hz	✓	✓	

VGA, SVGA, XGA, WXGA, SXGA, SXGA+ and UXGA are registered trademarks of International Business Machines Corporation.

NOTE

- This TV has only limited PC compatibility, correct operation can only be guaranteed if the video card conforms exactly to the VESA 60 Hz standard. Any variations from this standard will result in picture distortions.

Connecting a PC

PC control of the TV

- When a programme is set, the TV can be controlled from the PC using the RS-232C or IP. The input signal (PC/video) can be selected, the volume can be adjusted and various other adjustments and settings can be made, enabling automatic programmed playing.
- Use an RS-232C serial control cable (cross type), ETHERNET cable (commercially available) or wireless LAN USB adapter for the connections.

NOTE

- This PC control should be used by a person who is accustomed to using PCs.

Communication conditions for IP

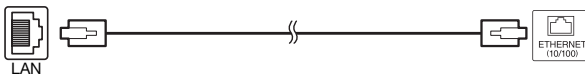

ETHERNET cable
(commercially available)

Connect to the TV with the following settings made for IP on the PC.

IP protocol	TCP/IP
Host IP address	Set the IP address on the TV menu.
Service	None (do not select Telnet or SSH).
TCP port#	Set a port number on the TV menu (Control port).

When you set your ID and password on the TV menu, you need to enter them as soon as you connect to the TV.

NOTE

- The connection will be cut off when there has been no communication for 3 minutes.

View setting IP Control setup

- Go to "HOME" > "TV Menu" > "Setup" > "View setting" > "Network setup" > "IP Control setup".
- [Control setting]
This function is set to enable IP Control.
- [Detail setting]
You can set up Login ID, Password and Control port for using IP Control.

Communication conditions for RS-232C



RS-232C serial control cable (cross type)
(commercially available)

Set the RS-232C communications settings on the PC to match the TV's communications conditions. The TV's communications settings are as follows:

Baud rate	9,600 bps
Data length	8 bits
Parity bit	None
Stop bit	1 bit
Flow control	None

Communication procedure

Send the control commands from the PC via the RS-232C connector.

The TV operates according to the received command and sends a response message to the PC.

Do not send multiple commands at the same time. Wait until the PC receives the OK response before sending the next command.

Make sure to send "A" with the carriage return and confirm that "ERR" returns before operating.

Command format

Eight ASCII codes +CR

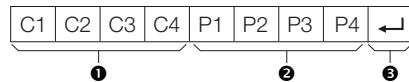

- Command four digits: Command. The text of four characters.
- Parameter four digits: Parameter 0-9, blank, ?, minus
- Return code (ODH): ↵

Parameter

Input the parameter values, aligning left, and fill with blank(s) for the remainder (be sure that four values are input for the parameter).

When the input parameter is not within an adjustable range, "ERR" returns (refer to "Response code format").

0			
0	0	0	9
1	0	0	
0	0	5	5

When "?" is input for some commands, the present setting value responds.

?	?	?	?
---	---	---	---

Response code format

Normal response



Return code (ODH)

Problem response
(communication error or incorrect command)



Return code (ODH)

Command list

CONTROL ITEM	COMMAND	PARAMETER	CONTROL CONTENTS
POWER SETTING	P O W R 0 _ _ _		POWER OFF (STANDBY)
INPUT SELECTION	I T G D _ _ _ _		INPUT SWITCHING (TOGGLE)
	I T V D _ _ _ _		TV (CHANNEL FIXED)
	I D T V _ _ _ _		DTV (CHANNEL FIXED)
CHANNEL	I A V D * _ _ _		HDMI 1-4 (1-4), INPUT 5-6 (5-6), PC (7)
	D C C H * * _ _		TV DIRECT CHANNEL (1-99)
	C H U P _ _ _ _		CHANNEL UP
	C H D W _ _ _ _		CHANNEL DOWN
	D T V D * * * _		DTV DIRECT CHANNEL (1-999)
	D T U P _ _ _ _		DTV CHANNEL UP
AV MODE SELECTION	D T D W _ _ _ _		DTV CHANNEL DOWN
	A V M D 0 _ _ _		TOGGLE
	A V M D 1 _ _ _		STANDARD
	A V M D 2 _ _ _		MOVIE
	A V M D 3 _ _ _		GAME
	A V M D 4 _ _ _		USER
	A V M D 5 _ _ _		DYNAMIC (Fixed)
	A V M D 6 _ _ _		DYNAMIC
	A V M D 7 _ _ _		PC
	A V M D 1 4 _ _		STANDARD (3D)* ¹
	A V M D 1 6 _ _		GAME (3D)* ¹
	A V M D 1 0 0 _		AUTO
VOLUME	V O L M * * * _		VOLUME (0-100)
POSITION	H P O S * * * _		H-POSITION (AV/PC) (-nn- <i>nn</i>)
	V P O S * * * _		V-POSITION (AV/PC) (-nn- <i>nn</i>)
	C L C K * * * _		CLOCK (0-180)
	P H S E * * _ _		PHASE (0-40)
WIDE MODE	W I D E 0 _ _ _		TOGGLE (AV)
	W I D E 1 _ _ _		NORMAL (AV)
	W I D E 2 _ _ _		ZOOM 14:9 (AV)
	W I D E 3 _ _ _		PANORAMA (AV)
	W I D E 4 _ _ _		FULL (AV/Multimedia-Video/Home network-Video)
	W I D E 5 _ _ _		CINEMA 16:9 (AV)
	W I D E 6 _ _ _		CINEMA 14:9 (AV)
	W I D E 7 _ _ _		NORMAL (PC)
	W I D E 8 _ _ _		CINEMA (PC)
	W I D E 9 _ _ _		FULL (PC)
	W I D E 1 0 _ _		DOT by DOT (AV/PC)
	W I D E 1 1 _ _		UNDERSCAN (AV)
	W I D E 1 2 _ _		AUTO (Multimedia-Video/Home network-Video)
	W I D E 1 3 _ _		ORIGINAL (AV/Multimedia-Video/Home network-Video)

CONTROL ITEM	COMMAND	PARAMETER	CONTROL CONTENTS
MUTE	M U T E 0 _ _ _		TOGGLE
	M U T E 1 _ _ _		MUTE
	M U T E 2 _ _ _		MUTE OFF
SURROUND	A C S U 0 _ _ _		SURROUND TOGGLE
	A C S U 1 _ _ _		SURROUND NORMAL
	A C S U 2 _ _ _		SURROUND OFF
	A C S U 4 _ _ _		SURROUND 3D HALL
	A C S U 5 _ _ _		SURROUND 3D MOVIE
	A C S U 6 _ _ _		SURROUND 3D STANDARD
AUDIO CHANGE	A C S U 7 _ _ _		SURROUND 3D STADIUM
	A C H A _ _ _ _		TOGGLE
SLEEP TIMER	O F T M 0 _ _ _		OFF
	O F T M 1 _ _ _		SLEEP TIMER 30 MIN
	O F T M 2 _ _ _		SLEEP TIMER 1 HOUR
	O F T M 3 _ _ _		SLEEP TIMER 1 HOUR 30 MIN
	O F T M 4 _ _ _		SLEEP TIMER 2 HOUR
	O F T M 5 _ _ _		SLEEP TIMER 2 HOUR 30 MIN
TELETEXT	T E X T 0 _ _ _		TEXT OFF
	T E X T 1 _ _ _		TEXT ON (TOGGLE)
	D C P G * * * _		DIRECT PAGE JUMP (100-899)
3D	T D C H 0 _ _ _		3D OFF
	T D C H 1 _ _ _		2D → 3D
	T D C H 2 _ _ _		SIDE BY SIDE
	T D C H 3 _ _ _		TOP AND BOTTOM
	T D C H 4 _ _ _		3D → 2D (SIDE BY SIDE)
	T D C H 5 _ _ _		3D → 2D (TOP AND BOTTOM)
	T D C H 6 _ _ _		3D AUTO
T D C H 7 _ _ _		3D → 2D* ¹	
DEVICE NAME	T V N M 1 _ _ _		DISPLAY THE DEVICE NAME
SOFTWARE VERSION	S W V N 1 _ _ _		DISPLAY THE SOFTWARE VERSION
IP PROTOCOL VERSION	I P P V 1 _ _ _		DISPLAY THE IP PROTOCOL VERSION

*¹ These commands are available only during 3D mode.

NOTE

- If an underbar (_) appears in the parameter column, enter a space.
- If an asterisk (*) appears, enter a value in the range indicated in brackets under CONTROL CONTENTS.
- Some command on DTV operation may not work in setting of some country.

Enjoying 3D image viewing

You can enjoy 3D-supported images on this TV when you wear 3D glasses.

To produce 3D images, liquid crystal shutters in the 3D glasses alternately open and close imperceptibly fast to exactly match alternating left and right video images displayed by the TV.

NOTE

- Refer to the operation manual of the 3D glasses for details regarding usage.
- Some menu items are greyed out in 3D mode. This is not a malfunction.

Before using the 3D glasses

- Not all consumers can experience and enjoy 3D TV. Some people suffer from stereo blindness which prevents them from perceiving the intended depth of 3D entertainment. Also, some people who watch 3D programming may experience initial feelings of motion sickness as they adjust to the picture. Others may experience headaches, eye fatigue or motion sickness. Some viewers might also experience epileptic seizures. Like a roller coaster, the experience is not for everyone.
- The 3D glasses are precision equipment. Handle them with care.
- Improper use of the 3D glasses or failure to follow these instructions can result in eye strain.
- If you experience dizziness, nausea, or other discomfort while viewing 3D images, immediately discontinue use of the 3D glasses. Using the 3D TV with incompatible 3D broadcasts or software can make images appear blurry or create overlapping images.
- When viewing 3D images continuously, be sure to take a break periodically to prevent eye strain.
- If you are nearsighted or farsighted or have astigmatism or a different level of eyesight between the left and right eyes, you should take the necessary steps, such as wearing eyeglasses, to correct your eyesight before viewing 3D images. The 3D glasses can be worn over eyeglasses.
- When viewing 3D images, keep the 3D glasses horizontally level with the TV screen. If you tilt the 3D glasses with respect to the TV screen, the images viewed by the left and right eyes may appear significantly different or images may appear overlapping.
- View 3D images at the appropriate distance from the TV screen. The recommended distance is three times the effective height of the TV screen.
- Be careful of your surroundings when viewing 3D images. When you view 3D images, objects may appear closer or farther than they are. This may cause you to misjudge the distance and possibly result in injury if you accidentally hit the screen or surrounding objects.
- The 3D glasses are not recommended for people aged less than 6.
- When children are viewing 3D images, be sure a parent or guardian is present. Monitor children viewing 3D images, and if they show signs of discomfort, immediately discontinue use of the 3D glasses.
- People with a known history of photosensitivity and people with heart problems or poor health should not use the 3D glasses. This can worsen existing health conditions.
- Do not use the 3D glasses for other purposes (such as general eyeglasses, sunglasses, or protective goggles).
- Do not use the 3D function or 3D glasses while walking or moving around. This may result in injuries due to running into objects, tripping, and/or falling.
- When using the 3D glasses, take care not to accidentally strike the TV screen or other people. Viewing 3D images may cause you to misjudge the distance to the TV screen and accidentally strike the screen, resulting in possible injury.
- It is recommended that you do not view 3D images if you are sleep deprived or if you have been drinking alcohol.



indicates compatibility between TV products and 3D Glasses which are compliant with the "Full HD 3D Glasses™" format, and does not indicate picture quality of TV products.

Preparing for the 3D glasses

Part Names

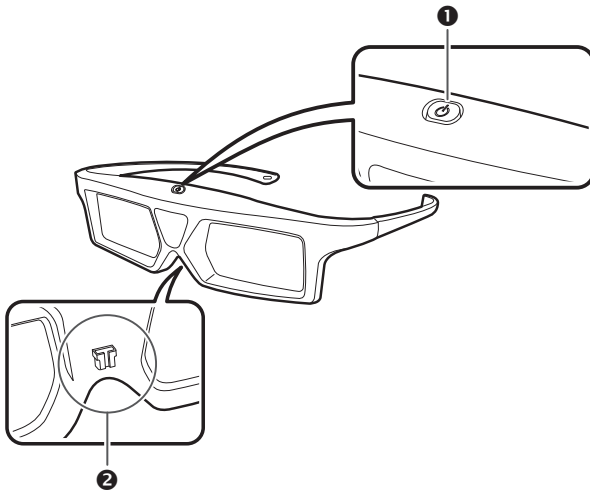

❶ Power button and LED indicator

❷ Nose pad

NOTE

- The power turns off automatically when the 3D glasses are not operated in standby for approximately 15 seconds

1 Power button

- When the power button is pressed for 2 or more seconds with the power off, pairing with the TV starts.
- When the power button is pressed for 2 or more seconds with the power on, the power turns off.
- When paired, the power will turn off if the power button is pressed for 2 or more seconds.
- When the 3D glasses are in 3D mode with the power on, pressing the power button for less than 2 seconds will turn the 3D glasses to 2D mode.
- When the 3D glasses are in 2D mode with the power on, pressing the power button for less than two seconds will turn the 3D glasses to 3D mode.
- When paired, the 3D glasses will be non-reactive if the power button is pressed for less than 2 seconds.

LED indicator

- When paired with the TV, the LED light blinks in green.
- When the power is turned on, the LED lights up in green for 3 seconds.
- When in 3D mode, the LED blinks in green in 3-second intervals.
- When in 2D mode, the LED blinks in red in 3-second intervals.
- When the power is turned off, the LED lights up in red for 3 seconds.

NOTE

- When in low voltage mode:
 - When in 3D mode, the LED blinks in green in 3-second intervals.
 - When in 2D mode, the LED blinks in red in 3-second intervals.

2 Nose pad mount

- The dedicated nose pad can be mounted here.

Enjoying 3D image viewing

Using the 3D glasses

Before using the 3D Glasses

Before using the 3D glasses for the first time, remove the insulating sheet attached to them.

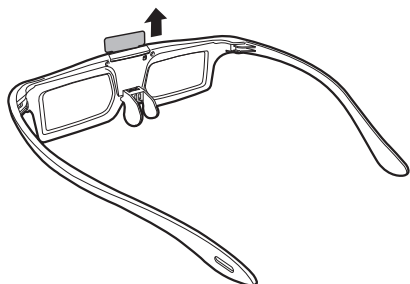

Attaching the Nose Pad

Attach either of the supplied nose pads as needed (such as when the glasses do not fit properly). The glasses come with a large and small nose pad.

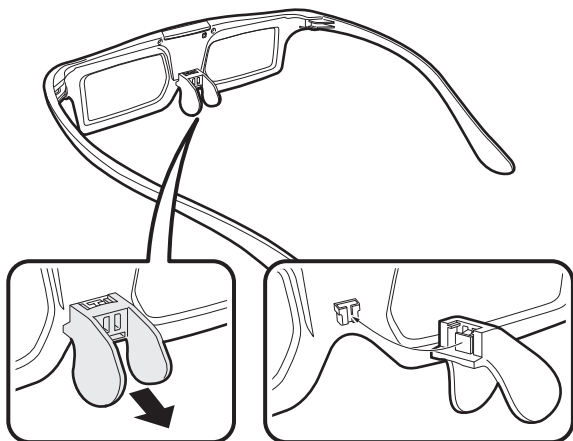

Removing the nose pad

Attaching the nose pad

Using the 3D glasses

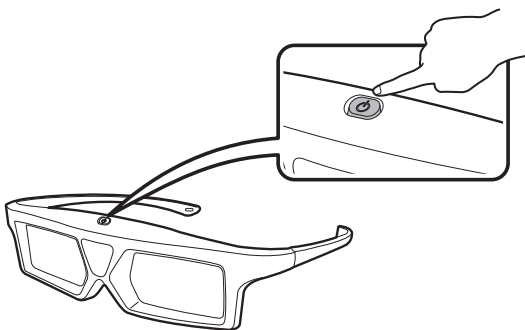

Pairing the 3D glasses

To view 3D images, it is necessary to pair the 3D glasses and TV.

- To confirm pairing of the 3D glasses and TV, make sure that 3D images are displayed on the TV screen.
- When the power button is pressed for 2 or more seconds with the power off, pairing with the TV starts. When pairing is completed successfully, the LED lights up in green for 3 seconds.
- To switch between 2D and 3D modes, briefly press the power button.

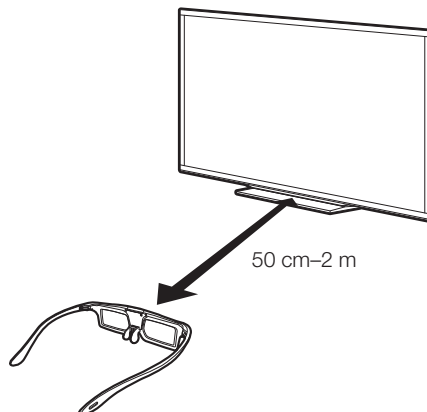

NOTE

- When paired, make sure that the 3D glasses are kept at a distance of 50 cm–2 m from the TV. If too close, pairing cannot be performed.

Switching to 3D and 2D Mode

When viewing 3D images, you can press the power button to switch between 2D and 3D modes. This is useful when several people are viewing 3D images on the same TV with some people wanting to watch in 3D and some people wanting to watch in 2D.

● Viewing 2D images

When you press and hold for less than 2 seconds while viewing 3D images, the LED light blinks in red and the 3D images switch to 2D images.

● Viewing 3D images

When you press and hold for less than 2 seconds while viewing 2D images, the LED light blinks in green and the 2D images switch to 3D images.

Usage Range of the 3D Glasses

The 3D glasses can be used by receiving a signal sent from the TV.

The 3D glasses turn off automatically after 15 seconds if no signal is received from the TV.

● Operating range

From directly the TV: approx. 5 m (within approx. 30° horizontally and 20° vertically)

Enjoying 3D image viewing

Replacing the Battery

The battery has an expected service life of approximately 75 hours.

- When replacing the button battery, use only the designated battery (Maxell branded CR2025 lithium button battery).

- 1 Use the tip of a ballpoint pen or similar object to press in on the lock.

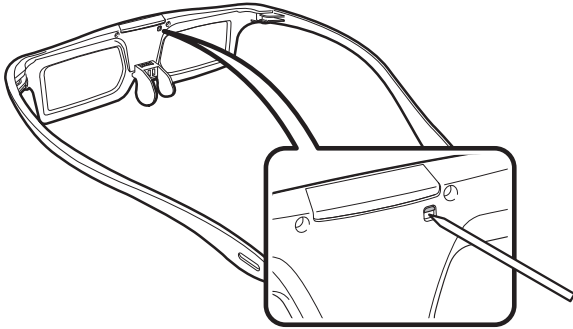

- 2 While pressing in on the lock, place your fingertip in the groove and pull out the battery holder.
 - Pull the battery holder all the way out.

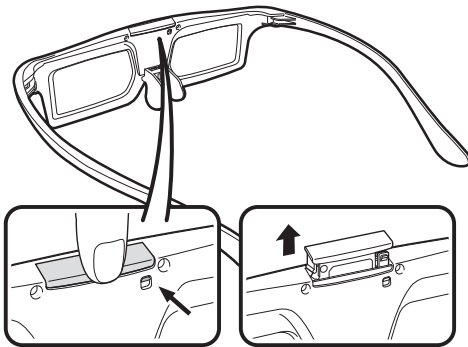

- 3 Replace the battery.

- ① Use the tip of a ballpoint pen or similar object to remove the battery.
- ② Insert a new battery.
 - Insert the battery with the negative side (-) facing up.

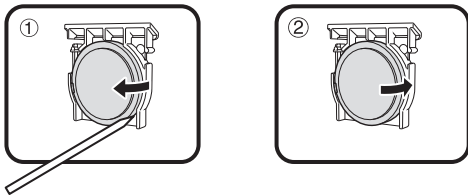

- 4 Align the battery holder with the battery slot on the 3D glasses and slide it back into place.
 - Press it in until it locks.

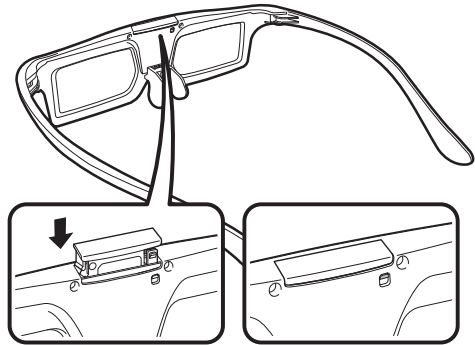

NOTE

- Take care not to reverse the battery poles (+) and (-) when loading the battery.
- Used batteries should be disposed of strictly in accordance with the applicable local laws and regulations.

Cautions for 3D image viewing

3D glasses lenses

- Do not apply pressure to the lenses of the 3D glasses. Also, do not drop or bend the 3D glasses.
- Do not scratch the surface of the lenses of the 3D glasses with a pointed instrument or other object. Doing so may damage the 3D glasses and reduce the quality of the 3D image.
- Use only the cloth provided with the 3D glasses to clean the lenses.

3D glasses infrared receiver

- Do not allow the infrared receiver to become dirty, and do not attach stickers to or otherwise cover the infrared receiver. Doing so may prevent the receiver from operating normally.
- If the 3D glasses are affected by other infrared data communication equipment, 3D images may not be displayed correctly.





Caution during viewing

- Do not use devices that emit strong electromagnetic waves (such as cellular phones or wireless transceivers) near the 3D glasses. Doing so may cause the 3D glasses to malfunction.
- The 3D glasses cannot operate fully at extreme high or low temperatures. Please use them within the specified usage temperature range.
- If the 3D glasses are used in a room with fluorescent lighting, the light within the room may appear to flicker. In this case, either darken or turn off the fluorescent lights when using the 3D glasses.
- Wear the 3D glasses correctly. 3D images will not be correctly visible if the 3D glasses are worn upside down or back-to-front.
- Other displays (such as computer screens, digital clocks, and calculators) may appear dark and difficult to view while wearing the 3D glasses. Do not wear the 3D glasses when watching anything other than 3D images.
- If you lie on your side while watching the TV with 3D glasses, the picture may look dark or may not be visible.
- Be sure to stay within the viewing angle and optimum TV viewing distance when watching 3D images. Otherwise, you may not be able to enjoy the full 3D effect.
- The 3D glasses may not work properly if there is any other 3D product or electronic devices turned on near the glasses or TV. If this occurs, turn off the other 3D product or electronic devices or keep the devices as far away as possible from the 3D glasses.
- Stop using this product in any of the following situations:
 - When images consistently appear doubled while you are wearing the 3D glasses
 - When you have difficulty perceiving the 3D effect
- If the 3D glasses are faulty or damaged, stop using them immediately. Continued use of the 3D glasses may cause eye fatigue, headaches and illness.
- If you have any abnormal skin reaction, stop using the 3D glasses. In very rare instances, such reactions may be due to an allergic reaction to the coating or materials used.
- If your nose or temples become red or you experience any pain or itchiness, stop using the 3D glasses. Pressure caused by long periods of use may lead to such reactions and may result in skin irritation.
- You may not be able to use several menu items while you are watching the TV in 3D mode.
- You cannot use the 3D function in radio or data mode.

NOTE

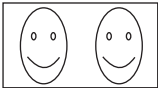
- These 3D glasses are only for use with SHARP LCD TVs supporting 3D.

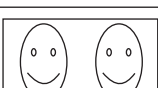
Display format for 3D and 2D images

	Image for input signals	Selectable mode	Description
3D mode (using the 3D glasses)		2D → 3D	• Converts normal 2D images into 3D images.
		Side by Side	• Creates 3D images from 3D images displayed side by side. The image is split into a left and right image, and then the images are stretched and displayed sequentially to create a 3D image.
		Top and Bottom	• Creates 3D images from 3D images displayed on the top and bottom. The image is split into a top and bottom image, and then the images are stretched and displayed sequentially to create a 3D image.
2D mode (without using the 3D glasses)		Side by Side → 2D	• Creates 2D images from 3D images displayed side by side. Only the left image is stretched and displayed. The image does not appear in 3D.
		Top and Bottom → 2D	• Creates 2D images from 3D images displayed on the top and bottom. Only the top image is stretched and displayed. The image does not appear in 3D.

Viewing 3D images

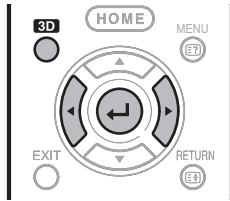

NOTE

- The TV screen may temporarily become black when the TV is trying to detect a 3D image signal and when switching from 3D to 2D mode.

Receiving a 3D image signal that can be detected automatically

The image signal may contain a 3D identification signal. You can enable the TV to automatically detect the 3D image type (Page 78).

- Go to "HOME" > "TV Menu" > "Setup" > "Option" > "3D setup" > "3D auto change".

● When "3D auto change" is set to "Mode 1" or "Mode 2"

- The 3D display format is detected automatically and the appropriate 3D image is displayed.

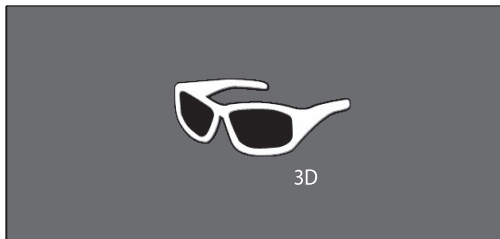

● When "3D auto change" is set to "Off"

- The confirmation message is displayed. Press **3D**.
- Press **◀/▶** to select "Yes", and then press **↵**.

2 Turn on the power of the 3D glasses, and then wear the 3D glasses.

- Press the power button for at least two seconds.
- The LED light blinks three times.

NOTE

- If you do not want to switch to 3D mode automatically, set "3D auto change" to "Off".
- When the TV is receiving a 3D image signal that can be detected automatically, the 3D mode icon is displayed in the channel display.

Switching 3D to 2D mode

When you press **3D** while you are watching the TV in 3D mode, the TV switches to 2D mode.

- Press **3D** during the 3D mode.
- Select "Yes", and then press **↵** to switch to 2D mode.

3 Take off the 3D glasses and turn off the power of the 3D glasses.

- Press the power button for at least two seconds.
- The LED light lights for two seconds.

NOTE

- If the input signal switches to 2D, 2D images are displayed automatically.
- 3D mode is cancelled automatically when the setting is changed, input source is changed, the input signal resolution is changed or the power is turned off.

Receiving a 3D image signal that cannot be detected automatically

When the TV receives a 3D image signal that cannot be detected automatically, you can select between 3D and 2D image viewing.

1 Press **3D**.

- A screen appears prompting you to select between 3D and 2D image viewing.



2 Press **◀/▶** to select "3D" or "2D", and then press **↵**.

● To view in 3D mode

- Press **◀/▶** to select the 3D signal type ("2D → 3D", "Side by Side" or "Top and Bottom"), and then press **↵**.

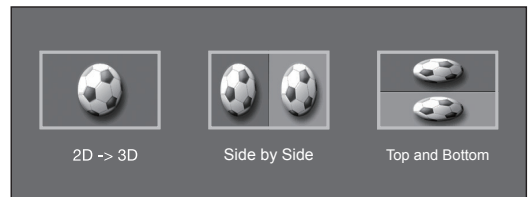

- If you select the same system as that of the input signal, 3D images are displayed.
- You can select only "2D → 3D" in TV mode.
- Turn on the power of the 3D glasses, and then wear the 3D glasses.
 - Press the power button for at least two seconds.
 - The LED light blinks three times.

● To view in 2D mode

- Switching from 3D to 2D mode.

Press **◀/▶** to select the 2D signal type ("Side by Side" or "Top and Bottom"), and then press **↵**.

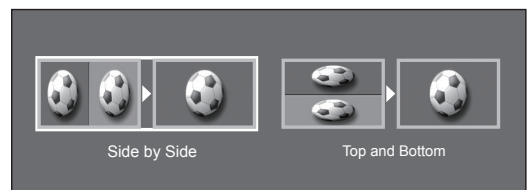

- If you select the same system as that of the input signal, 2D images are displayed.

Enjoying 3D image viewing

Watching 2D images in 3D

You can convert normal 2D images into 3D images.

- 1 Press **3D**.
- 2 Press **◀/▶** to select “2D → 3D”, and then press **↵**.
- 3 Turn on the power of the 3D glasses, and then wear the 3D glasses.

NOTE

- The confirmation message to select either 3D or 2D mode is displayed on the screen once per hour.
- When the TV converts normal 2D images into 3D images, you can display the “2D → 3D convert effect” menu to adjust the convert effect by pressing **Y**.

Switching to the previous mode

You can switch back to the previous mode by pressing **3D**.

- 1 Press **3D**.
 - A confirmation message is displayed.
- 2 Select “Yes”, and then press **↵**.
 - The TV returns to the previous mode.

3D Menu

Pressing **3D** in 3D mode displays the 3D menu. Press the coloured buttons to make the necessary settings.



Buttons	Description
G button	Surround (Page 40). <ul style="list-style-type: none"> • The surround mode changes each time you press G.
Y button	2D → 3D convert effect (Page 81). <ul style="list-style-type: none"> • “2D → 3D convert effect” is available only when selecting “2D → 3D” (refer to Watching 2D images in 3D shown above).
B button	3D setup (Page 81).

Configuring the TV settings to enhance 3D image viewing

You can make various settings to enhance 3D image viewing.

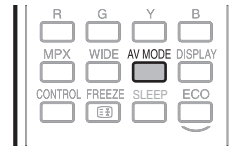

3D picture adjustments

● Basic operation

Go to “HOME” > “TV Menu” > “Setup” > “Picture” > select/adjust the item you want to set.

NOTE

- Which items can be selected/adjusted differs depending on whether the TV is in 2D mode or in 3D mode.

AV mode

The audio and video settings can be changed to suit the programme or input content being watched.

	Item
STANDARD (3D)	For a highly defined image in a normal lighting.
GAME (3D)	Lowers image brightness for easier viewing.

NOTE

- You can select “AV mode” by pressing **AV MODE** on the remote control unit.

Enjoying 3D image viewing

3D setup

Basic operation

Go to “HOME” > “TV Menu” > “Setup” > “Option” > “3D setup” > select the menu you want to set.

3D auto change

This function allows the TV to switch to 3D mode automatically when a 3D identification signal is detected.

Item	
Mode 1	3D mode is selected automatically when a 3D signal is detected while viewing video from a VOD service or HDMI-connected equipment.
Mode 2	3D mode is selected automatically when, in addition to detecting a 3D signal while viewing video from a VOD service or HDMI-connected equipment, a video pattern with “Side by Side” or “Top and Bottom” format is also detected.
Off	Auto change is not performed.

NOTE

- 3D signals may not be detected depending on the signal format.

3D depth control

Select the method for adjusting the 3D depth.

Item	
Auto	Adjusts the depth automatically.
Manual	Manually adjusts the depth using the function “Depth change”.

NOTE

- This function is only available when the input signal is 3D.
- This function is not displayed depending on the type of 3D signal.

Depth change

Adjusts the depth manually. “0” is the level where no adjustment is made.

NOTE

- This function is only available when “3D depth control” is “Manual”.

2D → 3D convert effect

You can adjust the 3D effect when converting images from 2D mode to 3D mode. Select a desired level of convert effect from +1 to +16.

NOTE

- This function is only available when converting 2D images to 3D images.
- When you use this function, image conversion on the TV will result in some differences in the original images and how they appear.
- 2D images that have been converted to 3D images may be viewed only for personal use.

Viewing time info

This function allows you to display the elapsed time of 3D image viewing on the screen.

Item	
Yes	The elapsed time is displayed in one-hour increments after you start watching 3D images.
No	Hide the time.

3D test

This function displays 3D images for testing the 3D operation. Clicking “Start” on the screen plays back 3D test images.

NOTE

- If you press **EXIT** during playback, the previous screen will be displayed.

Enjoying 3D image viewing

Specifications — 3D glasses

Product	3D Glasses
Lens type	Liquid crystal shutter
Power supply	DC3V
Battery	Lithium button battery (CR2025 x 1)
Battery life	Approx. 100 hours of continuous use
Dimension (W x H x D)	171 x 42.6 x 165.3 mm
Weight	Approx. 31.0 g (including the lithium battery)
Operating temperature	10°C to 40°C (The 3D glasses cannot operate fully at extreme high or low temperatures. Please use them within the specified usage temperature range.)

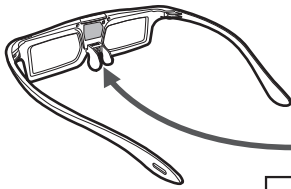

The product serial number is displayed on the 3D glasses as indicated in the illustration on the left. From the right to three digits represent the date of manufacture.

Example: Manufactured on February 23, 2013

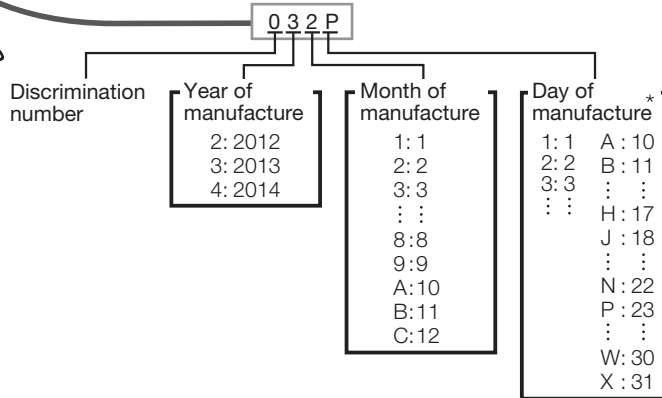



* "I", "O", "Y" and "Z" are not used.

NOTE

- Please contact your local authority for the correct method of disposal of this product and/or packing.

Troubleshooting – 3D Images

Problem	Possible solution
<ul style="list-style-type: none"> 3D images are not displayed. 	<ul style="list-style-type: none"> Is “3D auto change” set to “Off”? Press 3D to switch to 3D mode (Page 81). If “3D auto change” is set to “Mode1” or “Mode2” but no 3D images are displayed, check the display format of the content being viewed. Some 3D image signals may not be recognized as 3D images automatically. Press 3D to select the appropriate display format for the 3D image (Page 81). Is the power of the 3D glasses turned on? Press the power button for at least 2 seconds to turn on the 3D glasses. Are the 3D glasses set to 2D mode? Press the power button for an amount of time that is less than 2 seconds to switch the 3D glasses to 3D mode. Is there an obstacle between the 3D glasses and the TV, or is something covering the receiver on the 3D glasses? The 3D glasses operate by receiving a signal from the TV. Do not place anything between the 3D emitter on the TV and the receiver on the 3D glasses.
<ul style="list-style-type: none"> Images displayed in 3D mode appear doubled while you are wearing the 3D glasses. 	<ul style="list-style-type: none"> Is the power of the 3D glasses turned on? Press the power button for at least 2 seconds to turn on the 3D glasses.
<ul style="list-style-type: none"> Images displayed in 3D mode appear 2D while you are wearing the 3D glasses. 	<ul style="list-style-type: none"> Are the 3D glasses set to 2D mode? Press the power button while viewing 2D images, the LED light blinks in green and the 2D images switch to 3D images.

- For further details, refer to the operation manual of the 3D glasses.

Appendix

Troubleshooting

Problem	Possible solution
<ul style="list-style-type: none"> No power. 	<ul style="list-style-type: none"> Is the AC cord disconnected? Check if you pressed POWER on the TV. When the power switch does not work, remove the power plug and insert it again, and press POWER on the TV after waiting more than five seconds.
<ul style="list-style-type: none"> The TV cannot be operated. 	<ul style="list-style-type: none"> External influences such as lightning, static electricity, etc., may cause improper operation. In this case, operate the TV after first turning off the power, or unplugging the AC cord and re-plugging it in after one or two minutes.
<ul style="list-style-type: none"> Remote control unit does not operate. 	<ul style="list-style-type: none"> Are batteries inserted with polarity (+, -) aligned? Are batteries worn out? (Replace with new batteries.) Are you using it under strong or fluorescent lighting? Is a fluorescent light illuminating to the remote control sensor?
<ul style="list-style-type: none"> Picture is cut off. 	<ul style="list-style-type: none"> Is the image position correct? Are screen mode adjustments (Wide mode) such as picture size made correctly? (Pages 47 – 48, 68, 69 and 70).
<ul style="list-style-type: none"> Strange colour, light colour, or dark colour, or colour misalignment. 	<ul style="list-style-type: none"> Adjust the picture tone (Pages 37 – 39). Is the room too bright? The picture may look dark in a room that is too bright. Check the "Colour system" setting (Pages 43 and 50). Check the "HDMI auto view" setting (Page 49).
<ul style="list-style-type: none"> Power is suddenly turned off. 	<ul style="list-style-type: none"> The TV's internal temperature has increased. Remove any objects blocking the vent or clean. Is the "Sleep timer" set? Select "Off" from the "Sleep timer" menu (Page 41). Is "No signal off" or "No operation off" activated? (Page 41)
<ul style="list-style-type: none"> No picture. 	<ul style="list-style-type: none"> Are connections to external equipment correct? (Pages 28 – 31) Is the correct input source selected? (Page 19) Is a non-compatible signal being input? (Page 71) Is the picture adjustment correct? (Pages 37 – 39) Is the antenna connected properly? (Page 9)
<ul style="list-style-type: none"> No sound. 	<ul style="list-style-type: none"> Is the volume too low? If you do not clearly hear the sound for the visually impaired, go to "HOME" > "TV Menu" > "Setup" > "Audio" > "Audio description setting" > "Mix level", and select the upper level to turn up the volume. Make sure that headphones are not connected. Check if you pressed  on the remote control unit. Is the proper item selected in the "Audio select" menu when connecting devices to the HDMI 2 terminal or the PC terminal? (Pages 29, 48 and 70)
<ul style="list-style-type: none"> The TV sometimes makes a cracking sound. 	<ul style="list-style-type: none"> This is not a malfunction. This happens when the cabinet slightly expands and contracts according to changes in temperature. This does not affect the TV's performance.
<ul style="list-style-type: none"> AQUOS.NET top page cannot be displayed. 	<ul style="list-style-type: none"> Is the ETHERNET cable connected correctly? (Page 54) Check the settings of "Network setup". (Pages 54 – 57)
<ul style="list-style-type: none"> Some Internet functions used on a PC are not available from the TV. 	<ul style="list-style-type: none"> The TV has only limited functions compared with regular PC browsers. (Page 59)
<ul style="list-style-type: none"> Miracast image/audio cannot be output to the TV. 	<ul style="list-style-type: none"> Check pairing.
<ul style="list-style-type: none"> Bluetooth (smartphone) playback cannot be displayed on the TV. 	<ul style="list-style-type: none"> Check pairing.

Troubleshooting – Digital broadcasting

Problem	Error code	Possible solution
<ul style="list-style-type: none"> No picture or no sound. 	—	<ul style="list-style-type: none"> Is the correct input source selected? (Page 19)
<ul style="list-style-type: none"> Block noise appears on the screen. 	—	<ul style="list-style-type: none"> Is the antenna pointing in the correct direction? Check the "Signal strength" and "Quality" (Page 17). Are physical objects blocking the antenna? Is the antenna or antenna cable compatible with DTV broadcast?
<ul style="list-style-type: none"> DTV broadcasts cannot be received. 	E202	<ul style="list-style-type: none"> Is the DTV antenna set up properly? Is the antenna cable connected properly? (Page 9) Is the channel settings correct? (Page 17)
<ul style="list-style-type: none"> A specific channel cannot be received. 	—	<ul style="list-style-type: none"> Check the "Signal strength" and "Quality" (Page 17).
<ul style="list-style-type: none"> No broadcast now. 	E203	<ul style="list-style-type: none"> Check the current broadcast.

Reset

If complex adjustments are made so that the settings cannot be restored to normal, you can reset the settings to the factory preset values.

- 1 Go to "HOME" > "TV Menu" > "Setup" > "View setting" > "Reset".
- 2 If you have already set the password, enter it here.
- 3 Press ◀▶ to select "Yes", and then press ↵.
 - "Now, TV will restart automatically, OK?" displays on the screen.
- 4 Press ◀▶ to select "Yes", and then press ↵.
 - "Now initialising..." displays on the screen and blinks.
 - After the reset has completed, the power shuts off and then comes back on. The screen will have returned to its original settings.
- 5 Press ▲/▼/◀▶ to select the desired language listed on the screen, and then press ↵.

Press ◀▶ to select "HOME" or "STORE", and then press ↵.
- 6 **Setting the country.**
 Press ▲/▼/◀▶ to select your country or area, and then press ↵.
 - This setting screen only appears during the initial auto installation.
- 7 The TV searches for and stores all the receivable TV stations according to their settings and the connected antenna.
 - To abort the initial auto installation in progress, press **RETURN**.

NOTE

- When the TV is in "STORE" mode, repeat steps 1 to 5 to change to "HOME" mode.
- "Reset" is greyed out in 3D mode. To select the "Reset" menu, you need to switch to 2D mode.

Updating your TV via DVB-T (DTV only)

Ensure that your TV software version is always up to date. From time to time SHARP will make updated TV base software and DVB software available.



Go to "HOME" > "TV Menu" > "Setup" > "View setting" > "Individual setting" > "Standby search" > "Download setup".

Searching for updates

The TV automatically determines whether a new software version is available when the TV is in standby mode.

Item	
Yes	Automatically searches for new software updates available when the TV is in standby mode.
No	Does not search for update information.
Now	Lowers image brightness for easier viewing. Checks if there is new software immediately.

Downloading the software

You can select the method of update.

- 1 If the software is updated, the confirmation message "New download information has been detected." appears.
 - If the TV receives the update service while in standby mode, a confirmation message displays after turning on the power.
- 2 Follow the screen prompts.

Item	
Yes	Starts downloading immediately. It takes approximately one hour to update. You cannot carry out other operations while downloading. <ul style="list-style-type: none"> • Cancels the download by pressing ↵ on the remote control unit when "Discontinue" is displayed on the screen during the update.
No	Starts downloading automatically several minutes after entering standby mode.

NOTE

- Do not unplug the AC cord while receiving the data, otherwise it will not be captured properly.
- Updating the software may take some time.

Getting information

Information Picture / Audio test

When external equipment is connected with the TV powered on and there is no audio/video output, the TV may determine which equipment could cause a problem between the TV and the external equipment.

Go to "HOME" > "TV Menu" > "Setup" > "Information" > "Picture / Audio test".

NOTE

- Terminals which can be tested: HDMI, component, composite, SCART, DVI, D-sub
- External speakers cannot be tested. This function is available for the TV speakers only.

Item	
Picture test	Perform a test for picture display. When external equipment is connected but the picture is not displayed, the test will be performed.
Audio test	Perform a test for audio playback. When external equipment is connected but the audio does not playback, the test will be performed.

Information Message list (DTV only)

When new software is detected, you can confirm the update information and download the software from "Message list".

Go to "HOME" > "TV Menu" > "Setup" > "Information" > "Message list".

NOTE

- When the TV succeeds at downloading new software, the message is updated in the "Message list" of the "Information" menu.
- The software update will not be carried out if there is no new software available at the specified download time.

Information Receiver report (DTV only)

Display reports regarding failures and changes for timer settings.

Go to "HOME" > "TV Menu" > "Setup" > "Information" > "Receiver report".

Information Identification

You can check the TV ID on the screen for reporting to customer service.

Go to "HOME" > "TV Menu" > "Setup" > "Information" > "Identification".

Updating your TV via USB/Network

Information Software update

This function allows you to update to the latest software using a USB device or Network.

- 1 Go to "HOME" > "TV Menu" > "Setup" > "Information" > "Software update" > "USB update".
 - You can also update the software through the network. Go to "HOME" > "TV Menu" > "Setup" > "Information" > "Software update" > "Network update" > and follow the on-screen instruction.
 - A broadband connection and Network setup are required to update the software using the internet (Pages 54 – 56).
- 2 Press \leftarrow and then insert the USB device containing the software update file.

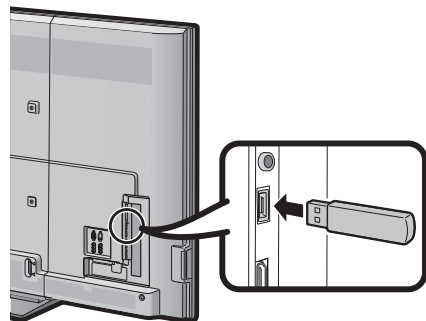

CAUTION

- Be sure to insert the USB device correctly into the terminal.
- 3 The TV displays a confirmation screen while checking the data in the inserted USB device.

CAUTION

- If the data is not compatible with the system, an error message appears on the screen. Repeat steps 2 and 3 after pressing \leftarrow .
- When an error message displays, check to see if:
 - The USB device is inserted firmly.
 - The USB memory has two or more software update files.
 - No data for updating the system exists in the USB memory.
 - The software update file is broken.
 - The software update file is not compatible with your TV's software.
 - The current system is same as the system update data.
 - The USB memory is not formatted by FAT32.

- 4 The TV displays the software version information after checking the data.
- 5 Press \leftarrow to select "Yes" to update the system, and then press \leftarrow .
- 6 The TV restarts automatically, and the software update will be complete.
 - This operation may take a while.

NOTE

- You cannot update the software using a SD/SDHC memory card containing the update file.

Information on the software licence for this product

Software licence

You can read the software licences in this menu.

Go to "HOME" > "TV Menu" > "Setup" > "Information" > "Software licence".

● Software composition

The software included in this product is comprised of various software components whose individual copyrights are held by SHARP or by third parties.

Warning regarding basic use

Cautions regarding use in high and low temperature environments

- When the TV is used in a low temperature space (e.g., room, office), the picture may leave trails or appear slightly delayed. This is not a malfunction, and the TV will recover when the temperature returns to normal.
- Do not leave the TV in a hot or cold location. Also, do not leave the TV in a location exposed to direct sunlight or near a heater, as this may cause the cabinet to deform and the LCD panel to malfunction.
Storage temperature: - 20 °C to + 60 °C.

Appendix

Trademarks

Manufactured under license from Dolby Laboratories.
Dolby and the double-D symbol are trademarks of Dolby Laboratories.

The terms HDMI and HDMI High-Definition Multimedia Interface, and the HDMI Logo are trademarks or registered trademarks of HDMI Licensing LLC in the United States and other countries.

DivX®, DivX Certified®, DivX Plus® HD and associated logos are trademarks of Rovi Corporation or its subsidiaries and are used under license.

ABOUT DIVX VIDEO: DivX® is a digital video format created by DivX, LLC, a subsidiary of Rovi Corporation. This is an official DivX Certified® device that has passed rigorous testing to verify that it plays DivX video. Visit divx.com for more information and software tools to convert your files into DivX videos.

ABOUT DIVX VIDEO-ON-DEMAND: This DivX Certified® device must be registered in order to play purchased DivX Video-on-Demand (VOD) movies. To obtain your registration code, locate the DivX VOD section in your device setup menu. Go to vod.divx.com for more information on how to complete your registration.

LC フォント、LCFONT、エルシーフォント and LC logo mark are registered trademarks of SHARP Corporation.
This product is embedded with LC Font technology, which was developed by SHARP Corporation for clearly displaying easy-to-read characters on an LCD screen. However, other non-LCD fonts are used for displaying some screen pages.

DLNA®, the DLNA Logo and DLNA CERTIFIED™ are trademarks, service marks, or certification marks of the Digital Living Network Alliance.

Audio Engine is a trademark of Yamaha Corporation.

YouTube and the YouTube logo are trademarks of Google Inc.

XT9 (R) is a registered trademark of Nuance Communications, Inc. and its affiliates in the United States and other countries. Copyright (c) 2012 Nuance Communications, Inc. All rights reserved.

MHL, the MHL Logo, and Mobile High-Definition Link are trademark or registered trademarks of MHL LLC in the United States and other countries.

This product includes DLNA Software 'DiXIM' developed by DigiOn, Inc.

All other company or product names are trademarks or registered trademarks of their respective companies.

For DTS patents, see <http://patents.dts.com>. Manufactured under license from DTS Licensing Limited. DTS, the Symbol, & DTS and the Symbol together are registered trademarks, and DTS 2.0+ Digital Out is a trademark of DTS, Inc. © DTS, Inc. All Rights Reserved.

SDHC Logo is a trademark of SD-3C, LLC.

The Wi-Fi CERTIFIED Logo is a certification mark of the Wi-Fi Alliance.
The Wi-Fi Protected Setup Mark is a mark of the Wi-Fi Alliance.

Wi-Fi CERTIFIED Miracast™ and Miracast™ are trademarks of Wi-Fi Alliance.

The Bluetooth® word mark and logos are registered trademarks owned by Bluetooth SIG, Inc. and any use of such marks by SHARP Corporation is under license. Other trademarks and trade names are those of their respective owners.

Specifications

Item		LC-90LE760X	
Resolution		1,920 x 1,080	
Video colour system		PAL/SECAM/NTSC 3.58/NTSC 4.43/PAL 60	
TV function	TV-standard	Analogue	PAL (B/G, D/K, I), SECAM (B/G, D/K, K/K1), NTSC:(M)
		Digital	DVB - T/DVB - T2
	Receiving channel	VHF/UHF	44.25-863.25 MHz
	TV tuning system		Auto preset 02ch/07ch/09ch/10ch/28ch at Australia.
STEREO/BILINGUAL		NICAM (B/G, I, D/K), A2 stereo (B/G), BTSC	
Audio amplifier		10 W x 2, 15 W x 1 (Woofer)	
Terminals	ANT (Antenna input)		UHF/VHF 75 Ω Din type
	RS-232C		D-Sub 9 pin male connector
	PC		15 pin mini D-sub, AUDIO in (shared usage with HDMI2) (φ 3.5 mm jack)
	INPUT 1 HDMI		HDMI (HDMI input) (HDCP 2.2)
	INPUT 2 HDMI		HDMI (HDMI input), AUDIO in (shared usage with PC) (φ 3.5 mm jack)
	INPUT 3 (ARC) HDMI		HDMI (HDMI input), ARC
	INPUT 4 (MHL) HDMI		HDMI (HDMI input), MHL
	INPUT 5		VIDEO in, AUDIO in (φ 3.5 mm jack)
	INPUT 6		AUDIO in, VIDEO in, COMPONENT in (480I, 576I, 480P, 576P, 720P/50Hz, 720P/60Hz, 1080I/50Hz, 1080I/60Hz)
	USB 1		USB
	USB 2		USB
	USB 3 (HDD)		USB
	SD/SDHC		SD/SDHC memory card*2
	ETHERNET (10/100 BASE-T)		Network connector
	AUDIO IN (HDMI 2/PC)		φ 3.5 mm jack*1
	DIGITAL AUDIO OUTPUT		Optical S/PDIF digital audio output
OUTPUT/Headphones		φ 3.5 mm jack (audio output)	
C.I. (Common Interface)		EN50221, R206001, CI Plus specification	
OSD language		English/Simplified Chinese/Arabic/French/Portuguese/Russian/Persian/Thai/Vietnamese/Indonesian	
Power requirement		AC 110—240 V, 50/60 Hz	
Power consumption (method IEC62087)		381 W (0.3 W Stand by)	
Power consumption during wallpaper mode		74 W	
Weight	With Stand		68.0 kg
	Without Stand		64.0 kg
Operating temperature		0 °C to + 40 °C	

*1 The HDMI 2 and PC terminals can both use the same audio input terminal.

*2 If you insert any card other than the SD/SDHC (class 6 or higher), it will not work.

- As a part of our policy of continuous improvement, SHARP reserves the right to make design and specification changes for product improvement without prior notice. The performance specification figures indicated are nominal values of production units. There may be some deviations from these values in individual units.

Removing the stand

- Before detaching (or attaching) the stand, make sure to turn off the TV and unplug the AC cord.

CAUTION

- Do not remove the stand from the TV unless using an optional wall mount bracket to mount it.

1

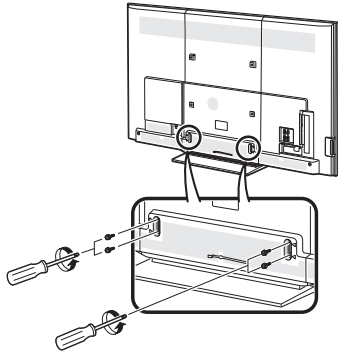

Unfasten the four screws used to secure the stand in place.

2

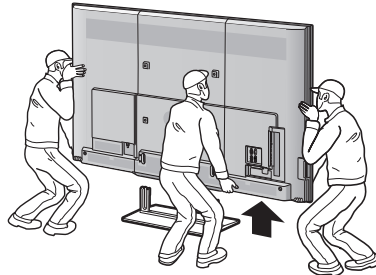

Detach the stand from the TV.

NOTE

- In the installation procedure, be careful not to catch your fingers between the TV set and the floor.

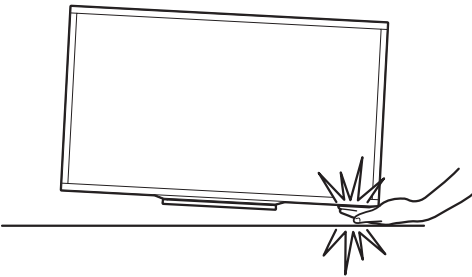

Mounting the TV on a wall

To use this TV mounted on a wall, remove the AC cord holder and the screws at the 4 locations on the rear of the TV, and then use the screws supplied with the wall mount bracket to secure the bracket to the rear of the TV.

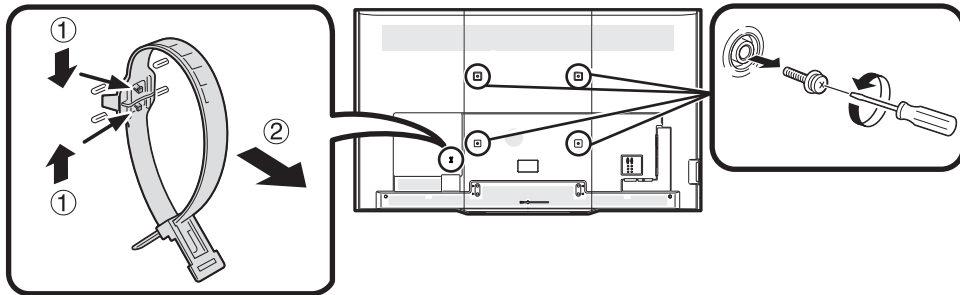

- **Mounting the LCD colour TV requires special skills and should only be performed by qualified service personnel. Customers should not attempt to do the work themselves. SHARP bears no responsibility for improper mounting or mounting that results in accident or injury.**
- You can ask qualified service personnel about using an optional bracket to mount the TV to a wall.
- When you mount the TV on a wall, you should attach the supporting post.
- Detach the AC cord holder on the rear of the TV before mounting the TV on a wall.

Appendix

The wall mount kit (sold separately) allows you to mount the TV on the wall.

For detailed information on installing the wall mount, see the instructions provided with the product. We recommend you to contact a technician for assistance when installing it.

SHARP is not responsible for any damage to the product or injury to yourself or others if you elect to install the wall mount on your own.

CAUTION

- **Install your wall mount on a solid wall perpendicular to the floor.**
When you want to attach the wall mount to surfaces other than plaster board, please contact your nearest retailer/ adviser for additional information. If you install the TV on a ceiling or slanted wall, it may fall and result in severe personal injury. Always have two people mount the TV on a wall.

Wall Mount Kit Specifications

Standard dimensions for wall mount kits are shown below.

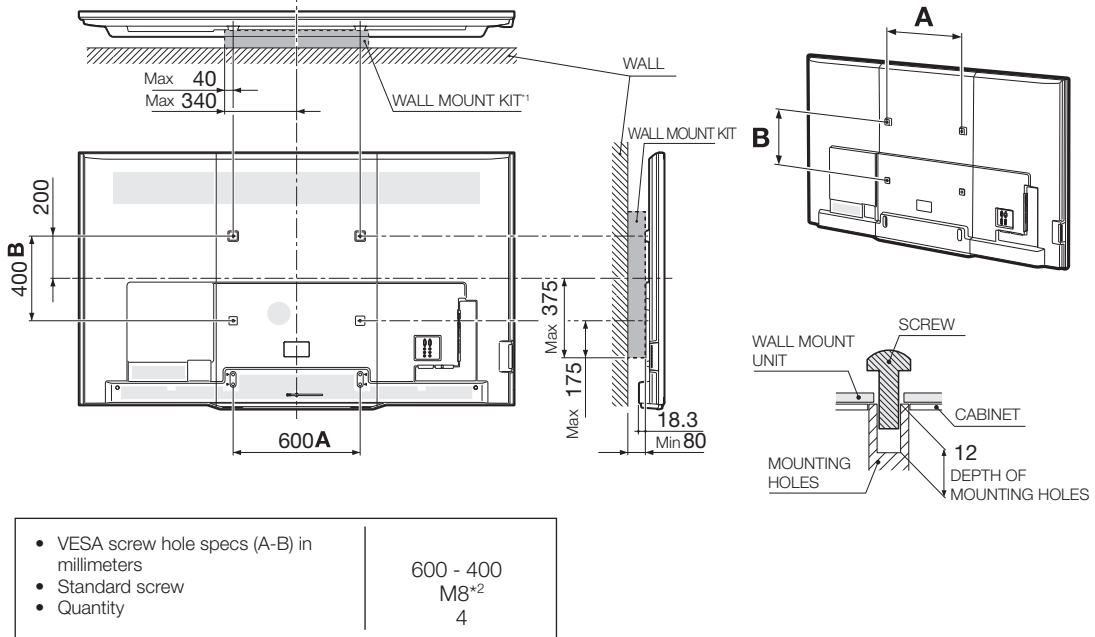

¹ Must be smaller than the shaded area.

² Use 1.25 pitch screws.

NOTE

- Do not mount the TV at a tilt.
- Due to the terminal configuration on this TV, when you wall-mount this model, make sure there is enough space between the wall and the TV for the cables.
- To use this TV mounted on a wall, remove the cable tie as needed.
- Do not use screws that do not comply with the VESA standard screw specifications.
- Do not use screws that are longer than the standard length. Screws that are too long may cause damage to the inside of the TV set.
- Do not fasten the screws too firmly or loosely. This may damage the product or cause the product to fall, leading to personal injury. SHARP is not liable for these kinds of accidents.
- SHARP is not liable for product damage or personal injury when a non-VESA or non-specified wall mount is used or the consumer fails to follow the product installation instructions.



Do not install the wall mount kit while your TV is turned on. It may result in personal injury due to electric shock.

● Wall mount audio setup

When you mount the TV on a wall, you can adjust the sound to a more suitable one by setting this function to "Yes".

Go to "HOME" > "TV Menu" > "Setup" > "View setting" > "Wall mount audio setup".

Dimensional drawings

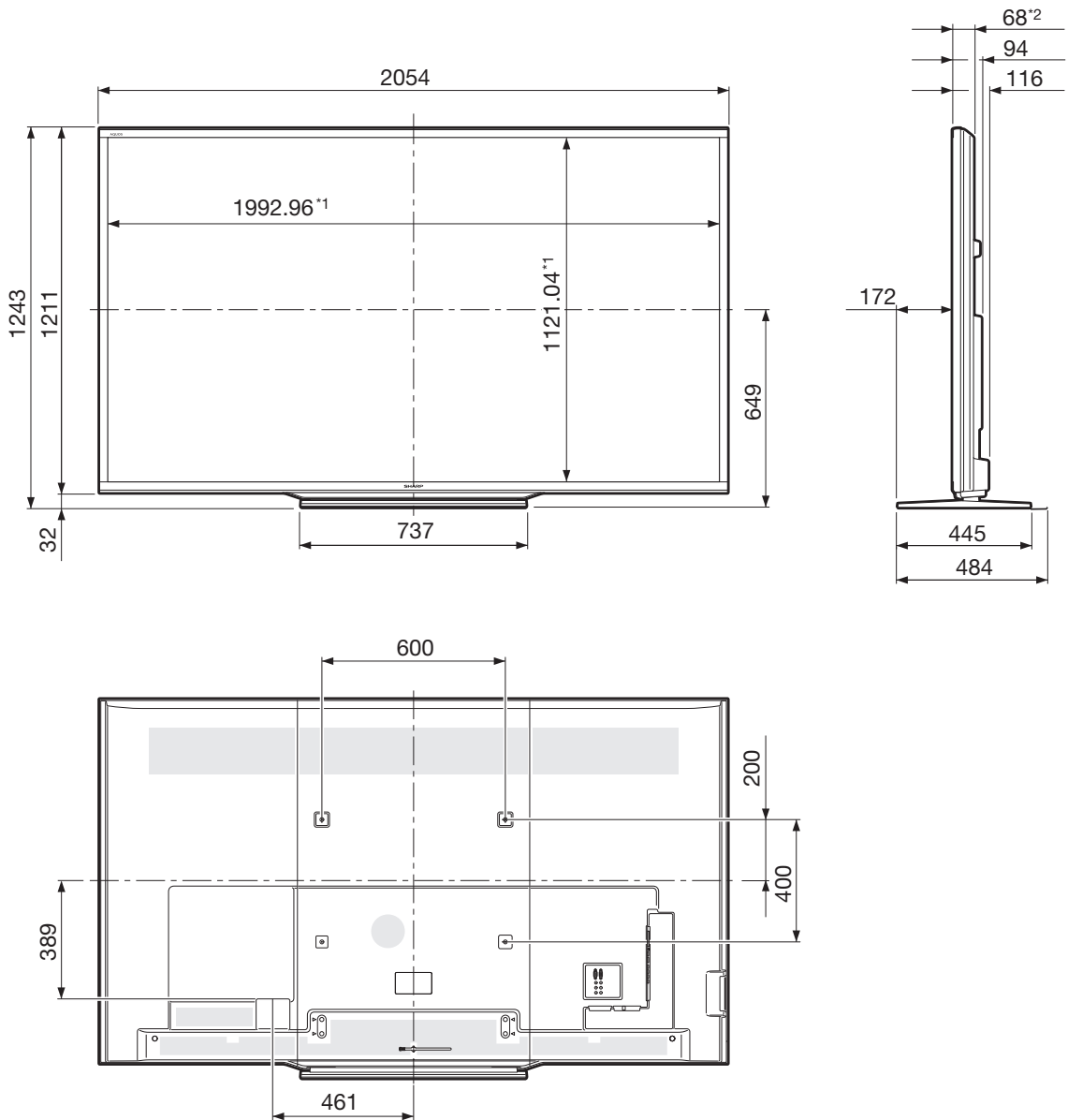

*1 Active area

*2 Thinnest part (except of terminal height)

NOTE

- Dimensions do not include protrusions such as screws and some parts.

CLEARING THE PASSWORD

- 1 Go to “HOME” > “TV Menu” > “Setup” > “View setting” > “Individual setting” > “Password”.
- 2 The password input screen displays.
- 3 Press and hold both **CH/∧** and **VOL+** on the TV simultaneously until the message appears on the screen.

NOTE

- To set the password again, refer to **Password** on page 45 and follow the instructions.



The Password is

--	--	--	--

NOTE

- As a precautionary measure, make a note of your password above, remove it from this manual, and keep it in a familiar place.

Note

Note

SHARP

FOR LOCATION ENQUIRIES WITHIN

AUSTRALIA

REGARDING YOUR LOCAL

SHARP APPROVED SERVICE CENTRE

VISIT OUR WEBSITE AT

www.sharp.net.au

OR CALL SHARP CUSTOMER CARE

1300 135 022

(LOCAL CALL COSTS APPLY WITHIN AUSTRALIA)

SHARP CORPORATION OF AUSTRALIA PTY LTD

SHARP

FOR LOCATION ENQUIRIES WITHIN

NEW ZEALAND

REGARDING YOUR LOCAL

SHARP APPROVED SERVICE CENTRE

VISIT OUR WEBSITE AT

www.sharp.net.nz

CONTACT YOUR SELLING DEALER/RETAILER

OR CALL

SHARP CUSTOMER SERVICES

TELEPHONE: 09 573 0111

FACSIMILE: 09 573 0113

SHARP CORPORATION OF NEW ZEALAND LIMITED

SPform019(AUGUST 2011)

SHARP

WARRANTY

Consumer Electronic Products

Congratulations on Your Purchase!

This Sharp product is warranted against faults in material and manufacture for the period as stated in the table below.

If service is required during the warranty period, please contact your nearest Sharp Approved Service Centre. These repairs would be carried out at no charge to the owner, subject to the conditions specified herein.

This warranty does not extend to defects or injuries caused by or resulting from causes not attributable to faulty parts or the manufacture of the product, including but not limited to, defect or injury caused by or resulting from misuse, abuse, neglect, lack of maintenance, accidental damage, improper voltage, liquid spillage, vermin infestation, software, or any alterations made to the product which are not authorised by Sharp.

Please retain your sales documentation, as this should be produced to validate a warranty claim. This warranty is in addition to and in no way limits, varies or excludes any implied rights and remedies under any relevant legislation in the country of sale.

This warranty does not cover transportation to and from the Sharp Approved Service Centre. Goods presented for repair may be replaced by refurbished goods of the same type rather than being repaired. Refurbished parts may be used to repair the goods. The repair of your goods may result in the loss of user generated data, please ensure that you have saved this data elsewhere prior to repair.

Australian customers: Our goods come with guarantees that cannot be excluded under the Australian Consumer Law. You are entitled to a replacement or refund for a major failure and for compensation for any other reasonably foreseeable loss or damage. You are also entitled to have the goods repaired or replaced if the goods fail to be of acceptable quality and the failure does not amount to a major failure. The criteria of a major failure is defined in the Australian Consumer Law. Should you require any assistance with a major failure please contact Sharp Customer Care.

WARRANTY PERIODS

Home Theatre Projector	12 months (excluding lamps and air filters)
Audio/Home Theatre	12 months
Microwave Oven	12 months
Steam Oven	12 months
Refrigerator	24 months
DVD/Blu-ray	12 months
Air Conditioner	60 months
Portable Air Conditioner	12 months
LCD Television	12 months
Air Purifier	12 months
Vacuum Cleaner	24 months

SHARP
SHARP CORPORATION OF
AUSTRALIA PTY LIMITED
ABN 40 003 089 405
1 Huntingwood Drive
Huntingwood NSW 2148

**SHARP CORPORATION OF
NEW ZEALAND LIMITED**
89 Hugo Johnston Drive
Penrose, Auckland

SPform 040 (JUNE 2012)

IMPORTANT NOTICE: This warranty applies only to products sold in Australia & New Zealand

SHARP®

SHARP CORPORATION

Printed in Malaysia
TINS-G134WJZZ
14P04-MA-NP

Free Manuals Download Website

<http://myh66.com>

<http://usermanuals.us>

<http://www.somanuals.com>

<http://www.4manuals.cc>

<http://www.manual-lib.com>

<http://www.404manual.com>

<http://www.luxmanual.com>

<http://aubethermostatmanual.com>

Golf course search by state

<http://golfingnear.com>

Email search by domain

<http://emailbydomain.com>

Auto manuals search

<http://auto.somanuals.com>

TV manuals search

<http://tv.somanuals.com>