

SHARP®

MODEL

AR-507

DIGITAL COPYING MACHINE

OPERATION MANUAL

	Page
• GETTING STARTED	1-1
• MAKING COPIES	2-1
• SPECIAL FUNCTIONS	3-1
• SUPPLIES	4-1
• COPIER TROUBLE?	5-1
• GENERAL INFORMATION	6-1
• OPTIONAL EQUIPMENT ...	7-1
• KEY OPERATOR'S GUIDE	8-1

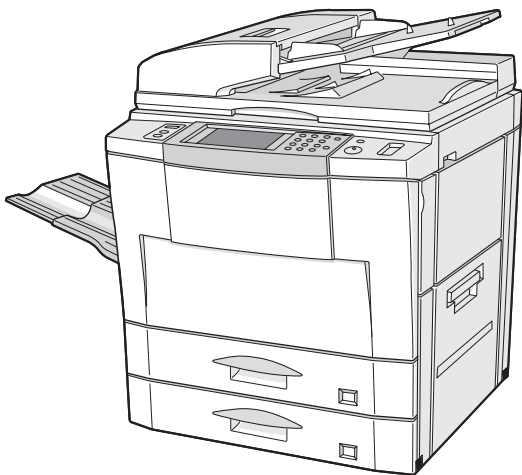

Warning

This is a class A product. In a domestic environment this product may cause radio interference in which case the user may be required to take adequate measures.

In some areas, the "POWER" switch positions are marked "I" and "⏻" on the copier instead of "ON" and "OFF".

The symbol "⏻" denotes the copier is not completely de-energized but in a stand-by condition at this "POWER" switch position.

If your copier is so marked, please read "I" for "ON" and "⏻" for "OFF".

Caution!

For a complete electrical disconnection, pull out the main plug.

The socket-outlet shall be installed near the equipment and shall be easily accessible.

This equipment complies with the requirements of Directives 89/336/EEC and 73/23/EEC as amended by 93/68/EEC.

Dieses Gerät entspricht den Anforderungen der EG-Richtlinien 89/336/EWG und 73/23/EWG mit Änderung 93/68/EWG.

Ce matériel répond aux exigences contenues dans les directives 89/336/CEE et 73/23/CEE modifiées par la directive 93/68/CEE.

Dit apparaat voldoet aan de eisen van de richtlijnen 89/336/EEG en 73/23/EEG, gewijzigd door 93/68/EEG.

Dette udstyr overholder kravene i direktiv nr. 89/336/EEC og 73/23/EEC med tillæg nr. 93/68/EEC.

Quest' apparecchio è conforme ai requisiti delle direttive 89/336/EEC e 73/23/EEC, come emendata dalla direttiva 93/68/EEC.

Η εγκατάσταση αυτή ανταποκρίνεται στις απαιτήσεις των οδηγιών της Ευρωπαϊκής Ένωσης 89/336/EOK και 73/23/EOK, όπως οι κανονισμοί αυτοί συμπληρώθηκαν από την οδηγία 93/68/EOK.

Este equipamento obedece às exigências das directivas 89/336/CEE e 73/23/CEE, na sua versão corrigida pela directiva 93/68/CEE.

Este aparato satisface las exigencias de las Directivas 89/336/CEE y 73/23/CEE, modificadas por medio de la 93/68/CEE.

Denna utrustning uppfyller kraven enligt riktlinjerna 89/336/EEC och 73/23/EEC så som kompletteras av 93/68/EEC.

Dette produktet oppfyller betingelsene i direktivene 89/336/EEC og 73/23/EEC i endringen 93/68/EEC.

Tämä laite täyttää direktiivien 89/336/EEC ja 73/23/EEC vaatimukset, joita on muutettu direktiivillä 93/68/EEC.

The CE mark logo label is affixed on an equipment in case that the directives described in the above sentence are applicable to the product. (This sentence is not applicable in any country where the above directives are not required.)

CONTENTS

	Page
● INTRODUCTION	2
● USING THIS MANUAL	2

CHAPTER 1 GETTING STARTED

● INSTALLATION REQUIREMENTS	1-2
● CAUTIONS	1-3
● POWER ON AND OFF	1-5
Power save modes	1-6
● INFORMATION FUNCTION	1-7
● USING THE TOUCH PANEL	1-8
How to use the touch panel	1-8
Selection of function	1-8
Function setting icons	1-9
● FACE UP/FACE DOWN DELIVERY	1-10

CHAPTER 2 MAKING COPIES

● AUDITING ACCOUNTS	2-2
● USING THE RSPF	2-3
● COPYING FROM THE DOCUMENT GLASS	2-8
● REDUCTION/ENLARGEMENT/ZOOM ..	2-11
● SPECIAL PAPERS (manual feed)	2-14
● EXPOSURE ADJUSTMENTS	2-16
● SORT/GROUP	2-17
● JOB MEMORY	2-18
● INTERRUPTING A COPY RUN	2-20

CHAPTER 3 SPECIAL FUNCTIONS

● XY ZOOM	3-2
● MARGIN SHIFT	3-4
● ERASE	3-6
● DUAL PAGE COPYING	3-8
● MULTI SHOT	3-10
● COVERS	3-13
● TRANSPARENCY FILM WITH INSERT SHEETS	3-15
● PAMPHLET COPY	3-17
● IMAGE EDITING FUNCTIONS	3-20
Job build	3-20
Centring	3-22
Repeat copy	3-24
B/W reverse	3-27
Binding change	3-29
● TEXT STAMP	3-32
Date	3-32
Select stamp	3-35
Watermark	3-38
Page number	3-41
● TANDEM COPY	3-44
● SETTING REVIEW	3-46

CHAPTER 4 SUPPLIES

● PAPER	4-2
Types and sizes of copy paper	4-2
Loading copy paper	4-2
● ADDING TONER	4-5
● USED TONER DISPOSAL	4-7
● STORAGE OF SUPPLIES	4-8

CHAPTER 5 COPIER TROUBLE?

● MISFEED REMOVAL	5-2
● MAINTENANCE REQUIRED	5-13
● TROUBLESHOOTING	5-14

CHAPTER 6 GENERAL INFORMATION

● PART NAMES AND FUNCTIONS	6-2
Exterior	6-2
Interior	6-3
Operation panel	6-4
Touch panel (Basic screen)	6-5
● USER MAINTENANCE	6-6
● TOUCH PANEL CONTRAST ADJUSTMENT	6-7
● SPECIFICATIONS	6-8

CHAPTER 7 OPTIONAL EQUIPMENT

● SYSTEM CONFIGURATION	7-2
● FINISHER (AR-FN3)	7-3
● LARGE CAPACITY TRAY (AR-LC1N) ...	7-19
● STAND/500-SHEET PAPER DRAWER (AR-DE7)	7-23

CHAPTER 8 KEY OPERATOR'S GUIDE

● KEY OPERATOR CODE NUMBER	8-2
Registering the key operator code number	8-2
● KEY OPERATOR PROGRAMS	8-4
Using the key operator programs	8-7
● KEY OPERATOR ASSISTANCE CALL ..	8-31
● KEY OPERATOR CODE NUMBER: FACTORY SETTING	8-33

CHAPTER 1

CHAPTER 2

CHAPTER 3

CHAPTER 4

CHAPTER 5

CHAPTER 6

CHAPTER 7

CHAPTER 8

INTRODUCTION

The AR-507 copier is a digital image processing copier which provides high productivity and convenient features including intelligent image-editing functions.

Amongst its many useful features and functions are the document feeder, various special functions such as dual page copying, margin shift, erase, XY zoom, and black and white reverse functions, photo copying, and an internal auditor. If this copier is connected with another copier of the same model equipped with the same options through the tandem-connection cable (AR-CA1), copying can be performed using the two copiers allowing copying to be twice as fast as copying on one copier when making multiple copies. Also, the JOB BUILD mode allows copies to be made of multipage documents of up to 120 pages (the limit, however, might be up to 60 pages of B4 or A3 (8-1/2" x 14" or 11" x 17") paper size when the copier is equipped with some option) by dividing the document into sections small enough (50 pages or less) and sequentially feeding through the document feeder.

The digital processing system of the copier allows multiple sets of copies to be sorted without the aid of a sorter. This copier can be equipped with an optional large capacity tray which holds 3,000 sheets of copy paper. The machine can also be equipped with an optional finisher to provide finished copy sets ready for distribution.

This copier was also designed with ease of use in mind. The easy-to-understand operation panel with touch panel system and INFORMATION function will guide the user through most operations. To gain the maximum benefit of all the features of the copier, however, it is recommended that users first read this manual to become familiar with all the features of the copier.

NOTE:

This manual describes only copier features. For a description of optional printer features and scanner features, see the separate relevant manual.

USING THIS MANUAL

This manual is intended as an operation guide for both general users and key operators.

For General Users

It is recommended that you read the GETTING STARTED, MAKING COPIES, and SPECIAL FUNCTIONS sections to become familiar with the available features and functions of your copier. Then refer to the manual as needed to become thoroughly familiar with those features you will normally use.

For Key Operators

Please read all sections thoroughly to become familiar with all features and functions of your copier. Throughout the manual, information which is relevant to key operator functions is noted by "★ **KEY OPERATOR.**" Please pay close attention to these notes and to the SUPPLIES, COPIER TROUBLE?, GENERAL INFORMATION, and OPTIONAL EQUIPMENT sections so you can ensure smooth and efficient operation of your machine.

The KEY OPERATOR'S GUIDE section has been written especially for you. It contains the programs and programming information that will enable you to tailor functions for maximum benefit to your company.

AB series (metric) and inch series references

Both specifications are quoted where applicable.

- The inch series specifications are quoted in brackets.

For example:

Page 2-3 ----- B4 and A3 (8-1/2" x 14" and 11" x 17")

Page 2-12, step 3, Menu 1-A ----- 86%, 81%, and 70% (77% and 64%)

- Although AB series size indications are shown on the touch panel of this manual, inch series indications are displayed on the inch series machines.

Depending on the country or area, some keys of this copier will be indicated with either an English name or a symbol. —Example: INFORMATION (i) key, PROGRAM (P) key, START (⏏) key.

[AB series]

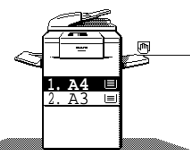

[Inch series]

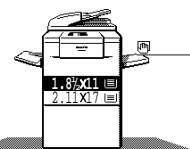

CHAPTER 1

GETTING STARTED

This chapter describes the basic information on the use of this copier.

	Page
• INSTALLATION REQUIREMENTS	1-2
• CAUTIONS	1-3
• POWER ON AND OFF	1-5
Power save modes	1-6
• INFORMATION FUNCTION	1-7
• USING THE TOUCH PANEL	1-8
How to use the touch panel	1-8
Selection of function	1-8
Function setting icons	1-9
• FACE UP/FACE DOWN DELIVERY	1-10

INSTALLATION REQUIREMENTS

To ensure safety and proper machine performance, please note the following before initial installation and whenever the machine is to be relocated.

1. The copier should be installed near an accessible power outlet for easy connection.
2. Be sure to connect the power cord only to a power outlet that meets the specified voltage and current requirements. Also make certain the outlet is properly grounded.
 - For this copier's power supply requirements, see the name plate located on the left hand side at the rear corner of the copier.
3. Do not install the machine where it is:
 - damp or humid,
 - exposed to direct sunlight,
 - extremely dusty,
 - poorly ventilated,
 - subject to extreme temperature or humidity changes (e.g., near an air conditioner or heater).
4. Since a hard disk drive is built into this copier, place the copier on a firm, level surface. Choose an area which is not subject to any vibration.
5. Be sure to allow the required space around the machine for servicing and proper ventilation.

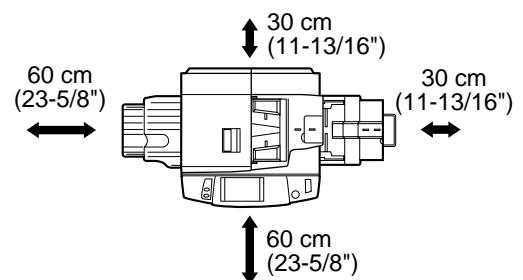
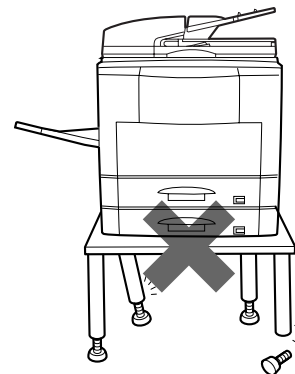
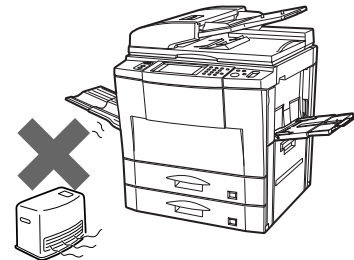
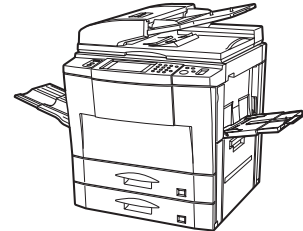
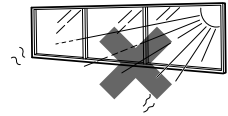

CAUTIONS

1. Do not touch the photoconductive drum. Scratches or smudges on the drum will cause dirty copies.
2. The fusing unit is extremely hot. Exercise care in this area.
3. Since a hard disk drive is built into the copier, be sure to turn the power switch to the "OFF" position when moving the copier. Take care not to subject the copier to any vibration or shock.
4. Do not look directly at the light source. Doing so may damage your eyes.
5. Four installation adjusters are provided on the optional stand/500-sheet paper drawer. When moving the machine with the optional stand/500-sheet paper drawer, be sure to raise the installation adjusters. After moving the machine, lower the four installation adjusters until they reach the floor and lock the two casters at the front of the copier.
6. When copying is interrupted (for example, because the INTERRUPT function has been used, paper or toner has run out, a misfeed has occurred, etc.), this copier will store the image data of the originals read prior to the interruption. If copying of secret documents is interrupted due to the above reasons, be sure to either resume the interrupted copying by pressing the START (⏏) key, or clear the image data by pressing the CLEAR ALL (Ⓢ) key after the interrupt copying is completed or the trouble is cleared, because the stored data may be printed by other operators.

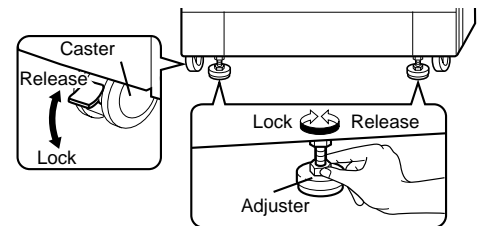
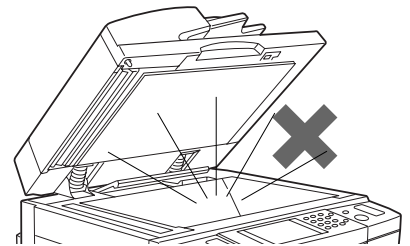
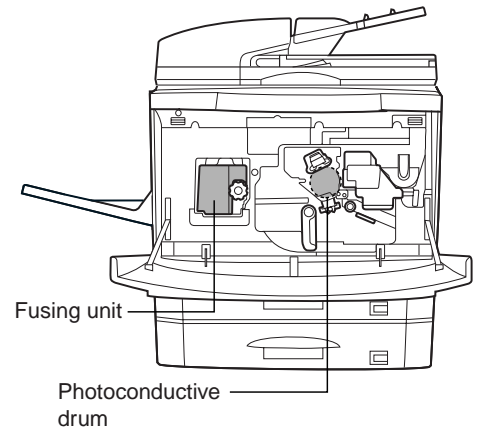

Cautions on laser

Wave length	785 nm +10 nm -15 nm
Pulse times	North America: (1.9 μs ±1.9 ns)/7 mm Europe: (2.6 μs ±2.6 ns)/7 mm
Output power	0.24 - 0.60 mW

At the production line, the output power of the scanner unit is adjusted to 0.6 MILLI-WATT PLUS 8 PCTS and is maintained constant by the operation of the Automatic Power Control (APC).

Caution

This product contains a low power laser device. To ensure continued safety do not remove any cover or attempt to gain access to the inside of the product. Refer all servicing to qualified personnel.

For Europe:

CLASS 1 LASER PRODUCT

LASER KLASSE 1

LUOKAN 1 LASERLAITE

KLASS 1 LASERAPPARAT

CAUTION
INVISIBLE LASER RADIATION
WHEN OPEN AND INTERLOCKS
DEFEATED. AVOID EXPOSURE
TO BEAM.

VORSICHT
UNSICHTBARE
LASERSTRAHLUNG WENN
ABDECKUNG GEÖFFNET UND
SICHERHEITSVERRIEGELUNG
ÜBERBRÜCKT. NICHT DEM
STRAHL AUSSETZEN.

ADVARSEL
OSYNLIG LASERSTRÅLNING
VED ÅBNING, NÅR
SIKKERHEDSBRYDERE ER UDE
AF FUNKTION. UNDGÅ
UDSÆTTELSE FOR STRÅLNING.

VAROITUS!
LAITTEEN KÄYTTÄMINEN
MUULLA KUIN TÄSSÄ
KÄYTTÖOHJEESSA MAINITULLA
TAVALLA SAATTAA ALTISTAA
KÄYTTÄJÄN
TURVALLISUUSLUOKAN 1
YLITTÄVÄLLE NÄKYMÄTTÖMÄLLE
LASERSÄTEILYLLE.

VARNING
OM APPARATEN ANVÄNDS PÅ
ANNAT SÄTT ÄN I DENNA
BRUKSANVISNING
SPECIFICERATS, KAN
ANVÄNDAREN UTSÄTTAS FÖR
OSYNLIG LASERSTRÅLNING,
SOM ÖVERSKRIDER GRÄNSEN
FÖR LASERKLASS 1.

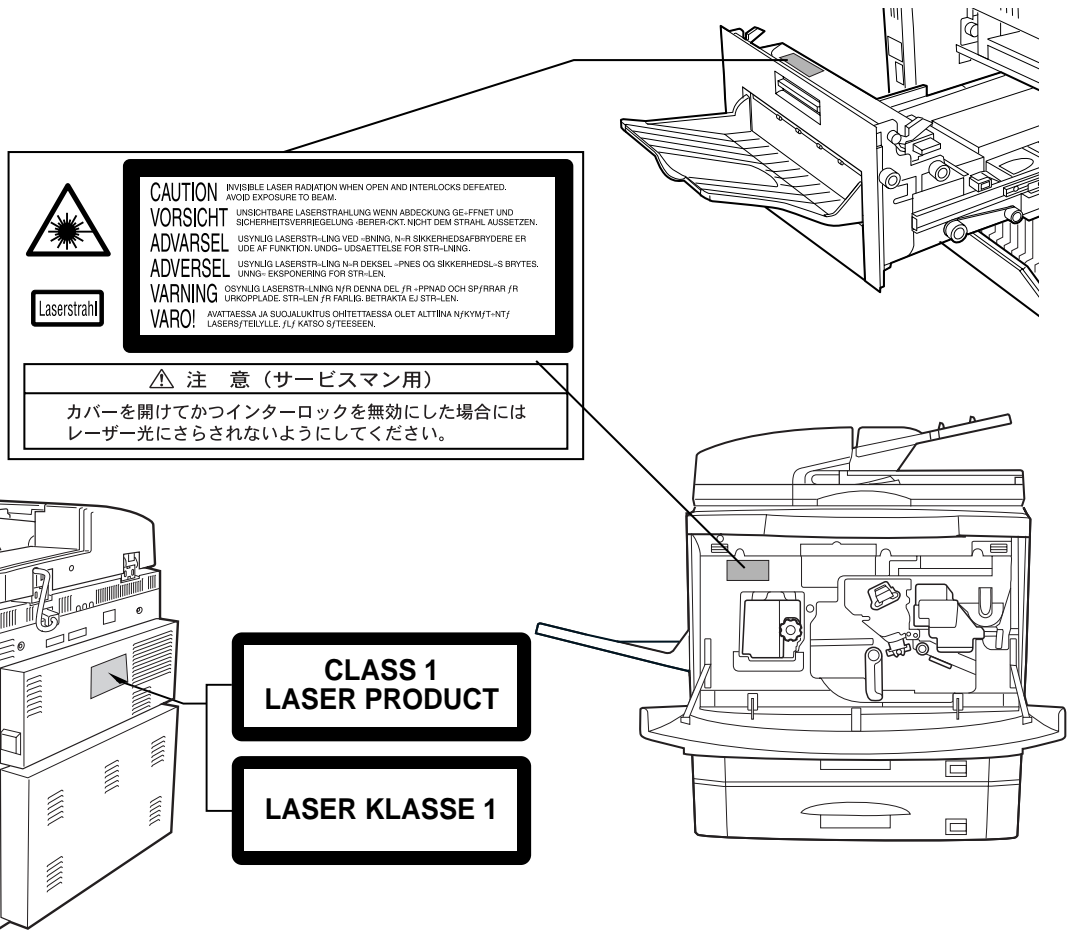

POWER ON AND OFF

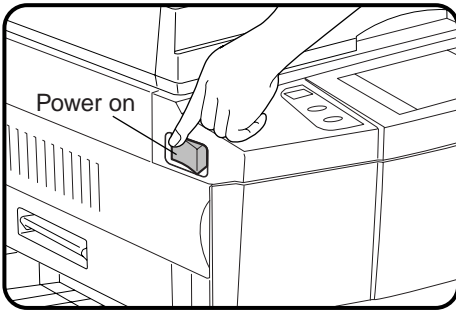

The power switch is located on the left side of the copier. When the power switch is turned to the "ON" position, the message "**WARMING UP. PLEASE WAIT.**" will appear in the message display. Warming up takes less than 150 seconds. Once the copier is ready, the message display will change to "**READY TO COPY.**", and the START (◊) key indicator will light up, indicating that copying is possible. If the copier has been programmed in the auditing mode, the message "**ENTER YOUR ACCOUNT NUMBER. -----**" will appear. Once a valid account number has been entered, copying will become possible.

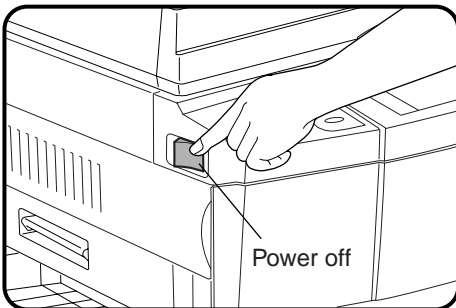

Power save modes

The copier has two power save modes to reduce overall power consumption and thereby reduce the cost of operation and to conserve natural resources to help reduce environmental pollution. The two power save modes are preheat mode and auto power shut-off mode.

★ **KEY OPERATOR**

The preheat activation time and the auto power shut-off time have been preset at the factory to 15 min. for preheat mode and 90 min. for auto power shut-off mode. These times can be changed as described in the key operator's guide section. It is suggested that you set appropriate times according to the actual usage of the copier.

Auto power shut-off mode

If the auto power shut-off mode is enabled, the copier will automatically turn off the power once a programmed length of time has elapsed without any copier operation after the last copy of a run is made or the power is first turned on. The power switch will automatically be turned to the "OFF" position.

To turn the power back on, simply turn the power switch to the "ON" position.

★ **KEY OPERATOR** See page 8-23 for setting the auto power shut-off timer. See page 8-29 for enabling or disabling the auto power shut-off mode.

Preheat mode

The copier will enter the mode once the set time has elapsed without any copier operation after the last copy of a run is made or power is turned on.

When the copier enters the preheat mode, the message "PREHEAT MODE. PLACE ORIGINALS." will appear.

In this condition, the fuser in the copier is maintained at a lower heat level thereby saving power. The preheat level is, however, high enough to allow the copier to come to a ready condition or begin copying approximately 60 seconds after any key input is made.

To copy from the preheat mode, make desired copier selections and press the START (⏏) key using the normal copying procedure.

★ **KEY OPERATOR** See page 8-24 for information on setting the preheat mode.

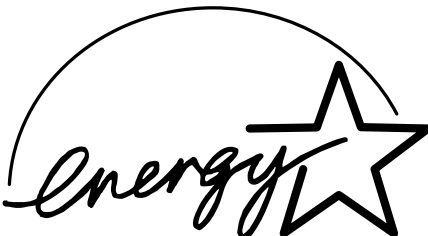

The ENERGY STAR® guidelines are applied to the products only in Europe, Australia and New Zealand. The products that meet the ENERGY STAR® guidelines carry the logo shown above. The products without the logo may not meet the ENERGY STAR® guidelines.

INFORMATION FUNCTION

The information function provides a quick reference guide to the use of the various features and functions of this copier. The information mode can be entered when the copier is in the standby mode.

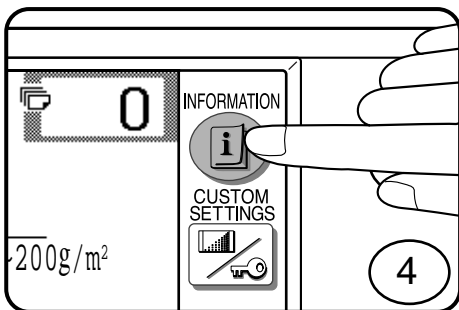

- 1 Press the INFORMATION (i) key in the standby mode.**
 - The screen for the information categories will appear.

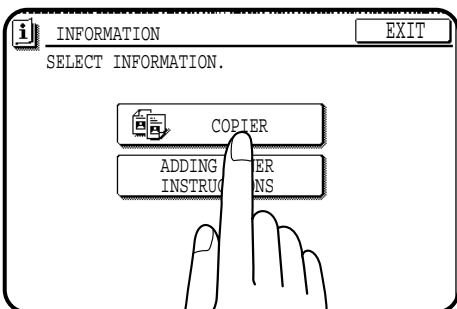

- 2 Select the "COPIER" key to display the first screen of the copier feature items.**
 - If the toner supply is not low, this screen is not displayed. Proceed to step 3.

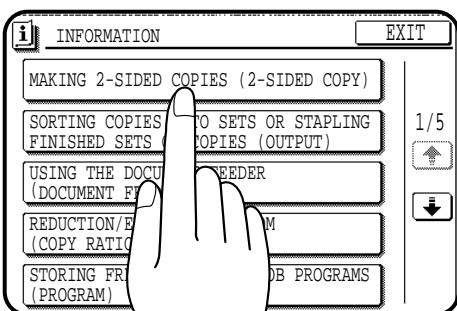

- 3 Select the feature you would like to know about by pressing a copier feature item key on the touch panel.**
 - If the feature you would like to know about is not displayed on the touch panel, press the scroll (↓) key on the touch panel until the feature is displayed.
 - If a copier feature item key is pressed, the description for that feature will appear. Use the scroll (↓) key to display additional information until all information for that feature has been displayed.
 - To return to the copier feature item screen, press the "INDEX" key.
 - To exit the INFORMATION mode, press the "EXIT" key on the touch panel.

USING THE TOUCH PANEL

How to use the touch panel

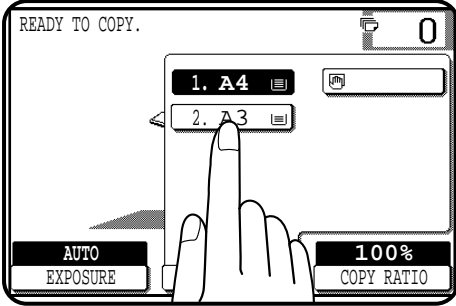

You can set or cancel a function displayed on the touch panel by pressing (touching) a key with a finger. The touch key operation can be confirmed with a beep tone (and highlighted display).

★ **KEY OPERATOR** For the beep tone to be heard, the beep tone must be enabled by a key operator program. See page 8-29.

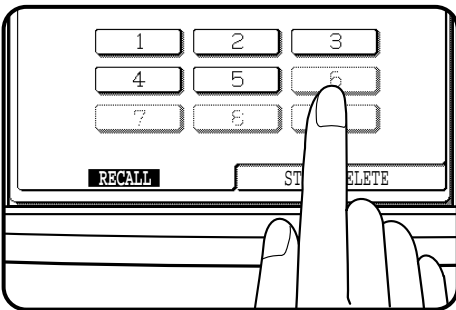

If any keys are displayed gray, the keys have been disabled. If you press these keys, two short beeps will be sounded.

Selection of function

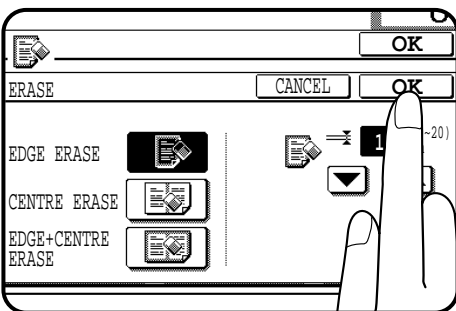

To register the selected settings for a function, press the "OK" key on the setting screen. The settings indicated by a highlighted display will be registered as a selected function.

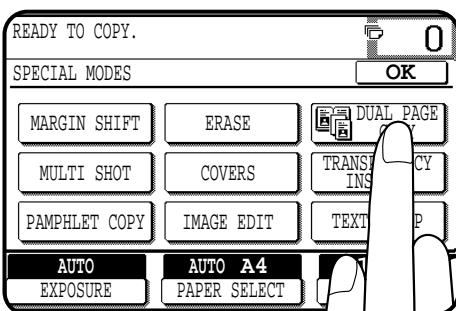

Some special functions can be selected by pressing the relevant keys on the SPECIAL MODES screen (page 3-4) or on the IMAGE EDIT menu (page 3-21) to highlight the keys. To cancel these functions, press the relevant keys again to return the keys to the normal display. These functions are: Dual page copying, Centring, B/W reverse, and Binding change.

Function setting icons

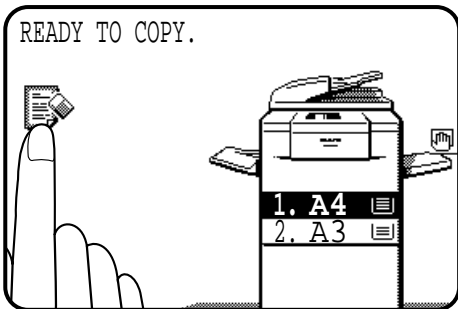

Selected special functions are indicated with their icons on the basic screen. The setting screen for a selected function can be easily called by pressing its icon. If multiple special functions are selected, up to six icons will be displayed.

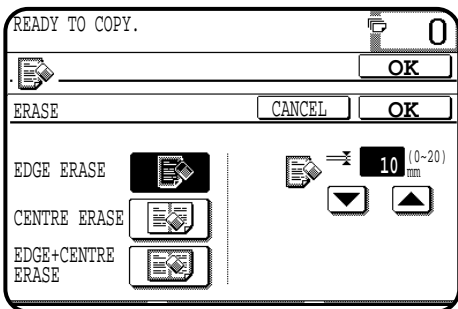

The function setting icons are listed below. The content of the icons indicated by *1 will change depending upon the particular settings for these functions.



*1 Margin shift (p.3-4)



*1 Repeat copy (p.3-24)



*1 Erase (p.3-6)



B/W reverse (p.3-27)



Dual page copying (p.3-8)



Binding change (p.3-29)



*1 Multi shot (p.3-10)



Date (p.3-32)



*1 Covers (p.3-13)



Select stamp (p.3-35)



*1 Transparency film with insert sheets (p.3-15)



Watermark (p.3-38)



Pamphlet copy (p.3-17)



Page number (p.3-41)



Job build (p.3-20)



Tandem copy (p.3-44)



Centring (p.3-22)

FACE UP/FACE DOWN DELIVERY

In this copier, copies will be delivered face up or face down depending on the features and paper type to be used.

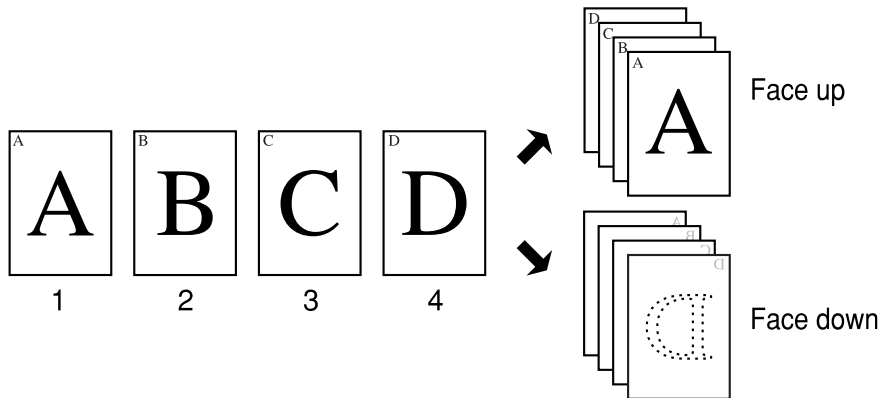

When normal copying is performed in the sort or group mode using plain paper, copies will be delivered face down. In the following cases, copies will be delivered face up.

- Special paper is used through the bypass tray.
- The COVERS feature or TRANSPARENCY INSERTS feature is used. When this feature is used, cover stock or transparency film must be fed through the bypass tray.
- Copying is performed from the document glass in the NON-SORT mode (neither SORT nor GROUP is specified).

When an optional finisher (AR-FN3) is installed, the specifications of face up/face down delivery are different from those without the finisher.

- When the offset tray is selected, copies will always be delivered face down. Face up/down will be controlled in the copier so that copies are always delivered face down regardless of the functions and paper to be used.
- When the top tray is selected, face up/down control is the same as that of the copier without the optional finisher.

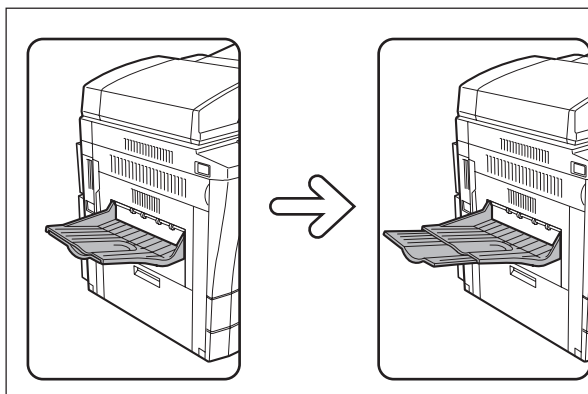

- Be sure to extend the tray when feeding B4 or A3 (8-1/2" x 14" or 11" x 17") sized paper.

CHAPTER 2

MAKING COPIES

This chapter describes the basic copying functions such as normal copying, reduction/enlargement, and exposure adjustments.

	Page
• AUDITING ACCOUNTS	2-2
• USING THE RSPF	2-3
• COPYING FROM THE DOCUMENT GLASS	2-8
• REDUCTION/ENLARGEMENT/ZOOM	2-11
• SPECIAL PAPERS (manual feed)	2-14
• EXPOSURE ADJUSTMENTS	2-16
• SORT/GROUP	2-17
• JOB MEMORY	2-18
• INTERRUPTING A COPY RUN	2-20

AUDITING ACCOUNTS

If this copier has been programmed in the auditing mode, it will not function until an assigned 5-digit account number has been entered.

★ **KEY OPERATOR** See page 8-9 for setting the auditing mode.

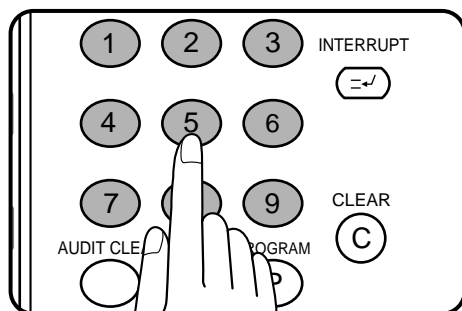

The initial status of the message display will be:

```
ENTER YOUR ACCOUNT NUMBER. -----
```

- Enter your account number using the 10-key pad.
- As each digit is entered, the dashes in the display will change to asterisks.

The following message will appear after the number is entered.

```
ACCOUNT STATUS: COPIES MADE 000,000  
COPIES REMAINING 000,000
```

“COPIES REMAINING” will appear only if account limit has been set using a key operator program.

★ **KEY OPERATOR** See page 8-14 for account limit settings.

The message, however, will not be displayed when the printer auditing mode is enabled by the key operator program with the optional printer expansion kit installed. Then the account limit setting will be cancelled.

★ **KEY OPERATOR** See page 46 of the AR-PB2A operation manual for the printer auditing mode setting.

- The message will be displayed for several seconds, then change to the following message.

```
READY TO COPY.
```

- When a copy run is performed, the following message will appear.

```
READY TO COPY.  
PRESS [AUDIT CLEAR] WHEN FINISHED.
```

- In the interrupt copy mode (see page 2-20), the following message will appear instead of the message above.

```
READY TO COPY. WHEN COPYING IS  
FINISHED, PRESS [INTERRUPT].
```

NOTE:

If an unassigned number is entered, the message display will show “ENTER YOUR ACCOUNT NUMBER. -----”, indicating that the number was not accepted.

When the key operator program of account number security has been set:

If an unassigned number is entered three successive times, the copier will not accept another number for one minute, and the following message will appear.

```
PLEASE SEE YOUR KEY OPERATOR FOR  
ASSISTANCE.
```

★ **KEY OPERATOR** See page 8-15 for account number security.

USING THE RSPF

The RSPF (reversing single pass feeder) will handle multiple originals.

- Before loading originals into the document feeder tray, be sure to remove any staples or paper clips from them.
- Damaged or crumpled originals or originals which have been folded may misfeed in the RSPF or cause incorrect size detection. It is recommended that these be copied from the document glass and the copies be used as original documents.
- When feeding originals which have closely spaced binding holes punched along an edge, place the originals so that the punched edge is positioned to the right or along the side guides.
- Special originals such as transparency film and tracing paper should not be fed from the RSPF, but should be placed on the document glass.
- Duplex copying will not work when a non-standard sized paper (or 5-1/2" x 8-1/2" paper) is used.
- If the orientation of the originals does not match that of the copy paper when both the originals and copy paper are of standard sizes and the auto paper select mode or automatic copy ratio select mode is on, the image of the originals will be automatically rotated to match the copy paper. If enlargement copying onto a paper size larger than A4 (8-1/2" x 11") is performed and in case of 100% copying onto a paper size larger than B4 (8-1/2" x 14"), however, the image will not be rotated.
- Image loss (max. 5mm (13/64")) can occur along the leading and trailing edges of the copies. Also image loss (max. 5mm (13/64")) in total) can occur along the other edges of the copies.

- The RSPF can handle a maximum of 50 originals in A4 (8-1/2" x 11") paper size.
- 1-sided to 2-sided, 2-sided to 1-sided, and 2-sided to 2-sided copying can be performed.
- The originals must be set face up in the document feeder tray.
- Different size originals with the same width can be placed in the document feeder tray and automatically copied onto copy paper of their respective sizes. The automatic copy ratio selection will not function in this case. Also, some special functions might not be properly activated.
- When using large originals such as B4 and A3 (8-1/2" x 14" and 11" x 17") sizes, unfold the auxiliary tray.

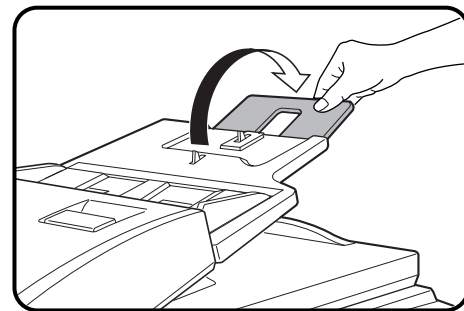

Stream feeding mode

If the stream feeding mode has been enabled using a key operator program, the message "NEWLY PLACED ORIGINALS WILL BE FED AND COPIED AUTOMATICALLY." will appear for approximately 5 seconds after feeding of all originals is completed. While this message is displayed, any new originals placed in the document feeder tray will be fed and copied automatically.

★ **KEY OPERATOR** See page 8-19 for information on setting the stream feeding mode.

NOTE:

- The original image positions on the copies are different concerning the leading edge position between copying from the RSPF and copying from the document glass. In some cases, the desired copy cannot be obtained from the normal orientation of the originals. The image position can be changed by rotating the original. When the optional staple sort mode is used, however, the stapling position may not be proper.

1. Different image positions on the copy

Same-size copying onto a larger size copy is performed.

Example) Same-size copying from A4 (8-1/2" x 11") original onto A3 (11" x 17") paper

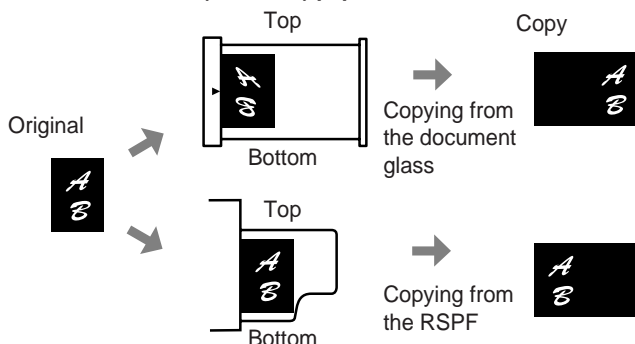

2. Different copy image ranges

Enlargement copying is performed onto copy paper of the same size as the original and part of image is out of the copy.

Example) Enlargement copying onto copy paper of the same size as the original

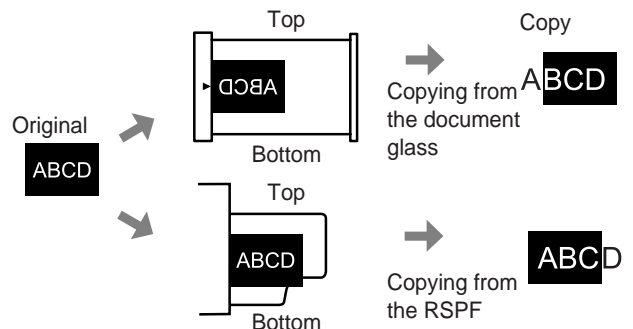

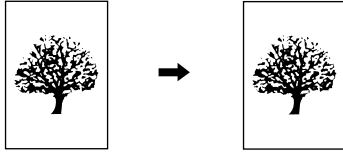

1-sided copies of 1-sided originals

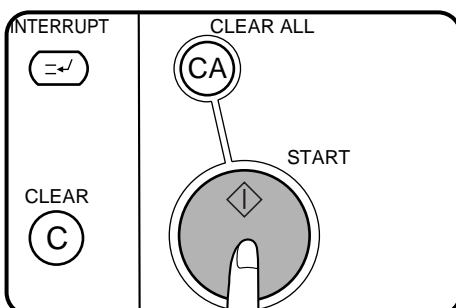
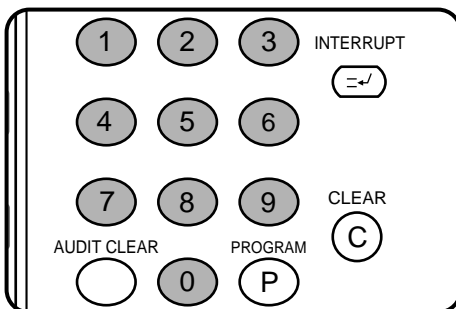
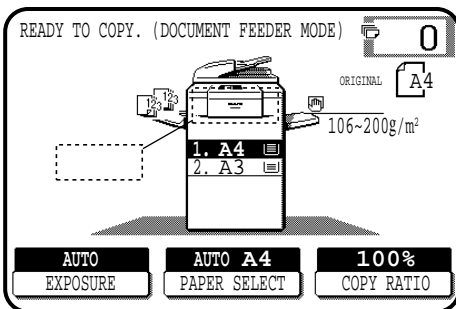
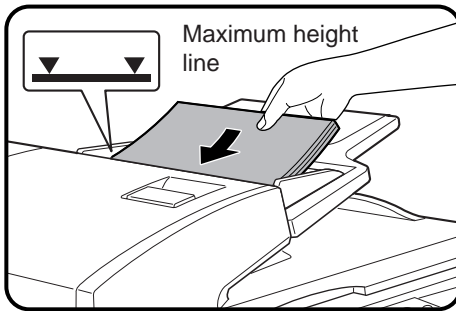
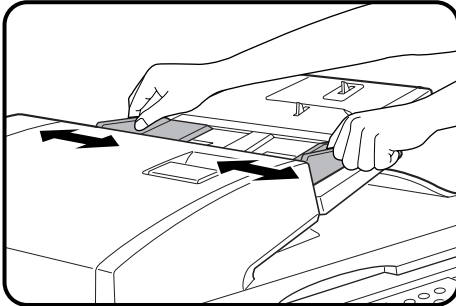

1 Adjust the original guides to the size of the originals and set the originals face up in the document feeder tray.

- The original size will be indicated on the touch panel, and the paper tray with the corresponding paper size will be automatically selected.
- Be sure to remove any original from the document glass before setting the originals in the document feeder tray. However, if an original has been placed on the document glass, copying will be performed from the RSPF when the START (◇) key is pressed.
- If copy paper of the required size is not installed in any of the trays, the following message will appear.

LOAD PAPER.

- If a tray of the required size is not installed, use the bypass tray and press the "PAPER SELECT" key on the touch panel to select the bypass tray.
- To copy onto a different size paper, use the "PAPER SELECT" key to make the selection.

2 Ensure that the 1-sided to 1-sided copying mode is selected on the touch panel.

- When no icon is displayed in the area indicated in the illustration (), the 1-sided to 1-sided copying mode is selected.
- If the 1-sided to 1-sided mode is not selected, press the 2-SIDED COPY key and then press the 1-sided to 1-sided key () on the touch panel. Press the "OK" key to return to the basic screen.

3 Use the 10-key pad to enter the desired number of copies.

- The number will be shown in the copy quantity display of the touch panel.
- Use the CLEAR (C) key to cancel an entry if a mistake has been made.
- If you set a multiple number of copies, the copies will be delivered collated. To deliver in the GROUP mode, press the OUTPUT key and then select "GROUP" on the touch panel. See page 2-17.

4 Press the START (◇) key.

- To cancel a copy run, press the CLEAR ALL (CA) key. Copying will stop and the RSPF will output any originals which have been fed. Also, the number in the copy quantity display will be reset to 0.

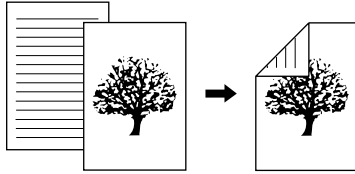

2-sided copies from 1-sided originals

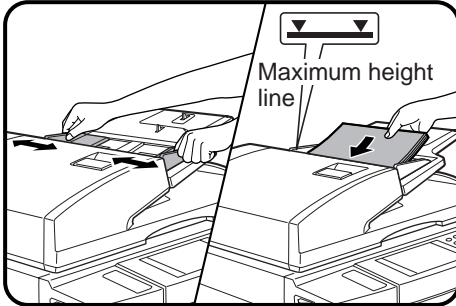

1 Adjust the original guides to the size of the originals and set the originals face up in the document feeder tray.

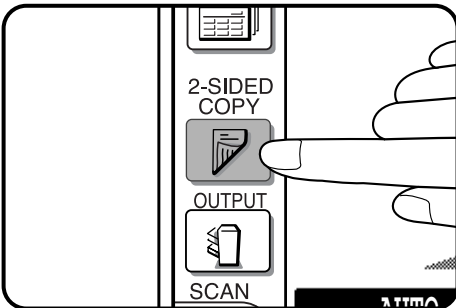

2 Press the 2-SIDED COPY key.

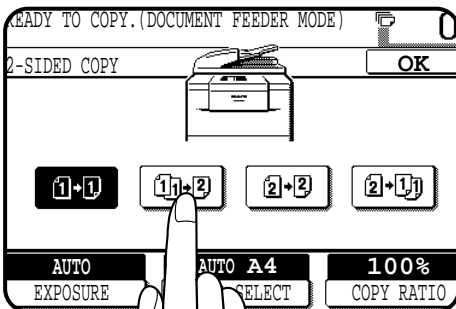

3 Press the **1j-2** key on the touch panel.

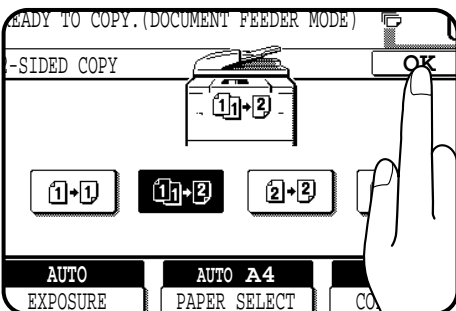

4 Press the "OK" key.

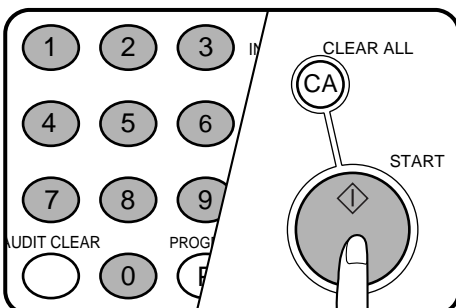

5 Enter the desired number of copies.

6 Press the START (◊) key.

- To cancel a copy run during duplex copying, press the CLEAR ALL (CA) key.

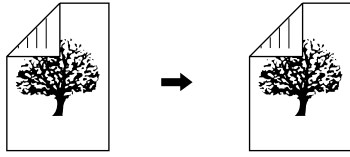

2-sided copies from 2-sided originals

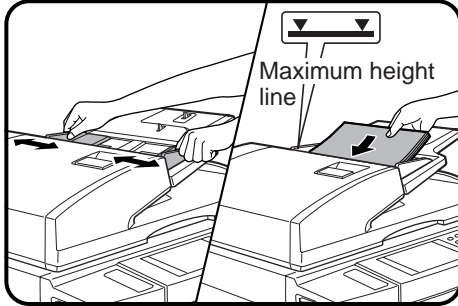

1 Adjust the original guides to the size of the originals and set the originals face up in the document feeder tray.

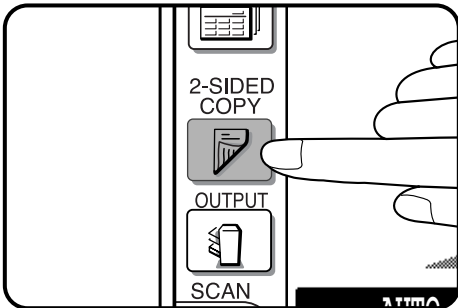

2 Press the 2-SIDED COPY key.

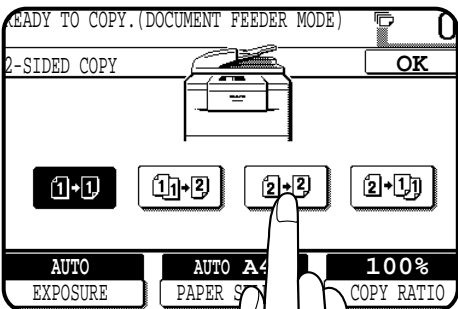

3 Press the **2-2** key on the touch panel.

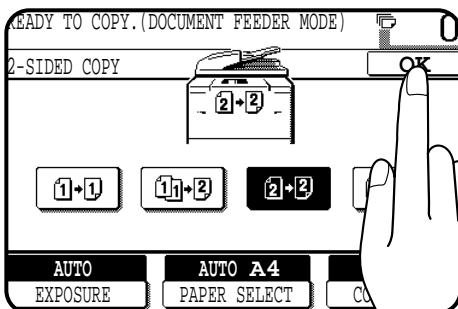

4 Press the "OK" key.

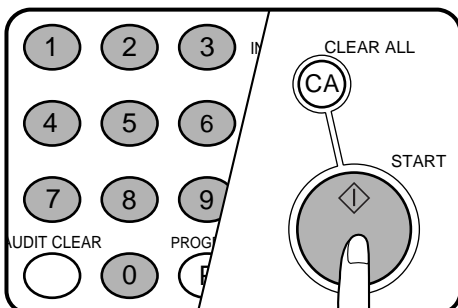

5 Enter the desired number of copies.

6 Press the **START** (**▶**) key.

- To cancel a copy run during duplex copying, press the CLEAR ALL (**CA**) key.

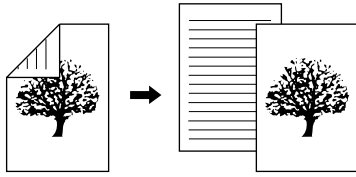

1-sided copies from 2-sided originals

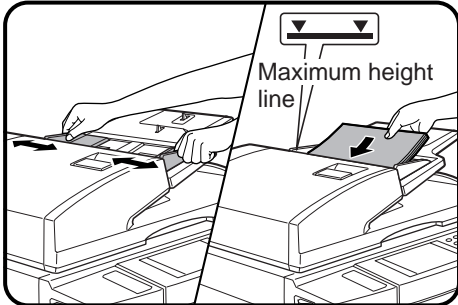

1 Adjust the original guides to the size of the originals and set the originals face up in the document feeder tray.

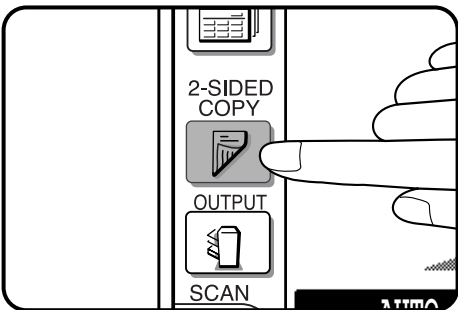

2 Press the 2-SIDED COPY key.

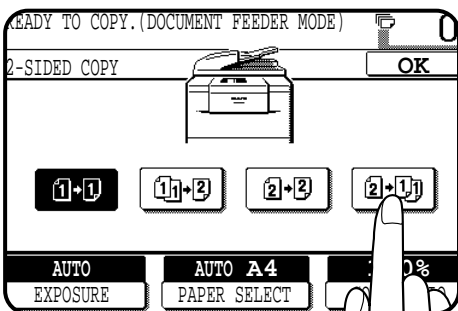

3 Press the  key on the touch panel.

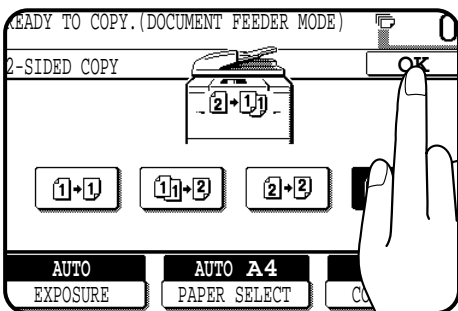

4 Press the "OK" key.

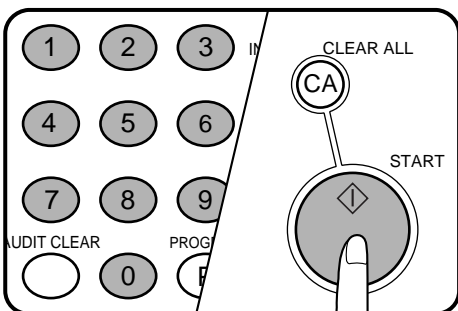

5 Enter the desired number of copies.

6 Press the START (◊) key.

- To cancel a copy run, press the CLEAR ALL (CA) key. Copying will stop and the RSPF will output any originals which have been fed. Also, the number in the copy quantity display will be reset to 0.

COPYING FROM THE DOCUMENT GLASS

Use the document glass for copying single originals, bound documents, and other originals that cannot be set in the RSPF.

- Only 1-sided to 1-sided and 1-sided to 2-sided copying can be selected when copying from the document glass.
- Duplex copying will not work when a non-standard sized paper (or 5-1/2" x 8-1/2" paper) is used.
- 2-sided to 2-sided or 2-sided to 1-sided copying cannot be selected when copying from the document glass. These operations can, however, be performed simply by turning over the original manually.

- If the orientation of the original does not match that of the copy paper when both the original and copy paper are of standard sizes and the auto paper select mode or automatic copy ratio select mode is on, the image of the original will be automatically rotated to match the copy paper. If enlargement copying onto a paper size larger than A4 (8-1/2" x 11") is performed and in case of 100% copying onto a paper size larger than B4 (8-1/2" x 14"), however, the image will not be rotated.
- Image void (max. 5 mm (13/64")) can occur along the leading and trailing edges of the copies. Also image void (max. 5 mm (13/64")) in total can occur along the other edges of the copies.

1-sided copies of 1-sided originals

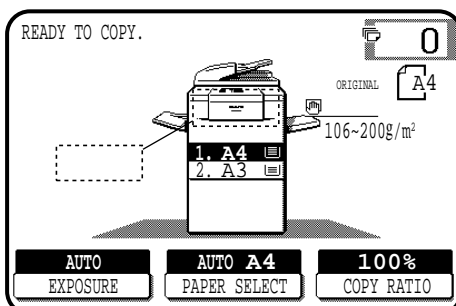
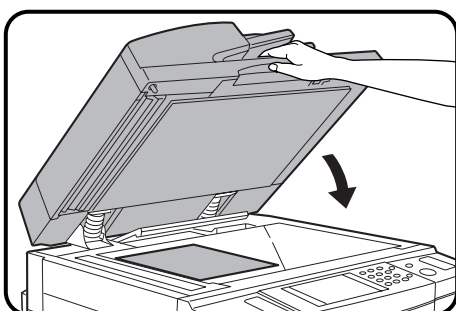
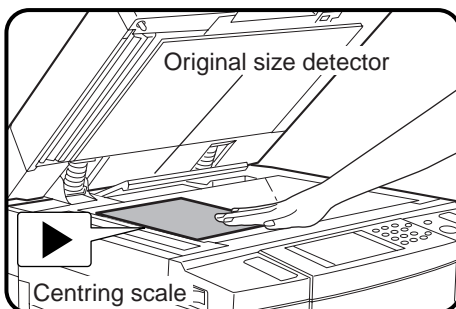

1 Open the document feeder cover and place an original face down on the document glass, using the centring scale to position it.

- When copying multi-page documents, copy from the first page to the last page. When copying onto special paper placed on the bypass tray, however, copy from the last page to the first page because copies will be delivered face up.
- If the copier is in the SORT or GROUP mode, copies will be delivered face down unless the bypass tray is used to feed special paper. If the copier is not in the SORT or GROUP mode, copies will be delivered face up.

NOTE:

Do not place objects under the original size detector, because they may damage it.

2 Close the document feeder cover.

- The original size will be indicated on the touch panel, and the paper tray with the corresponding paper size will be automatically selected.

3 Ensure that the 1-sided to 1-sided copying mode is selected on the touch panel.

- When no icon is displayed in the area indicated in the illustration (), the 1-sided to 1-sided copying mode is selected.
- If the 1-sided to 1-sided mode is not selected, press the 2-SIDED COPY key and then press the 1-sided to 1-sided key () on the touch panel. Press the "OK" key to return to the basic screen.

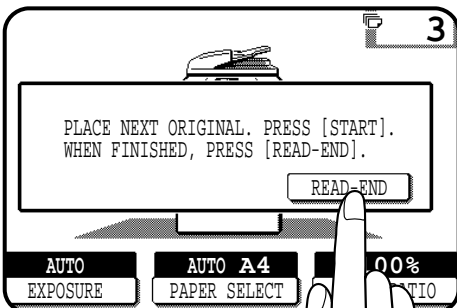
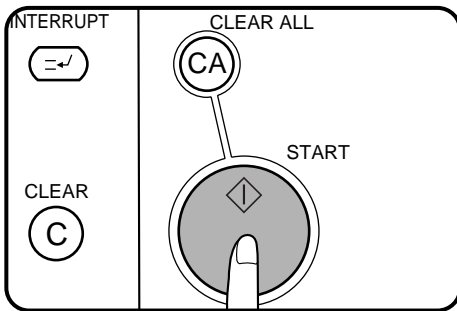
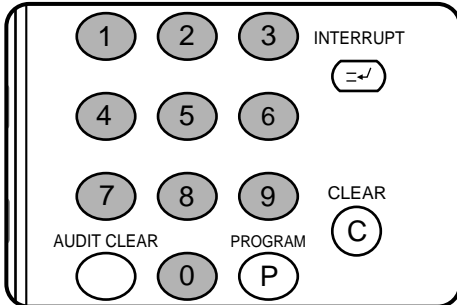

4 Use the 10-key pad to enter the desired number of copies.

- The number will be shown in the copy quantity display of the touch panel.
- A single copy can be made with the initial setting, i.e., when "0" is displayed.
- Use the CLEAR (C) key to cancel an entry if a mistake is made.
- If you set a multiple number of copies, the copies will not be delivered collated in the default setting. To deliver in the SORT mode, press the OUTPUT key and then select the SORT mode on the touch panel. See page 2-17.

5 Press the START (◇) key.

- If the copier is not in the SORT mode (the sort icon is not displayed on the touch panel), copying will start and the number in the copy quantity display will decrease by 1 each time a copy is made. To repeat the same copy sequence with a different original, simply replace the original and press the START (◇) key.
- If the copier is in the SORT mode, the original will be scanned when the START (◇) key is pressed but copying will not begin. Proceed to step 6.
- To cancel a copy run, press the CLEAR ALL (CA) key. Copying will stop and the number in the copy quantity display will be reset to 0.

6 Replace the first original with the next original after the START (◇) key indicator lights up, and then press the START (◇) key. Repeat this step until all the originals have been scanned. Then, press the "READ-END" key on the touch panel.

- Copying will start after the "READ-END" key is pressed.
- Up to 120 sheets of A4 (8-1/2" x 11") originals or up to 60 sheets of originals larger than A4 (8-1/2" x 11") can be scanned.

2-sided copies from 1-sided originals

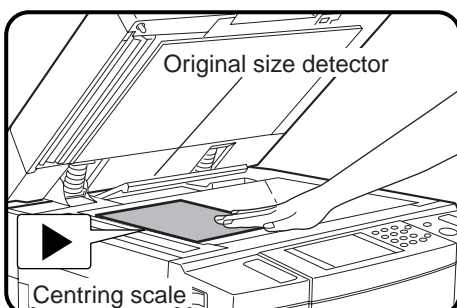

1 Set the first page of the document onto the document glass, using the centring scale to position it.

NOTE:

Do not place objects under the original size detector, because they may damage it.

2 Close the document feeder cover.

- The original size will be indicated on the touch panel, and the paper tray with the corresponding paper size will be automatically selected.

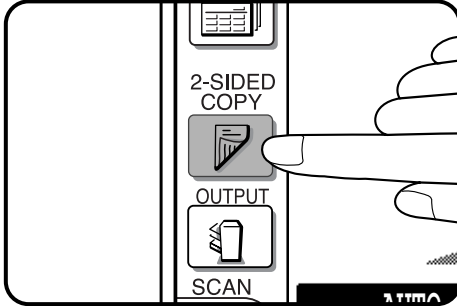

3 Press the 2-SIDED COPY key.

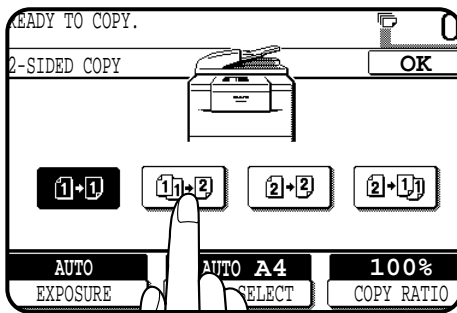

4 Press the  key on the touch panel.

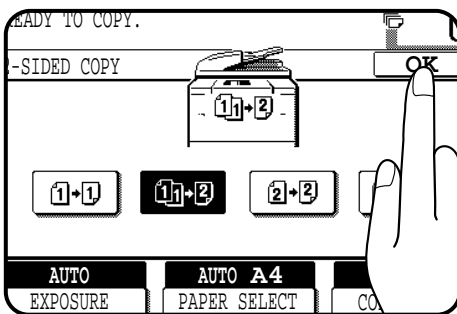

5 Press the “OK” key.

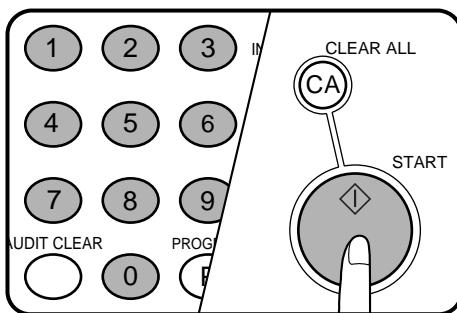

6 Use the 10-key pad to enter the desired number of copies.

- The number will be shown in the copy quantity display.
- Use the CLEAR (C) key to cancel an entry if a mistake is made.

7 Press the START (◀) key.

- The original will be scanned each time the START (◀) key is pressed, but copying will not begin yet.

8 Remove the first original and replace it with the next original after the START (◀) key indicator lights up, and then press the START (◀) key.

9 Repeat step 8 until all originals have been scanned. Then, press the “READ-END” key on the touch panel.

- Copying will start after the “READ-END” key is pressed. Up to 120 sheets of A4 (8-1/2" x 11") originals or up to 60 sheets of originals larger than A4 (8-1/2" x 11") can be scanned.
- To cancel a copy run, press the CLEAR ALL (CA) key.

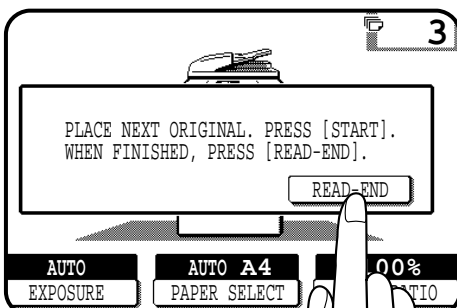

REDUCTION/ENLARGEMENT/ZOOM

Reduction and enlargement ratios can be selected either automatically with the "AUTO IMAGE" key or manually with the reduction, enlargement or "ZOOM" keys on the touch panel. The zoom function enables precise copy ratio selection from 25% to 400% in 1% increments.

★ **KEY OPERATOR** A total of four extra preset copy ratios, two each for reduction and enlargement, can be added. See page 8-17.

Automatic selection

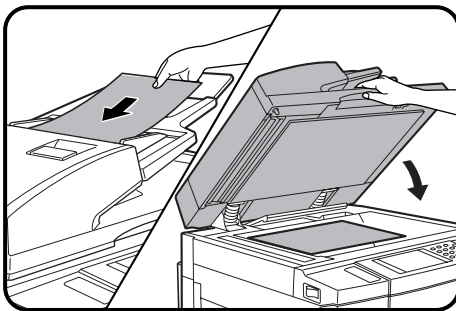

1 Place the original in the document feeder tray or on the document glass.

- The original size will be detected and indicated on the touch panel.

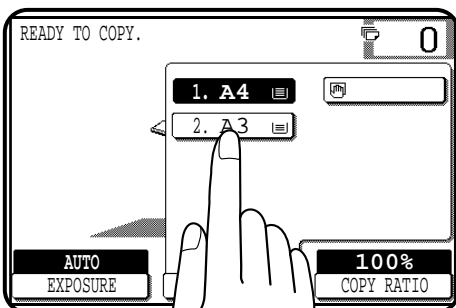

2 Press the "PAPER SELECT" key on the touch panel and select the paper tray with the desired paper size.

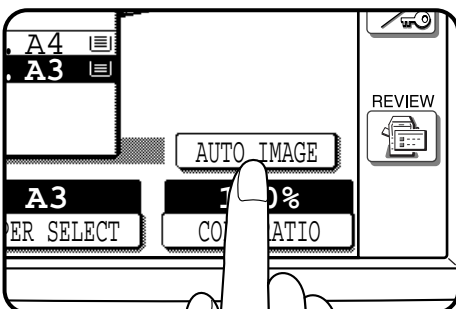

3 Press the "AUTO IMAGE" key on the touch panel.

- The best reduction or enlargement ratio for the selected paper size will be automatically set and displayed on the touch panel.
- If the originals and the selected copy paper are not facing the same direction, the image will be automatically rotated to match the copy paper. If enlargement copying onto a paper size larger than A4 (8-1/2" x 11") is performed and in case of 100% copying onto a paper size larger than B4 (8-1/2" x 14"), however, the image will not be rotated.

NOTE:

This feature will not work when original or copy paper is of non-standard size.

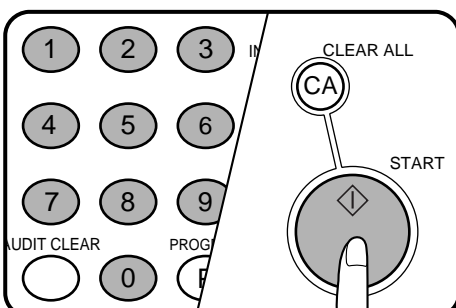

4 Enter the desired number of copies.

5 Press the START (◊) key.

- To cancel the automatic reduction/enlargement mode, press the "AUTO IMAGE" key again.

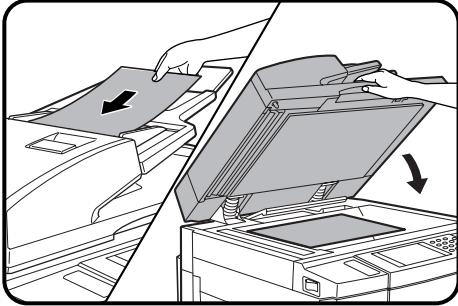

1 Place the original in the document feeder tray or on the document glass.

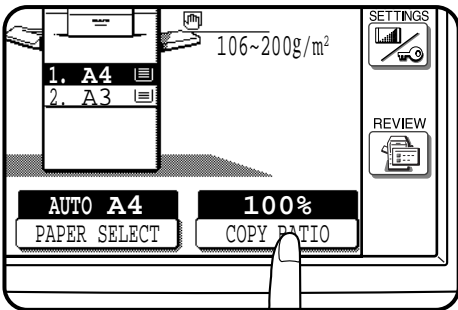

2 Press the “COPY RATIO” key on the touch panel.

MENU 1

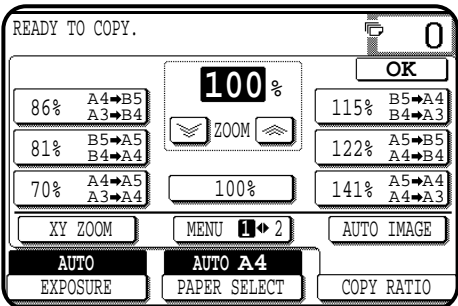

3 Use the **MENU** \leftrightarrow **2** key to select menu 1 or menu 2 for copy ratio selection.

Menu 1

A. Preset reduction copy ratios are: 86%, 81%, and 70% (77% and 64%).

B. Preset enlargement copy ratios are: 115%, 122%, and 141% (121% and 129%).

Menu 2

A. Preset reduction copy ratios are: 50% and 25% (95%, 50%, and 25%).

B. Preset enlargement copy ratios are: 200% and 400% (141%, 200%, and 400%).

MENU 2

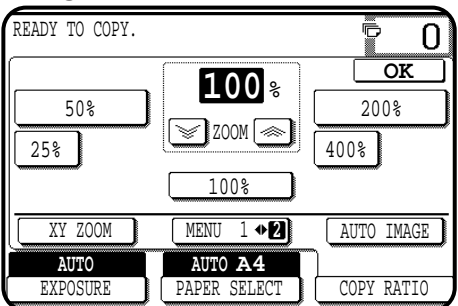

4 Use the reduction, enlargement, and “ZOOM” keys on the touch panel to set the desired copy ratio.

Zoom ratios: Any ratio from 25% to 400% can be set in 1% increments.

- Press a reduction or enlargement key to set the approximate ratio, then press the ∇ key to decrease the ratio or the \triangleleft key to increase the ratio.
- To set the horizontal and vertical copy ratios separately, use the XY ZOOM feature. See page 3-2.
- To reset the copy ratio to 100%, press the “100%” key on the touch panel.
- The message “**IMAGE IS LARGER THAN THE COPY PAPER.**” may appear, indicating that the selected copy ratio is too large for the copy paper size. However, if you press the START (\diamond) key, a copy will be made.
- The image of the original may be rotated to match the copy paper orientation if the original and copy paper are of standard sizes.

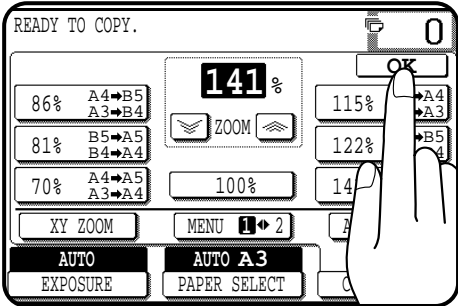

5 Press the “OK” key.

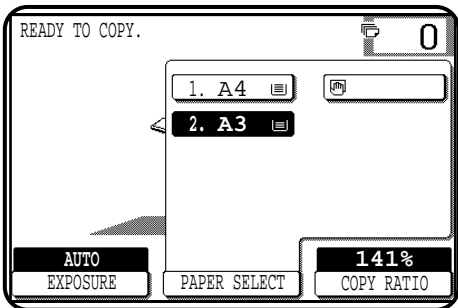

6 Use the “PAPER SELECT” key to select the paper tray with the desired paper size.

- If the AUTO PAPER SELECT mode is on, the appropriate copy paper size will have been automatically selected based on the original size and selected copy ratio.
- If a tray of the required size is not installed, use the bypass tray and press the “PAPER SELECT” key to select the bypass tray.

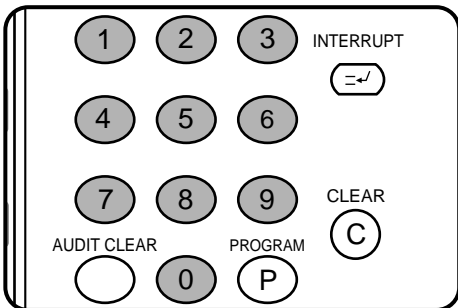

7 Enter the desired number of copies.

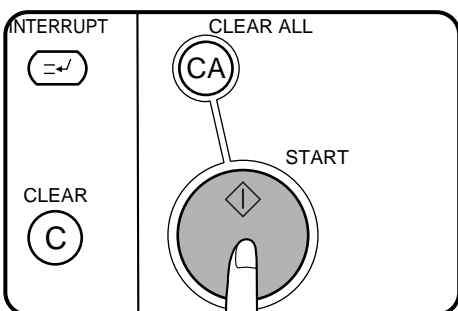

8 Press the START (◊) key.

SPECIAL PAPERS (manual feed)

The bypass tray is used to copy onto transparency film, labels, tracing paper, and other special purpose papers. Up to 50 sheets of standard copy paper can be set in the bypass tray.

- Automatic duplex copying will not work when a non-standard sized paper is used. If a duplex copying mode is selected and a non-standard sized paper is used from the bypass tray, the corresponding one-sided mode will be selected automatically when the START (⏏) key is pressed.

NOTE:

In this copier, copies are normally delivered face down. When copying onto special paper (including transparency film) placed in the bypass tray, however, copies will be delivered face up. When copying multi-page documents from the document glass onto special paper, copy from the last page to the first page. Also,

if an optional finisher (AR-FN3) is installed and the top tray output is selected, copy from the last page to the first page and then press the "READ-END" key on the touch panel. Copying will start after the "READ-END" key is pressed. In the default setting, paper placed in the bypass tray is always regarded as special paper and auto paper selection for the bypass tray is disabled.

★ **KEY OPERATOR** *If the selection of paper type placed in the bypass tray is enabled, the type of copy paper can be specified on the touch panel after the "PAPER SELECT" key is pressed. Plain paper placed in the bypass tray can be regarded as plain paper and copies can be delivered face down. See page 8-22. And if auto paper selection from the bypass tray is enabled, paper placed in the bypass tray will be one of the alternatives of auto paper selection adding to other paper trays. See page 8-28. This function is available only when the selection of paper type placed in the bypass tray is enabled.*

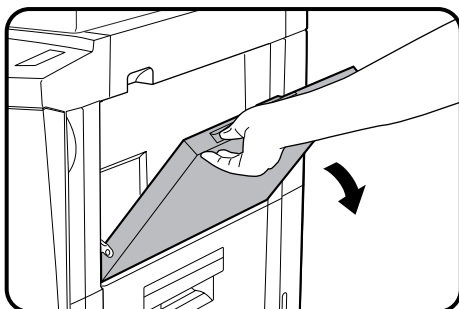

1 Place the original in the document feeder tray or on the document glass.

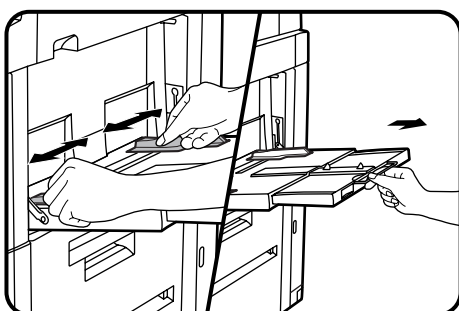

2 Open the bypass tray.

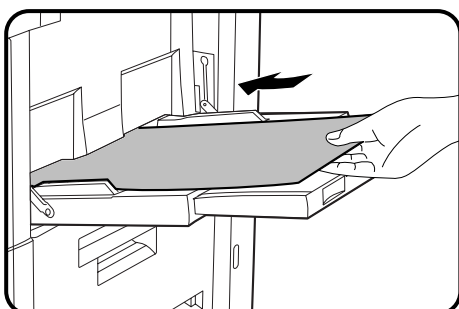

3 Set the bypass tray guides to the width of the copy paper.

- Be sure to extend the tray when feeding A4R, B4 or A3 (8-1/2" x 11"R, 8-1/2" x 14" or 11" x 17") sized paper. When feeding A3 (11" x 17") sized paper, pull out the metallic support.

4 Insert the copy paper all the way into the bypass tray.

- Labels, tracing paper, and other special purpose papers other than SHARP recommended transparency film must be fed individually. Multiple sheets of SHARP recommended transparency film can be loaded in the bypass tray.
- Up to 50 sheets of standard copy paper measuring from A6 to A3 (5-1/2" x 8-1/2" to 11" x 17") can be loaded into the bypass tray.
- For automatic two-sided copying of A5 paper, position the side guides against the copy paper's longest side.
- A6 size paper must be fed narrow side into the feed slot and must be fed individually.
- When adding paper, first remove remaining paper, combine it with the paper to be added and then reload as a single stack.

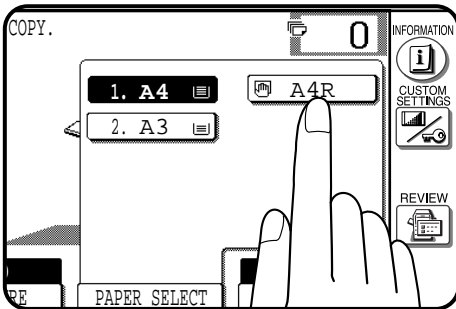

5 Press the “PAPER SELECT” key on the touch panel and then select the bypass tray.

- If paper type selection has been enabled, select “60 ~ 105 g/m²” (“16 ~ 28 lbs.”) or “106 ~ 200 g/m²” (“28+ ~ 55 lbs.”).

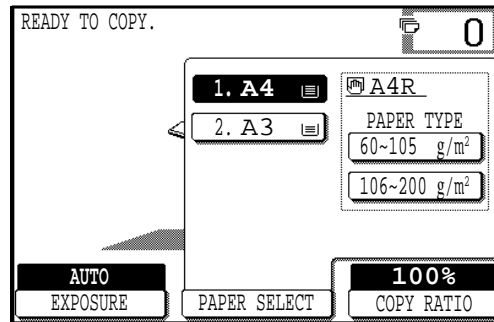

- If “60 ~ 105 g/m²” (“16 ~ 28 lbs.”) is specified and heavier paper is used, a misfeed may occur.

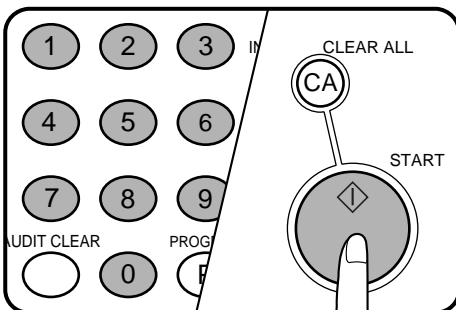

6 Set the number of copies.

7 Press the START (◊) key.

Two-sided copying with bypass tray

Two-sided copies can be made manually using the bypass tray, when the heavy paper which is out of specification for duplex module is used.

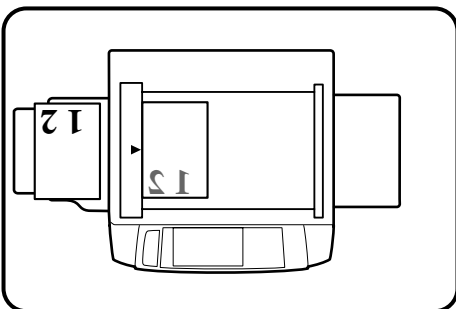

1 Place the first original face down on the document glass and make a copy.

- The first side of the copy can be made using any of the paper feed stations.

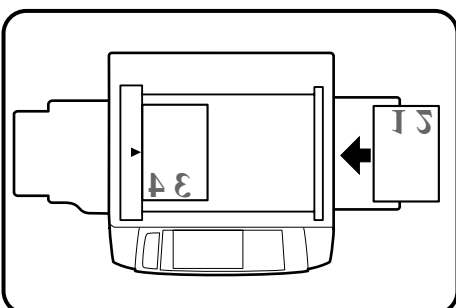

2 Replace the first original with the second original and close the document cover.

- Make sure the first and second originals are oriented in the same way on the document glass.
- The first and second originals can be set in the document feeder tray. They must, however, be set and fed individually.

3 Turn the first copy over without changing its top-bottom orientation and place it into the bypass tray.

- Be sure to feed the copies one sheet at a time.

4 Press the “PAPER SELECT” key and select the bypass tray.

- If paper type selection has been enabled, select “60 ~ 105 g/m²” (“16 ~ 28 lbs.”) or “106 ~ 200 g/m²” (“28+ ~ 55 lbs.”).

5 Press the START (◊) key.

EXPOSURE ADJUSTMENTS

This copier has four exposure modes to choose from: AUTOMATIC, TEXT, TEXT/PHOTO and PHOTO.

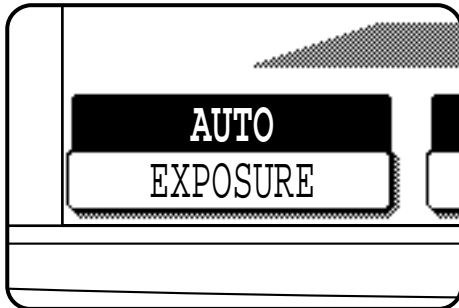

Automatic

This is the standard initial setting for this copier. In this mode, the characteristics of an original being copied are “read” by the exposure system, and exposure adjustments are made automatically. This optimizes the contrast of the copied images by reducing the effect of coloured or shaded background areas.

Text, text/photo, and photo

- Text mode:** This mode is useful in enhancing very low density areas of an original or in suppressing unusually high-density background areas.
- Text/photo mode:** This mode provides the best balance for copying an original which contains both text and photos. This mode is also useful for copying printed photographs.
- Photo mode:** This mode provides the best copies of photographs with fine details.

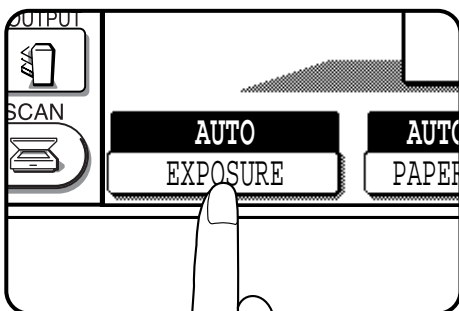

1 Press the “EXPOSURE” key on the touch panel.

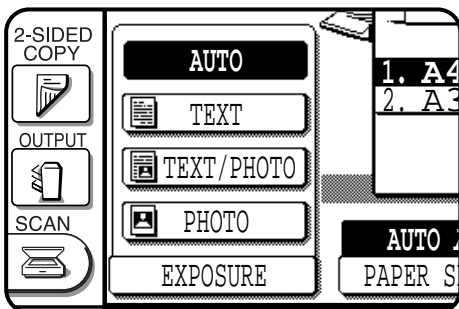

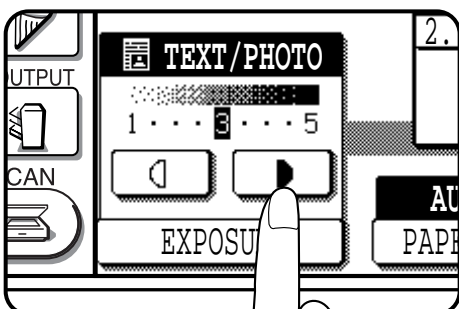

2 Select “TEXT”, “TEXT/PHOTO” or “PHOTO” depending on the original.





3 Use the  and  keys to adjust the copy density as desired.

SORT/GROUP

When the SORT () icon is indicated on the touch panel, copies will be collated by sets and then delivered to the exit tray.

When the GROUP () icon is indicated, copies will be grouped by originals.

- When the RSPF is used for copying, copies will be collated in the default setting. To copy in the GROUP mode, press the OUTPUT key and then select the GROUP mode on the touch panel. When the GROUP mode is selected, the GROUP () icon is indicated on the touch panel.
- When the document glass is used for copying, the copier is not in the SORT nor GROUP mode. Copies will be delivered face up each time the START () key is pressed. To copy in the SORT or GROUP mode, press the OUTPUT key and then select the SORT mode or GROUP mode on the touch panel. Copies will be delivered face down.

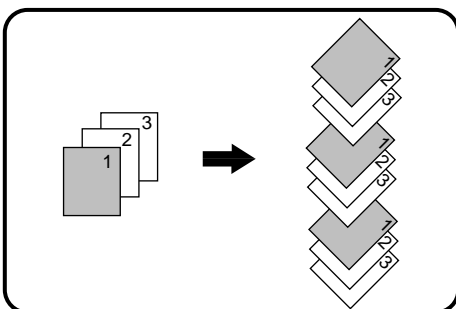

SORT mode

Each set of copies will be sequentially delivered to the exit tray.

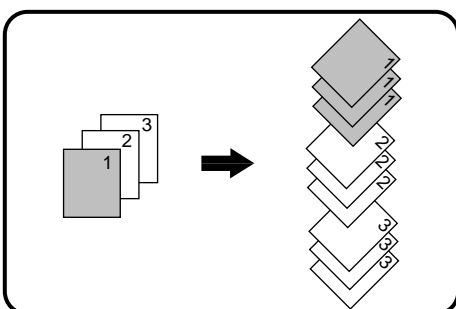

GROUP mode

All copies of the same original will be grouped in the exit tray.

JOB MEMORY

Frequently used job programs can be stored in each of nine storage registers. This is convenient for quick job recall without losing time manually reprogramming each aspect of the job.

- All functions that can be set in the copy mode except the copy quantity setting can be stored in the job memory.
- If any function which has been stored in a job program is modified by a key operator program, the key operator settings will supercede the previous setting.

★ **KEY OPERATOR** Job memory replacement/deletion can be prohibited. See page 8-27.

Storing a job program

1 Press the PROGRAM (P) key.

- The JOB PROGRAMS screen will appear on the touch panel.

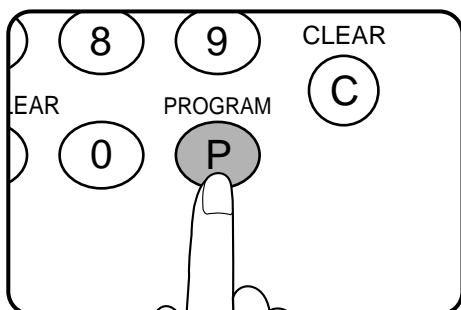

2 Press the "STORE/DELETE" key on the touch panel.

- To cancel the job memory mode, press the "EXIT" key or the CLEAR ALL (CA) key.

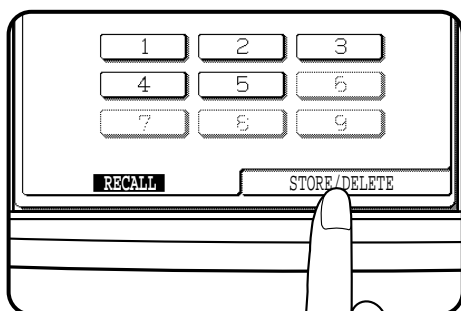

3 Select a program number from 1 to 9 on the touch panel.

- The numbers which are highlighted are program numbers which have been used.
- If a program number which has been used is entered, a message will appear to confirm the selection. To replace with the new program, press the "STORE" key and proceed to the next step. To cancel replacement, press the "CANCEL" key.

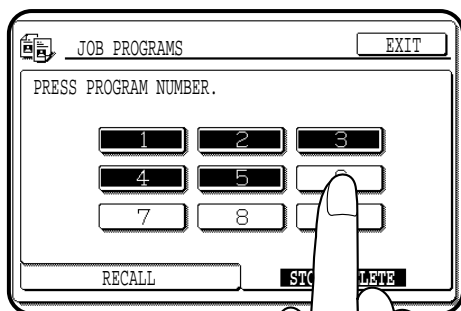

4 Make all copier selections to be stored.

5 Press the "OK" key to complete the storage.

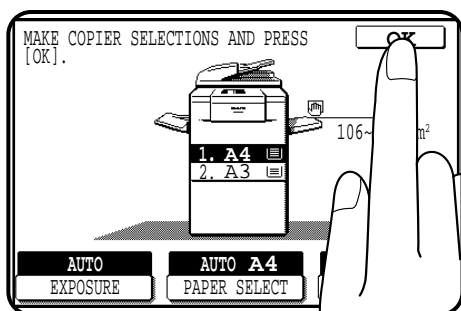

Deleting a stored job program

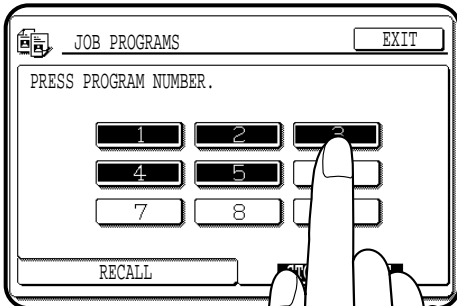

1 Follow steps 1 and 2 in “Storing a job program” on the previous page. (1. Press the PROGRAM (P) key. 2. Press the “STORE/DELETE” key.)

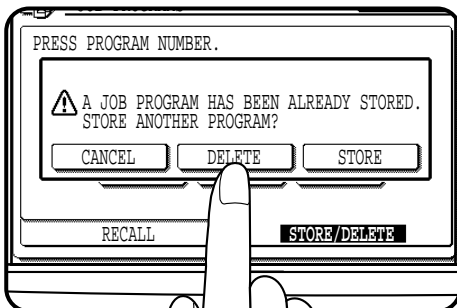

2 Select the storage register number of the program to be deleted.

- Be sure to select a number which contains a stored program. If not, “Storing a job program” operation will start.

3 Press the “DELETE” key.

- The program will be deleted from memory.
- To cancel deletion, press the “CANCEL” key.

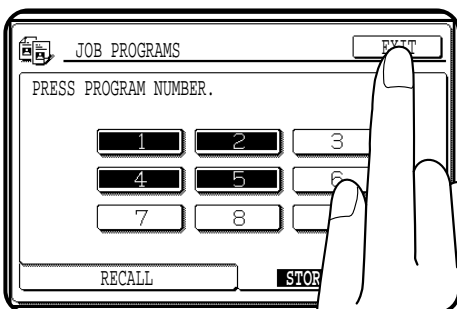

4 Press the “EXIT” key to exit the job memory mode.

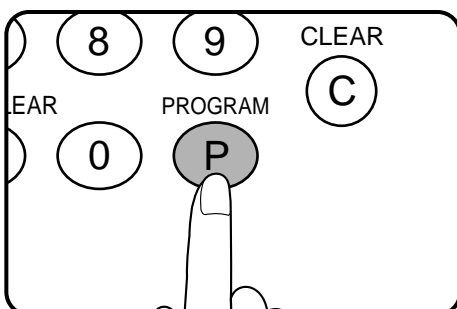

Recalling a job program

1 Press the PROGRAM (P) key.

- The JOB PROGRAMS screen will appear on the touch panel.
- The numbers which are indicated are program numbers which contain stored programs.

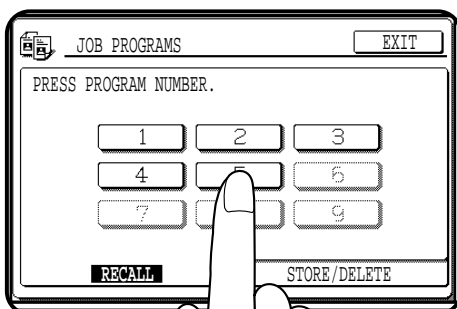

2 Select a stored program from 1 to 9 on the touch panel.

- All selections stored in the program will appear on the touch panel.
- The recalled settings may be modified for a particular job run, but any changes made will not be stored in the job memory. To store the new settings, follow the “Storing a job program” procedure.

INTERRUPTING A COPY RUN

INTERRUPT can be used to temporarily stop a long copy run so that another job can be run.

- INTERRUPT will not function during duplex copying.
- Duplex copying, tandem copying and the JOB BUILD function can not be selected during interrupt copying.

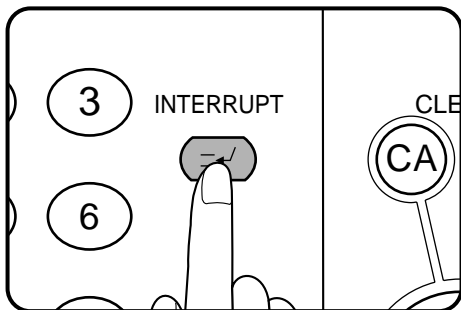

1 Press the INTERRUPT () key.

- When the document feeder is being used, the copier will stop after completing the copying of the originals which have been fed into the document feeder. The INTERRUPT indicator will blink until the copier becomes ready for interrupt copying. Then the INTERRUPT indicator will light up. The copier will return to the initial setting.
- If the copier has been programmed in the auditing mode, the account number entry message will appear. Enter your account number using the 10-key pad. The number of copies of the interrupt copying will be accumulated against this account number.

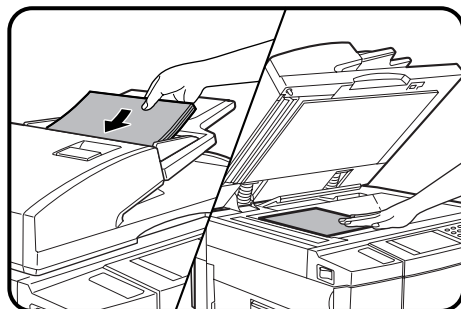

2 When the copier stops, remove the original(s) and set the original(s) for interrupt copying in the document feeder tray or on the document glass.

- The maximum number of originals for interrupt copying is restricted.
1-sided originals: 20 sheets (10 sheets for B4 and A3 (8-1/2" x 14" and 11" x 17"))
2-sided originals: 10 sheets (5 sheets for B4 and A3 (8-1/2" x 14" and 11" x 17"))

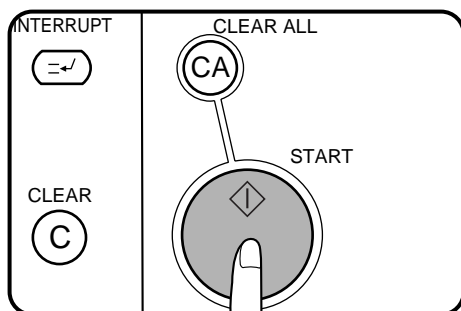

3 Select the desired available copier functions.

4 Press the START () key.

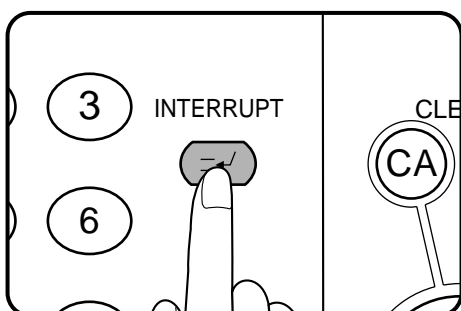

5 When the interrupt copy run is complete, press the INTERRUPT () key again to cancel the mode and remove the original(s) used for interrupt copying.

- The copier will reset itself to the functions which were in use before the INTERRUPT () key was first pressed.

6 Replace the original(s) for the interrupted job and press the START () key to resume copying.

- If scanning of originals has been already complete, the original need not be replaced.

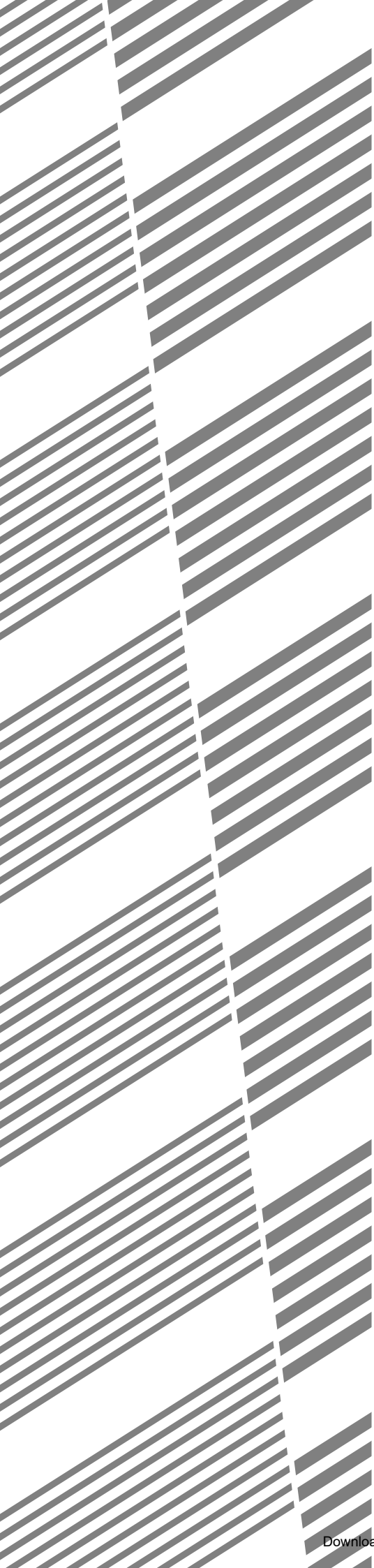

CHAPTER 3

SPECIAL FUNCTIONS

This chapter describes the special copying functions including various image editing functions which have been made possible by digital image processing technology.

	Page
• XY ZOOM	3-2
• MARGIN SHIFT	3-4
• ERASE	3-6
• DUAL PAGE COPYING	3-8
• MULTI SHOT	3-10
• COVERS	3-13
• TRANSPARENCY FILM WITH INSERT SHEETS	3-15
• PAMPHLET COPY	3-17
• IMAGE EDITING FUNCTIONS	3-20
Job build	3-20
Centring	3-22
Repeat copy	3-24
B/W reverse*	3-27
Binding change	3-29
• TEXT STAMP	3-32
Date	3-32
Select stamp	3-35
Watermark	3-38
Page number	3-41
• TANDEM COPY	3-44
• SETTING REVIEW	3-46

* In some regions, the B/W reverse feature is not provided.

XY ZOOM

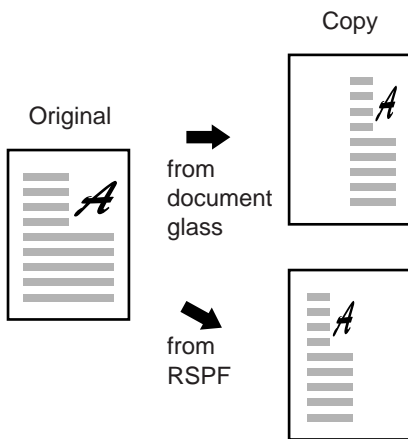

The XY ZOOM feature allows the horizontal and vertical copy ratios to be changed independently. If this feature is selected, the copy ratios can be set from 25% to 400%.

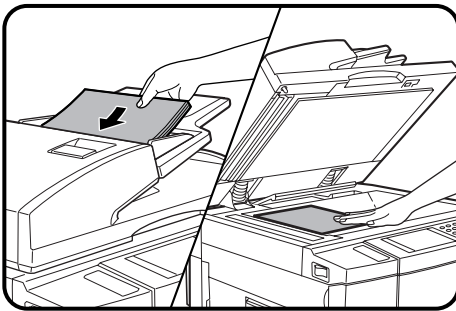

- 1 Place the original in the document feeder tray or on the document glass.

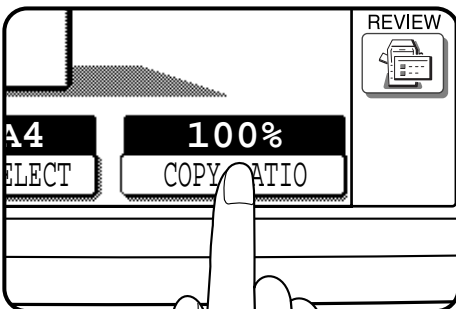

- 2 Press the "COPY RATIO" key on the touch panel.

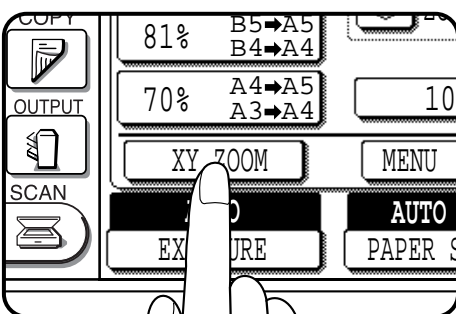

- 3 Press the "XY ZOOM" key.
 - The following screen will appear.

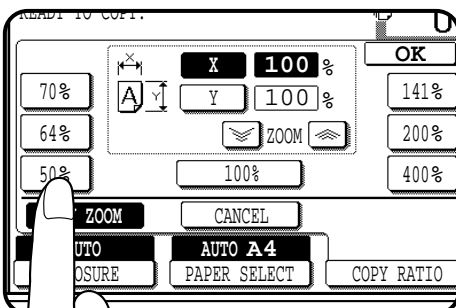
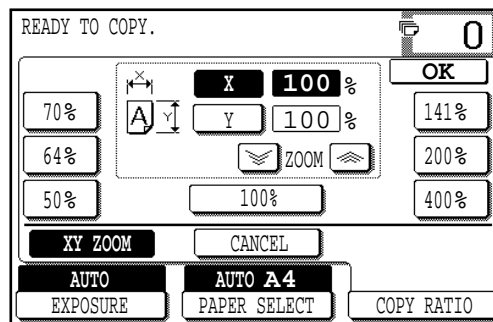

- 4 Use the reduction, enlargement, and ZOOM (⏏, ⏏) keys to change the copy ratio in the horizontal (X) direction.
 - Press a reduction key or an enlargement key to set the approximate ratio, then press the ⏏ key to decrease the ratio or ⏏ key to increase the ratio.

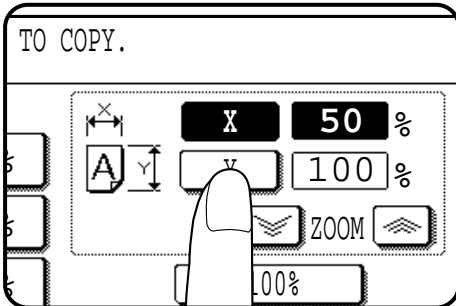

5 Press the **Y** key.

- The copy ratio in the vertical (Y) direction will be highlighted.

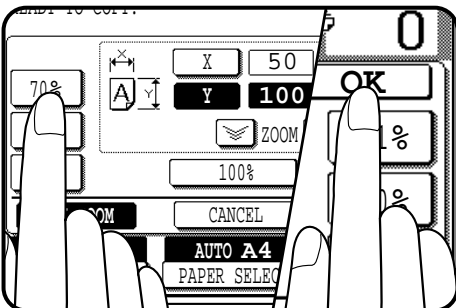

6 Use the reduction, enlargement, and ZOOM ([ZOOM]) keys to change the copy ratio in the vertical (Y) direction.

- To change the copy ratio in the horizontal direction again, press the **X** key.
- The message “IMAGE IS LARGER THAN THE COPY PAPER.” may appear, indicating that the selected copy ratio is too large for the copy paper size. However, if you press the START ([START]) key, a copy will be made.

7 Press the “OK” key.

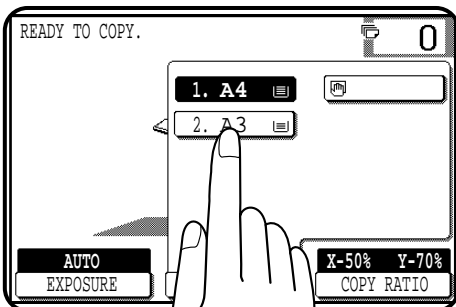

8 Press the “PAPER SELECT” key and select the paper tray with the desired paper size.

- If the AUTO PAPER SELECT mode is on, the appropriate copy paper size will have been automatically selected based on the original size and selected copy ratios.

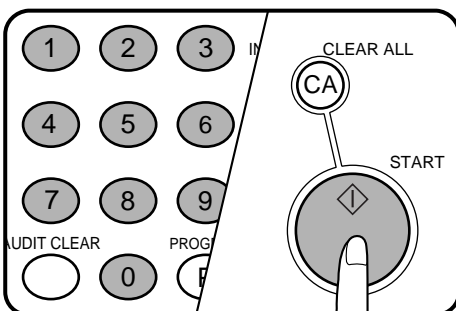

9 Enter the desired number of copies.

10 Press the START ([START]) key.

- If the document feeder is used, scanning of originals and copying will start.
- If the document glass is used in the SORT mode, proceed to the next step.

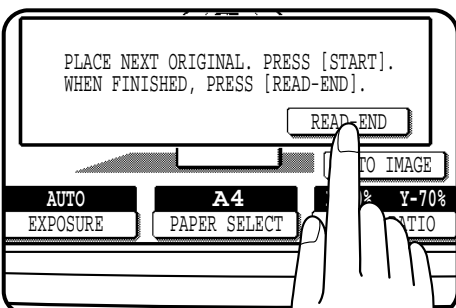

11 Replace the finished original with the next original after the START ([START]) key indicator lights up, and then press the START ([START]) key. Repeat this step until all originals have been scanned. Then, press the “READ-END” key on the touch panel.

- Copying will start at this time.
- Up to 120 sheets of A4 (8-1/2" x 11") originals or up to 60 sheets of originals larger than A4 (8-1/2" x 11") can be scanned.
- To cancel this function, press the “CANCEL” key or the “XY ZOOM” key again as in step 3.

MARGIN SHIFT

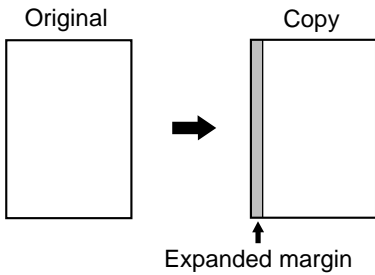

(Initial setting:
copy image shifted to the right)

The MARGIN SHIFT feature, in its initial setting, automatically shifts the text or image to the right both on one-sided copies and on the front side of two-sided copies. The text or image is shifted to the left on the reverse side of two-sided copies. Shift direction can be changed to left, right, up or down as described in step 4 below.

- The standard shift amount is 10mm (1/2"), but can be changed from 0mm to 20 mm in 1mm increments (from 0" to 1" in 1/8" increments).
- When copying originals from the RSPF onto extra size copy paper, the expanded margin might not be properly made.

★ **KEY OPERATOR** The initial shift setting can be changed from 0mm to 20 mm in 1mm increments (from 0" to 1" in 1/8" increments). See page 8-18.

NOTE:

The front side and reverse side are referred to as "SIDE 1" and "SIDE 2" respectively on the touch panel.

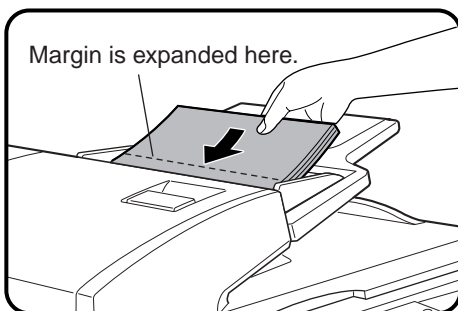

1 Place the original in the document feeder tray or on the document glass.

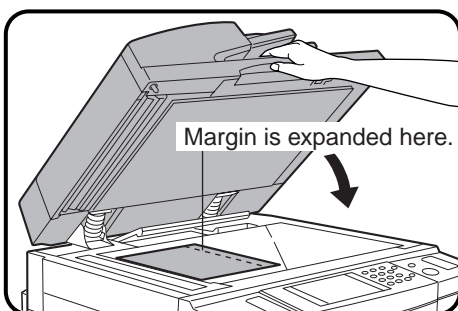

2 Press the SPECIAL MODES key.

- The SPECIAL MODES screen will appear.

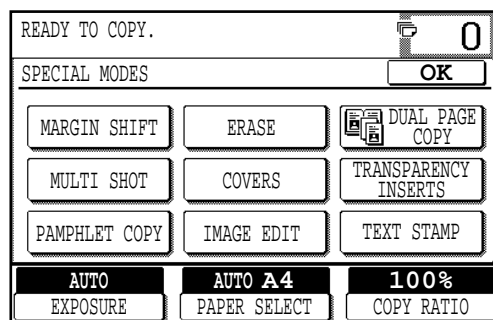
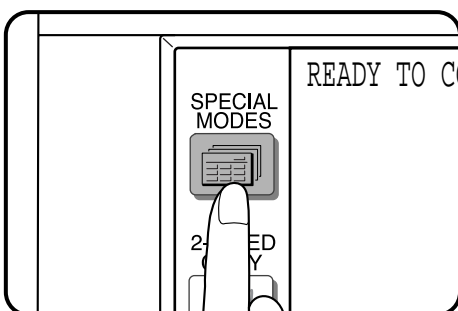

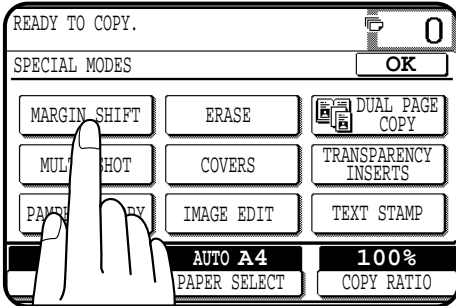

- 3** Press the “MARGIN SHIFT” key on the touch panel.
- The setting screen for MARGIN SHIFT will appear.

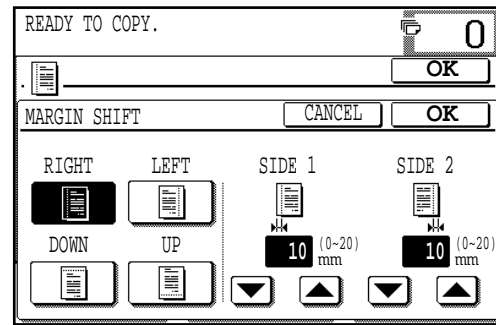

- 4** Select the shift direction.
- Select “RIGHT”, “LEFT”, “DOWN” or “UP” on the touch panel. The selected shift direction will be highlighted.

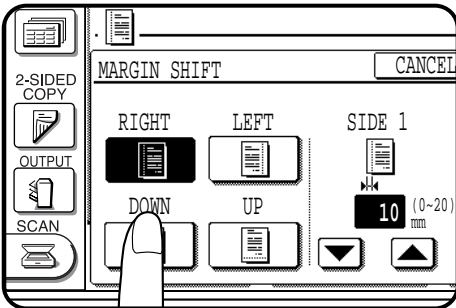

- 5** Select the desired shift amounts using the ▼ and ▲ keys.

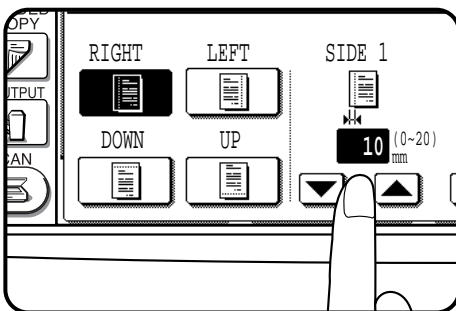

- 6** Press the upper “OK” key on the touch panel.

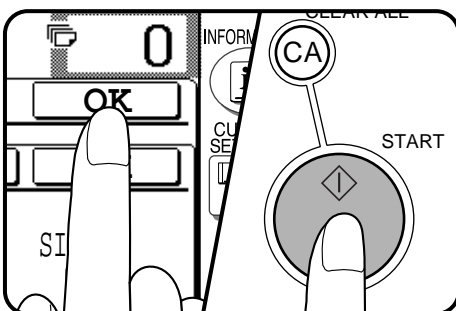

- 7** Make all other desired copier selections and press the START (◊) key.

- If the document feeder is used, scanning of originals and copying will start.
- If the document glass is used in the SORT mode, proceed to the next step.

- 8** Replace the finished original with the next original after the START (◊) key indicator lights up, and then press the START (◊) key. Repeat this step until all originals have been scanned. Then, press the “READ-END” key on the touch panel.

- Copying will start at this time.
- Up to 120 sheets of A4 (8-1/2" x 11") originals or up to 60 sheets of originals larger than A4 (8-1/2" x 11") can be scanned.
- To cancel the MARGIN SHIFT function, select the MARGIN SHIFT function again and press the “CANCEL” key.

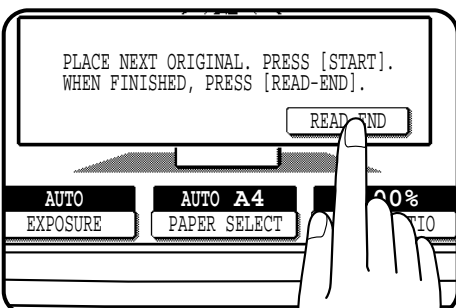

ERASE

Edge erase

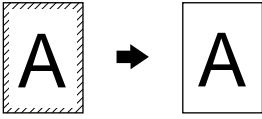

Centre erase

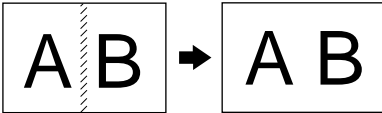

Edge + centre erase

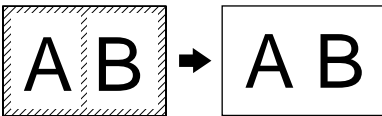

This copier has an edge erase mode and a centre erase mode.

- Edge erase can be used to eliminate shadow lines around the edges of copies caused when thick paper or a book is used as an original.
- Centre erase can be used to eliminate the shadow produced by the bindings of bound documents.
- Edge + centre erase can be used to eliminate shadow lines around the edges of copies and to eliminate the shadow at the centre of copies.
- The standard erase width is 10mm (1/2"), but can be changed from 0mm to 20 mm in 1mm increments (from 0" to 1" in 1/8" increments).

★ **KEY OPERATOR** The initial setting of the width for edge erase and centre erase can be changed. See page 8-18.

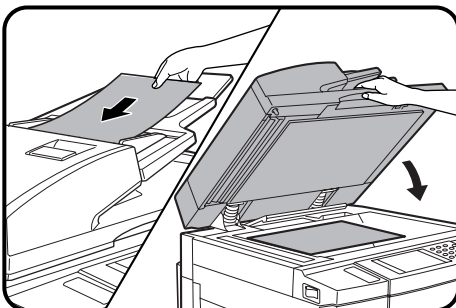

1 Place the original in the document feeder tray or on the document glass.

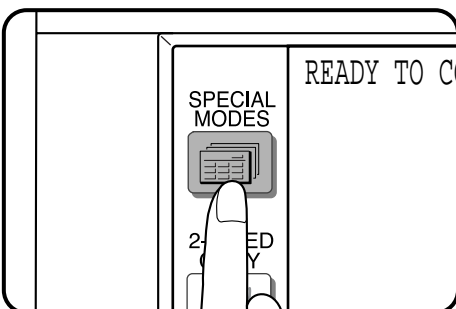

2 Press the **SPECIAL MODES** key.

- The **SPECIAL MODES** screen will appear.

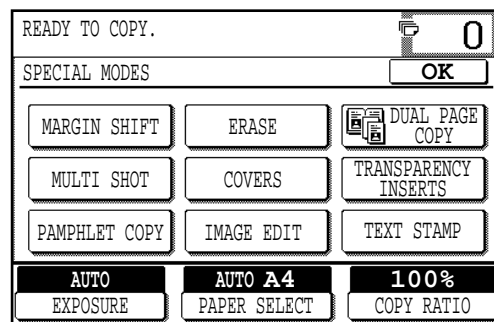

3 Press the **"ERASE"** key on the touch panel.

- The setting screen for **ERASE** will appear.

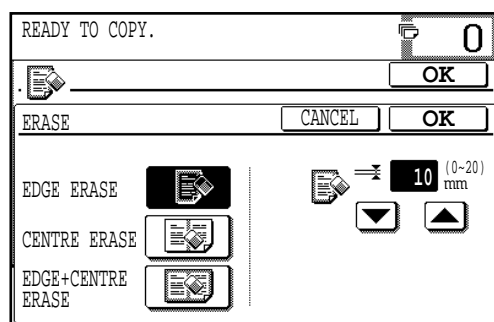
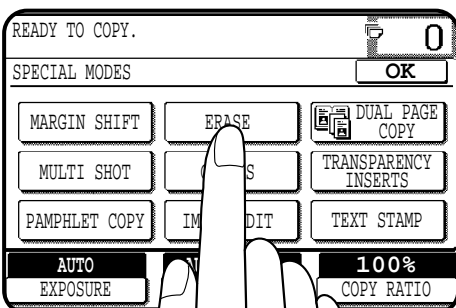

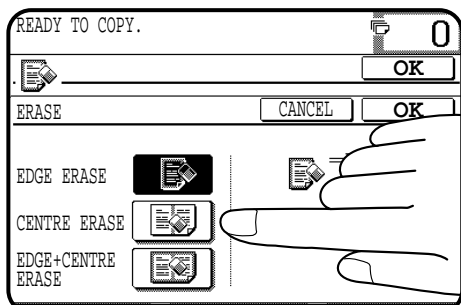

4 Select the desired erase mode.

- Select “EDGE ERASE”, “CENTRE ERASE” or “EDGE+CENTRE ERASE” on the touch panel. The selected erase mode will be highlighted.

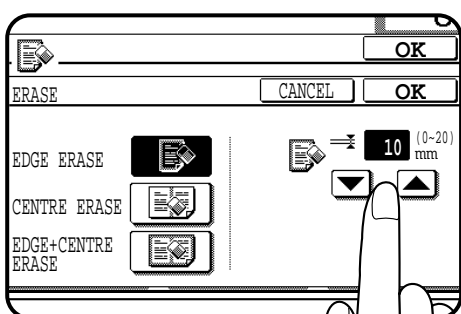

5 Adjust the amount of edge erase and/or centre erase if needed.

- The amount can be adjusted between 0mm and 20mm in 1mm increments (0" and 1" in 1/8" increments).

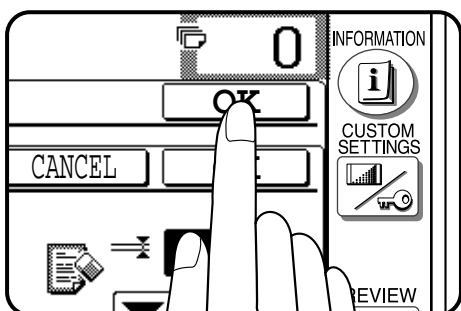

6 Press the upper “OK” key on the touch panel.

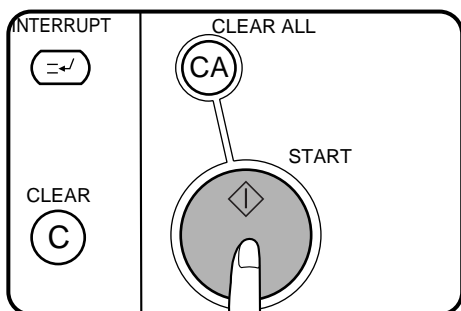

7 Make all other desired copier selections and press the START (◊) key.

- If the document feeder is used, scanning of originals and copying will start.
- If the document glass is used in the SORT mode, proceed to the next step.

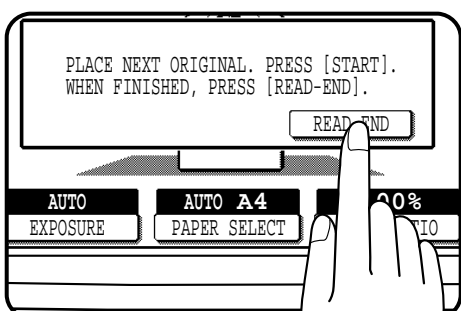

8 Replace the finished original with the next original after the START (◊) key indicator lights up, and then press the START (◊) key. Repeat this step until all originals have been scanned. Then, press the “READ-END” key on the touch panel.

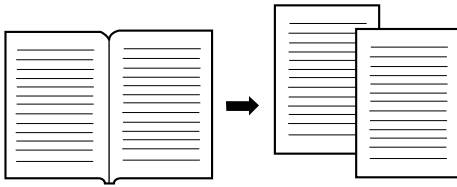

- Copying will start at this time.
- Up to 120 sheets of A4 (8-1/2" x 11") originals or up to 60 sheets of originals larger than A4 (8-1/2" x 11") can be scanned.
- To cancel the ERASE function, select the ERASE function again and press the “CANCEL” key.

DUAL PAGE COPYING

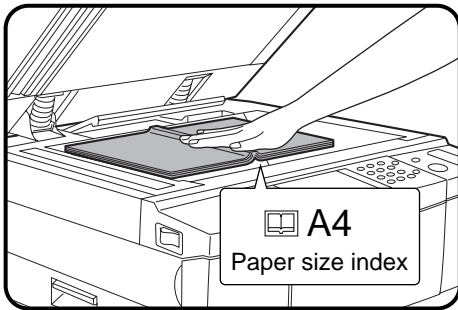

The DUAL PAGE COPY feature produces separate copies of two documents placed side by side on the document glass. It is especially useful when copying books and other bound documents. This feature can be used in the one-sided to two-sided copying mode.



- 1 Place the originals on the document glass with the centre of the two pages aligned with the paper size index  A4 ( 8 1/2). Close the document feeder cover.**
 - Set the first page on the right part of the document glass.

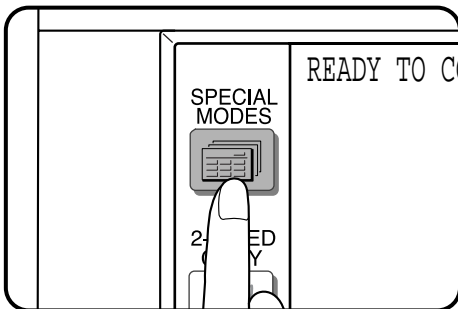

- 2 Press the SPECIAL MODES key.**
 - The SPECIAL MODES screen will appear.

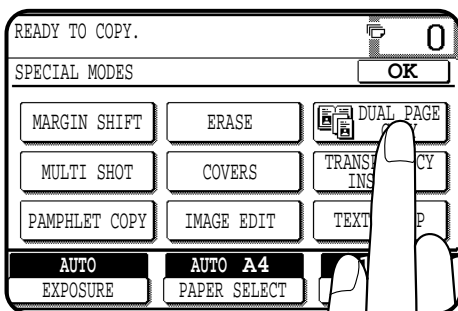

- 3 Press the "DUAL PAGE COPY" key on the touch panel.**
 - The "DUAL PAGE COPY" key will be highlighted.
 - A4 (8-1/2" x 11") sized copy paper will be automatically selected. If A4 (8-1/2" x 11") copy paper is not loaded, copying can be performed with the currently selected tray.
 - To leave a binding margin on the copy, select the MARGIN SHIFT function. See page 3-4. The MARGIN SHIFT feature applies only to the left page on the document glass if "RIGHT" or "LEFT" of MARGIN SHIFT has been selected.
 - To erase shadows caused by document binding, use the EDGE ERASE feature. See page 3-6.
 - The CENTRE ERASE feature is not available with the DUAL PAGE COPY feature.

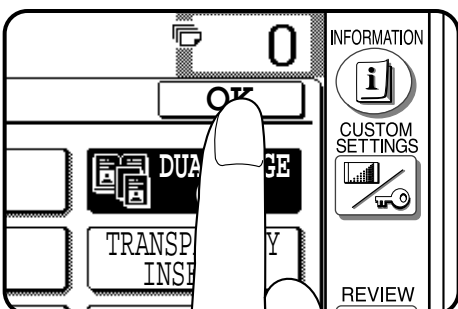

- 4 Press the "OK" key.**

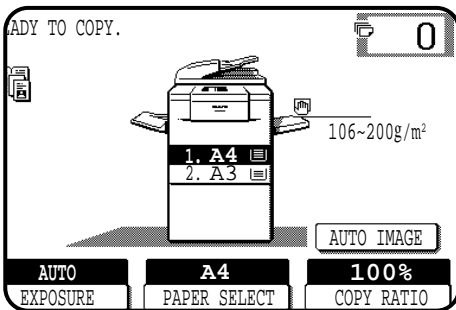

5 Ensure that the desired tray is selected.

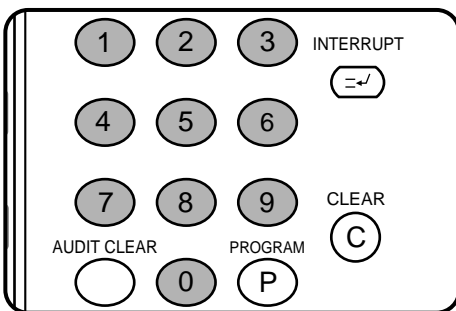

6 Enter the desired number of copies.

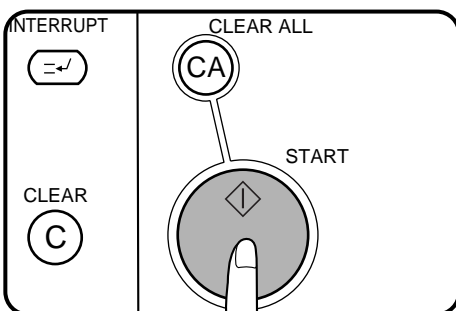

7 Press the **START** (◊) key.

- If the SORT mode has been selected for copying multiple originals, proceed to the next step. If not, copying will start.

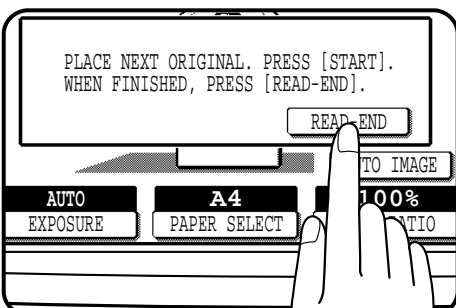

8 Replace the finished original with the next original after the **START** (◊) key indicator lights up, and then press the **START** (◊) key. Repeat this step until all originals have been scanned. Then, press the “READ-END” key on the touch panel.

- Copying will start at this time.
- Up to 120 sheets of A4 (8-1/2" x 11") originals or up to 60 sheets of A3 (11" x 17") originals can be scanned.
- To cancel the DUAL PAGE COPY function, press the “DUAL PAGE COPY” key again on the SPECIAL MODES screen.

MULTI SHOT

The MULTI SHOT function is used to copy several originals, collectively in a specified order, onto one sheet.

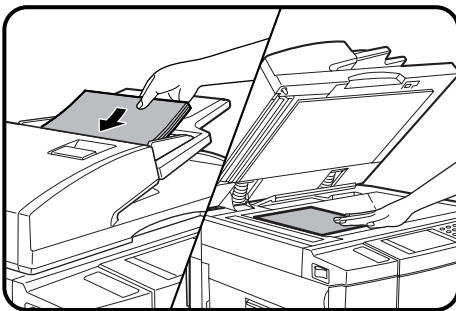
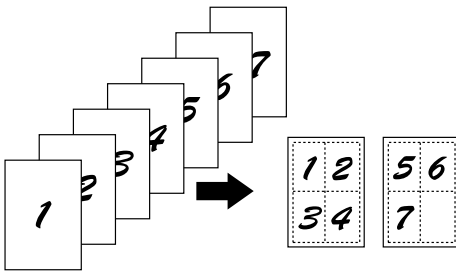

1 Place the originals in the document feeder tray or on the document glass.

- When using the document glass, place the originals one at a time starting with the first original.

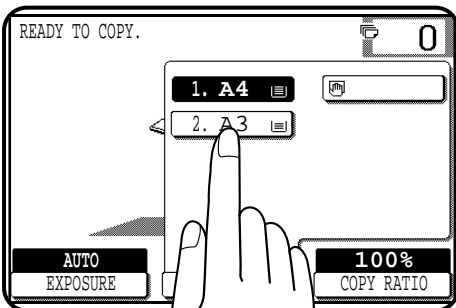

2 Press the "PAPER SELECT" key on the touch panel and select the desired paper size.

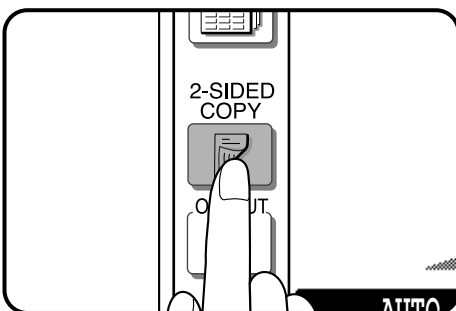

3 Press the 2-SIDED COPY key and select a duplex mode if desired. Press the "OK" key to close the duplex selection window.

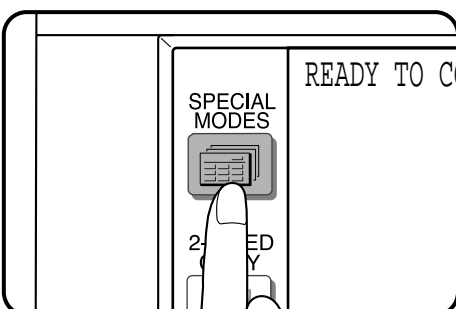

4 Press the SPECIAL MODES key.

- The SPECIAL MODES screen will appear.

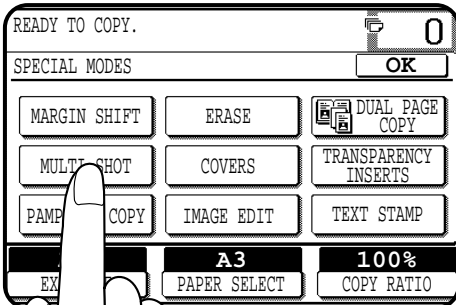

- 5** Press the “MULTI SHOT” key on the touch panel.
- The function setting screen for MULTI SHOT will appear.

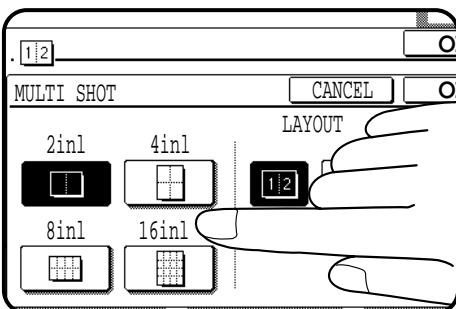
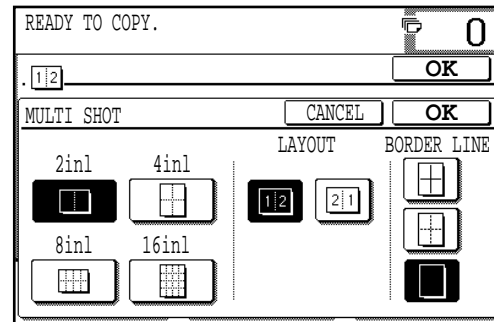

- 6** Select the number of originals to be included on one sheet of copies.

- Select “2in1”, “4in1”, “8in1” or “16in1” on the touch panel.
- The copy ratio will be calculated automatically.
- Portions of original images may not be copied depending on the original and copy paper sizes and the number of images to be copied onto a page.
- Depending on the number of originals and the orientation of the originals and copy paper, the image of the originals may be rotated.

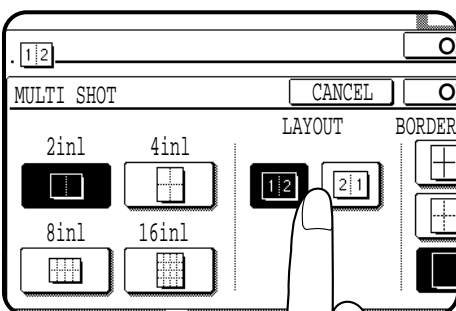

- 7** Select the layout of originals on the copy.

- Select the order of originals which will be arranged on the copy.
- For example, the following types are provided for “4in1”.

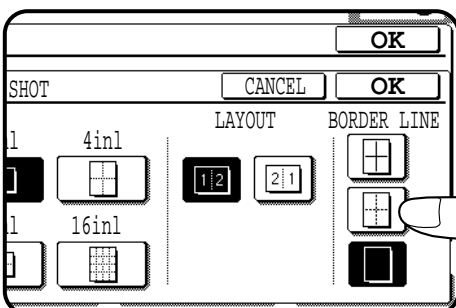
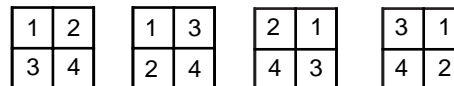

- 8** Select a type of border line.
- Select the solid line, broken line or no border line.

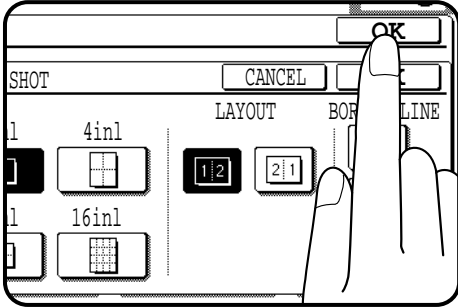

9 Press the upper “OK” key.

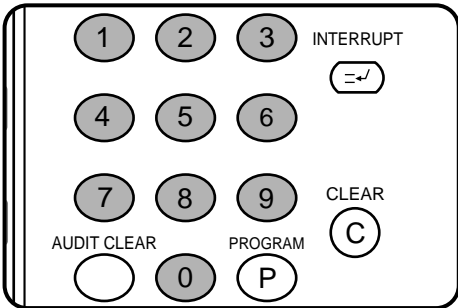

10 Enter the desired number of copies.

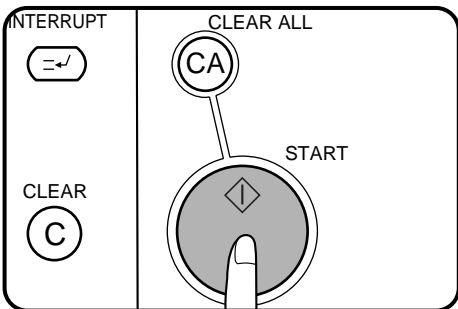

11 Press the **START** (◊) key.

- If the document feeder is used, copying will start after all originals are scanned.
- If the document glass is used, proceed to the next step.

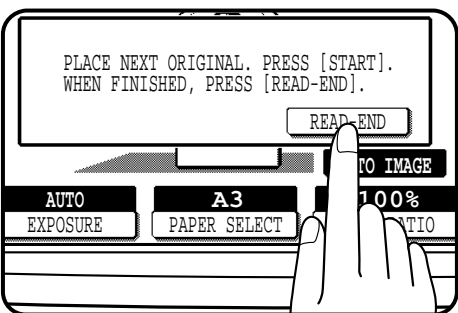

12 Replace the finished original with the next original after the **START** (◊) key indicator lights up, and then press the **START** (◊) key. Repeat this step until all originals have been scanned. Then, press the “READ-END” key on the touch panel.

- Copying will start at this time.
- Up to 120 sheets of A4 (8-1/2" x 11") originals or up to 60 sheets of originals larger than A4 (8-1/2" x 11") can be scanned.
- To cancel the MULTI SHOT function, select the MULTI SHOT function again and press the “CANCEL” key.

COVERS

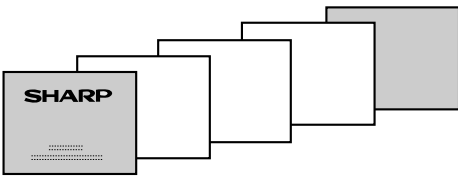

The COVERS mode is used to place covers on the front, back, or both the front and back of multipage documents.

- Front cover sheets can be copied on, but only on the front side even in the 1-sided to 2-sided and 2-sided to 2-sided copy modes. The back side of the original designated as the cover will not be copied.
- Back cover sheets cannot be copied on, either on the front side or on the back side.
- Cover sheets must be fed from the bypass tray and must be the same size as the copy paper being used to copy the document.
- When the COVERS mode is selected, the stream feeding mode of the RSPF will always be off.

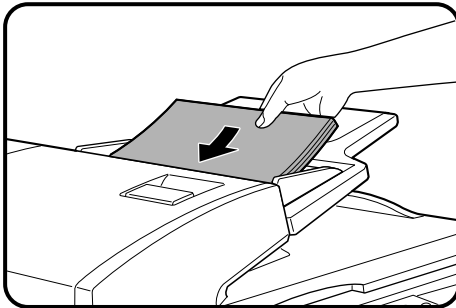

1 Place the originals in the document feeder tray.

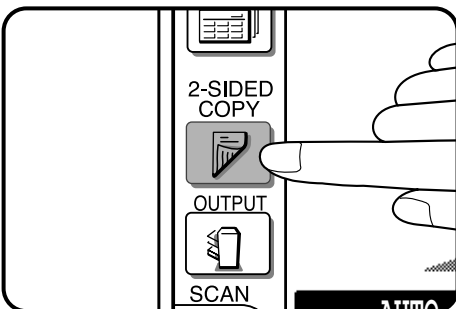

2 Press the 2-SIDED COPY key and select the desired duplex mode if needed. Press the "OK" key to close the duplex selection window.

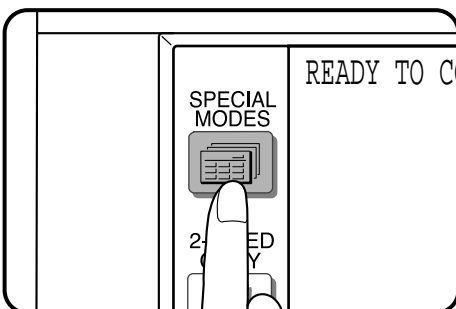

3 Press the SPECIAL MODES key.

- The SPECIAL MODES screen will appear.

4 Press the "COVERS" key on the touch panel.

- The setting screen for COVERS will appear.

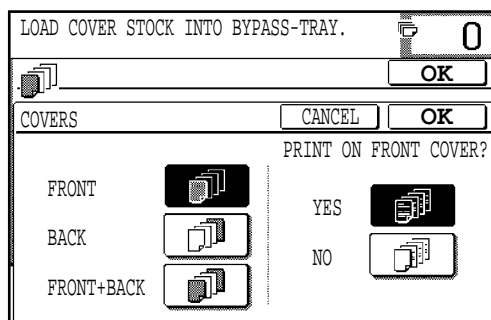
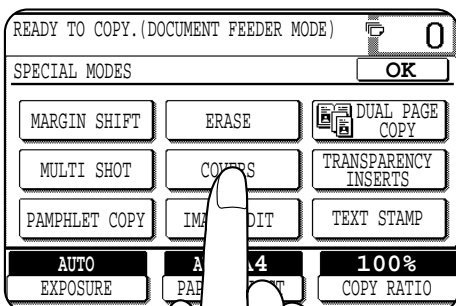

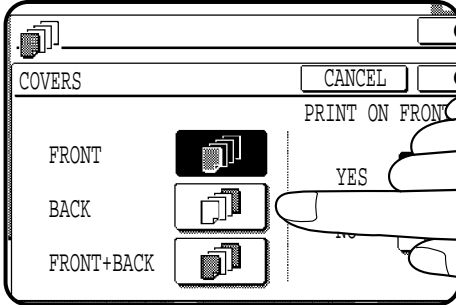

5 Select cover placement.

- Select "FRONT", "BACK" or "FRONT+BACK" on the touch panel.

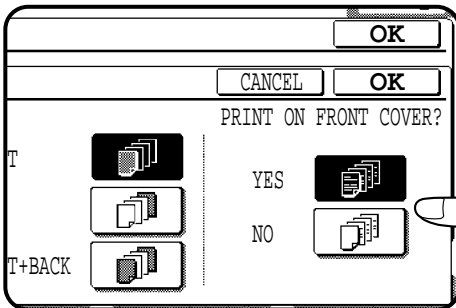

6 Indicate whether the front cover sheets are to be copied on or not.

- Select "YES" or "NO" on the touch panel. If "YES" is selected, the first page of the document will be copied onto the front cover sheet.
- If "BACK" has been selected in step 5, this selection is not needed.

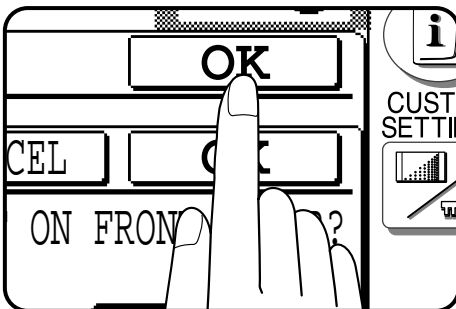

7 Press the upper "OK" key.

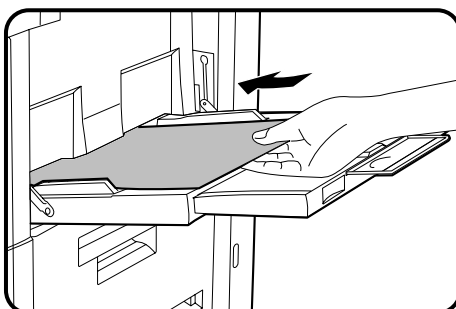

8 Load the cover stock into the bypass tray, making sure that the cover stock is the same size as the copy paper.

- The START (◊) key indicator will light up.

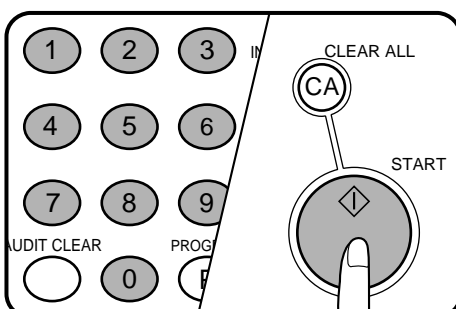

9 Enter the desired number of copies and press the START (◊) key.

- To cancel the COVERS function, select the COVERS function again and press the "CANCEL" key.

TRANSPARENCY FILM WITH INSERT SHEETS

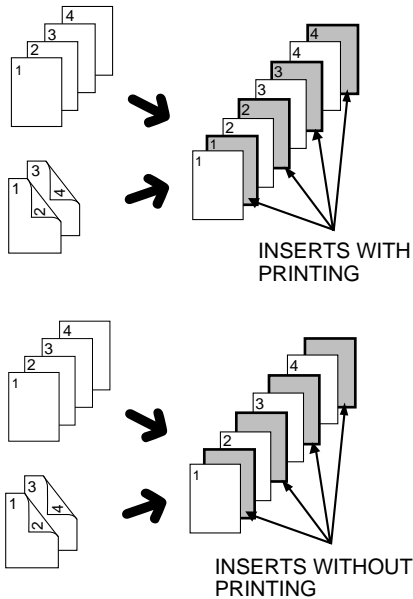

When copying onto transparency film, insert sheets can be placed following each transparent sheet. The insert sheets can be processed blank or can be copied with the same image as the transparent sheets.

- This mode can be selected only in the 1-sided to 1-sided and 2-sided to 1-sided modes.
- A multiple number of copies cannot be selected in this mode.
- Transparency film must be fed from the bypass tray.
- Insert sheets must be the same size as the transparency film.
- When this function is used, copies will be delivered face up. When copying multi-page documents from the document glass with this mode, copy from the last page to the first page.

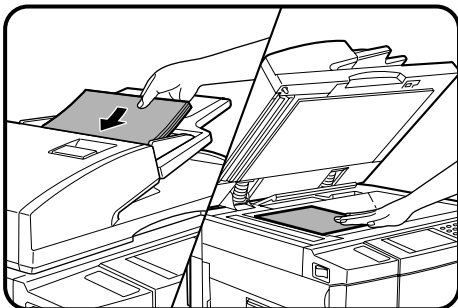

1 Place the originals in the document feeder tray or on the document glass.

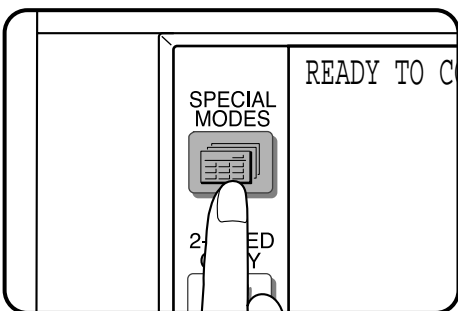

2 Press the **SPECIAL MODES** key.

- The SPECIAL MODES screen will appear.

3 Press the **“TRANSPARENCY INSERTS”** key on the touch panel.

- The setting screen for TRANSPARENCY INSERTS will appear.

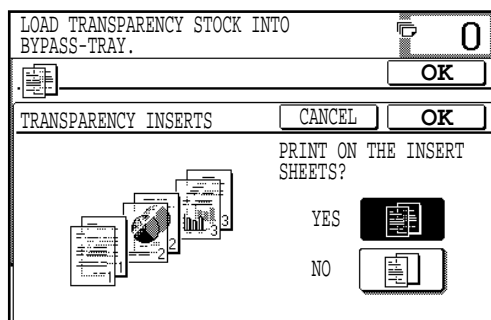
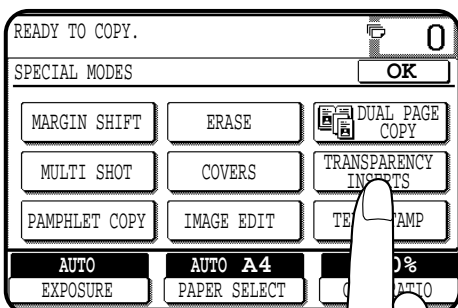

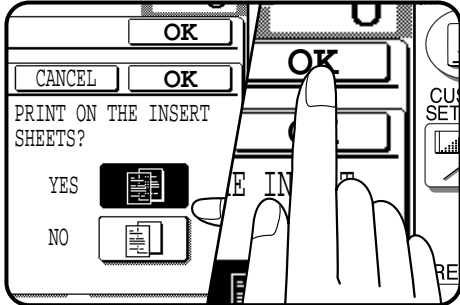

4 Indicate whether the insert sheets are to be copied on or not.

- Select “YES” or “NO” on the touch panel.

5 Press the upper “OK” key.

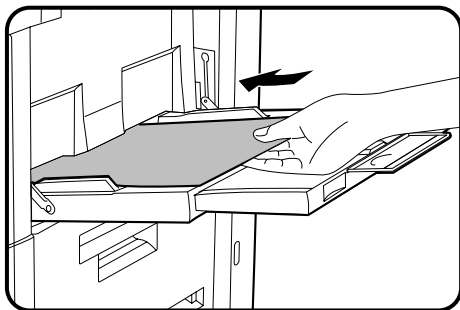

6 Load transparency film into the bypass tray.

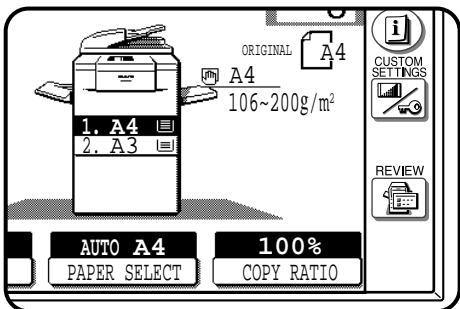

7 Ensure that the desired tray is selected for insert sheets.

- The copy paper for insert sheets must be the same size as the transparency film.

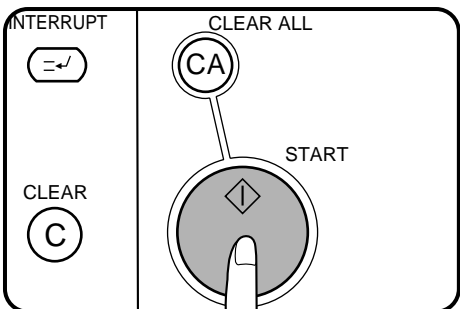

8 Make all other selections and press the **START** (◊) key.

- If the document feeder is used, scanning of originals and copying will start.
- If the document glass is used in the SORT mode, proceed to the next step.

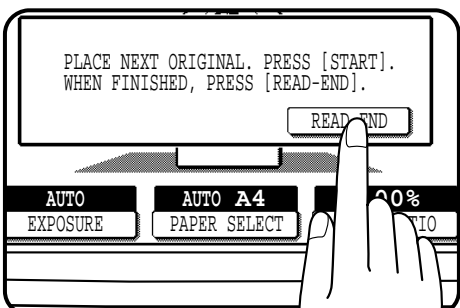

9 Replace the finished original with the next original after the **START** (◊) key indicator lights up, and then press the **START** (◊) key. Repeat this step until all originals have been scanned. Then, press the “READ-END” key on the touch panel.

- Copying will start at this time.
- Up to 120 sheets of A4 (8-1/2" x 11") originals or up to 60 sheets of originals larger than A4 (8-1/2" x 11") can be scanned.
- When copying is completed, remove remaining transparency film.
- To cancel the TRANSPARENCY INSERTS function, select the TRANSPARENCY INSERTS function again and press the “CANCEL” key.

PAMPHLET COPY

Originals
(1-sided)

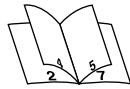
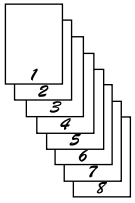

Originals
(2-sided)

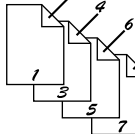

The PAMPHLET COPY function is used to arrange copies in proper order for eventual centre-stapling and folding into a booklet. Four pages will be copied onto one sheet.

- Centre stapling cannot be performed by this copier. Even if PAMPHLET COPY is selected and an optional finisher (AR-FN3) is installed, centre-stapling cannot be performed.
- This function will not work when non-standard size originals or copy paper are used.

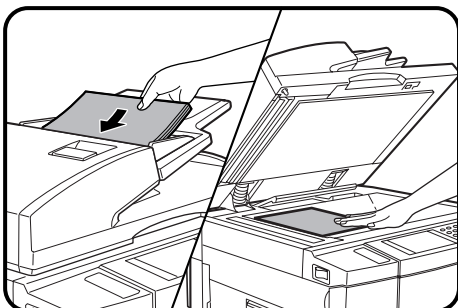

1 Place the originals in the document feeder tray or on the document glass.

- When using the document glass, place the originals one at a time starting with the first original .

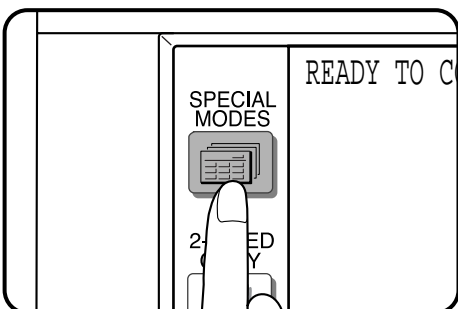

2 Press the SPECIAL MODES key.

- The SPECIAL MODES screen will appear.

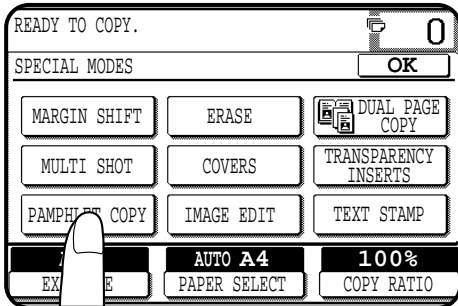

- 3** Press the “PAMPHLET COPY” key on the touch panel.
- The setting screen for PAMPHLET COPY will appear.
 - Depending on the setting of the tandem copying, the “PAMPHLET COPY” function may be included in the “IMAGE EDIT” menu. In this case, press the “IMAGE EDIT” key and then press the “PAMPHLET COPY” key.

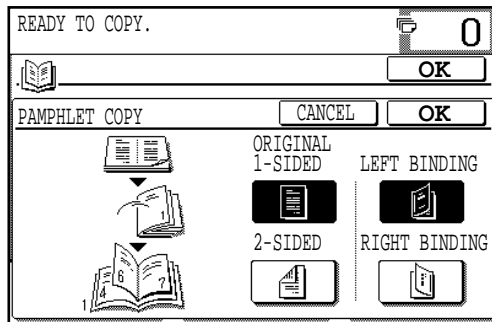

- 4** Select the type of originals.
- Indicate whether the originals are 1-sided or 2-sided using the “1-SIDED” or “2-SIDED” key on the touch panel.

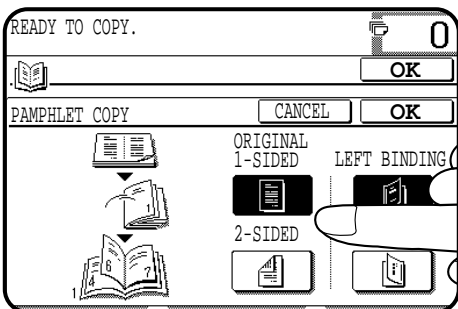

- 5** Select the binding position.
- Select “LEFT BINDING” or “RIGHT BINDING” on the touch panel.

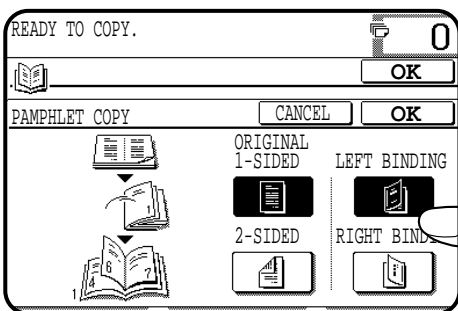

- 6** Press the upper “OK” key.

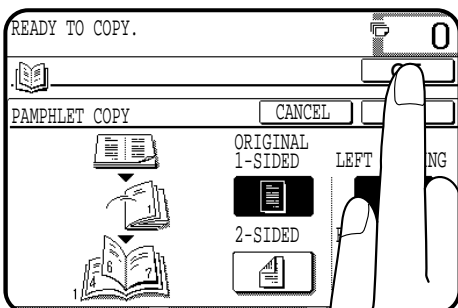

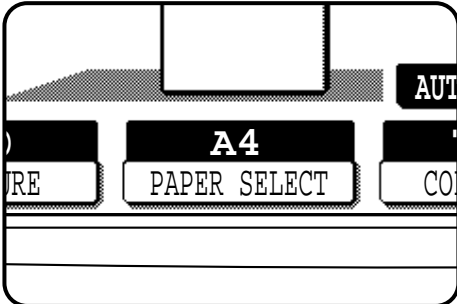

7 Check the copy paper selection.

- When the desired paper size is not selected, touch the desired paper tray on the touch panel then the AUTO IMAGE key. This lets the copier automatically set the best reduction or enlargement ratio and display it on the touch panel, judging from the placed original size and the desired paper size.
(See steps 2 and 3 of page 2-11.)

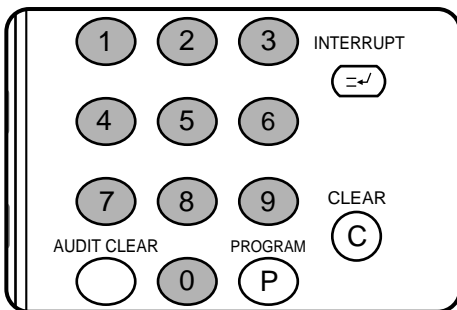

8 Enter the desired number of copies.

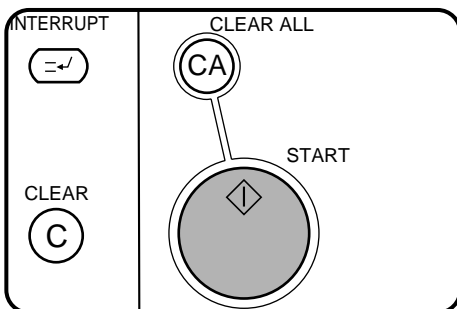

9 Press the START (◊) key.

- If the document feeder is used, copying will start after all originals are scanned.
- If the document glass is used, proceed to the next step.

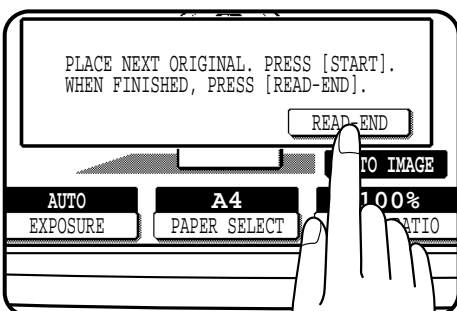

10 Replace the finished original with the next original after the START (◊) key indicator lights up, and then press the START (◊) key. Repeat this step until all originals have been scanned. Then, press the "READ-END" key on the touch panel.

- Copying will start at this time.
- Up to 120 sheets of A4 (8-1/2" x 11") originals or up to 60 sheets of originals larger than A4 (8-1/2" x 11") can be scanned.
- If originals of different sizes are used, the copy paper size will be determined based on the original that is scanned first. If originals larger than the first original are used, a portion of the images may not be copied.
- You can make a pamphlet by folding the copies in two and stapling them.
- To cancel the PAMPHLET COPY function, select the PAMPHLET COPY function again and press the "CANCEL" key.

IMAGE EDITING FUNCTIONS

The image editing functions include the following functions.

- Job build: Makes copies from a large volume of originals (up to 120 pages of A4 (8-1/2" x 11") paper size) using the document feeder.
- Centring: Shifts the image to the centre of copy paper when the original and the copy paper are of different sizes.
- Repeat copy: Produces repeated copies on a single sheet of copy paper.
- B/W reverse: Reverses the black and white areas. (In some regions, this function is not provided.)
- Binding change: Rotates the image of originals for the second side in the 1-sided to 2-sided copy mode.

These functions are selected by pressing the "IMAGE EDIT" key on the SPECIAL MODES screen and pressing the key of each function.

JOB BUILD

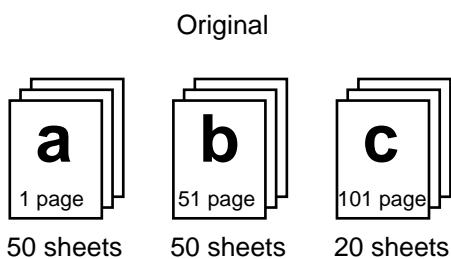

Divide the original containing more than 50 pages into some sections as shown above and feed them in the order of **a** → **b** → **c**. The original should be less than 120 pages in total. If the total page exceeds 120 (if the above section "c" exceeds 20 pages), the pages in excess of the limit will be output to the exit area without being copied.

The JOB BUILD function allows copying of multipage documents containing up to 120 pages (the limit, however, might be up to 60 pages of B4 or A3 (8-1/2" x 14" or 11" x 17") paper size when the copier is equipped with some option) using the RSPF. The original must be divided into sections of up to 50 pages per section. Each section can be fed separately through the RSPF for eventual copying into a complete set(s).

- Once a copy job is set in this mode, the copy mode can not be changed between the simplex and duplex modes except for INTERRUPT copying.
- When the JOB BUILD function is selected, the below mentioned functions can not be selected simultaneously. GROUP MODE/TRANSPARENCY INSERTS/DUAL PAGE COPY/REPEAT COPY.
- The JOB BUILD mode has priority over the stream feeding mode. Stream feeding will not operate while the JOB BUILD mode is selected.

The illustration shows an example when copying 120 pages of original.

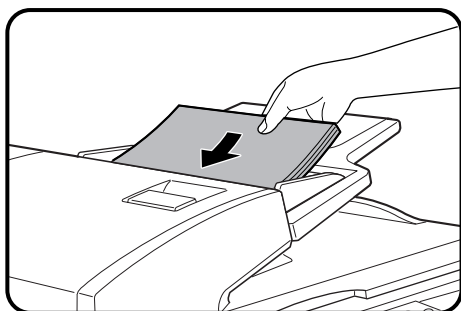

- 1** Divide the multipage document (maximum 120 pages) into sections of 50 pages or less and place the section containing the first page of the document into the document feeder tray.

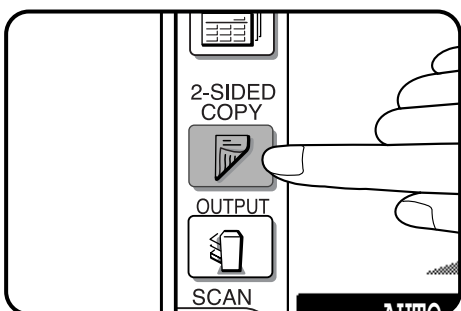

- 2** If a duplex copy mode is required, it must be selected at this time by pressing the 2-SIDED COPY key.

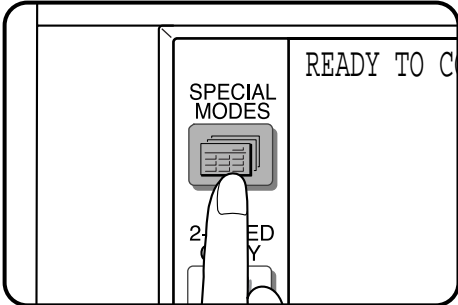

- 3** Press the **SPECIAL MODES** key.
- The SPECIAL MODES screen will appear.

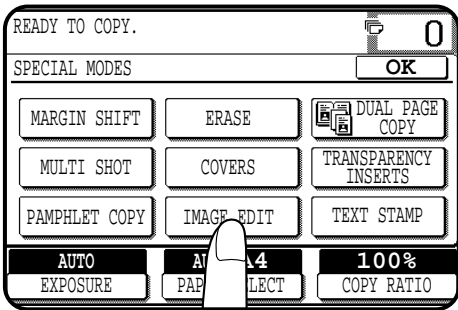

- 4** Press the **“IMAGE EDIT”** key.
- The IMAGE EDIT menu will appear.

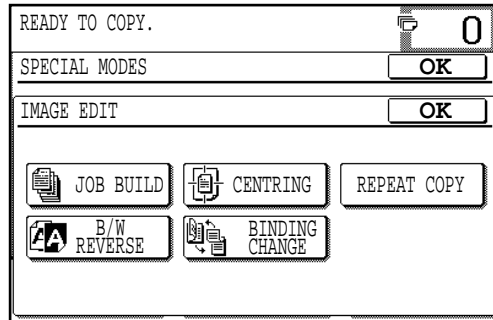

- 5** Press the **“JOB BUILD”** key.
- The **“JOB BUILD”** key will be highlighted.

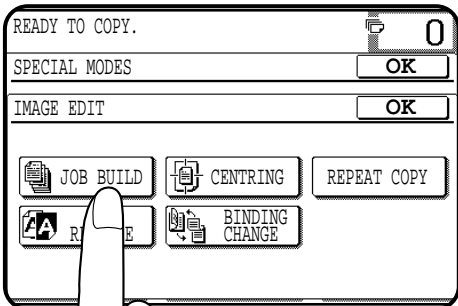

- 6** Press the upper **“OK”** key.

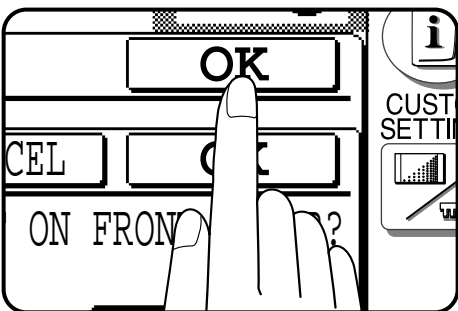

- 7** Make all other desired copy mode selections and enter the desired number of copies.

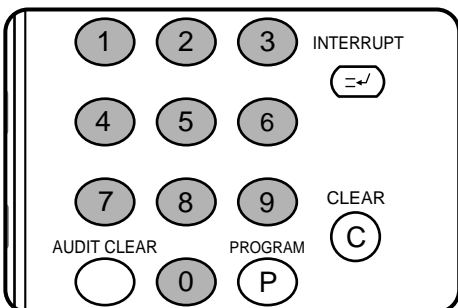

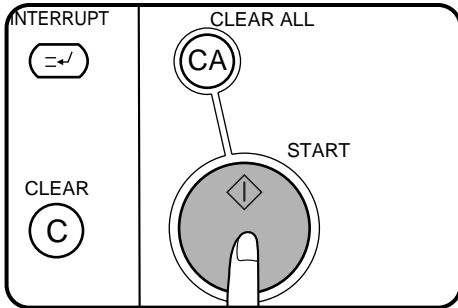

- 8** Press the **START** (◊) key.
- Scanning of the first section will start.

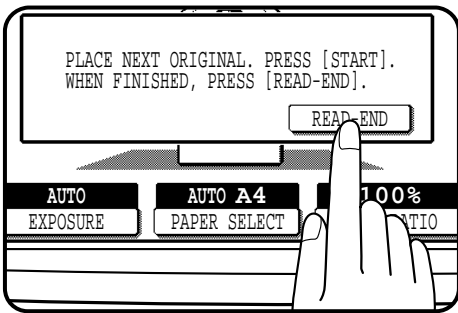

- 9** After the first section of original pages has been fed and the **START** lights up, remove the scanned originals from the exit area, set the next section of original pages into the document feeder tray and press the **START** (◊) key. Repeat this sequence until all sections have been fed. Then press the “**READ-END**” key on the touch panel.
- Copying will start at this time.

CENTRING

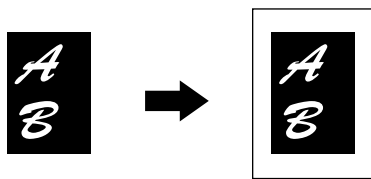

When the original and copy paper are of different sizes, **CENTRING** is used to shift the image as a whole to the centre of the copy paper. The image will shift only in the left to right direction, not in the top to bottom direction.

- This function will not work when non-standard size originals or copy paper are used. This function cannot be selected when enlargement copying has been selected.

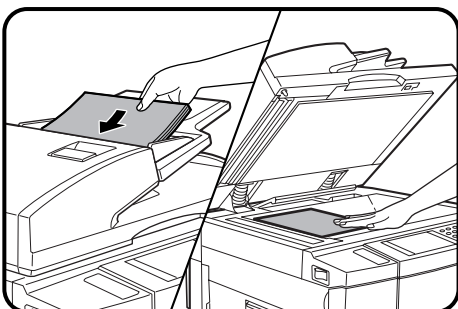

- 1** Place the originals in the document feeder tray or on the document glass.

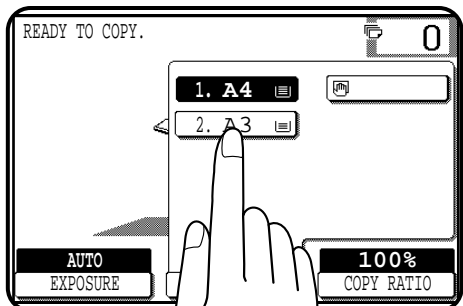

2 Press the “PAPER SELECT” key on the touch panel and select the desired paper size.

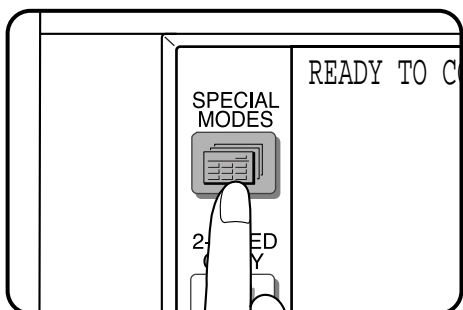

3 Press the SPECIAL MODES key.
 • The SPECIAL MODES screen will appear.

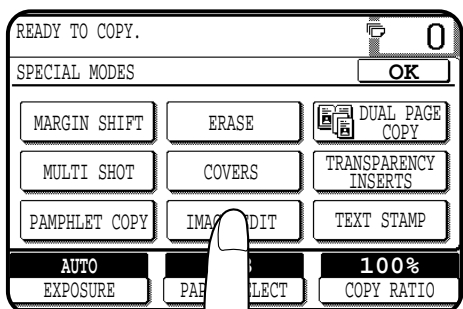

4 Press the “IMAGE EDIT” key on the touch panel.
 • The IMAGE EDIT menu will appear.

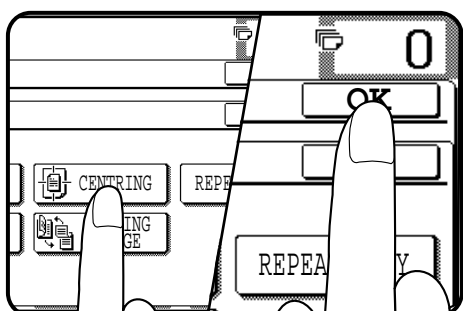

5 Press the “CENTRING” key.
 • The “CENTRING” key will be highlighted.

6 Press the upper “OK” key.

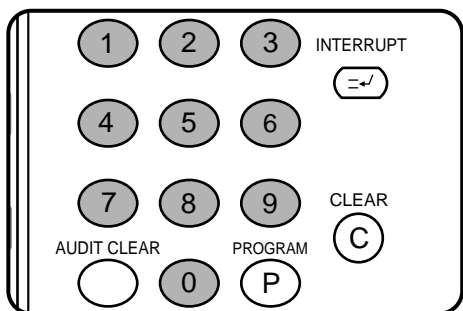

7 Make all other desired copier selections and enter the desired number of copies.

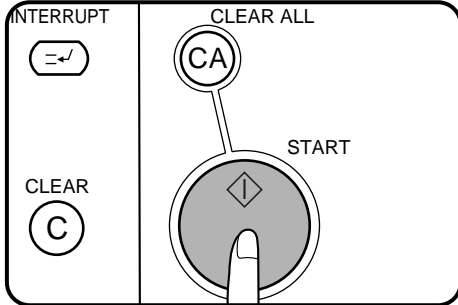

8 Press the START (◊) key.

- If the document feeder is used, scanning of originals and copying will start.
- If the document glass is used in the SORT mode, proceed to the next step.

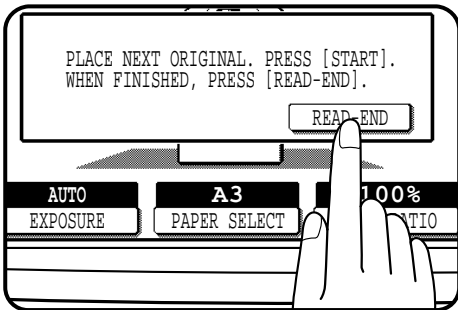

9 Replace the finished original with the next original after the START (◊) key indicator lights up, and then press the START (◊) key. Repeat this step until all originals have been scanned. Then, press the "READ-END" key on the touch panel.

- Copying will start at this time.
- Up to 120 sheets of A4 (8-1/2" x 11") originals or up to 60 sheets of originals larger than A4 (8-1/2" x 11") can be scanned.
- To cancel the CENTRING function, press the "CENTRING" key again on the IMAGE EDIT menu screen.

REPEAT COPY

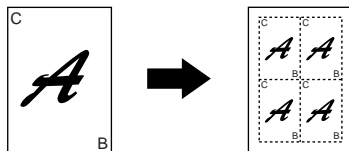

REPEAT COPY is used to produce repeated images of an original on a single sheet of paper. Border lines can be drawn to separate repeated images.

- Up to 16 (4 x 4) copies can be made on a single sheet.
- When a standard size original is copied onto a standard size paper, copy ratio will be automatically calculated based on the original size and the number of the images required in single sheet of paper. When the copier cannot detect the size of original, however, copy ratio will be automatically set to 100%.
- If the proper reduction ratio is calculated as less than 25%, part of the original will not be copied. In that case the reduction ratio will be set to 25% showing the following message on the display. "IMAGE DOES NOT FIT INTO THE IMAGE AREA. COPY RATIO WILL BE SET TO 25%."

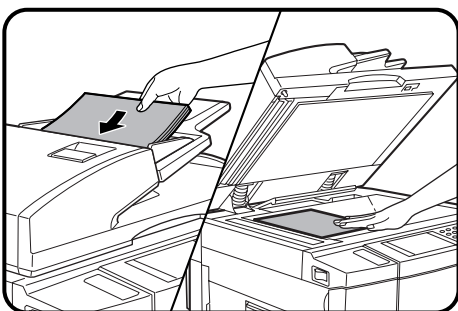

1 Place the originals in the document feeder tray or on the document glass.

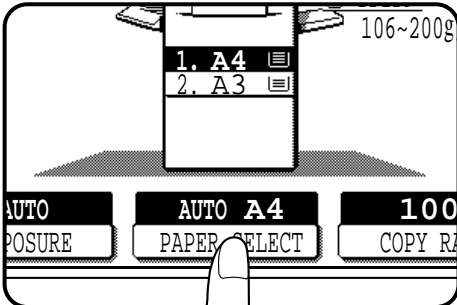

- 2** Select the desired copy paper size.
- Press the “PAPER SELECT” key on the touch panel and then select the desired paper size.

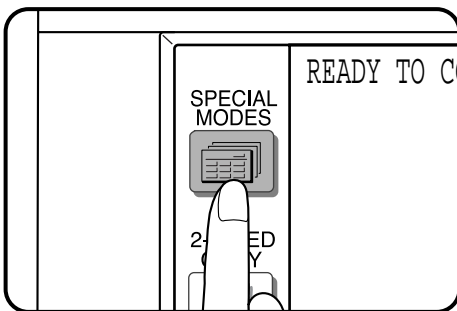

- 3** Press the SPECIAL MODES key.
- The SPECIAL MODES screen will appear.

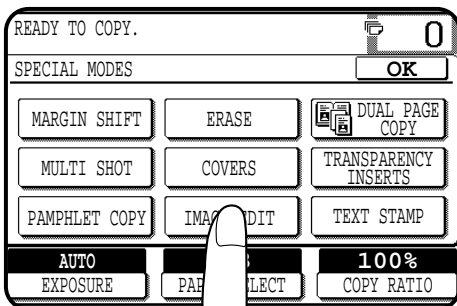

- 4** Press the “IMAGE EDIT” key on the touch panel.
- The IMAGE EDIT menu will appear.

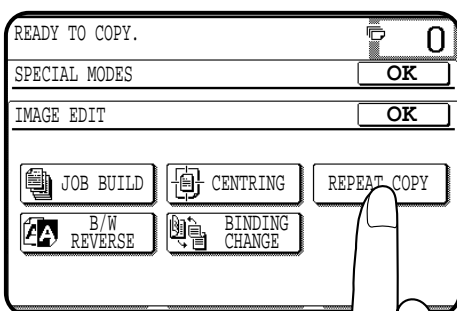

- 5** Press the “REPEAT COPY” key on the touch panel.
- The setting screen for REPEAT COPY will appear.

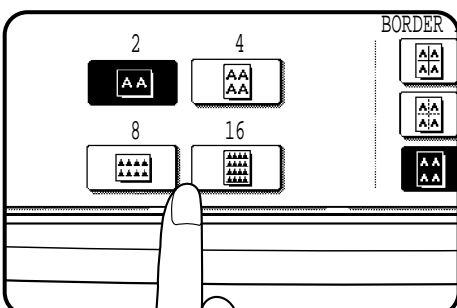
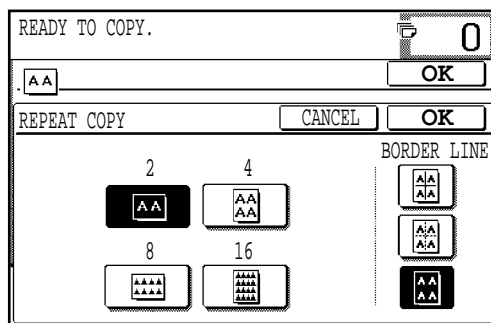

- 6** Select the number of images to be repeated on a single sheet of copy paper.
- Select “2”, “4”, “8” or “16” on the touch panel.

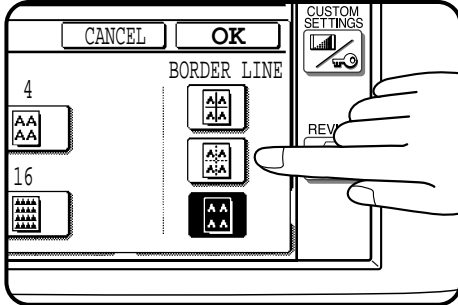

- 7** Select a type of border line.
- Select the solid line, broken line or no border line.

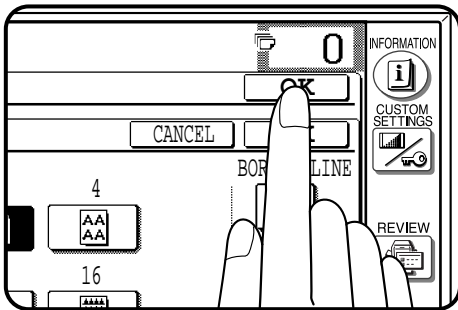

- 8** Press the upper “OK” key.

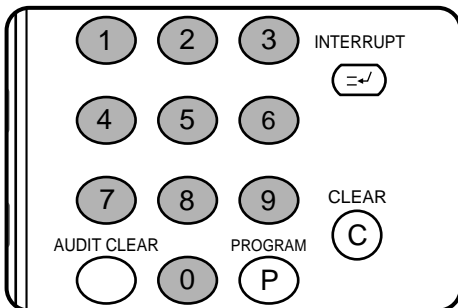

- 9** Make all other desired copier selections and enter the desired number of copies.
- If the required area of the originals is not included on the copies, select a proper reduction ratio.

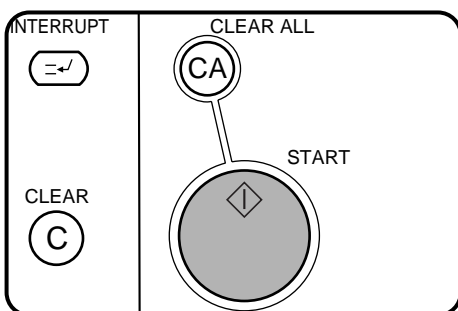

- 10** Press the **START** (◊) key.
- If the document feeder is used, scanning of originals and copying will start.
 - If the document glass is used in the SORT mode, proceed to the next step.

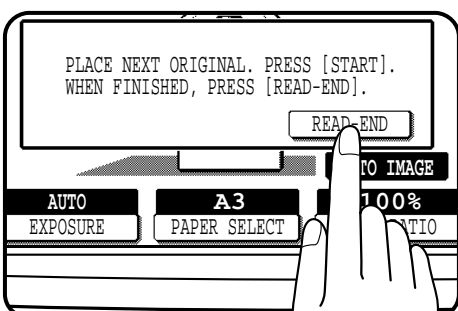

- 11** Replace the finished original with the next original after the **START** (◊) key indicator lights up, and then press the **START** (◊) key. Repeat this step until all originals have been scanned. Then, press the “READ-END” key on the touch panel.
- Copying will start at this time.
 - Up to 120 sheets of A4 (8-1/2" x 11") originals or up to 60 sheets of originals larger than A4 (8-1/2" x 11") can be scanned.
 - To cancel the REPEAT COPY function, select the REPEAT COPY function again and press the “CANCEL” key.

B/W REVERSE

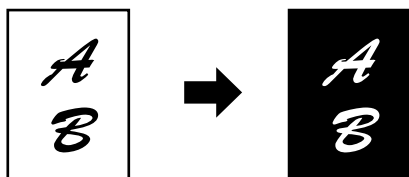

The B/W REVERSE feature is used to reverse black and white areas.

- When the B/W REVERSE feature is selected, the exposure mode will be automatically set to the TEXT mode. Other exposure modes cannot be selected. Even if this feature is cancelled, the TEXT mode will not automatically be cancelled.
- In some regions, the B/W REVERSE feature is not provided.

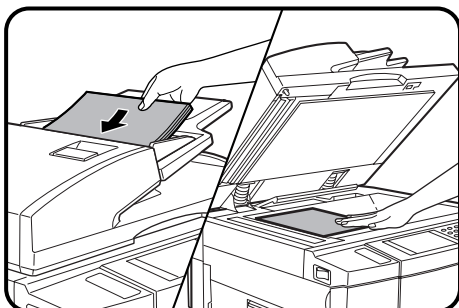

1 Place the original in the document feeder tray or on the document glass.

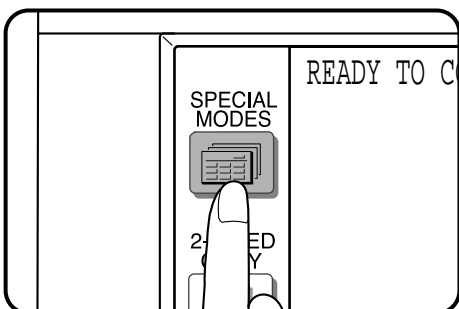

2 Press the **SPECIAL MODES** key.
 • The SPECIAL MODES screen will appear.

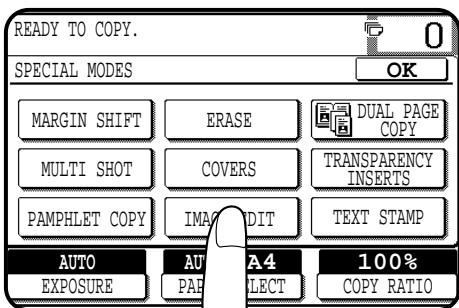

3 Press the **“IMAGE EDIT”** key on the touch panel.
 • The IMAGE EDIT menu will appear.

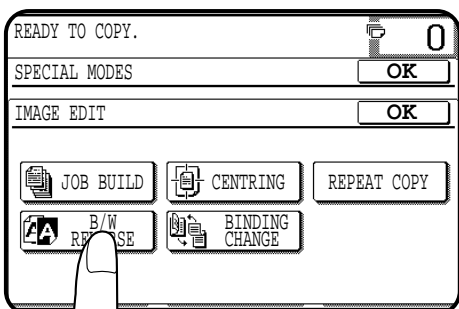

4 Press the **“B/W REVERSE”** key on the touch panel.
 • The **“B/W REVERSE”** key will be highlighted.

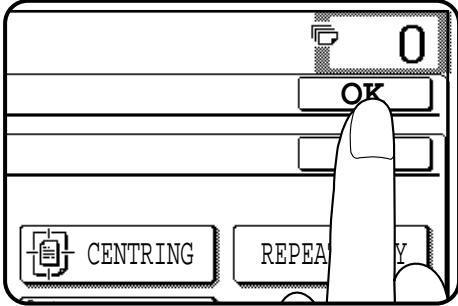

5 Press the upper “OK” key.

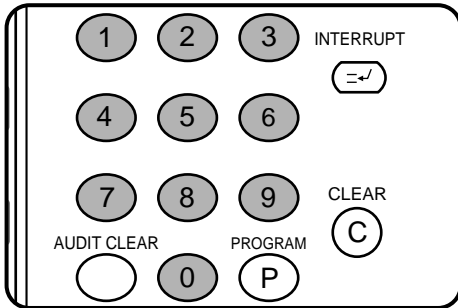

6 Make all other desired copier selections and enter the desired number of copies.

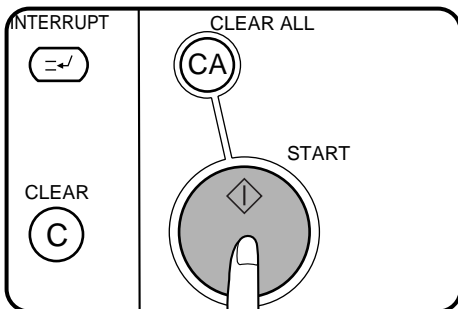

7 Press the **START** (◊) key.

- If the document feeder is used, scanning of originals and copying will start.
- If the document glass is used in the SORT mode, proceed to the next step.

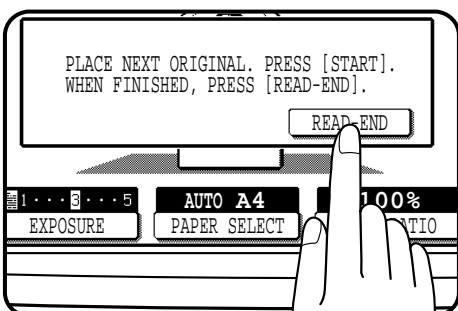





8 Replace the finished original with the next original after the **START** (◊) key indicator lights up, and then press the **START** (◊) key. Repeat this step until all originals have been scanned. Then, press the “READ-END” key on the touch panel.

- Copying will start at this time.
- Up to 120 sheets of A4 (8-1/2" x 11") originals or up to 60 sheets of originals larger than A4 (8-1/2" x 11") can be scanned.
- To cancel the B/W REVERSE function, press the “B/W REVERSE” key again on the IMAGE EDIT menu screen.

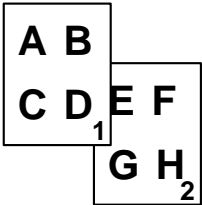
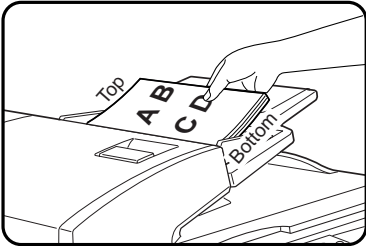
BINDING CHANGE

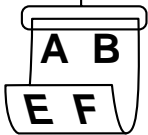
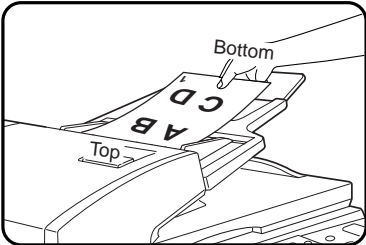
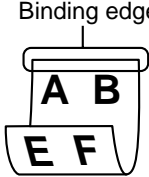
This function rotates the image of originals of the second side in the 1-sided to 2-sided copy mode. This function is useful for copying B4 or A3 (8-1/2" x 14" or 11" x 17") originals in the 1-sided to 2-sided copy mode to allow left side binding.

Original	Setting of originals	Copies
	<p>Portrait orientation setting</p> 	<p>Normal 1-sided to 2-sided copying</p>  <p>Binding edge</p> <p>The binding edge is at the left side.</p>
		<p>1-sided to 2-sided copying with binding change</p>  <p>Binding edge</p> <p>The binding edge is at the top.</p>
	<p>Landscape orientation setting</p> 	<p>Normal 1-sided to 2-sided copying</p>  <p>Binding edge</p> <p>The binding edge is at the top.</p>
		<p>1-sided to 2-sided copying with binding change</p>  <p>Binding edge</p> <p>The binding edge is at the left side.</p>

- This function will not work when non-standard size paper (or 5-1/2" x 8-1/2" paper) is used.

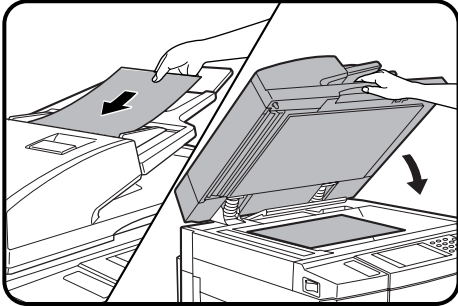

1 Place the originals in the document feeder tray or on the document glass.

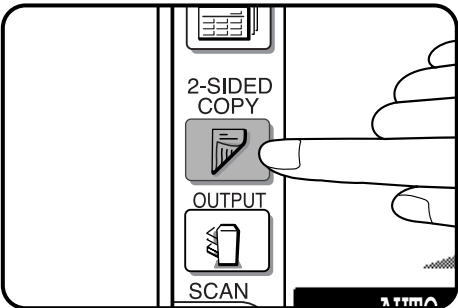

2 Press the 2-SIDED COPY key and select the 1-sided to 2-sided copy mode.

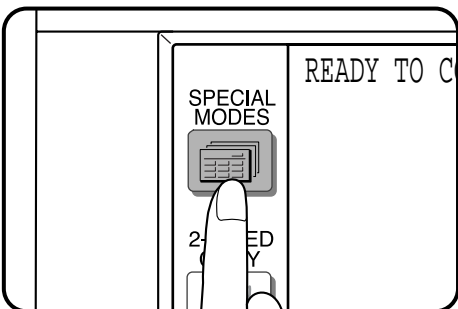

3 Press the SPECIAL MODES key.
 • The SPECIAL MODES screen will appear.

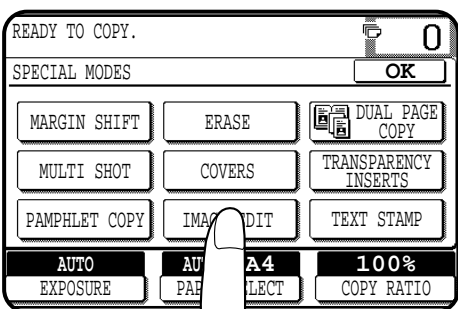

4 Press the "IMAGE EDIT" key on the touch panel.
 • The IMAGE EDIT menu will appear.

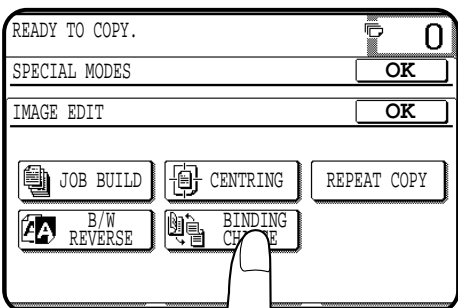

5 Press the "BINDING CHANGE" key on the touch panel.
 • The "BINDING CHANGE" key will be highlighted.
 • When "BINDING CHANGE" is selected, the 1-sided to 2-sided copy mode is automatically on.

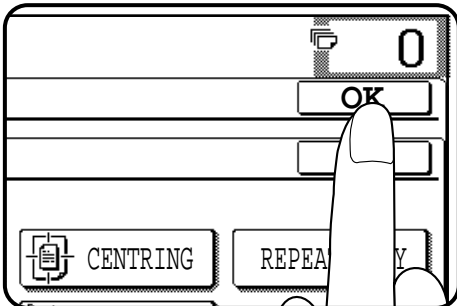

6 Press the upper “OK” key.

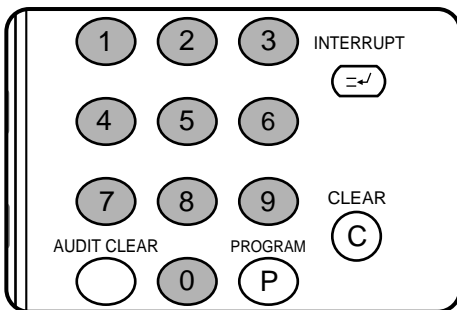

7 Make all other desired copier selections and enter the desired number of copies.

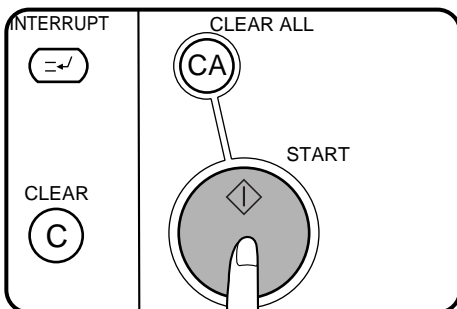

8 Press the **START** (◊) key.

- If the document feeder is used, scanning of originals and copying will start.
- If the document glass is used, proceed to the next step.

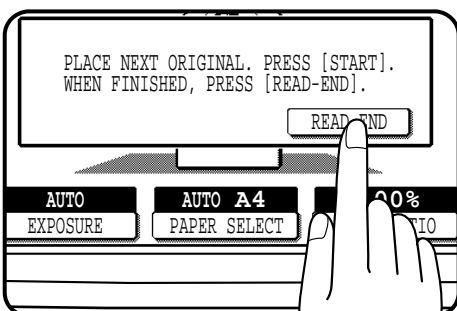

9 Replace the finished original with the next original after the **START** (◊) key indicator lights up, and then press the **START** (◊) key. Repeat this step until all originals have been scanned. Then, press the “READ-END” key on the touch panel.

- Copying will start at this time.
- Up to 120 sheets of A4 (8-1/2" x 11") originals or up to 60 sheets of originals larger than A4 (8-1/2" x 11") can be scanned.
- To cancel the BINDING CHANGE function, press the “BINDING CHANGE” key again on the IMAGE EDIT menu screen.

TEXT STAMP

The text stamp functions include the following functions.

- Date: Adds the current date to the copies.
- Select stamp: Adds a selected stamp to the copies. The stamp will be printed in white on a shaded background.
- Watermark: Adds a selected watermark to the copies. The watermark will be printed in gray tone.
- Page number: Adds page numbers to the copies.

These functions are selected by pressing the “TEXT STAMP” key on the SPECIAL MODES screen and then selecting from the “TEXT STAMP” menu.

- These functions will not work when non-standard size paper is used.
- Multiple text stamp functions can be selected at the same time except for SELECT STAMP and WATERMARK. These functions cannot be selected together.
- Depending upon the original image type, the watermark may obscure some of the copied image or vice versa.
- The size of printed characters is fixed. The size will not vary even in reduction or enlargement copying.

DATE

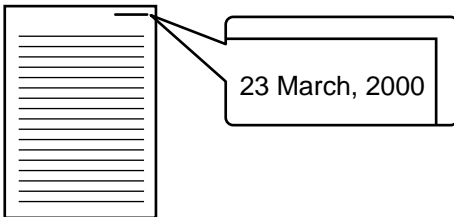

The DATE function adds the current date to the copies. The date will be printed at the upper right of the copies.

- If reduction or enlargement is used with this function, the print position may move or the date may not be printed.
- ★ **KEY OPERATOR** To use the DATE function, set the current date and time. See page 8-21. The initial setting of the date format can be changed. See page 8-20.

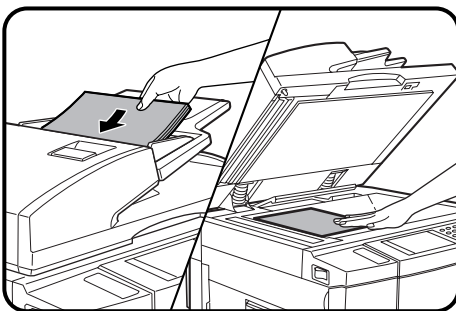

- 1** Place the originals in the document feeder tray or on the document glass.

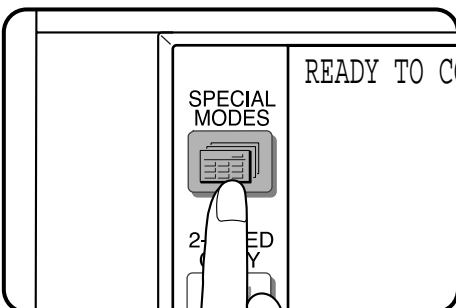

- 2** Press the SPECIAL MODES key.
 - The SPECIAL MODES screen will appear.

- 3 Press the "TEXT STAMP" key on the touch panel.
 - The TEXT STAMP menu will appear.

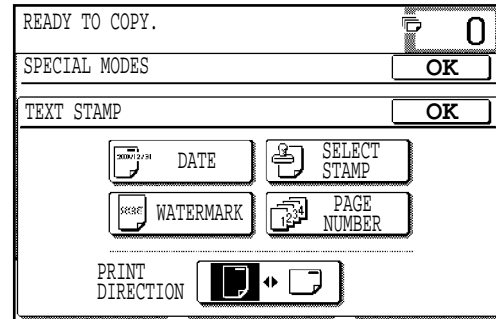
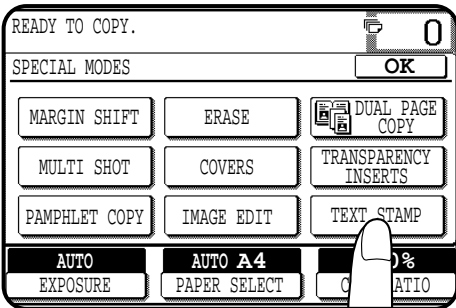

- 4 Press the "DATE" key on the touch panel.
 - The setting screen for DATE will appear.

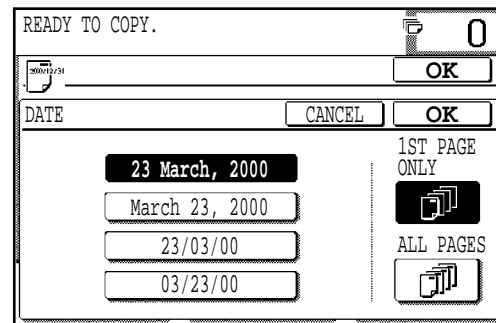
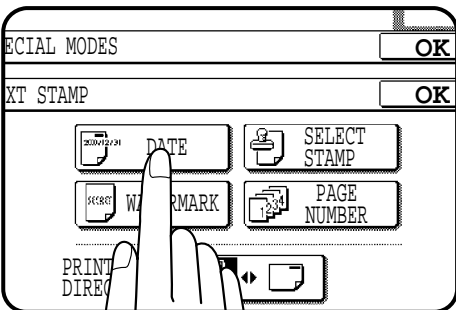

- 5 Select the desired date format on the touch panel.
 - The selected format will be highlighted.
 - The date formats displayed on the touch panel may be different from the illustration above depending on the country or region.

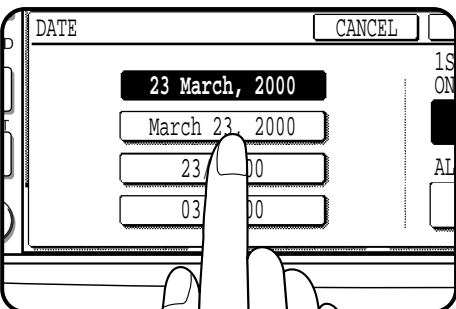

- 6 Select the pages to be stamped.
 - Indicate whether the date is to be printed only on the first page or on all pages, by pressing the "1ST PAGE ONLY" or "ALL PAGES" key.

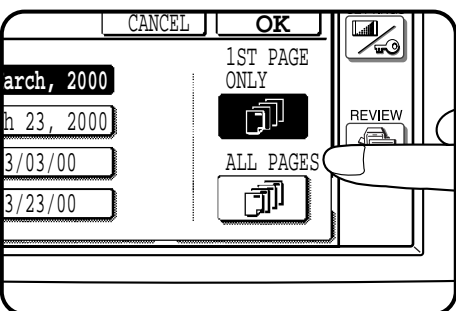

- 7 Press the lower "OK" key.
 - The TEXT STAMP menu will appear again.

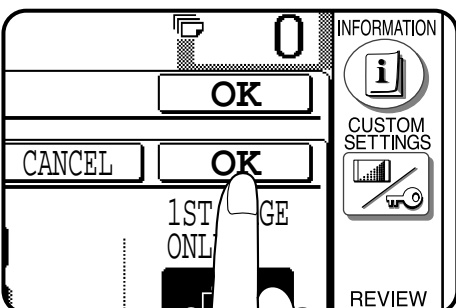

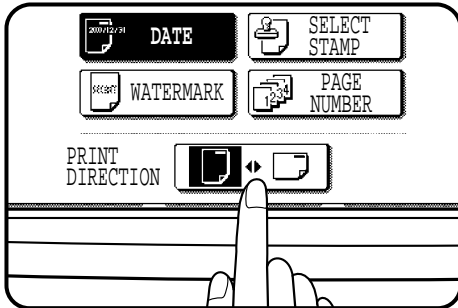

- 8 Select the print direction.**
- If the PAMPHLET COPY function is used with this function, the portrait orientation (📄) must be selected.

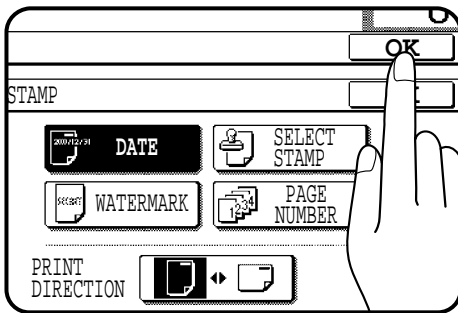

- 9 Press the upper "OK" key.**

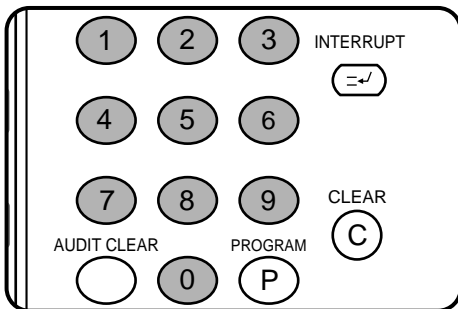

- 10 Make all other desired copier selections and enter the desired number of copies.**

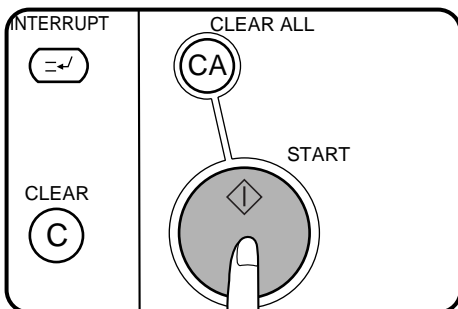

- 11 Press the START (◊) key.**
- If the document feeder is used, scanning of originals and copying will start.
 - If the document glass is used, proceed to the next step.

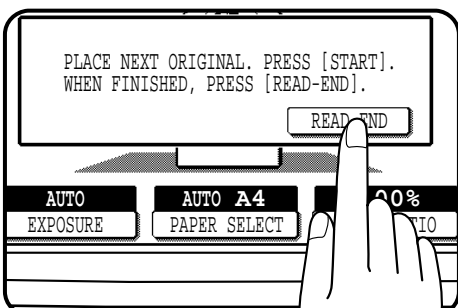

- 12 Replace the finished original with the next original after the START (◊) key indicator lights up, and then press the START (◊) key. Repeat this step until all originals have been scanned. Then, press the "READ-END" key on the touch panel.**
- Copying will start at this time.
 - Up to 120 sheets of A4 (8-1/2" x 11") originals or up to 60 sheets of originals larger than A4 (8-1/2" x 11") can be scanned.
 - To cancel the DATE function, select the DATE function again and press the "CANCEL" key.

SELECT STAMP

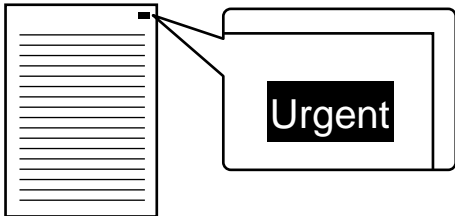

The SELECT STAMP function adds a selected stamp such as “Confidential” or “Urgent” to the copies. The stamp will be printed in white on a shaded background.

- The stamps which can be selected are: “Confidential”, “Urgent”, “Copy”, “Preliminary”, “Draft”, and “Final”.
- The darkness of the shaded background can be adjusted in three levels.
- The print position can be selected from six positions.
- If reduction or enlargement is used with this function, the print position may move or the stamp may not be printed.

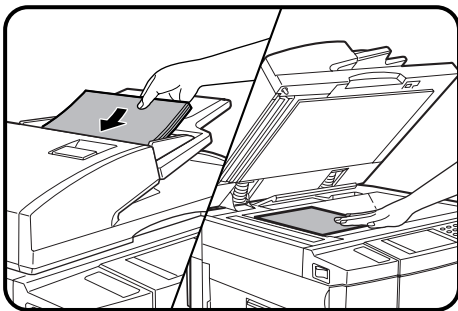

1 Place the originals in the document feeder tray or on the document glass.

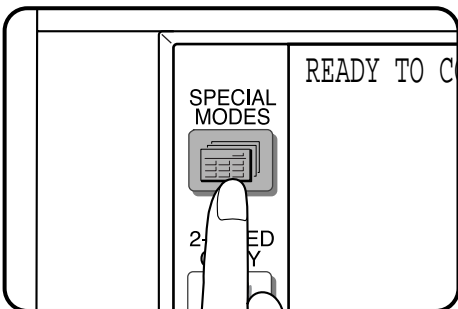

2 Press the **SPECIAL MODES** key.

- The SPECIAL MODES screen will appear.

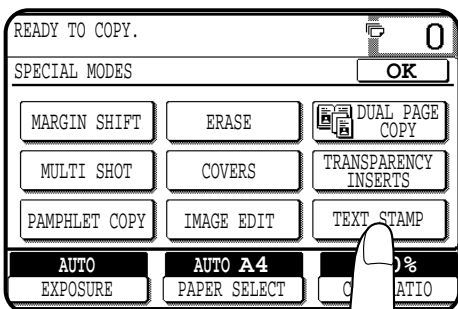

3 Press the **“TEXT STAMP”** key on the touch panel.

- The TEXT STAMP menu will appear.

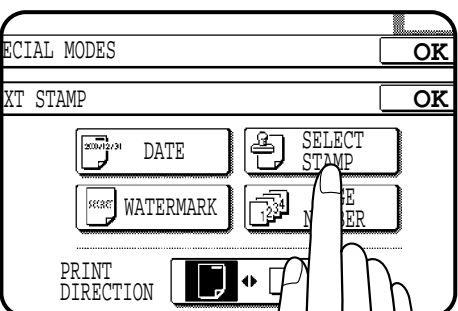

4 Press the **“SELECT STAMP”** key on the touch panel.

- The setting screen for SELECT STAMP will appear.

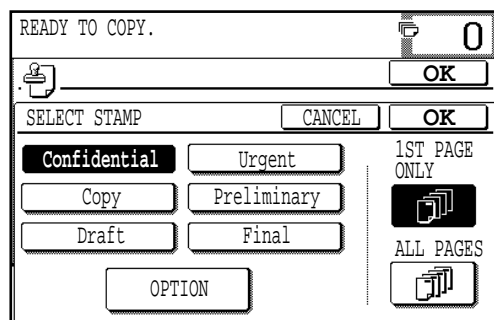

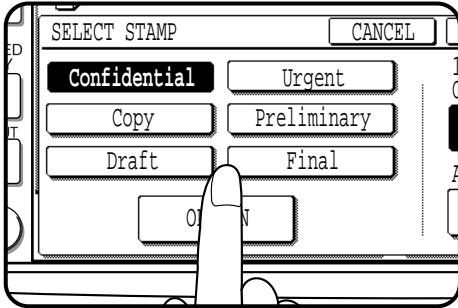

5 Select the desired stamp to be printed.

- The selected stamp will be highlighted.

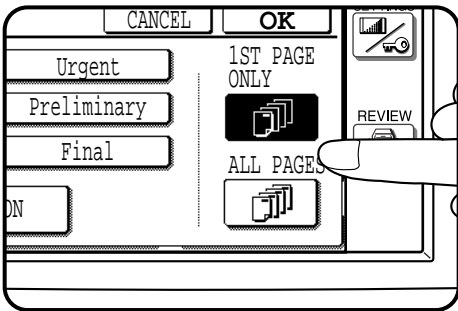

6 Select the pages to be stamped.

- Indicate whether the stamp is to be printed only on the first page or on all pages, by pressing the "1ST PAGE ONLY" or "ALL PAGES" key.

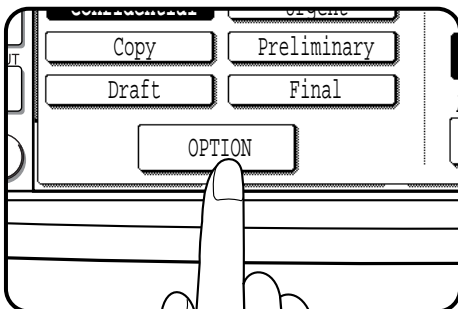

7 To adjust the exposure and print position, press the "OPTION" key. Otherwise, proceed to step 10.

- The following screen will appear.

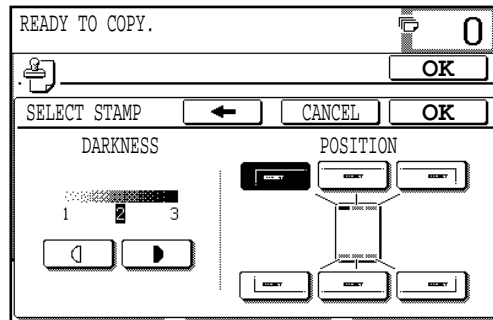

8 Adjust the darkness of the background of the stamp.

- Press the  key to darken or the  key to lighten.

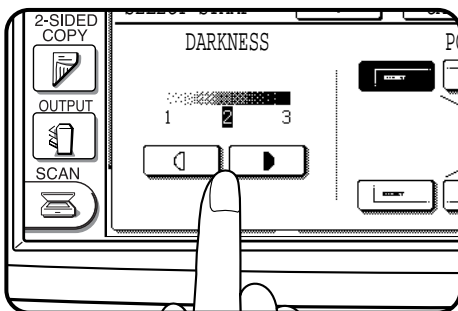

9 Select the stamp position.

- The selected position will be highlighted.
- To return to the previous screen, press the  key.

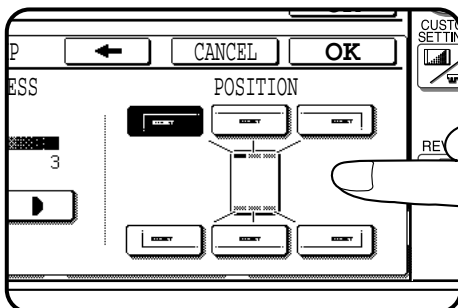

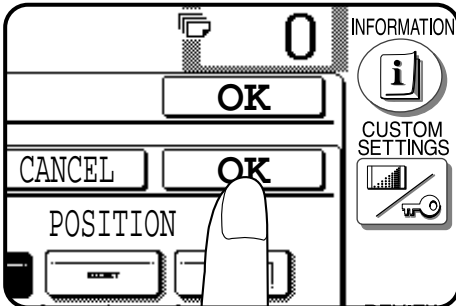

- 10** Press the lower “OK” key.
- The TEXT STAMP menu will appear again.

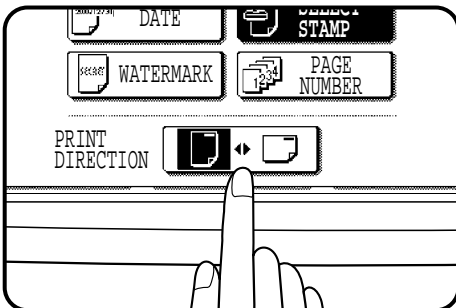

- 11** Select the print direction.
- If the PAMPHLET COPY function is used with this function, the portrait orientation (📄) must be selected.

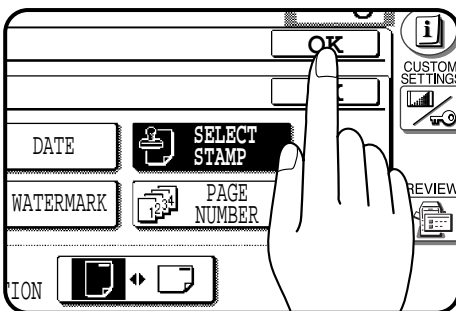

- 12** Press the upper “OK” key.

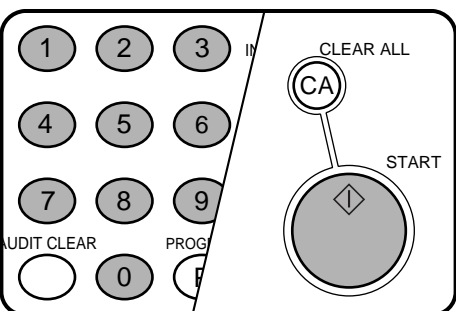

- 13** Make all other desired copier selections and enter the desired number of copies.

- 14** Press the START (◊) key.
- If the document feeder is used, scanning of originals and copying will start.
 - If the document glass is used, proceed to the next step.

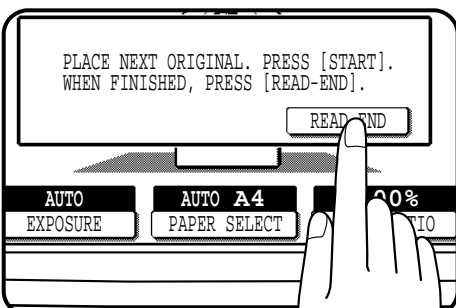

- 15** Replace the finished original with the next original after the START (◊) key indicator lights up, and then press the START (◊) key. Repeat this step until all originals have been scanned. Then, press the “READ-END” key on the touch panel.

- Copying will start at this time.
- Up to 120 sheets of A4 (8-1/2" x 11") originals or up to 60 sheets of originals larger than A4 (8-1/2" x 11") can be scanned.
- To cancel the SELECT STAMP function, select the SELECT STAMP function again and press the “CANCEL” key.

WATERMARK

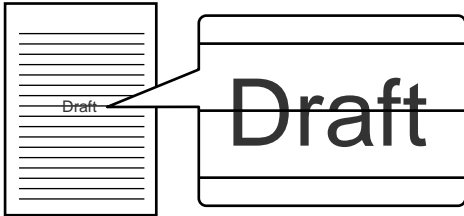

The WATERMARK function adds a selected watermark such as “Confidential” or “Urgent” to the copies. The watermark will be printed in gray tone at the centre of copies.

- The watermarks which can be selected are: “Confidential”, “Urgent”, “Copy”, “Preliminary”, “Draft”, and “Final”.
- The darkness of the watermark can be adjusted in two levels.

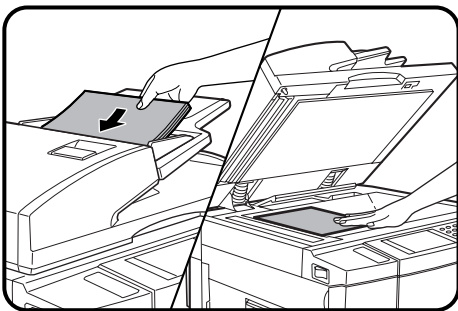

1 Place the originals in the document feeder tray or on the document glass.

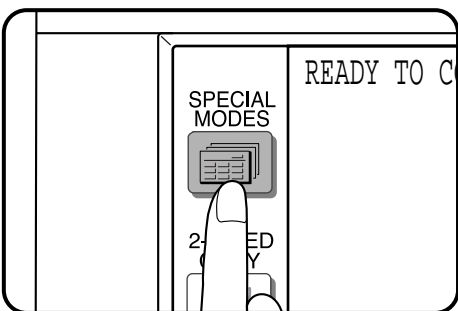

2 Press the SPECIAL MODES key.
 • The SPECIAL MODES screen will appear.

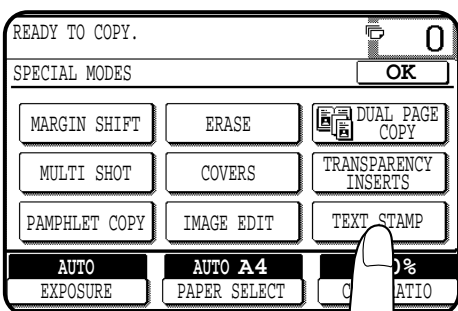

3 Press the “TEXT STAMP” key on the touch panel.
 • The TEXT STAMP menu will appear.

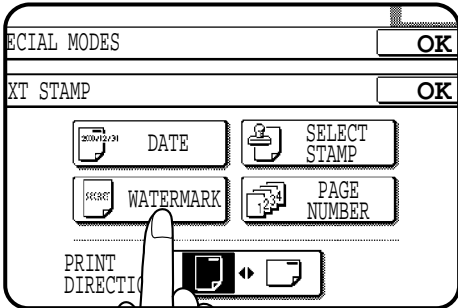

- 4** Press the “WATERMARK” key on the touch panel.
- The setting screen for WATERMARK will appear.

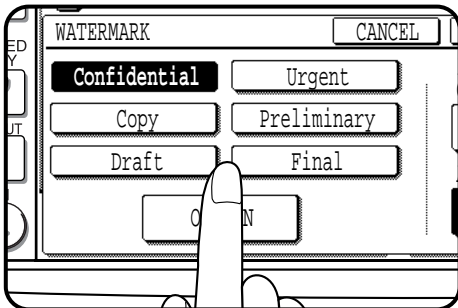
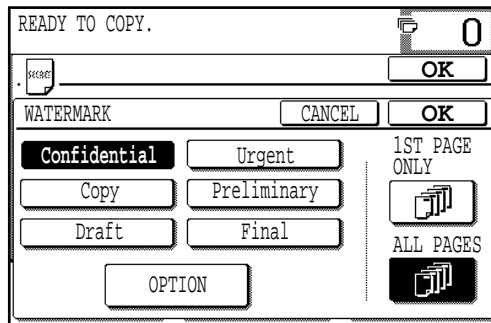

- 5** Select the desired watermark to be printed.
- The selected watermark will be highlighted.

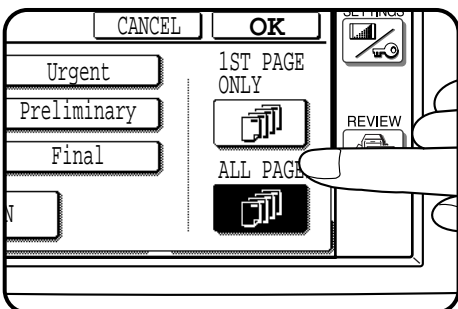

- 6** Select the pages to be printed with the watermark.
- Indicate whether the watermark is to be printed only on the first page or on all pages, by pressing the “1ST PAGE ONLY” or “ALL PAGES” key.

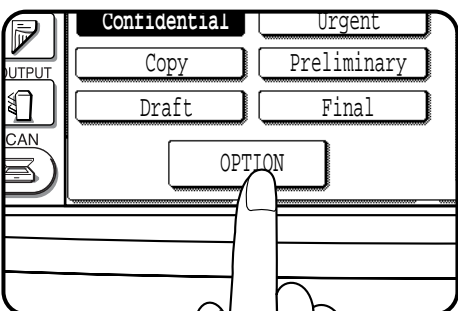

- 7** To adjust the exposure, press the “OPTION” key. Otherwise, proceed to step 9.
- The following screen will appear.

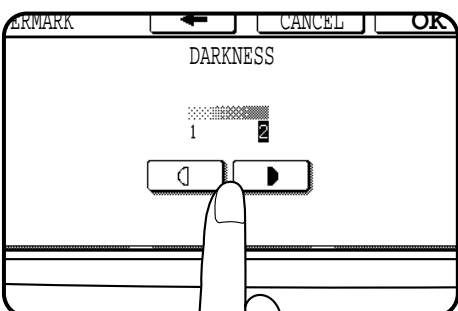
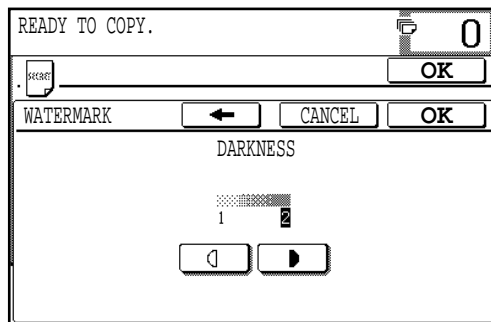

- 8** Adjust the darkness of the watermark.
- Press the key to darken or the key to lighten.
 - To return to the previous screen, press the key.

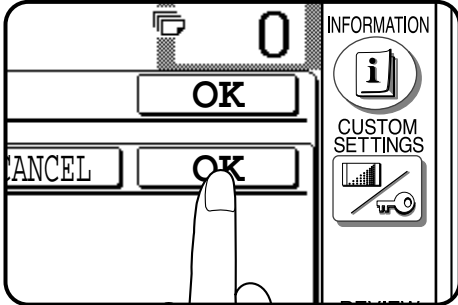

- 9** Press the lower “OK” key.
- The TEXT STAMP menu will appear again.

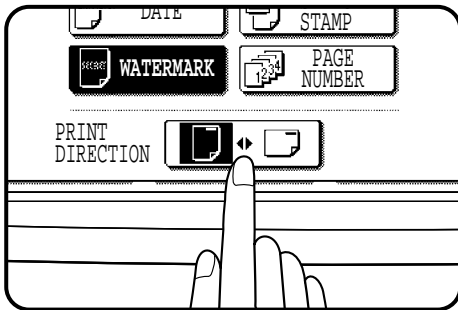

- 10** Select the print direction.
- If the PAMPHLET COPY function is used with this function, the portrait orientation (📄) must be selected.

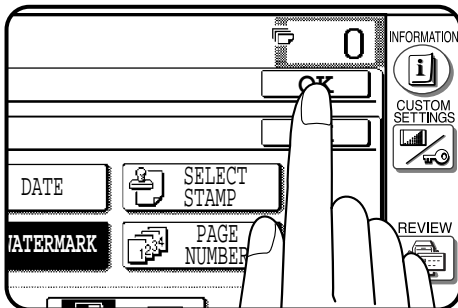

- 11** Press the upper “OK” key.

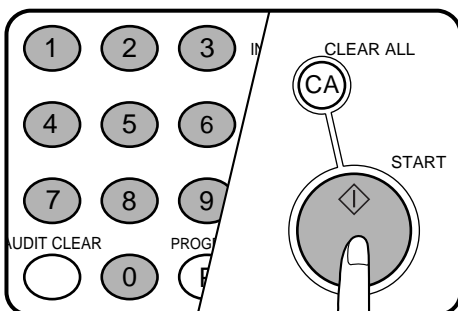

- 12** Make all other desired copier selections and enter the desired number of copies.

- 13** Press the START (◊) key.
- If the document feeder is used, scanning of originals and copying will start.
 - If the document glass is used, proceed to the next step.

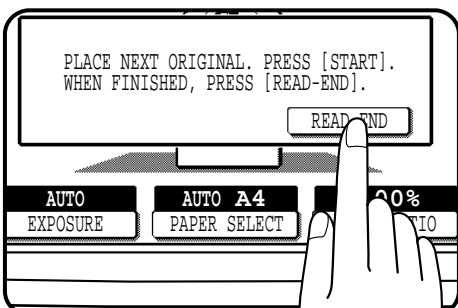

- 14** Replace the finished original with the next original after the START (◊) key indicator lights up, and then press the START (◊) key. Repeat this step until all originals have been scanned. Then, press the “READ-END” key on the touch panel.
- Copying will start at this time.
 - Up to 120 sheets of A4 (8-1/2" x 11") originals or up to 60 sheets of originals larger than A4 (8-1/2" x 11") can be scanned.
 - To cancel the WATERMARK function, select the WATERMARK function again and press the “CANCEL” key.

PAGE NUMBER

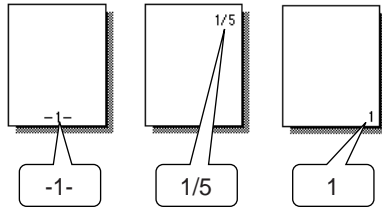

The PAGE NUMBER function adds page numbers to the copies.

- The page number format can be selected from three types.
- The page number print position is automatically selected depending on the selected page number format.
- If reduction or enlargement is used with this function, the print position may move or the page numbers may not be printed.

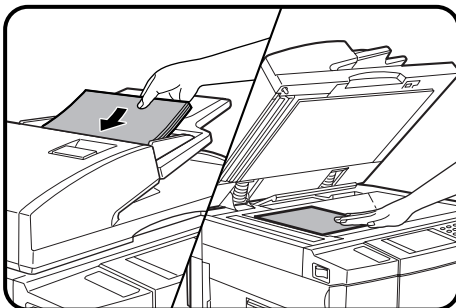

1 Place the originals in the document feeder tray or on the document glass.

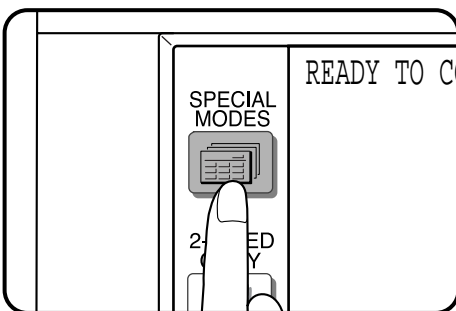

2 Press the SPECIAL MODES key.
 • The SPECIAL MODES screen will appear.

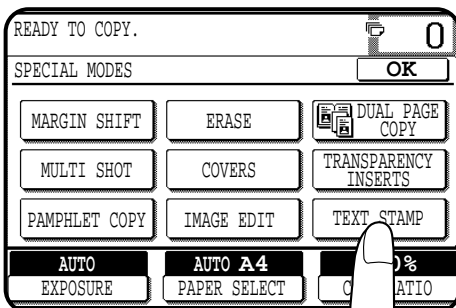

3 Press the “TEXT STAMP” key on the touch panel.
 • The TEXT STAMP menu will appear.

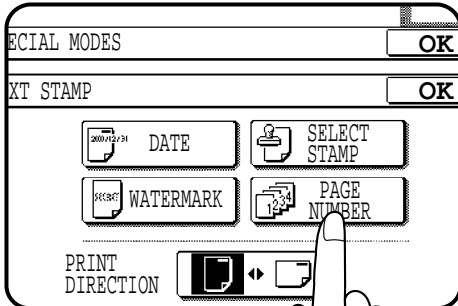

- 4** Press the “PAGE NUMBER” key on the touch panel.
- The setting screen for PAGE NUMBER will appear.

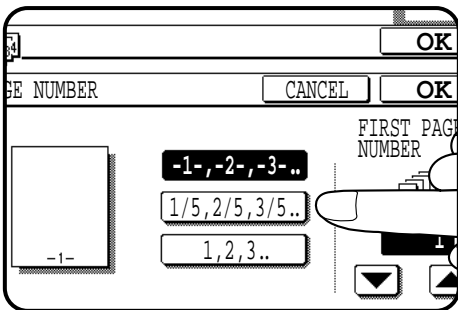
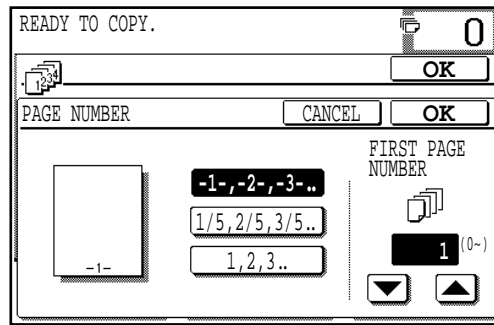

- 5** Select the desired page number format.
- The selected page number format will be highlighted.

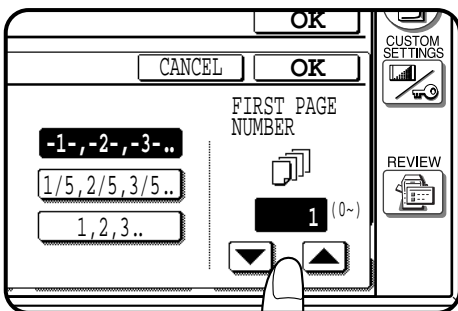

- 6** Select the starting page number.
- Use the ▼ or ▲ key to increment or decrement the page number.
 - If the page number format “1/5, 2/5, 3/5..” has been selected in step 5, the starting page number is fixed to 1 and cannot be changed.

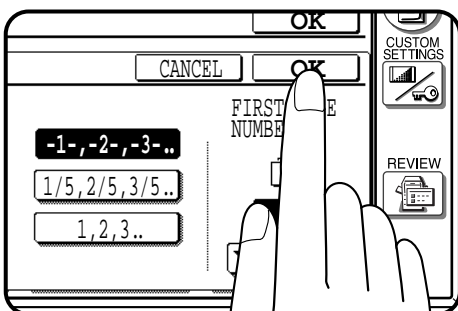

- 7** Press the lower “OK” key.
- The TEXT STAMP menu will appear again.

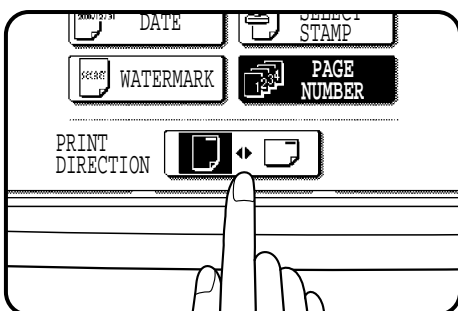

- 8** Select the print direction.
- If the PAMPHLET COPY function is used with this function, the portrait orientation (📄) must be selected.

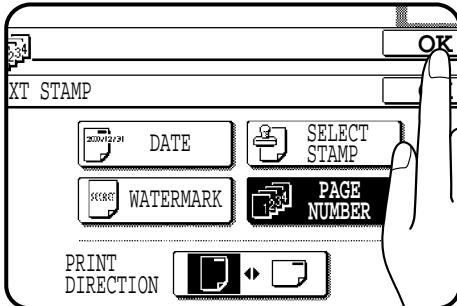

9 Press the upper “OK” key.

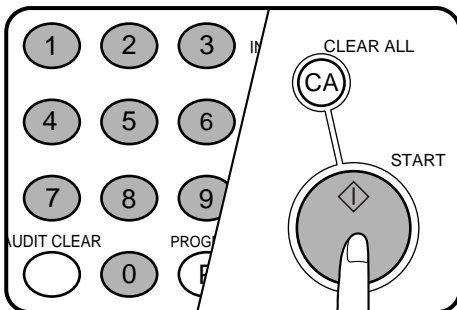

10 Make all other desired copier selections and enter the desired number of copies.

11 Press the START (◊) key.

- If the document feeder is used, copying will start after all originals are scanned.
- If the document glass is used, proceed to the next step.

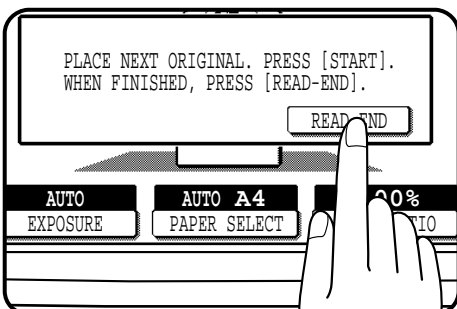

12 Replace the finished original with the next original after the START (◊) key indicator lights up, and then press the START (◊) key. Repeat this step until all originals have been scanned. Then, press the “READ-END” key on the touch panel.

- Copying will start at this time.
- Up to 120 sheets of A4 (8-1/2" x 11") originals or up to 60 sheets of originals larger than A4 (8-1/2" x 11") can be scanned.
- To cancel the PAGE NUMBER function, select the PAGE NUMBER function again and press the “CANCEL” key.

TANDEM COPY

If this copier is connected with another copier of the same model equipped with the same options through the tandem-connection cable (AR-CA1), copying with the two machines can be performed eventually making the total copy time for multiple copies one-half of the case when using a single copier.

- A dedicated tandem-connection cable AR-CA1 is required for tandem copying.
- The tandem copying can be used only in the sort mode or staple sort mode. The group mode cannot be selected.
- The transparency inserts function cannot be used with this function because the number of copies must be 1 when the transparency inserts function is used.
- The TANDEM COPY key will only be displayed on the touch panel of the machine set as the main copier, (an authorised Sharp Service Technician will do the setting of the main and sub copiers at the time of installation). When the tandem function is selected, (only available on the main copier) the other will then become the sub copier. The setting procedure is described below.

- INTERRUPT will not function during tandem copying.

CHAPTER 3

SPECIAL FUNCTIONS Tandem copy

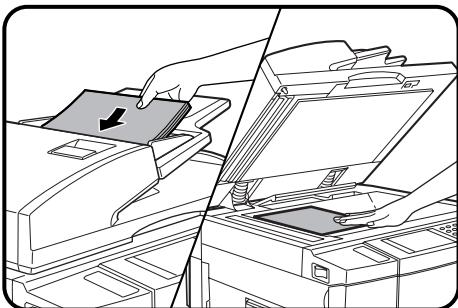

1 Ensure that the two copiers are connected through the tandem-connection cable and they have been turned on.

2 On the copier that will be set as the main copier, place the originals in the document feeder tray or on the document glass.

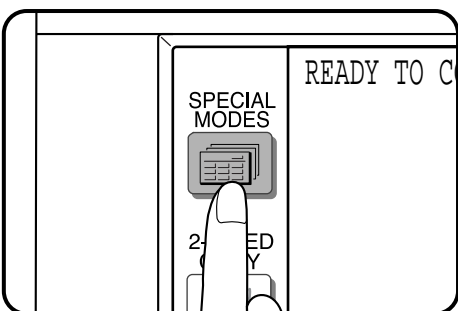

3 Press the SPECIAL MODES key.

- The SPECIAL MODES screen will appear.

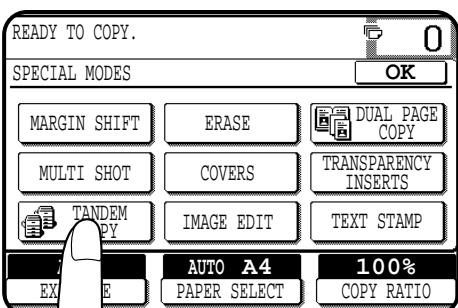

4 Press the “TANDEM COPY” key on the touch panel.

- The “TANDEM COPY” key will be highlighted.

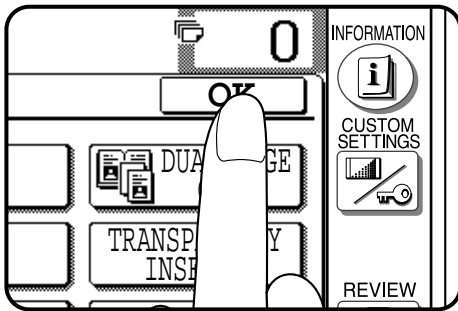

5 Press the “OK” key.

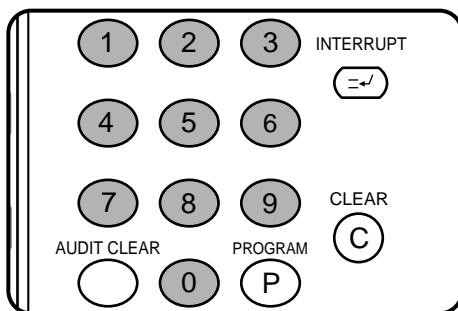

6 Make all other desired copier settings and enter the number of copies.

- The functions selected on the main copier will be used by both copiers.
 - (1) The key operator programs of which settings at the main copier are given priority (the settings at the sub copier are disregarded): Exposure Adjustment, Toner Save Mode, Initial Margin Shift, Erase Width Adjustment, Initial Status Setting, Staple Position Setting, Date Format Setting, Date and Time Adjustment and Disabling of Covers Mode.
 - (2) The key operator programs for which the same settings between the main and sub copiers are required: Disabling of Duplex Copying and Disabling of Stapler.
 - (3) The key operator program that can only be set at the main copier: Disabling of Auto Paper Selection.
 - (4) In case of the other key operator programs than mentioned above, different settings on the main and sub copiers respectively do not matter even when the tandem copying is activated.

7 Ensure that paper of the same size selected in the main copier is installed in the sub copier.

- Paper of the same size and same orientation must be installed in the two copiers. Even if the image of the original is rotated to match the copy paper in the main copier, the orientation of the copy paper in the sub copier must be the same as that in the master copier.

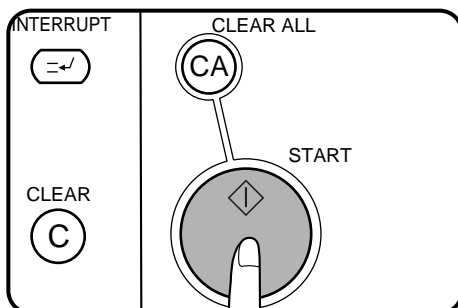

8 On the main copier, press the START (◊) key.

- Images scanned by the main copier will be stored in both copiers. Half the number of copies selected will be made simultaneously on both copiers. When the number of copies selected is odd, one more copy will be made on the main copier than the sub copier.
- If the message “CHECK THE SUB MACHINE.” appears on the main machine, an error has occurred in the sub machine. Check the message on the sub machine and clear the error.
- If the message “THE SYSTEM IS NOT CONFIGURED TO PERFORM TANDEM JOB. CODE: XX” appears on the main machine, refer to the tandem copy related descriptions in the TROUBLESHOOTING (see page 5-15).
- To cancel a copy run after starting, press the CLEAR ALL (CA) key on the main copier.
- To cancel the TANDEM copying, press the “TANDEM COPY” key again on the SPECIAL MODES screen of the main copier.

SETTING REVIEW

The current settings of copier functions can be displayed on the touch panel.

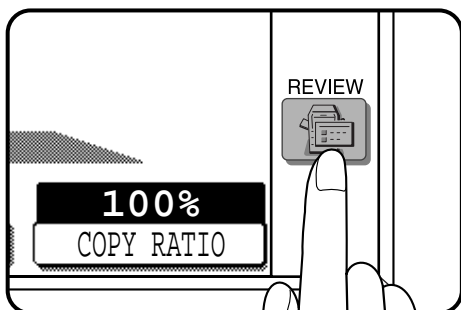

1 Press the REVIEW (🖨️) key.

- The REVIEW screen will appear.

The settings of the duplex mode (1-sided to 1-sided, etc.), sort/group mode, and special functions will be displayed. The exposure, paper size, and copy ratio which are displayed on the basic screen will not be displayed on the REVIEW screen.

Example

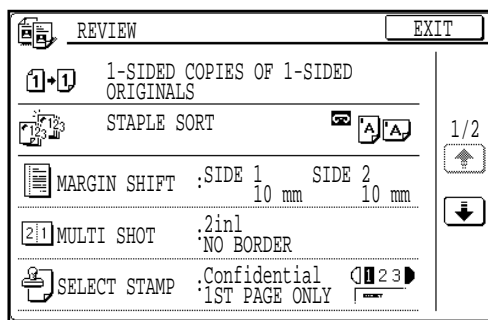

2 To review all setting information, it may be necessary to scroll between review screens. To scroll between screens, use the ⬇️ or ⬆️ key.

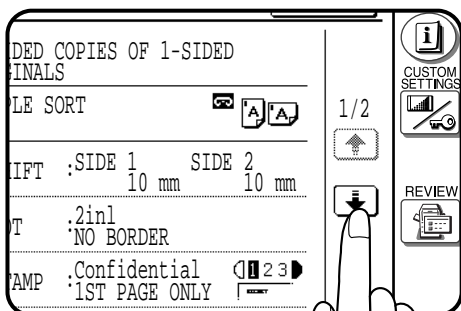

3 To exit the review screen, press the “EXIT” key.

- The basic screen will appear again.

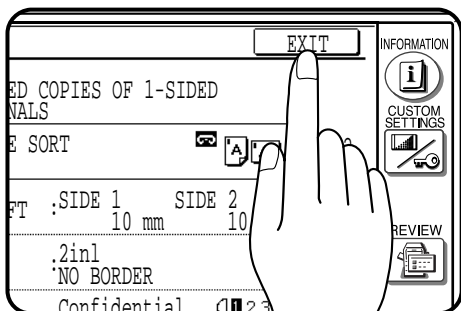

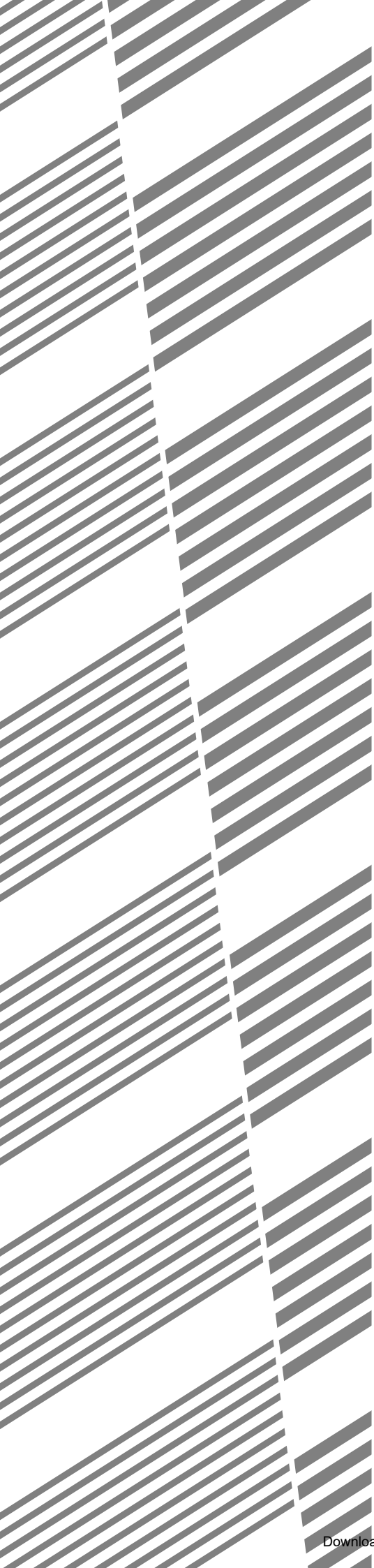

CHAPTER 4

SUPPLIES

This chapter describes the supplies for this copier such as paper and toner.

	Page
• PAPER	4-2
Types and sizes of copy paper	4-2
Loading copy paper	4-2
• ADDING TONER	4-5
• USED TONER DISPOSAL	4-7
• STORAGE OF SUPPLIES	4-8



PAPER

Types and sizes of copy paper

		Size	Weight	Capacity (80 g/m ² (21lb.) paper)	Special paper
Paper trays 1 and 2		A5 to A3 (5-1/2" x 8-1/2" to 11" x 17")	56 to 105 g/m ² (15 lbs. to 28 lbs.)	500 sheets	
Bypass tray	Face up delivery	A6 to A3 (5-1/2" x 8-1/2" to 11" x 17")	52 to 128 g/m ² (14 lbs. to 34 lbs.)* (Ordinary paper)	50 sheets	Transparency film, labels, tracing paper, 176 g/m ² (65 lb.) paper**, 200 g/m ² (110 lb.) paper**
	Face down delivery	A5 to A3 (8-1/2" x 11" to 11" x 17")	56 to 105 g/m ² (15 lbs. to 28 lbs.)	50 sheets	

- For best results, use only paper recommended by SHARP.
 - * For paper weighing from 105 to 128 g/m² (28 to 34 lbs.), A4 (8-1/2" x 11") is the maximum size that can be fed through the bypass tray.
 - ** Paper heavier than 128 g/m² (34 lbs.) must be fed narrow side into the feed slot of the bypass tray.
- ★ **KEY OPERATOR** To enable face down delivery from the bypass tray, paper type setting in the bypass tray must be enabled. See page 8-22.

Loading copy paper

"OPEN TRAY AND ADD PAPER." will be displayed when there is no copy paper in a selected paper feed station.

When a selected paper tray is not installed or is improperly installed, "PUSH PAPER TRAY INTO THE MACHINE UNTIL IT LATCHES." will be displayed. Install it or push it back firmly into place.

For best results, use only Sharp recommended paper.

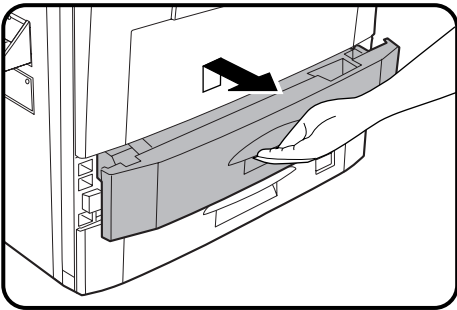
Loading paper in paper trays 1 and 2

1 Gently lift and pull out the paper tray.

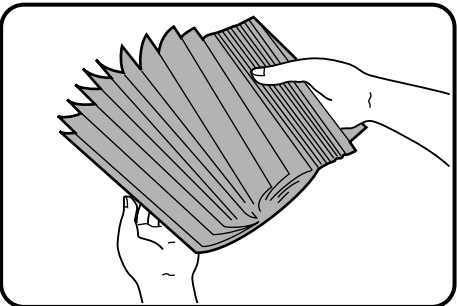

2 Only use paper within the Sharp specification and follow the paper manufacturer's instructions regarding fanning and loading the paper.

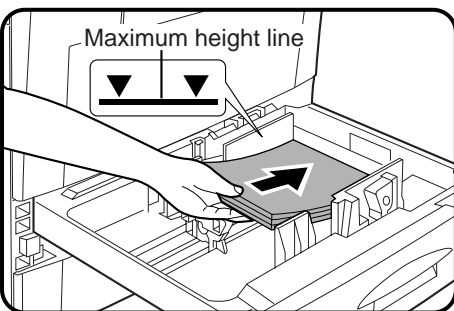

- The tray holds 500 sheets of paper.
Do not load paper above the maximum height line.

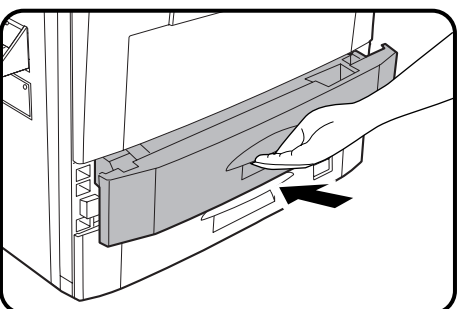

3 Push the paper tray firmly back into the copier.

Changing the copy paper size in the tray

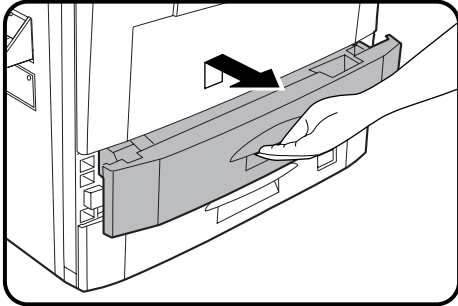

1 Gently lift and pull out the paper tray until it stops.

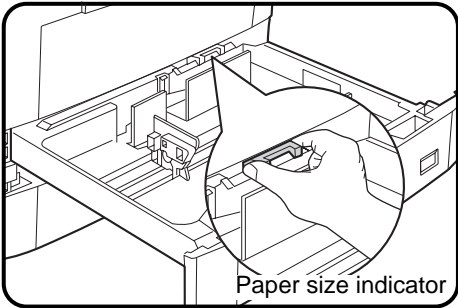

2 Adjust the paper size indicator to match the paper size to be set.

- Slide the paper size indicator to the right or left to match the paper size.

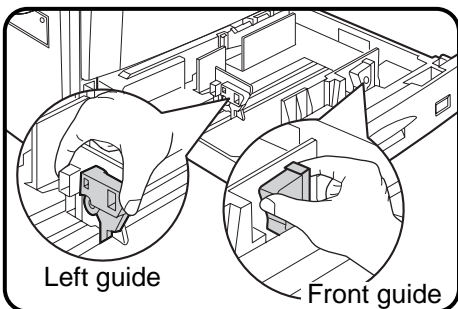

3 Adjust the front guide and left guide while squeezing their lock levers.

- Slide the front and left guides to match the width and length of the copy paper.

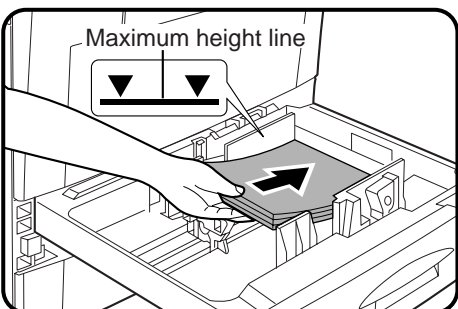

4 Load copy paper into the tray.

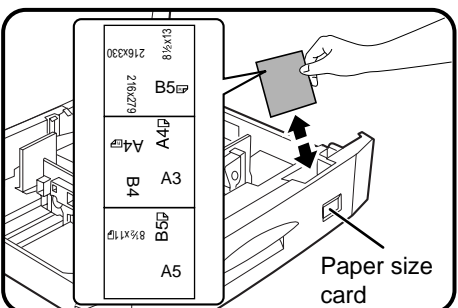







5 Place the paper size card in the front of the paper tray.

- The paper size card has three faces. Fold the card properly to show the selected paper size. The paper size indication which shows through the slot on the front of the copier should match the selected paper size.

6 Push the paper tray firmly back into the copier.

ADDING TONER

The message “(TONER SUPPLY IS LOW. PRESS  FOR GUIDANCE.)” will appear in the message display before the toner supply is completely empty. If copying is continued, copies will gradually become lighter until the copier stops and the message display changes to “ADD TONER. PRESS  FOR GUIDANCE.” indicating that the toner supply is empty. Toner can be added any time after the message “(TONER SUPPLY IS LOW. PRESS  FOR GUIDANCE.)” appears. To add toner, stop the copier and proceed as below. When either message appears, you can use the INFORMATION () key for detailed information as necessary.

During long copy runs of multiple originals containing many images and/or dark shades, “TONER REPLENISHMENT IN PROGRESS.” will appear and the copier will stop making copies even though toner is left. The copier will automatically cycle and replenish the toner to the normal level and then the START () key indicator will light up. Press the START () key to resume copying.

For best copying results, be sure to use only Sharp products. The package of Sharp toner has the Genuine Supplies label.

SHARP

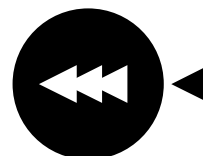

GENUINE SUPPLIES

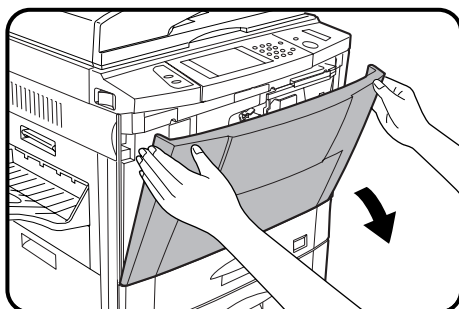

1 Open the front cover.

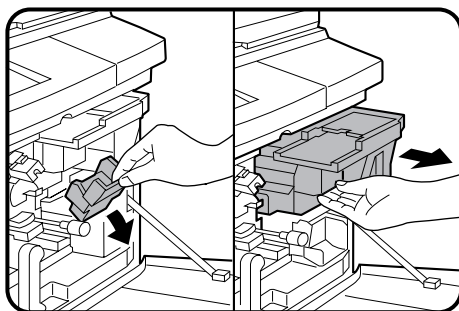

2 Pull down the toner hopper lock lever and pull the toner hopper out slowly until it stops.

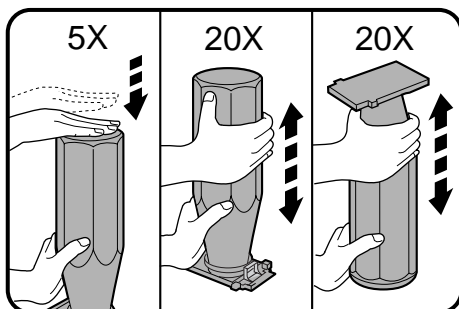

3 Tap on the top of the toner cartridge 5 times. Hold the new toner cartridge vertically and vigorously shake it up and down about 20 times, then invert the cartridge and again shake it up and down about 20 times. This will loosen the toner and allow it to flow more easily into the toner hopper.

- When any caution label is attached to the new toner cartridge, read it carefully and remove it.

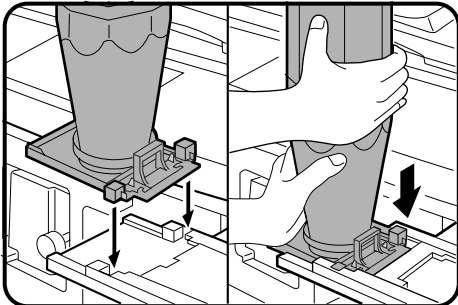

4 Place the new toner cartridge with the protrusions in the notches as shown.

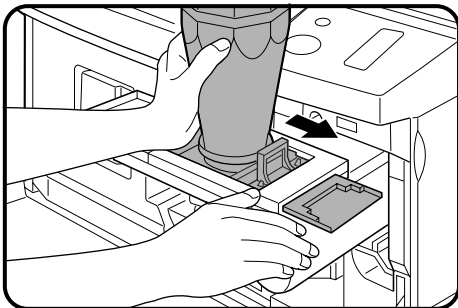

5 Slide the toner cartridge along the guides over the toner hopper.

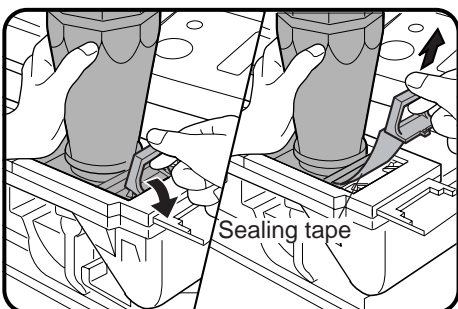

6 Hold the toner cartridge with one hand and bend the protrusion at the sealing tape as shown in the illustration.

7 Pull on the sealing tape to remove it.

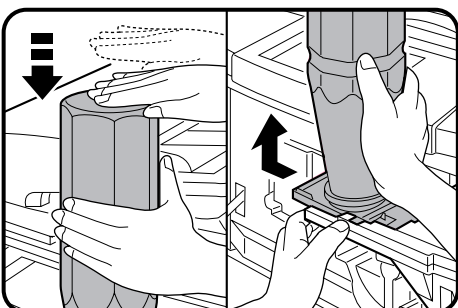

8 Tap on the top of the toner cartridge 5 times to start the flow of toner into the toner hopper.

- If the toner cartridge was sufficiently shaken as described in step 3, it will take about 50 seconds for the cartridge to empty. Do not remove the cartridge until it is empty. If not empty, tap on the top of the cartridge again until empty.

9 Slide the empty toner cartridge back along the guides and remove it.

- The cartridge opening will be closed as it is moved back along the guides.

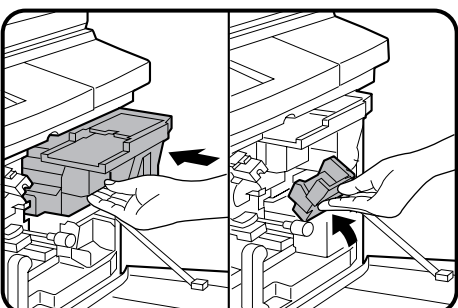

10 Slide the toner hopper into the copier and return the toner hopper lock lever into place.

11 Close the front cover.

NOTE:
Add only one cartridge of toner.

USED TONER DISPOSAL

"REPLACE USED TONER CONTAINER. PRESS  FOR GUIDANCE." will appear when the toner collecting container is full.

The copier will stop and will not operate until a new container has been installed. Replace the toner collecting container as described below. When the above message is displayed, you can use the INFORMATION () key for detailed information as necessary.

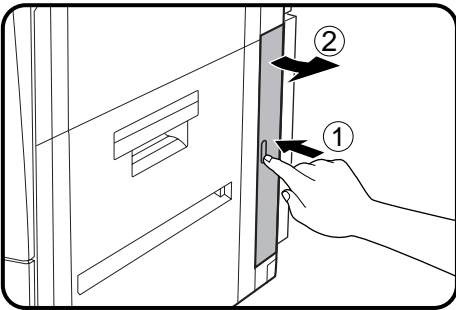

1 Open the toner collecting container cover.

- Push once on the door to unlatch and open it.

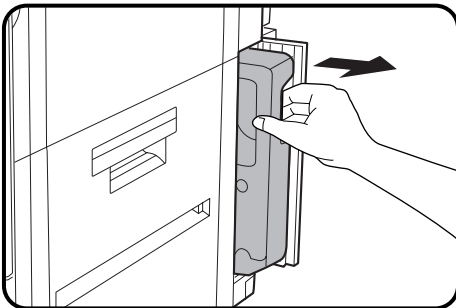

2 Disengage and remove the container from the copier.

- Toner cannot be reused. Do not transfer used toner to the toner hopper.
- Remove the cap from a new toner collecting container and use it to cover the full toner collecting container.
- Keep the full toner collecting container until the next regular service call. Your authorised Sharp Service Technician will collect the container for disposal.

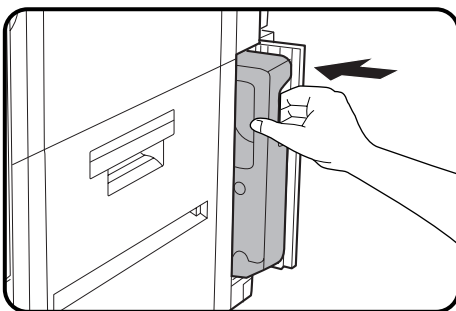

3 Install a new toner collecting container until it clicks into place.

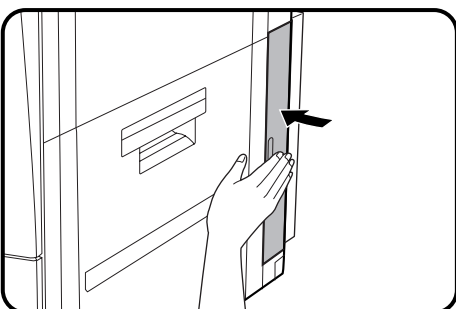

4 Close the toner collecting container cover.

STORAGE OF SUPPLIES

The supplies of this copier replaced by the user include copy paper, toner, toner collecting container, and staple cartridges for the optional finisher (AR-FN3).

For best copying results, be sure to use only Sharp products. The package of Sharp toner has the Genuine Supplies label.

SHARP®

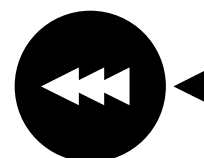

GENUINE SUPPLIES

Photoconductive drum

The AR-507 Copier has advanced process control technology which improves copy quality uniformity. This feature stabilizes copy quality throughout the life of the photoconductive drum by automatically compensating for the changes in drum characteristics due to wear, operator use patterns, and environmental conditions. The automatic adjustments are made in response to a sensor that detects the reflectance characteristics of the drum.

WARNING

This feature requires drums containing the special reflectance area (recommended Sharp genuine photoconductive drum), to prevent low image density copies from poor process control and possible damage to the machine. If you use other drums, the process control system cannot run properly.

Proper storage

- 1 Store the supplies in a location that is:**
 - clean and dry,
 - at a stable temperature,
 - not exposed to direct sunlight.

- 2 Store copy paper in the wrapper and lying flat.**
 - Paper stored in packages standing up or out of the wrapper may curl or become damp, resulting in paper misfeeds.

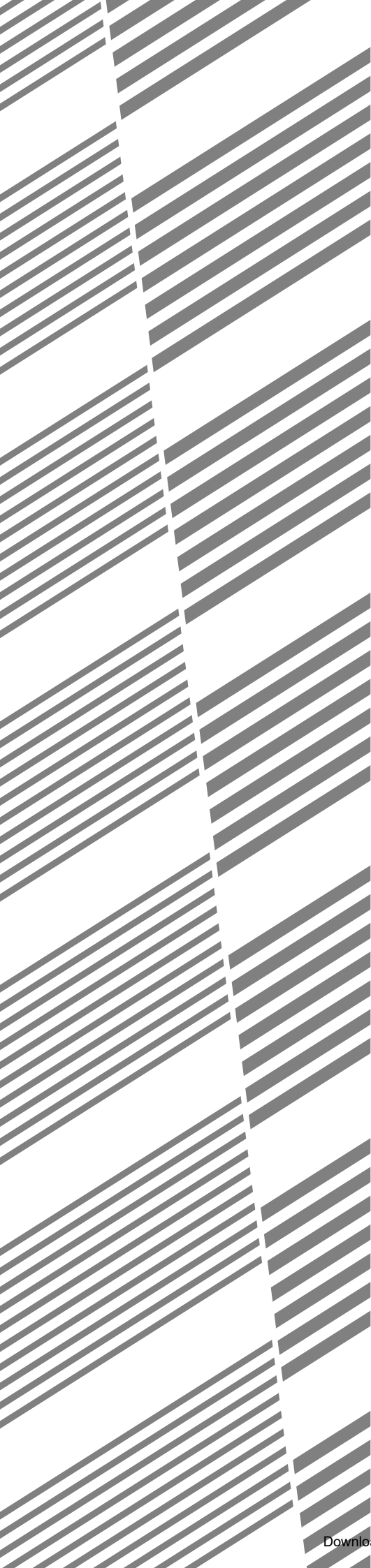

CHAPTER 5

COPIER TROUBLE?

This chapter describes how to remove misfed originals and paper and other common trouble remedies.

	Page
• MISFEED REMOVAL	5-2
• MAINTENANCE REQUIRED	5-13
• TROUBLESHOOTING	5-14

MISFEED REMOVAL

When a misfeed occurs, the copier will stop. The message "A MISFEED HAS OCCURRED. CLEAR INDICATED AREA. PRESS **i** FOR RECOVERY INSTRUCTIONS." will appear with a display of paper misfeed locations. Press the INFORMATION (**i**) key for more detailed information as necessary.

If paper becomes accidentally torn during removal, be sure to remove all pieces. Be careful not to damage the photoconductive drum or the corona wires.

First confirm the misfeed locations. For misfeeds in optional equipment, see their respective sections. (pages 7-14, 7-21, and 7-25)

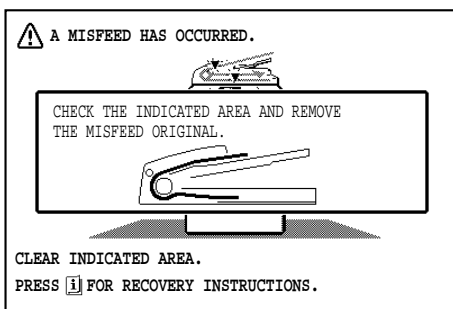
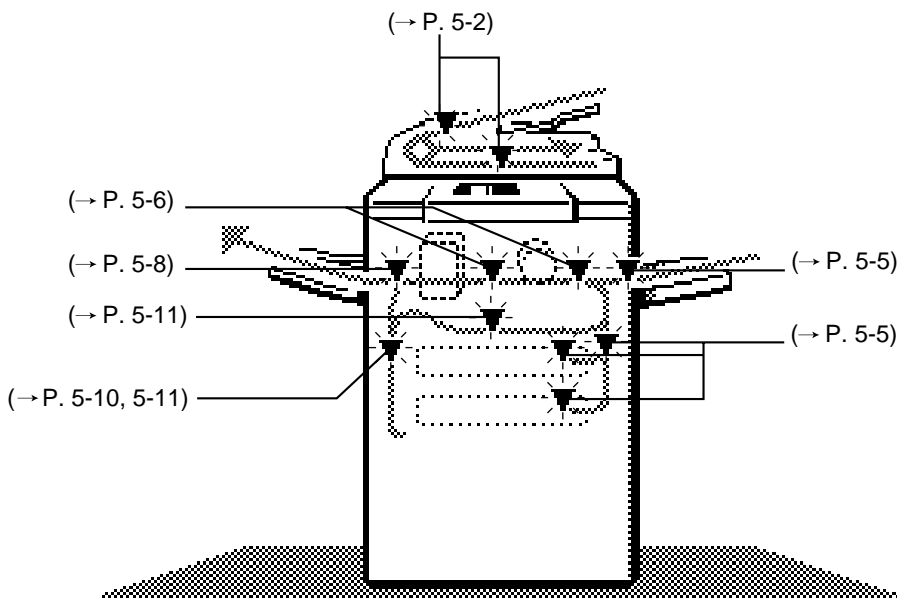

Misfeed in the RSPF

When the RSPF misfeeds an original sheet, the copier will stop and the misfeed message will appear. The misfeed message display varies with the misfed area.

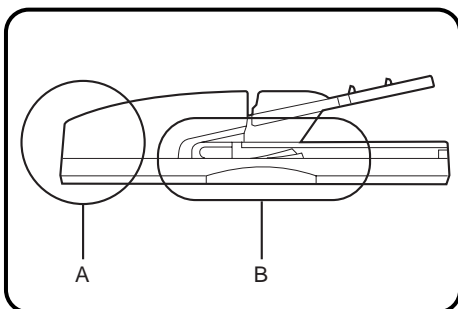

An original misfeed may occur at one of two locations: (A) in the RSPF feed section or (B) in the exit section.

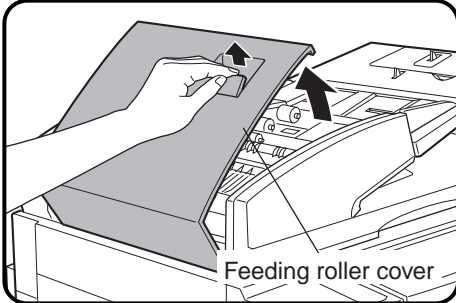

(A) Open the feeding roller cover.

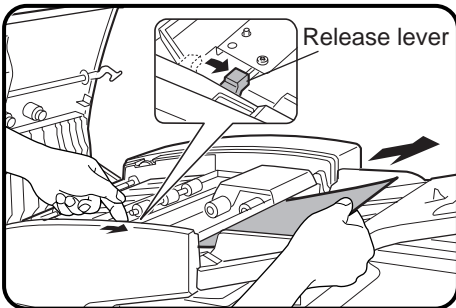

If a misfed original is in the feeding section:

Move the release lever in the direction of the arrow and remove the misfed original.

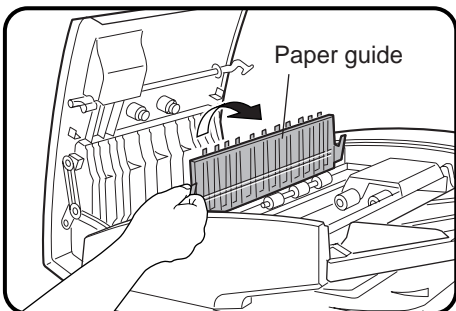

If a misfed original is in the transport section:

Open the paper guide.

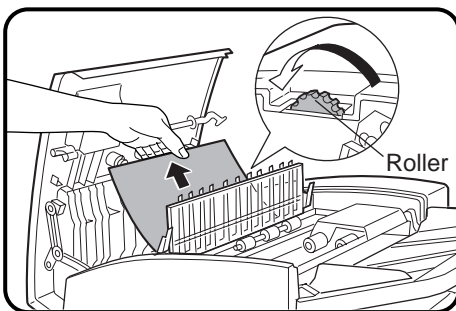

Rotate the roller in the direction of the arrow and gently remove the misfed original. Close the paper guide after removing the misfed original.

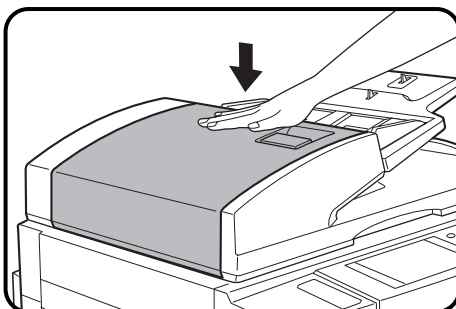

Close the feeding roller cover firmly by pressing in the middle of the cover.

- Be sure to open and close the document feeder to cancel the misfeed display.

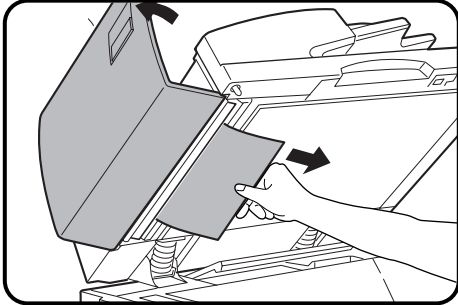

Open the document feeder and gently remove the misfed original.

- If the misfed original cannot be easily removed, open the feeding roller cover. Close the feeding roller cover firmly by pressing in the middle of the cover after removing the misfed original.

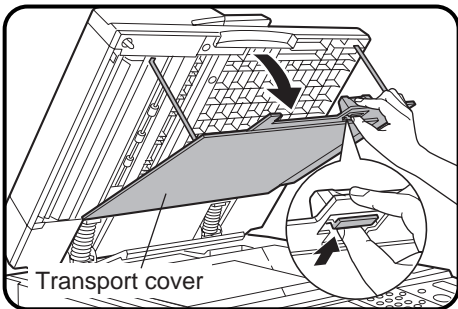

(B) Unlock the lever and open the transport cover.

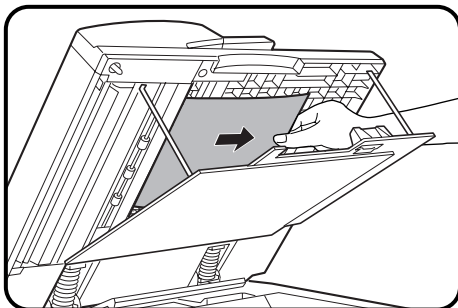

Gently remove the misfed original.

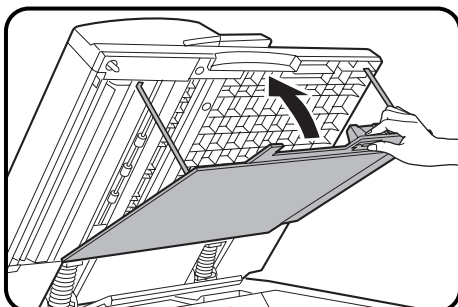

Close the transport cover and close the document feeder.

NOTE:

After misfed originals are removed from locations A and/or B, a message may appear indicating to return the originals to the document feeder tray. Return the originals and press the START (◊) key to resume copying.

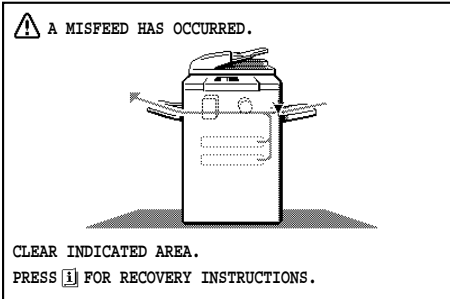

Misfeed in the bypass tray

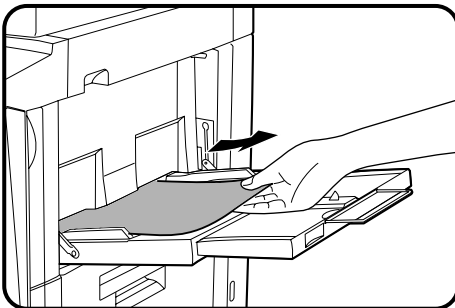

1 Gently pull the misfed paper out.

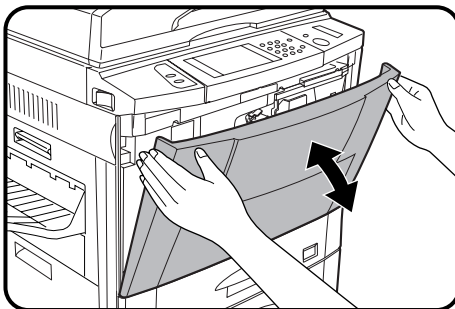

2 Open and close the front cover to cancel the misfeed display.

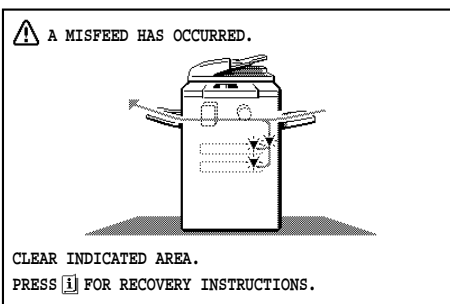

Misfeed in paper trays 1 and 2

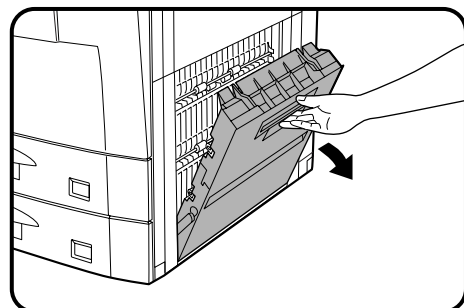

1 Open the right side cover.

- Hold the handle and gently open the cover.
- If any paper is set in the bypass tray, remove the paper and close the bypass tray before opening the right side cover.

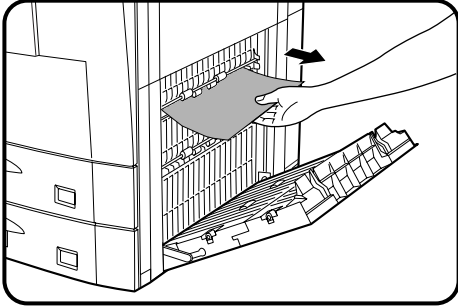

- 2** Remove the misfed paper.
- Be careful not to tear the misfed paper during removal.

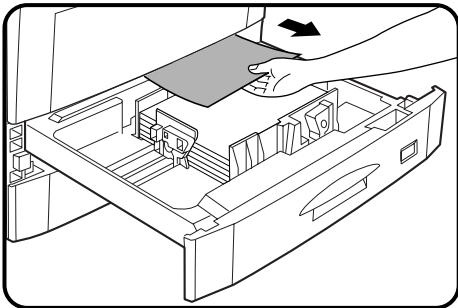

- 3** If the paper cannot be seen from the side, pull out the paper tray which was in use and remove the misfed paper.
- Be careful not to tear the misfed paper during removal.

NOTE:

If the paper misfed in tray 2 and the paper has dropped beyond the tray, remove the tray and remove the misfed paper. To remove the paper tray, pull the paper tray out until it stops and then lift and remove the paper tray.

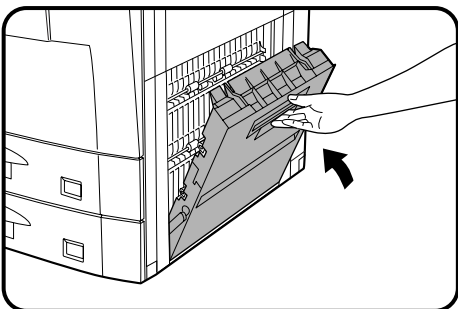

- 4** Close the paper tray and the side cover.

- 5** Open and close the front cover to cancel the misfeed display.
- Confirm that the misfeed display is cleared.

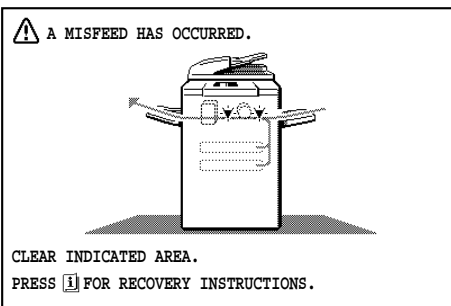

Misfeed in the transport area

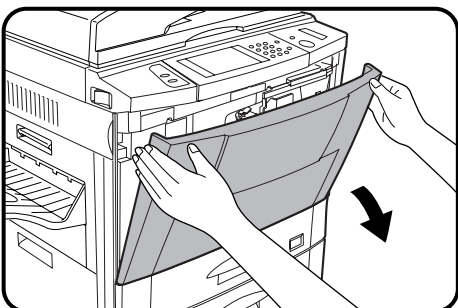

- 1** Open the front cover.

2 Remove the misfed paper.

- ① Turn the transport lever to the left.

CAUTION

The area behind the transport lever is hot. Use sufficient care in handling this lever.

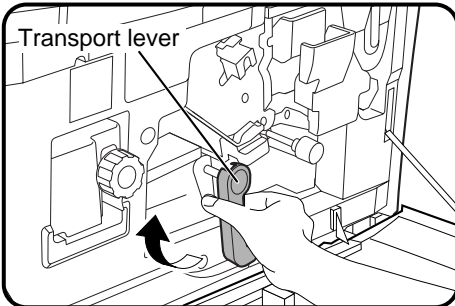

- ② Turn roller rotating knob Ⓐ in the direction of the arrow to remove the misfed paper.

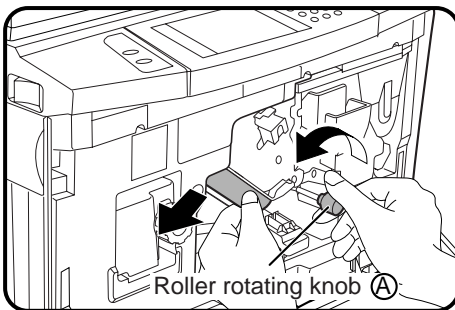

- Push down the paper guide and remove any misfed paper.

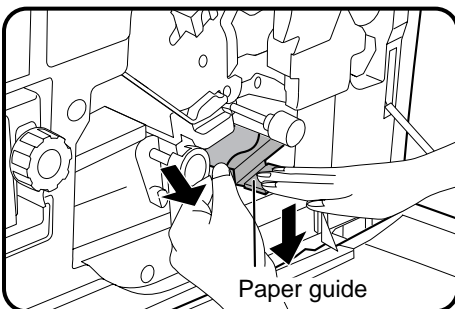

- ③ Turn the transport lever back into place.

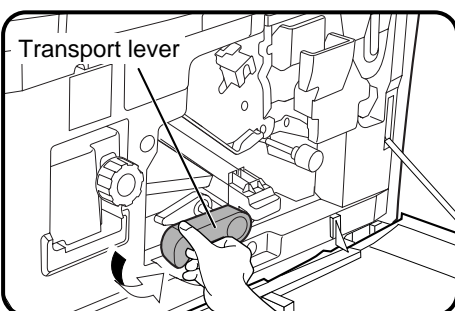

3 Close the front cover.

- Confirm that the misfeed display is cleared.

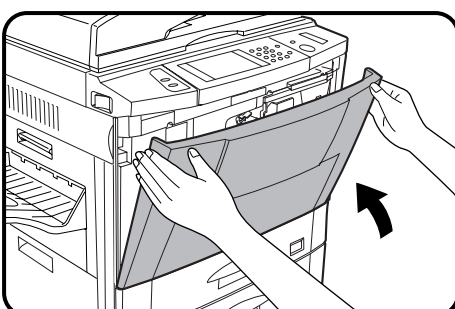

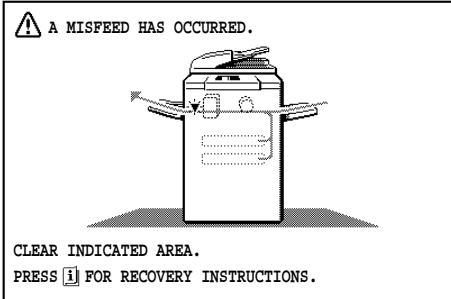

Misfeed around the fusing unit and exit area

NOTE:

If an optional finisher (AR-FN3) is fitted, please refer to chapter 7 Optional Equipment for additional misfeed removal help.

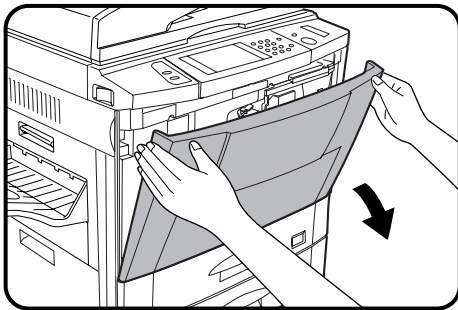

1 Open the front cover.

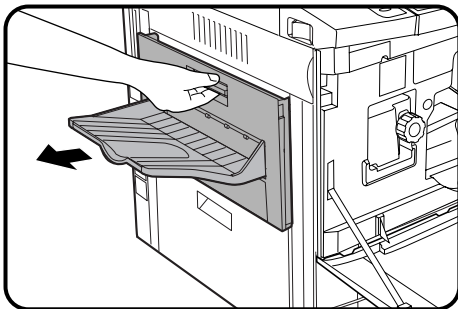

2 Open the exit area cover carefully.

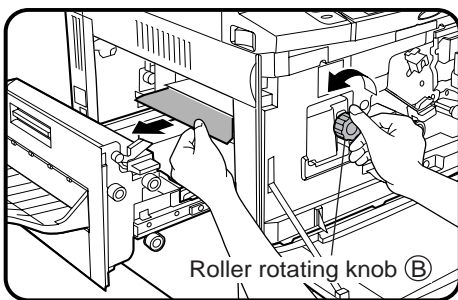

3 Remove the misfed paper.

If the misfed paper is in the inner part of the exit area:

① Turn roller rotating knob (B) in the direction of the arrow and remove the paper.

② If the misfed paper is deep in the fusing unit, lift the fusing unit tab and remove any misfed paper.

CAUTION

The fusing unit is hot! Be sure to touch only the green tab or the green roller rotating knob.

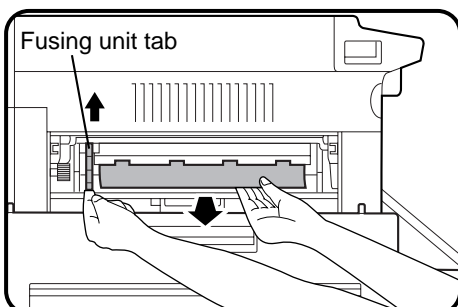

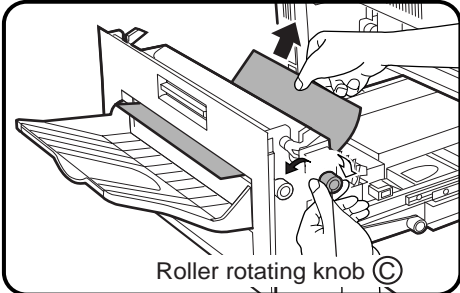

If the misfed paper is in the exit area:

- ① Turn roller rotating knob © and remove the paper.

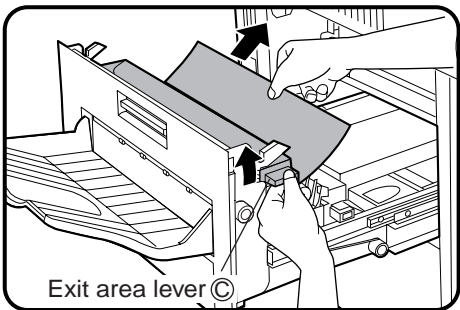

- ② If the misfed paper cannot be removed in step ①, raise exit area lever © and remove the paper.

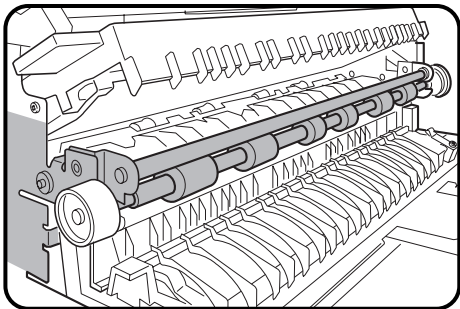

CAUTION

The part of exit area shown in the illustration may be hot. Use sufficient care not to touch it.

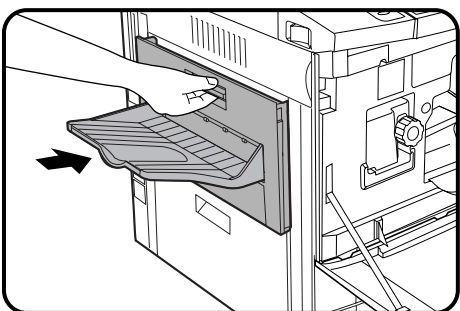

- 4** Close the exit area cover.

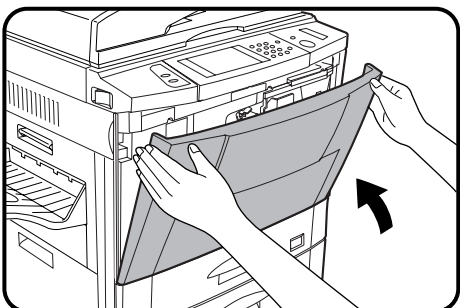

- 5** Close the front cover.
 - Confirm that the misfeed display is cleared.

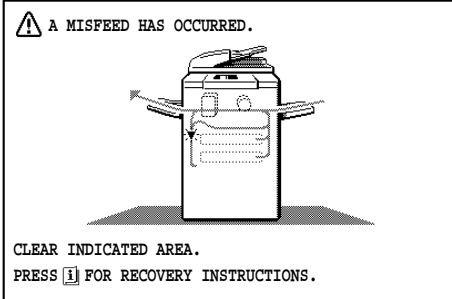

Misfeed in the reversing area

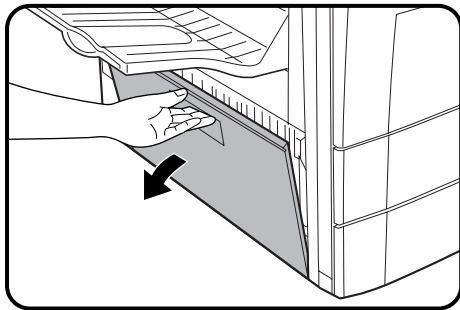

1 Open the left side cover.

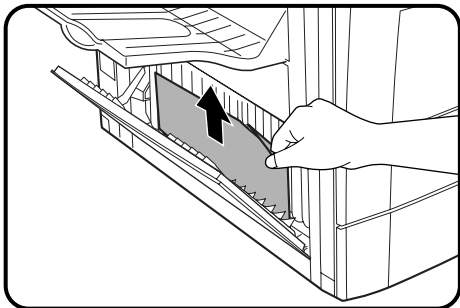

2 Gently remove the misfed paper.

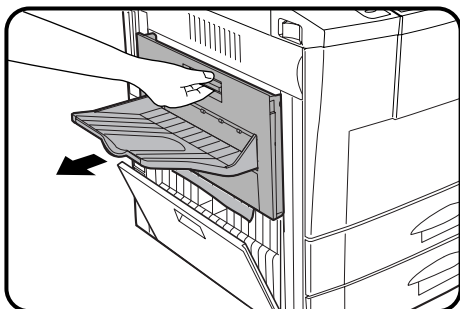

- Open the exit area cover carefully.

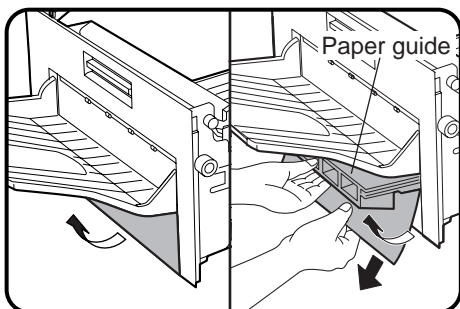

① Raise the paper guide and gently remove the misfed paper.

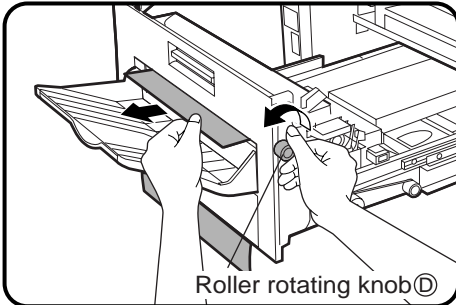

Roller rotating knob ①

② If the misfed paper cannot be removed in the previous step, turn roller rotating knob ① in the direction of the arrow and remove the paper.

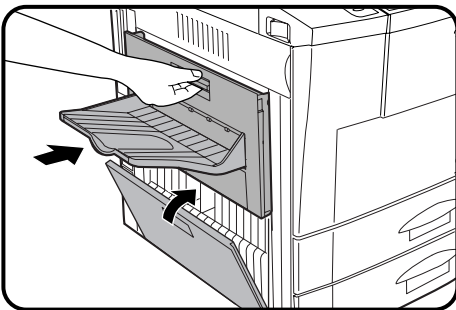

3 Close the exit area cover and the left side cover.

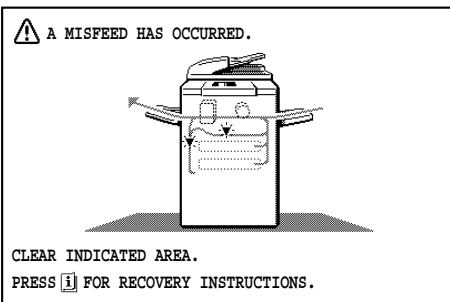

Misfeed in the duplex module

Also see Misfeed around the Fusing Unit and Exit Area (p.5-8) and Misfeed in the Reversing Area (p.5-10).

If the misfed paper is in the duplex module or the section below the exit area:

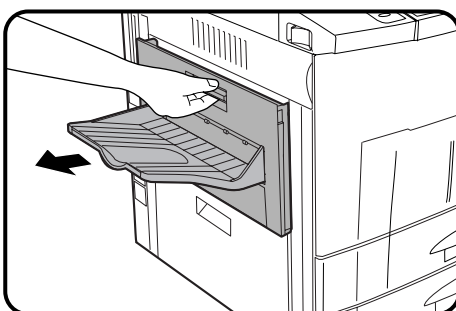

1 Open the exit area cover carefully.

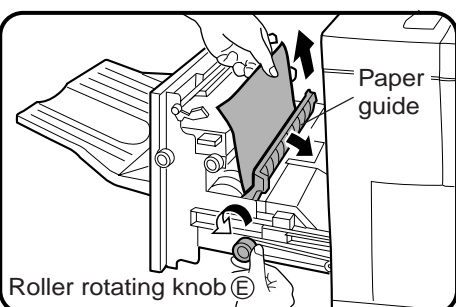

Roller rotating knob ②

2 Remove the misfed paper.

① Open the paper guide, turn roller rotating knob ② in the direction of the arrow and remove the misfed paper. Close the paper guide.

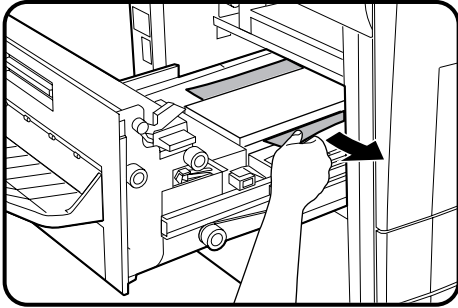

- ② Remove any misfed paper from the duplex module.
 - Be careful not to tear the misfed paper during removal.

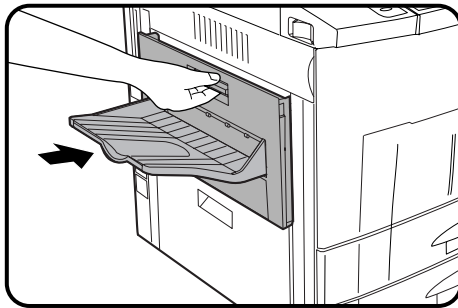

3 Close the exit area cover.

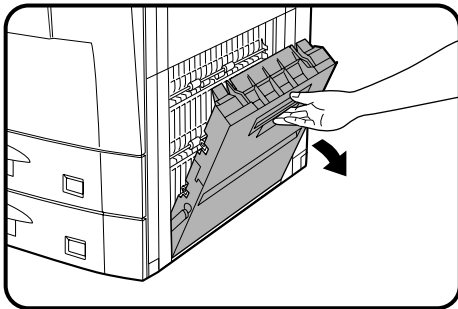

If the misfed paper is in the right side of the duplex module:

1 Open the right side cover.

- Hold the handle and gently open the cover.
- If any paper is set in the bypass tray, remove the paper and close the bypass tray before opening the right side cover.

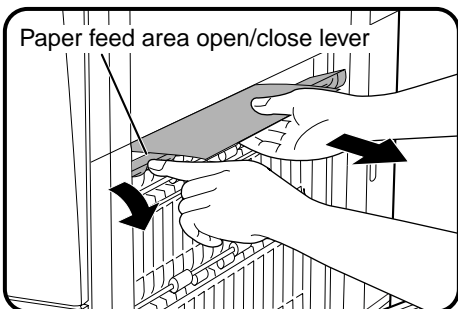

2 Remove the misfed paper.

- Move the paper feed area open/close lever in the direction of the arrow and remove the misfed paper.

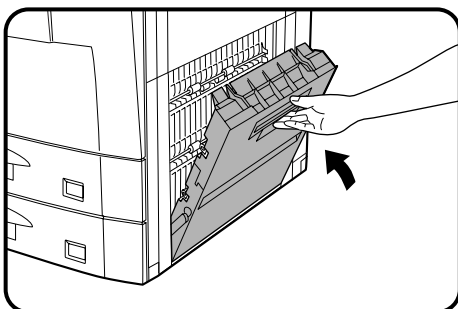

3 Close the right side cover.

4 Open and close the front cover to cancel the misfeed display.

- Confirm that the misfeed display is cleared.

MAINTENANCE REQUIRED

When the message “**READY TO COPY. (MAINTENANCE REQUIRED)**” appears in the message display, service by an authorised Sharp Service Technician will be required soon. Contact your Service Centre as soon as possible.

TROUBLESHOOTING

Always check the message display whenever the copier stops or operation is not possible. The messages will give you easy-to-follow directions. If the messages do not give specific instructions, check the list below.

Problem	Solution	
Copier does not operate.	● Copier plugged in?	Plug the copier into a grounded outlet.
	● Power switch on?	Turn the power switch on.
Copies are too dark or too light.	● Copy density properly adjusted?	See page 2-16.
Blank copies.	● Is the original placed face up in the document feeder tray or face down on the document glass?	Place the original face up in the document feeder tray or face down on the document glass.
Copies smear if rubbed.	● Paper too heavy?	Use copy paper within the specified range. See page 4-2.
	● Paper damp?	Replace with dry copy paper. Be sure to store copy paper in a dry location.
Copy size is different from the selected paper size.	● Paper size indicator properly set?	When changing the copy paper size in a tray, be sure to adjust the paper size indicator. See page 4-4.
Desired image position on copy cannot be obtained.	● Is same-size copying onto different size paper or enlargement copying performed?	Rotate the original in the RSPF or on the document glass. See page 2-3. Be careful if using the optional staple sort mode.
Paper misfeeds frequently.	● Non-standard paper used?	Use standard paper. If using special papers, feed the paper through the bypass tray.
	● Is paper properly installed?	See pages 2-14 and 4-2.
	● Pieces of paper inside copier?	Remove all pieces of misfed paper. See page 5-2.
	● Paper curled or damp?	Store copy paper flat in the wrapper in a dry location. See page 4-8.

Problem	Solution	
Dust, dirt, smudges appear on copies.	<ul style="list-style-type: none"> Document glass, documentfeeder dirty? 	Clean regularly. See page 6-6.
Black lines appear on copies when using RSPF.	<ul style="list-style-type: none"> Is the scanning section glass or the scanning guide of the RSPF dirty? 	Clean regularly. See page 6-6.
Touch panel is too dark or too light.	<ul style="list-style-type: none"> Is LCD contrast properly adjusted? 	Adjust the LCD contrast. See page 6-7.
“CHECK THE SUB MACHINE.” message appears and the tandem copying does not start.	<ul style="list-style-type: none"> Some message appears on the touch panel of the sub copier? 	Follow the message on the sub copier to solve the problem.
“THE SYSTEM IS NOT CONFIGURED TO PERFORM TANDEM JOB. CODE: XX” message appears and the tandem copying can not be performed.	<ul style="list-style-type: none"> The same options are equipped for the main and sub copiers? 	Tandem copying is not performed unless the same options are equipped for both main and sub copiers.
	<ul style="list-style-type: none"> The settings in the following key operator programs are different on the main and sub copiers: <ul style="list-style-type: none"> * Disabling of Duplex Copying (error code No. 51) * Disabling of Stapler (error code No. 52) * HDD-Data Auto Clear Function (with an optional Data Security Kit) 	Tandem copying is not performed unless the settings in these key operator programs are the same on both main and sub copiers.

If a problem persists after checking the above, please consult your key operator prior to contacting your authorised Sharp Service Centre.

Self-diagnostic function

An automatic self-diagnostic function is built into this copier. Should the copier malfunction, the self-diagnostic function will locate the problem and stop the copier to prevent damage. An alphanumeric code will appear in the message display.

Example

Should the copier stop completely, and the message “CALL FOR SERVICE. CODE: □□” appear in the message display, contact your authorised Sharp Service Centre.

★ **KEY OPERATOR** See page 8-31.

CHAPTER 6

GENERAL INFORMATION

This chapter describes general information for using this copier.

	Page
• PART NAMES AND FUNCTIONS	6-2
Exterior	6-2
Interior	6-3
Operation panel	6-4
Touch panel (Basic screen)	6-5
• USER MAINTENANCE	6-6
• TOUCH PANEL CONTRAST ADJUSTMENT	6-7
• SPECIFICATIONS	6-8

PART NAMES AND FUNCTIONS

Exterior

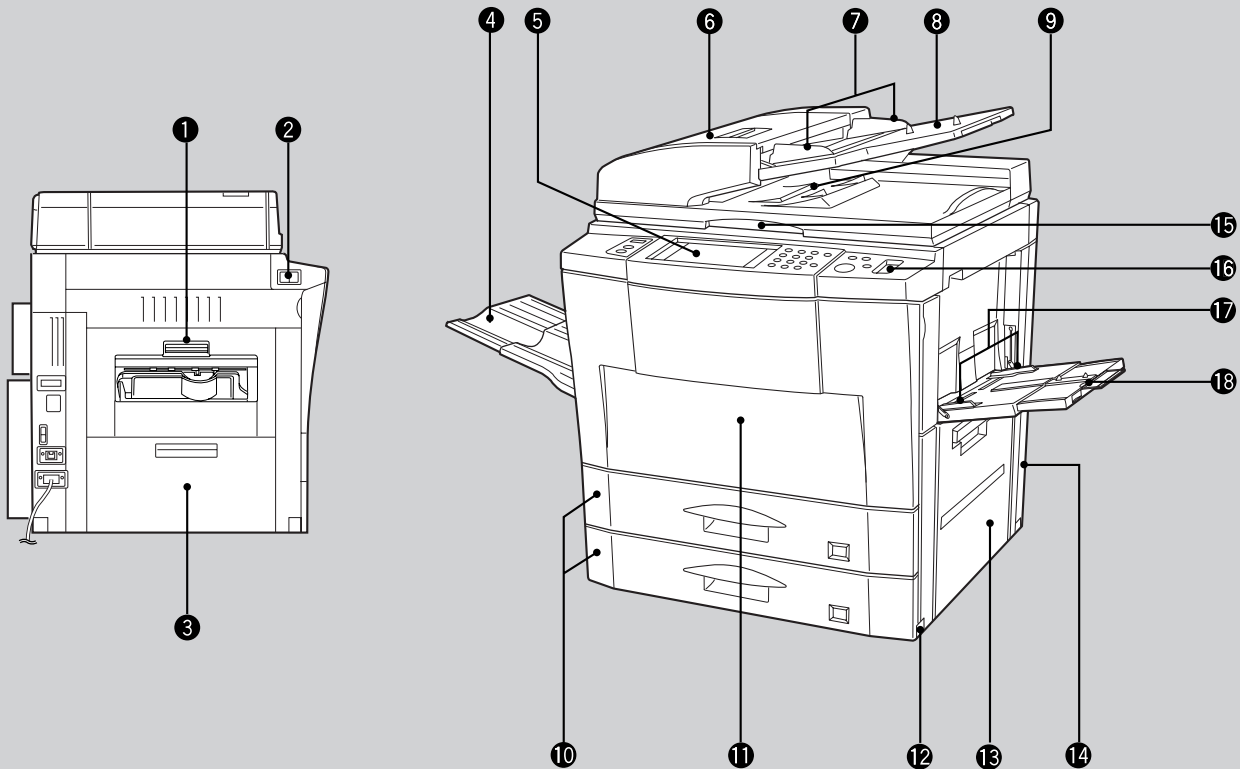

- 1 Exit area cover**
Open to remove misfed paper.
- 2 Power switch**
Press to turn copier power on and off.
- 3 Left side cover**
Open to remove misfed paper.
- 4 Exit tray (optional)**
Finished copies are deposited in the exit tray.
- 5 Operation panel**
All copier controls are located here for easy operation.
- 6 RSPF feeding section cover**
Open to remove misfed originals.
- 7 Original guides**
Adjust to the size of the originals.
- 8 Document feeder tray**
Holds up to 50 originals.
- 9 RSPF exit area**
Finished originals are output here.
- 10 Paper trays**
Each tray holds 500 sheets of paper.
- 11 Front cover**
Open to remove misfeeds and to service the copier.
- 12 Handles**
- 13 Right side cover**
Open to remove misfeeds in the paper feed area.
- 14 Toner collecting container cover**
Open to replace the toner collecting container.
- 15 Document glass**
All originals which cannot be copied from the RSPF must be copied here.
- 16 Paper clip tray**
Keep paper clips here.
- 17 Bypass tray paper guides**
Adjust to the width of the copy paper.
- 18 Bypass tray**
Special papers (including transparency film) and copy paper can be fed from the bypass tray.

Interior

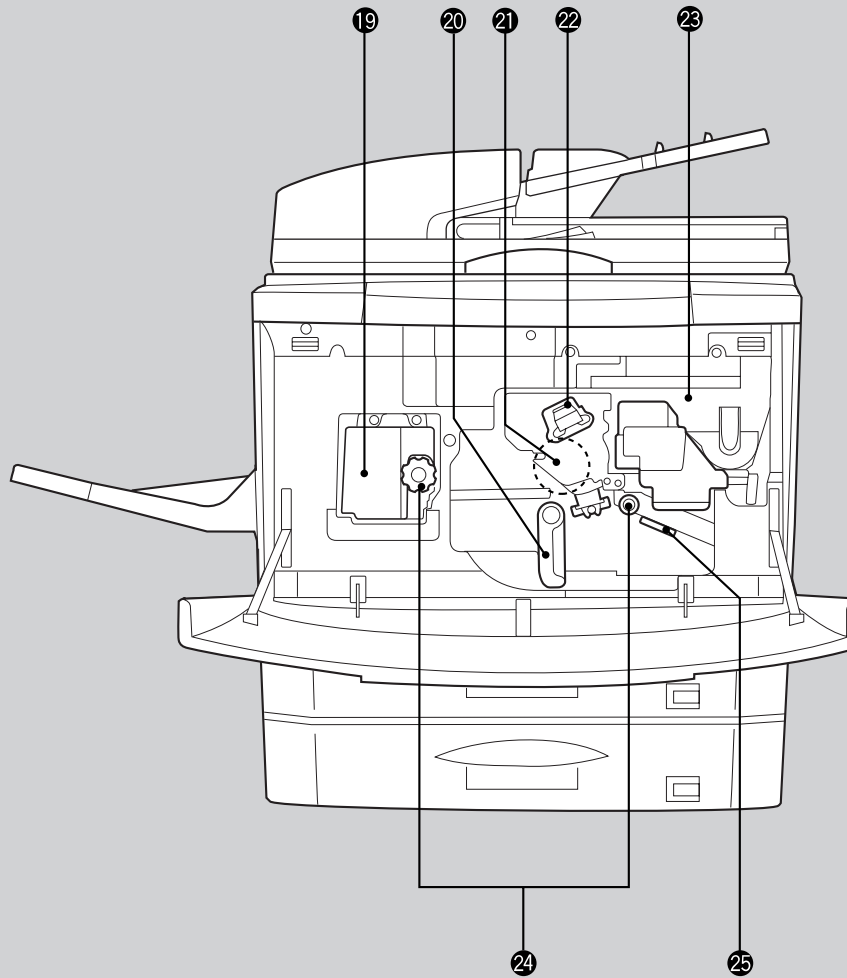

- 19 Fusing unit**
The fusing unit is hot. Exercise care in this area.
- 20 Transport lever**
Turn to open the transport section.
- 21 Photoconductive drum**
Copy images are formed on the photoconductive drum.
- 22 Corona unit**
The unit is used to charge the photoconductive drum.
- 23 Toner hopper**
Contains toner.

- 24 Roller rotating knobs**
Turn to remove misfed paper.
- 25 Paper guide**
Push down to remove misfed paper.

Accessories	
Operation manual	1
Toner collecting containers (including 1 pre-installed at the factory)	3

PART NAMES AND FUNCTIONS

Operation Panel

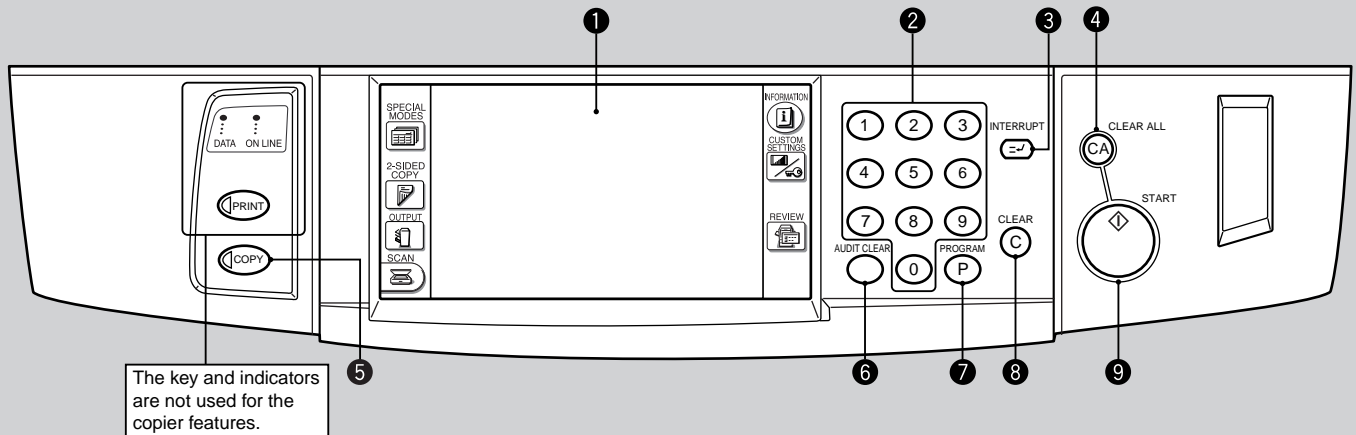

1 LCD touch panel

Displays information to assist the operator. Various operation keys are included in the touch panel depending on the particular screen being displayed.

2 10-key pad

Used to set the copy quantity.

3 INTERRUPT (≡) key and indicator (p. 2-20)

Interrupts a copy run.

4 CLEAR ALL (CA) key

Clears all selected settings and returns the copier to the initial settings.

5 COPY key

Press during standby to display the total output count.

6 AUDIT CLEAR (ACC.#-C) key

Closes an open account.

7 PROGRAM (P) key (p. 2-18)

Press to select the job memory mode.

8 CLEAR (C) key

Press to clear the copy quantity display, or press during a copy run to terminate copying. The copier will stop after copies in progress are finished.

9 START (◇) key and indicator

Copying is possible when the indicator is on. Press to start copying.

10 SPECIAL MODES key (p.3-1)

Press to select special functions.

11 Message display

Messages are displayed regarding copier status and operation.

12 Function setting icons (p.1-9)

Icons appear depending on the special functions selected.

13 Paper size display

The sizes of loaded copy paper are displayed and the selected paper feed location is highlighted.  indicates the amount of copy paper.

14 Copy quantity display

Displays the specified number of copies.

15 Original size display

The original paper size is displayed.

16 INFORMATION (i) key (p. 1-7)

Press for operation guidance on use of various features of this copier. Press for guidance when a misfeed occurs, when adding toner, or when used toner must be disposed of.

Touch Panel (Basic screen)

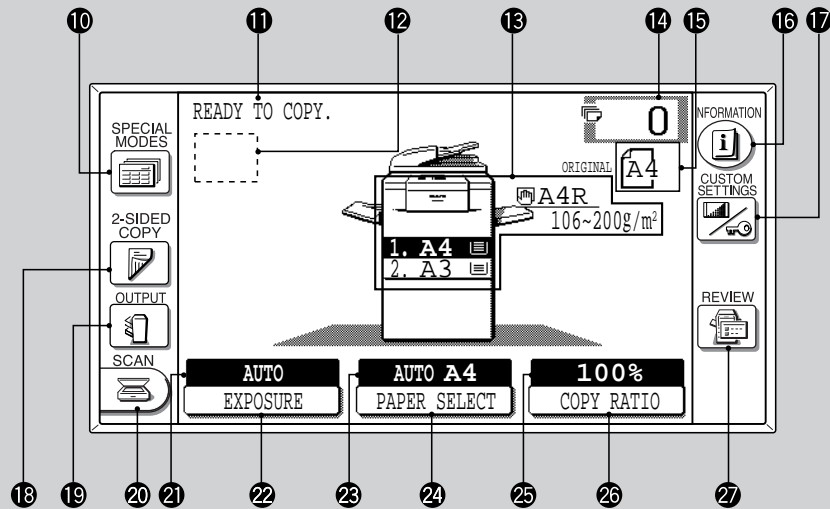

17 CUSTOM SETTINGS () key

Press to set key operator programs or adjust the contrast of the touch panel.

18 2-SIDED COPY key

Press to select the 1-sided to 1-sided, 1-sided to 2-sided, 2-sided to 1-sided or 2-sided to 2-sided copy mode.

19 OUTPUT key

Press to select the finisher mode: SORT or GROUP.

20 SCAN key

Press to select the network scanner function. (Optional Printer Expansion Kit and Network Scanner Expansion Kit must be installed.)

21 EXPOSURE display

Indicates the selected exposure mode.

22 EXPOSURE key (p. 2-16)

Press to select the exposure mode: AUTO, TEXT, TEXT/PHOTO, or PHOTO.

23 PAPER SELECT display

Displays the selected paper size. When "AUTO" is displayed, paper size matching the original and copy ratio will be automatically selected.

24 PAPER SELECT key

Press to select the desired paper tray.

25 COPY RATIO display

Displays the copy ratios for reductions or enlargements.

26 COPY RATIO key

Press to select a reduction or enlargement copy ratio or select the automatic copy ratio selection mode.

27 REVIEW () key

Press to check the settings of selected functions.

Initial settings

The copier assumes the initial settings when it is turned on, when the CLEAR ALL () key is pressed, and approximately 1 minute after the last copy is made in any mode.

- Copy ratio: 100%
- Automatic exposure
- Copy quantity: 0
- All special copier modes are set to off.
- Tray select: Paper tray 1
Optional large capacity tray will be selected when installed.

★ **KEY OPERATOR** *Initial settings can be programmed as desired. The auto clear time can also be changed. See pages 8-19 and 8-23.*

USER MAINTENANCE

The document glass and the document feeder cover must be kept clean to avoid dirty areas from being copied onto the copies.

Document glass and document feeder cover

Wipe the document glass and the document feeder cover with a soft, clean cloth.

- If necessary, dampen the cloth with water. Do not use thinner, benzene, or similar volatile cleaning agents.

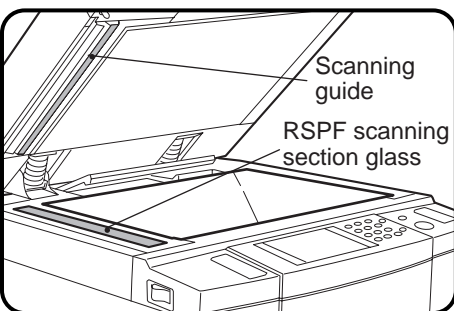
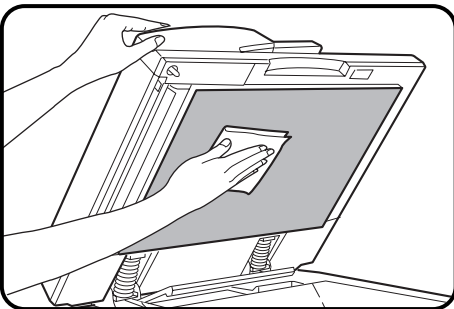
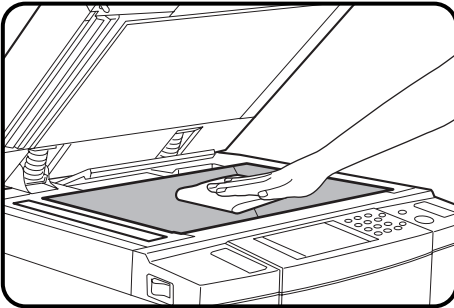

RSPF scanning section

- If black lines appear on copies when copying with the RSPF, wipe the parts shown in the illustration with a soft, clean cloth dampened with plain water or water containing a small amount of neutral detergent.

TOUCH PANEL CONTRAST ADJUSTMENT

The contrast of the touch panel can be adjusted as below.

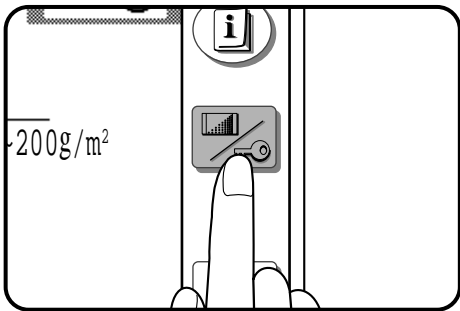

1 Press the CUSTOM SETTINGS () key.

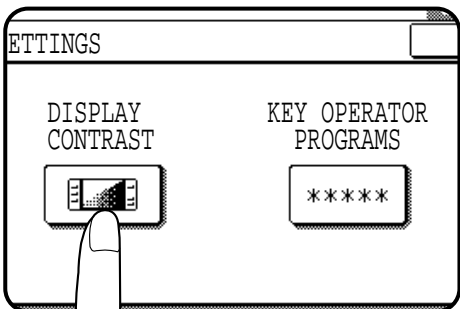

2 Press the “DISPLAY CONTRAST” key on the touch panel.

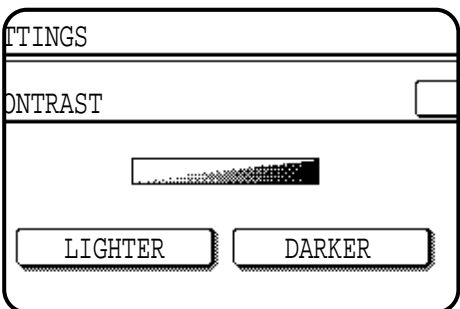

3 Press the “LIGHTER” or “DARKER” key to adjust the contrast.

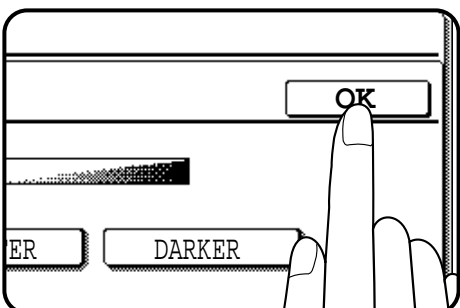

4 Press the “OK” key.

SPECIFICATIONS

COPIER

Type	Desktop
Copy system	Dry, electrostatic transfer system
Originals	Sheets, bound documents
Original feed system	Reversing single pass feeder (RSPF)
Original sizes	Max. A3 (11" x 17")
Copy sizes	Max. A3 (11" x 17"), min. A6 (5-1/2" x 8-1/2") Image loss: Max. 5 mm (13/64") (both leading and trailing edges) Max. 5 mm (13/64") (along all other edges in total) For paper weight, see page 4-2.
Copying speed (at 100% copy ratio)	50 copies/min. (A4 (8-1/2" x 11")) 35 copies/min. (A4R (8-1/2" x 11"R)) 29 copies/min. (B4 (8-1/2" x 14")) 25 copies/min. (A3 (11" x 17"))
Continuous copy	Max. 999 copies; subtractive counter
First-copy time*	Approx. 4.3 sec.
Warm-up time	Less than 150 sec.
Copy ratio	Variable: 25 to 400% in 1% increments, total 376 steps (can be set in the horizontal and vertical directions independently) Fixed presets: 25%, 50%, 70%, 81%, 86%, 100%, 115%, 122%, 141%, 200%, 400% (25%, 50%, 64%, 77%, 95%, 100%, 121%, 129%, 141%, 200%, 400%)
Exposure system	Document glass: Moving optical source (stationary platen) with automatic exposure function RSPF: Moving original
Copy paper feed	Two paper trays with automatic paper feed (500 sheets each); one bypass tray with 50-sheet automatic feed capability
Fusing system	Heat rollers
Developer system	Magnetic brush development
Light source	Xenon lamp
Resolution	Scan: 400 dpi Output: 600 dpi
Gradation	Scan: 256 levels Output: 2 levels (normal copying)
Required power supply	Local voltage $\pm 10\%$ (For this copier's power supply requirements, see the name plate located on the left hand side at the rear corner of the copier.)

* When the copier is in the noise level reduce mode, the first copy time will be several seconds longer.

Power consumption	Max. 1.94 kW
Overall dimensions	1292 mm (W) x 700 mm (D) (50-7/8" (W) x 27-9/16" (D))
Weight	Approx. 102 kg (225 lbs.)
Copier dimensions	600 mm (W) x 700 mm (D) x 773 mm (H) (23-5/8" (W) x 27-9/16" (D) x 30-7/16" (H))
Operating conditions	Temperature: 15°C to 30°C (59°F to 86°F) Humidity: 20% to 85%
Optional equipment	Finisher (AR-FN3) Large capacity tray (AR-LC1N) Stand/500-sheet paper drawer (AR-DE7) 500-sheet paper drawer (AR-CS3) Exit tray (AR-TE1) Tandem-connection cable (AR-CA1) Printer expansion kit (AR-PB2A) Printer server card (AR-NC3D) Network scanner expansion kit (AR-NS1)

DOCUMENT FEEDER

Type	Reversing single pass feeder (RSPF)
Acceptable originals	
Weight:	Single-sided originals: 50 to 128 g/m ² (14 to 34 lbs.) Two-sided originals: 50 to 110 g/m ² (14 to 29 lbs.)
Size:	A5 to A3 (5-1/2" x 8-1/2" to 11" x 17")
Capacity:	Up to 50 sheets for 50 to 80 g/m ² (14 to 21 lb.) originals. For originals heavier than 80 g/m ² (21 lbs.), the total aggregate thickness must not exceed 6mm or 15/64".

DUPLEX MODULE

Paper type	Ordinary paper only
Number of copies	1 (trayless system)
Copy paper size	A5, A4, A4R, B4, A3 (8-1/2" x 11", 8-1/2" x 11"R, 8-1/2" x 14", 11" x 17")
Copy paper weight	56 to 105 g/m ² (15 lbs. to 28 lbs.)

Specifications are subject to change for improvement without notice.

CHAPTER 7

OPTIONAL EQUIPMENT

This chapter describes operating instructions for the Finisher (AR-FN3), Large Capacity Tray (AR-LC1N) and Stand/500-sheet Paper Drawer (AR-DE7) .

	Page
• SYSTEM CONFIGURATION	7-2
• FINISHER (AR-FN3)	7-3
Part names	7-3
Specifications	7-3
Offset stack	7-4
Sort and group	7-5
Staple sort	7-6
Staple cartridge replacement	7-10
Staple jam removal	7-12
Misfeed removal	7-14
• LARGE CAPACITY TRAY (AR-LC1N)	7-19
Part names	7-19
Specifications	7-19
Loading copy paper	7-20
Misfeed removal	7-21
• STAND/500-SHEET PAPER DRAWER (AR-DE7)	7-23
Part names	7-23
Specifications	7-23
Loading copy paper	7-24
Misfeed removal	7-25

SYSTEM CONFIGURATION

The options which are available for this copier are shown below.

Finisher (AR-FN3)

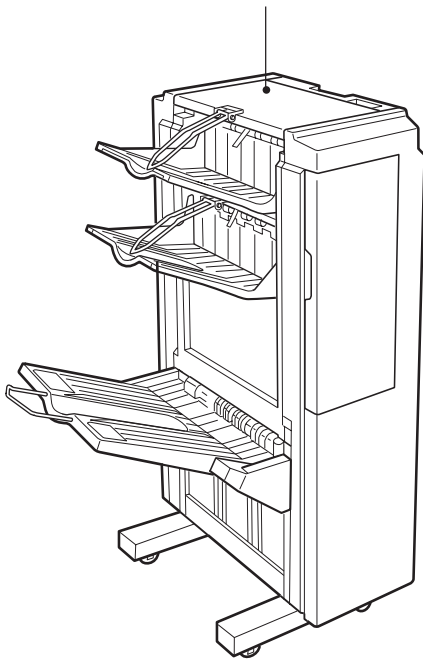

Large capacity tray (AR-LC1N)

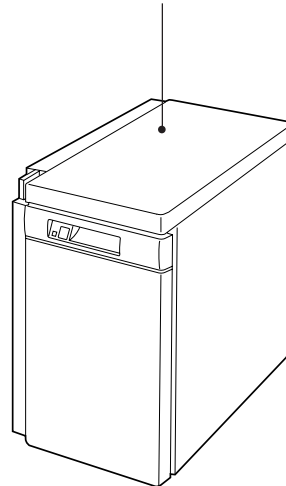

Exit tray (AR-TE1)

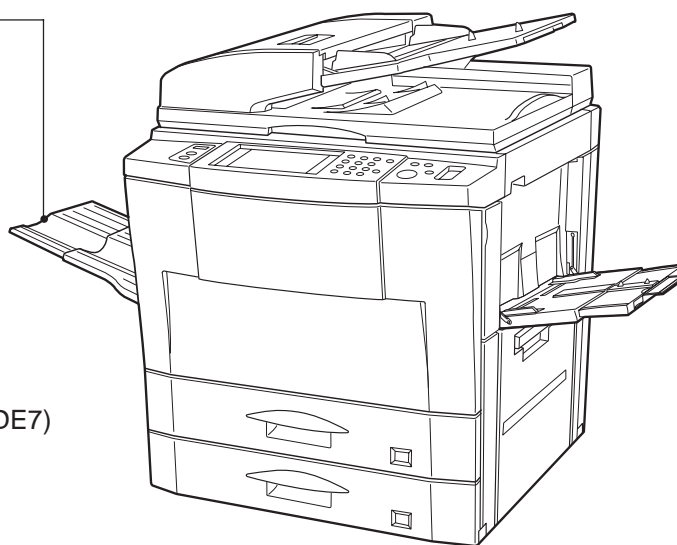

Stand/500-sheet paper drawer (AR-DE7)

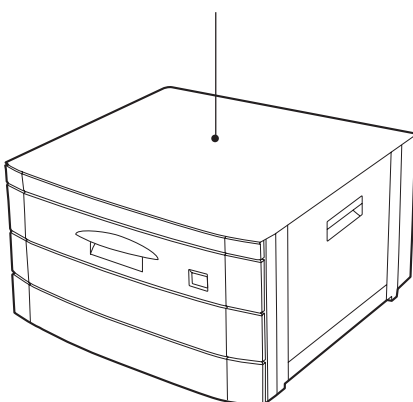

500-sheet paper drawer (AR-CS3)

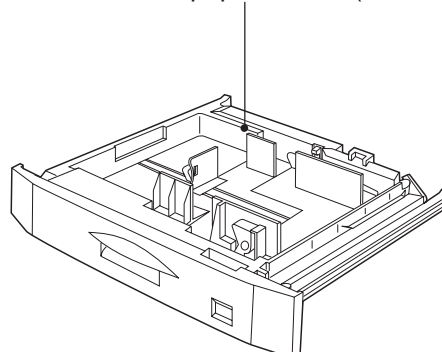

Printer expansion kit (AR-PB2A)
Printer server card (AR-NC3D)
Network scanner expansion kit (AR-NS1)
Tandem-connection cable (AR-CA1)
Data security kit 3 (AR-FR3) *

* This equipment may not be available in some regions.

FINISHER (AR-FN3)

The copier has two different finisher modes: one sorts copies into sets matching the sequence of the originals and the second groups copies by original. When an optional finisher (AR-FN3) is installed, copy sets can be automatically stapled. Unstapled sets or groups of copies can be stacked offset from the previous set or group.

PART NAMES

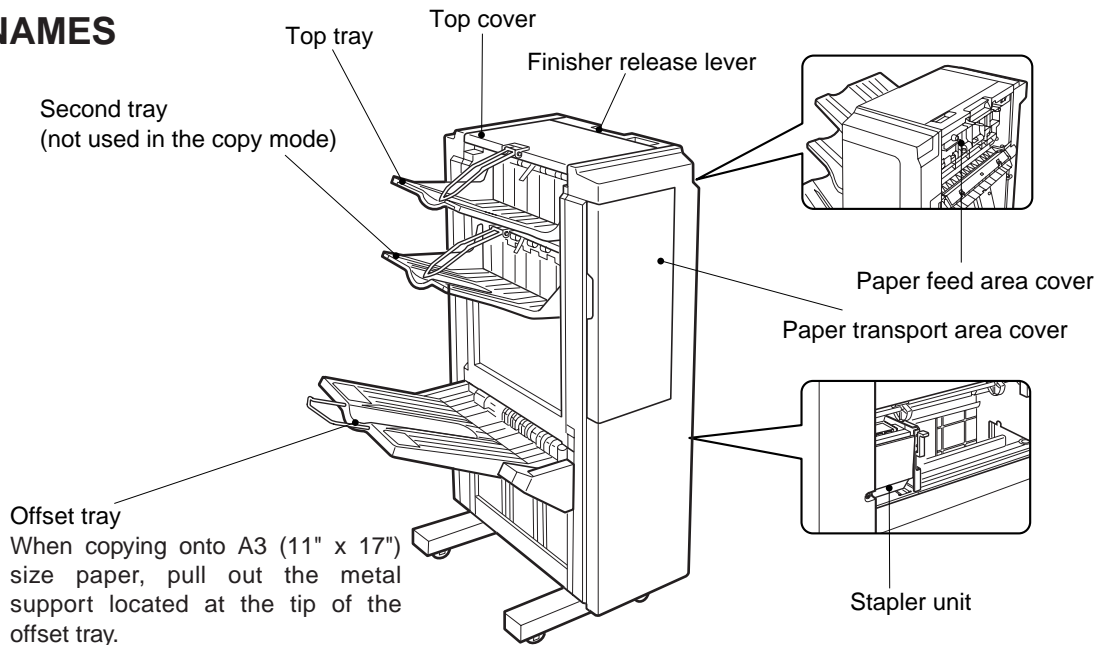

- The top tray and second tray are each furnished with an extendable component, which is to be used when copying onto A3 (11" x 17") size paper.

Specifications

Tray capacity	Top tray: 500 sheets Second tray: 500 sheets Offset tray: 1,500 sheets (A4 (8-1/2" x 11")) 750 sheets (larger than A4 (8-1/2" x 11"))
Paper size	Top tray: A6 to A3 (5-1/2" x 8-1/2" to 11" x 17") Second tray: A5 to A3 (5-1/2" x 8-1/2" to 11" x 17") Offset tray: A4 to A3 (8-1/2" x 11" to 11" x 17")
Paper weight	Top tray: 52 to 128 g/m ² , 176 g/m ² , 200 g/m ² (14 lbs. to 34 lbs., 47 lbs., 53 lbs.) Second tray: 64 to 105 g/m ² (17 lbs. to 28 lbs.) Offset tray: 64 to 128 g/m ² (17 lbs. to 34 lbs.) For paper weighing more than 105 g/m ² (28 lbs.), A4 (8-1/2" x 11") is the maximum size.
Offset	30 mm (1.2 inch)
Paper size for stapling	A4, A4R, B4, A3 (8-1/2" x 11", 8-1/2" x 11"R, 8-1/2" x 14", 11" x 17")
Stapling capacity	50 sheets (80 g/m ² (21 lbs.)) (25 sheets for B4 and A3 (8-1/2" x 14" and 11" x 17") paper)
Power supply	Drawn from the copier
Weight	Approx. 52 kg (115 lbs.)
Dimensions	590 mm (W) x 560 mm (D) x 998 mm (H) (23-15/64"(W) x 22-1/16"(D) x 39-19/64"(H))

Specifications are subject to change for improvement without notice.

Offset stack

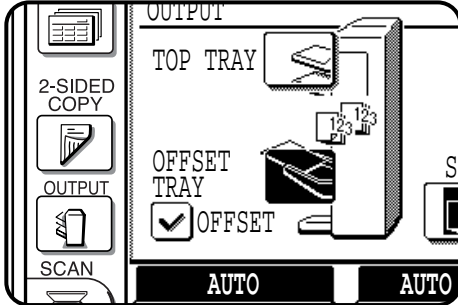

In the initial setting, the offset tray will move from side to side so that each copy set is offset by approximately 30 mm (1.2 inch).

When the offset stack function is disabled, the offset tray will not move from side to side.

The offset stack function can be enabled or disabled by pressing the OUTPUT key and then the "OFFSET" check mark box on the touch panel.

When the STAPLE SORT mode is selected, the offset stack function will be disabled.

The top tray cannot be used to offset copies.

To select the top tray, press the "TOP TRAY" key on the touch panel.

If the offset tray is selected, copies will be always delivered face down. If the top tray is selected, copies will be delivered face up or face down depending on copying settings.

NOTE:

When copying from the bypass tray onto special papers, be sure to select the top tray. If the offset tray is selected, a misfeed may occur.

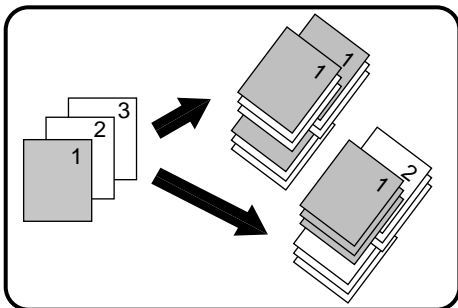

OFFSET mode

When copying in the SORT mode, each collated set of copies will be stacked offset approximately 30 mm (1.2 inch) from the previous set. When copying in the GROUP mode, copies will be offset stacked in groups of multiple copies from the same original.

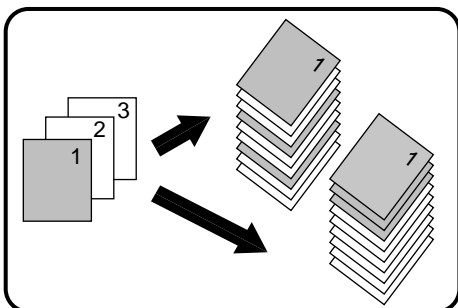



NON-OFFSET mode

All copies will be aligned in one stack in the offset tray or the top tray with no offset.

Sort and group

When SORT is selected, the SORT () icon will be indicated and copies will be collated by sets.

When STAPLE SORT is selected, the STAPLE SORT () icon will be indicated and collated copies will be stapled automatically.

When the GROUP () icon is indicated on the touch panel, copies will be grouped by originals.

To change the finisher mode, press the OUTPUT key and then select the desired mode on the touch panel.

- When the RSPF is used for copying, copies will be collated in the OFFSET mode as the default setting.
When the document glass is used for copying, copies will be grouped in the OFFSET mode as the default setting.

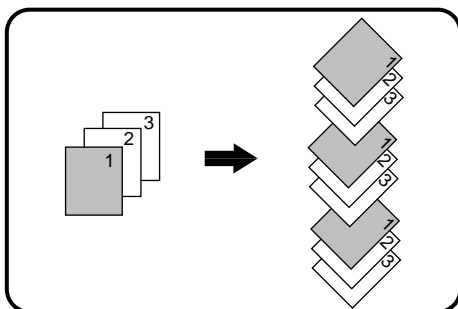

SORT mode

Each set of copies will be sequentially delivered to the offset tray or the top tray as selected.

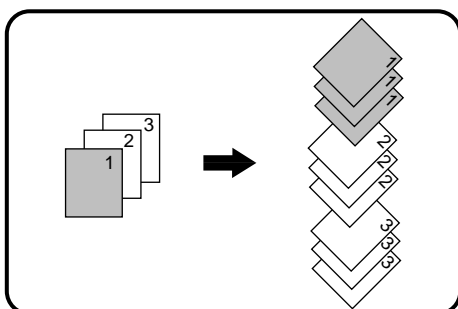

GROUP mode

All copies of the same original will be grouped in the offset tray or the top tray.

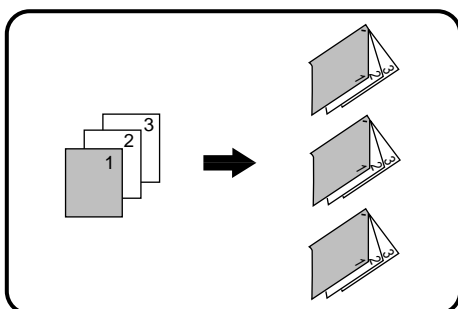

STAPLE SORT mode

Collated sets of copies will be stapled and delivered to the offset tray.

- See next page for details.

NOTE:

Rotation copy (image of original will be rotated when the orientation of the original does not match that of the copy paper) will not function when the STAPLE SORT mode is set.

Staple sort

The STAPLE SORT mode staples A4, A4R, B4, and A3 (8-1/2" x 11", 8-1/2" x 11"R, 8-1/2" x 14", and 11" x 17") size copies. Stapled sets cannot be delivered to the top tray.

- In the STAPLE SORT mode, copying will automatically stop when the number of copies output in the offset tray exceeds certain limits regardless of the tray capacity. In that case, follow the message on the screen. Such limits vary with the size of copy paper.

NOTE:

Different size originals cannot be copied onto copy paper of their respective sizes in the STAPLE SORT mode. The paper size selected for the first scanned original will be used for all originals. To copy different size originals in the STAPLE SORT mode, select the paper size for the largest original.

Using the RSPF

1 Set the originals in the document feeder tray.

- If the number of copies in one set is more than 50 for A4 or A4R (8-1/2" x 11" or 8-1/2" x 11"R) paper or 25 for B4 or A3 (8-1/2" x 14" or 11" x 17") paper, the copies will not be stapled.
- The stapling position shown in the left figure is the factory default position.

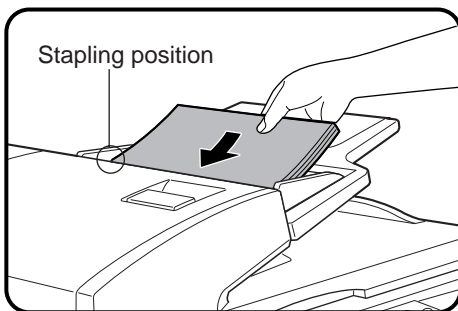

2 Press the OUTPUT key.

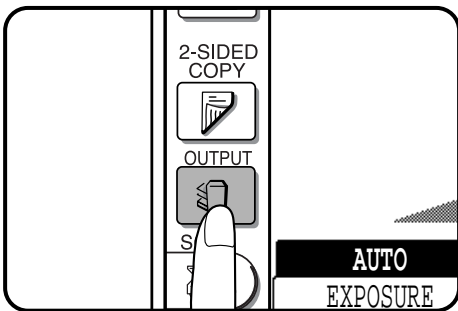

3 Press the "STAPLE SORT" key on the touch panel.

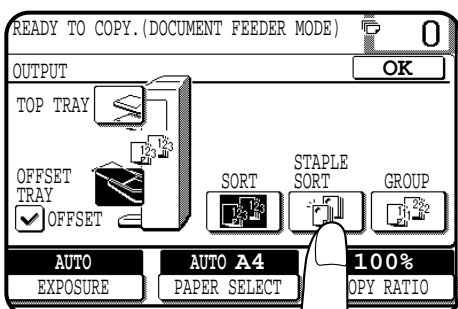

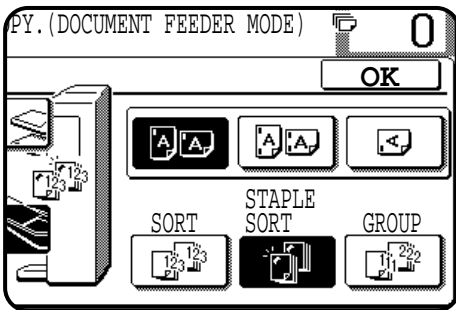

4 Select the desired stapling position.

- The AR-FN3 finisher has three selectable stapling positions as shown below.

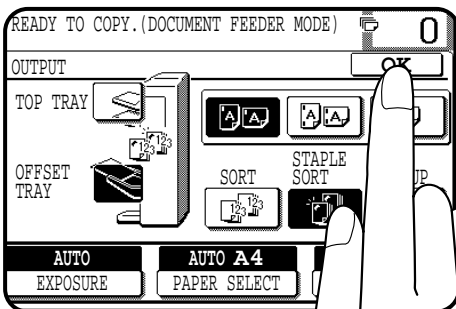
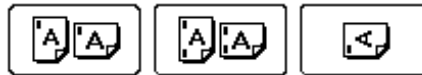

5 Press the "OK" key.

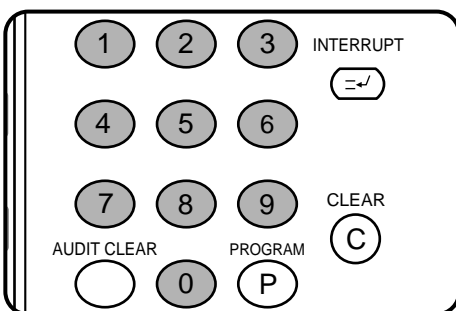

6 Set the number of copies.

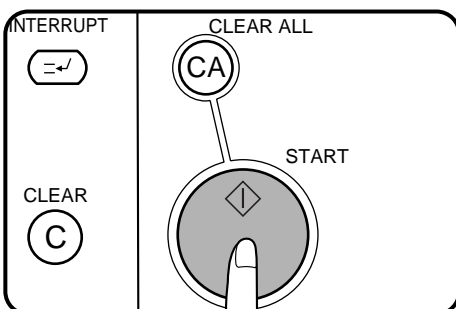

7 Press the START (◊) key.

- When copying of each set is completed, the copies will be automatically stapled and delivered to the offset tray.

Using the document glass

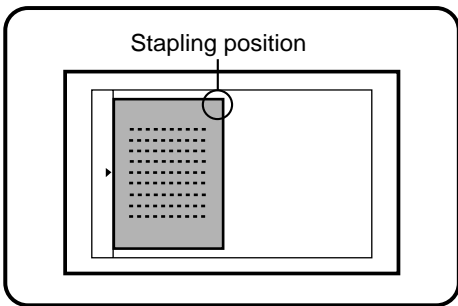

- 1** Set the original on the document glass with the corner to be stapled to the upper right.
 - Copy from the last page to the first page.
 - If the number of copies in one set is more than 50 for A4 or A4R (8-1/2" x 11" or 8-1/2" x 11"R) paper or 25 for B4 or A3 (8-1/2" x 14" or 11" x 17") paper, the copies will not be stapled.
 - The stapling position shown in the left figure is the factory default position.

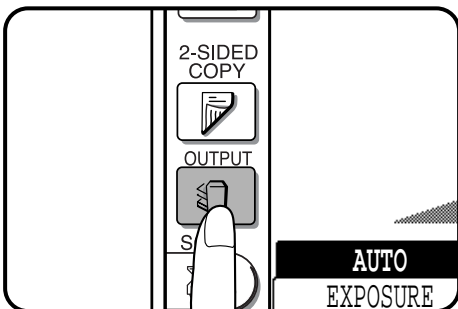

- 2** Press the **OUTPUT** key.

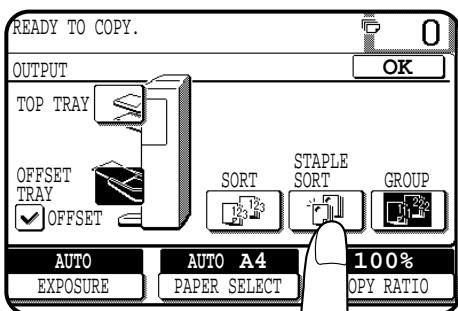

- 3** Press the “**STAPLE SORT**” key on the touch panel.

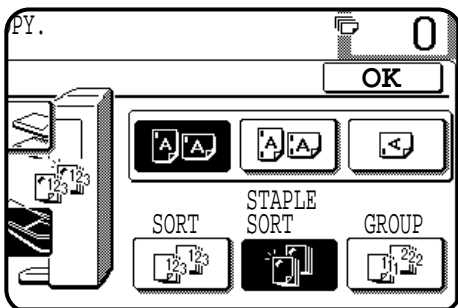

- 4** Select the desired stapling position.
 - The AR-FN3 finisher has three selectable stapling positions as shown below.

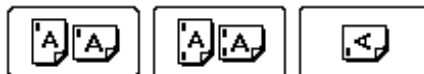

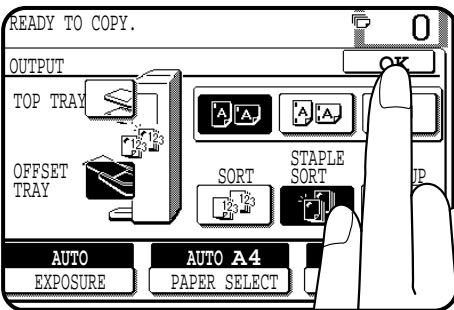

5 Press the “OK” key.

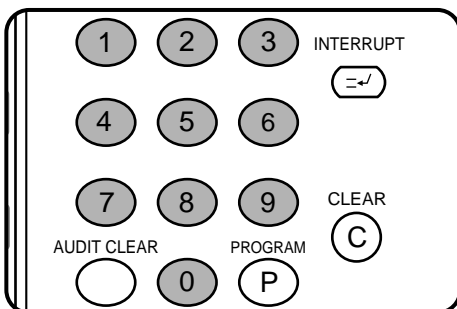

6 Set the number of copies.

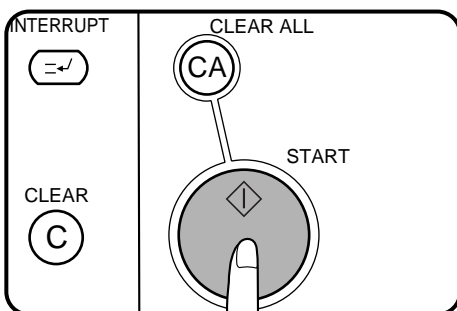

7 Press the START (◊) key.

8 Replace the finished original with the next original after the START (◊) key indicator lights up, and then press the START (◊) key. Repeat this step until all originals have been scanned.

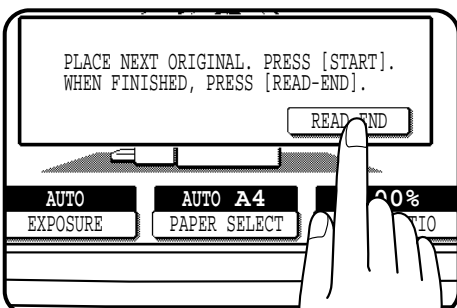

9 After all originals are scanned, press the “READ-END” key on the touch panel.

- Copying will start and each set of copies will be automatically stapled and delivered to the offset tray.

Staple cartridge replacement

The message "SLIDE THE FINISHER AWAY FROM THE COPIER AND ADD STAPLES." will appear when the staple cartridge is empty. Replace the staple cartridge as follows:

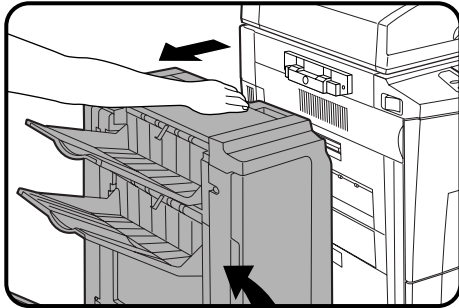

1 While holding the finisher release lever, slide the finisher away from the copier.

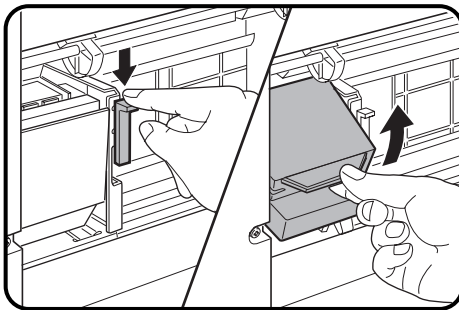

2 Lower the lock lever to unlock the stapler unit.

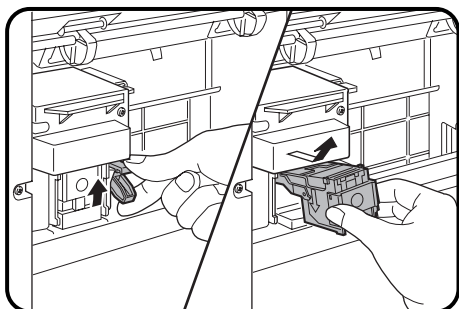

3 Turn the stapler unit to face up.

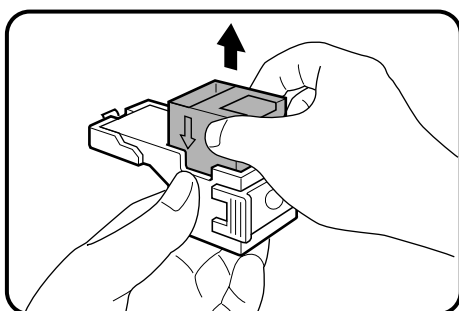

4 Hold the staple box release lever to unlatch the staple box.

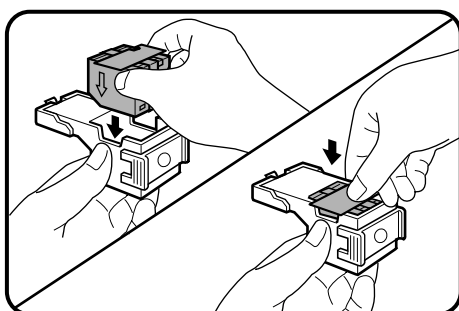

5 Remove the staple box.



6 Remove the empty staple cartridge from inside the staple box.

7 Insert the new staple cartridge into the box until it clicks in place.

- Insert the new cartridge by aligning the arrows on the cartridge with those on the box. Check that the cartridge locks in place by pulling it slightly.
- The cartridge holds 5,000 staples.

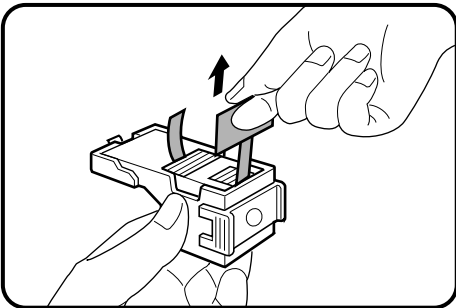

- 8** Remove the rear paper and tape from the cartridge.
- Pull the tape straight. If not, the tape may tear.

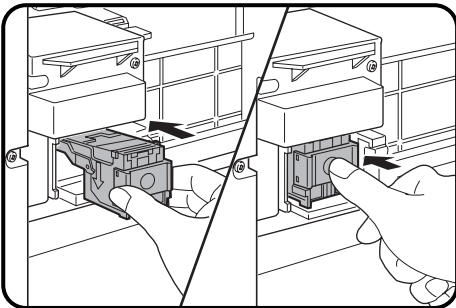

- 9** Insert the staple box into the stapler unit until it clicks into place.

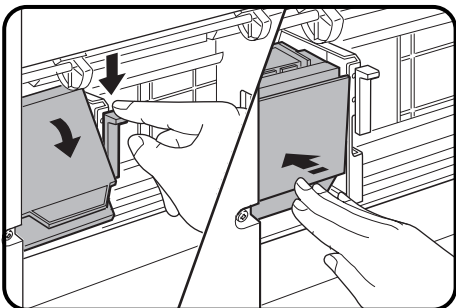

- 10** Lower the lock lever and return the stapler unit to face down. Push the stapler unit until it locks.

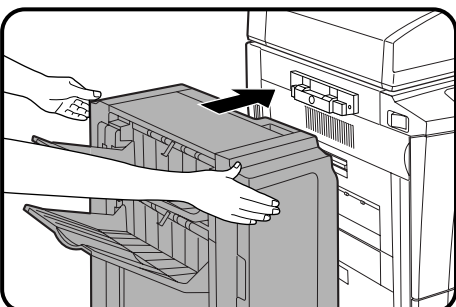

- 11** Push the finisher toward the copier and latch it in place.

Staple jam removal

If staples become jammed in the stapler, "CHECK STAPLER POSITION OR STAPLE JAM." will be displayed. Remove the jammed staples in the manner described below.

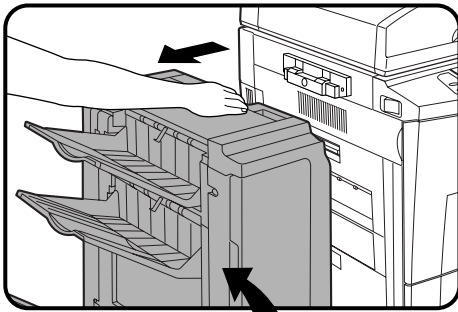

- 1** While holding the finisher release lever, slide the finisher away from the copier.

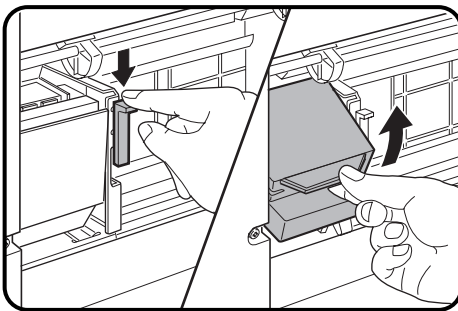

- 2** Lower the lock lever to unlock the stapler unit.

- 3** Turn the stapler unit to face up.

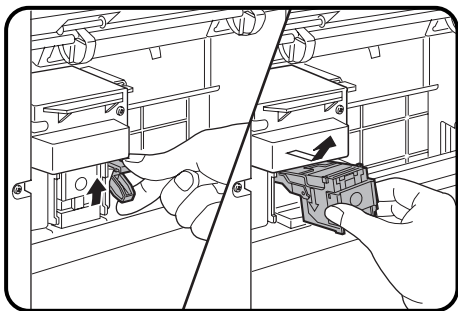

- 4** Hold the staple box release lever to unlatch the staple box.

- 5** Remove the staple box.

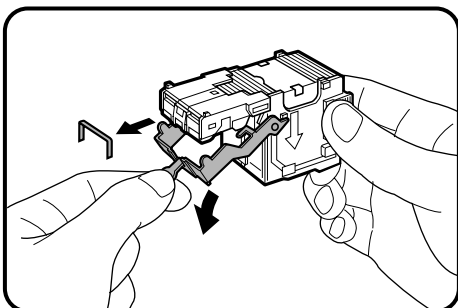

- 6** Lower the lever at the end of the staple box and remove the jammed staples.

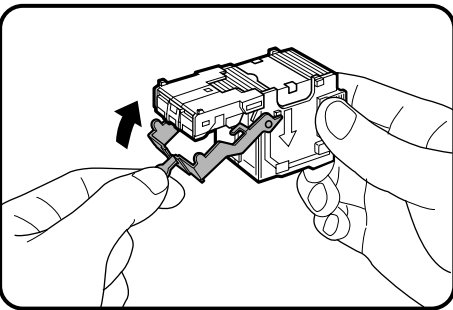

7 Return the lever to its original position.

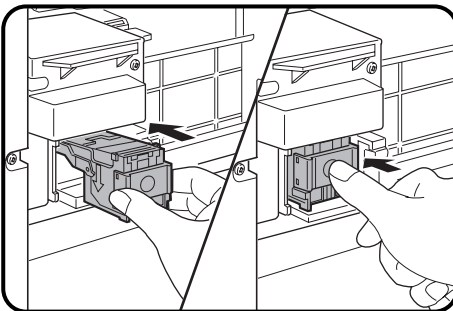

8 Insert the staple box into the stapler unit until it clicks in place.

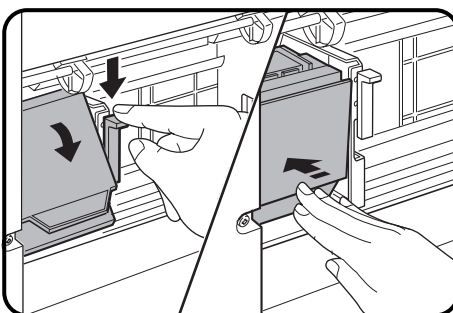

9 Lower the lock lever and return the stapler unit to face down. Push the stapler unit until it locks.

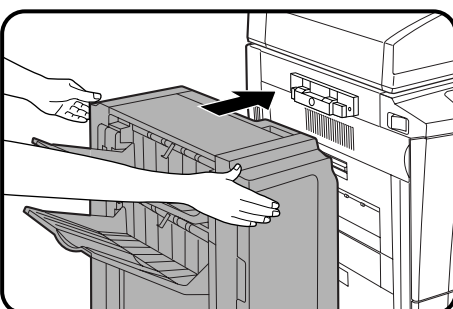

10 Push the finisher toward the copier and latch it in place.

Misfeed removal

The copier will stop when a misfeed occurs.

The message "A MISFEED HAS OCCURRED. CLEAR INDICATED AREA. PRESS **i** FOR RECOVERY INSTRUCTIONS." will appear with a display of paper misfeed locations. Press the INFORMATION (**i**) key for more detailed information as necessary.

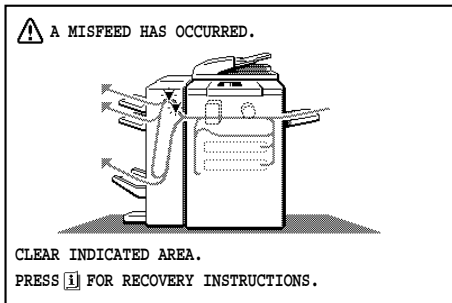

Misfeed in the upper transport area

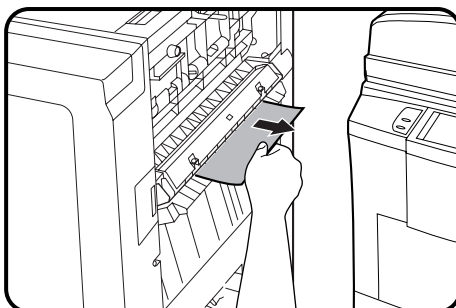
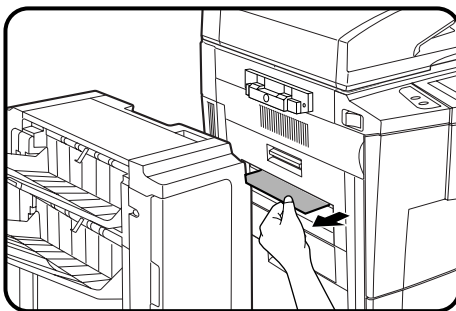
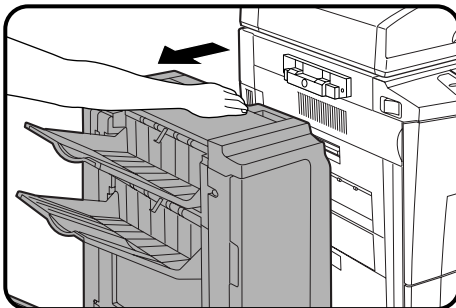

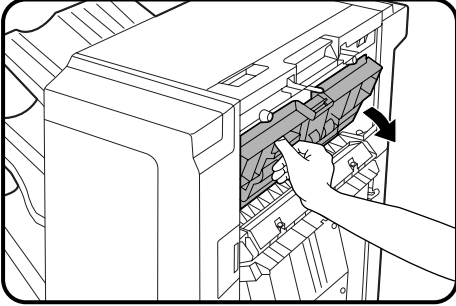

3 If the misfed paper cannot be removed in step 2, open the cover of the paper feed area of the finisher.

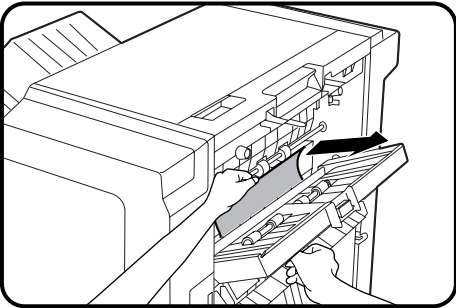

4 Remove the misfed paper.

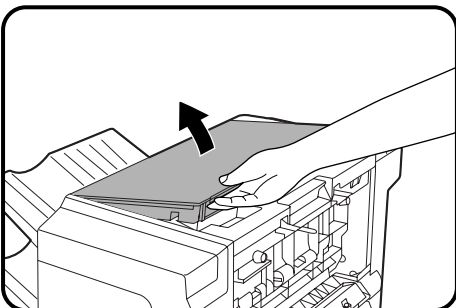

5 If the misfed paper cannot be removed in step 4, close the cover of the paper feed area and open the top cover.

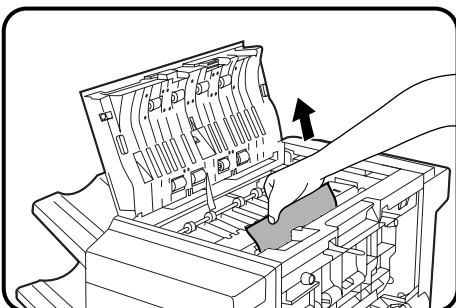

6 Remove the misfed paper.

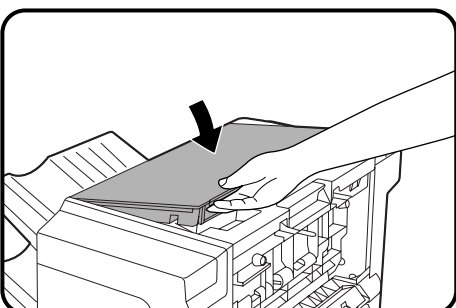

7 Close the top cover.

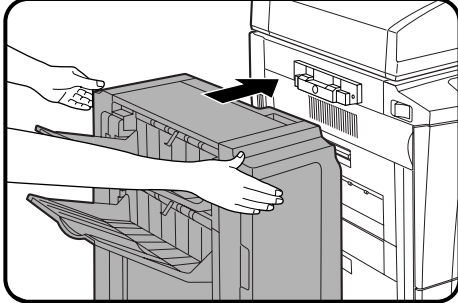

- 8** Push the finisher toward the copier and latch it in place.
- Confirm that the misfeed display is cleared.

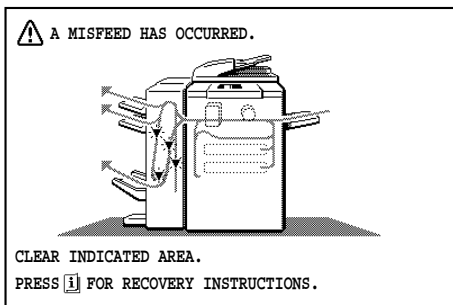

Misfeed in the lower transport area

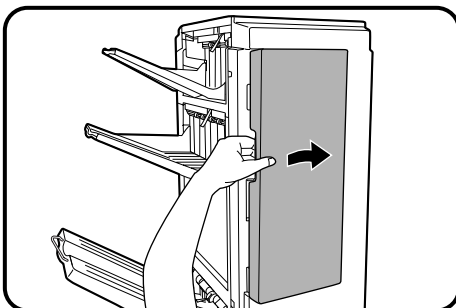

- 1** Open the paper transport area cover of the finisher.

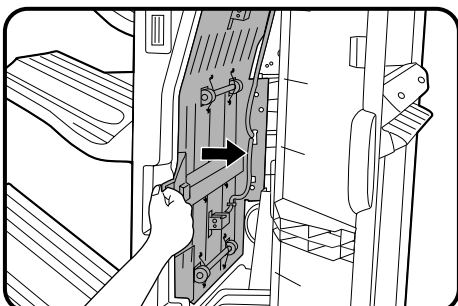

- 2** Use the transport area lever to open the transport.

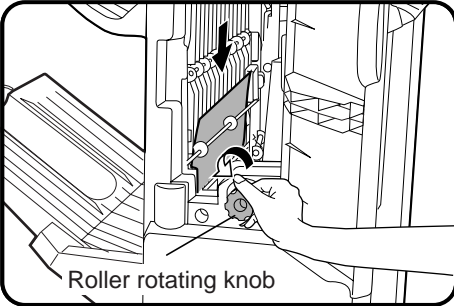

3 Remove the misfed paper.

- Turn the roller rotating knob in the direction of the arrow to assist in removing the paper.

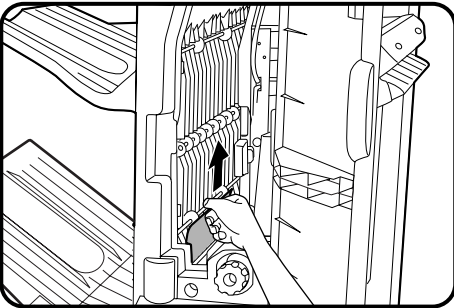

4 Close the transport.

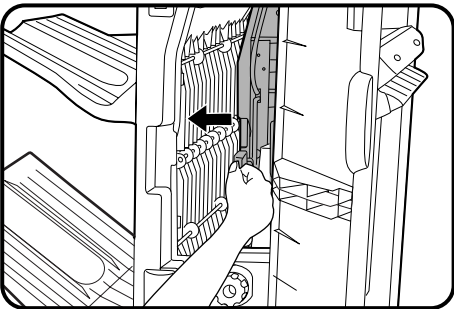

5 Remove the misfed paper from the inside of offset tray by raising the shutter as shown.

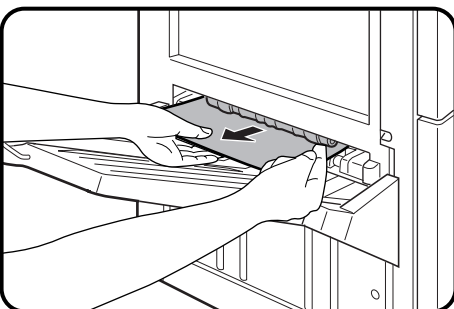

- Remove the misfed paper from the paper transport area.

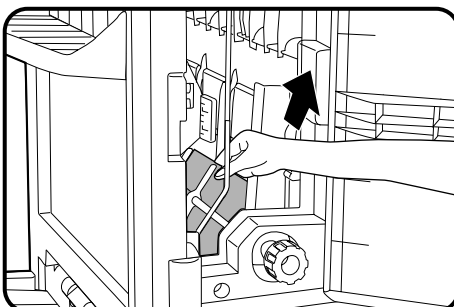

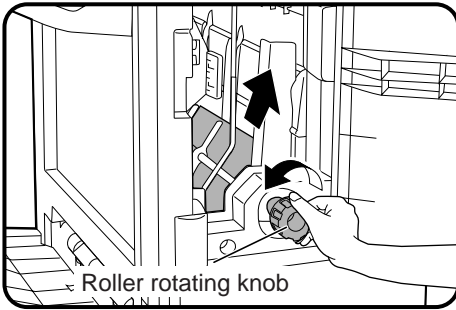

- If the misfed paper is not seen in the paper transport area, turn the roller rotating knob to feed the paper.

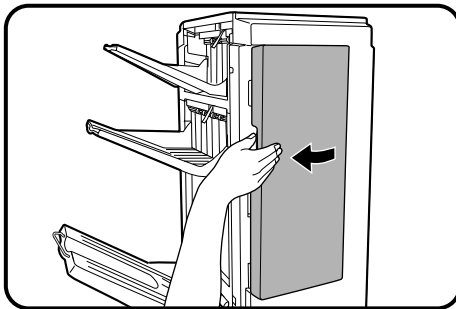

- 6** Close the paper transport area cover.
- Confirm that the misfeed display is cleared.

LARGE CAPACITY TRAY (AR-LC1N)

The large capacity tray provides the added convenience of having 3,000 additional sheets of A4 (8-1/2" x 11") paper available.

NOTE:

To install the large capacity tray, an optional stand/500-sheet paper drawer (AR-DE7) or an equivalent stand must be installed.

PART NAMES

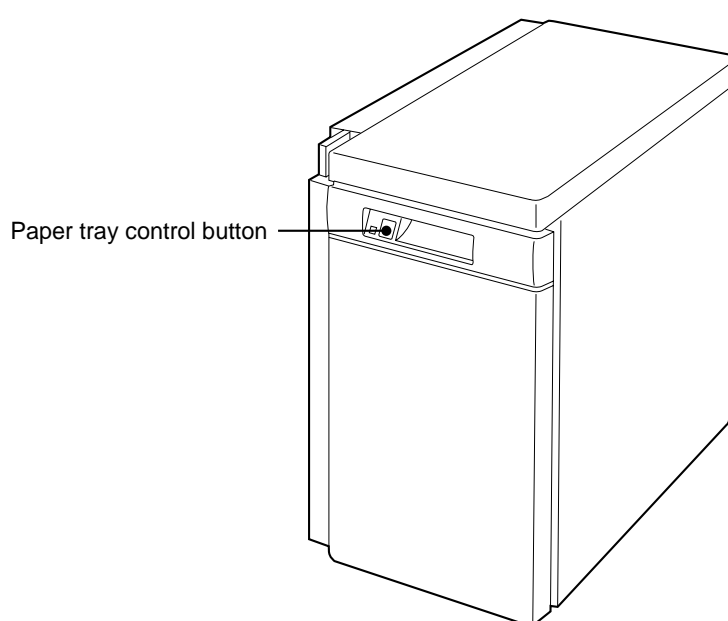

Specifications

Paper size	A4 (8-1/2" x 11")
Paper weight	56 to 105 g/m ² (15 lbs. to 28 lbs.)
Paper capacity	3,000 sheets
Weight	Approx. 32 kg (70.6 lbs.)
Dimensions	330 mm (W) x 540 mm (D) x 583 mm (H) (13" (W) x 21-17/64" (D) x 22-61/64" (H))

Specifications are subject to change for improvement without notice.

Loading copy paper

The large capacity tray will automatically lower when the tray runs out of paper.

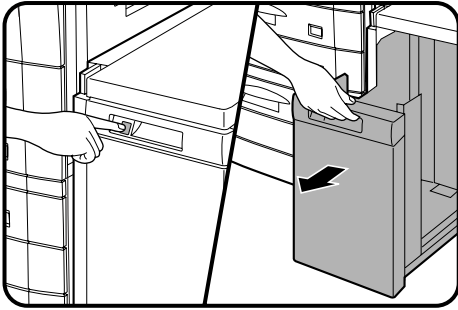

1 Press the paper tray control button on the large capacity tray.

- The button lamp will blink while the feed table is lowering and will go out when the tray is ready to be opened.

2 When the button lamp goes out, pull the paper tray out.

- Do not pull the paper tray out before the button lamp goes out.

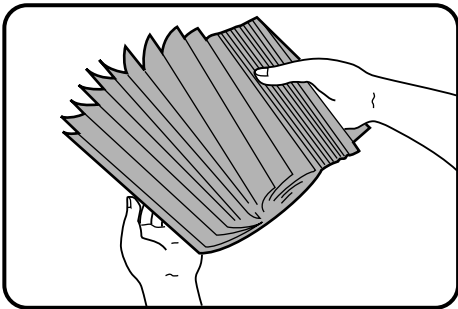

3 Only use paper within the Sharp specification and follow the paper manufacturer's instructions regarding fanning and loading the paper.

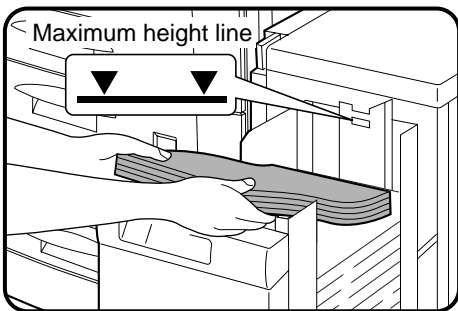

4 Load the paper onto the feed table.

- Be sure to load paper appropriate for the large capacity tray. See page 7-19.
- Do not exceed the maximum height line.

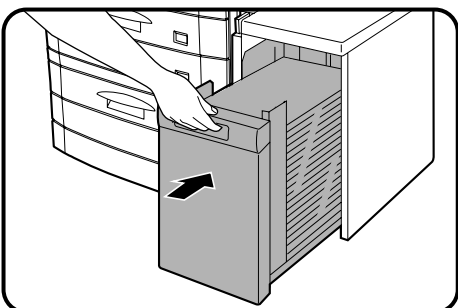

5 Gently push the large capacity tray back into place.

- The paper tray control button lamp will blink as the feed table returns to the feed position and will light up steadily when it is in position to feed.

Misfeed removal

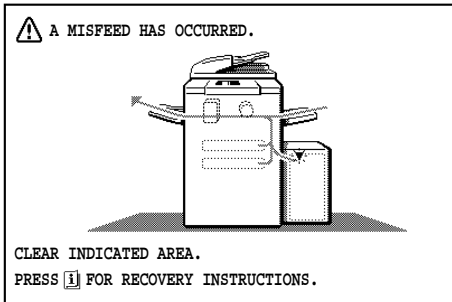

The copier will stop when a misfeed occurs. The message "A MISFEED HAS OCCURRED. CLEAR INDICATED AREA. PRESS [i] FOR RECOVERY INSTRUCTIONS." will appear with a display of paper misfeed locations. Press the INFORMATION ([i]) key for more detailed information as necessary.

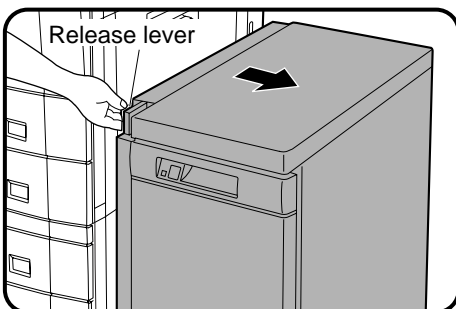

1 While holding the tray release lever, carefully slide the large capacity tray away from the copier until it stops.

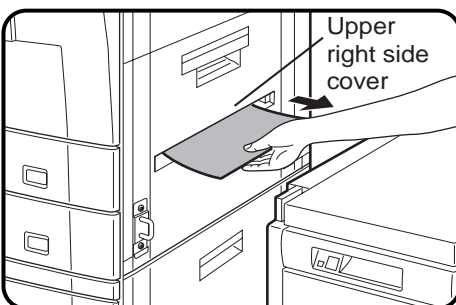

2 Remove any misfed paper from the copier and the large capacity tray.

- Be sure not to tear the misfed paper during removal.
- Open and close the upper right side cover of the copier after removing the misfed paper from the copier.

If the misfed paper cannot be removed easily, open the upper right side cover to remove the paper.

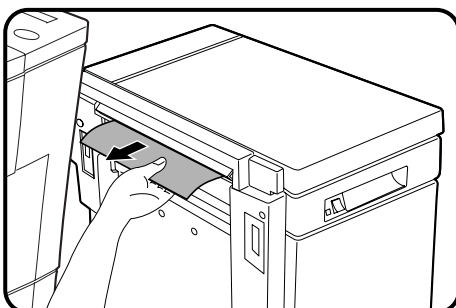

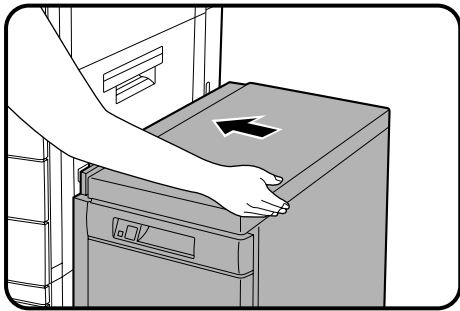

3 Push the large capacity tray toward the copier and latch it into place.

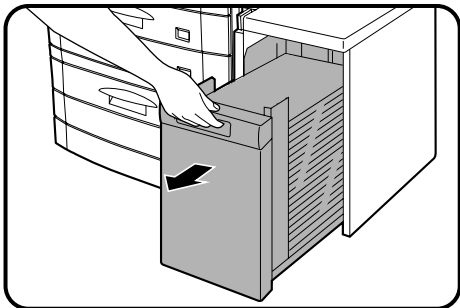

4 If misfed paper is not found in step 2, pull the tray out.
• When pulling the large capacity tray out, be sure to pull it out after the paper tray control button lamp goes out.

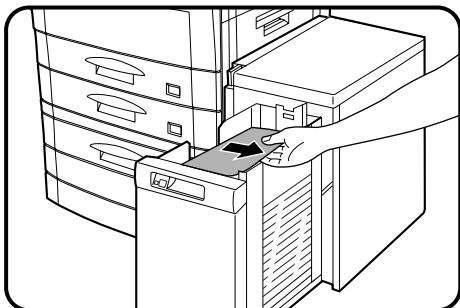

5 Remove the misfed paper.

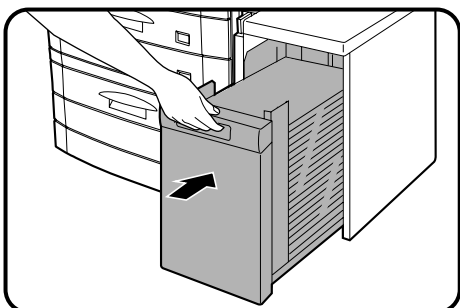

6 Gently push the tray back into place.
• Confirm that the misfeed display is cleared.

STAND/500-SHEET PAPER DRAWER (AR-DE7)

This optional stand with a paper tray provides the convenience of increased paper capacity for the copier and a greater choice of paper sizes readily available for copying. Even greater paper capacity and size flexibility are available when the stand is equipped with an optional auxiliary 500-sheet paper drawer (AR-CS3).

The AR-DE7 is available with a 500-sheet paper drawer alone or with an optional auxiliary 500-sheet paper drawer for the additional flexibility of two feeds with a total capacity of 1,000 sheets.

PART NAMES

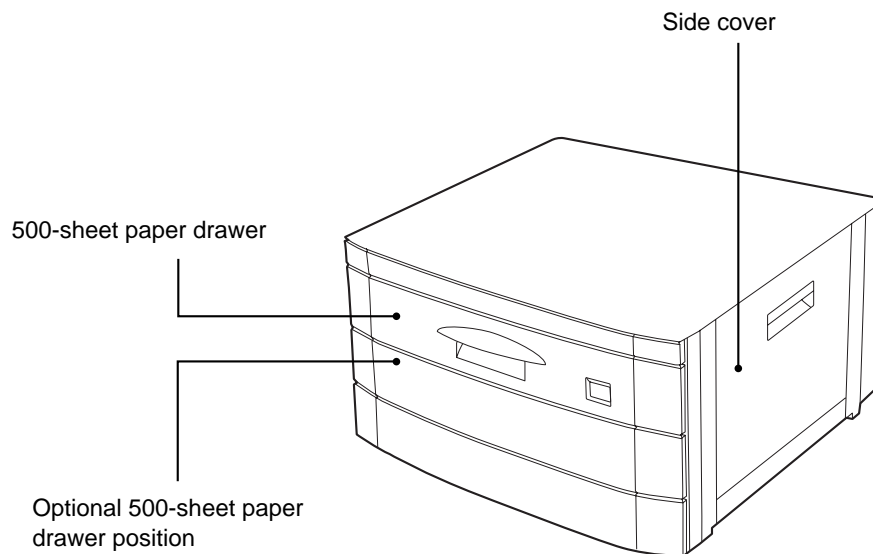

Specifications

Paper size	A4 to A3 (8-1/2" x 11" to 11" x 17")
Paper weight	56 to 105 g/m ² (15 lbs. to 28 lbs.)
Paper capacity	500 sheets of paper Total of 1,000 sheets of paper with an optional 500-sheet paper drawer installed
Weight	Approx. 25 kg (55.2 lbs.)
Dimensions	600 mm (W) x 604 mm (D) x 403 mm (H) (23-5/8" (W) x 23-25/32" (D) x 15-7/8" (H))

Specifications are subject to change for improvement without notice.

Loading copy paper

The method of loading of copy paper for the paper tray of the 500-sheet paper drawer is the same as for the paper trays in the copier. See page 4-3.

The method of changing the copy paper size is also the same for the paper trays in the copier. See page 4-4.

Misfeed removal

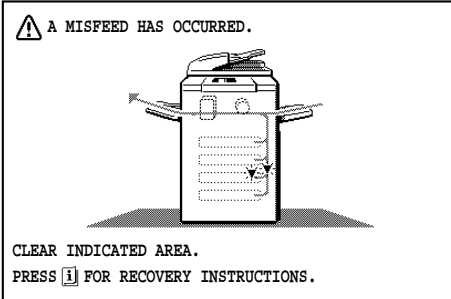

The copier will stop when a misfeed occurs. The message "A MISFEED HAS OCCURRED. CLEAR INDICATED AREA. PRESS [i] FOR RECOVERY INSTRUCTIONS." will appear with a display of paper misfeed locations. Press the INFORMATION ([i]) key for more detailed information as necessary.

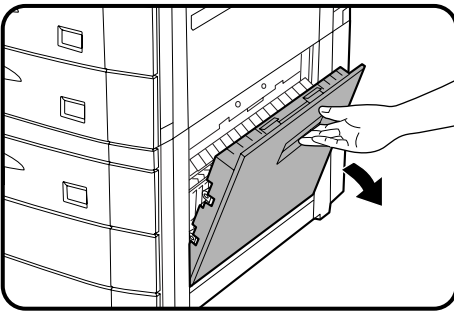

1 Open the lower right side cover and remove any misfed paper.

- Be sure to perform this step before pulling out the paper drawer. If not, the paper may be torn as the drawer is opened.
- Be sure not to tear the misfed paper during removal.

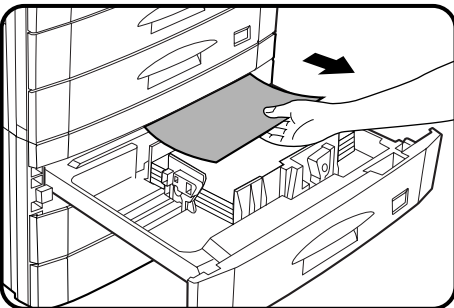
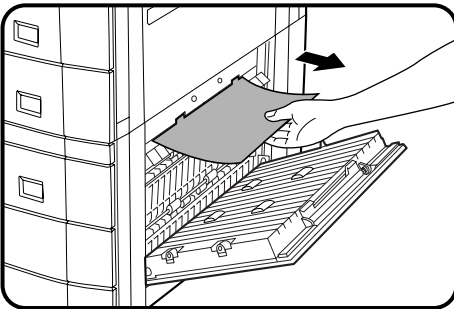

2 Gently lift and pull out the paper drawer. Remove any misfed paper.

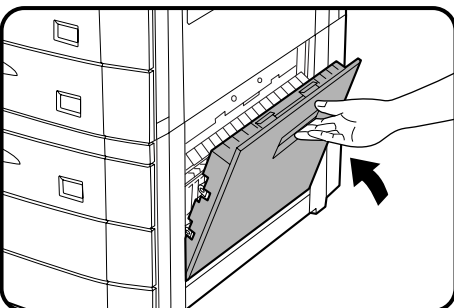

3 Close the paper drawer and the lower right side cover.

4 Open and close the front cover to cancel the misfeed display.

- Confirm that the misfeed display is cleared.

CHAPTER 8

KEY OPERATOR'S GUIDE

This chapter contains information on all of the programs for use by the key operator. The programs allow the key operator to tailor many functions of the AR-507 for specific modes of operation. These programs can only be accessed after a key operator code number has been entered.

Please familiarise yourself with this chapter and refer to it for the information you need to keep the copier operating smoothly.

	Page
• KEY OPERATOR CODE NUMBER	8-2
Registering the key operator code number	8-2
• KEY OPERATOR PROGRAMS	8-4
Using the key operator programs	8-7
• KEY OPERATOR ASSISTANCE CALL	8-31
• KEY OPERATOR CODE NUMBER: FACTORY SETTING	8-33

KEY OPERATOR CODE NUMBER

A key operator code number must be registered before a key operator program can be used. The key operator must remember this number. Only this registered number will allow access to the key operator programs.

Registering the key operator code number

1 Press the **CUSTOM SETTINGS** () key.

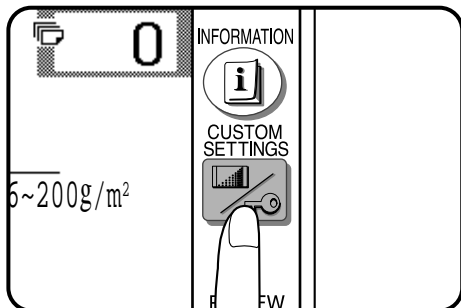

2 Press the “**KEY OPERATOR PROGRAMS**” key on the touch panel.

- The following display will appear.

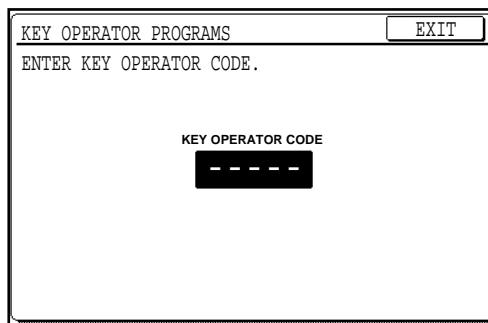
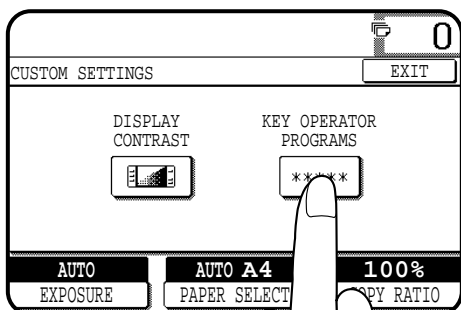

3 Enter your key operator code number using the **10-key pad**.

- When registering the key operator code number for the first time, enter the number that was set at the factory. (See page 8-33.)
- As the code number is entered, the dashes in the display will change to asterisks.

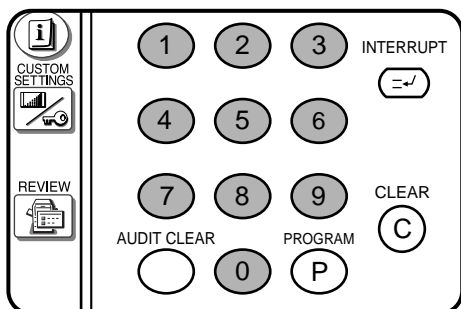

4 Press the “**COPIER**” key on the touch panel.

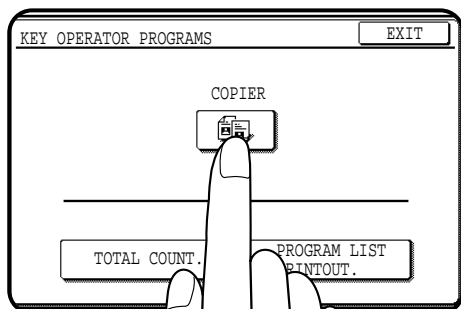

5 Press the “**OTHER FUNCTION SETTINGS**” key.

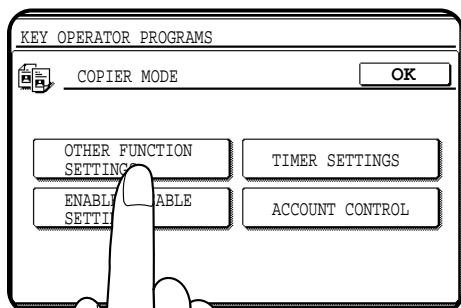

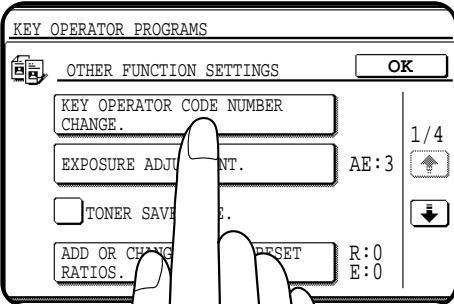

6 Press the “KEY OPERATOR CODE NUMBER CHANGE.” key.

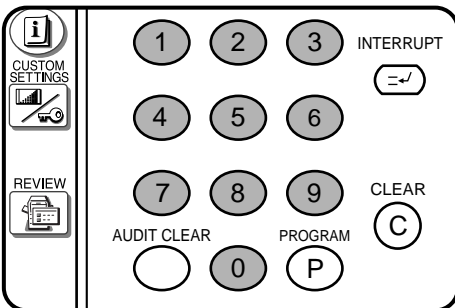

7 Choose a new 5-digit code number and enter it using the 10-key pad.

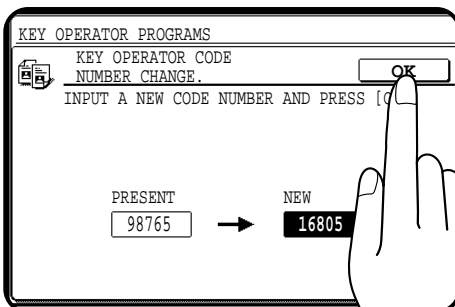

8 Press the **OK** key.

- The code number will change from the factory setting to the new setting.

9 To continue with other key operator programs, press the **OK** key and then select another program. To exit the key operator program mode, press the **CLEAR ALL (CA)** key.

KEY OPERATOR PROGRAMS

A complete list of all key operator programs is provided below. These programs can only be accessed by first entering the key operator code number.

The key operator programs are grouped into four categories: account control, other function settings, timer settings, and enable/disable settings.

Category	Program Name	Function	Page No.
Account Control	Auditing Mode	Enables or disables the basic auditing mode, which controls access to copier.	8-9
	Number of Copies per Account	Displays the total number of copies made against account numbers.	8-9
	Billing by Account	Displays the accumulated cost of copies against account numbers.	8-10
	Resetting Account	Resets all audit accounts or selectively resets individual accounts.	8-11
	Account Number Control	Registers accounts, deletes accounts, changes an account number, or prints all registered account numbers.	8-12
	Price/Copy Setting	Sets up to 3 levels of price per copy against account numbers.	8-13
	Account Limit Setting	Sets the maximum number of copies which can be made against a registered account number.	8-14
	Account Number Security	Guards against trial and error entering of audit account numbers.	8-15
Other Function Settings	Key Operator Code Number Change	Changes the key operator code number.	8-16
	Exposure Adjustment	Lightens or darkens copies in the automatic exposure mode.	8-16
	Add or Change Extra Preset Ratios	Adds or changes reduction and enlargement preset copy ratios.	8-17
	Setting a Maximum Number of Copies	Sets the maximum number of copies that can be selected.	8-17
	Initial Margin Shift Setting	Sets the initial margin shift values.	8-18
	Erase Width Adjustment	Sets the initial amount of the erase area.	8-18
	Initial Status Setting	Sets the copier's initial settings in the ready condition.	8-19
	Stream Feeding Mode	Enables the stream feeding mode for copying from the document feeder.	8-19
	Staple Position Setting	Sets the initial stapling position setting for an optional finisher (AR-FN3).	8-20

Category	Program Name	Function	Page No.
	Date Format Setting	Sets the initial date format.	8-20
	Date and Time Adjustment	Adjusts the date and time.	8-21
	Rotation Copy Setting	Enables/disables rotation of original images.	8-21
	Size Setting for [EXTRA]	Sets a paper size in each tray with [EXTRA] setting.	8-22
	Heavy Paper on the Bypass Tray	Enables/disables selection of paper type placed in the bypass tray.	8-22
Timer Settings	Auto Power Shut-off Timer	Sets a time interval after which the copier automatically turns off.	8-23
	Auto Clear Setting	Sets a time interval after which the copier returns to the initial settings.	8-23
	Preheat Mode Setting	Sets the time that elapses before the copier enters the preheat mode after copying is completed.	8-24
	Noise Level Reduce Mode	Sets the time that elapses before the copier enters the noise level reduce mode after copying is completed.	8-24
	Message Time Setting	Sets the length of time that messages are displayed.	8-25
Enable/Disable Settings	Disabling of Auto Paper Selection	Prevents automatic paper selection. To disable auto paper selection from the bypass tray, see page 8-28, Prohibit Auto Paper Selection from the Bypass-Tray.	8-26
	Disabling of Auto Tray Switching	Prevents automatic switching between the paper trays.	8-26
	Disabling of Bypass-Tray in Duplex Copy	Prohibits the use of the bypass tray during duplex copying.	8-26
	Disabling Deletion of Job Programs	Prevents stored programs from being replaced or deleted.	8-27
	Disabling of Document Feeder	Prevents the use of the document feeder when it malfunctions.	8-27
	Disabling of Duplex Copying	Temporarily prevents the duplex system from operating when it malfunctions. Allows the use of the copier but not the duplex system.	8-27

KEY OPERATOR PROGRAMS

Category	Program Name	Function	Page No.
	Disabling of Stapler	Prevents damage to the stapler while awaiting repair service. (The stapler is included in an optional finisher (AR-FN3).)	8-28
	Disabling of Covers Mode	Prevents the selection of COVERS mode.	8-28
	Prohibit Auto Paper Selection from the Bypass-Tray	Prevents automatic paper selection from the bypass tray.	8-28
	Disabling of PC/Modem Access	Provides or prevents access to key operator programs through a PC/modem without key operator code entry.	8-28
	Disabling of Auto Power Shut-off Mode	Disables the auto power shut-off mode.	8-29
	Disabling of Beep When Keys Touched	Enables or disables sounding of beep when keys are touched.	8-29
Other Programs	Total Count	Recalls the total counts, including counts of the copier, document feeder, duplex module, and stapler.	8-30
	Program List Printout	Sequentially prints available key operator programs.	8-30

Using the key operator programs

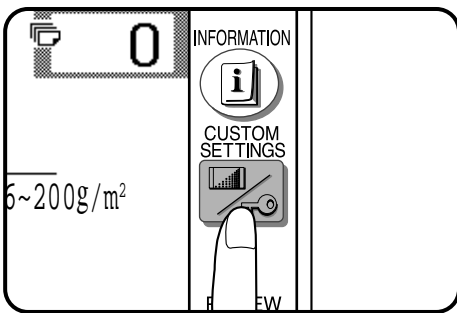

1 Press the CUSTOM SETTINGS (🔑) key.

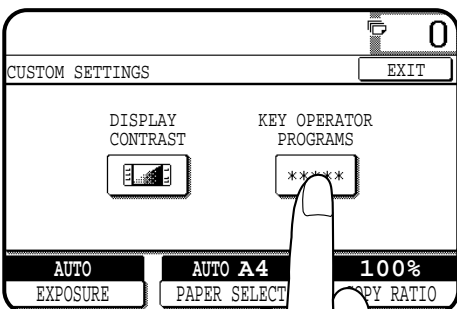

2 Press the “KEY OPERATOR PROGRAMS” key on the touch panel.

- The following display will appear.

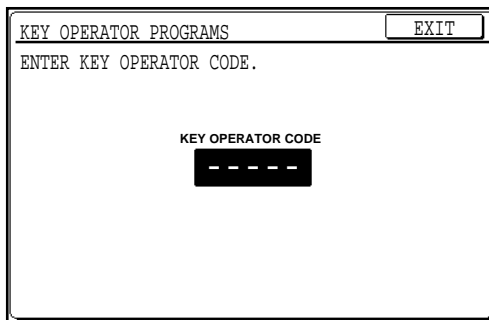

3 Enter the key operator code number.

- The dashes in the display will change to asterisks.

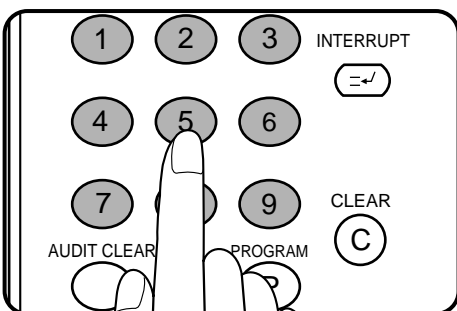

4 Press the “COPIER” key on the touch panel.

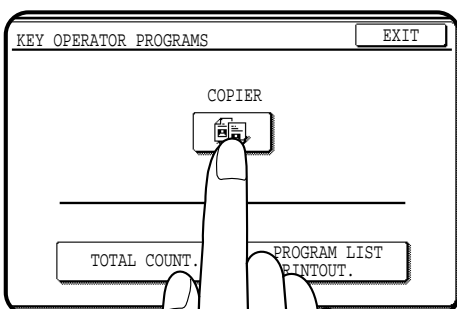

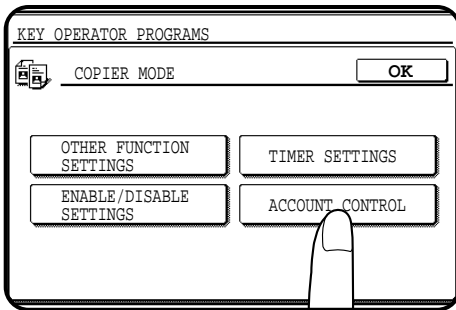

5 Select the desired category on the touch panel.
Example: To select the account control category, press the "ACCOUNT CONTROL" key.

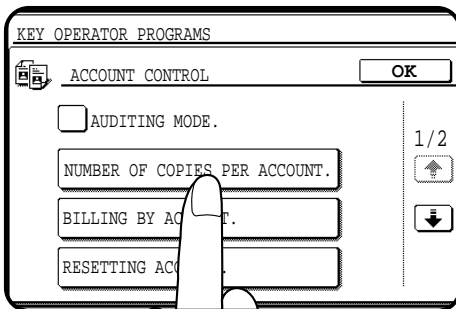

6 Press the key of the desired program on the touch panel.
Example: To see the number of copies per account, press the "NUMBER OF COPIES PER ACCOUNT." key.

- For some programs, a check box is displayed to the left of the program name. If the box is pressed, a check mark will appear and the program will be set. If the box is pressed again, the check mark will disappear and the program will be cancelled.
- For other programs, the program setting screen of the program will appear when the program key is pressed.
- If and/or keys are displayed, additional programs can be displayed using these keys.

7 Follow instructions for the program.

- If a mistake is made during entry, press the CLEAR (C) key to clear the entry.
- To continue with other key operator programs, press the "OK" key and then select another program.

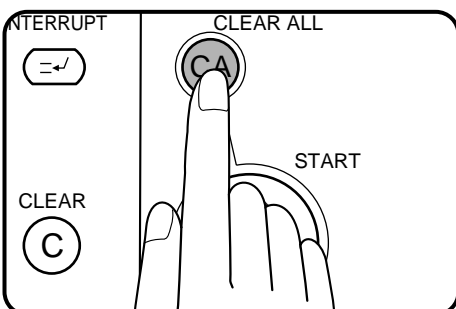

8 To exit the key operator program mode, press the CLEAR ALL (CA) key.

ACCOUNT CONTROL

The programs of this category are used to set the internal auditor functions. These programs can be selected by pressing the "ACCOUNT CONTROL" key and then selecting the desired program key.

Auditing Mode

This program is used to enable or disable the basic auditing mode. When disabled, the message in the display will be "READY TO COPY." Access to copying is open to any operator. When enabled, the message in the display will be "ENTER YOUR ACCOUNT NUMBER. -----". Copying in this state is limited to operators with an assigned 5-digit account number. A maximum of 500, 5-digit account numbers (00001 to 99999) can be assigned. Use key operator program "Account Number Control" (page 8-12) to assign account numbers.

To enable the auditing mode, press the check box of "AUDITING MODE." to display a check mark in the check box.

To disable the auditing mode, press the check box of this program again to clear the check mark in the check box.

Number of Copies per Account

This program is used to display or print the total number of copies made against each account number. An A3 (11" x 17") copy is counted as two copies. When the "NUMBER OF COPIES PER ACCOUNT." key is pressed, the following display will appear.

KEY OPERATOR PROGRAMS				
NUMBER OF COPIES PER ACCOUNT.				OK
ACCOUNT NUMBER	NUMBER OF COPIES MADE	MAXIMUM	1/2	
16805	: 001,100	600,000	↑	
16850	: 002,200	500,000	↓	
16900	: 003,500	500,000		
17806	: 004,400	800,000		
ACCOUNT SEARCH			PRINT	

1. Press the  key to advance through the accounts.
 - To print all accounts, press the "PRINT" key. To stop printing after starting, press the "CANCEL" key.
 - If "000,000" is displayed in a column of MAXIMUM, the account limit has not been set for the account.
 - To display the number of copies for a specified account, press the "ACCOUNT SEARCH" key.

KEY OPERATOR PROGRAMS

NUMBER OF COPIES PER ACCOUNT.

ACCOUNT SEARCH

INPUT ACCOUNT NUMBER.

ACCOUNT NUMBER	NUMBER OF COPIES MADE	MAXIMUM
-----	000,000	000,000

- Enter the desired account number using the 10-key pad. Press the “NEXT SEARCH” key to enter another account number or press the lower “OK” key to return to the initial screen.

2. Press the “OK” key to exit the program.

Billing by Account

This program is used to display or print the accumulated cost of copies made when a relevant price per copy has been set using program “Price/Copy Setting”.

When the “BILLING BY ACCOUNT.” key is pressed, the following display will appear.

KEY OPERATOR PROGRAMS

BILLING BY ACCOUNT

ACCOUNT NUMBER	BILLING	
16805	600000.000000	↑
16850	500000.000000	↓
16900	500000.000000	
17806	800000.000000	

ACCOUNT SEARCH

1. Press the key to advance through the accounts.

- To print all accounts, press the “PRINT” key. To stop printing after starting, press the “CANCEL” key.
- To display the billing for a specified account, press the “ACCOUNT SEARCH” key.

KEY OPERATOR PROGRAMS

BILLING BY ACCOUNT

ACCOUNT SEARCH

INPUT ACCOUNT NUMBER.

ACCOUNT NUMBER	BILLING
-----	000000.000000

- Enter the desired account number using the 10-key pad. Press the “NEXT SEARCH” key to enter another account number or press the lower “OK” key to return to the initial screen.

2. Press the “OK” key to exit the program.

Resetting Account

This program is used to reset all audit accounts or to selectively reset individual accounts.

When the "RESETTING ACCOUNT." key is pressed, the following display will appear.

KEY OPERATOR PROGRAMS			
RESETTING ACCOUNT.			OK
ACCOUNT NUMBER	NUMBER OF COPIES MADE	MAXIMUM	1/2
16805	: 001,100	600,000	↑
16850	: 002,200	500,000	↓
16900	: 003,500	500,000	
17806	: 004,400	800,000	
ACCOUNT SEARCH		ALL ACCOUNTS	RESET

- If "000,000" is displayed in a column of MAXIMUM, the account limit has not been set for the account.

To reset all accounts

1. Press the "RESET" (ALL ACCOUNTS) key on the touch panel.
2. Press the "YES" key.
3. Press the "OK" key to exit the program.

To reset a single account

1. Press the key of an account to be reset.
 - To display other account numbers, press the ↑ or ↓ key.
 - A single account can be also specified by pressing the "ACCOUNT SEARCH" key, then entering the desired account number using the 10-key pad and pressing the key of the number of copies made.
2. Press the "YES" key.
3. Continue with steps 1 and 2 for other account numbers. Press the "OK" key to exit the program.

Account Number Control

This program is used to register accounts, delete accounts, change an account number, or print all account numbers.

When the "ACCOUNT NUMBER CONTROL." key is pressed, the following display will appear.

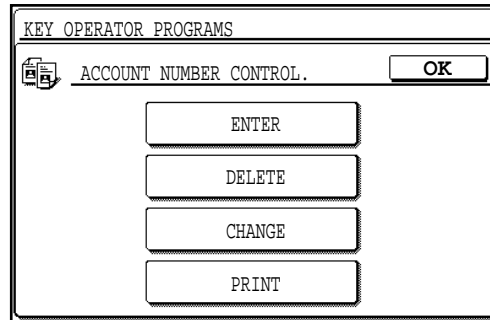

To register accounts

1. Press the "ENTER" key.
2. Enter a 5-digit account number (00001 to 99999) using the 10-key pad.
 - Select a number different from the key operator code number.
3. Press the "ENTER" key.
 - If a number that is already registered is entered, the message "THIS NUMBER IS ALREADY USED." will appear. Press the "OK" key and enter another number.
4. To enter other account numbers, repeat steps 2 and 3. Press the "OK" key twice to exit the program.

To delete accounts

1. Press the "DELETE" key.
2. To delete all accounts, press the "DELETE" (ALL ACCOUNTS) key on the touch panel.
 - A message will appear to confirm the selection. Press the "YES" key to delete all accounts. If you decide not to delete all accounts, press the "NO" key.
3. To delete an individual account, enter the account number to be deleted using the 10-key pad.
4. Press the "ENTER" key.
5. Continue with steps 3 and 4 for other account numbers. Press the "OK" key twice to exit the program.

To change an account number

1. Press the “CHANGE” key.
2. Enter the account number to be changed using the 10-key pad.
3. Enter a new account number.
4. Press the “ENTER” key.
 - If a number that is already registered is entered, the message “THIS NUMBER IS ALREADY USED.” will appear. Press the “OK” key and enter another number.
5. To change other account numbers, repeat steps 2 to 4. Press the “OK” key twice to exit the program.

To print all registered account numbers

1. Press the “PRINT” key.
 - The copier will start printing. To stop printing after starting, press the “CANCEL” key.
2. Press the “OK” key to exit the program.

Price/Copy Setting

This program is used to set the price per copy. Three price per copy values can be set (#1, #2, and #3). As copies are made, the cumulative cost of the copies is kept in memory.

When the “PRICE/COPY SETTING.” key is pressed, the following display will appear.

PRICE CODE	PRESENT PRICE	NEW PRICE
# 1	80	-
# 2	60	-
# 3	180	-

1. Enter the new price for price code #1 by using the 10-key pad and then press the “ENTER” key.
 - Use the INTERRUPT (\equiv) key for decimal points.
 - If the “ENTER” key is pressed without entering a value, the price per copy will not be changed.
2. Similarly enter the prices for price codes #2 and #3.
 - The following display will appear.

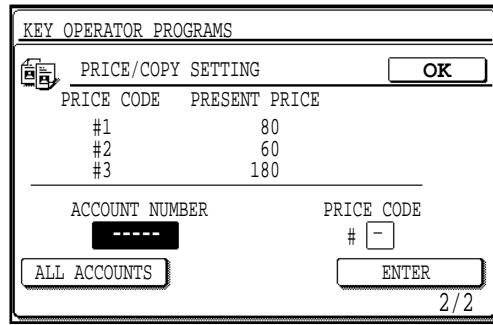

3. Enter the account number for which the price code is set, and then press the “ENTER” key.
 - To set a single price code for all accounts, press the “ALL ACCOUNTS” key and then press the “ENTER” key.
4. Enter the price code (#1 - #3) and then press the “ENTER” key.
 - If only the “ENTER” key is pressed without entering any price code, no price per code will be set.
5. Continue with steps 3 and 4 for other individual accounts.
 - Press the “OK” key to exit the program.

Account Limit Setting

This program is used to set the maximum number of copies which can be made against a registered account number.

When an optional printer expansion kit is installed, enabling of key operator program “RECORD COPY AND PRINT PER ACCOUNT” will disable the “ACCOUNT LIMIT SETTING”.

★ **KEY OPERATOR** See page 46 of the AR-PB2 A operation manual for the setting of key operator program “RECORD COPY AND PRINT PER ACCOUNT”.

When the “ACCOUNT LIMIT SETTING.” key is pressed, the following display will appear.

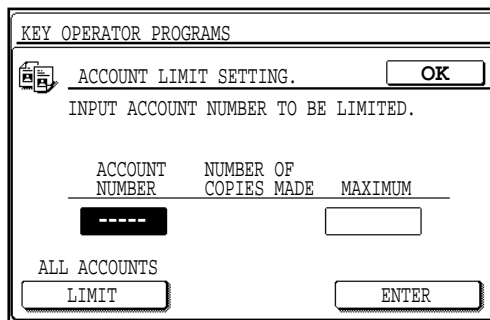

To set a limit

1. Enter the account number to be limited.

2. **Enter the upper limit (max. 999,999) for the account.**
 - If a limit for the account has been already set, the limit will be displayed. Press the CLEAR (C) key before entering a new upper limit.
 - To cancel a limit, press the CLEAR (C) key and proceed to step 3 without entering a limit.
3. **Press the “ENTER” key.**
4. **To limit other accounts, repeat steps 1 to 3. Press the “OK” key to exit the program.**

To set a limit for all accounts

1. **Press the “LIMIT” (ALL ACCOUNTS) key on the touch panel.**
 - “ALL” will appear under “ACCOUNT NUMBER”.
2. **Enter the upper limit (max. 999,999) for all accounts.**
 - To cancel the limit for all accounts, proceed to step 3 without entering a limit.
3. **Press the “ENTER” key.**
4. **Press the “OK” key to exit the program.**

Account Number Security

This program is used to make it difficult for users to gain access to accounts by entering code numbers through trial and error. If this program is selected and an operator enters three successive invalid account numbers, the copier will not accept another number for one minute and the message “PLEASE SEE YOUR KEY OPERATOR FOR ASSISTANCE.” will appear.

To enable the account number security function, press the check box of “ACCOUNT NUMBER SECURITY.” to display a check mark in the check box.

To disable this function, press the check box of this program again to clear the check mark in the check box.

OTHER FUNCTION SETTINGS

The programs of this category are used to adjust various settings of copier functions. These programs can be selected by pressing the "OTHER FUNCTION SETTINGS" key and then selecting the desired program key.

Key Operator Code Number Change



See page 8-2, KEY OPERATOR CODE NUMBER.

Exposure Adjustment

Use this program to lighten or darken copies in the automatic exposure mode. The factory setting is level 3.

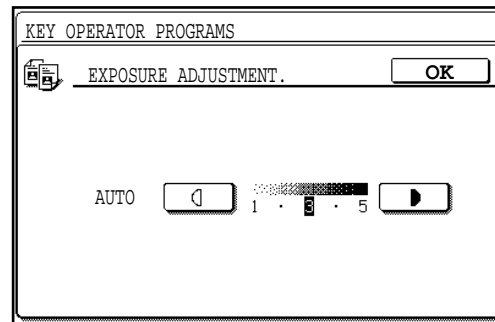
When the "EXPOSURE ADJUSTMENT." key is pressed, the following display will appear.



1. Adjust the exposure using the  and  keys.
2. Press the "OK" key.

Add or Change Extra Preset Ratios

Two extra preset copy ratios can be added within both the reduction range (25% to 99%) and the enlargement range (101% to 400%). Only added preset copy ratios can be changed. The standard preset copy ratios are fixed in memory and cannot be changed.

When the "ADD OR CHANGE EXTRA PRESET RATIOS." key is pressed, the following display will appear.

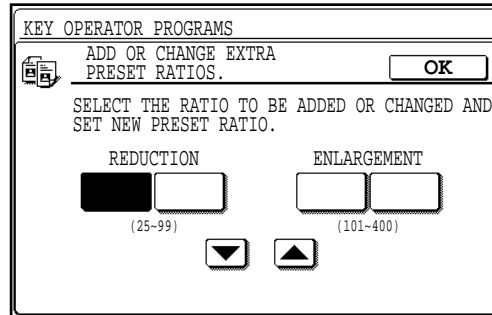

1. **Press a key under "REDUCTION" or "ENLARGEMENT" on the touch panel.**
 - The selected key will be highlighted.
2. **Use the ▼ and ▲ keys to set the desired copy ratio.**
 - To decrease or increase the copy ratio rapidly, press and hold the ▼ or ▲ key.
 - To add or change other extra preset copy ratios, repeat steps 1 and 2.
 - To cancel an extra preset ratio, select the copy ratio and press the CLEAR (C) key.
3. **Press the "OK" key.**

Setting a Maximum Number of Copies

Use this program to limit the maximum number of copies per copy run which can be input in the copy quantity display.

When the "SETTING A MAXIMUM NUMBER OF COPIES." key is pressed, the following display will appear.

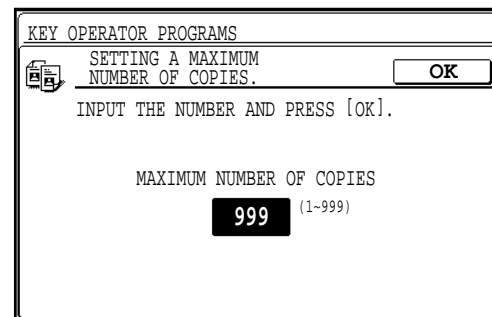



1. **Input the number using the 10-key pad.**
 - A number from 1 to 999 can be set.
2. **Press the "OK" key.**

Initial Margin Shift Setting

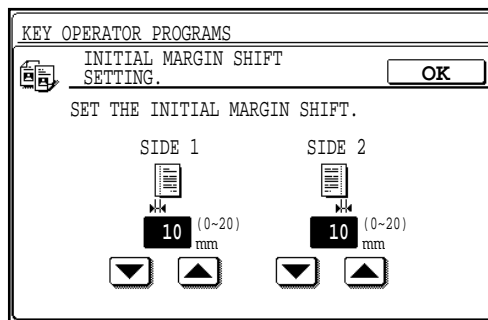
Set the initial margin shift value with this program.
When the "INITIAL MARGIN SHIFT SETTING." key is pressed, the following display will appear.





1. Adjust the value for each side using the  and  keys.
 - The value can be set from 0mm to 20mm in 1 mm increments (0" to 1" in 1/8" increments).
2. Press the "OK" key.

Erase Width Adjustment

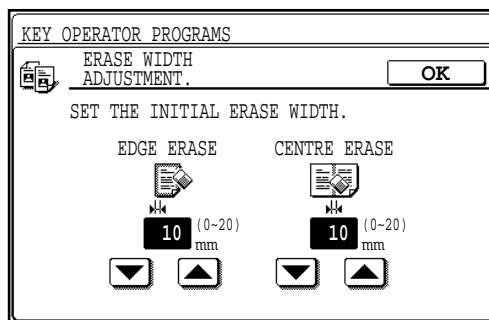
Set the initial setting of the amount of the erase area with this program.
When the "ERASE WIDTH ADJUSTMENT." key is pressed, the following display will appear.



1. Adjust the values for the edge erase mode and centre erase mode using the  and  keys.
 - The values can be set from 0mm to 20mm in 1mm increments (0" to 1" in 1/8" increments).
2. Press the "OK" key.

Initial Status Setting

The copier will assume the initial settings when it is turned on, when the CLEAR ALL (Ⓢ) key is pressed, or when the auto clear interval has elapsed after a copy run. Use this program to establish the initial settings.

When the "INITIAL STATUS SETTING." key is pressed, the following display will appear.

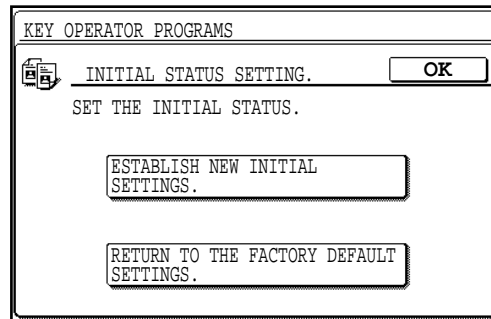

To establish new initial settings

1. Press the "ESTABLISH NEW INITIAL SETTINGS." key.
2. Select all initial settings on the operation panel.
 - The following functions cannot be set:
Number of copies, XY zoom, automatic copy ratio selection, interrupt, special functions, information, stapling position (for an optional finisher (AR-FN3)) and LCD contrast.
3. Press the "OK" key.

To return to the factory default settings

Press the "RETURN TO THE FACTORY DEFAULT SETTINGS." key.

Stream Feeding Mode

This program is used to enable the stream feeding mode of the document feeder. When the stream feeding mode is enabled, additional originals which are set in the document feeder tray within 5 seconds after the previous original was fed will be fed and copied automatically.

To enable the stream feeding mode, press the check box of "STREAM FEEDING MODE." to display a check mark in the check box.

To disable this mode, press the check box of this program again to clear the check mark in the check box.

- The stream feeding mode will only function when the group mode has been selected.

Staple Position Setting

This program is used to select the initial stapling position for an optional finisher (AR-FN3).

When the “STAPLE POSITION SETTING.” key is pressed, the following display will appear.

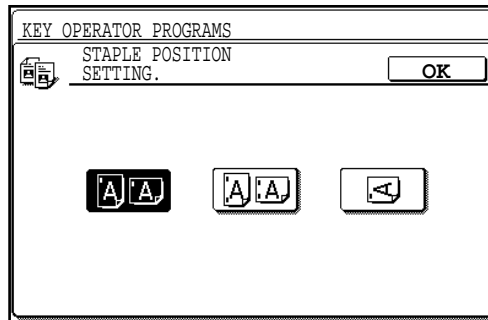

1. Select the desired stapling position on the touch panel.
2. Press the “OK” key.

Date Format Setting

This program is used to set the initial date format for the date function.

When the “DATE FORMAT SETTING.” key is pressed, the following display will appear.

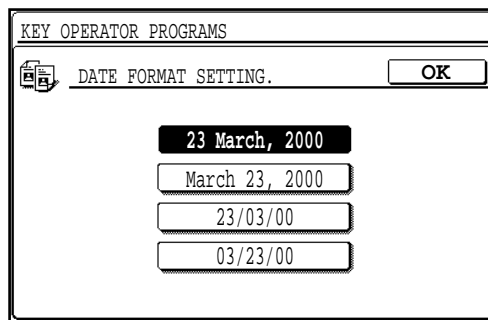

1. Select the desired date format on the touch panel.
 - The date formats displayed on the touch panel may be different from the illustration above depending on the country or region.
2. Press the “OK” key.

Date and Time Adjustment

This program is used to adjust the date and time which will be used for printing date.

When the "DATE AND TIME ADJUSTMENT." key is pressed, the following display will appear.

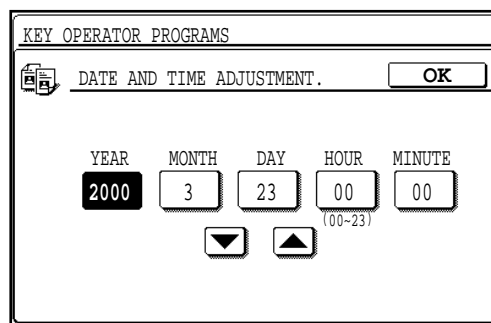

1. Select an item to be adjusted and adjust the value using the and keys.
 - Repeat this step for all desired items.
2. Press the "OK" key.
 - If an invalid date (example: February 31) has been entered in step 1, the "OK" key will be disabled.

Rotation Copy Setting

If this program is set, the image of originals will rotate when the orientation of the originals does not match that of the copy paper. Rotation copy will function only when the auto paper select or auto copy ratio mode has been selected.

When the STAPLE SORT function is used, rotation copy will not be performed even if this program has been set.

NOTE:

If the image is rotated in reduction copying, the position of the image in relation to copy paper will vary with the orientations of the originals and copy paper.

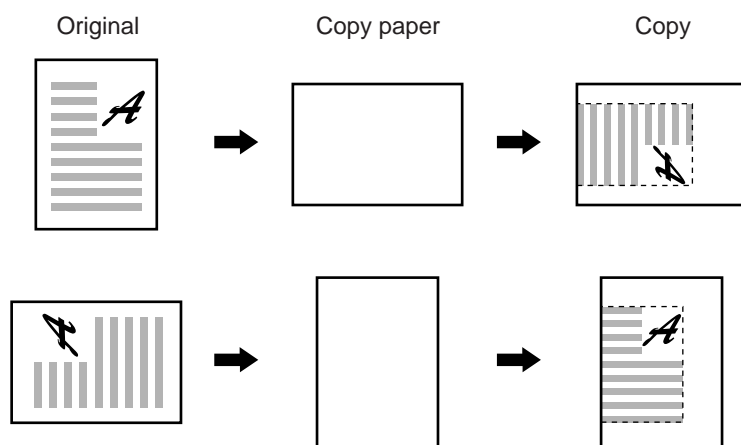

To enable rotation copy, press the check box of "ROTATION COPY SETTING." to display a check mark in the check box. To disable this mode, press the check box of this program again to clear the check mark in the check box.

Size Setting for [EXTRA]

The paper sizes in the paper trays (except an optional large capacity tray) can be changed by the users. The copier senses the paper sizes with the paper size indicators in the paper trays. If a paper size indicator is set to [EXTRA] and this program is used, the copier can sense paper sizes as selected on the setting screen.

When the "SIZE SETTING FOR [EXTRA]." key is pressed, the following display will appear.

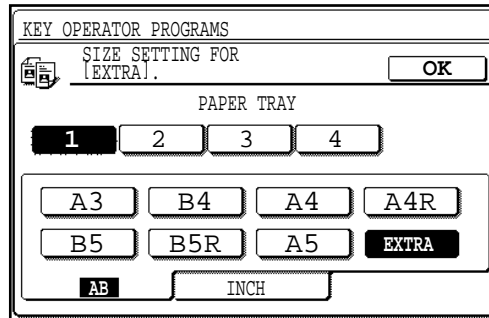

1. Select a paper tray on the touch panel.
2. Select a paper size for [EXTRA] setting.
To select a size of INCH series, press the "INCH" key and select a paper size.
 - Select the paper size which matches the paper to be loaded into the paper tray.
 - This setting can also be used for paper trays in an optional stand/ 500-sheet paper drawer (AR-DE7).
3. Press the "OK" key.

Heavy Paper on the Bypass Tray

In this copier, copies are normally delivered face down. Special paper including transparency film, however, cannot be delivered face down. If this program is set, any paper placed in the bypass tray will be regarded as special paper. Copies from the bypass tray will always be delivered face up. If this program is not set, paper type in the bypass tray can be specified. If plain paper is specified, copies will be delivered face down.

To regard paper placed in the bypass tray as special paper, press the check box of "HEAVY PAPER ON THE BYPASS TRAY." to display a check mark in the check box.

To enable selection of paper type placed in the bypass tray, press the check box of this program again to clear the check mark in the check box.

TIMER SETTINGS

The programs of this category are used to set the timers for some functions. These programs can be selected by pressing the “TIMER SETTINGS” key and then selecting the desired program key.

Auto Power Shut-off Timer

The auto power shut-off mode is a function to turn off the power automatically once a programmed length of time has elapsed without any copier operation after the last copy of a run is made or power is turned on.

This function lowers the user's electricity bill, reduces waste of natural resources, and cuts down on environmental pollution.

The programmed time is set to 90 minutes for this function on completion of shipment from the factory. The default time can be changed optionally within the prescribed range of time. We suggest you set the most appropriate time according to your usage pattern.

Use this program to set the time interval. The time until auto power shut-off occurs can be set in 1 minute increments up to a 4 hour maximum.

When the “AUTO POWER SHUT-OFF TIMER.” key is pressed, the following display will appear.

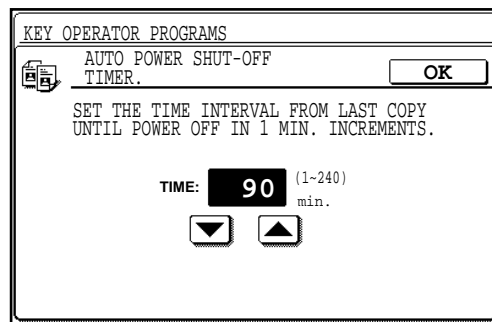

1. Enter the time interval using the ▼ and ▲ keys.
2. Press the “OK” key.

Auto Clear Setting

Use this program to set the time interval to return the copier to the initial settings after the last copy of a run has been completed. The time can be set from 10 to 240 seconds in 10 second increments.

When the “AUTO CLEAR SETTING.” key is pressed, the following display will appear.

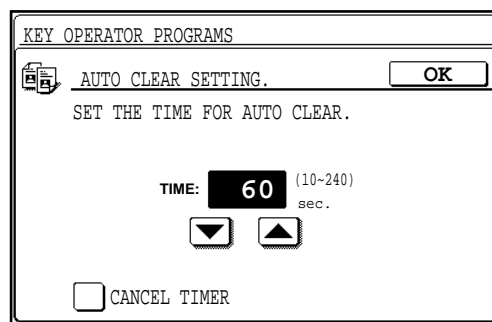

1. Set the desired time interval using the ▼ and ▲ keys.
 - To disable the auto clear, press the check box of “CANCEL TIMER” to display a check mark in the check box.
2. Press the “OK” key.

Preheat Mode Setting

Preheat mode functions to control the power consumption by lowering the temperature of the fusing unit to a programmed level once a programmed length of time has elapsed without any copier operation after the last copy of a run is made or power is turned on. This function lowers user's electricity bill, reduces waste of natural resources, and cuts down on environmental pollution. The programmed time is set to 15 minutes for this function on completion of shipment from the factory. The default time can be changed optionally within the prescribed range of time. We suggest you set the most appropriate time according to your usage pattern.

This program is used to set the time that elapses before the copier enters the preheat mode after copying is completed. The interval can be set between 1 and 240 minutes in 1 minute increments.

When the "PREHEAT MODE SETTING." key is pressed, the following display will appear.

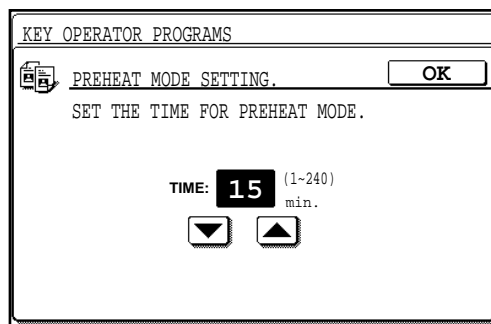



1. Set the desired time interval using the  and  keys.
2. Press the "OK" key.

Noise Level Reduce Mode

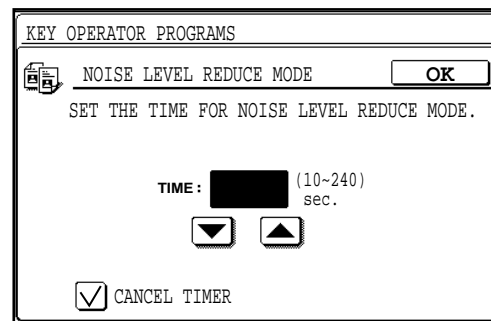
When the copier is programmed to enter the noise level reduce mode, the noise level will be reduced in the standby mode, however, the first copy time will be several seconds longer when the copier is in this mode. This program is used to set the time that elapses before the copier enters the noise level reduce mode after copying is completed. When the "NOISE LEVEL REDUCE MODE." key is pressed, the following display will appear.



1. Set the time using the  and  keys.
 - To enable the time setting, press the check box of the "CANCEL TIMER" to clear the check mark in the check box.
2. Press the "OK" key.

Message Time Setting

This program is used to adjust the length of time that messages are displayed in the range of 1 to 12 seconds in 1 second increments. When the "MESSAGE TIME SETTING." key is pressed, the following display will appear.

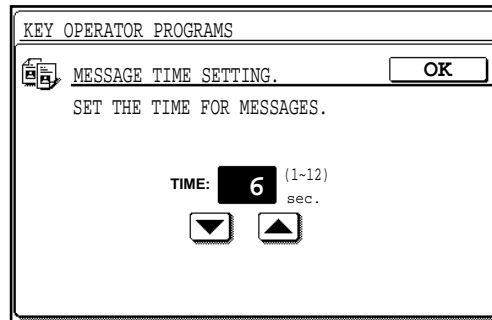

1. Set the time using the ▼ and ▲ keys.
2. Press the "OK" key.

ENABLE/DISABLE SETTINGS

The programs of this category are used to enable or disable some functions. These programs can be set or cancelled by pressing the check box of each program.

Disabling of Auto Paper Selection ---

This program is used to prevent automatic paper selection. When disabled, the copier will not automatically select a paper tray containing paper that matches the size of the original placed on the document glass or in the document feeder.

To disable auto paper selection, press the check box of “DISABLING OF AUTO PAPER SELECTION.” to display a check mark in the check box.

To restore this function, press the check box of this program again to clear the check mark in the check box.

Disabling of Auto Tray Switching ---

This program prevents automatic switching between the paper trays.

To disable auto tray switching, press the check box of “DISABLING OF AUTO TRAY SWITCHING.” to display a check mark in the check box.

To restore this function, press the check box of this program again to clear the check mark in the check box.

Disabling of Bypass-Tray in Duplex Copy ---

This program is used to disable the use of the bypass tray when making duplex copies.

To disable use of the bypass tray when making duplex copies, press the check box of “DISABLING OF BYPASS-TRAY IN DUPLEX COPY.” to display a check mark in the check box.

To restore use of the bypass tray, press the check box of this program again to clear the check mark in the check box.

Disabling Deletion of Job Programs

This program is used to prevent stored programs from being replaced or deleted. If this program is set, storing of job programs is also disabled.

To prevent job programs stored in memory from being replaced or deleted, press the check box of “DISABLING DELETION OF JOB PROGRAMS.” to display a check mark in the check box.

To allow replacement/deletion, press the check box of this program again to clear the check mark in the check box.

Disabling of Document Feeder

This program is used to prevent the use of the document feeder when it malfunctions.

To prohibit use of the document feeder, press the check box of “DISABLING OF DOCUMENT FEEDER.” to display a check mark in the check box.

To enable use of the document feeder, press the check box of this program again to clear the check mark in the check box.

Disabling of Duplex Copying

This program is used to enable or disable the duplex system. If a malfunction occurs within the duplex system of the copier, the system can be disabled until it is serviced. The rest of the copier in the meantime will remain operable.

To disable the duplex system, press the check box of “DISABLING OF DUPLEX COPYING.” to display a check mark in the check box.

To enable the duplex system, press the check box of this program again to clear the check mark in the check box.

KEY OPERATOR PROGRAMS

Disabling of Stapler

This program is used to enable or disable the stapler of the optional finisher (AR-FN3). If the stapler malfunctions, it can be disabled to prevent further malfunction or possible damage to the stapler until it is serviced.

**To disable the stapler, press the check box of “DISABLING OF STAPLER.” to display a check mark in the check box.
To enable the stapler, press the check box of this program again to clear the check mark in the check box.**

Disabling of Covers Mode

This program is used to prevent selection of the COVERS mode.

**To disable the COVERS mode, press the check box of “DISABLING OF COVERS MODE.” to display a check mark in the check box.
To enable use of the mode, press the check box of this program again to clear the check mark in the check box.**

Prohibit Auto Paper Selection from the Bypass-Tray

This program is used to prevent automatic paper selection from the bypass tray. In the default setting, auto paper selection from the bypass tray is disabled.

**To disable auto paper selection from the bypass tray, press the check box of “PROHIBIT AUTO PAPER SELECTION FROM THE BYPASS-TRAY.” to display a check mark in the check box.
To restore this function, press the check box of this program again to clear the check mark in the check box.**

NOTE:

Auto paper selection from the bypass tray is available only when Heavy Paper on the Bypass Tray program (see page 8-22) is not set and Prohibit Auto Paper Selection from the Bypass-Tray program is not set, either.

Disabling of PC/Modem Access

This program is used to determine whether persons other than persons who know the key operator code number will be permitted access via a computer or other equipment, either directly or through a telephone line, to the copier's key operator programs.

To require key operator code entry for access to key operator programs, press the check box of “DISABLING OF PC/MODEM ACCESS.” to display a check mark in the check box. To permit remote access to key operator programs without key operator code entry, press the check box of this program again to clear the check mark in the check box.

NOTE:

The customers must choose the setting of this program by themselves. If this program is not set, external operators can access the key operator programs from a computer or other equipment without key operator code entry. If this program is set, external operators must enter the key operator code to access the key operator programs. (This program is set in the factory default setting.)

Disabling of Auto Power Shut-off Mode ---

The auto power shut-off mode is used to turn off the power automatically once a programmed length of time has elapsed without any copier operation after the last copy of a run is made or power is turned on. This mode lowers the user's electricity bill, reduces waste of natural resources, and cuts down on environmental pollution.

Depending on how the machine is to be used, you may wish for some reasons to disable this mode. This can be done using this program.

NOTE:

Since we would like you to fully understand the purpose of this mode, we suggest that you enable this mode and set the most appropriate time using program “AUTO POWER SHUT-OFF TIMER” (page 8-23).

To disable the auto power shut-off mode, press the check box of “DISABLING OF AUTO POWER SHUT-OFF MODE.” to display a check mark in the check box.

To restore the mode, press the check box of this program again to clear the check mark in the check box.

Disabling of Beep When Keys Touched ---

This program is used to enable or disable the beep function. If this function is enabled, a beep sound will be produced when you press a key on the operation panel including the touch panel.

To disable the beep function, press the check box of “DISABLING OF BEEP WHEN KEYS TOUCHED.” to display a check mark in the check box.

To enable the beep function, press the check box of this program again to clear the check mark in the check box.

OTHER PROGRAMS

The following two programs are not included in the four categories. The programs can be selected by pressing the relevant key on the touch panel after the key operator program mode is selected.

Total Count

This program is used to display the total counts, including counts of the copier, document feeder, duplex module, and stapler.

An A3 (11" x 17") copy is counted as two copies.

Covers and transparency inserts are counted as one copy even if they are blank.

The lists printed with the key operator programs are included in "OTHERS". When the "TOTAL COUNT." key is pressed, the following display will appear.

KEY OPERATOR PROGRAMS	
TOTAL COUNT.	<input type="button" value="OK"/>
COPIES : 022,500	
DOCUMENT FEEDER : 012,000	
DUPLEX : 007,500	
STAPLER : 003,000	
OTHERS : 000,500	<input type="button" value="PRINT"/>

The total counts for all units in use will be displayed. To print these counts, press the "PRINT" key. Press the "OK" key to exit the program.

Program List Printout

This program is used to print out the list of available key operator programs.

Press the "PROGRAM LIST PRINTOUT." key.

- The copier will start printing. To stop printing after starting, press the "CANCEL" key.

KEY OPERATOR ASSISTANCE CALL

When the copier is in need of service or care not usually performed by general users, the copier will stop and one of the following messages listed below will appear.

Message	Remedy
CHECK STAPLER POSITION OR STAPLE JAM.	See page 7-12 for staple jam removal. If the trouble cannot be easily remedied, use key operator program "DISABLING OF STAPLER" (page 8-28) to prevent the use of the stapler. Contact your authorised Sharp Service Centre for service.
THE FINISHER IS OUT OF SERVICE. PRESS [CA] TO CANCEL JOB.	Contact your authorised Sharp Service Centre for service. (This message will appear when an optional finisher (AR-FN3) malfunctions.)
DUPLEX SYSTEM IS OUT OF SERVICE.	Use key operator program "DISABLING OF DUPLEX COPYING" (page 8-27) to prevent the use of the duplex system. Contact your authorised Sharp Service Centre for service.
THE DOCUMENT FEEDER IS OUT OF SERVICE. PRESS [CA] TO CANCEL JOB.	Use key operator program "DISABLING OF DOCUMENT FEEDER" (page 8-27) to prevent the use of the document feeder. Contact your authorised Sharp Service Centre for service.
SELECTED PAPER TRAY IS OUT OF SERVICE. PLEASE SELECT ANOTHER PAPER TRAY.	Contact your authorised Sharp Service Centre for service.
CALL FOR SERVICE. CODE:□□	With this message, an alphanumeric code will appear to indicate a malfunction has occurred which cannot be corrected by the key operator. Contact your authorised Sharp Service Centre for service. Be sure to report the alphanumeric code information as well. This will enable the Service Centre to prepare to correct the malfunction associated with the code.

KEY OPERATOR CODE NUMBER: FACTORY SETTING



The following is the factory setting of the Key Operator Code Number, which must be used to access the Key Operator Program.

Factory setting = 00000

This number must be entered when accessing the Key Operator Program for the first time. (See page 8-2.)

NOTE:

The Key Operator Code Number is an important security number allowing the Key Operator to configure the copier's functions and auditor's settings.

You should register your own code number — different from the factory setting above — immediately after your copier is installed.

★ **KEY OPERATOR**

Detach this page and store it in a safe place.



2000C DSC1
CINSE1982FC51

Required in IEC-950 (EN 60 950) - Europe

- The equipment should be installed near an accessible socket outlet for easy disconnection.

Required in Appendix ZB of BS 7002 (En 60 950) — United Kingdom

MAINS PLUG WIRING INSTRUCTIONS

The mains lead of this equipment is already fitted with a mains plug which is either a non-rewireable (moulded) or a rewireable type. Should the fuse need to be replaced, a BSI or ASTA approved fuse to BS1362 marked  or  and of the same rating as the one removed from the plug must be used.

Always refit the fuse cover after replacing the fuse on the moulded plug. Never use the plug without the fuse cover fitted.

In the unlikely event of the socket outlet in your home not being compatible with the plug supplied either cut-off the moulded plug (if this type is fitted) or remove by undoing the screws if a rewireable plug is fitted and fit an appropriate type observing the wiring code below.

DANGER: The fuse should be removed from the cut-off plug and the plug destroyed immediately and disposed of in a safe manner. Under no circumstances should the cut-off plug be inserted elsewhere into a 13A socket outlet as a serious electric shock may occur.

To fit an appropriate plug to the mains lead, follow the instructions below:

IMPORTANT: The wires in this mains lead are coloured in accordance with the following code:

GREEN-AND-YELLOW:	Earth
BLUE:	Neutral
BROWN:	Live

As the colours of the wires in this mains lead may not correspond with coloured markings identifying the terminals in your plug, proceed as follows:

The wire which is coloured **GREEN-AND YELLOW** must be connected to the terminal in the plug which is marked with the letter **E**, or by the safety earth symbol , or coloured green or green-and-yellow.

The wire which is coloured **BLUE** must be connected to the terminal which is marked with the letter **N** or coloured black.

The wire which is coloured **BROWN** must be connected to the terminal which is marked with the letter **L** or coloured red.

If you have any doubt, consult a qualified electrician.

WARNING: THIS APPARATUS MUST BE EARTHED.

SHARP[®]

SHARP ELECTRONICS (U.K.) LTD.

Sharp House, Thorp Road, Newton Heath, Manchester
M40 5BE

SHARP CORPORATION

PRINTED IN JAPAN
2000C DSC1
CINSE1982FC51

Free Manuals Download Website

<http://myh66.com>

<http://usermanuals.us>

<http://www.somanuals.com>

<http://www.4manuals.cc>

<http://www.manual-lib.com>

<http://www.404manual.com>

<http://www.luxmanual.com>

<http://aubethermostatmanual.com>

Golf course search by state

<http://golfingnear.com>

Email search by domain

<http://emailbydomain.com>

Auto manuals search

<http://auto.somanuals.com>

TV manuals search

<http://tv.somanuals.com>