

Facsimile Guide



TABLE OF CONTENTS

ABOUT THIS MANUAL	4
• MANUALS PROVIDED WITH THE MACHINE ...	4

1 BEFORE USING THE MACHINE AS A FAX

BASE SCREEN OF FAX MODE	6
• BASE SCREEN OF FAX MODE	7
• ADDRESS BOOK SCREEN	9
• CHANGING THE DISPLAY OF ONE-TOUCH KEYS IN THE ADDRESS BOOK SCREEN	10
FAX TRANSMISSION SEQUENCE	12

2 ENTERING DESTINATIONS

ENTERING A FAX NUMBER WITH THE NUMERIC KEYS	15
RETRIEVING A FAX NUMBER FROM THE ADDRESS BOOK	16
• RETRIEVING A STORED DESTINATION	17
• CHECKING AND DELETING ENTERED DESTINATIONS	18
USING A SEARCH NUMBER TO RETRIEVE A DESTINATION	19
RETRIEVING A DESTINATION FROM A GLOBAL ADDRESS BOOK	20
USING THE RESEND FUNCTION	22
CHAIN DIALLING	23

3 BASIC TRANSMISSION METHODS

TRANSMISSION METHODS	24
• PLACEMENT ORIENTATION OF THE ORIGINAL	26
• AUTOMATIC REDUCTION OF THE TRANSMITTED IMAGE	26
• TRANSMITTABLE ORIGINAL SIZES	27
• THE SIZE OF THE PLACED ORIGINAL	27
• WHEN THE LINE IS BUSY	28
• WHEN A COMMUNICATION ERROR OCCURS	28
USING THE AUTOMATIC DOCUMENT FEEDER FOR TRANSMISSION	29
• USING THE AUTOMATIC DOCUMENT FEEDER TO SEND A FAX IN DIRECT TRANSMISSION MODE	30

USING THE DOCUMENT GLASS FOR TRANSMISSION	32
• USING THE DOCUMENT GLASS TO SEND A FAX IN DIRECT TRANSMISSION MODE	34
TRANSMISSION USING THE SPEAKER	36
SENDING THE SAME FAX TO MULTIPLE DESTINATIONS (Broadcast Transmission)	37
SENDING A FAX DIRECTLY FROM A COMPUTER (PC-Fax)	42
IMAGE SETTINGS	43
• AUTOMATICALLY SCANNING BOTH SIDES OF AN ORIGINAL (2-Sided Original)	44
• SPECIFYING THE SCAN SIZE AND SEND SIZE (Enlarge/Reduce Transmission)	45
• CHANGING THE EXPOSURE	52
• CHANGING THE RESOLUTION	53

4 FAX RECEPTION

RECEIVING FAXES	55
• RECEIVING A FAX	56
• RECEIVING A FAX MANUALLY	57
• PRINTING A PASSWORD-PROTECTED FAX (Hold Setting For Received Data Print)	57
FORWARDING RECEIVED FAXES (Fax Data Forward)	58
FORWARDING A RECEIVED FAX TO AN E-MAIL ADDRESS (Inbound Routing Settings)	59

5 SPECIAL MODES

SPECIAL MODES	60
STORING FAX OPERATIONS (Program)	62
• USING A PROGRAM TO SEND A FAX	63
ERASING PERIPHERAL SHADOWS ON THE IMAGE (Erase)	65
TRANSMITTING AN ORIGINAL AS TWO SEPARATE PAGES (Dual Page Scan)	67
SENDING A FAX AT A SPECIFIED TIME (Timer) ..	70
SENDING TWO PAGES AS A SINGLE PAGE (2in1)	73
SENDING BOTH SIDES OF A CARD AS A SINGLE PAGE (Card Shot)	76
SENDING A LARGE NUMBER OF PAGES (Job Build)	79

TRANSMITTING ORIGINALS OF DIFFERENT SIZES (Mixed Size Original)	82
FAXING THIN ORIGINALS (Slow Scan Mode)	84
ADDING YOUR SENDER INFORMATION TO FAXES (Own number sending)	86
• TEMPORARILY CHANGING THE SENDER INFORMATION (Own Name Select)	87
CALLING A FAX MACHINE AND INITIATING RECEPTION (Polling)	88
• INITIATING POLLING RECEPTION MANUALLY	90
SENDING A FAX WHEN ANOTHER MACHINE POLLS YOUR MACHINE (Polling Memory)	91
• RESTRICTING POLLING ACCESS (Polling security)	91
• SCANNING A DOCUMENT INTO POLLING MEMORY	92
• PRINTING A DOCUMENT STORED IN THE PUBLIC BOX	94
• DELETING A DOCUMENT FROM THE PUBLIC BOX	95

6 PERFORMING F-CODE COMMUNICATION

F-CODE COMMUNICATION	96
• HOW F-CODES WORK	96
• CREATING MEMORY BOXES IN THE MACHINE FOR F-CODE COMMUNICATION	97
• F-CODE DIALLING	97
CONFIDENTIAL COMMUNICATION USING F-CODES	98
• F-CODE CONFIDENTIAL TRANSMISSION	99
• PRINTING A FAX RECEIVED BY F-CODE CONFIDENTIAL RECEPTION	100
POLLING RECEPTION USING F-CODES	102
POLLING MEMORY TRANSMISSION USING F-CODES	104
• SCANNING A DOCUMENT INTO A MEMORY BOX FOR F-CODE POLLING TRANSMISSION	104
• PRINTING A DOCUMENT STORED FOR F-CODE POLLING TRANSMISSION.	107
• DELETING A DOCUMENT STORED FOR F-CODE POLLING TRANSMISSION.	108
RELAY REQUEST TRANSMISSION USING F-CODES	109
RELAY BROADCAST TRANSMISSION USING F-CODES	111

7 USING AN EXTENSION PHONE

CONNECTING AND USING AN EXISTING PHONE (Extension Phone Connection)	112
• RECEIVING A FAX AFTER ANSWERING A CALL ON THE EXTENSION PHONE (Remote Reception)	113
• MAKING AND RECEIVING PHONE CALLS	113

8 CHECKING THE STATUS OF FAX JOBS

JOB STATUS SCREEN	114
• JOB QUEUE SCREEN AND COMPLETED JOB SCREEN.	115
• OPERATION WHEN A JOB IN THE JOB QUEUE IS COMPLETED	118
• CHECKING A RESERVED JOB OR THE JOB IN PROGRESS.	119
• CHECKING COMPLETED JOBS.	120
CANCELLING A FAX IN PROGRESS OR A RESERVED FAX	121
GIVING PRIORITY TO A RESERVED FAX JOB	123

9 PRINTING A TRANSACTION REPORT / IMAGE SENDING ACTIVITY REPORT

TRANSACTION REPORT	124
• CHANGING THE TRANSACTION REPORT PRINT CONDITION FOR A SINGLE TRANSMISSION	125
• INFORMATION APPEARING IN THE RESULT COLUMN	126
IMAGE SENDING ACTIVITY REPORT	127

10 IF THE MACHINE IS MOVED

CONNECTIONS AND SETTINGS AFTER THE MACHINE IS MOVED	128
• CONNECTION TO THE TELEPHONE LINE	128
• MAKE SURE THE MAIN POWER SWITCH IS IN THE "ON" POSITION.	129
• CHECKING THE DATE AND TIME	130
• CHANGING THE SENDER FAX NUMBER	130

ABOUT THIS MANUAL

Please note

- For information on installing the drivers and software cited in this manual, please refer to the Software Setup Guide.
- For information on your operating system, please refer to your operating system manual or the online Help function.
- Considerable care has been taken in preparing this manual. If you have any comments or concerns about the manual, please contact your dealer or nearest authorised service representative.
- This product has undergone strict quality control and inspection procedures. In the unlikely event that a defect or other problem is discovered, please contact your dealer or nearest authorised service representative.
- Aside from instances provided for by law, SHARP is not responsible for failures occurring during the use of the product or its options, or failures due to incorrect operation of the product and its options, or other failures, or for any damage that occurs due to use of the product.

Warning

- Reproduction, adaptation or translation of the contents of the manual without prior written permission is prohibited, except as allowed under copyright laws.
- All information in this manual is subject to change without notice.

Illustrations and the operation panel and touch panel shown in this manual

The peripheral devices are generally optional, however, some models include certain peripheral devices as standard equipment. The explanations in this manual assume that a saddle stitch finisher, punch module, and inserter are installed on the machine. For some functions and procedures, the explanations assume that devices other than the above are installed.

The display screens, messages, and key names shown in the manual may differ from those on the actual machine due to product improvements and modifications.

MANUALS PROVIDED WITH THE MACHINE

Printed manuals and manuals stored in PDF format on the machine's hard drive are provided with the machine. When using the machine, read the appropriate manual for the feature you are using.

Printed manuals

Manual name	Contents
Safety Guide	This manual contains instructions for using the machine safely and lists the specifications of the machine and its peripheral devices.
Software Setup Guide	This manual explains how to install the software and configure settings to use the machine as a printer or scanner.
Quick Start Guide	This manual provides easy-to-understand explanations of all the functions of the machine in a single volume. Detailed explanations of each of the functions can be found in the manuals in PDF format.
Troubleshooting	This manual explains how to remove paper misfeeds and provides answers to frequently asked questions regarding the operation of the machine in each mode. Refer to this manual when you have difficulty using the machine.





Operation manuals in PDF format

The manuals in PDF format provide detailed explanations of the procedures for using the machine in each mode. To view the PDF manuals, download them from the hard drive in the machine. The procedure for downloading the manuals is explained in "How to download the manuals in PDF format" in the Quick Start Guide.

Manual name	Contents
User's Guide	This manual provides information, such as basic operation procedures, how to load paper, and machine maintenance.
Copier Guide	This manual provides detailed explanations of the procedures for using the copy function.
Printer Guide	This manual provides detailed explanations of the procedures for using the printer function.
Facsimile Guide (This manual)	This manual provides detailed explanations of the procedures for using the fax function.
Scanner Guide	This manual provides detailed explanations of the procedures for using the scanner function and the Internet fax function.
Document Filing Guide	This manual provides detailed explanations of the procedures for using the document filing function. The document filing function allows you to save the document data of a copy or fax job, or the data of a print job, as a file on the machine's hard drive. The file can be called up as needed.
System Settings Guide	This manual explains the "System Settings", which are used to configure a variety of parameters to suit the aims and the needs of your workplace. Current settings can be displayed or printed out from the "System Settings".

Icons used in the manuals

The icons in the manuals indicate the following types of information:

	This alerts you to a situation where there is a risk of machine damage or failure.		This indicates the name of a system setting and provides a brief explanation of the setting. For detailed information on each system setting, see the System Settings Guide. When "System Settings:" appears: A general setting is explained. When "System Settings (Administrator):" appears: A setting that can only be configured by an administrator is explained.
	This provides a supplemental explanation of a function or procedure.		
	This explains how to cancel or correct an operation.		

1

BEFORE USING THE MACHINE AS A FAX

This section provides information that you should know before using the machine as a fax machine.

BASE SCREEN OF FAX MODE

To use the fax function, select settings and operations in the base screen of fax mode. To display the base screen of fax mode, touch the [IMAGE SEND] key and then touch the [Fax] tab.

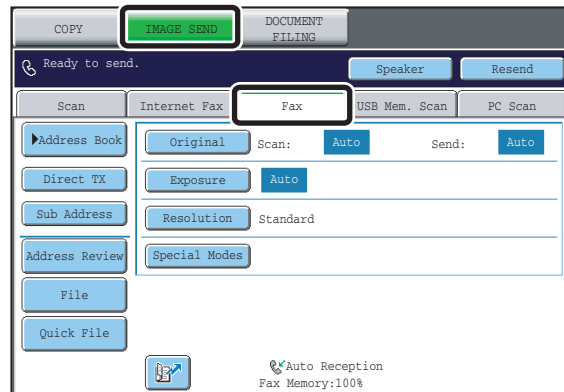

This screen only appears when the fax function or Internet fax function has been installed. The contents of the screen will vary depending on the devices that are installed.

Each of the other modes that can be displayed by pressing the [IMAGE SEND] key (scan, Internet fax, USB memory, and PC scan modes) also have base screens.

Transmission destinations can be stored in one-touch keys in the address book and retrieved from the address book screen when you need to use them. The address book is shared by fax mode, scan mode, and Internet fax mode. To display the address book screen, touch the [Address Book] key in the base screen. To display the base screen, touch the [Condition Settings] key in the address book screen. This manual refers to the base screen of fax mode as the "base screen".

Base screen of fax mode

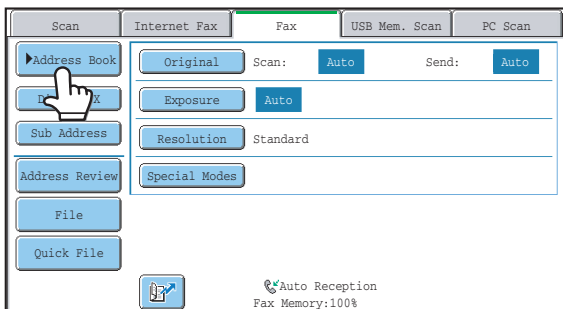

Address book screen

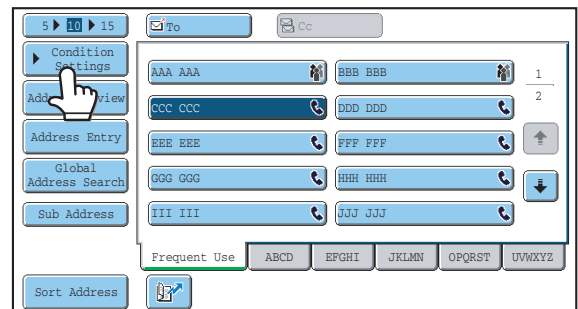

The procedures in this manual begin from the base screen of fax mode.



System Settings (Administrator): Default Display Settings

One of the following screens can be selected for the initial screen that appears when the [IMAGE SEND] key is touched.

- Base screen of each mode (scan, Internet fax, fax, or data entry mode)
- Address book screen (alphabetical/custom index)

BASE SCREEN OF FAX MODE

This screen is used to select settings and operations in fax mode.

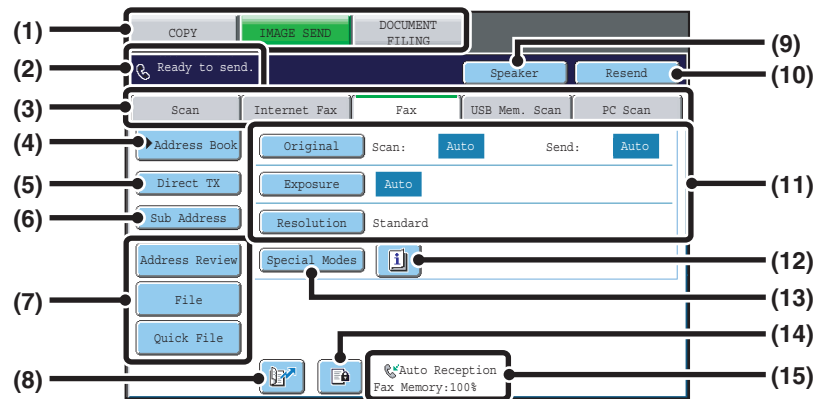

(1) Mode select keys

Use these keys to switch between copy, image send, and document filing modes.
To switch to fax mode, touch the [IMAGE SEND] key.

(2) This shows various messages and the destinations that have been entered.

The  icon on the left indicates fax mode.

(3) Send mode tabs

Use these keys to change the mode of the image send function. Tabs of modes that cannot be used because the appropriate options (Internet fax expansion kit, application integration module) are not installed do not appear.

If the [Fax] tab does not appear, touch the  tab to move the screen.

[BASE SCREEN OF FAX MODE](#) (page 6)

(4) [Address Book] key

Touch this key to dial using a one-touch key or group key. When the key is touched, the address book screen appears.

[RETRIEVING A FAX NUMBER FROM THE ADDRESS BOOK](#) (page 16)

(5) [Direct TX] key

Touch this key to send a fax by direct transmission. When the [Direct TX] key is not highlighted, normal transmission (memory TX mode) is selected.

[To fax a large number of sheet originals, use the automatic document feeder.](#) (page 24)

[If you wish to send a fax ahead of other previously reserved fax transmissions, use direct transmission mode.](#) (page 25)

(6) [Sub Address] key

Touch this key to enter a sub-address and passcode for F-code transmission.

[F-CODE DIALLING](#) (page 97)

(7) Customized keys

The keys that appear here can be changed to show settings or functions that you prefer.

[Customizing displayed keys](#) (page 8)

(8) key

Touch this key to dial a fax destination using a search number.

[USING A SEARCH NUMBER TO RETRIEVE A DESTINATION](#) (page 19)

(9) [Speaker] key / [Pause] key / [Space] key

Touch this key to dial using the speaker.

When entering a fax number to be dialled, the key changes to the [Pause] key. When entering a sub-address, the key changes to the [Space] key.

[TRANSMISSION USING THE SPEAKER](#) (page 36)

(10) [Resend] key / [Next Address] key

Touch this key to redial a fax number. When entering a fax number to be dialled, this key changes to the [Next Address] key.

[USING THE RESEND FUNCTION](#) (page 22)

(11) Image settings

Image settings (original size, exposure, resolution) can be selected.

[IMAGE SETTINGS](#) (page 43)

(12) key

This key appears when a special mode or 2-sided scanning is selected. Touch the key to display the selected special modes.

[Checking what special modes are selected](#) (page 8)

(13) [Special Modes] key

Touch this key to use a special mode.

[5. SPECIAL MODES](#) (page 60)

(14)  key

When "Hold Setting for Received Data Print" is enabled, this appears when a fax has been received. Touch this key to open a password entry screen. Enter the set password to print the received fax.

 [PRINTING A PASSWORD-PROTECTED FAX \(Hold Setting For Received Data Print\)](#) (page 57)

(15) This shows the currently selected fax reception mode and the amount of free memory remaining.

 [RECEIVING FAXES](#) (page 55)

Customizing displayed keys

Special mode keys and other keys can be displayed in the base screen. You can assign frequently used functions to these keys to access the functions with a single touch. To change the function that is assigned to a key, use "Customize Key Setting" in the Web pages. The following keys appear by factory default:

• **[Address Review] key**

Touch this key to display a list of the destinations that have been selected in the address book. This is the same key as the [Address Review] key in the address book screen.

• **[File] key, [Quick File] key**

Touch either key to use Quick File or File in document filing mode. For more information on the document filing function, see the Document Filing Guide.

Example: When "Dual Page Scan", "Job Build", and "Mixed Size Original" are assigned to the customized keys.

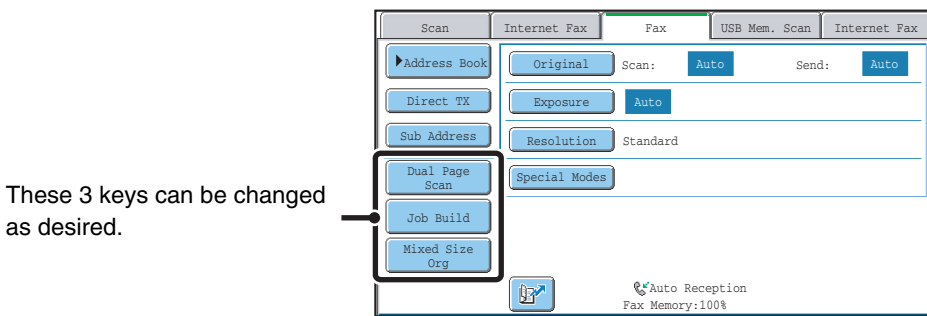

Displaying a program key in the base screen will enable you to call up the program by simply touching the key.

 [STORING FAX OPERATIONS \(Program\)](#) (page 62)



System Settings (Administrator): Customize Key Setting

Registration is performed in [System Settings] - [Operation Settings] - "Customize Key Setting" in the Web page menu.

Checking what special modes are selected

The  key appears in the base screen when a special mode or 2-sided scanning is selected.

The  key can be touched to display the selected special modes. To close the screen, touch the [OK] key.

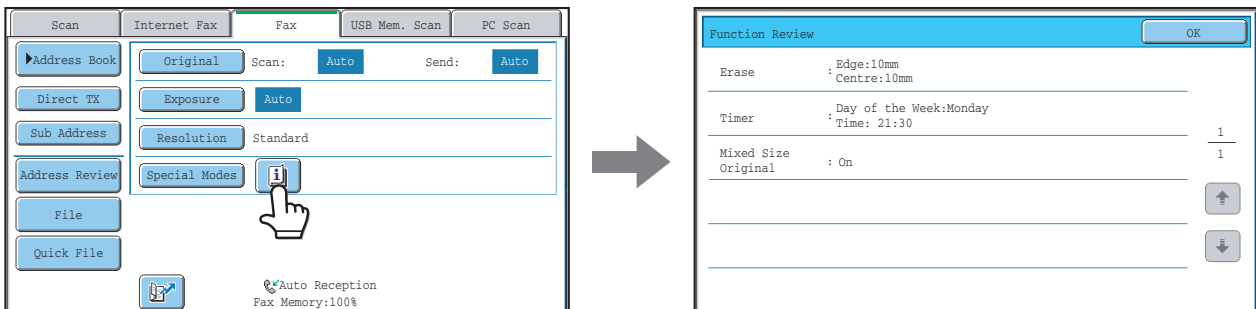

The special mode settings cannot be changed from the function review screen. To change a setting, touch the [OK] key to close the function review screen and then touch the [Special Modes] key and select the setting that you wish to change.

ADDRESS BOOK SCREEN

This screen is used to select a destination from the list of stored destinations.

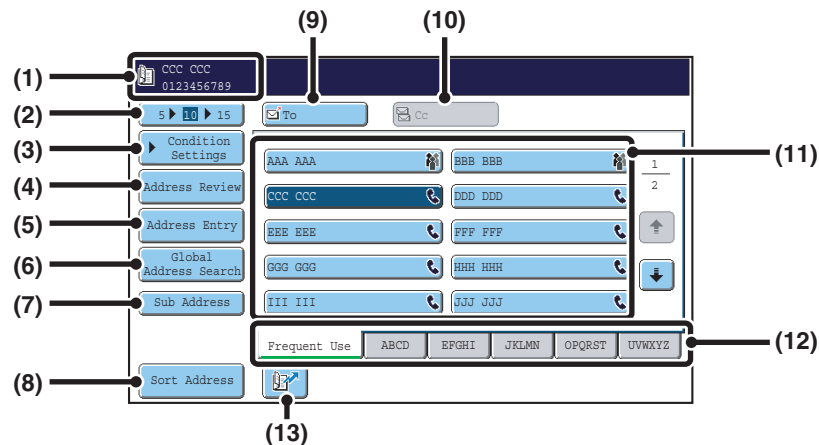

(1) This shows the destination that has been selected.

(2) **Number of displayed items selector key**
Touch to change the number of destinations (one-touch keys) displayed in the address book screen. Select 5, 10, or 15 destinations.

(3) **[Condition Settings] key**
Touch this key to select transmission settings and operations. When the key is touched, the base screen appears.
☞ [BASE SCREEN OF FAX MODE](#) (page 7)

(4) **[Address Review] key**
Touch this key to view a list of the selected destinations. The selected destinations can be changed.
☞ [CHECKING AND DELETING ENTERED DESTINATIONS](#) (page 18)

(5) **[Address Entry] key**
Not used in fax mode.

(6) **[Global Address Search] key**
When the use of an LDAP server has been enabled in the machine's Web page, a fax number can be obtained from a global address book.
☞ [RETRIEVING A DESTINATION FROM A GLOBAL ADDRESS BOOK](#) (page 20)

(7) **[Sub Address] key**
Touch this key to enter a sub-address and passcode for F-code transmission.
☞ [F-CODE DIALLING](#) (page 97)

(8) **[Sort Address] key**
Touch this key to change the index tabs to custom indexes or to display one-touch keys by send mode.

☞ [CHANGING THE DISPLAY OF ONE-TOUCH KEYS IN THE ADDRESS BOOK SCREEN](#) (page 10)

(9) **[To] key**
Touch this key to enter a selected destination (one-touch key).
☞ [RETRIEVING A STORED DESTINATION](#) (page 17)

(10) **[Cc] key**
Not used in fax mode.

(11) **One-touch key display**
This shows the one-touch keys of the destinations that have been stored in the address book. This manual refers to keys in which single destinations and groups are stored as one touch keys. Keys that have fax numbers stored are indicated by ☎.
☞ [RETRIEVING A STORED DESTINATION](#) (page 17)

(12) **Index tabs**
Touch this to change indexes.
☞ [RETRIEVING A STORED DESTINATION](#) (page 17)

(13) **☎ key**
Touch this key to retrieve a destination using a search number.
☞ [USING A SEARCH NUMBER TO RETRIEVE A DESTINATION](#) (page 19)



Destinations stored for the network scanner and Internet fax functions are indicated by a different icon.

[RETRIEVING A FAX NUMBER FROM THE ADDRESS BOOK](#) (page 16)



• **System Settings: Address Book**

This is used to store fax numbers in one-touch keys.

• **System Settings (Administrator): The Number of Direct Address Keys Displayed Setting**

This is used to change the default setting for the number of one-touch keys displayed in the address book screen.

• **System Settings (Administrator): Default Display Settings**

One of the following screens can be selected for the initial screen that appears when the [IMAGE SEND] key is touched.

- Base screen of each mode (scan, Internet fax, fax, or data entry mode)
- Address book screen (alphabetical/custom index)

CHANGING THE DISPLAY OF ONE-TOUCH KEYS IN THE ADDRESS BOOK SCREEN

You can show only destinations of a specific transmission mode in the address book screen, or change the displayed index tabs from the alphabetical tabs to the custom tabs. The procedure for selecting destinations does not change.

1

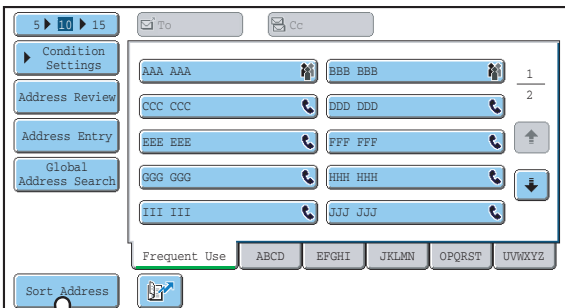

Touch the [Sort Address] key.

2

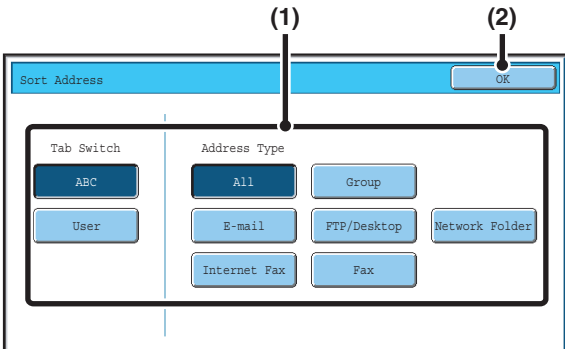

Change the display mode.

(1) Touch the key of the mode or tab that you wish to display.

- To show only the one-touch keys of a particular send mode, touch the desired mode key under "Address Type".
- To change the index tabs to the custom indexes, touch the [User] key under "Tab Switch".

(2) Touch the [OK] key.

Index display

Indexes make it easy to search for a destination (one-touch key). Destinations are grouped on alphabetical index tabs by their initials. To display a stored destination, touch the appropriate index tab. It is convenient to store frequently used destinations in the [Frequent Use] index. Specify that a destination be displayed in the [Frequent Use] index when you store the destination.

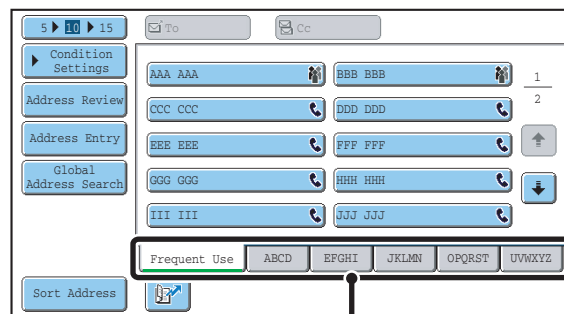

Index tabs

The destinations can be displayed in alphabetical order by their initials.

Each time the displayed index tab is touched, the display order changes in the following order: search numbers (page 19), ascending names, descending names, search numbers... When the display order is changed, the display order of the other index tabs also changes.

Ordered by search number (default)

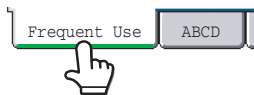

Ascending names



Descending names



Index names can be changed using "Custom Index" in the system settings, allowing you to create groups of one-touch keys that can be easily recognized. For more information on "Custom Index", see the System Settings Guide.



System Settings: Custom Index

This is used to store custom index names. The custom index where a one-touch key appears is specified when the transmission destination is stored in the key.

FAX TRANSMISSION SEQUENCE

This section explains the basic procedure for sending a fax.

Place the original.

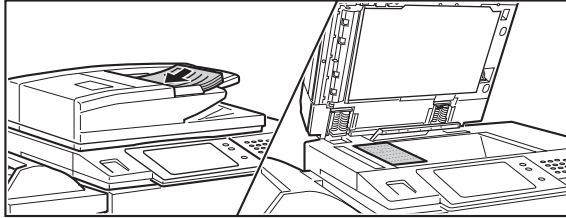

Place the original in the document feeder tray of the automatic document feeder, or on the document glass.



Change the mode.

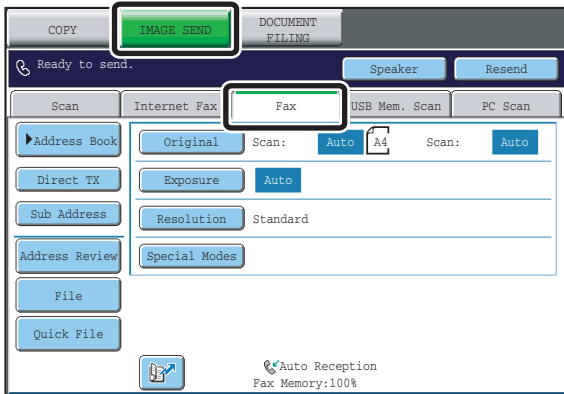

Change to fax mode.

Touch the [IMAGE SEND] key and then the [Fax] tab.

➤ [BASE SCREEN OF FAX MODE](#) (page 6)



Select image settings.

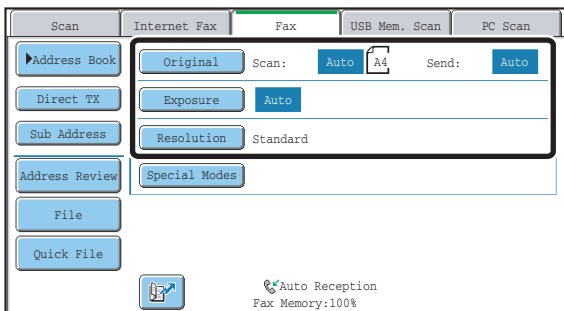

Select settings for the original to be faxed.

- [Original] key: Use this key to select the original size, the original send size, and 2-sided original scanning.
 - [SPECIFYING THE SCAN SIZE AND SEND SIZE \(Enlarge/Reduce Transmission\)](#) (page 45), [AUTOMATICALLY SCANNING BOTH SIDES OF AN ORIGINAL \(2-Sided Original\)](#) (page 44)
- [Exposure] key: Use this key to adjust the exposure of the image.
 - [CHANGING THE EXPOSURE](#) (page 52)
- [Resolution] key: Use this key to adjust the resolution of the image.
 - [CHANGING THE RESOLUTION](#) (page 53)



Special mode settings

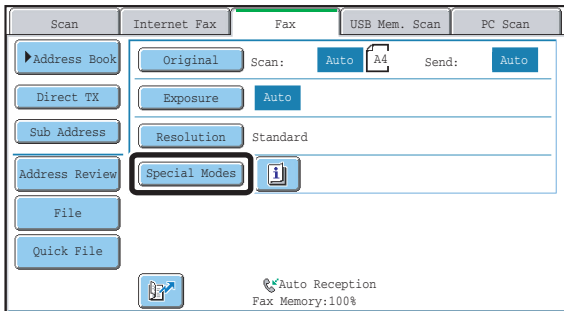

Touch the [Special Modes] key to select special modes such as timer transmission and the erase function.



Enter the destination fax number

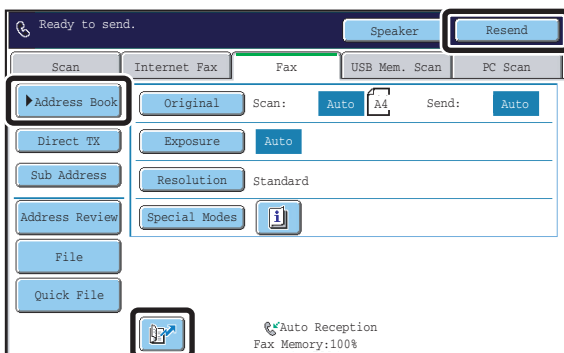

or



- [Address Book] key: Select a destination that is stored in the address book or look up a destination in a global address book.
 - [RETRIEVING A FAX NUMBER FROM THE ADDRESS BOOK](#) (page 16)
-  key: Use a search number to specify a destination stored in the address book.
 - [USING A SEARCH NUMBER TO RETRIEVE A DESTINATION](#) (page 19)
- [Resend] key: Select a fax number from the last eight destinations used for transmission.
 - [USING THE RESEND FUNCTION](#) (page 22)
- Numeric keys: Enter a fax number.
 - [ENTERING A FAX NUMBER WITH THE NUMERIC KEYS](#) (page 15)



Begin transmission

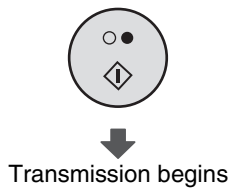

Scan the original and send the fax.

If the original is placed on the document glass, follow these steps to start scanning and transmission:

When sending a fax normally (memory transmission)

- (1) Press the [BLACK & WHITE START] key (○●).
- (2) When scanning is finished, replace the original with the next original.
- (3) Press the [BLACK & WHITE START] key (○●).
- (4) Repeat steps (2) and (3) until all originals have been scanned.
- (5) Touch the [Read-End] key.

When sending a fax in direct transmission mode

Multiple originals cannot be scanned in direct transmission mode.

Press the [BLACK & WHITE START] key (○●) to start transmission.



When transmission ends, image settings and convenient special mode settings are cleared.



To cancel scanning...

Press the [STOP] key (⊘).



System Settings (Administrator): Default Display Settings

The settings can be kept in effect a fixed period of time after scanning is completed.

2

ENTERING DESTINATIONS

This chapter explains how to enter destination fax numbers.

Destination fax numbers can be entered using the numeric keys, or by retrieving a previously stored fax number using the address book or a search number.

ENTERING A FAX NUMBER WITH THE NUMERIC KEYS



Enter the destination fax number with the numeric keys.



Take care to enter the correct number.



If an incorrect number is entered...

Press the [CLEAR] key (C) to clear the number and then enter the correct number.

Entering a pause between digits of the number

Enter a pause after the number used to dial out from a PBX (for example, after "0"), or after the country code when dialling an international number.

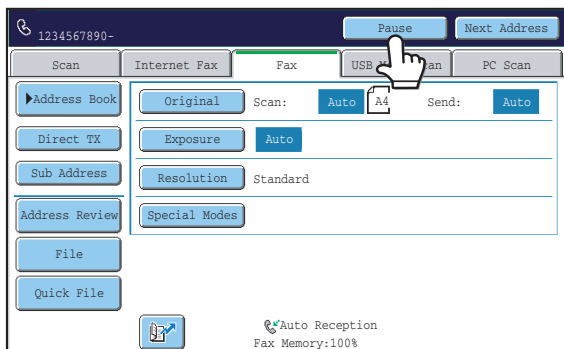

Touch the [Pause] key.

A hyphen "-" is entered when the [Pause] key is touched once.



System Settings (Administrator): Pause Time Setting

This is used to set the length of pauses. The default setting is 2 seconds.

RETRIEVING A FAX NUMBER FROM THE ADDRESS BOOK

The address book screen shows stored destinations as one-touch keys.

A destination fax number is retrieved by simply touching the one-touch key of that destination. This is called "one-touch dialling". It is also possible to store multiple fax numbers in a one-touch key, allowing you to retrieve all the numbers by simply touching the key. This is called "group dialling". This dialling method is convenient when you wish to send a fax to (or poll) multiple fax destinations.

One-touch keys are grouped on alphabetical index tabs to make it easy to find a destination.

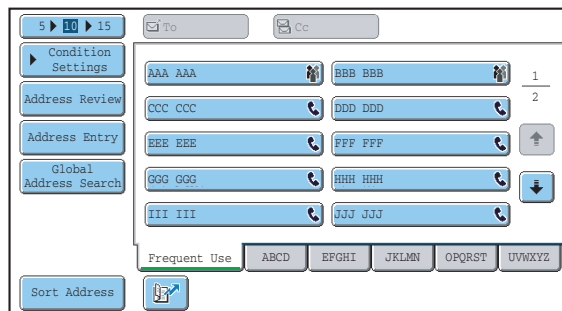

When destinations of other scan modes are stored in addition to fax destinations, an icon indicating the mode appears together with the name of the destination in each one-touch key.

Icon	Mode
	Fax
	When multiple destinations are stored
	Scan to E-mail
	Internet Fax
	Scan to FTP
	Scan to Network Folder
	Scan to Desktop



System Settings: Address Book

This is used to store destinations (names and fax numbers) in the address book.

RETRIEVING A STORED DESTINATION

A destination fax number is retrieved by simply touching the one-touch key of that destination.

1

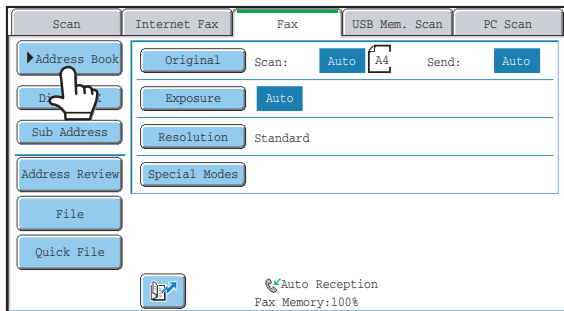

Touch the [Address Book] key.

2

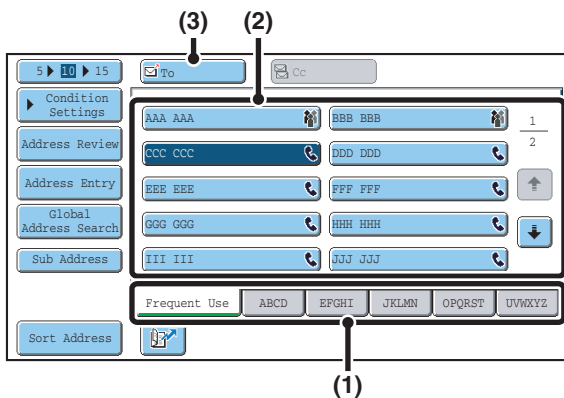

Select the destination.

(1) Touch the index tab where the destination is stored.

(2) Touch the one-touch key of the desired destination.

If you select an incorrect destination, touch the key again to cancel the selection.

(3) Touch the [To] key.

This enters the selected destination.



- Frequently used destinations can be displayed in the [Frequent Use] index. Specify that a destination be displayed in the [Frequent Use] index when you store the destination.
- **To continue specifying other destinations...**
Touch the [Next Address] key and repeat (2) and (3) of this step.



• System Settings (Administrator): Must Input Next Address Key at Broadcast Setting

This setting determines whether or not the [Next Address] key can be omitted before specifying the next destination. Factory default setting: The [Next Address] key can be omitted.

• System Settings (Administrator): Disable Switching of Display Order

This is used to disable switching of the order of display of the one-touch keys in the address book screen. The currently selected display order will be the order that is used after this setting is enabled.

CHECKING AND DELETING ENTERED DESTINATIONS

When multiple destinations have been entered, you can display and check the destinations. You can also delete a destination (cancel selection of the destination).

1

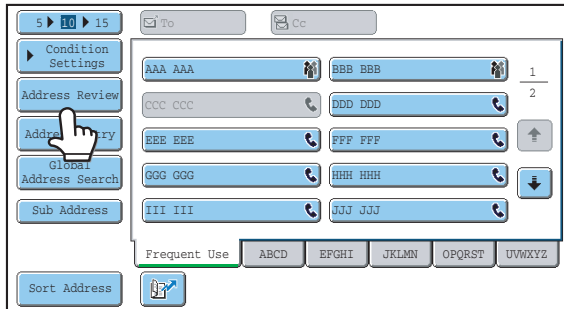

Touch the [Address Review] key.

2

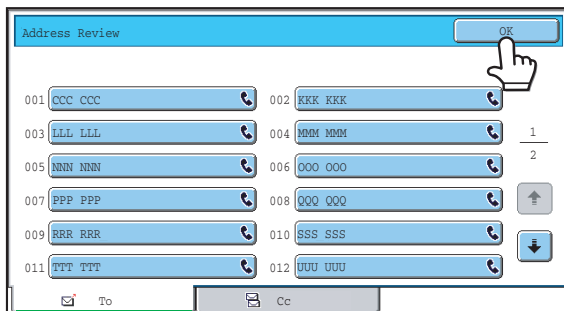

Check the destinations and then touch the [OK] key.



To delete a destination...

Touch the one-touch key of the destination that you wish to delete. A message will appear to confirm the deletion. Touch the [YES] key.

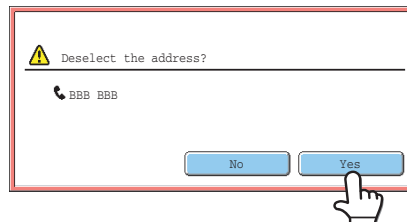

USING A SEARCH NUMBER TO RETRIEVE A DESTINATION

A destination stored in the address book can be retrieved using the  key. This can be done in the base screen of fax mode or in the address book screen.

1

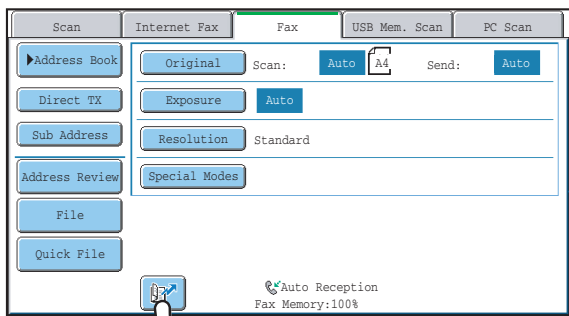

The screenshot shows the 'Fax' mode screen with various settings. A hand cursor is pointing to the search key icon at the bottom left of the screen. The screen displays options like 'Original', 'Scan: Auto', 'Send: Auto', 'Exposure: Auto', 'Resolution: Standard', and 'Special Modes'. At the bottom, it shows 'Auto Reception' and 'Fax Memory: 100%'.

Touch the  key.

2

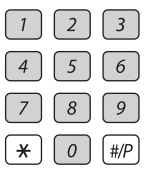

Enter the 3-digit search number of the address with the numeric keys.

When the 3-digit search number is entered, the stored address is retrieved and specified as a destination.

- The search number is programmed when the destination is stored in the address book.
- If you do not know the search number, print the one-touch address list using "Sending Address List" in the system settings.
- When entering search numbers such as "001" and "011", "0" can be omitted. For example, to enter "001", enter "1" and touch the  key or the [Next Address] key.

If an incorrect search number is entered...

Press the [CLEAR] key () to clear the number and enter the correct number.

RETRIEVING A DESTINATION FROM A GLOBAL ADDRESS BOOK

If an LDAP server is stored in the Web pages, you can look up a destination fax number in a global address book.

1

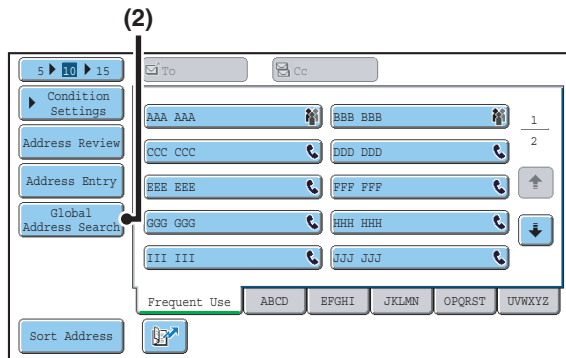

Open the global address search screen.

(1) Touch the [Address Book] key in the base screen.

(2) Touch the [Global Address Search] key.

2

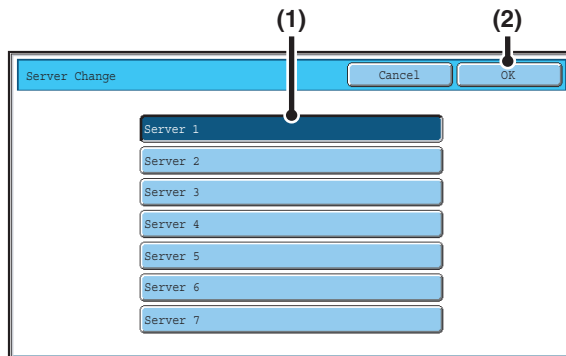

Search for the destination.

If only one LDAP server has been stored, (1) and (2) are not necessary. Go directly to (3).

(1) Touch the key of the LDAP server that you wish to use.

(2) Touch the [OK] key.

(3) Search for the destination in the search screen.

Enter search characters for the destination and touch the [Search] key. The search results will appear after a brief interval.

For the procedure for entering text, see "6. ENTERING TEXT" in the User's Guide.



How to search

Enter a maximum of 64 characters for the search characters. The system will look for names starting with the entered letters.

An asterisk * can be used as follows:

XXX*: Names beginning with "XXX".

*XXX: Names that end with "XXX".

XXX: Names that include "XXX".

AA*XX: Names that start with "AA" and end with "XX".

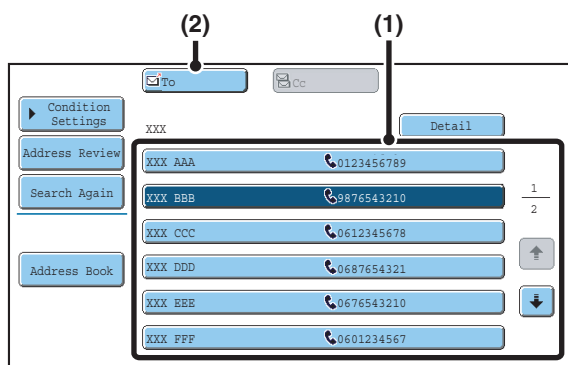

Select the destination.

(1) Touch the key of the desired destination.

If no names are found that match the search letters, a message will appear. Touch the [OK] key to close the message and touch the [Search Again] key to search again.

(2) Touch the [To] key.

This enters the selected destination.

If you wish to select another destination, repeat steps (1) and (2) above.



- If more than 30 matches are found, a message will appear in the screen. Touch the [OK] key to close the message. A maximum of 300 search results are displayed. If the desired destination was not found, touch the [Search Again] key to add more search letters.
- **To check the information stored in a destination...**
Touch the key of the destination and then touch the [Detail] key. The information stored for the selected destination will appear. Check the information and then touch the [OK] key to return to the search results screen.
- **If a screen for selecting the item to be used appears...**
If the selected destination includes an E-mail address or other address in addition to the fax number or telephone number, you will need to select which item you wish to use. Touch the [Fax] key to retrieve the fax number.

Storing a destination from a global address book in the machine's address book

A destination from a global address book can be stored in the machine's address book as a one-touch key. Touch the [Detail] key in the search results screen of the global address book (the screen of step 3 above) to display information on the selected destination. Touch the [Register] key in the detailed information screen and then touch the item to be used (the [Fax] key in this case). The following screen will appear.

Direct Address / Individual		Exit
<input type="checkbox"/> E-mail	<input type="checkbox"/> Internet Fax	<input checked="" type="checkbox"/> Fax
Search Number	001	
Name	AAA AAA	
Initial	A	Index User 1
Fax No.	0123456789	
Key Name	AAA AAA	
Mode	33.6 kbps/None	

The information stored in the global address book is automatically entered. (The settings can be changed if needed. For detailed information on each item, see "Address Control" in the System Settings Guide.) However, configure the items below manually. To complete the storing procedure, touch the [Exit] key.

- [Initial] key: Touch this key to enter the initials that determine where the destination will appear in the alphabetical index and the order of one-touch key display.
- [Index] key: Touch this key to select the custom index in which the address will appear. You can also select whether or not the destination will be included on the [Frequent Use] tab of the address book.
- [Mode] key: Touch this key to configure the "Transmission Speed" and "International Correspondence Mode" settings. These settings have already been configured, however, if the destination is an international destination, or if you find that communication errors frequently occur when communicating with that destination, you can try changing the settings.

USING THE RESEND FUNCTION

The destinations of the most recent 8 transmissions by fax, Scan to E-mail, and/or Internet fax are stored. One of these can be selected to resend to that destination.

1

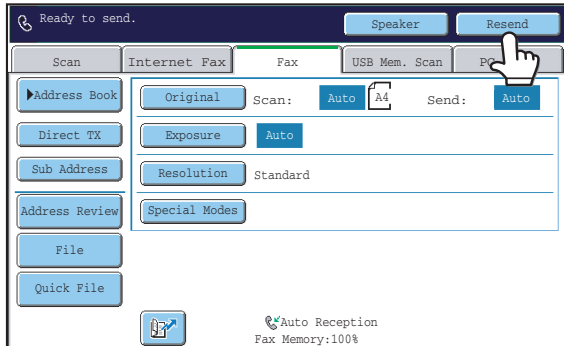

Touch the [Resend] key.

2

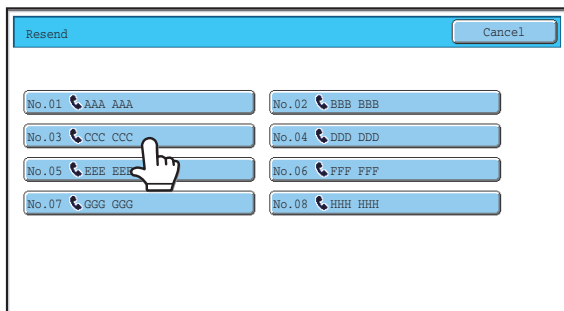

Touch the key of the fax destination that you wish to redial.

The last 8 transmission destinations appear.



- If numeric keys were pressed during the previous transmission, the [Resend] key may not dial the correct number.
- The following types of addresses are not stored for resending.
 - A one-touch key in which multiple destinations are stored (group key).
 - Broadcast destinations
 - Destinations transmitted to using a program

CHAIN DIALLING

Number sequences entered with the numeric keys and/or one-touch keys can be linked together with pauses and dialled as a single number.

Use chain dialling to dial a long number (such as an international number) when the country code and/or area code are stored separately in one-touch keys.

Example: Using chain dialling to dial an international number

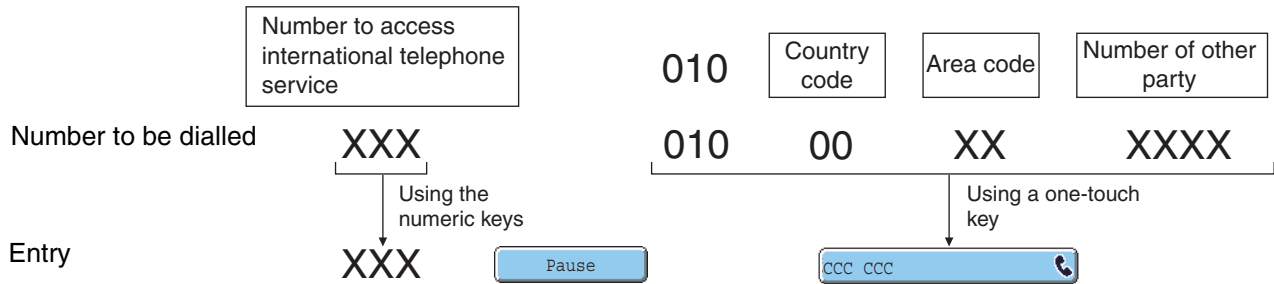

System Settings (Administrator): Pause Time Setting

This is used to set the length of pauses. The default setting is 2 seconds.

3

BASIC TRANSMISSION METHODS

This chapter explains the basic procedures for sending a fax.

TRANSMISSION METHODS

The methods that can be used to send a fax from the machine are explained below. Select the method that best suits your needs.

To fax a large number of sheet originals, use the automatic document feeder.

The originals will be scanned into memory and then transmitted (memory transmission).

When memory transmission is selected and multiple originals are placed in the automatic document feeder (and the line is free), transmission will begin as soon as the first page is scanned and will take place while the remaining pages are being scanned (Quick Online transmission).

If transmission cannot begin immediately because the line is in use, all pages will be scanned into memory and the transmission will be reserved.

☞ [USING THE AUTOMATIC DOCUMENT FEEDER FOR TRANSMISSION](#) (page 29)

When a fax transmission or reception is already in progress, the following procedure can be performed to reserve a transmission job. To check reserved transmission jobs, display the job status screen.

☞ [8. CHECKING THE STATUS OF FAX JOBS](#) (page 114)

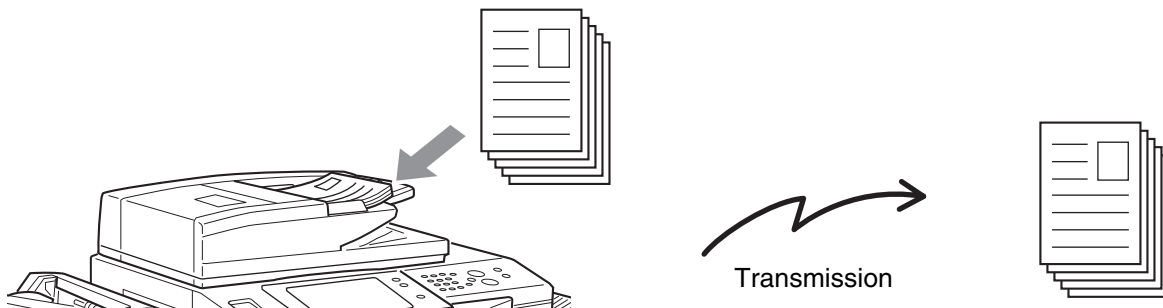

- If memory becomes full while the first original page is being scanned, transmission will stop.
- In the following situations, the transmission will be automatically reserved (memory transmission)
 - When the line is busy or a communication error occurs and automatic resending is enabled.
☞ [WHEN THE LINE IS BUSY](#) (page 28), [WHEN A COMMUNICATION ERROR OCCURS](#) (page 28)
 - The machine is already using the line to send or receive a fax.
 - Another fax transmission was reserved ahead of your fax.
 - One of the following functions is being used for transmission.
Broadcast transmission, F-code transmission, timer transmission, Dual Page Scan, 2in1, Card Shot, Job Build
 - The document glass is being used (except when the speaker is being used to dial).
- Up to 94 transmission jobs can be reserved.
- When the transmission is finished, the scanned original pages are cleared from memory. However, when the document filing function is used, the transmitted fax is stored.
☞ Document Filing Guide



System Settings (Administrator): Quick On Line Sending

This is used to disable Quick Online transmission. In this case, fax transmissions will be sent by memory transmission (reserved and then transmitted).

To fax thick originals or pages of a book, use the document glass.

The transmission will be reserved after all pages are scanned (memory transmission).

[USING THE DOCUMENT GLASS FOR TRANSMISSION](#) (page 32)

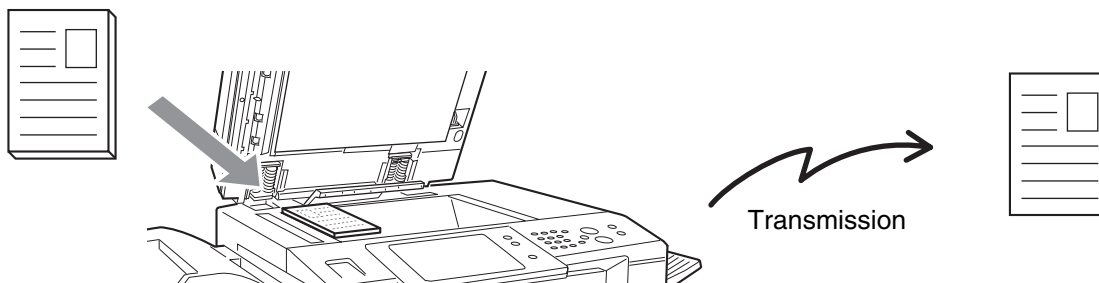

When the document glass is being used for a transmission, Quick Online transmission will not operate.

If you wish to send a fax ahead of other previously reserved fax transmissions, use direct transmission mode.

The original is transmitted directly to the receiving fax machine without being scanned into memory.

When direct transmission mode is used, transmission will begin as soon as the transmission in progress is completed (ahead of any previously reserved transmissions).

To send a fax by direct transmission, touch the [Direct TX] key in the base screen.

[USING THE AUTOMATIC DOCUMENT FEEDER TO SEND A FAX IN DIRECT TRANSMISSION MODE](#) (page 30),
[USING THE DOCUMENT GLASS TO SEND A FAX IN DIRECT TRANSMISSION MODE](#) (page 34)

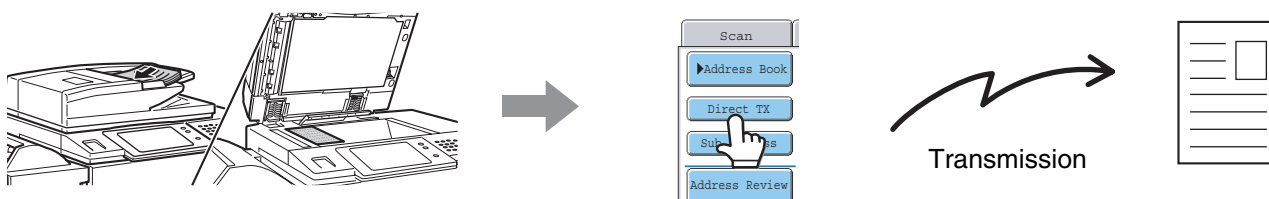

- When transmission in direct transmission mode ends, the mode automatically changes back to memory transmission mode.
- When the document glass is used, multiple original pages cannot be scanned.

PLACEMENT ORIENTATION OF THE ORIGINAL

When an A4 (8-1/2" x 11") original is placed in vertical orientation (📄), the image is automatically rotated 90 degrees and transmitted in horizontal orientation (📄) (Rotation Sending). If the original is placed in horizontal orientation (📄), it is transmitted in that orientation (📄) without being rotated.

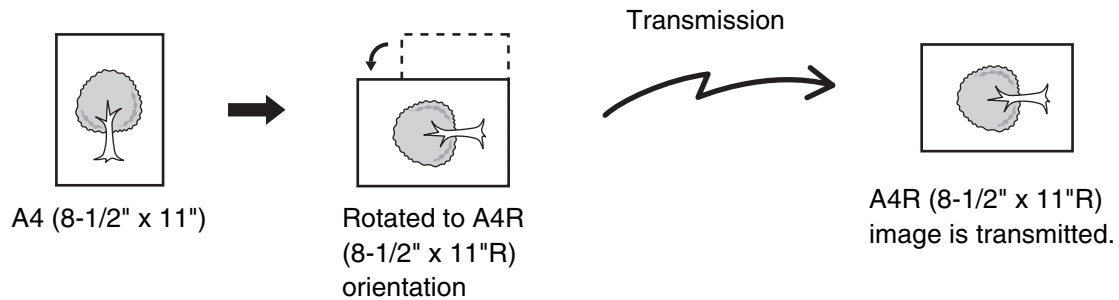

A4R, B5 and A5 (8-1/2" x 11"R and 5-1/2" x 8-1/2") size originals are not rotated for transmission.



System Settings (Administrator): Rotation Sending Setting

The factory default setting is rotate before transmission. If this setting is disabled, the original will be transmitted in the orientation in which it is placed.

AUTOMATIC REDUCTION OF THE TRANSMITTED IMAGE

If the width of the transmitted image is larger than the width of the paper in the receiving machine, the image will be automatically reduced to fit the receiving machine's paper width.

Example: Reduced sizes and reduction ratios

Transmitted image width	Receiving machine's paper width	Reduced size	Ratio
A3	B4	B4	1 : 0.84
A3 (11" x 17")	A4 (8-1/2" x 14", 8-1/2" x 11")	A4R (8-1/2" x 14", 8-1/2" x 11"R)	1 : 0.71
B4	A4	A4R	1 : 0.84



System Settings (Administrator): Auto Reduction Sending Setting

The factory default setting is automatic reduction enabled. If this setting is disabled, the image will be sent at full size and part of the image may be cut off.

TRANSMITTABLE ORIGINAL SIZES

The following original sizes can be transmitted.

	Minimum original size	Maximum original size
Using the automatic document feeder	131 mm (height) x 140 mm (width) (5-1/8" (height) x 5-1/2" (width))	297 mm (height) x 800 mm* (width) (11" (height) x 31-1/2"* (width))
Using the document glass	–	297 mm (height) x 432 mm (width) (11" (height) x 17" (width))

*When transmitting a long original (page 46)

THE SIZE OF THE PLACED ORIGINAL

When a standard size original is placed, the original size is automatically detected and displayed in "Scan" in the base screen.

When the automatic original detection function is operating and the original is a non-standard size, the closest standard size may be displayed or the original size may not appear. In this event, manually set the correct original size.

 [Specifying the original scan size \(by paper size\)](#) (page 46)

[Specifying the original scan size \(by numerical values\)](#) (page 48)

STANDARD SIZES

Standard sizes are sizes that the machine can automatically detect. The standard sizes are set in "Original Size Detector Setting" in the system settings (administrator). The factory default setting is "AB-1".

List of original size detector settings

Selections	Standard sizes (detected original sizes)	
	Document glass	Document feeder tray (automatic document feeder)
AB-1	A3, A4, A4R, A5, B4, B5, B5R	A3, A4, A4R, A5, B4, B5, B5R, 8-1/2" x 11", 8-1/2" x 14", 11" x 17"
AB-2	A3, A4, A4R, A5, B5, B5R, 216 mm x 330 mm (8-1/2" x 13")	A3, A4, A4R, A5, B4, B5, B5R, 8-1/2" x 11", 11" x 17", 216 mm x 330 mm (8-1/2" x 13")
AB-3	A4, A4R, A5, B4, 8K, 16K, 16KR	A3, A4, A4R, A5, B4, 8K, 16K, 16KR, 8-1/2" x 11", 11" x 17", 216 mm x 330 mm (8-1/2" x 13")
Inch-1	11" x 17", 8-1/2" x 14", 8-1/2" x 11", 8-1/2" x 11"R, 5-1/2" x 8-1/2"	11" x 17", 8-1/2" x 14", 8-1/2" x 11", 8-1/2" x 11"R, 5-1/2" x 8-1/2", A4, A3
Inch-2	11" x 17", 8-1/2" x 13" (216 mm x 330 mm), 8-1/2" x 11", 8-1/2" x 11"R, 5-1/2" x 8-1/2"	11" x 17", 8-1/2" x 13" (216 mm x 330 mm), 8-1/2" x 11", 8-1/2" x 11"R, 5-1/2" x 8-1/2", A4, A3

WHEN THE LINE IS BUSY

If the line is busy when you send a fax, transmission will be re-attempted automatically after a preset interval. This function only operates in memory transmission mode. In direct transmission mode or manual transmission mode, the transmission will be cancelled. Wait briefly and then try sending the fax again.



To cancel transmission...

Cancel the transmission from the job status screen.

 [CANCELLING A FAX IN PROGRESS OR A RESERVED FAX](#) (page 121)



System Settings (Administrator): Recall in Case of Line Busy

This is used to set the number of recall attempts and the interval between attempts when the connection cannot be established because the line is busy. The factory default setting is 2 attempts at an interval of 3 minutes.

WHEN A COMMUNICATION ERROR OCCURS

If a communication error occurs or the other fax machine does not answer the call within a preset period of time, transmission will be re-attempted automatically after a preset interval. This function only operates in memory transmission mode.



To cancel transmission...

Cancel the transmission from the job status screen.

 [CANCELLING A FAX IN PROGRESS OR A RESERVED FAX](#) (page 121)



System Settings (Administrator): Recall in Case of Communication Error

This is used to set the number of recall attempts and the interval between attempts when a transmission fails due to an error. The factory default setting is attempt at an interval of 1 minute.

USING THE AUTOMATIC DOCUMENT FEEDER FOR TRANSMISSION

This section explains how to use the automatic document feeder to send a fax.

1

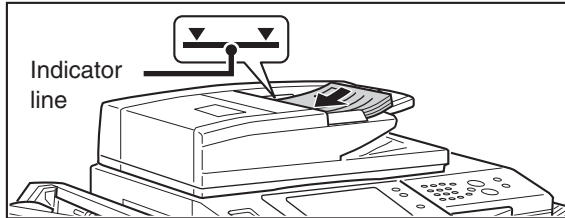

Place the originals face up in the document feeder tray with the edges aligned evenly.

Insert the originals all the way into the document feeder tray. Multiple originals can be placed in the document feeder tray. The stack of originals must not be higher than the indicator line on the tray.



When sending a multi-page fax, the automatic document feeder and the document glass cannot both be used to scan the original pages.

2

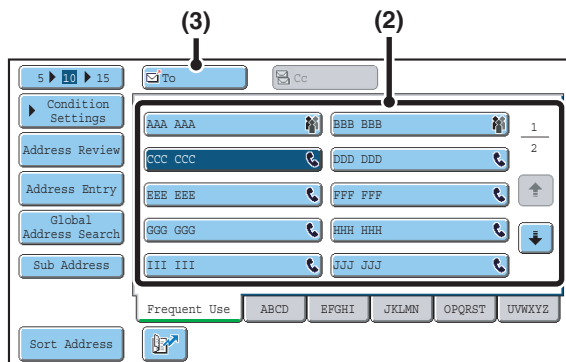

Enter the destination fax number

(1) Touch the [Address Book] key in the base screen.

(2) Touch the one-touch key of the desired destination.

(3) Touch the [To] key.



In addition to specification by one-touch key, a destination can also be specified using a search number. You can also directly enter a fax number with the numeric keys or look up a destination in a global address book. For more information, see "2. ENTERING DESTINATIONS" (page 15).

3



Press the [BLACK & WHITE START] key (○●).

Scanning begins.

When scanning is completed, the machine sounds a beep.



When scanning is completed, "Job stored." will be displayed together with a job control number. This number can be used to locate the job in the Transaction Report or in the Image Sending Activity Report.



System Settings (Administrator): Scan Complete Sound Setting

The scan complete sound can be selected.



To cancel scanning...

While "Scanning original" appears in the display, press the [STOP] key (⊙).



- If a fax is being received when the transmission operation is performed, the transmission will be reserved and transmitted after fax reception is completed.
- If the memory becomes full while the originals are being scanned, a message will appear and scanning will stop. If Quick Online transmission is taking place, the originals that were scanned will be transmitted. If Quick Online is not enabled, the transmission will be cancelled.

USING THE AUTOMATIC DOCUMENT FEEDER TO SEND A FAX IN DIRECT TRANSMISSION MODE

1

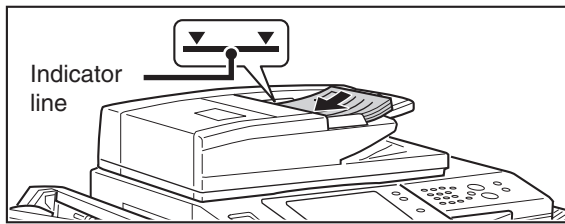

Place the originals face up in the document feeder tray with the edges aligned evenly.

Insert the originals all the way into the document feeder tray. Multiple originals can be placed in the document feeder tray. The stack of originals must not be higher than the indicator line on the tray.

2

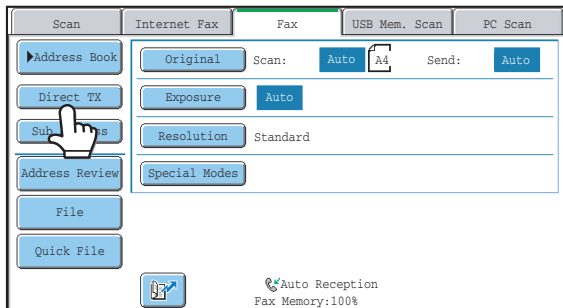

Touch the [Direct TX] key.

3

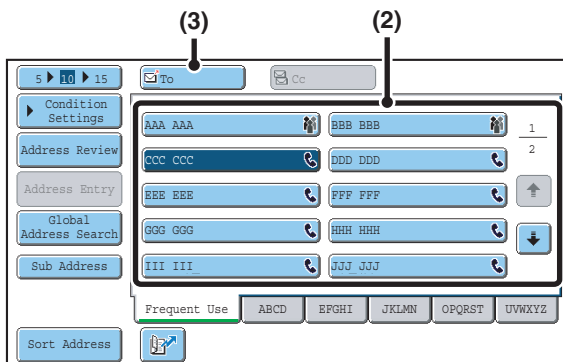

Enter the destination fax number

- (1) Touch the [Address Book] key in the base screen.
- (2) Touch the one-touch key of the desired destination.
- (3) Touch the [To] key.



In addition to specification by one-touch key, a destination can also be specified using a search number. You can also directly enter a fax number with the numeric keys or look up a destination in a global address book. For more information, see "2. ENTERING DESTINATIONS" (page 15).

4



Press the [BLACK & WHITE START] key (○●).

Transmission begins.



To cancel transmission...

While "Dialling. Press [▽] to cancel" appears or while the fax is being transmitted, press the [STOP] key (⊞).



- Only one destination can be entered.
- The following functions cannot be used with direct transmission:
Program, Timer Transmission, 2in1, Card Shot, Job Build, Polling Memory, File, Quick File, 2-Sided Original Scanning, Global Address Search
- Resending will not take place when a direct transmission is not successful due to a communication error or other reason.
- If a fax transmission is already in progress when the direct transmission operation is performed, the direct transmission will wait until the previous transmission is finished. When the previous transmission is completed, the direct transmission will begin. While the direct transmission is waiting, the [JOB STATUS] key can be pressed to display the job status screen. No other operations are possible.

 [8. CHECKING THE STATUS OF FAX JOBS](#) (page 114)

USING THE DOCUMENT GLASS FOR TRANSMISSION

To fax a thick original or other original that cannot be fed through the automatic document feeder, open the automatic document feeder and place the original on the document glass.

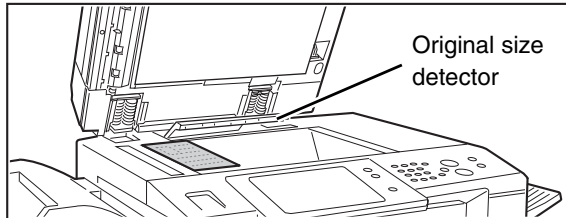

Open the automatic document feeder, place the original face down on the document glass, and then gently close the automatic document feeder.

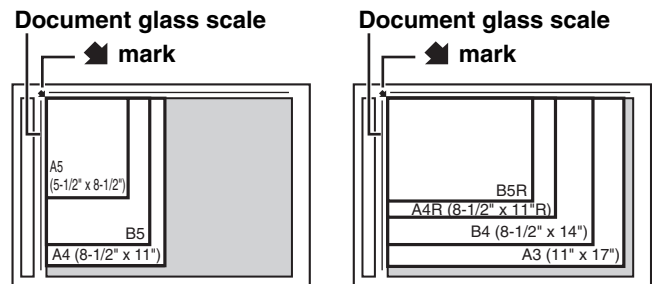

- Align the corner of the original with the tip of the arrow mark  on the document glass scale.
- Place the original in the appropriate position for its size as shown above.

1



Do not place any objects under the original size detector. Closing the automatic document feeder with an object underneath may damage the original size detector plate and prevent correct detection of the document size.



- When faxing a multi-page original, scan each page in order starting from the first page.
- When sending a multi-page fax, the automatic document feeder and the document glass cannot both be used to scan the original pages.

2

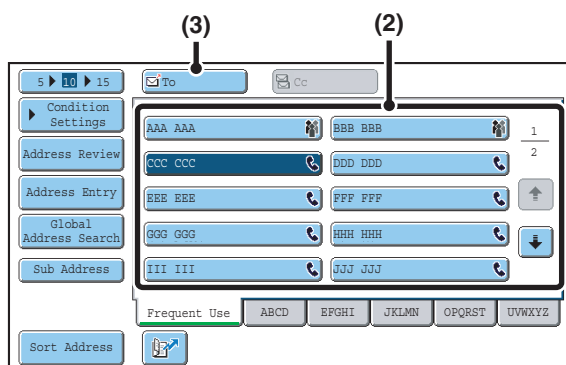

Enter the destination fax number

- (1) Touch the [Address Book] key in the base screen.
- (2) Touch the one-touch key of the desired destination.
- (3) Touch the [To] key.



In addition to specification by one-touch key, a destination can also be specified using a search number. You can also directly enter a fax number with the numeric keys or look up a destination in a global address book. For more information, see "2. ENTERING DESTINATIONS" (page 15).

3



Press the [BLACK & WHITE START] key (○●).

Scanning begins.

4

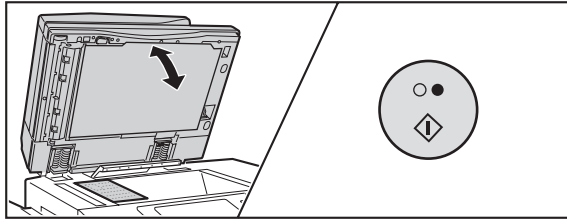

If you have another page to scan, change pages and then press the [BLACK & WHITE START] key (○●).

Repeat until all originals have been scanned.



If no action is taken for one minute, scanning automatically ends and the transmission is reserved.

5

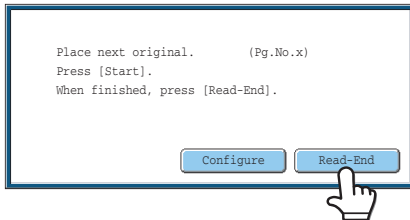

Touch the [Read-End] key.

A beep sounds.

Open the automatic document feeder and remove the original.



- When scanning is completed, "Job stored." will be displayed together with a job control number. This number can be used to locate the job in the Transaction Report or in the Image Sending Activity Report.
- If no action is taken for one minute after the confirmation screen appears, scanning automatically ends and the transmission is reserved.
- The [Configure] key can be touched to change the exposure, resolution, scan size, and send size for each original page scanned. However, when "2in1" or "Card Shot" is selected in the special modes, only the exposure can be changed, and this can only be done when scanning each even page number of the original pages.



To cancel transmission...

Press the [STOP] key (Ⓢ) before the [Read-End] key is touched.



- If a fax is being received when the transmission operation is performed, the transmission will be reserved and transmission will take place after fax reception is completed.
- If the memory becomes full while the originals are being scanned, a message will appear and transmission will be cancelled.

USING THE DOCUMENT GLASS TO SEND A FAX IN DIRECT TRANSMISSION MODE

When sending a fax from the document glass in direct transmission mode, only one page can be transmitted.

1

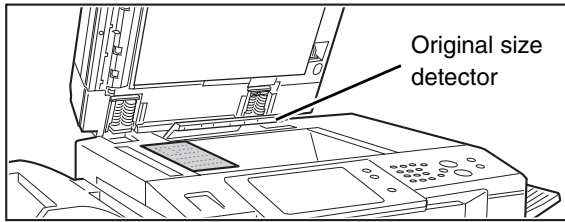

Open the automatic document feeder, place the original face down on the document glass, and then gently close the automatic document feeder.

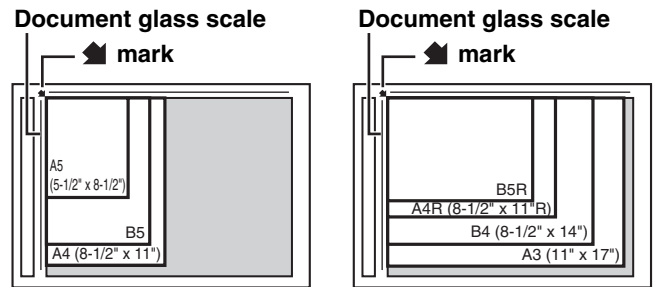

- Align the corner of the original with the tip of the arrow mark  on the document glass scale.
- Place the original in the appropriate position for its size as shown above.



Do not place any objects under the original size detector. Closing the automatic document feeder with an object underneath may damage the original size detector plate and prevent correct detection of the document size.

2

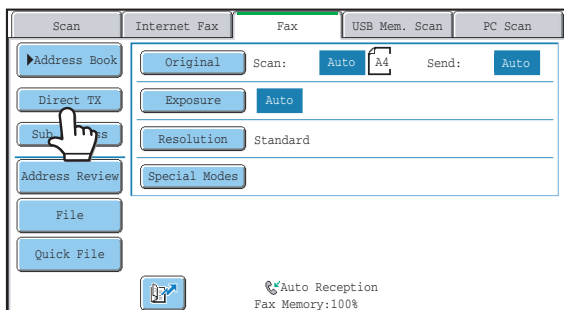

Touch the [Direct TX] key.

3

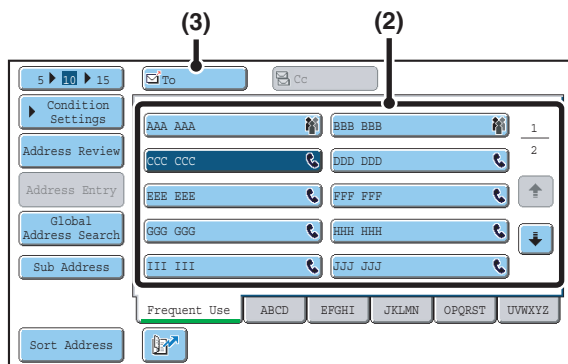

Enter the destination fax number

- (1) Touch the [Address Book] key in the base screen.
- (2) Touch the one-touch key of the desired destination.
- (3) Touch the [To] key.



- Only one destination can be entered. A one-touch key in which multiple destinations are stored (group key) cannot be used.
- In addition to specification by one-touch key, a destination can also be specified using a search number. You can also directly enter a fax number with the numeric keys or look up a destination in a global address book. For more information, see "2. ENTERING DESTINATIONS" (page 15).

4

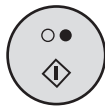

Press the [BLACK & WHITE START] key (○●).

Transmission begins.



To cancel transmission...

While "Dialling. Press [▽] to cancel" appears in the display, press the [STOP] key (⊞).



- The following functions cannot be used with direct transmission: Program, Timer Transmission, 2in1, Card Shot, Job Build, Polling Memory, File, Quick File, 2-Sided Original Scanning, Global Address Search
 - Resending will not take place when a direct transmission is not successful due to a communication error or other reason.
 - If a fax transmission is already in progress when the direct transmission operation is performed, the direct transmission will wait until the previous transmission is finished. When the previous transmission is completed, the direct transmission will begin. While the direct transmission is waiting, the [JOB STATUS] key can be pressed to display the job status screen. No other operations are possible.
- ➔ 8. CHECKING THE STATUS OF FAX JOBS (page 114)

TRANSMISSION USING THE SPEAKER

When the speaker is used to dial, the fax is sent after the number is dialed and the connection is established. If a person answers, you will be able to hear his or her voice, but you will not be able to speak.

1

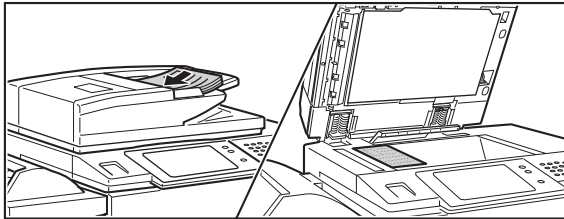

Place the original.

Place the original face up in the document feeder tray, or face down on the document glass. When the document glass is used, only one page can be transmitted.

2

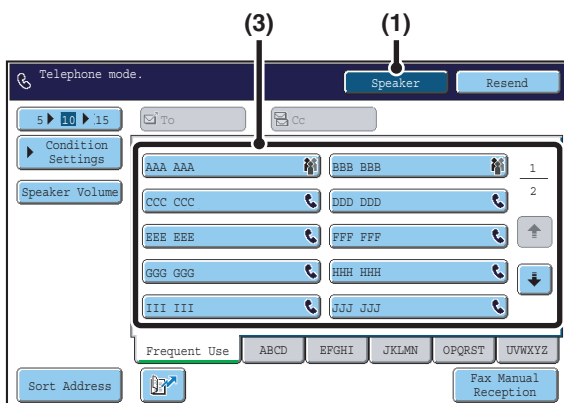

Enter the destination fax number

(1) Touch the [Speaker] key.

You will hear the dial tone through the machine's speaker.

(2) Touch the [Address Book] key in the base screen.

(3) Touch the one-touch key of the desired destination.

A group key cannot be used.



- In addition to specification by one-touch key, a destination can also be specified using a search number. You can also directly enter a fax number with the numeric keys or look up a destination in a global address book. For more information, see "2. ENTERING DESTINATIONS" (page 15).
- After touching the [Speaker] key, you can touch the [Speaker Volume] key to adjust the volume of the speaker. The speaker volume changes each time the [Speaker Volume] key is touched. Adjust the volume to the desired level.

3



Wait until the connection is made and then press the [BLACK & WHITE START] key (○●).

Transmission begins.



To cancel transmission...

Touch the [Speaker] key before the [BLACK & WHITE START] key (○●) is pressed. The line will be disconnected and transmission will stop.



- When the speaker is used, transmission takes place without scanning the original into memory.
- A destination that includes an F-code (sub-address and passcode) cannot be used.
- A one-touch key that has multiple destinations or has a non-fax destination cannot be used.



System Settings (Administrator): Speaker Settings

The default volume level of the speaker can be changed in the "Speaker Settings".

SENDING THE SAME FAX TO MULTIPLE DESTINATIONS (Broadcast Transmission)

This function is convenient when you need to send the same fax to multiple destinations, such as sending a report to branch offices in different regions. You can transmit to as many as 500 destinations in one broadcast operation.

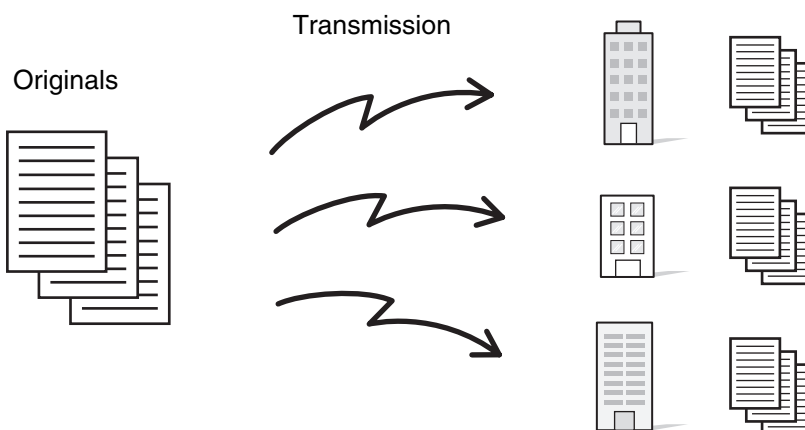

It is convenient to store destinations to which you frequently send faxes by broadcast transmission in group keys. Group dialling allows you to retrieve multiple fax numbers stored in a one-touch key by simply pressing the one-touch key. To store group keys, see "Address Control" in the system settings.

When a group key is used to dial, the number of fax numbers that are dialled is the number of destinations that are stored in the group key. When a group key that has 10 destinations is used, 10 fax numbers are dialled.

1

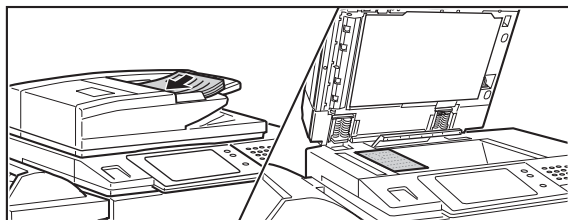

Place the original.

Place the original face up in the document feeder tray, or face down on the document glass.

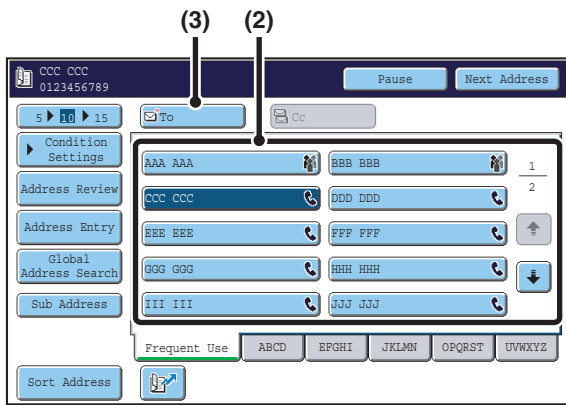

Enter the destination fax number

- (1) Touch the [Address Book] key in the base screen.
- (2) Touch the one-touch key of the desired destination.
- (3) Touch the [To] key.
The destination is specified.
- (4) Repeat steps (2) and (3) until all destinations are selected.

2



- In addition to specification by one-touch key, a destination can also be specified using a search number. You can also directly enter a fax number with the numeric keys or look up a destination in a global address book. For more information, see "2. ENTERING DESTINATIONS" (page 15).
- It is convenient to use a group key to enter the destinations.
- Touch the [Next Address] key before entering the next destination.
The [Next Address] key can be omitted before and after a destination entered with a one-touch key.

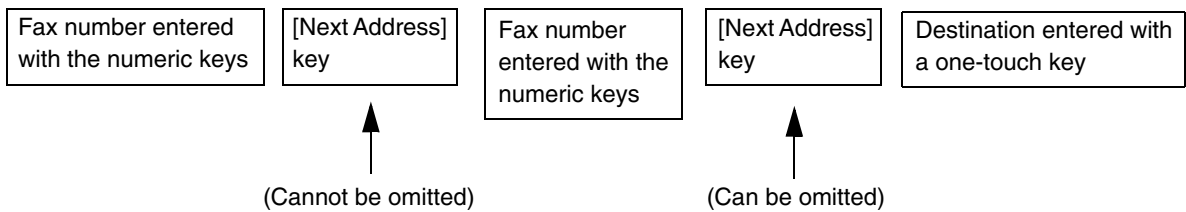

System Settings (Administrator): Must Input Next Address Key at Broadcast Setting

This setting is used to prohibit omission of the [Next Address] key when entering destinations for broadcast transmissions.

3

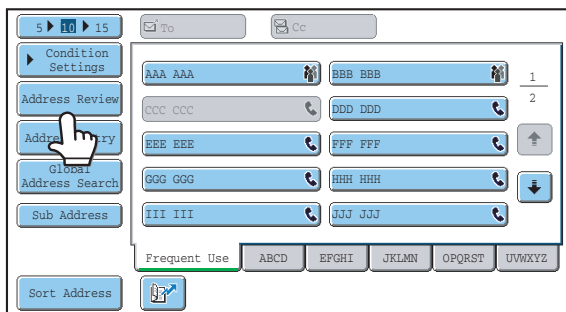

Touch the [Address Review] key.

4

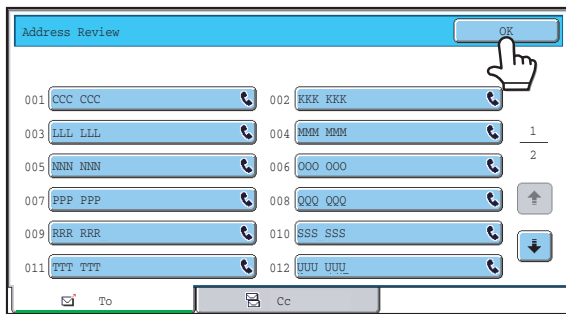

Check the destinations and then touch the [OK] key.



To cancel a specified destination...

Touch the key of the destination that you wish to cancel. A message will appear to confirm the deletion. Touch the [Yes] key.

[CHECKING AND DELETING ENTERED DESTINATIONS](#) (page 18)

5



Press the [BLACK & WHITE START] key (○●).

Scanning begins.

- If you inserted the original pages in the document feeder tray, all pages are scanned. A beep will sound to indicate that scanning is finished.
- If you are scanning the original on the document glass, scan each page one page at a time. When scanning finishes, place the next original and press the [BLACK & WHITE START] key (○●). Repeat until all pages have been scanned and then touch the [Read-End] key. A beep will sound to indicate that scanning is finished.



To cancel scanning...

Press the [STOP] key (⊘).



- A broadcast transmission takes place by memory transmission only.
- A broadcast transmission can be used in combination with the timer transmission function to transmit at night or any other desired time. A broadcast transmission can also be used in combination with other convenient functions.
- The broadcast transmission can include Scan to E-mail and Internet fax destinations. In this case, the image sent to the Scan to E-mail and Internet fax destinations will be black and white.

Resending to unsuccessful broadcast transmission destinations

The results of a completed broadcast transmission can be checked in the job status screen. If transmission to any of the destinations failed, resend the fax to those destinations.

1

JOB STATUS



Press the [JOB STATUS] key.

2

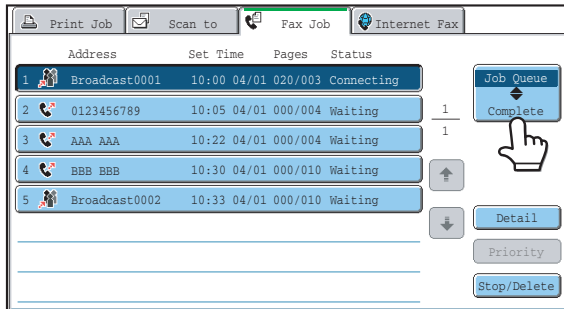

Touch the [Complete] key.

If the job status screen of fax mode does not appear, touch the [Fax Job] tab.



If the broadcast transmission included destinations of different modes, the same broadcast transmission key will appear in each of those modes.

3

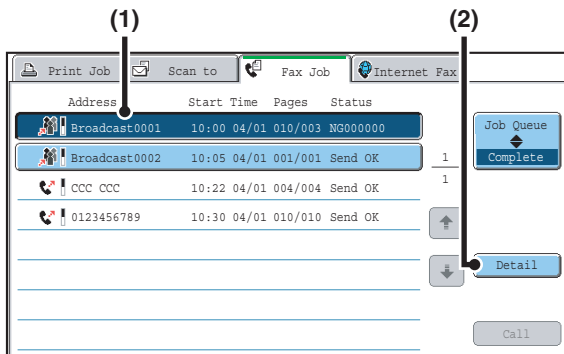

Display details on the broadcast transmission.

(1) Touch the key of the completed broadcast transmission.

(2) Touch the [Detail] key.



"Broadcastxxxx" will appear as the destination of the broadcast job key. The job control number that appeared in the touch panel when scanning ended appears in "xxxx".

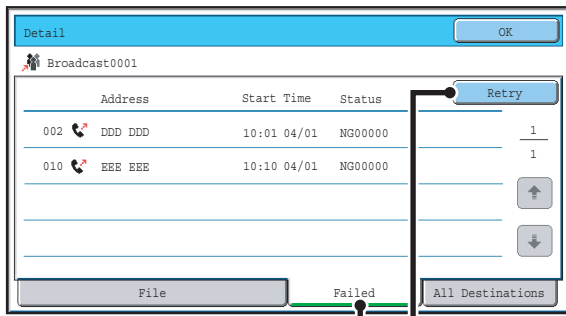

Resend to unsuccessful destinations.

(1) Touch the [Failed] tab.

(2) Touch the [Retry] key.

4



- The procedure after the [Retry] key is touched varies depending on whether or not the document filing function was used.

Not using document filing

You will return to the base screen with the unsuccessful destinations entered. Place the original and perform the broadcast transmission operation.

Using document filing

The document filing operation selection screen will appear with the unsuccessful destinations entered. Perform the document filing resend procedure. (There is no need to rescan the original.)

If the job was stored in a confidential folder or was stored as confidential file, a password entry screen will appear after you touch the [Retry] key. Enter the password.

For more information, see the Document Filing Guide.

- If the [All Destinations] key is touched in (1), all destinations will be displayed. The [Retry] key that appears in the screen can be touched to resend to all destinations.

SENDING A FAX DIRECTLY FROM A COMPUTER (PC-Fax)

A document in a computer can be transmitted via the machine as a fax. Faxes are sent using the PC-Fax function in the same way as documents are printed. Select the PC-Fax driver as the printer driver on your computer and then select the Print command in the software application. Image data for transmission will be created and sent as a fax.

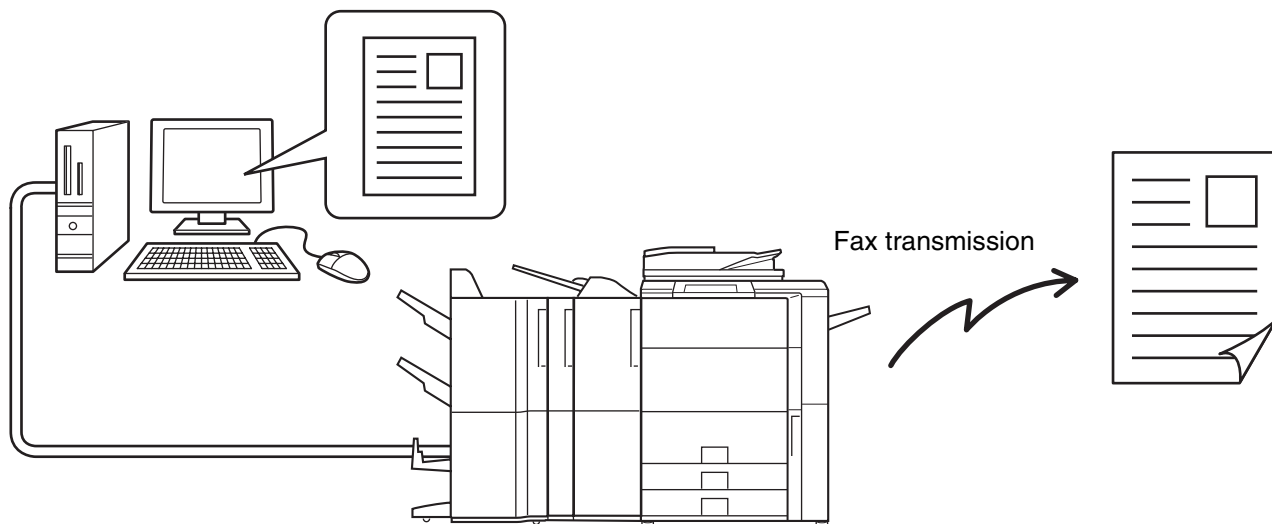

For more information on using PC-Fax, see the Help file for the PC-Fax driver.



- To use the PC-Fax function, the PC-Fax driver must be installed. For more information, see the Software Setup Guide.
- This function can only be used on a Windows® computer.
- This function can only be used for transmission. Faxes cannot be received to your computer.

IMAGE SETTINGS

Settings for scanning the original are selected in the base screen of each mode. The current state of each setting appears to the right of the key used to select the setting.

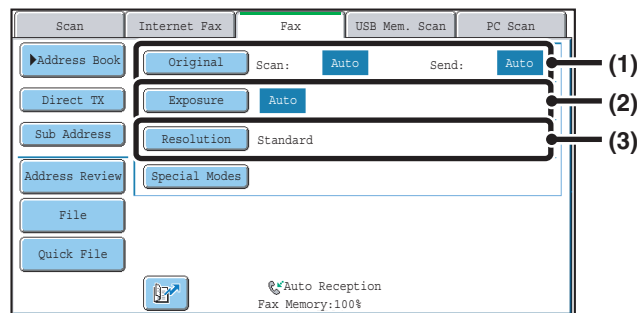

(1) [Original] key

Touch this key to set the scan size, send size, and orientation of the original, and select 2-sided scanning settings.

[AUTOMATICALLY SCANNING BOTH SIDES OF AN ORIGINAL \(2-Sided Original\)](#) (page 44),
[SPECIFYING THE SCAN SIZE AND SEND SIZE \(Enlarge/Reduce Transmission\)](#) (page 45)

(2) [Exposure] key

Touch this key to select the exposure for scanning.

[CHANGING THE EXPOSURE](#) (page 52)

(3) [Resolution] key

Touch this key to select the scanning resolution.

[CHANGING THE RESOLUTION](#) (page 53)

AUTOMATICALLY SCANNING BOTH SIDES OF AN ORIGINAL (2-Sided Original)

The automatic document feeder will automatically scan both sides of the document.

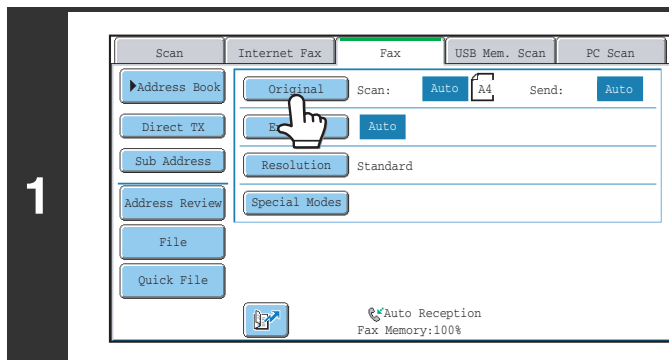
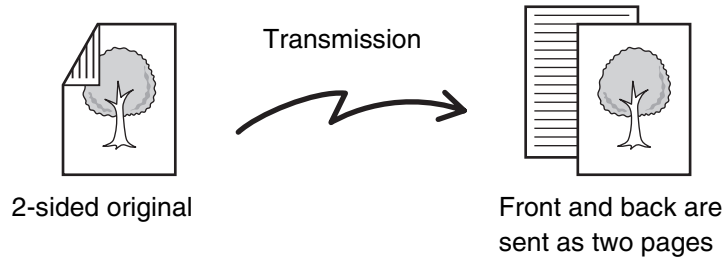

Touch the [Original] key.

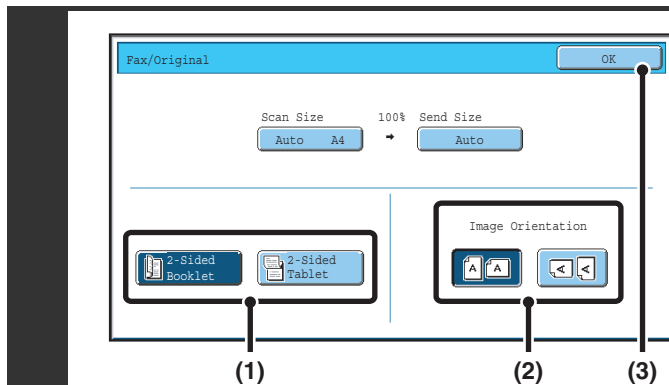

Specify the binding style of the 2-sided original (book or tablet) and the orientation in which the original is placed.

(1) Touch the [2-Sided Booklet] key or the [2-Sided Tablet] key.

A book and a tablet are bound as shown below.

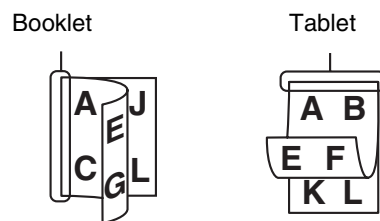

(2) Touch the appropriate [Image Orientation] key.

If the wrong orientation is selected here, the image may not be sent properly.

(3) Touch the [OK] key.

To cancel 2-sided scanning, touch the highlighted key so that it is no longer highlighted.



- 2-sided scanning automatically turns off after the transmission operation is completed.
- When direct transmission mode is selected, 2-sided scanning cannot be used.

SPECIFYING THE SCAN SIZE AND SEND SIZE (Enlarge/Reduce Transmission)

When the original is placed, its size is automatically detected and displayed in the base screen.

The size of the placed original is indicated as the scan size, and the size to be transmitted is indicated as the send size.

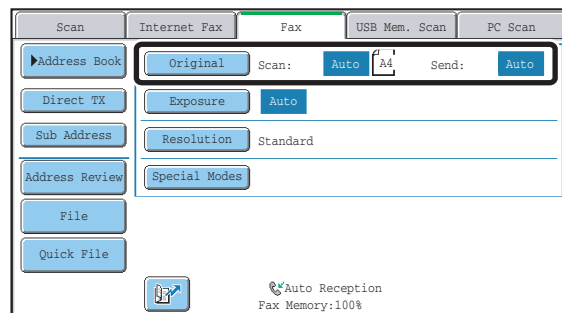

In the above screen, the scan size (the placed original) is A4 (8-1/2" x 11") and the send size is auto. If, for example, the scan size were A4 (8-1/2" x 11") and the send size were B5 (5-1/2" x 8-1/2"), the image would be reduced before transmission.

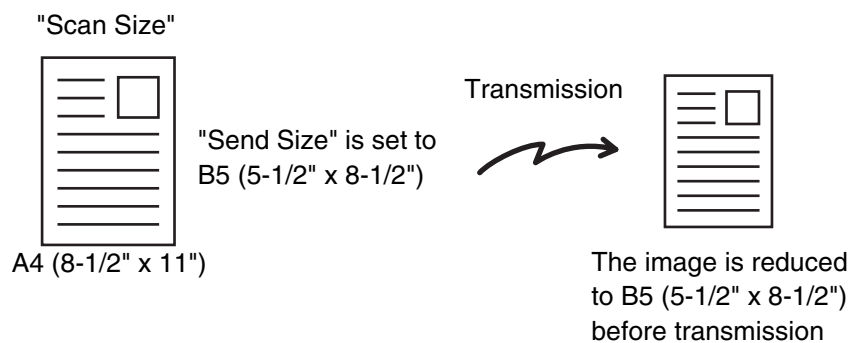

- Only standard original sizes can be automatically detected.
 - [STANDARD SIZES](#) (page 27)
- When the original size is a non-standard size, or if the size is not detected correctly, manually specify the original scan size.
 - [Specifying the original scan size \(by paper size\)](#) (page 46)
 - [Specifying the original scan size \(by numerical values\)](#) (page 48)

Specifying the original scan size (by paper size)

If the original is a non-standard size or you wish to change the scan size, touch the [Original] key to specify the original size manually. Place the original in the document feeder tray or on the document glass and follow the steps below.

1

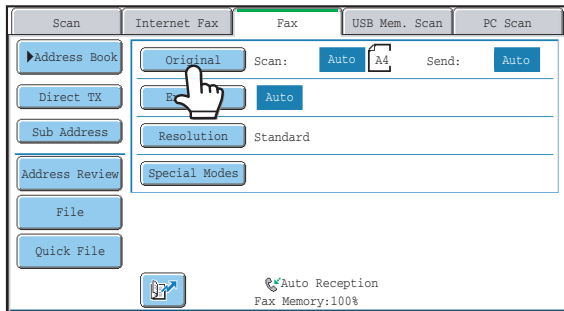

Touch the [Original] key.

The automatically detected original size appears to the right of the [Original] key.

2

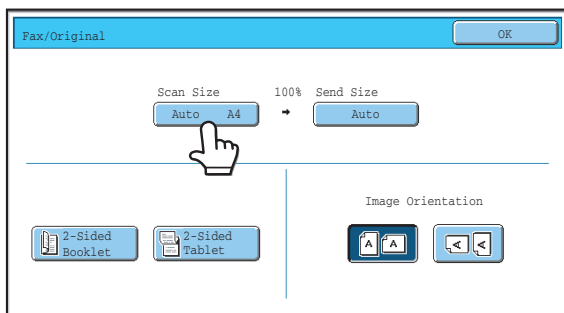

Touch the [Scan Size] key.

3

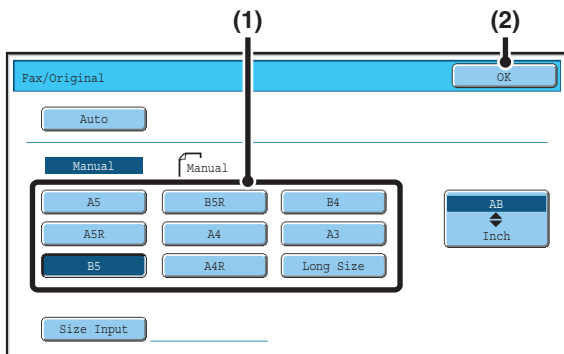

Specify the scan size.

- (1) Touch the appropriate original size key.
- (2) Touch the [OK] key.



- If you are sending a long original, touch the [Long Size] key. Use the automatic document feeder to scan a long original. The maximum length that can be scanned is 800 mm (31-1/2") (the maximum height is 297 mm (11-5/8")).
- To specify an Inch size for the scan size, touch the [AB \updownarrow Inch] key to highlight the [Inch] side and then specify the scan size.

4

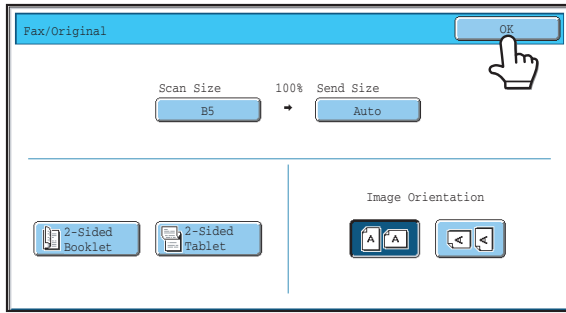

Touch the [OK] key.



When [Long Size] is selected, the 2-sided scanning setting and send size cannot be changed.

Specifying the original scan size (by numerical values)

When scanning a non-standard size original such as a postcard or card, follow these steps to specify the original size. The width can be from 64 mm to 432 mm (2-1/2" to 17"), and the height can be from 64 mm to 297 mm (2-1/2" to 11-5/8").

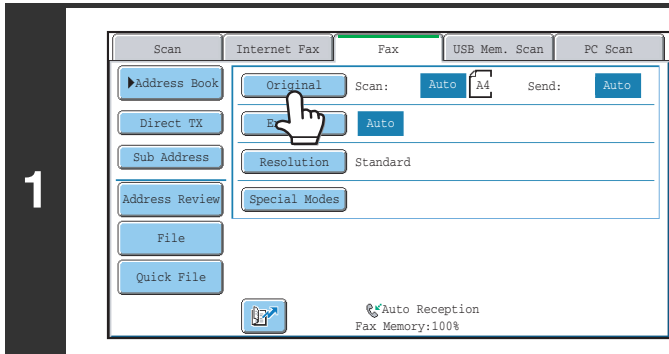

Touch the [Original] key.

The automatically detected original size appears to the right of the [Original] key.

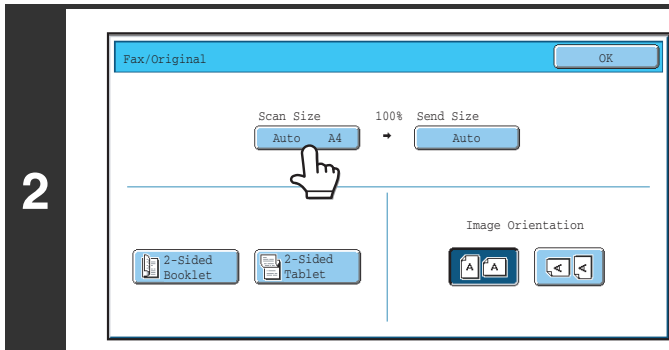

Touch the [Scan Size] key.

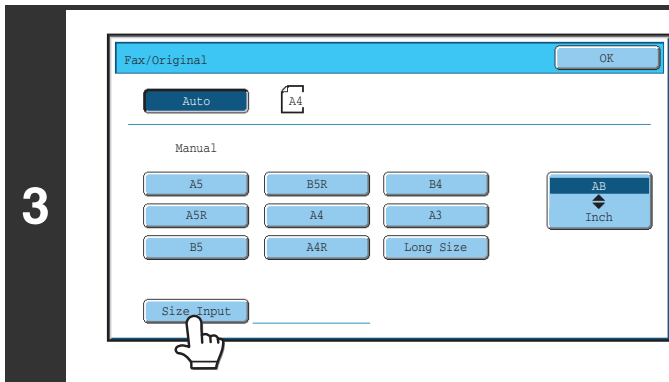

Touch the [Size Input] key.

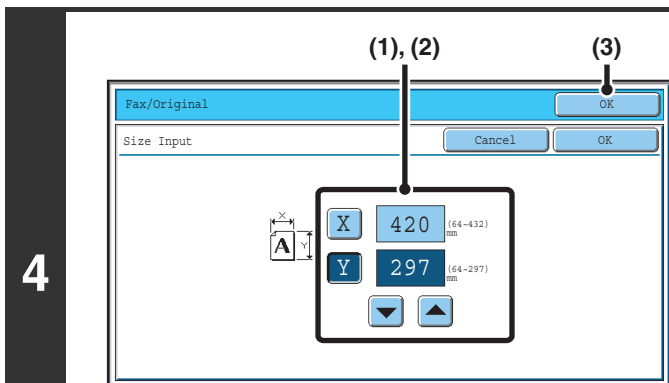

Enter the scan size.

- (1) Touch the [X] key and enter the X (horizontal) dimension with the keys.
- (2) Touch the [Y] key and enter the Y (vertical) dimension with the keys.
- (3) Touch the [OK] key.

To complete the setting and return to the screen of step 3, touch the [OK] key next to the [Cancel] key.



System Settings (Administrator): Original Size Detector Setting

This is used to set the size entry screen to "inch units" or "mm units".

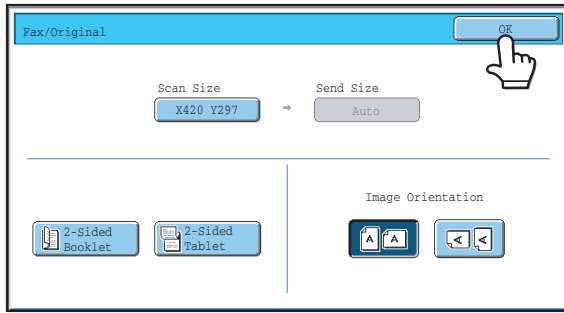

Touch the [OK] key.

The specified size appears in the [Scan Size] key.



- When the scan size is specified by numerical values, the send size cannot be specified.
- When the automatic document feeder is used, an original longer than 432 mm (17") can be scanned (maximum width 800 mm (31-1/2")). In this case, touch the [Long Size] key in the screen of step 3.
 - 👉 [Specifying the original scan size \(by paper size\)](#) (page 46)

Specifying the send size of the original

Specify the send size as a paper size. If a send size bigger than the scan size is selected, the image will be enlarged. If a send size smaller than the scan size is selected, the image will be reduced.

 The send size cannot be specified when [Long Size] is selected for the scan size, or when the scan size is specified by numerical values.

1

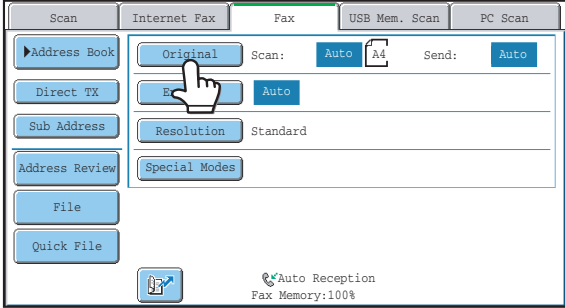

The screenshot shows the 'Fax' menu with several options. The 'Original' key is highlighted with a hand icon, indicating it should be touched. Other keys include 'Auto', 'Resolution', 'Special Modes', 'Address Book', 'Direct TX', 'Sub Address', 'Address Review', 'File', and 'Quick File'. The 'Scan' and 'Send' settings are both set to 'Auto'.

Touch the [Original] key.

2

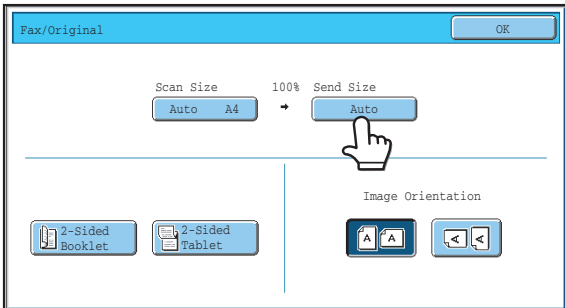

The screenshot shows the 'Fax/Original' dialog box. The 'Scan Size' is set to 'Auto A4' and the 'Send Size' is set to 'Auto'. A hand icon is touching the 'Auto' key under 'Send Size'. Below the size settings, there are options for 'Image Orientation' and '2-Sided Booklet/2-Sided Tablet'.

Touch the [Send Size] key.

3

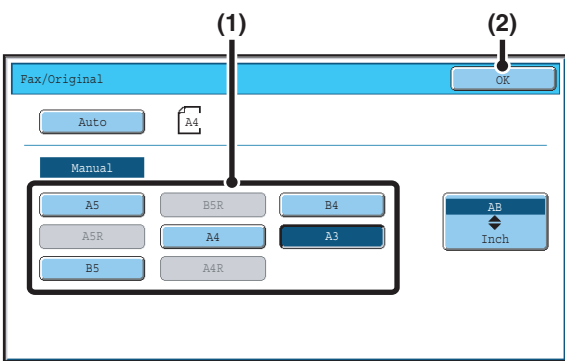

The screenshot shows the 'Fax/Original' dialog box with the 'Manual' menu open. A hand icon is touching the 'A3' key. The 'Manual' menu includes options for 'A5', 'A4R', 'B5', 'A4', 'A3', 'B4', 'B5R', 'A4R', and 'AB Inch'. The 'A3' key is highlighted with a dark blue background. The 'OK' key is also visible in the top right corner.

Specify the send size.

- (1) Touch the desired send size key.
- (2) Touch the [OK] key.

- 
- Depending on the "Scan Size" setting, it may not be possible to select some sizes for the "Send Size". Size keys that cannot be specified for the "Send Size" are greyed out to prevent selection.
 - To specify an Inch size for the send size, touch the [AB \updownarrow Inch] key to highlight the [Inch] side and then specify the send size.

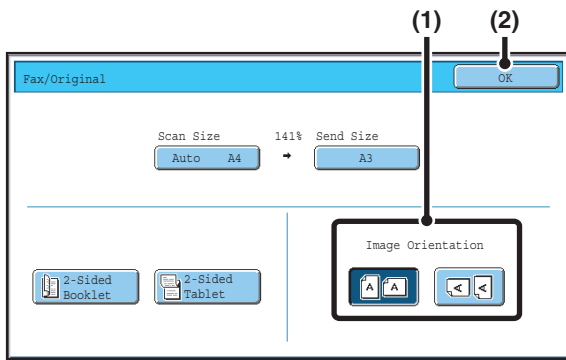

Specify the orientation in which the original is placed.

- (1) Touch the appropriate [Image Orientation] key.

If the wrong orientation is selected here, the image may not be sent properly when using enlargement/reduction.

- (2) Touch the [OK] key.



The ratio used for reduction or enlargement of the original will appear between the "Scan Size" and the "Send Size".

CHANGING THE EXPOSURE

The exposure can be changed to match the darkness of the original.

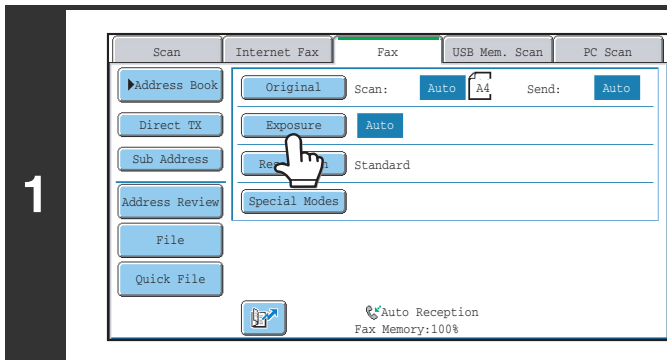

Touch the [Exposure] key.

The current exposure setting appears to the right of the [Exposure] key.

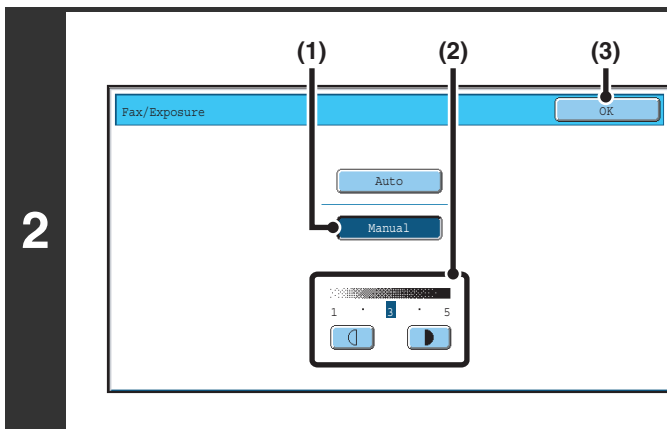

Select the exposure.

(1) Touch the [Manual] key.

(2) Adjust the exposure with the keys.

When the exposure is set to [Auto], the keys cannot be used.

The exposure darkens when the key is touched, and lightens when the key is touched.

To return to auto exposure adjustment, touch the [Auto] key.

(3) Touch the [OK] key.

When using the document glass to scan multiple original pages, the exposure setting can be changed each time you change pages. When using the automatic document feeder, the exposure setting cannot be changed once scanning has begun. (However, when "Job Build" in the special modes is used, the exposure can be changed each time a new set of originals is inserted.)

System Settings (Administrator): Default Exposure Settings
This is used to change the default exposure setting.

Exposure settings

Exposure		When to select
Auto		This setting automatically adjusts the exposure for light and dark parts of the original.
Manual	1-2	Select this setting when the original consists of dark text.
	3	Select this setting for a normal original (neither dark nor light).
	4-5	Select this setting when the original consists of faint text.

CHANGING THE RESOLUTION

The resolution can be selected to match the characteristics of the original, such as text or photo, the size of the text, and the darkness of the image.

1

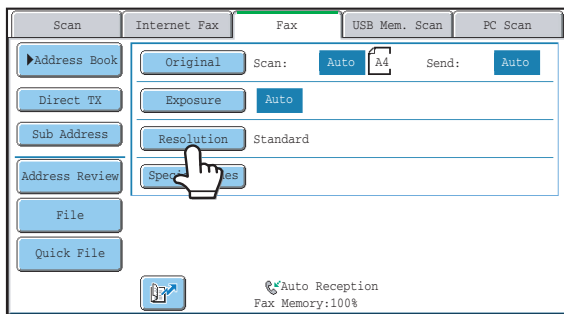

Touch the [Resolution] key.

The current resolution setting appears to the right of the [Resolution] key.

2

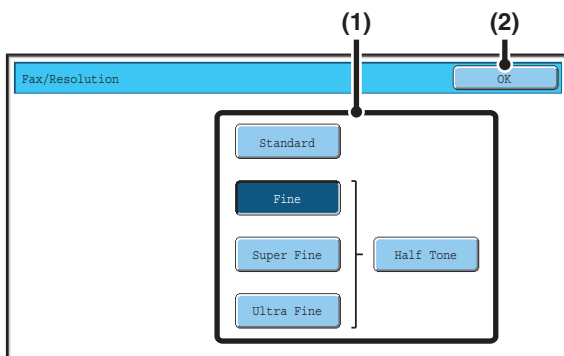

Select the resolution.

- (1) Touch the key of the desired resolution.
- (2) Touch the [OK] key.



When [Fine], [Super Fine], or [Ultra Fine] is selected, the [Half Tone] key can be touched to select halftone.



- When using the document glass to scan multiple original pages, the resolution setting can be changed each time you change pages. When using the automatic document feeder, the resolution setting cannot be changed once scanning has begun. (However, when "Job Build" in the special modes is used, the resolution can be changed each time a new set of originals is inserted.)
- When a fax is sent at [Ultra Fine], [Super Fine], or [Fine] resolution, a lower resolution will be used if the receiving machine does not have that resolution.



System Settings (Administrator): Initial Resolution Setting

This is used to change the default resolution setting.

Resolution settings

Resolution	When to select
Standard	Select this setting when your original consists of normal-sized text (like the text in this manual).
Fine	Select this setting when your original has small text or diagrams with fine lines. The original will be scanned at twice the resolution of the [Standard] setting.
Super Fine	Select this setting when your original has intricate pictures or diagrams. A higher-quality image will be produced than with the [Fine] setting.
Ultra Fine	Select this setting when your original has intricate pictures or diagrams. This setting gives the best image quality. However, transmission will take longer than with the other settings.
Half Tone	Select this setting when your original is a photograph or has gradations of colour (such as a colour original). This setting will produce a clearer image than [Fine], [Super Fine], or [Ultra Fine] used alone. Halftone cannot be selected when [Standard] is used.

4 FAX RECEPTION

This chapter explains the basic procedures for receiving faxes.

RECEIVING FAXES

When the reception mode is set to "Auto Reception", the machine will receive and print faxes automatically. The fax reception mode is displayed in the base screen.

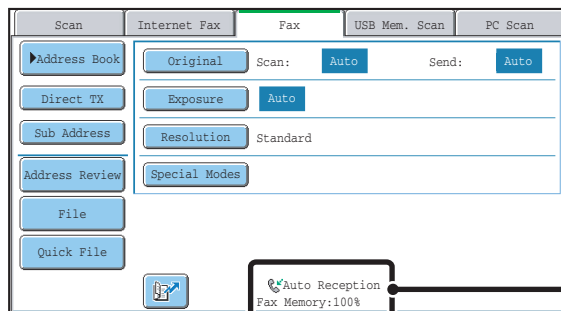

This shows the current fax reception mode and the amount of free memory remaining.

- When fax reception is in progress, it is possible to reserve a transmission by performing the transmission in memory transmission mode.
➔ [TRANSMISSION METHODS](#) (page 24)
- To print received faxes, make sure that the required paper is loaded in the machine's paper trays. It is not necessary to load A4 (8-1/2" x 11") paper and B5 (5-1/2" x 8-1/2") paper in both the vertical (📄) and horizontal (📄) orientations. Differences in orientation are automatically adjusted when faxes are received. When a fax smaller than A4 (8-1/2" x 11") size is received, the size of the paper used for printing will vary depending on the orientation (vertical or horizontal) in which the sender placed the original.
- **System Settings: Receive Setting**
This is used to change the fax reception mode. "Auto Reception" should normally be used. Select "Manual Reception" when an extension phone is connected to the machine.
- **System Settings (Administrator): Anti Junk Fax Setting**
This setting is used to enter fax numbers from which you wish to block reception.

RECEIVING A FAX

When a fax is transmitted to the machine, the machine automatically receives and prints the fax.

1

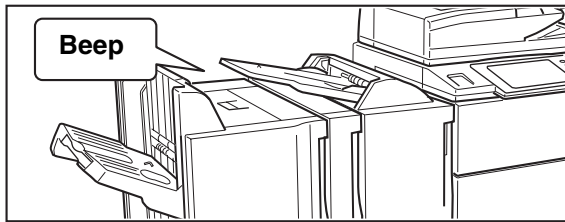

The machine rings and fax reception begins automatically.

A beep sounds when reception ends.



- **System Settings (Administrator): Speaker Settings**

This is used to change the volume and tone of the reception beep.

- **System Settings (Administrator): Number of Calls in Auto Reception**

This is used to change the number of rings on which fax reception begins automatically. To receive faxes without the machine ringing, select "0" rings.

2

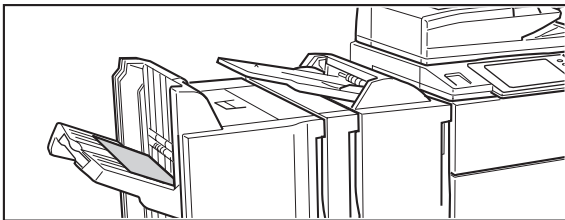

The fax is automatically printed.



- **If a password entry screen appears...**

A password must be entered to print the received fax. When the correct password is entered, the received fax is printed.

➤ [PRINTING A PASSWORD-PROTECTED FAX \(Hold Setting For Received Data Print\)](#) (page 57)

- **The output tray and stapling (when a finisher is installed) can be selected.**

The number of copies of received faxes that are printed and the output tray can be selected. When a finisher is installed, the number of copies printed, the output tray, and stapling can be selected. For more information, see the System Settings Guide.



- If printing of a copy job or print job is in progress when a fax is received, the fax will not be printed until the previously reserved job is completed.
- Received faxes will not be printed when the machine cannot print due to an error condition such as out of paper, out of toner, or a paper misfeed. The faxes will be printed automatically when the error condition is cleared. (If the machine ran out of paper, touch the [OK] key in the touch panel after loading paper.)
- When received faxes cannot be printed, the faxes can be forwarded to another fax machine.
➤ [FORWARDING RECEIVED FAXES \(Fax Data Forward\)](#) (page 58)



- **System Settings (Administrator): Duplex Reception Setting**

This is used to have received faxes printed on both sides of the paper.

RECEIVING A FAX MANUALLY

A fax can be received manually using the touch panel. While the machine rings, touch the [Speaker] key in the base screen and then touch the [Fax Manual Reception] key that appears.

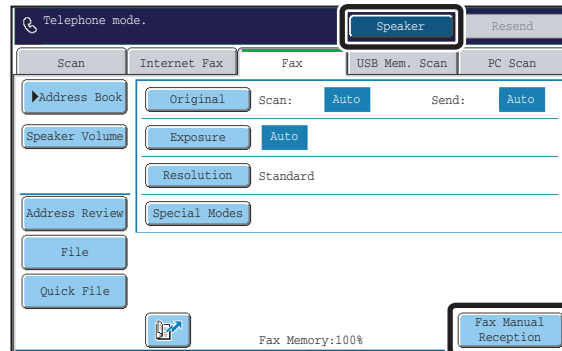



- When a call is answered by touching the [Speaker] key, you will be able to hear the other party, however, you will not be able to speak.
- Even when you use an extension phone to answer a call, you can touch the [Fax Manual Reception] key in the touch panel to begin fax reception. You can also use the extension phone to begin fax reception.
➤ [RECEIVING A FAX AFTER ANSWERING A CALL ON THE EXTENSION PHONE \(Remote Reception\)](#) (page 113)

PRINTING A PASSWORD-PROTECTED FAX (Hold Setting For Received Data Print)

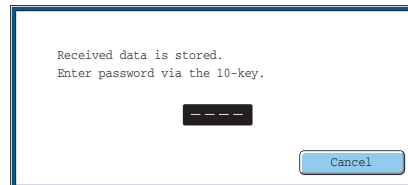
"Hold Setting for Received Data Print" can be enabled in the system settings (administrator) to have faxes received to memory without being printed. To print the faxes, a password must be entered. When this function is used, a password entry screen appears in the touch panel when a fax is received.



When the previously programmed 4-digit password is entered with the numeric keys, printing begins. The [Cancel] key can be touched to close the password entry screen. If this is done, the data in memory key () will blink in the touch panel. The password entry screen will reappear when you touch the blinking key () or change modes.

- The received faxes will be retained in memory regardless of whether they were received automatically or manually. If a transaction report is set to print when a fax is received, the transaction report will also be retained in memory.
- If "Fax Data Receive/Forward" is executed in the system settings to forward received faxes to another machine, faxes retained in memory will also be forwarded. At that time, the same password entry screen as for printing will appear. Forwarding will not take place unless the password is entered.



System Settings (Administrator): Hold Setting for Received Data Print

Enable this setting to have received faxes retained in memory until a password is entered. This setting is also used to program the password.

FORWARDING RECEIVED FAXES (Fax Data Forward)

When the machine cannot print because it is out of paper or out of toner, received faxes can be forwarded to another previously programmed fax machine.

This function is convenient in an office or work area that has two or more telephone lines and another fax machine is connected to a different line than the machine.

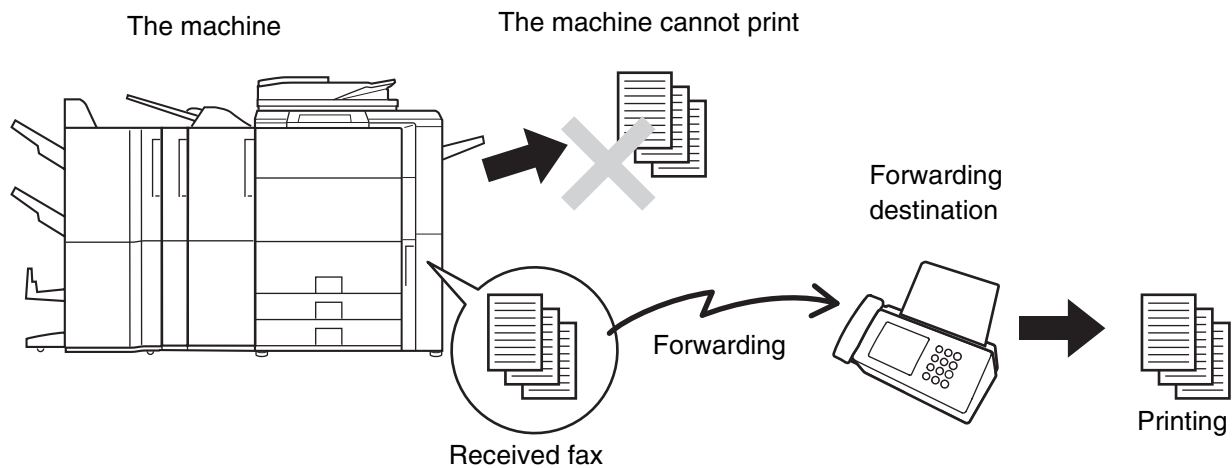

Forwarding of received faxes is executed in the system settings of the machine. Touch the [SYSTEM SETTINGS] key on the operation panel to display the system setting menu screen in the touch panel. Select [Fax Data Receive/Forward] - [Fax Settings], and then touch the key that executes received fax forwarding.



- If some pages of a fax that is being forwarded were successfully printed, only those pages that were not printed will be forwarded.
- A forwarded fax becomes a fax transmission job. If transmission does not take place because the transmission was cancelled or an error occurred, the fax will be held in memory until it can be printed.
- All faxes received are forwarded. Note, however, that faxes received to an F-code confidential memory box cannot be forwarded.
- If a password entry screen appears after touching the [OK] key, "Hold Setting for Received Data Print" has been enabled. Enter the password with the numeric keys to begin forwarding.
👉 [PRINTING A PASSWORD-PROTECTED FAX \(Hold Setting For Received Data Print\)](#) (page 57)



- **System Settings: Fax Data Receive/Forward**
Use this to forward received faxes when the machine is unable to print.
- **System Settings (Administrator): Set the Telephone Number for Data Forwarding**
This is used to store the forwarding fax number.

FORWARDING A RECEIVED FAX TO AN E-MAIL ADDRESS (Inbound Routing Settings)

Received faxes can be automatically forwarded to a specified E-mail address. This function can be used to forward received faxes directly to an e-mail address without printing the faxes.

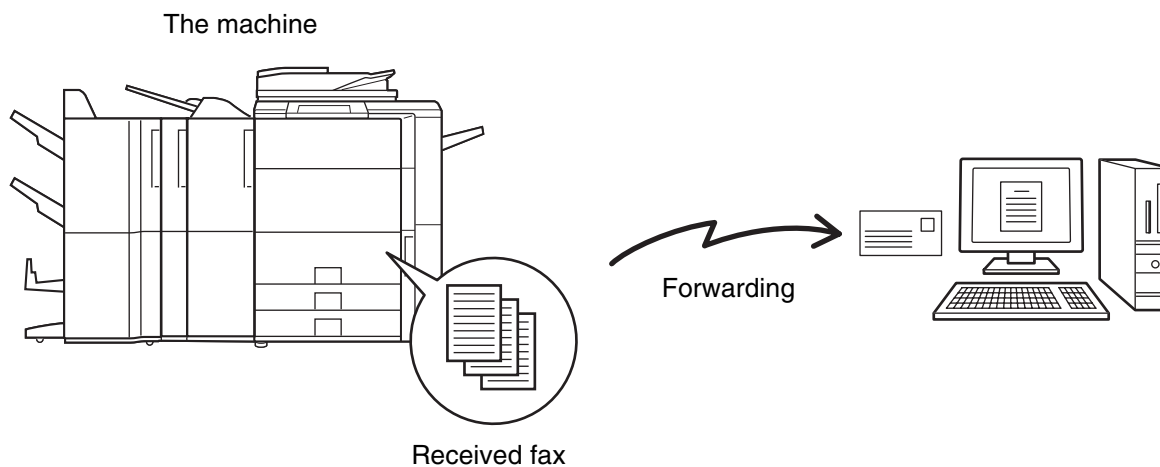

To configure inbound routing settings, click [Application Settings] and then [Inbound Routing Settings] in the Web page menu. (Administrator rights are required.)





- The format of the forwarded file is TIFF-F.
- This function cannot be used for faxes received by confidential reception.

5 SPECIAL MODES

This chapter explains special modes that can be used for fax transmission.







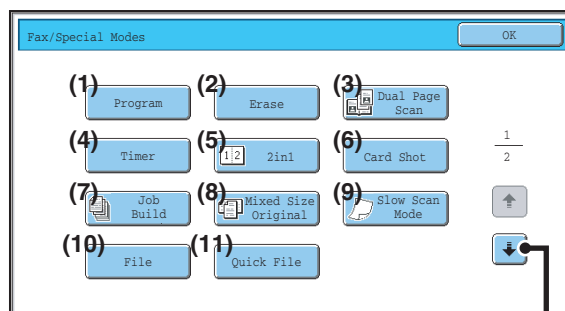
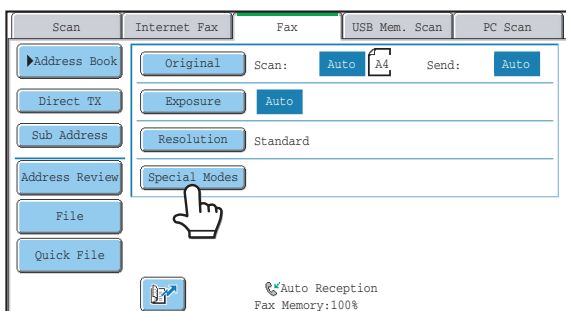

SPECIAL MODES

When the [Special Modes] key is pressed in the base screen, the special modes menu screen appears. The special modes menu consists of two screens. Touch the   keys to move between the screens. After selecting special mode settings, touch the [OK] key in the special modes menu screen to complete the settings and return to the base screen of fax mode.

Special modes menu (1st screen)



 Special modes menu (2nd screen)
(page 61)

- (1) **[Program] key**
 [STORING FAX OPERATIONS \(Program\)](#) (page 62)
- (2) **[Erase] key**
 [ERASING PERIPHERAL SHADOWS ON THE IMAGE \(Erase\)](#) (page 65)
- (3) **[Dual Page Scan] key**
 [TRANSMITTING AN ORIGINAL AS TWO SEPARATE PAGES \(Dual Page Scan\)](#) (page 67)
- (4) **[Timer] key**
 [SENDING A FAX AT A SPECIFIED TIME \(Timer\)](#) (page 70)
- (5) **[2in1] key**
 [SENDING TWO PAGES AS A SINGLE PAGE \(2in1\)](#) (page 73)
- (6) **[Card Shot] key**
 [SENDING BOTH SIDES OF A CARD AS A SINGLE PAGE \(Card Shot\)](#) (page 76)
- (7) **[Job Build] key**
 [SENDING A LARGE NUMBER OF PAGES \(Job Build\)](#) (page 79)
- (8) **[Mixed Size Original] key**
 [TRANSMITTING ORIGINALS OF DIFFERENT SIZES \(Mixed Size Original\)](#) (page 82)
- (9) **[Slow Scan Mode] key**
 [FAXING THIN ORIGINALS \(Slow Scan Mode\)](#) (page 84)
- (10) **[File] key**
Touch this to use the File function of document filing mode. For more information on File, see the Document Filing Guide.
- (11) **[Quick File] key**
Touch this to use the Quick File function of document filing mode. For more information on Quick File, see the Document Filing Guide.

Special modes menu (2nd screen)

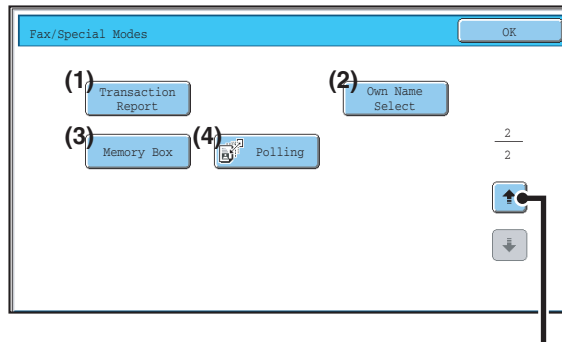

Special modes menu (1st screen) (page 60)

(1) [Transaction Report] key

CHANGING THE TRANSACTION REPORT PRINT CONDITION FOR A SINGLE TRANSMISSION (page 125)

(3) [Memory Box] key

SENDING A FAX WHEN ANOTHER MACHINE POLLS YOUR MACHINE (Polling Memory) (page 91)

(2) [Own Name Select] key

TEMPORARILY CHANGING THE SENDER INFORMATION (Own Name Select) (page 87)

(4) [Polling] key

CALLING A FAX MACHINE AND INITIATING RECEPTION (Polling) (page 88)

Special modes can generally be combined with other special modes, however, there are some combinations that are not possible. If a prohibited combination is selected, a message will appear in the touch panel.

[OK] key and [Cancel] key

In some cases two [OK] keys and one [Cancel] key will appear in the special mode screens. The keys are used as follows:

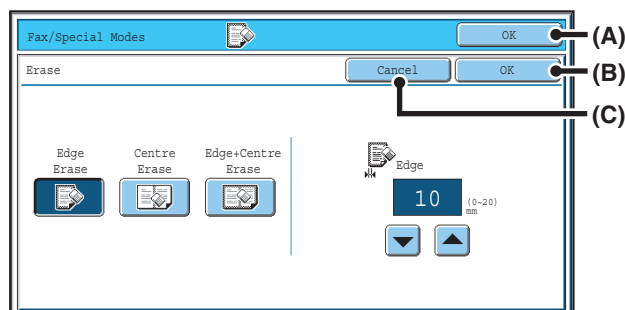

(A) Enter the selected special mode setting and return to the base screen.

(B) Enter the selected special mode setting and return to the special modes menu screen. Touch this key when you wish to continue selecting other special mode settings.

(C) During selection of special mode settings, this key returns you to the special modes menu screen without saving the settings. When settings have been completed, this cancels the settings and returns you to the special modes menu screen.

STORING FAX OPERATIONS (Program)

A program is a group of transmission settings stored together. When transmission settings are stored in a program, the settings can be retrieved and used for a fax job by means of a simple operation.

For example, suppose that the same A4 (8-1/2" x 11") size documents are distributed to branch offices in various regions once a month.

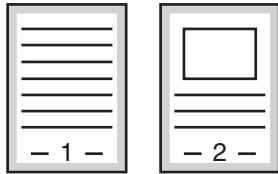

- (1) The same documents are faxed to each branch office
- (2) To save paper, two document pages are faxed as a single page
- (3) Smudges on the edges of the documents are erased before transmission

A4 (8-1/2" x 11") size documents to be distributed



Fax received by recipients.



When a job program is not stored	When a job program is stored
<p>Enter the fax numbers of the branch offices</p> <p style="text-align: center;">↓</p> <p>Select the 2in1 function.</p> <p style="text-align: center;">↓</p> <p>Select erase settings</p> <p style="text-align: center;">↓</p>  <p>Press the [BLACK & WHITE START] key (○●). The originals are scanned and transmitted.</p>	<p>Retrieve the stored program.</p> <p style="text-align: center;">↓</p>  <p>Press the [BLACK & WHITE START] key (○●). The originals are scanned and transmitted.</p>
<p>Considerable time is required to send the documents each month because the above settings must be selected. In addition, mistakes may occasionally be made when selecting the settings, so incorrect transmissions may occur.</p>	<p>When a program is stored, settings are selected with ease by simply pressing the program key. In addition, transmission takes place based on the stored settings so there are no chances for mistakes.</p>



- **Programs are stored, edited, and deleted using "Address Control" in the system settings. See "Program" in the System Settings Guide.**
- Programs can also be stored using the Web pages. Click [Job Programs] and then [Program Registration] in the Web page menu.
- The settings stored in a program will be retained even after the program is used for transmission. The same settings can be used repeatedly for transmission.
- The following settings can be stored in programs.
 - Destinations: One-touch keys, group keys, search numbers
 - Image settings: Resolution and exposure settings
 - Special modes: Polling reception, Erase, Dual Page Scan, 2in1
 - F-code communication: A destination that includes an F-code can be stored to perform an F-code operation.
- Up to 48 programs can be stored.
- Up to 500 destinations can be stored in each program.

USING A PROGRAM TO SEND A FAX

1 Place the original.

Place the original in the document feeder tray or on the document glass as appropriate for the functions stored in the program.

2 Select the special modes.

(1) Touch the [Special Modes] key.

(2) Touch the [Program] key.

☞ [Special modes menu \(1st screen\)](#) (page 60)

3

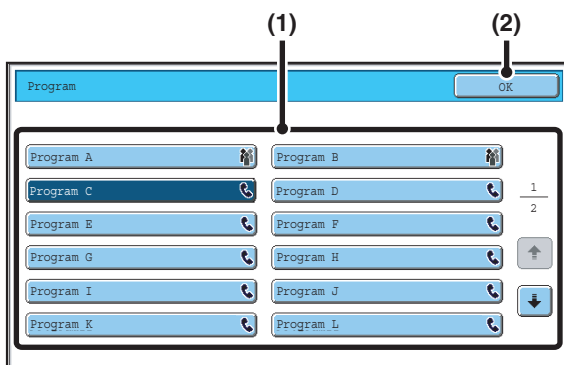

Retrieve the stored program.

(1) Touch the desired program key.

(2) Touch the [OK] key.

4

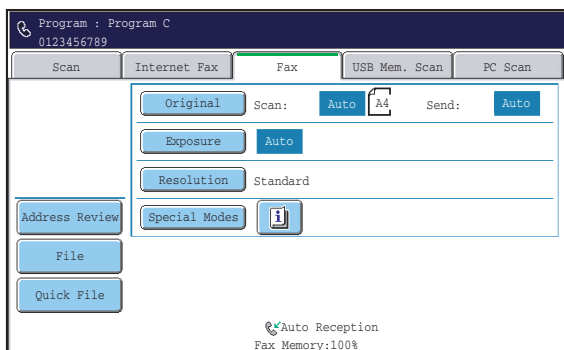

Select additional settings.

Select any settings or functions that you wish to use that cannot be stored in a program. The following items can be selected.

- Image settings: original scan size, send size, 2-sided scanning
- Special modes: Timer Transmission, Card Shot, Job Build, Mixed Size Original, Slow Scan Mode, Own Name Select, Transaction Report, File, Quick File



- The screen that appears will vary depending on the destination stored in the program.
- The mode cannot be changed here.
- Functions stored in the program cannot be cancelled here.



Press the [BLACK & WHITE START] key (○●).

Scanning begins.

- If you inserted the original pages in the document feeder tray, all pages are scanned. A beep will sound to indicate that scanning is finished.
- If you are scanning the original on the document glass, scan each page one page at a time.

When scanning finishes, place the next original and press the [BLACK & WHITE START] key (○●). Repeat until all pages have been scanned and then touch the [Read-End] key.

A beep will sound to indicate that scanning is finished.



To cancel scanning...

Press the [STOP] key (⏏).

ERASING PERIPHERAL SHADOWS ON THE IMAGE (Erase)

The erase function is used to erase shadows on images produced when scanning thick originals or books. (This function erases the parts of the image where shadows tend to form. The function does not detect shadows and erase only the shadows.)

Scanning a thick book

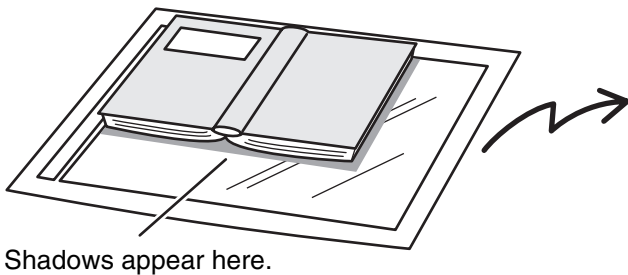

Shadows appear here.

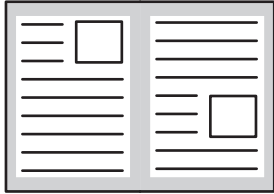
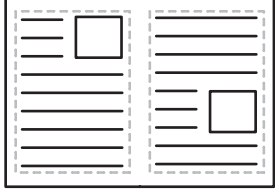
Not using the erase function	Using the erase function
	
Shadows appear in the image.	No shadows appear.

Erase modes



Edge Erase

This erases shadows that appear at the edges of the image when thick originals or books are faxed.

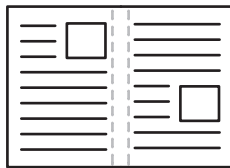

Centre Erase

This erases shadows at the bindings of books or other bound documents.

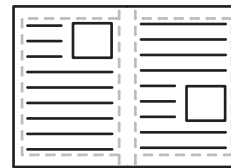

Edge + Centre Erase

This erases shadows at both the edges and the binding.

1

Place the original.

Place the original face up in the document feeder tray, or face down on the document glass.

2

Select the special modes.

(1) Touch the [Special Modes] key.

(2) Touch the [Erase] key.

 [Special modes menu \(1st screen\)](#) (page 60)

3

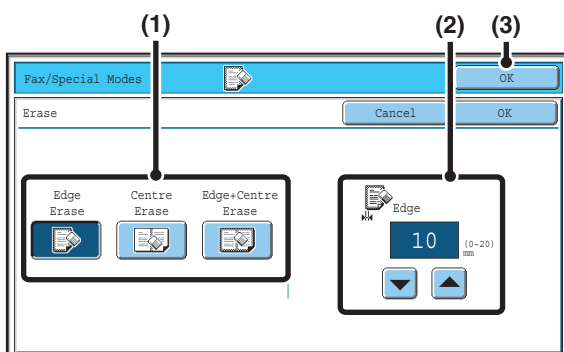

Select the erase settings.

(1) Touch the desired erase mode.

Select one of the three erase modes.

(2) Set the erasure width with the   keys.

0 mm to 20 mm (0" to 1") can be entered.

(3) Touch the [OK] key.

4

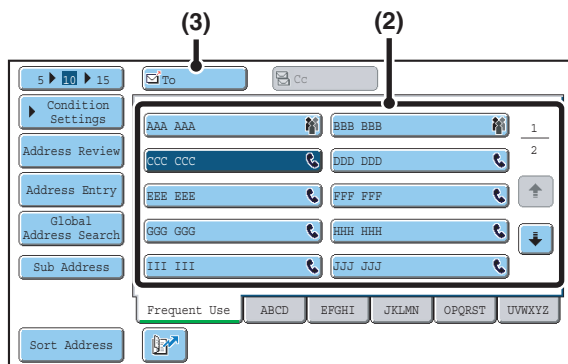

Enter the destination fax number

- (1) Touch the [Address Book] key in the base screen.
- (2) Touch the one-touch key of the desired destination.
- (3) Touch the [To] key.



In addition to specification by one-touch key, a destination can also be specified using a search number. You can also directly enter a fax number with the numeric keys or look up a destination in a global address book. For more information, see "2. ENTERING DESTINATIONS" (page 15).

5



Press the [BLACK & WHITE START] key (○●).

Scanning begins.

- If you inserted the original pages in the document feeder tray, all pages are scanned. A beep will sound to indicate that scanning is finished.
- If you are scanning the original on the document glass, scan each page one page at a time. When scanning finishes, place the next original and press the [BLACK & WHITE START] key (○●). Repeat until all pages have been scanned and then touch the [Read-End] key. A beep will sound to indicate that scanning is finished.



To cancel scanning...

Press the [STOP] key (⊘).



When the erase function is used, erase takes place at the edges of the original image. If you also use a reduction or an enlargement setting, the erase width will change according to the selected ratio. For example, if the erase width setting is 20 mm (1") and the image is reduced to 50%, the erase width will be 10 mm (1/2").



To cancel an erase setting...

Touch the [Cancel] key in the screen of step 3.



System Settings (Administrator): Erase Width Adjustment

The default erase width setting is linked to the copy mode system setting, and can be set from 0 mm to 20 mm (0" to 1"). The factory default setting is 10 mm (1/2").

TRANSMITTING AN ORIGINAL AS TWO SEPARATE PAGES (Dual Page Scan)

The left and right sides of an original can be transmitted as two separate pages. This function is useful when you wish to fax the left and right pages of a book or other bound document as separate pages.

Example: Faxing the left and right pages of a book

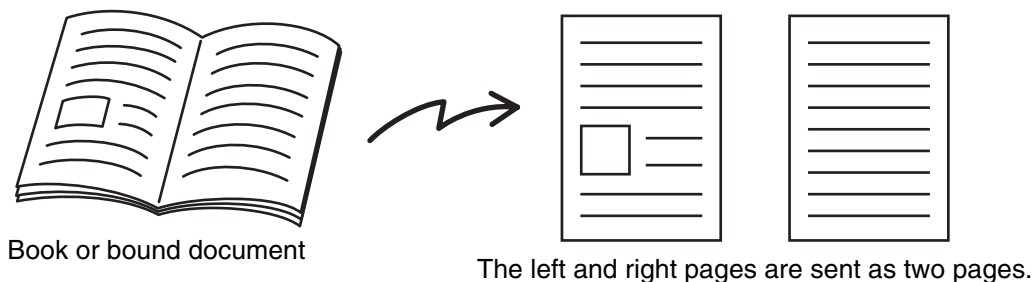

Example:

Original scan size	Transmitted image
A3 (11" x 17") x 1 page	A4 (8-1/2" x 11") x 2 pages



- When using dual page scan, the original must be placed on the document glass.
- The send size cannot be changed.

1

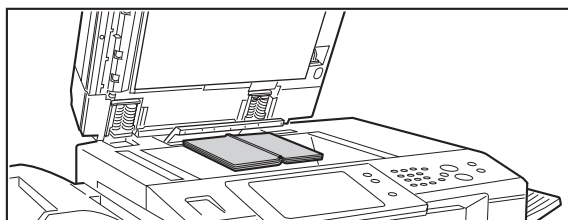

Place the original face down on the document glass.

Align the centre of the original with the appropriate size mark ▼.

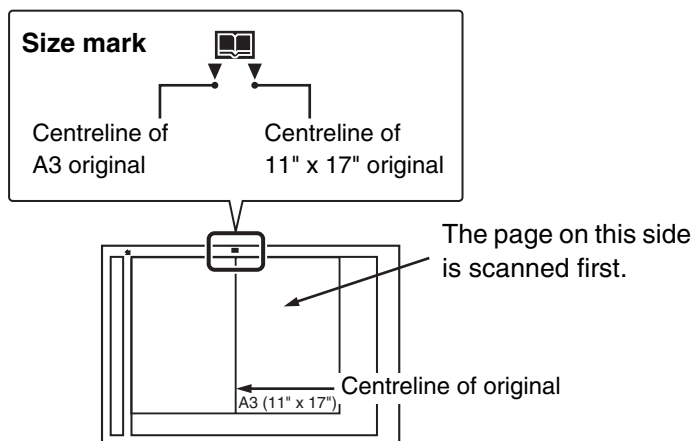

2

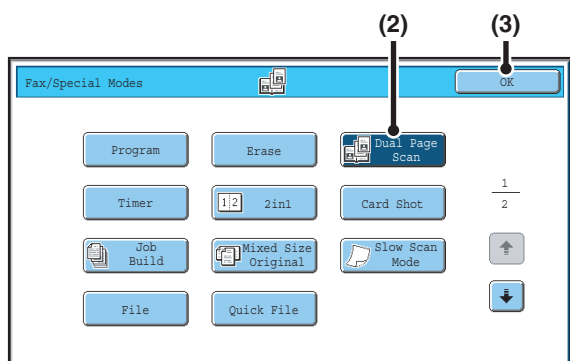

Select Dual Page Scan.

- (1) Touch the [Special Modes] key.
 ☞ [SPECIAL MODES](#) (page 60)
- (2) Touch the [Dual Page Scan] key so that it is highlighted.
- (3) Touch the [OK] key.

3

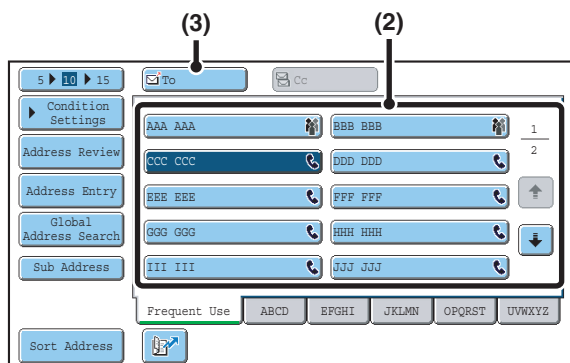

Enter the destination fax number

- (1) Touch the [Address Book] key in the base screen.
- (2) Touch the one-touch key of the desired destination.
- (3) Touch the [To] key.



In addition to specification by one-touch key, a destination can also be specified using a search number. You can also directly enter a fax number with the numeric keys or look up a destination in a global address book. For more information, see "2. ENTERING DESTINATIONS" (page 15).

4



Press the [BLACK & WHITE START] key (○●) to scan the first original.



To cancel scanning...
 Press the [STOP] key (↶).

5

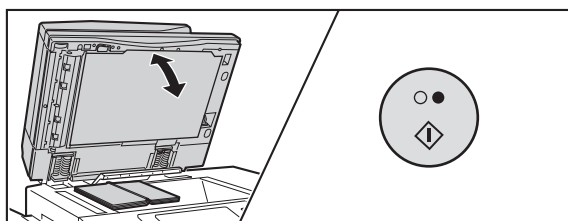

If you have more pages to scan, change pages and then press the [BLACK & WHITE START] key (○●).

Repeat this step until all pages have been scanned.

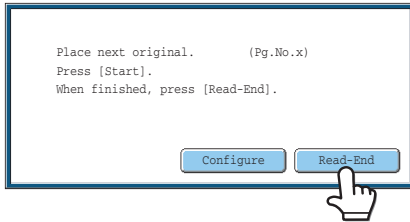

Touch the [Read-End] key.



The [Configure] key can be touched to change the exposure, resolution, scan size, and send size for each original page scanned.



- To erase shadows caused by the binding of a book or other bound document, use the erase function. (Note, however, that "Centre Erase" and "Edge + Centre Erase" cannot be used.)
- When the scan size of the original is specified by numerical values, this function cannot be used.



To cancel Dual Page Scan...

Touch the [Dual Page Scan] key in the screen of step 2 so that it is not highlighted.

SENDING A FAX AT A SPECIFIED TIME (Timer)

When this function is used, transmission takes place automatically at a specified time.

The timer transmission function makes it easy to perform reserved transmissions, broadcast transmissions and other transmissions at night or other times when phone rates are low.

A timer setting can also be specified for polling reception to receive a fax when you are not present.

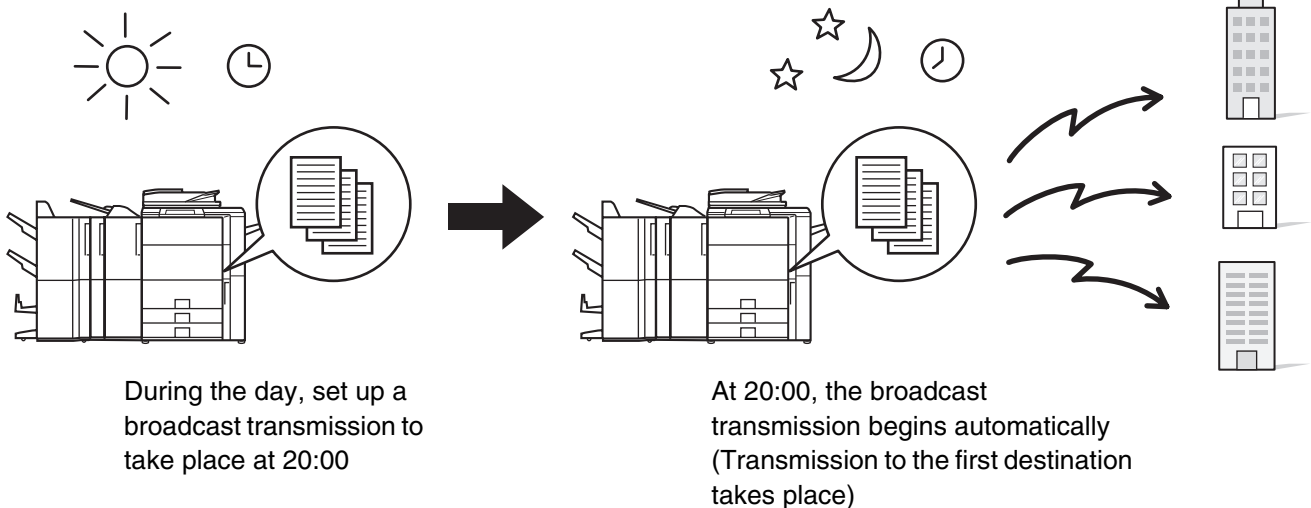

- When a timer transmission is set, keep the main power switch "on". Transmission will not take place if the main power is turned off at the specified time.
- When performing a timer transmission, you must scan the original into memory when you set up the transmission. It is not possible to leave the document in the auto document feeder or on the document glass and have it scanned at the reserved time of transmission.
- Settings selected for a timer transmission (exposure, resolution, special modes, etc.) are automatically cleared after the transmission is finished. (However, when the document filing function is used, the scanned original and settings are stored on the built-in hard drive. For more information on the document filing function, see the Document Filing Guide.)

1

Place the original.

Place the original face up in the document feeder tray, or face down on the document glass.

2

Select the special modes.

(1) Touch the [Special Modes] key.

(2) Touch the [Timer] key.

☞ [Special modes menu \(1st screen\)](#) (page 60)

3

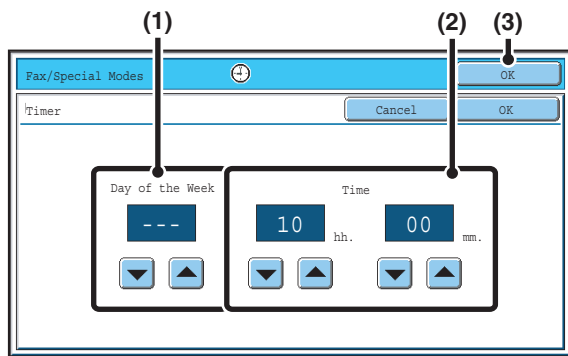

Set the time with the keys.

(1) Specify the day.

If you do not wish to specify a day, select [---]. In this case, transmission will begin when the time specified in (2) arrives.

(2) Specify the time (hour, minute)

Select the time in 24-hour format.

(3) Touch the [OK] key.



When this screen is opened, the setting will show the current time. If the time is not correct, press the [CLEAR ALL] key () to cancel the operation. Correct the time in the system settings and then perform the timer transmission procedure.

 [CHECKING THE DATE AND TIME](#) (page 130)

4

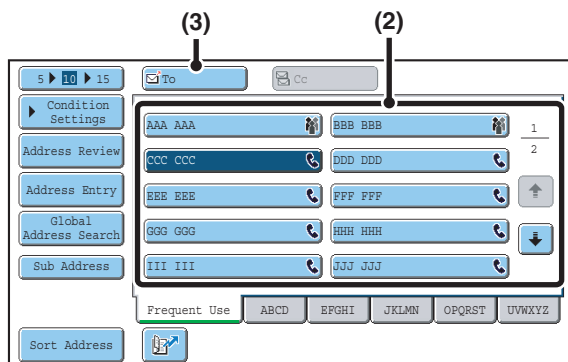

Enter the destination fax number

(1) Touch the [Address Book] key in the base screen.

(2) Touch the one-touch key of the desired destination.

(3) Touch the [To] key.



In addition to specification by one-touch key, a destination can also be specified using a search number. You can also directly enter a fax number with the numeric keys or look up a destination in a global address book. For more information, see "[2. ENTERING DESTINATIONS](#)" (page 15).



5



Press the [BLACK & WHITE START] key ().

Scanning begins.

- If you inserted the original pages in the document feeder tray, all pages are scanned.
A beep will sound to indicate that scanning is finished.
- If you are scanning the original on the document glass, scan each page one page at a time.

When scanning finishes, place the next original and press the [BLACK & WHITE START] key ( ). Repeat until all pages have been scanned and then touch the [Read-End] key.

A beep will sound to indicate that scanning is finished.



- The time can be specified up to a week in advance.
 - Up to 94 timer transmissions can be stored at once.
 - Only one timer polling operation can be stored at once. If you wish to poll multiple machines, store a serial polling timer operation.
 - If another transmission is in progress when the specified time arrives, the timer operation will begin after that transmission is finished.
 - Other operations can be performed after a timer transmission is set up.
 - This function cannot be used in direct transmission mode or when the speaker is used to dial.
 - If a timer transmission is given priority in the job status screen, the time specification is cancelled. The transmission will begin as soon as the job in progress is completed.
-  [GIVING PRIORITY TO A RESERVED FAX JOB](#) (page 123)



To cancel timer transmission...

Touch the [Cancel] key in the screen of step 3.

SENDING TWO PAGES AS A SINGLE PAGE (2in1)

Two original pages can be reduced and sent as a single page. This function is convenient when you have a large number of original pages and wish to reduce the number of pages sent.

Portrait-oriented originals

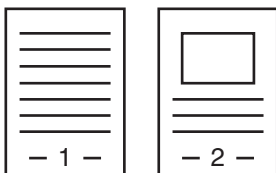

Transmission

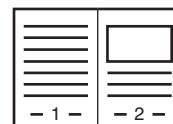

Landscape-oriented originals



Transmission

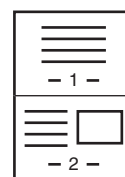

Place the original.



When placing the originals, orient them as shown below.

Originals	Document feeder tray Place the originals face up.	Document glass Place the originals face down.
Portrait orientation 		
Landscape orientation 		

1

2

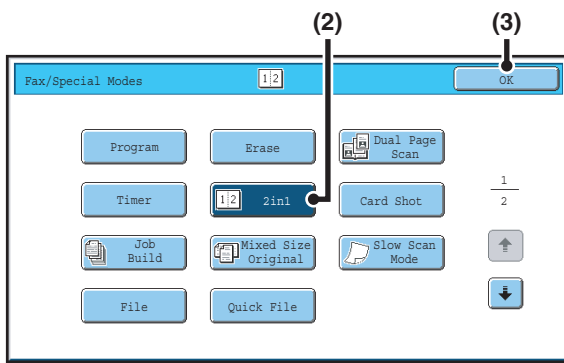

Select 2in1.

- (1) Touch the [Special Modes] key.
 ☞ [SPECIAL MODES](#) (page 60)
- (2) Touch the [2in1] key so that it is highlighted.
- (3) Touch the [OK] key.

3

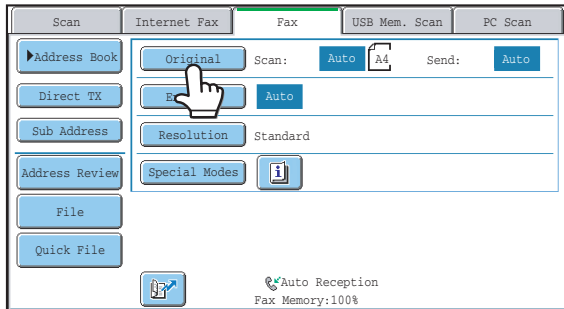

Touch the [Original] key.

4

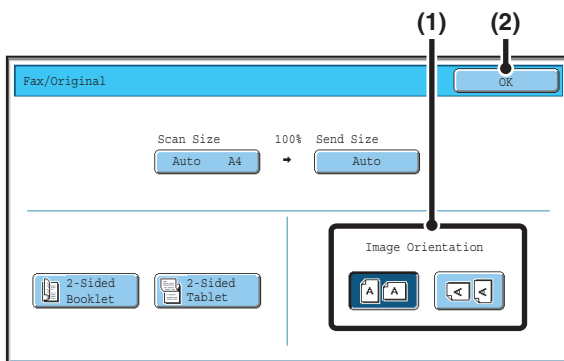

Specify the orientation in which the original is placed.

- (1) Touch the appropriate [Image Orientation] key.

If this setting is not correct, a suitable image may not be transmitted.

- (2) Touch the [OK] key.

5

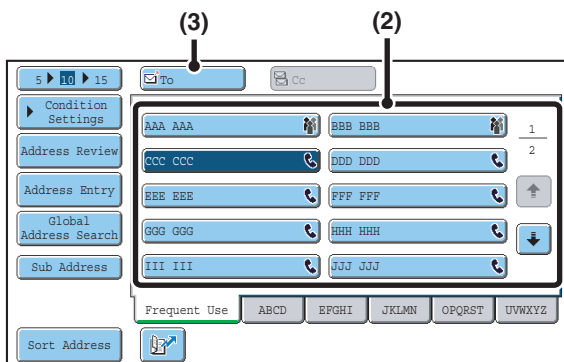

Enter the destination fax number

- (1) Touch the [Address Book] key in the base screen.
- (2) Touch the one-touch key of the desired destination.
- (3) Touch the [To] key.



In addition to specification by one-touch key, a destination can also be specified using a search number. You can also directly enter a fax number with the numeric keys or look up a destination in a global address book. For more information, see ["2. ENTERING DESTINATIONS"](#) (page 15).



Press the [BLACK & WHITE START] key (○●).

Scanning begins.

- If you inserted the original pages in the document feeder tray, all pages are scanned. A beep will sound to indicate that scanning is finished.
- If you are scanning the original on the document glass, scan each page one page at a time.

When scanning finishes, place the next original and press the [BLACK & WHITE START] key (○●). Repeat until all pages have been scanned and then touch the [Read-End] key.

A beep will sound to indicate that scanning is finished.



The [Configure] key can be touched in the scan-end confirmation screen to change the exposure, resolution, scan size, and send size. (However, when scanning each even-numbered page of the original, only the exposure can be changed.)



To cancel scanning...

Press the [STOP] key (⊘).



- Transmission is not possible at a size smaller than the original size.
- This function cannot be used in direct transmission mode or when the speaker is used to dial.
- The 2in1 function cannot be used when the original is other than A4, B5 and A5 (8-1/2" x 11" and 5-1/2" x 8-1/2") size.
- When the scan size of the original is specified by numerical values, this function cannot be used.



To cancel 2in1...

Touch the [2in1] key in the screen of step 2 so that it is not highlighted.

SENDING BOTH SIDES OF A CARD AS A SINGLE PAGE (Card Shot)

This function lets you send the front and reverse sides of a card as a single page, without the need to send each side separately.

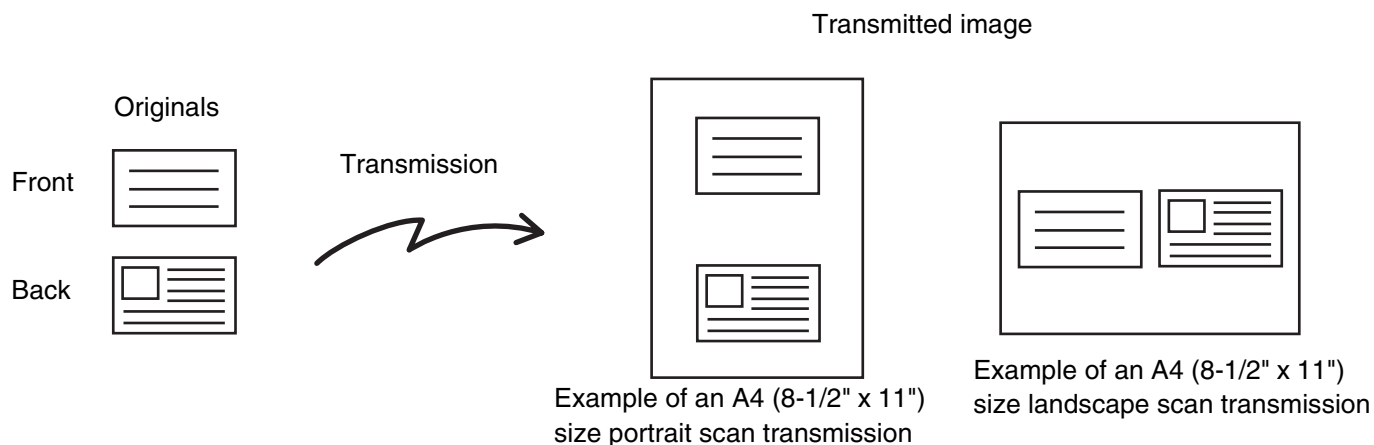

When using card shot, the original must be scanned on the document glass.

1

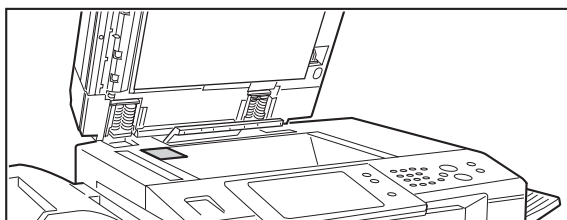

Place the original (card) face down on the document glass.

2

Select the special modes.

(1) Touch the [Special Modes] key.

(2) Touch the [Card Shot] key.

[Special modes menu \(1st screen\)](#) (page 60)

3

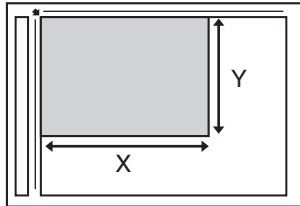
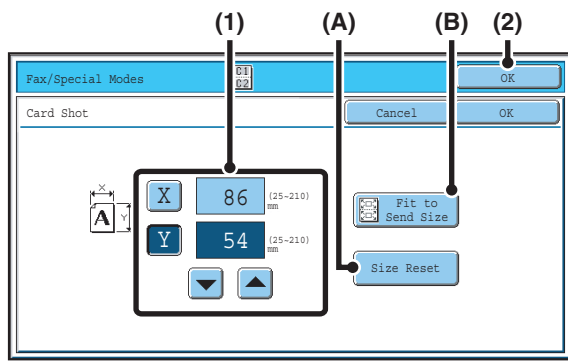

Specify the original size.

(1) Enter the original size.

- Touch the [X] key and enter the horizontal dimension (X) of the original with the keys.
- Touch the [Y] key and enter the vertical dimension (Y) of the original with the keys.

- (A) To return the original size to the default size, touch the [Size Reset] key.
- (B) To automatically enlarge or reduce the image size to the send size, touch the [Fit to Send Size] key. Do not touch this key if you wish to scan the original at the original size that you entered.

(2) Touch the [OK] key.



- The send size is automatically selected based on the original size you entered.
- After selecting Card Shot, you can touch the [Original] key in the base screen to change the original scan size or the send size. In this case, the screen of step 3 appears when you touch the scan size key. For the procedure for setting the send size, see "[Specifying the send size of the original](#)" (page 50).

4

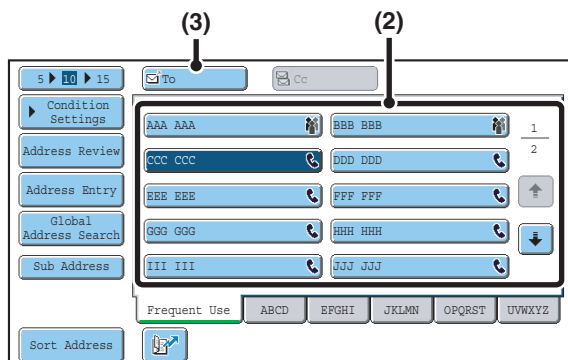

Enter the destination fax number

(1) Touch the [Address Book] key in the base screen.

(2) Touch the one-touch key of the desired destination.

(3) Touch the [To] key.



- In addition to specification by one-touch key, a destination can also be specified using a search number. You can also directly enter a fax number with the numeric keys or look up a destination in a global address book. For more information, see "[2. ENTERING DESTINATIONS](#)" (page 15).

5

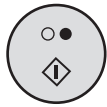

Press the [BLACK & WHITE START] key (○●) to scan the front of the card.



To cancel scanning...

Press the [STOP] key (⊘).

6

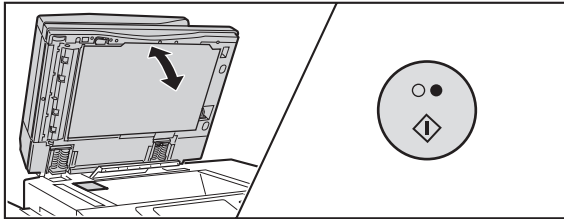

Turn the card over so that the back is face down, and press the [BLACK & WHITE START] key (○●) to scan the back of the card.



Before scanning the back of the card, you can touch the [Configure] key in the touch panel to change the exposure.



To cancel scanning...

Press the [STOP] key (⊘).

7

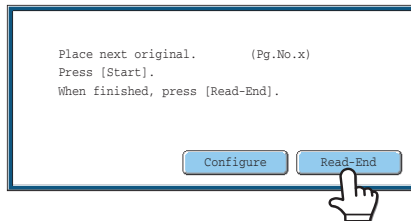

Touch the [Read-End] key.



If you will continue by scanning the front of the card, you can touch the [Configure] key to change the exposure, resolution, scan size, and send size.



- The ratio cannot be specified and "Rotation Sending Setting" cannot be selected.
- This function cannot be used in direct transmission mode or when the speaker is used to dial.



To cancel Card Shot...

Touch the [Cancel] key in the screen of step 3.

SENDING A LARGE NUMBER OF PAGES (Job Build)

This function lets you separate an original consisting of numerous pages into sets, scan each set using the automatic document feeder, and transmit the pages in a single transmission. Use this function when there are more original pages than can be placed at once in the auto document feeder.

When scanning originals that are separated into sets, scan the set that has the first page first. The settings that you select for the first set can be used for all remaining sets.

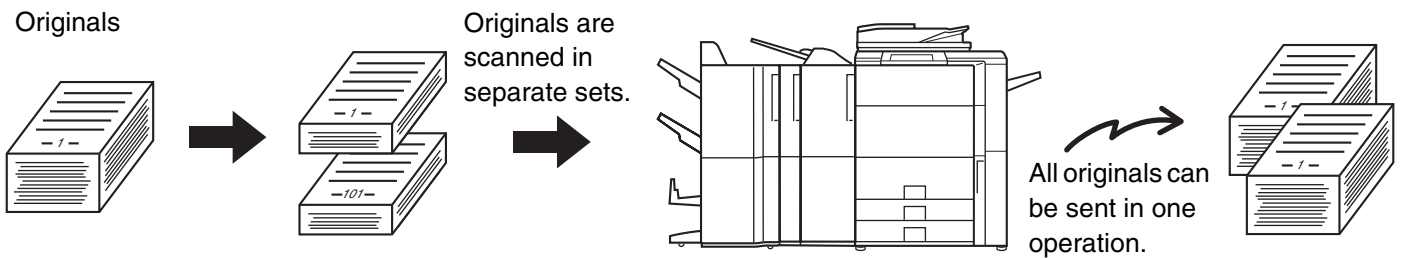

 Up to 999 pages can be scanned. Note that when the memory is being used for other jobs, fewer pages can be scanned.

1

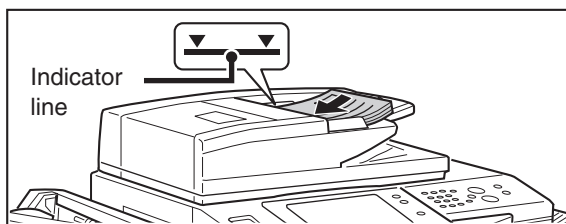

Insert the originals face up in the document feeder tray.

Insert the originals all the way into the document feeder tray. Multiple originals can be placed in the document feeder tray. The stack of originals must not be higher than the indicator line on the tray.

2

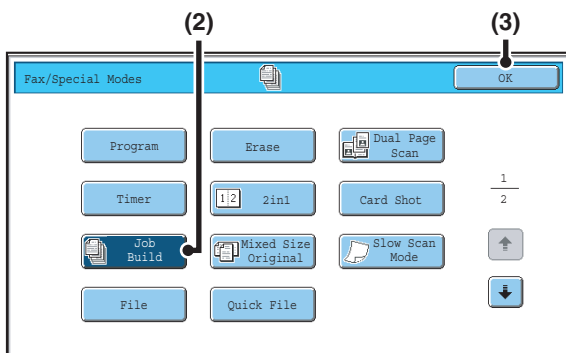

Select job build mode.

- (1) Touch the [Special Modes] key.
 **SPECIAL MODES** (page 60)
- (2) Touch the [Job Build] key so that it is highlighted.
- (3) Touch the [OK] key.

3

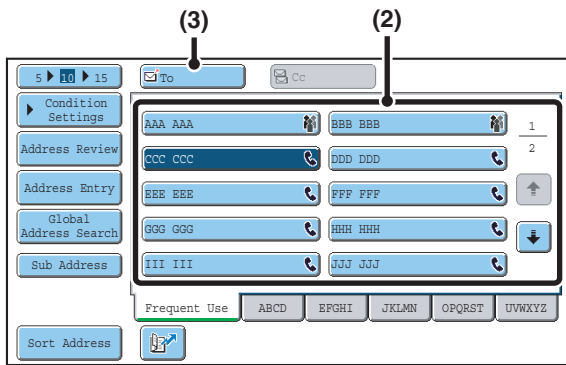

Enter the destination fax number

- (1) Touch the [Address Book] key in the base screen.
- (2) Touch the one-touch key of the desired destination.
- (3) Touch the [To] key.



In addition to specification by one-touch key, a destination can also be specified using a search number. You can also directly enter a fax number with the numeric keys or look up a destination in a global address book. For more information, see "2. ENTERING DESTINATIONS" (page 15).

4



Press the [BLACK & WHITE START] key (○●) to scan the first set.



To cancel scanning...

Press the [STOP] key (⊘).

5

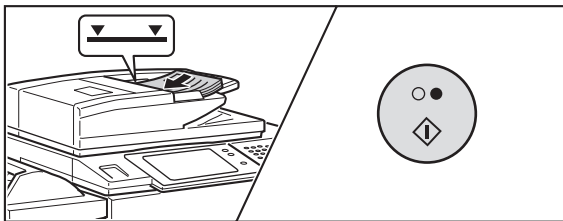

Insert the next set of originals and press the [BLACK & WHITE START] key (○●).

Repeat this step until all originals have been scanned.



To cancel scanning...

Press the [STOP] key (⊘). All scanned data will be cleared.

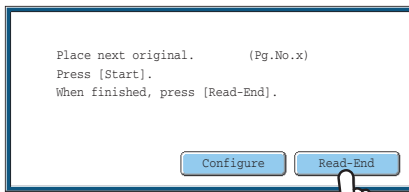

Touch the [Read-End] key.



- If no action is taken for one minute after the confirmation screen appears, scanning automatically ends and the transmission is reserved.
- The [Configure] key can be touched to change the exposure, resolution, scan size, and send size for each original page scanned. However, when Job Build is used in combination with 2in1 in the special modes, only the exposure can be changed when scanning each even-numbered page of the original pages.



- If the memory becomes full during scanning, a message will appear and the transmission will be cancelled.
- This function cannot be used in direct transmission mode or when the speaker is used to dial.



To cancel Job Build....

Touch the [Job Build] key in the screen of step 2 so that it is not highlighted.

TRANSMITTING ORIGINALS OF DIFFERENT SIZES (Mixed Size Original)

This feature lets you scan and transmit originals of different sizes at the same time; for example, B4 (8-1/2" x 14") size originals mixed together with A3 (11" x 17") size originals. When scanning the originals, the machine automatically detects the size of each original.



This feature can only be used with the following combinations of original sizes:

- A3 and B4
- A3 and B5
- B4 and A4
- A4 and B5
- A4R and B5
- B4 and A4R
- B4 and A5
- B5 and A5
- 11" x 17" and 8-1/2" x 14"
- 11" x 17" and 8-1/2" x 13"
- 11" x 17" and 5-1/2" x 8-1/2"

1

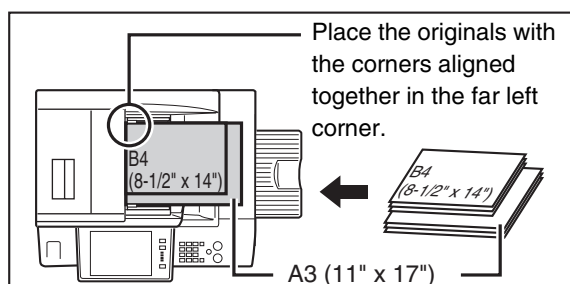

Place the originals with the corners aligned together in the far left corner.

Insert the originals face up in the document feeder tray.

Insert the originals with the corners aligned together in the far left corner of the document feeder tray.

2

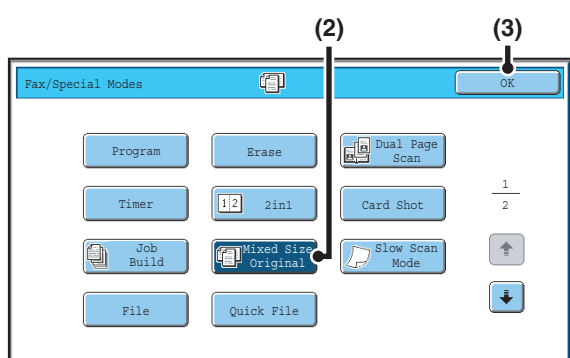

Select the mixed size original setting.

- (1) Touch the [Special Modes] key.
☞ [SPECIAL MODES](#) (page 60)
- (2) Touch the [Mixed Size Original] key so that it is highlighted.
- (3) Touch the [OK] key.



If an original scan size has been specified, a message will appear when the [Mixed Size Original] key is touched. To enable the Mixed Size Original setting, change the scan size setting to auto and then touch the [Mixed Size Original] key again.

3

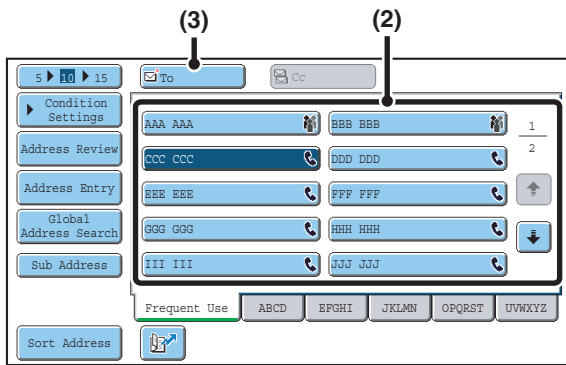

Enter the destination fax number.

- (1) Touch the [Address Book] key in the base screen.
- (2) Touch the one-touch key of the desired destination.
- (3) Touch the [To] key.



In addition to specification by one-touch key, a destination can also be specified using a search number. You can also directly enter a fax number with the numeric keys or look up a destination in a global address book. For more information, see "2. ENTERING DESTINATIONS" (page 15).

4



Press the [BLACK & WHITE START] key (○●).

Scanning begins. A beep will sound to indicate that scanning is finished.



To cancel scanning...

Press the [STOP] key (⊘).



- If an original scan size is specified after selecting the Mixed Size Original setting, the original scan size setting will be enabled and the Mixed Size Original setting will be cleared.
- When the mixed size original setting is selected, rotation sending does not operate.



To cancel the mixed size original setting...

Touch the [Mixed Size Original] key in the screen of step 2 so that it is not highlighted.



System Settings (Administrator): Original Feeding Mode

The original feeding mode can be set to always scan mixed size originals.

FAXING THIN ORIGINALS (Slow Scan Mode)

Use this function when you wish to scan thin originals using the automatic document feeder. This function helps prevent thin originals from misfeeding.

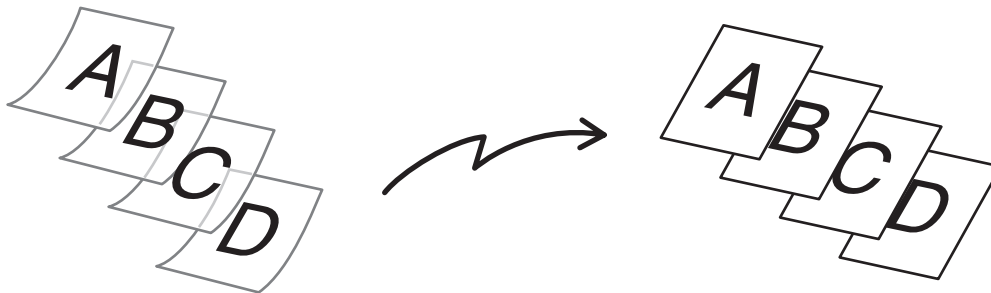

1

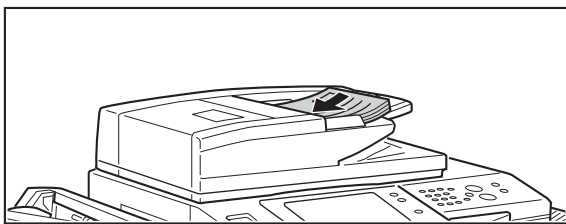

Insert the originals face up in the document feeder tray.

Adjust the document guides slowly.



If the originals are inserted with too much force, they may crumple and misfeed.

2

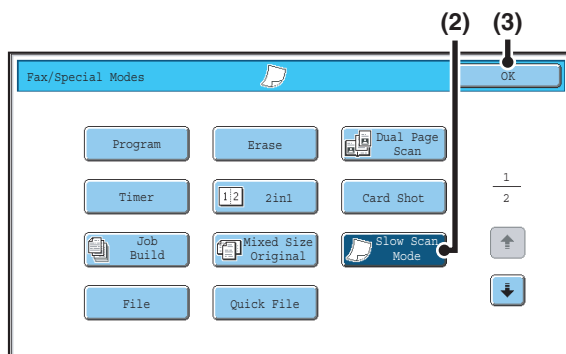

Select slow scan mode.

- (1) Touch the [Special Modes] key.
☞ **SPECIAL MODES** (page 60)
- (2) Touch the [Slow Scan Mode] key so that it is highlighted.
- (3) Touch the [OK] key.

3

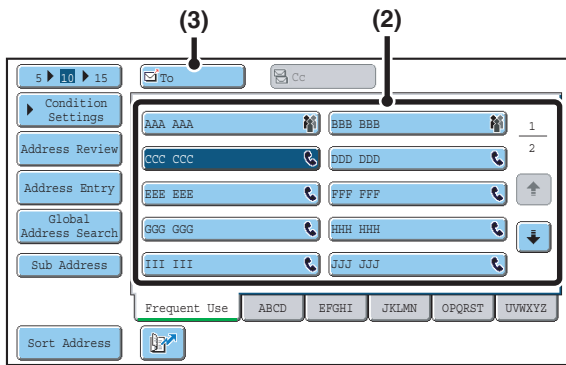

Enter the destination fax number.

- (1) Touch the [Address Book] key in the base screen.
- (2) Touch the one-touch key of the desired destination.
- (3) Touch the [To] key.



In addition to specification by one-touch key, a destination can also be specified using a search number. You can also directly enter a fax number with the numeric keys or look up a destination in a global address book. For more information, see "2. ENTERING DESTINATIONS" (page 15).

4



Press the [BLACK & WHITE START] key (○●).

Scanning begins. A beep will sound to indicate that scanning is finished.



To cancel scanning...
Press the [STOP] key (⊘).



When this function is selected, automatic 2-sided scanning is not possible.



To cancel slow scan mode...
Touch the [Slow Scan Mode] key in the screen of step 2 so that it is not highlighted.



System Settings (Administrator): Original Feeding Mode
This is used to have scanning always take place using slow scan mode.

ADDING YOUR SENDER INFORMATION TO FAXES (Own number sending)

Your sender information (date, time, sender name, sender fax number, number of pages) is automatically added to the top of each fax page you transmit.

Example of the sender information printed

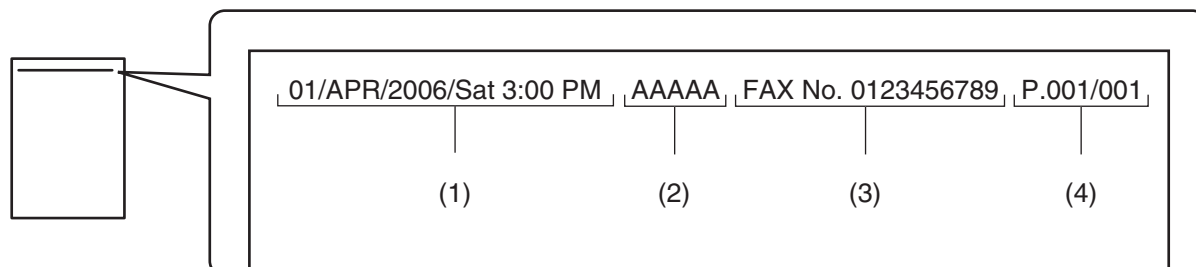

- (1) Date, time: The date and time of transmission.
- (2) Sender name: The sender name programmed in the machine.
- (3) Sender fax number: The sender fax number programmed in the machine.
- (4) Page numbers: Page number / total pages (the total page number is only printed when the fax is sent by memory transmission.)



Information programmed in Own Number Sending

- Date, time: To set or check the date and time, see the System Settings Guide.
- Sender name, sender fax number: Program the sender name and fax number in "Fax Own Name and Number Set" in the system settings (administrator).
- Page numbers: Select whether or not to include page numbers in "Printing Page Number at Receiver" in the system settings (administrator).
Page numbers appear in the format "page number / total pages". Only the page number is printed when manual transmission or quick online transmission is used.



System Settings (Administrator): Date/Own Number Print Position Setting

This is used to set the position where the sender information is printed. The sender information can be printed outside the scanned original image or inside the scanned original image.

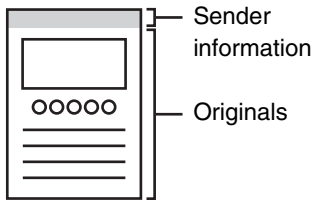
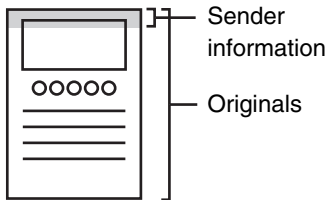

Outside scanned image (factory default setting)	Inside scanned image
 <p>The transmitted image length will be: length of sender information + length of original image. When the fax is printed by the receiving machine, it may be reduced or divided onto two pages.</p>	 <p>The sender information is printed inside the original image, and thus the transmitted image length is the length of the original. Note that the sender information will overlap part of the original image (the overlapped part of the original image will not appear).</p>

TEMPORARILY CHANGING THE SENDER INFORMATION (Own Name Select)

You can select the sender information printed on a transmitted fax from a list of stored senders.

Select the special modes.

1

- (1) Touch the [Special Modes] key.
- (2) Touch the   keys to switch through the screens.
- (3) Touch the [Own Name Select] key.

 [Special modes menu \(2nd screen\)](#) (page 61)

2

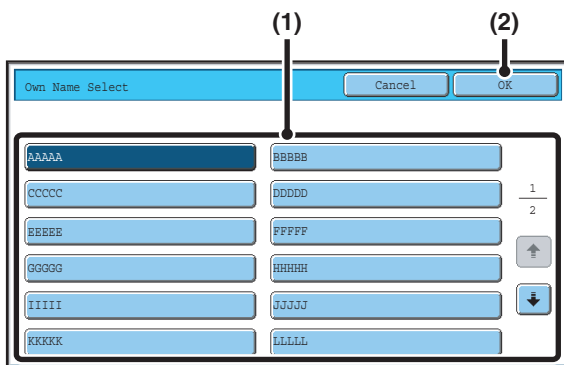

Select the sender information.

- (1) Touch the desired sender information key.
- (2) Touch the [OK] key.

3

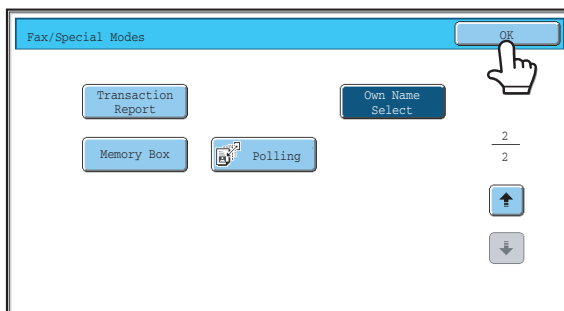

Touch the [OK] key.



System Settings (Administrator): Registration of Own Name Select

This is used to store sender information for Own Name Select.

CALLING A FAX MACHINE AND INITIATING RECEPTION (Polling)

The Polling function allows the receiving machine to call the transmitting machine and initiate reception of a document in that machine.

Because the receiving machine initiates reception of a document, this is called "Polling Reception".

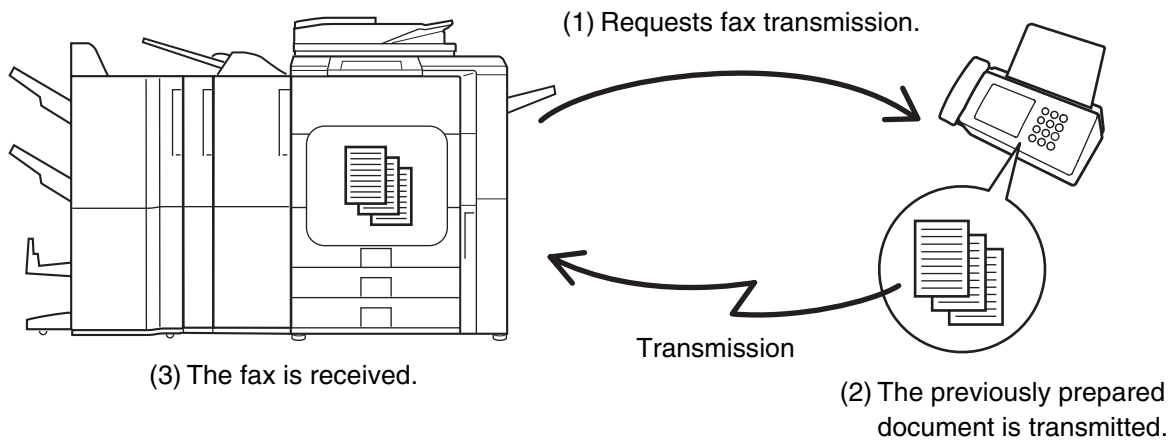

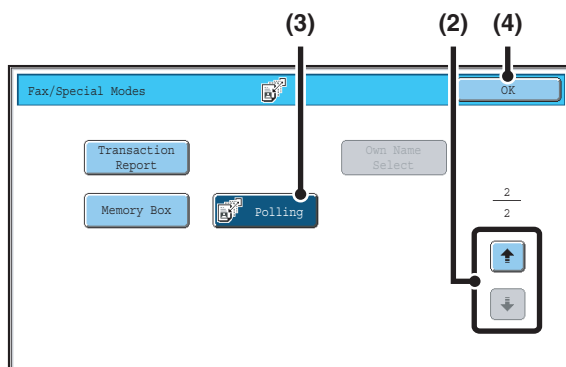

Make sure that an original is not placed in the machine when using the polling reception function.

1



Select polling reception.

- (1) Touch the [Special Modes] key.
☞ [SPECIAL MODES](#) (page 60)
- (2) Touch the   keys to switch through the screens.
- (3) Touch the [Polling] key so that it is highlighted.
- (4) Touch the [OK] key.

2

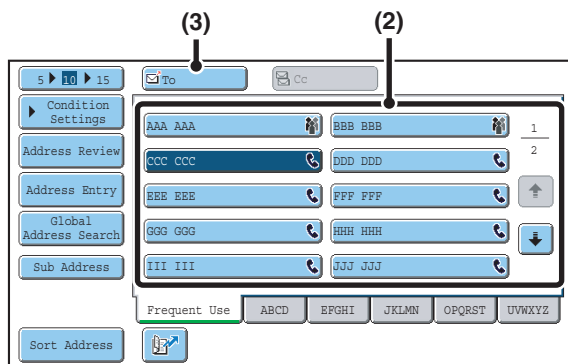

Enter the destination fax number.

- (1) Touch the [Address Book] key in the base screen.
- (2) Touch the one-touch key of the desired destination.
- (3) Touch the [To] key.

If you wish to enter multiple fax numbers, repeat steps (2) and (3) above to enter each number.



- In addition to specification by one-touch key, a destination can also be specified using a search number. You can also directly enter a fax number with the numeric keys or look up a destination in a global address book. For more information, see "2. ENTERING DESTINATIONS" (page 15).
- Multiple fax numbers can be entered.**
Polling will take place in the order that the numbers were entered.
Polling multiple machines is called "Serial Polling".
Up to 500 fax numbers can be entered. In this procedure, one-touch keys that have a sub-address and passcode cannot be used.
- To enter multiple fax numbers, touch the [Next Address] key after entering a fax number and enter the next fax number.

3



Press the [BLACK & WHITE START] key (○●).

Your machine will call the other machine and initiate reception of the fax.



- Polling reception can be used in combination with the timer function to poll at any specified time, such as at night or when you are not present.
- This function can only be used when the other machine is Super G3 or G3 compatible and has a polling function.
- The receiving machine bears the expense (phone charges) of the polling reception.



To cancel polling reception...

Touch the [Polling] key in the screen of step 1 so that it is not highlighted.

INITIATING POLLING RECEPTION MANUALLY

Use this procedure when you must start polling after listening to a recorded greeting, such as when using a fax information service.



- Make sure that an original is not placed in the machine when using the polling reception function.
- This function cannot be used to poll multiple machines (serial polling).

1

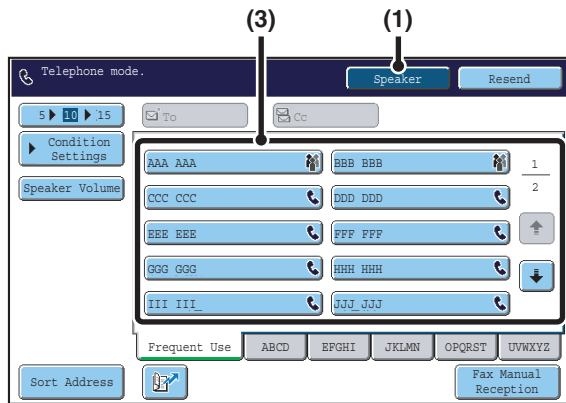

Enter the destination fax number.

- (1) Touch the [Speaker] key.
You will hear the dial tone through the machine's speaker.
- (2) Touch the [Address Book] key in the base screen.
- (3) Touch the one-touch key of the desired destination.
A group key cannot be used.



- In addition to specification by one-touch key, a destination can also be specified using a search number. You can also directly enter a fax number with the numeric keys or look up a destination in a global address book. For more information, see "2. ENTERING DESTINATIONS" (page 15).
- After touching the [Speaker] key, you can touch the [Speaker Volume] key to adjust the volume of the speaker. The speaker volume changes each time the [Speaker Volume] key is touched. Adjust the volume to the desired level.

2



Follow the instructions in the recorded greeting.

3

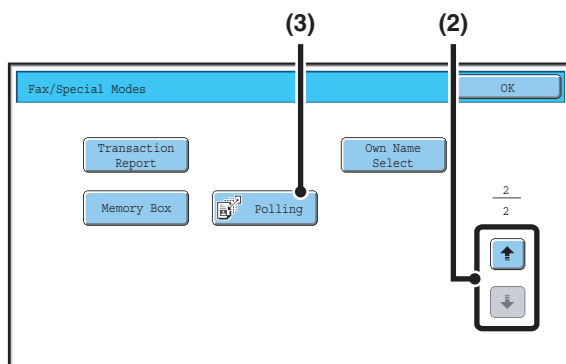

Receive the fax.

- (1) Touch the [Special Modes] key.
➡ SPECIAL MODES (page 60)
- (2) Touch the [Down] [Up] keys to switch through the screens.
- (3) When you hear the fax tone, touch the [Polling] key.
The fax is received.



- This function can only be used when the other machine is Super G3 or G3 compatible and has a polling function.
- The receiving machine bears the expense (phone charges) of the polling reception.

SENDING A FAX WHEN ANOTHER MACHINE POLLS YOUR MACHINE (Polling Memory)

Sending a document that has been scanned into memory when another machine polls your machine is called "Polling Memory".

Prior to polling, the document that will be faxed to the other machine must be scanned into a polling memory box. This function can only be used when the other machine is Super G3 or G3 compatible and has a polling function.

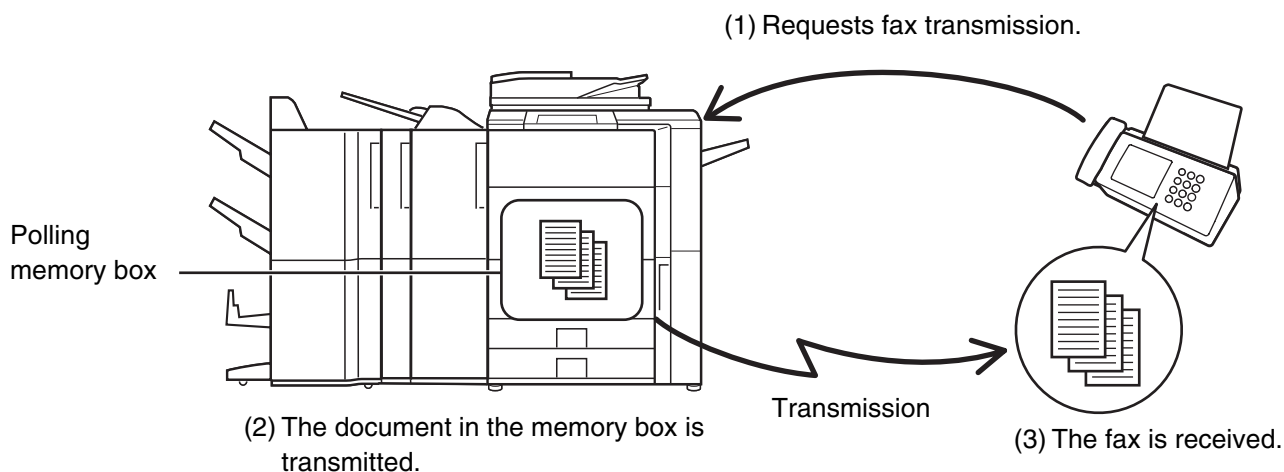

RESTRICTING POLLING ACCESS (Polling security)

To only allow specified machines to poll your machine, you can restrict polling to machines whose programmed sender fax number matches a fax number stored in your machine as a polling passcode number. This is called "Polling Security".

To use this function, first store polling passcode numbers (the sender fax numbers programmed in the other machines) in the machine's system settings, and then enable polling security.



Up to 10 fax numbers can be stored as polling passcode numbers.



System Settings (Administrator): Fax Polling Security

This is used to enable polling security. This is used to store fax numbers as polling passcode numbers.

SCANNING A DOCUMENT INTO POLLING MEMORY

Follow these steps to scan a document into the memory box for polling transmission (Public Box).

1 Place the original.

Place the original face up in the document feeder tray, or face down on the document glass.

2 Select the special modes.

(1) Touch the [Special Modes] key.

2 (2) Touch the   keys to switch through the screens.

(3) Touch the [Memory Box] key.

 [Special modes menu \(2nd screen\)](#) (page 61)

3

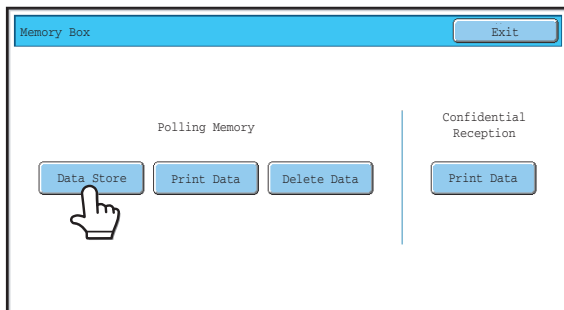

Touch the [Data Store] key.

4

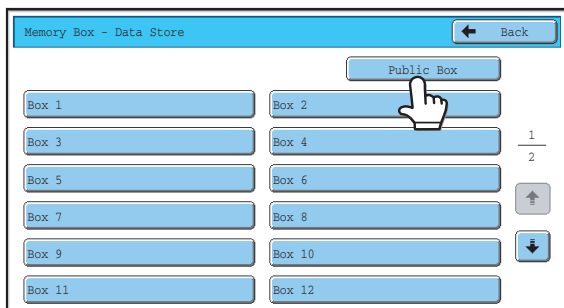

Touch the [Public Box] key.

5

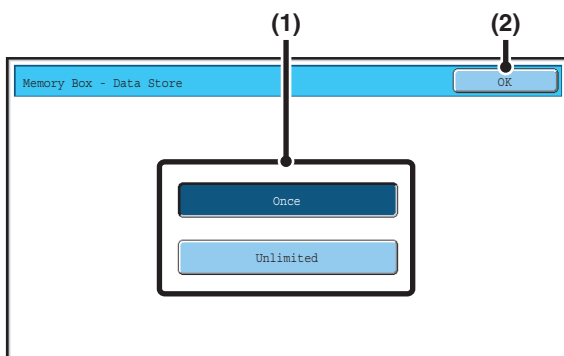

Specify the number of polling times.

(1) Touch the key for the desired number of times.

Touch the [Once] key if you want the document cleared from memory after it is transmitted. Touch the [Unlimited] key to allow polling an unlimited number of times.

(2) Touch the [OK] key.

6

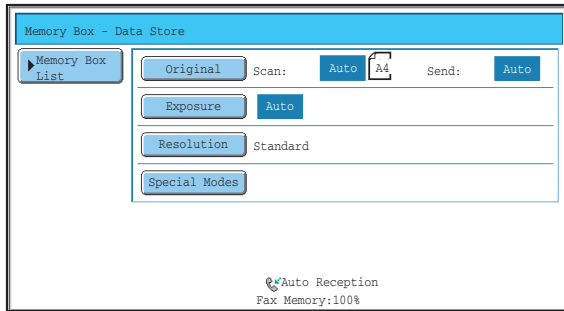

Select image settings and special modes.



- The following functions can be selected:
Erase, Dual Page Scan, 2in1, Card Shot, Job Build, Mixed Size Original, Slow Scan Mode, Own Name Select.
- To return to the screen of step 4, touch the [Memory Box List] key.

7



Press the [BLACK & WHITE START] key (○●).

Scanning begins.

- If you inserted the original pages in the document feeder tray, all pages are scanned.
- If you are scanning the original on the document glass, scan each page one page at a time.
When scanning finishes, place the next original and press the [BLACK & WHITE START] key (○●). Repeat until all pages have been scanned and then touch the [Read-End] key.



To cancel scanning...

Press the [STOP] key (⊘) while the original is being scanned.





If another document remains in the memory box (Public Box), the newly scanned document is added to the previous document. In this case, the number of polling times will be the number set for the newly scanned document.

PRINTING A DOCUMENT STORED IN THE PUBLIC BOX

To check a document stored in the Public Box for polling transmission, follow the steps below to print the document.

1 **Select the special modes.**

- (1) Touch the [Special Modes] key.
- (2) Touch the   keys to switch through the screens.
- (3) Touch the [Memory Box] key.

 [Special modes menu \(2nd screen\)](#) (page 61)

2 **Touch the [Print Data] key.**

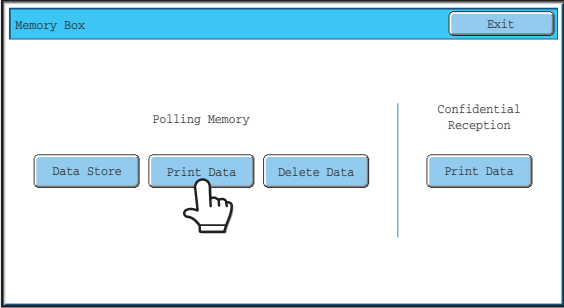

3 **Touch the [Public Box] key.**

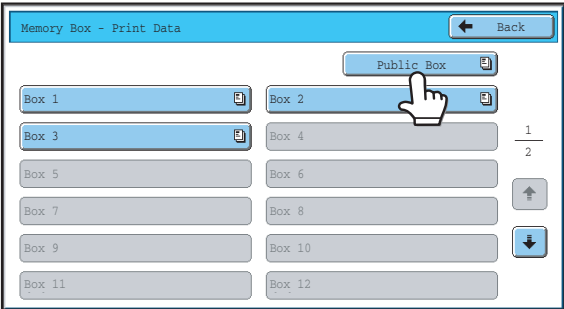

 When nothing is stored in the Public Box, the [Public Box] key will be greyed out.

4 **Press the [BLACK & WHITE START] key (○●).**

The stored document is printed.





 **To cancel printing...**
Touch the [Cancel] key in the touch panel.

DELETING A DOCUMENT FROM THE PUBLIC BOX

Delete a document from the Public Box when it is no longer needed.

1 Select the special modes.

- (1) Touch the [Special Modes] key.
- (2) Touch the   keys to switch through the screens.
- (3) Touch the [Memory Box] key.
 [Special modes menu \(2nd screen\)](#) (page 61)

2

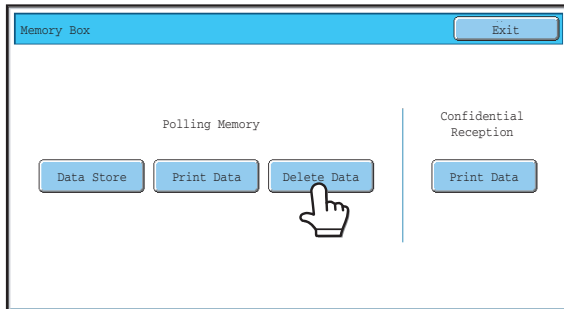

Touch the [Delete Data] key.

3

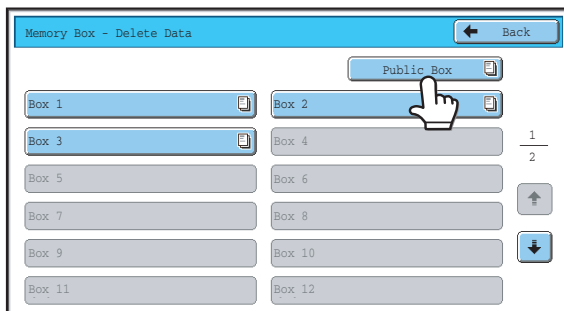

Touch the [Public Box] key.



When nothing is stored in the Public Box, the [Public Box] key will be greyed out.

4

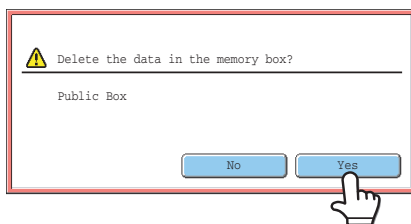

Touch the [Yes] key.

The document is deleted and you return to the screen of step 3.



To cancel the deletion...

Touch the [No] key. You will return to the screen of step 3.

6

PERFORMING F-CODE COMMUNICATION

This chapter explains how to perform F-code communication operations. F-code communication is possible with machines of other manufacturers that also support F-code communication.

F-CODE COMMUNICATION

Exchange of confidential documents (confidential communication), retrieval (polling) and distribution (polling memory) of information, distribution of information to multiple destinations (relay broadcast transmission) are possible with other machines that support F-code communication.

An F-code* is specified in each communication, enabling a higher level of security.

* F-code is a communication function based on the G3 standard of the ITU-T.

 The ITU-T is a United Nations organization that establishes communications standards. It is a department of the International Telecommunication Union (ITU), which coordinates global telecommunications networks and services.

HOW F-CODES WORK

A fax that is transmitted with an F-code is received to the memory box in the receiving machine specified by the F-code (sub-address and passcode). If the F-code sent by the transmitting machine does not match the F-code in the receiving machine, reception will not take place.

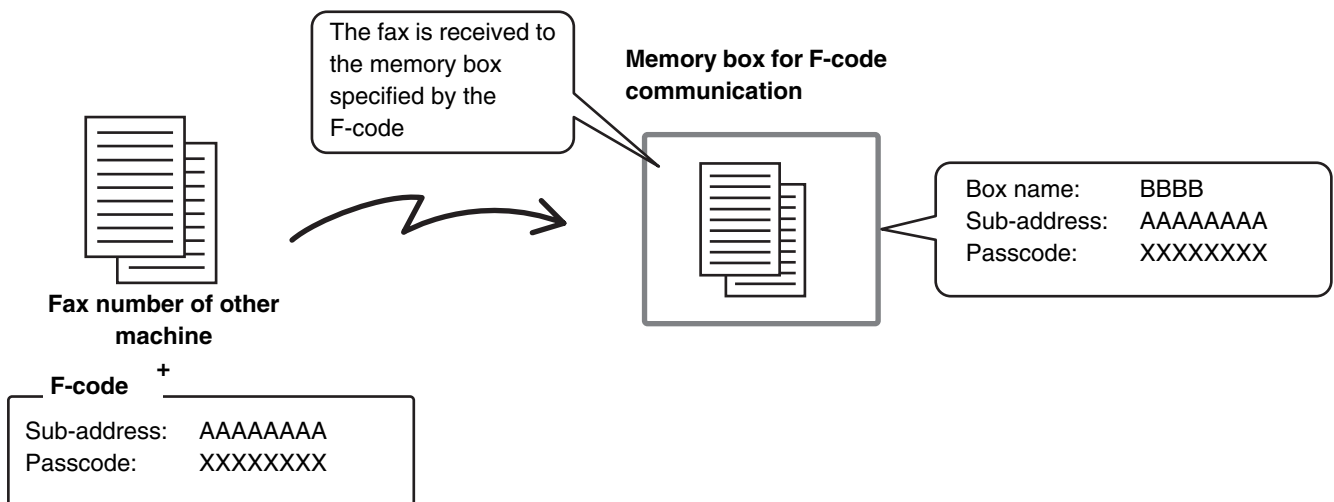

The products of other manufacturers may use different terms for "sub-address" and "passcode". If you need to contact the operator of another machine regarding sub-addresses and passcodes, refer to the terms used by the ITU-T in the table below.

The machine	ITU-T		
	F-code polling memory box	F-code confidential box	F-code relay broadcast memory box
Sub Address	SEP	SUB	SUB
Passcode	PWD	SID	SID

 An F-code consists of a sub-address and passcode, and cannot be longer than 20 digits.

CREATING MEMORY BOXES IN THE MACHINE FOR F-CODE COMMUNICATION

Before the F-code communication function can be used, special memory boxes must be created using "F-Code Memory Box" in the system settings.

A box name and F-code (sub-address and passcode) are programmed in each box, and an F-code communication function is assigned to each box.

After you have created a memory box, inform the other party of the sub-address and passcode of the box.

Memory box for F-code communication



- Box Name
- Sub Address
- Passcode
- End receiving machines (only in an F-code relay broadcast memory box)
- Print PIN (only for F-code confidential reception)

To use the following F-code communication functions, F-code memory boxes must be created in your machine.

F-code confidential reception, F-code polling memory, F-code relay broadcast transmission

To use the following F-code communication functions, F-code memory boxes must be created in the other machine.

F-code confidential transmission, F-code polling reception, F-code relay request transmission



System Settings: F-Code Memory Box

This is used to configure memory boxes for F-code communication.

- Up to 100 memory boxes can be created.
- The memory box name cannot be longer than 18 characters, and the sub-address and passcode cannot be longer than 20 digits.

F-CODE DIALLING

When performing an F-code operation, the F-code (sub-address and passcode) is appended to the fax number that is dialled. Check the F-code (sub-address and passcode) programmed in the memory box in the other machine before you perform an F-code transmission. It is convenient to store an F-code together with the fax number in a one-touch key or group key.

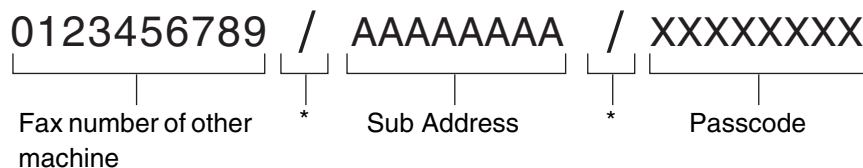

* Touch the [Sub Address] key in the screen to enter "/>.

When the following F-code functions are used, your machine dials the other machine.

F-code confidential transmission, F-code polling reception, F-code relay request transmission

When the following F-code functions are used, the other machine dials your machine.

F-code confidential reception, F-code polling memory, F-code relay broadcast transmission



- If the destination machine does not have a passcode configured in the F-code, do not enter a passcode when dialling that machine.
- F-code communication cannot be performed when using the speaker or performing manual transmission.



System Settings: Address Book

This is used to store and edit one-touch keys and group keys.

CONFIDENTIAL COMMUNICATION USING F-CODES

By sending a fax to an F-code memory box (confidential) in the receiving machine (your machine or the other machine), the sender can direct the transmission specifically to the user of the box.

This is convenient for sending sensitive documents that you do not wish people other than the recipient to see, or when the receiving machine is shared by multiple departments.

To print an F-code confidential fax, the print passcode must be entered.

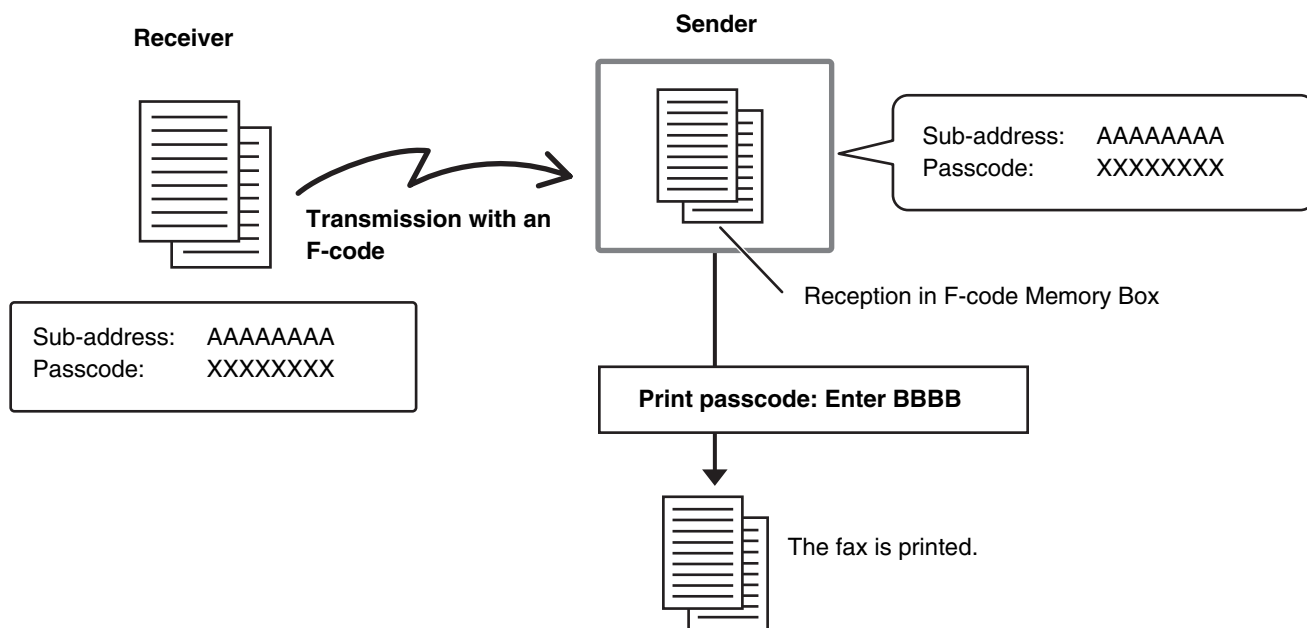

 The F-code (sub-address and passcode) of the memory box to be used should be verified by the sender and the recipient before the fax is sent.

 **System Settings: F-Code Memory Box**
This is used to create memory boxes for F-code confidential communication (confidential reception). A memory box name, sub-address, passcode, and print passcode are programmed in each box.

F-CODE CONFIDENTIAL TRANSMISSION

Follow the steps below to send a confidential fax by adding an F-code to the fax number.

1

Place the original.

Place the original face up in the document feeder tray, or face down on the document glass.

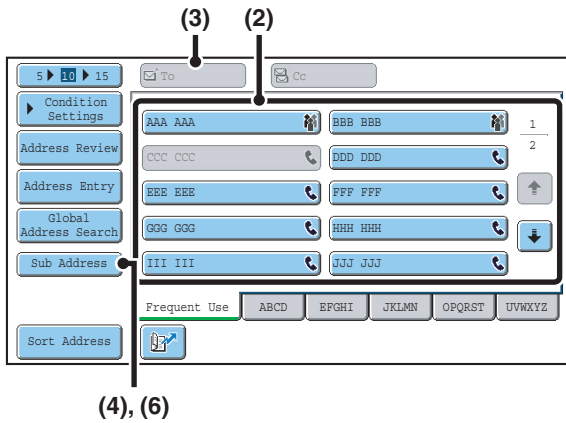

2

Enter the destination fax number.

(1) Touch the [Address Book] key in the base screen.

(2) Touch the one-touch key of the desired destination.

If the destination is not stored in the address book, enter the fax number with the numeric keys.

(3) Touch the [To] key.

If you entered the fax number with the numeric keys, this is not necessary.

If the sub-address and passcode are stored in the one-touch key, the following sub-steps are not necessary. Go to step 3.

(4) Touch the [Sub Address] key.

"/" appears.

(5) Enter the sub-address with the numeric keys.

(6) Touch the [Sub Address] key.

"/" appears.

(7) Enter the passcode with the numeric keys.



If a passcode has been omitted in the memory box of the other machine, (6) and (7) are not necessary.

3



Press the [BLACK & WHITE START] key (○●).

Scanning begins.

- If you inserted the original pages in the document feeder tray, all pages are scanned.

A beep will sound to indicate that scanning is finished.

If you are scanning the original on the document glass, scan each page one page at a time.

When scanning finishes, place the next original and press the [BLACK & WHITE START] key (○●). Repeat until all pages have been scanned and then touch the [Read-End] key.

A beep will sound to indicate that scanning is finished.



This function can be used in combination with a broadcast transmission or timer transmission. This function can also be stored in a program.

PRINTING A FAX RECEIVED BY F-CODE CONFIDENTIAL RECEPTION

When an F-code confidential fax is sent to your machine, the fax is received to the memory box specified by the F-code. To print the received fax, enter the print passcode.

1



The machine rings and the fax is received.

A beep sounds when reception ends.

2

Select the special modes.

(1) Touch the [Special Modes] key.

(2) Touch the   keys to switch through the screens.

(3) Touch the [Memory Box] key.

 [Special modes menu \(2nd screen\)](#) (page 61)

3

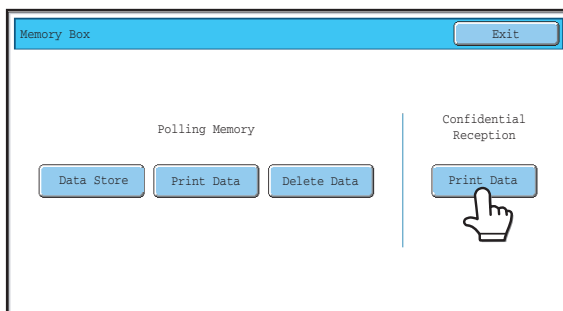

Touch the [Print Data] key.

4

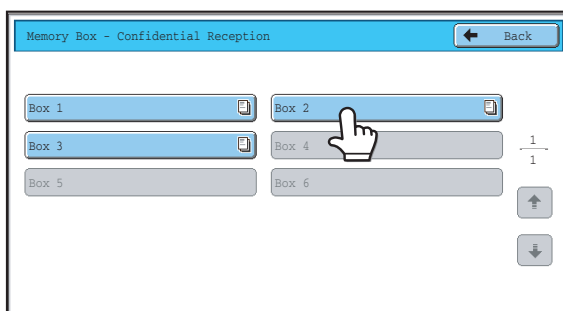

Touch the key of the memory box containing the confidential fax.

"" appears in the keys of memory boxes that have received faxes. The keys of memory boxes that have not received faxes are greyed out and cannot be selected.

5

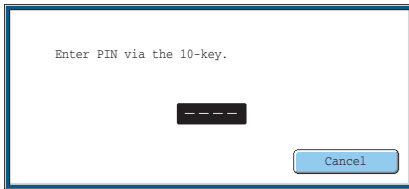

Enter the print passcode with the numeric keys.

As each digit is entered, "-" changes to "*".



Take care to enter the correct print passcode. If you make a mistake, a message will appear and you will return to the entry screen. You can touch the [Cancel] key to return to step 4.

6



Press the [BLACK & WHITE START] key (○●).



- The confidential fax is automatically given priority in the print job queue.
- The fax is automatically cleared from the memory box after printing.

• If you forget the print passcode...

There is no way to check a forgotten passcode on the machine. Take care not to forget the passcode. In the event that you forget the passcode or need to verify the passcode, contact your dealer or nearest authorised service representative.



System Settings (Administrator): Transaction Report Print Select Setting

This setting can be used to have a transaction report printed automatically when an F-code confidential fax is received.

POLLING RECEPTION USING F-CODES

This function enables your machine to call another machine and initiate reception of a fax stored in an F-code memory box (polling memory) in the other machine. During the polling operation, your machine must correctly specify the F-code (sub-address and passcode) configured in the other machine or polling reception will not take place.

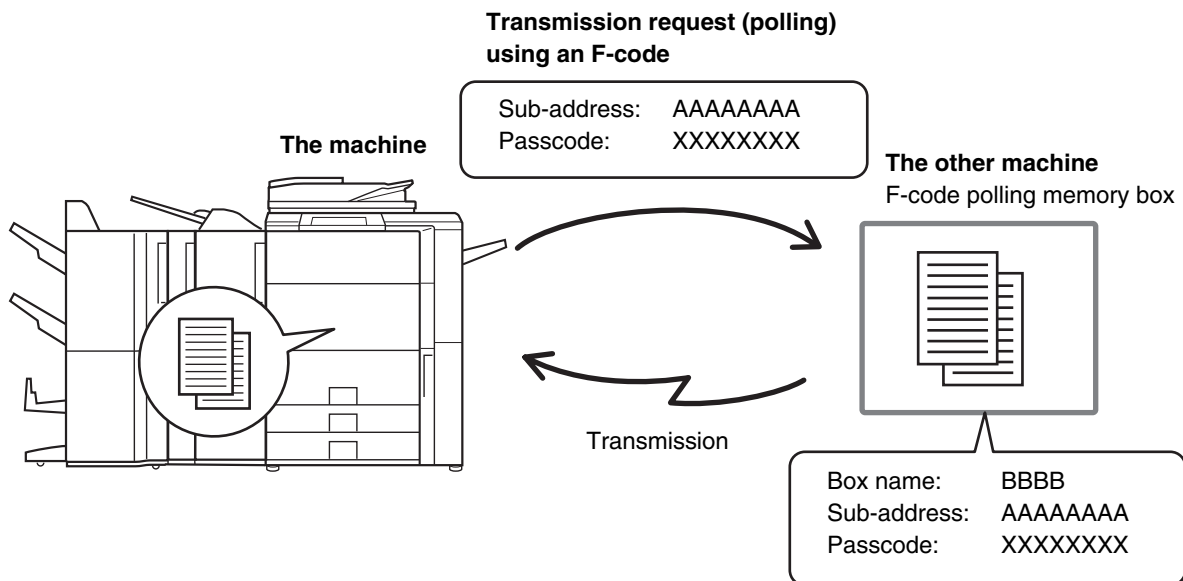

- Verify the F-code (sub-address and passcode) of the memory box in the other machine before you perform F-code polling reception.
- Do not place an original in the automatic document feeder or on the document glass when using this function.
- The receiving machine bears the phone charges of the transmission.

1

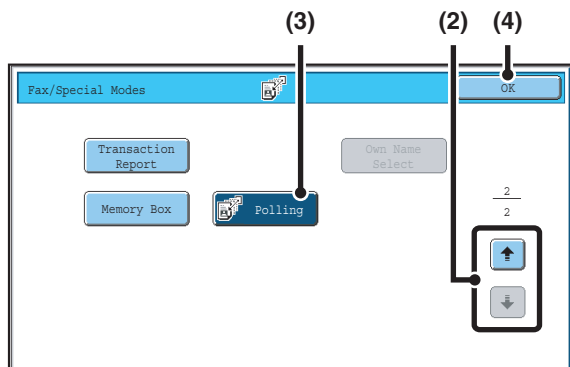

Select polling.

- (1) Touch the [Special Modes] key.
☞ [SPECIAL MODES](#) (page 60)
- (2) Touch the keys to switch through the screens.
- (3) Touch the [Polling] key so that it is highlight.
- (4) Touch the [OK] key.

2

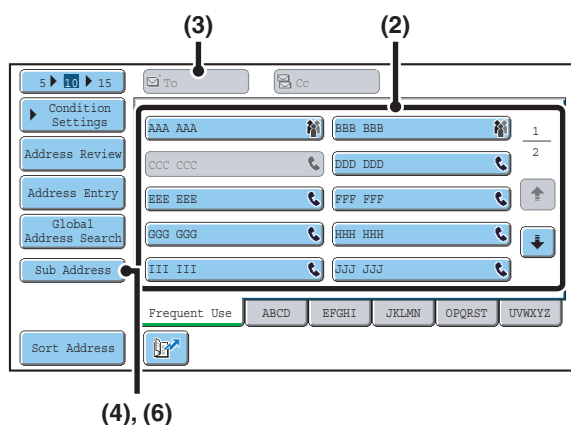

Enter the destination fax number.

(1) Touch the [Address Book] key in the base screen.

(2) Touch the one-touch key of the desired destination.

If the destination is not stored in the address book, enter the fax number with the numeric keys.

(3) Touch the [To] key.

If you entered the fax number with the numeric keys, this is not necessary.

If the sub-address and passcode are stored in the one-touch key, the following sub-steps are not necessary. Go to step 3.

(4) Touch the [Sub Address] key.

"/" appears.

(5) Enter the sub-address with the numeric keys.

(6) Touch the [Sub Address] key.

"/" appears.

(7) Enter the passcode with the numeric keys.



If a passcode has been omitted in the memory box of the other machine, (6) and (7) are not necessary.

3



Press the [BLACK & WHITE START] key (○●).

Your machine will call the other machine and initiate reception of the fax.



- Polling multiple machines (serial polling) is not possible.
 - F-code polling reception can be used in combination with a timer setting. Only one polling reception operation with a timer setting can be stored at a time.
- 🔗 [SENDING A FAX AT A SPECIFIED TIME \(Timer\)](#) (page 70)



To cancel polling...

Touch the [Polling] key in the screen of step 1 so that it is not highlighted.

POLLING MEMORY TRANSMISSION USING F-CODES

When your machine receives a transmission request from another machine, this function sends a fax stored in an F-code memory box (polling memory) in your machine to that machine. The other machine must correctly specify the F-code configured in your machine or transmission will not take place.

The document to be transmitted must be scanned into an F-code polling memory box.

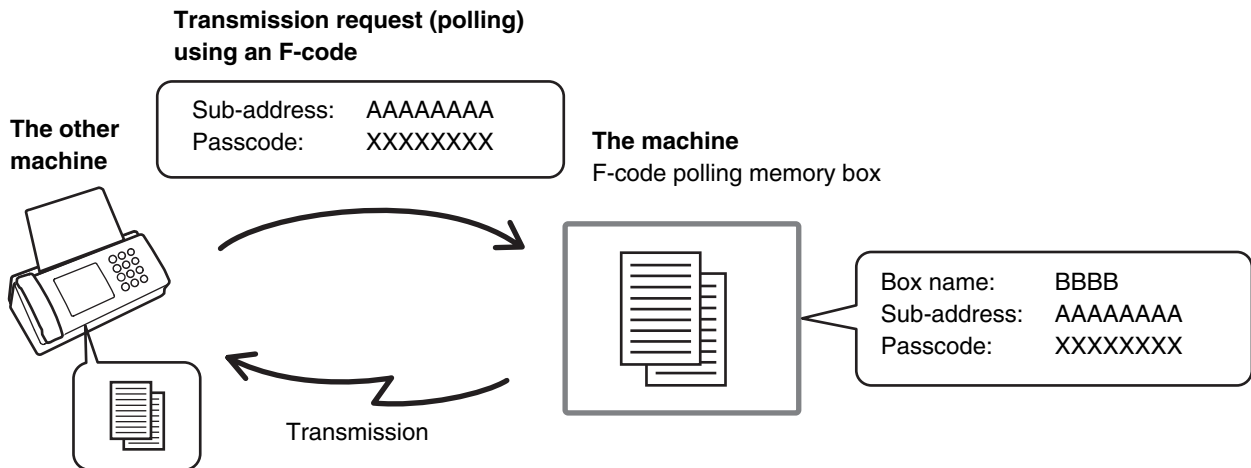

System Settings: F-Code Memory Box

This is used to create memory boxes (polling memory) for F-code polling memory transmission. A memory box name, sub-address, and passcode are programmed in each box.

SCANNING A DOCUMENT INTO A MEMORY BOX FOR F-CODE POLLING TRANSMISSION

Follow these steps to scan a document into a memory box (polling memory) for F-code polling transmission.

1

Place the original.

Place the original face up in the document feeder tray, or face down on the document glass.

2

Select the special modes.

(1) Touch the [Special Modes] key.

(2) Touch the   keys to switch through the screens.

(3) Touch the [Memory Box] key.

 [Special modes menu \(2nd screen\)](#) (page 61)

3

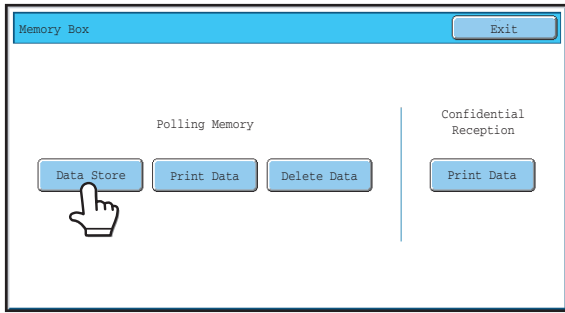

Touch the [Data Store] key.

4

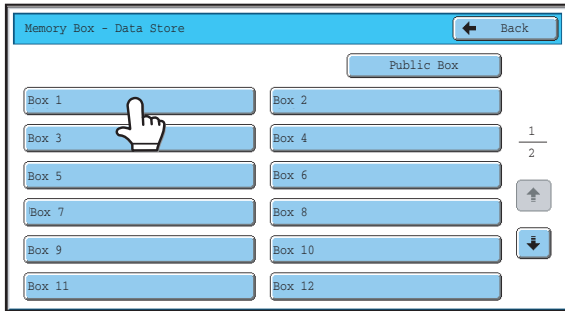

Touch the key of the F-code memory polling box.

5

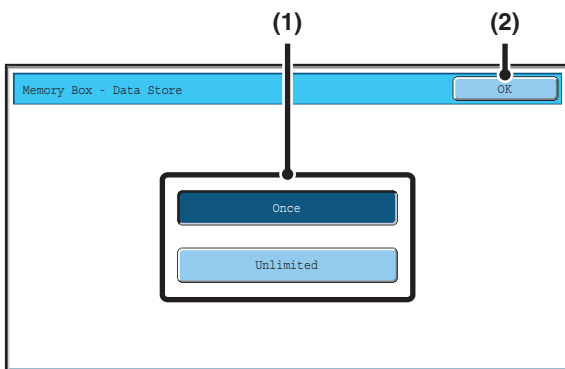

Specify the number of polling times.

(1) Touch the key for the desired number of times.

Touch the [Once] key if you want the document cleared from memory after it is transmitted. Touch the [Unlimited] key to allow polling an unlimited number of times.

(2) Touch the [OK] key.

6

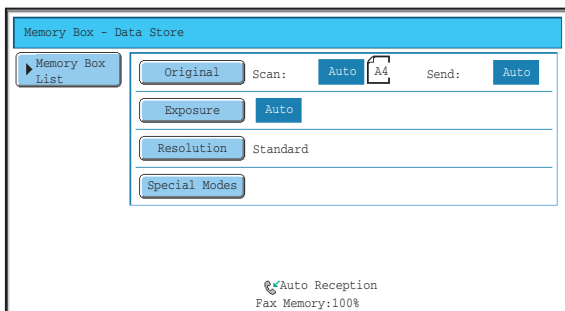

Select image settings and special modes.



- A program, timer setting, transaction report, polling, and document filing cannot be selected.
- To return to the screen of step 4, touch the [Memory Box List] key.



Press the [BLACK & WHITE START] key (○●).

Scanning begins.

- If you inserted the original pages in the document feeder tray, all pages are scanned.
- If you are scanning the original on the document glass, scan each page one page at a time.

When scanning finishes, place the next original and press the [BLACK & WHITE START] key (○●). Repeat until all pages have been scanned and then touch the [Read-End] key.



To cancel scanning...

Press the [STOP] key (⊞) while the original is being scanned.



- If other documents have already been stored in the memory box, the document is added to the previously stored documents.
- The factory default setting for the number of polling times is "Once" (after the document is transmitted to the receiving machine, it is automatically cleared).

PRINTING A DOCUMENT STORED FOR F-CODE POLLING TRANSMISSION



You can check a document in an F-code memory polling box by printing it out.



A document in a memory box cannot be printed while the document is being transmitted.

Select the special modes.

1

- (1) Touch the [Special Modes] key.
- (2) Touch the   keys to switch through the screens.
- (3) Touch the [Memory Box] key.

 [Special modes menu \(2nd screen\)](#) (page 61)

2

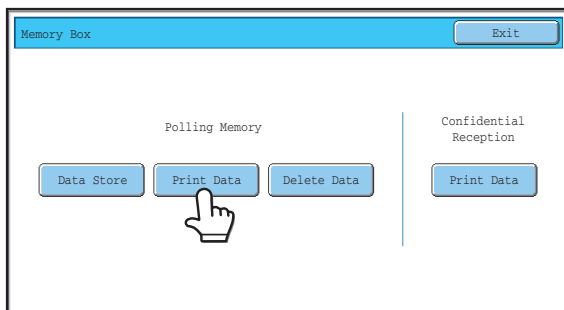

Touch the [Print Data] key.

3

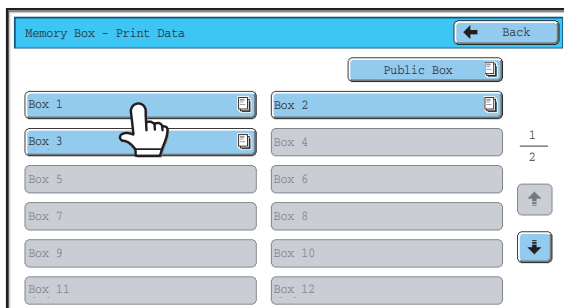

Touch the key of the F-code memory polling box where the document you wish to print is stored.

 appears in keys that have documents stored.

4



Press the [BLACK & WHITE START] key (○●).

The document in the selected memory box is printed.



To cancel printing...
Touch the [Cancel] key.

DELETING A DOCUMENT STORED FOR F-CODE POLLING TRANSMISSION

When a document in an F-code memory polling box is no longer needed, follow the steps below to delete it.



A document in a memory box cannot be deleted while the document is being transmitted.

Select the special modes.

1

- (1) Touch the [Special Modes] key.
 - (2) Touch the keys to switch through the screens.
 - (3) Touch the [Memory Box] key.
- [Special modes menu \(2nd screen\)](#) (page 61)

2

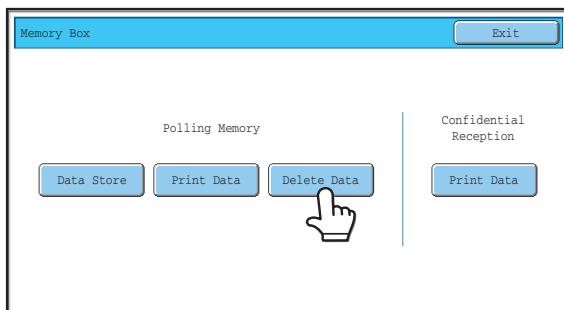

Touch the [Delete Data] key.

3

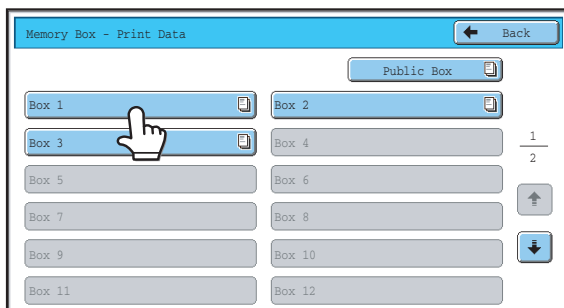

Touch the key of the F-code memory polling box that has the document you wish to delete.

appears in keys that have documents stored.

4

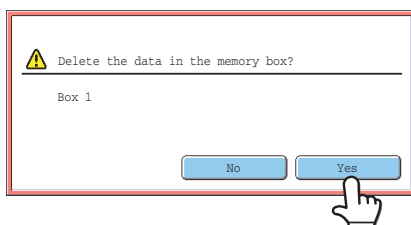

Touch the [Yes] key.

The document in the selected memory box is deleted and you return to the screen of step 3.



To cancel the deletion...

Touch the [No] key. You will return to the screen of step 3 without deleting the document.

RELAY REQUEST TRANSMISSION USING F-CODES

This function is used to send a fax to an F-code relay broadcast memory box in another machine and have that machine relay the fax to multiple end receiving machines.

When the end receiving machines are far from your machine, sending the fax to a relay machine that is close to the end receiving machines can help reduce phone charges. A relay request transmission can be used in combination with the timer transmission function to further reduce phone costs.

 [SENDING A FAX AT A SPECIFIED TIME \(Timer\)](#) (page 70)

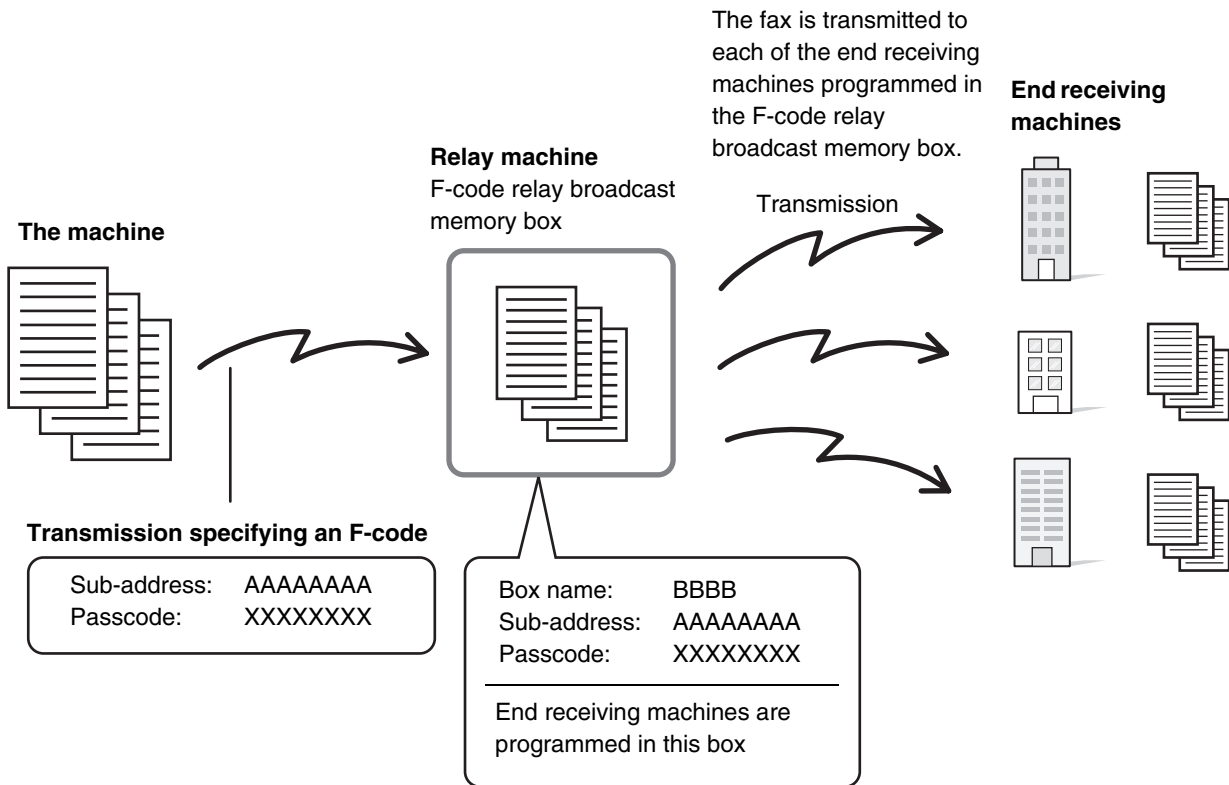

- Verify the F-code (sub-address and passcode) and end receiving machines programmed in the relay broadcast memory box in the relay machine before you perform an F-code relay request transmission.
- Before this function can be used, the end receiving machines must be programmed in the F-code relay broadcast memory box in the relay machine.
- The end receiving machines do not need to support F-code communication.
- This function can be used in combination with a broadcast transmission or timer transmission. An F-code relay request transmission can also be stored in a program.
- Your machine (the machine that requests a relay broadcast transmission) only bears the cost of sending the fax to the relay machine. The relay machine bears the cost of sending the fax to each of the end receiving machines.



System Settings: F-Code Memory Box

This is used to create memory boxes for F-code relay broadcast transmission.

A memory box name, sub-address, passcode, and end receiving machines are programmed in each box.

1

Place the original.

Place the original face up in the document feeder tray, or face down on the document glass.

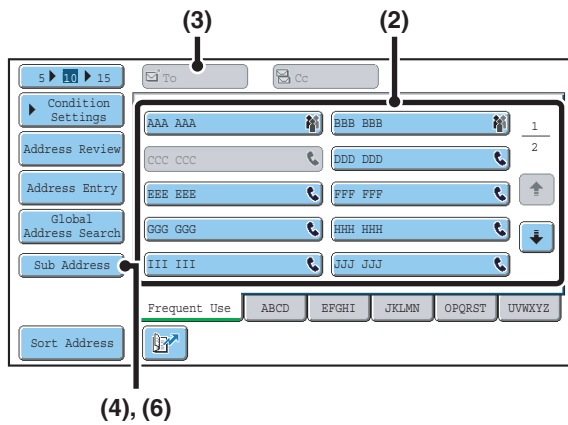

Enter the destination fax number.

(1) Touch the [Address Book] key in the base screen.

(2) Touch the one-touch key of the desired destination.

If the destination is not stored in the address book, enter the fax number with the numeric keys.

(3) Touch the [To] key.

If you entered the fax number with the numeric keys, this is not necessary.

If the sub-address and passcode are stored in the one-touch key, the following sub-steps are not necessary. Go to step 3.

(4) Touch the [Sub Address] key.

"/" appears.

(5) Enter the sub-address with the numeric keys.

(6) Touch the [Sub Address] key.

"/" appears.

(7) Enter the passcode with the numeric keys.



If a passcode has been omitted in the memory box of the other machine, (6) and (7) are not necessary.



Press the [BLACK & WHITE START] key (○●).

Scanning begins.

- If you inserted the original pages in the document feeder tray, all pages are scanned. A beep will sound to indicate that scanning is finished.
- If you are scanning the original on the document glass, scan each page one page at a time. When scanning finishes, place the next original and press the [BLACK & WHITE START] key (○●). Repeat until all pages have been scanned and then touch the [Read-End] key. A beep will sound to indicate that scanning is finished.

When the relay machine receives the fax, it will automatically transmit the fax to each of the end receiving machines programmed in the memory box.



To cancel scanning...

Press the [STOP] key (Ⓢ) while the original is being scanned.

RELAY BROADCAST TRANSMISSION USING F-CODES

When your machine receives an F-code relay request transmission, the fax is received to an F-code relay broadcast memory box in your machine. Your machine then relays the fax to each of the end receiving machines programmed in the memory box. Transmission to the end receiving machines takes place automatically.

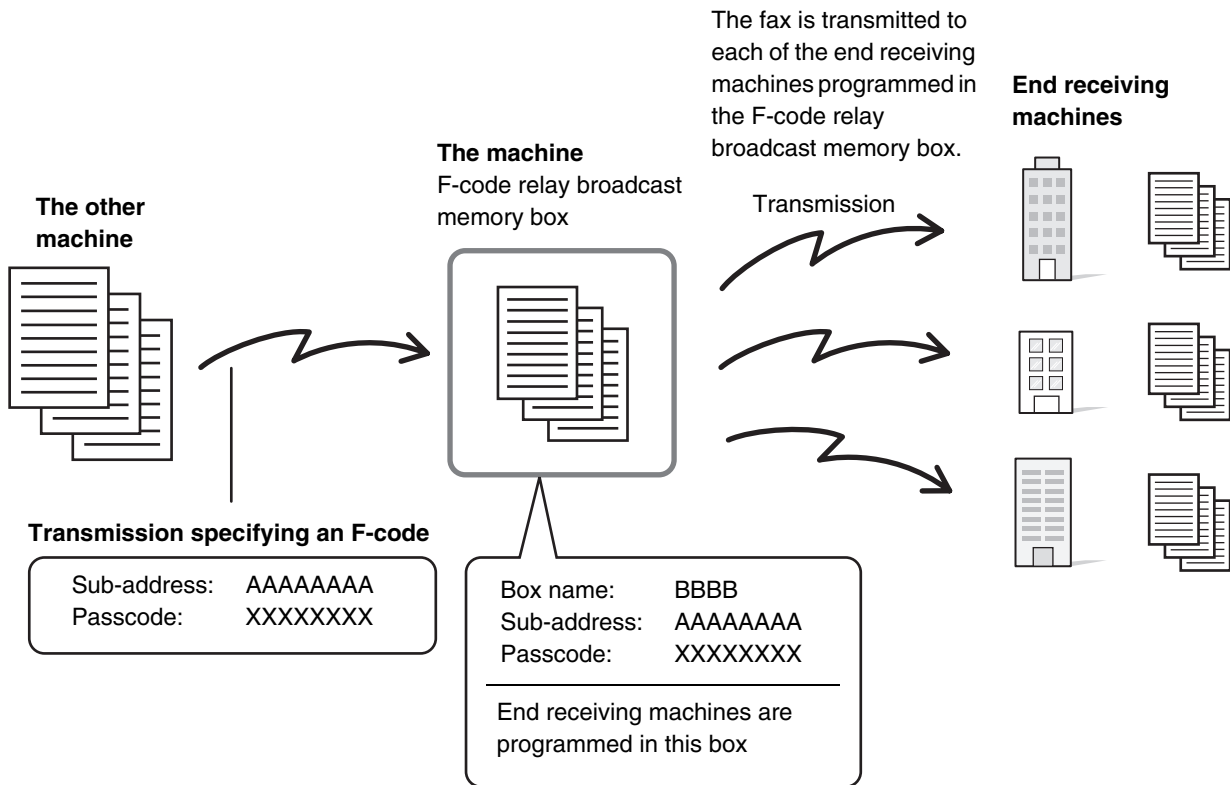

- Prior to the operation, inform the requesting party of the sub-address and passcode of the relay broadcast memory box in your machine.
- Program the end receiving machines in the F-code relay broadcast memory box when you create the box in your machine. [CREATING MEMORY BOXES IN THE MACHINE FOR F-CODE COMMUNICATION](#) (page 97)
- The end receiving machines do not need to support F-code communication.
- The machine that requests a relay broadcast transmission only bears the cost of sending the fax to your machine (the relay machine). Your machine bears the cost of sending the fax to each of the end receiving machines.

7

USING AN EXTENSION PHONE

This chapter explains how to use an extension phone to make voice calls and receive a fax after talking with the other party.

CONNECTING AND USING AN EXISTING PHONE (Extension Phone Connection)

You can connect an existing extension phone to the machine.

The phone can be used for voice calls and to start fax reception on the machine.

As an example, you can make a phone call using the existing phone, speak to the other party, and then press the [BLACK & WHITE START] key (○●) to fax an original that has been placed to that party. You can also press the [BLACK & WHITE START] key (○●) when an original is not placed to receive a fax.

Connect the extension phone as shown below.

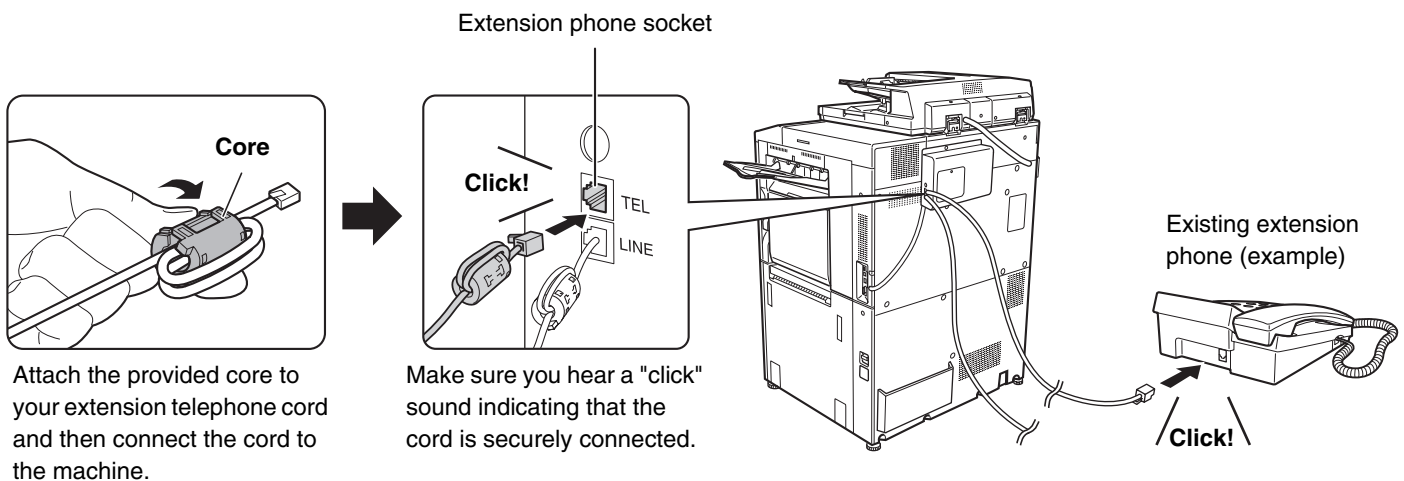

- Connect an extension phone that has a modular socket. Use standard phone line cable to connect the phone. If other than a standard phone line cable is used, the connection may not work correctly.
- If the plug on the telephone line cord does not fit into the socket on your extension phone, contact your dealer or nearest authorised service representative.

RECEIVING A FAX AFTER ANSWERING A CALL ON THE EXTENSION PHONE (Remote Reception)

Follow the steps below if you need to start fax reception after answering a call and speaking on the extension phone. If you are on a pulse-dial (rotary) line, set the extension phone to issue tone signals.

1

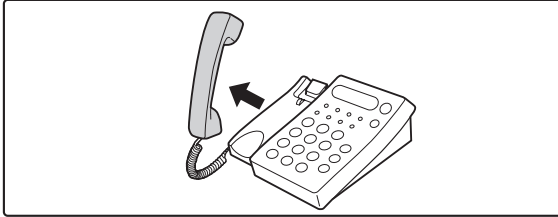

When you hear ringing, answer the call on the extension phone.

2

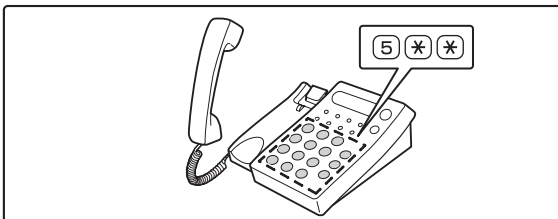

Signal the machine to start fax reception.

Press **5 * *** on the keypad of the extension phone.

3

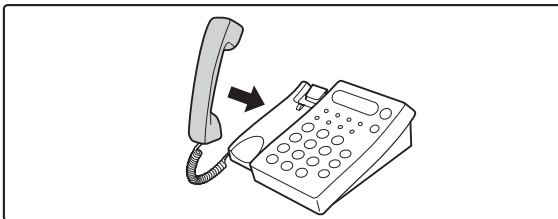

Replace the extension phone.

The machine sounds a beep when reception ends.



If the extension phone is still lifted when fax transmission ends, an alarm signal will sound and a message will appear in the touch panel. The alarm and message will stop when the extension phone is replaced.



- **System Settings: Receive Setting**

To use remote fax reception, set this setting to "Manual Reception".

- **System Settings (Administrator): Remote Reception Number Setting**

This is used to change the number used for remote fax reception. The factory default setting is "5".

MAKING AND RECEIVING PHONE CALLS

You can make and receive calls like normal on your extension phone. A phone call can also be made by dialling on the machine.

8

CHECKING THE STATUS OF FAX JOBS

This chapter explains how to check the status of reserved transmission jobs and received faxes.

JOB STATUS SCREEN

The job status screen is displayed when the [JOB STATUS] key on the operation panel is pressed. The job status screen shows the status of jobs by mode. When the [JOB STATUS] key is pressed, the job status screen of the mode that was being used before the key was pressed appears.

Reserved transmissions and received faxes are referred to as jobs here.

Example: Pressing the key in fax mode

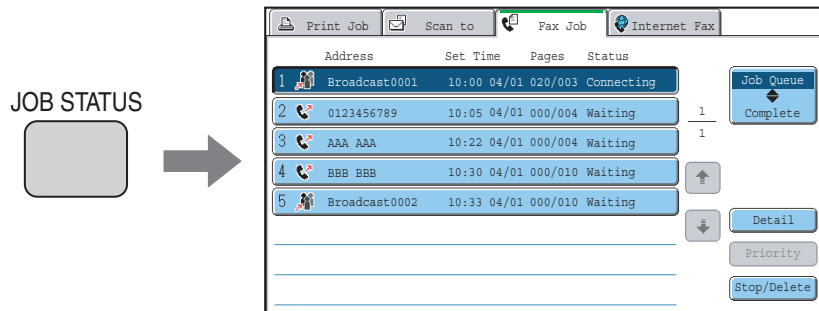

The job status display is in the lower left corner of the touch panel. The job status display can be touched to display the job status screen.

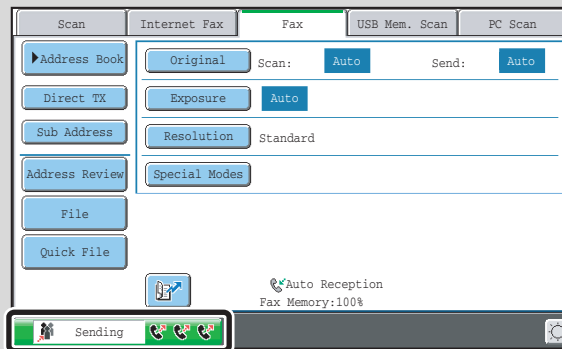

JOB QUEUE SCREEN AND COMPLETED JOB SCREEN

The job status screen consists of two screens: the job queue screen, which shows reserved jobs and the job currently in progress, and the completed jobs screen. To switch between the two screens, touch the job status screen selector key ((2) below).

Job queue screen

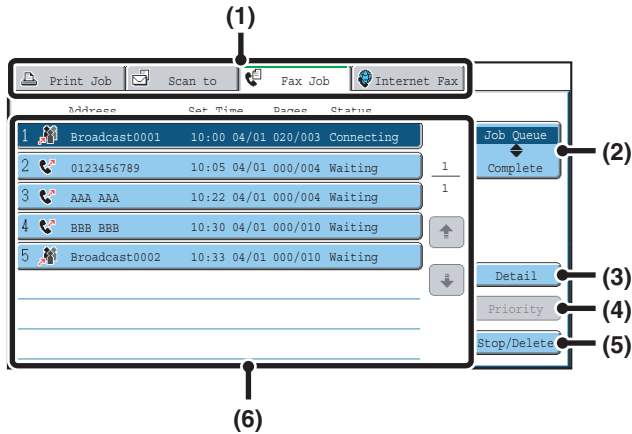

Completed job screen

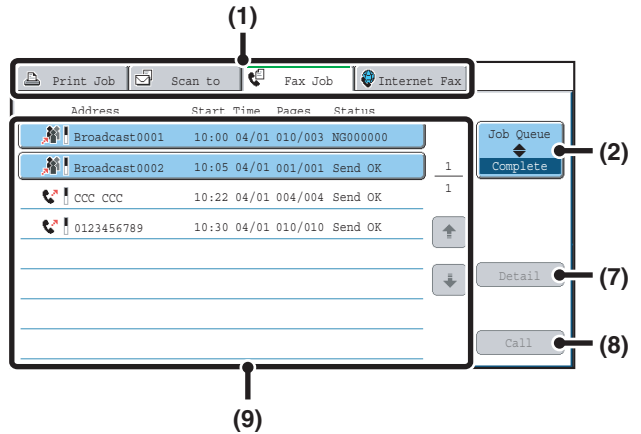

(1) Mode select tabs

Use these tabs to select the job status screen of each mode.

(2) Job status screen selector key

Touch this key to switch between the job queue screen and the completed jobs screen.

(3) Job queue screen [Detail] key

This shows detailed information on a broadcast transmission or serial polling job that is reserved or in progress. Select the key of the desired job in the job queue screen (6) and then touch the [Details] key.

☞ [CHECKING A RESERVED JOB OR THE JOB IN PROGRESS](#) (page 119)

(4) [Priority] key

Touch this key to give priority to a selected job.
☞ [GIVING PRIORITY TO A RESERVED FAX JOB](#) (page 123)

(5) [Stop/Delete] key

Touch this key to stop or delete a selected job.
☞ [CANCELLING A FAX IN PROGRESS OR A RESERVED FAX](#) (page 121)

(6) Job queue screen

Jobs are shown as keys in the order they were reserved. Each key shows information on a job and its current status.

☞ [Job key display](#) (page 116)

(7) Completed jobs screen [Detail] key

This shows detailed information on the results of completed broadcast transmission jobs, completed serial polling jobs, and completed jobs that used the document filing function. Select the key of the desired job in the completed jobs screen (9) and then touch the [Details] key.

From the details screen, it is possible to resend the fax to destinations to which transmission was not successful.

☞ [CHECKING COMPLETED JOBS](#) (page 120)

(8) [Call] key

Touch this key to retrieve and use a transmission or reception job that was stored using the document filing function.

(9) Completed jobs screen

This shows up to 99 completed transmission/reception jobs. A description of each job and the result (status) are shown.

Broadcast transmission jobs, serial polling jobs, received fax forwarding jobs, and transmission/reception jobs that used the document filing function are indicated as keys.

Job key display

The following information is shown in the job queue keys and completed job keys that appear in the job status screen.

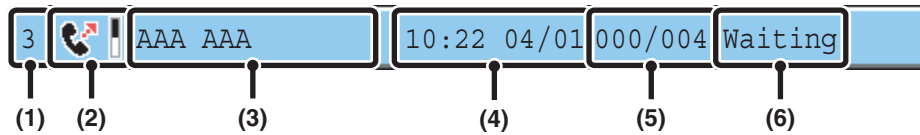

(1) Indicates the number (position) of the job in the job queue.

When the job currently being transmitted is finished, each job moves up one position in the job queue. This number does not appear in keys in the completed jobs screen.

(2) Mode icon

This indicates the type of job. In the completed jobs screen, a colour bar indicating black & white will appear next to the icon. (However, the colour bar icon does not appear in the key of a job stored using the document filing function.)

Icon	Job type
	Fax transmission
	Fax reception
	Broadcast transmission or serial polling
	PC-Fax transmission

(3) Name of other party

For a transmission, the name or fax number of the destination. For a reception, the fax number of the sending party. For a broadcast transmission or serial polling operation, the function name and a broadcast control number (4-digits).

(4) Time reserved / Time started

In the job queue screen, the date and time the job was reserved. In the completed jobs screen, the date and time the job was started.

(5) Number of pages

Shows the number of pages transmitted / total number of original pages.

(6) Status

Shows the job status.

- Job in progress

Message	Status
"Connecting"	Connecting
"Sending"	Sending
"Receiving"	Receiving
"Tel"	Speaking with the other party using an extension phone
"Stopped"	The job has been stopped.
"Error"	An error occurred while the job was being executed.

- Job waiting to be executed

Message	Status
"Waiting"	The job is waiting to be executed.
"Retry"	The job is being re-attempted due to a communication error or other problem.
"Stopping"	When a reserved fax job is cancelled, the job is put on stop-wait.
The day and time are displayed.	Timer transmission job (the specified time is displayed)

• Completed job

Message	Status
"Send OK"	Transmission completed.
"In Memory"	Reception completed but the fax has not been printed. (The received fax is being held by the print hold function.)
"Printed"	The received fax has been printed.
"Forward OK"	The received fax has been forwarded.
"Stopped"	The job was stopped.
"Number of successful transmission destinations / Total destinations OK"	Broadcast transmission or serial polling completed. If transmission to 3 destinations was successful out of a total of 5, "003/005" will appear.
"No response"	An error occurred because there was no response from the destination.
"Busy"	An error occurred because the other party was busy.
"Reject Reception"	A fax was sent from a party that has been blocked by the anti junk fax function.
"NGxxxxxx"	Transmission/reception was not successful because a communication error occurred (a 6-digit error code appears in xxxxxx.)
"Error"	An error occurred while the job was being executed.

OPERATION WHEN A JOB IN THE JOB QUEUE IS COMPLETED

When a normal transmission job is completed, it moves to the completed jobs screen and "Send OK" appears in the status column.

Received faxes, timer transmission jobs, retry jobs, and forwarding jobs are handled in the job status screen as explained below.

Fax reception jobs

While a fax is being received, "Receiving" appears in the job queue screen.

When reception is completed, the job moves to the completed jobs screen and "In Memory" appears.

After the fax is printed, the status changes to "Printed".

Timer transmission jobs

A timer transmission job appears at the bottom of the job queue screen until the specified time arrives.

When the specified time arrives, the job is executed. If another job is in progress, the timer job is started when the other job is completed.

Retry jobs

A retry job appears at the bottom of the job queue screen. When the set retry interval elapses, the job is executed. If there are jobs reserved ahead of the retry job, the retry job is reserved at the bottom of the job queue and executed when its turn arrives.

Fax reception jobs when Inbound Routing is enabled

When Inbound Routing is enabled in the Web pages, fax reception jobs are handled as follows depending on the print setting.

 [FORWARDING A RECEIVED FAX TO AN E-MAIL ADDRESS \(Inbound Routing Settings\)](#) (page 59)

- **Received fax is not printed**

"Receiving" appears in the job queue screen while the fax is being received. When reception is completed, the job moves to the job queue of the job status screen of scan mode.

- **Received fax is printed**

When reception is completed, the job moves to the completed jobs screen and "In Memory" appears. After the fax is printed, "Printed" appears. In addition, the job is added to the job queue of the job status screen of scan mode. When forwarding is finished, "Forward OK" appears.

CHECKING A RESERVED JOB OR THE JOB IN PROGRESS

The detailed contents of a broadcast transmission or serial polling job can be displayed. Select (touch) the key of the job that you wish to check and touch the [Detail] key. The job details screen will appear (see below).

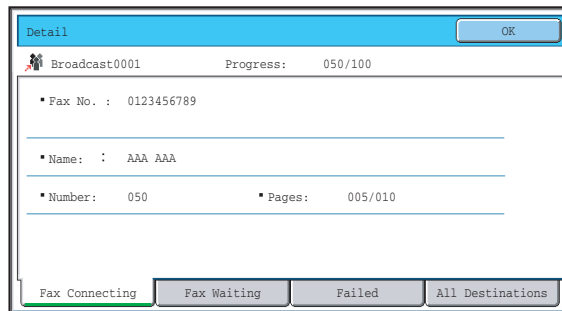

The job name and progress (number of completed destinations / total destinations) appear at the top of the screen. Touch a tab to display the information that appears on that tab. The following information appears on each tab.

Tab name	Information displayed
Fax Connecting	Information on the current destination appears. Fax No.: The fax number of the destination. Name: The name of the destination. Number: The broadcast control number (3-digits). Pages: Number of pages completed / total number of pages
Fax Waiting	This shows information on the destinations that are waiting. A broadcast control number (3-digits) appears in front of each destination. Address: The name of the other destination. Status: The status of communication.
Failed	This shows information on destinations for which communication failed. A broadcast control number (3-digits) appears in front of each destination. Address: The name or fax number of each destination. Start Time: The time when communication began. Status: The status of communication.
All Destinations	This shows all destinations specified in the job. A broadcast control number (3-digits) appears in front of each destination. Address: The name or fax number of the destination. Start time: The time at which communication began. Status: The status of communication.

CHECKING COMPLETED JOBS

You can check a list of the destinations, the destinations for which transmission failed, and other detailed information on completed broadcast transmission jobs, received fax forwarding jobs, serial polling jobs, and jobs that used document filing. Touch the key of the desired job in the completed jobs screen and touch the [Detail] key. The job detail screen (see below) will appear.

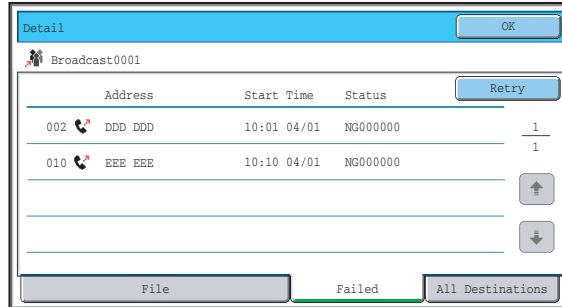

The job name appears at the top of the job detail screen.

To view details on the job, touch one of the tabs. The following information appears on each tab.

Tab name	Information displayed
File	Information on a transmission/reception that used document filing. To retrieve the file and use it, touch the [Call] key.
Failed	This shows information on destinations for which communication failed. A broadcast control number (3-digits) appears in front of each destination. Address: The name or fax number of each destination. Start time: Time at which communication began. Status: Description of failure (error) The [Retry] key can be touched to re-attempt transmission to that destination.
All Destinations	Shows all addresses specified in the job. A broadcast control number (3-digits) appears in front of each destination. Address: The name or fax number of each destination. Start time: Time at which communication began. Status: Communication result The [Retry] key can be touched to transmit to all destinations again.

CANCELLING A FAX IN PROGRESS OR A RESERVED FAX

Follow the steps below to cancel a fax transmission that is in progress or a reserved fax job.

1

JOB STATUS



Press the [JOB STATUS] key.

2

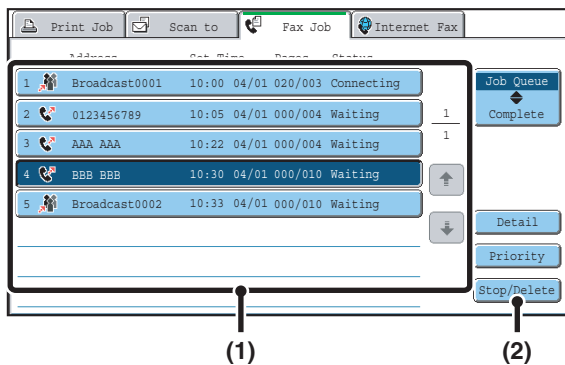

Select the fax job that you wish to cancel.

- (1) Touch the key of the fax job to be cancelled.
- (2) Touch the [Stop/Delete] key.

3

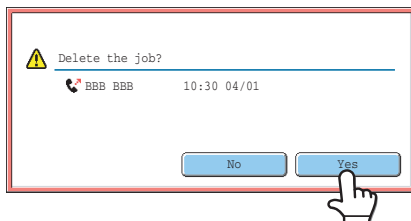

Touch the [Yes] key.



If you do not wish to cancel the selected fax job...
Touch the [NO] key.



- When a reserved fax job is cancelled, "Stopping" appears and the job is put on stop-wait. When the stop-wait job reaches the top of the job queue, it is deleted.
- If you cancel a fax job in progress, touch the [Yes] key to confirm the cancellation.

	Address	Set Time	Pages	Status	
1	Broadcast0001	10:00 04/01 020/003	Connecting		Job Queue
2	0123456789	10:05 04/01 000/004	Waiting	1	Complete
3	AAA AAA	10:22 04/01 000/004	Waiting	1	
4	Broadcast0002	10:33 04/01 000/010	Waiting		↑
5	BBB BBB	10:35 04/01 000/010	Stopping		↓

- When transmission of a job is cancelled, "Cancel" will appear in the result column of the transaction report.
- **To stop the cancellation and execute the job...**
While "Stopping" appears, the cancellation can be stopped and the job can be transmitted.
 - (1) Touch the key of the "Stopping" fax job.
 - (2) Touch the [Release] key.
The job status changes to "Waiting".
- Printing of received faxes and forwarding jobs set using "Inbound Routing Settings" cannot be cancelled.
 [FORWARDING A RECEIVED FAX TO AN E-MAIL ADDRESS \(Inbound Routing Settings\)](#) (page 59)

GIVING PRIORITY TO A RESERVED FAX JOB

When multiple jobs are waiting to be transmitted, the jobs are normally transmitted in the order they were reserved. If you need to give priority to a job and send it ahead of the other jobs, follow the steps below.

1

JOB STATUS



Press the [JOB STATUS] key.

2

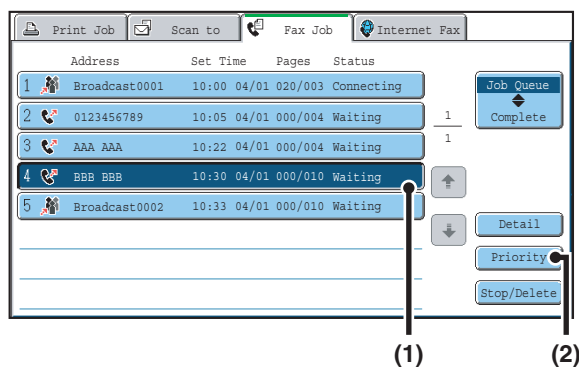

Select the fax job to which you wish to give priority.

(1) Touch the key of the desired job.

(2) Touch the [Priority] key.

The selected job moves up to the position immediately following the job in progress. The job will be executed when the job in progress is completed.

 If the job in progress is a broadcast transmission job or a serial polling job, the priority job will be transmitted between destinations of the broadcast transmission or serial polling job. However, if the priority job is a broadcast transmission job or a serial polling job, it will be executed after the current job is completed.

9

PRINTING A TRANSACTION REPORT / IMAGE SENDING ACTIVITY REPORT

This chapter explains how to print out and check the results of transmissions and receptions.

TRANSACTION REPORT

A transaction report is printed when transmission fails or after a broadcast transmission or a confidential reception. The conditions for printing a transaction report can be changed. The conditions can also be changed for only a single transmission.

Example of a transaction report

The report shows the date, starting time, name of the other party, time required, number of pages, and result.

TRANSACTION REPORT								P. 01/01	
								01/APR/2006/SAT 10:00 AM	
FAX (TX)									
#	DATE	START T.	SENDER	COM. TIME	PAGE	TYPE/NOTE	FILE		
001	01/APR	09:45AM	xxxxxxxxxx	0:00:13	1	OK	SG3	2697	



- **System Settings (Administrator): Transaction Report Print Select Setting**

This is used to set the conditions for printing transaction reports.

The factory default settings are print at below.

Single Sending: Print Out All Report//No Printed Report

Broadcasting: /Print Out Error Report Only/No Printed Report

Receiving: Print Out All Report/Print Out Error Report Only/

Confidential reception: /No Printed Report

- **System Settings (Administrator): Original Print on Transaction Report**



This is used to have part of the transmitted original printed on the transaction report.

CHANGING THE TRANSACTION REPORT PRINT CONDITION FOR A SINGLE TRANSMISSION

When performing a transmission, follow the steps below to select the condition for printing a transaction report. When the transmission is finished, your setting will be cleared.

Select the special modes.

1

- (1) Touch the [Special Modes] key.
- (2) Touch the   keys to switch through the screens.
- (3) Touch the [Transaction Report] key.

 [Special modes menu \(2nd screen\)](#) (page 61)

2

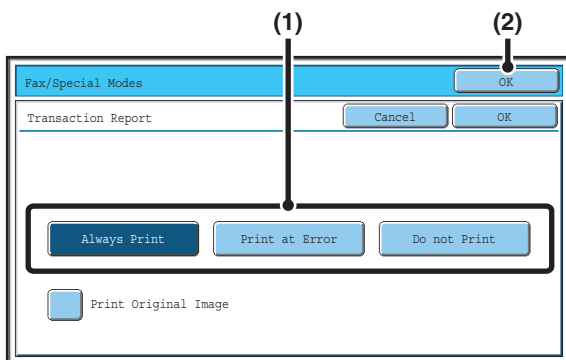

Select the transaction report print condition.

- (1) Touch the key of the desired print condition.
- (2) Touch the [OK] key.



- The print conditions for a transaction report are as follows:
 - "Always Print": A transaction report is printed no matter whether the transmission succeeds or fails.
 - "Print at Error": A transaction report is printed when transmission fails.
 - "Do not Print": Do not print a transaction report.
- When the [Print Original Image] checkbox is selected () , part of the transmitted original is included on the transaction report. However, the original image is not printed when the speaker is used to dial or a direct transmission or polling reception operation is performed.



For a broadcast transmission, the print condition applies to each destination.

INFORMATION APPEARING IN THE RESULT COLUMN

Error types and other information are printed in the result column of the report. Check the transaction result in the result column and take appropriate action if the result is an error.

Examples of messages that are printed in the result column

Message	Explanation
OK	The transaction was completed normally.
G3	Communication took place in G3 mode.
ECM	Communication took place in G3 ECM mode.
SG3	Communication took place in Super G3 mode.
Forwarding	The received data was forwarded.
NO RESPONSE	No response from the receiving party.
BUSY	Transmission was not possible because the other party was already using the line.
CANCEL	The transmission was cancelled while in progress.
MEMORY OVER	The memory became full during quick on-line transmission.
MEM.FULL	The memory became full during reception.
LENGTH OVER	The transmitted fax was over 1.5 m (59") long and therefore could not be received.
ORIGINAL ERROR	Direct transmission or manual transmission was not successful because a misfeed occurred.
PASS# NG	The connection was broken because the polling passcode was not correct.
NO RX POLL	The machine that was polled does not have a polling function.
RX POLL FAIL	The other machine refused the polling operation, or your machine broke the connection when polled because no data was in memory.
F-CODE RX POLL FAIL	The other machine refused an F-code polling operation, or your machine broke the connection when polled because no data was in its F-code memory polling box.
RX POLL# NG	The connection was broken because the sub-address for F-code polling memory was not valid.
F POLL PASS# NG	The connection was broken because the passcode for F-code polling memory was not valid.
BOX NO. NG	Your machine broke the connection because the specified sub-address for an F-code memory box does not exist.
F PASS# NG	Your machine broke the connection because the other machine sent an incorrect passcode for F-code communication.
RX NO F-CODE POLL	F-code polling was attempted, however, the other machine did not have an F-code polling memory box.
NO F FUNC	F-code communication was attempted, however, the other machine does not support F-code communication.
NO F-CODE	F-code communication was refused by the other machine because of an incorrect sub-address or other reason.
M. BOX: [xxxxxx] *****	Data was received to a confidential or relay broadcast memory box, or data was sent from a memory polling box. The name of the memory box appears in [xxxxxx], and the type of F-code operation (relay request reception, polling memory transmission, or confidential reception) appears in *****.
NG xx (xxxx) (1) (2)	The communication handshake signals or image signals were distorted due to line conditions or other reasons, and communication was not successful. (1) First two digits of communication error number: Error code from 00 to 99. (2) Last four digits of communication error number: Code for use by service technicians.
REJECTED	A fax was sent from a party from which reception is blocked.

IMAGE SENDING ACTIVITY REPORT

You can print a log of recent image sending activity (date, name of other party, result, etc.). The result column shows messages such as error types and other information. The Image Sending Activity Report shows your most recent 199 transactions.

You can have the machine print the Image Sending Activity Report each time the number of transactions reaches 200, or at a specified time (once a day only).

Example of the Image Sending Activity Report

The report shows the date, starting time, name of the other party, time required, number of pages, and result.

ACTIVITY REPORT (SEND)							P. 01/01
							01/APR/2006/SAT 10:00
FAX							
#	DATE	START T.	RECEIVER	COM. TIME	PAGE	TYPE/NOTE	FILE
001	01/APR	08:55	xxxxxxxx				0032
002		08:56	xxxxxxxx	0:00:13	1	OK	SG3 0033
003		09:01	xxxxxxxx	0:00:13	1	OK	SG3 0034
TOTAL				0:00:26	2		
GRAND TOTAL				0:00:26	2		



- The contents of the Image Sending Activity Report are erased when the report is printed, and thus it cannot be reprinted.
- The Image Sending Activity Report can also be printed manually. See "List Print" in the system settings (administrator).
- For the information that appears in the result column, see "[INFORMATION APPEARING IN THE RESULT COLUMN](#)" (page 126).



System Settings (Administrator): Activity Report Print Select Setting

This is used to set the condition for printing activity reports. The report is not printed by factory default. The Image Sending Activity Report can be set to print each time the number of transactions reaches 200, or at a specified time (once a day only).

10

IF THE MACHINE IS MOVED

This chapter explains connections and changes to settings that are necessary in the event that the machine is moved.

CONNECTIONS AND SETTINGS AFTER THE MACHINE IS MOVED

If the machine is moved to a different location or the fax number changes, check the following items and change the following settings:

Telephone line connection, telephone line type setting, check the main power, check the date and time, change your sender fax number setting.

CONNECTION TO THE TELEPHONE LINE

Be sure to use the provided telephone line cord to connect the machine to the wall telephone socket. Connect the end of the line cord that has the core to the "LINE" socket on the machine. Insert the other end (the end without the core) into a telephone line socket.

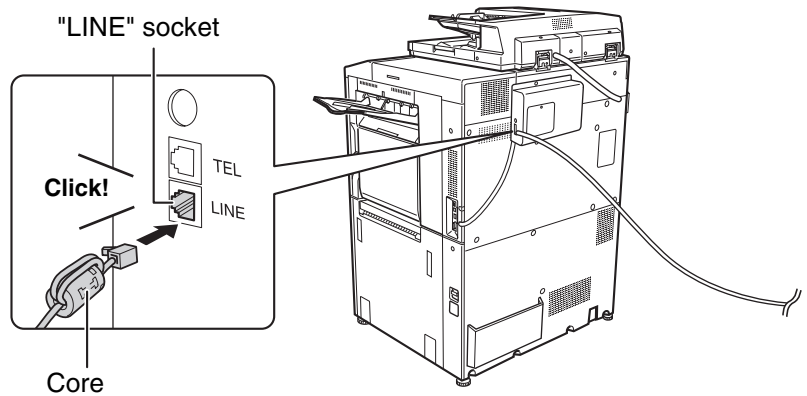

Insert the end of the cord with the core into the "LINE" socket.

An adapter is required to connect the telephone line cable to the wall telephone socket, as shown in the illustration.

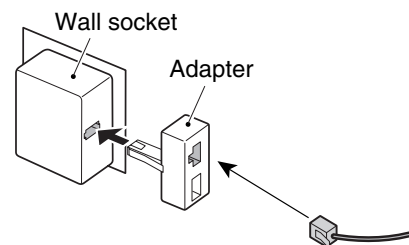

MAKE SURE THE MAIN POWER SWITCH IS IN THE "ON" POSITION

When the main power indicator on the operation panel is lit, the main power is on.

If the main power indicator light is not lit, the main power is "off". Switch the main power switch to the "on" position and press the [POWER] key (⏻) on the operation panel.

If the fax function will be used, and in particular if reception or timer transmission will take place at night, always keep the main power switch in the "on" position.



When the [POWER SAVE] key (Ⓜ) indicator light is blinking, the machine is in auto power shut-off mode. If the [POWER SAVE] key (Ⓜ) is pressed when the indicator is blinking, the indicator will turn off and the machine will return to the ready state after a brief interval.

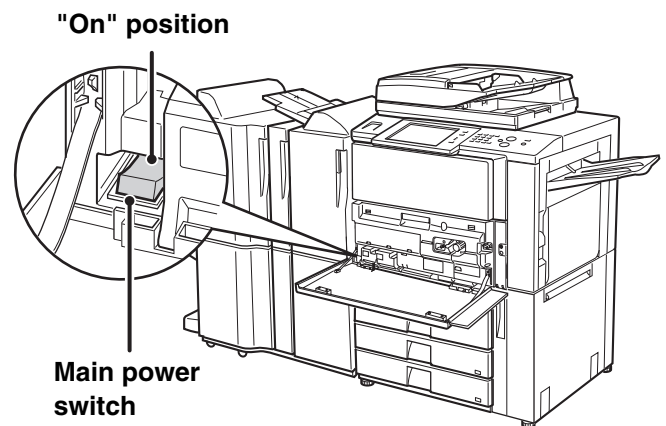
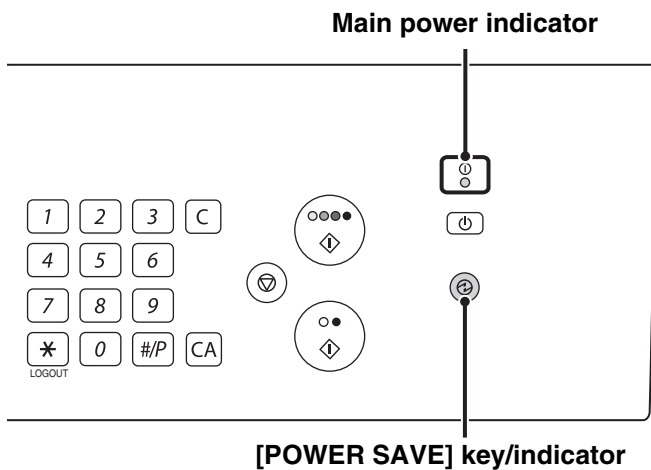

CHECKING THE DATE AND TIME

Verify that the correct date and time are set in the machine.

The date and time are set in the system settings of the machine. When the [SYSTEM SETTINGS] key is pressed, the system settings menu screen appears on the touch panel. Select [Default Settings], [Clock], and [Clock Adjust], and set the year, month, day, hour, and minute.



If "Disabling of Clock Adjustment" has been enabled in the system settings (administrator), the date and time cannot be set.

CHANGING THE SENDER FAX NUMBER

If your fax number changed, change the sender fax number.



System settings (administrator): Fax Own Name and Number Set

This is used to change the sender fax number.



SHARP®

Free Manuals Download Website

<http://myh66.com>

<http://usermanuals.us>

<http://www.somanuals.com>

<http://www.4manuals.cc>

<http://www.manual-lib.com>

<http://www.404manual.com>

<http://www.luxmanual.com>

<http://aubethermostatmanual.com>

Golf course search by state

<http://golfingnear.com>

Email search by domain

<http://emailbydomain.com>

Auto manuals search

<http://auto.somanuals.com>

TV manuals search

<http://tv.somanuals.com>