

SHARP®

LC-47SB57UT

LIQUID CRYSTAL TELEVISION
TÉLÉVISEUR ACL

TELEVISOR CON PANTALLA
DE CRISTAL LÍQUIDO

OPERATION MANUAL

MODE D'EMPLOI

MANUAL DE OPERACIÓN



ENGLISH

FRANÇAIS

ESPAÑOL



IMPORTANT : Please read this operation manual before starting operating the equipment.

IMPORTANT : Veuillez lire ce mode d'emploi avant de commencer à utiliser l'appareil.

IMPORTANTE : Lea este manual de operación antes de comenzar a operar el equipo.

LC-47SB57UT

LIQUID CRYSTAL TELEVISION

ENGLISH

OPERATION MANUAL

- The illustrations and on-screen displays in this operation manual are for explanation purposes and may vary slightly from the actual operations.
- Menu items that are not selectable are grayed out.
- To avoid scratching the frame or screen, please use a soft, lint free cloth for cleaning. Approved cleaning cloths are available directly from Sharp in single (00Z-LCD-CLOTH) or triple (00Z-LCD-CLOTH-3) packs. Call 1-800-BE SHARP for ordering, or VISIT www.sharppusa.com/SharpDirect.

IMPORTANT:

To aid reporting in case of loss or theft, please record the TV's model and serial numbers in the space provided. The numbers are located at the rear of the TV.

Model No.:

Serial No.:

IMPORTANT INFORMATION

WARNING: TO REDUCE THE RISK OF FIRE OR ELECTRIC SHOCK, DO NOT EXPOSE THIS PRODUCT TO RAIN OR MOISTURE.



CAUTION

RISK OF ELECTRIC SHOCK
DO NOT OPEN



This "bolt of lightning" indicates uninsulated material within your unit may cause an electrical shock. For the safety of everyone in your household, please do not remove product covering.

CAUTION: TO REDUCE THE RISK OF ELECTRIC SHOCK,
DO NOT REMOVE COVER (OR BACK).
NO USER-SERVICEABLE PARTS INSIDE.
REFER SERVICING TO QUALIFIED SERVICE
PERSONNEL.



The "exclamation point" calls attention to features for which you should read the enclosed literature closely to prevent operating and maintenance problems.

IMPORTANT INFORMATION

CAUTION:

DO NOT PLACE THIS PRODUCT ON AN UNSTABLE CART, STAND, TRIPOD, BRACKET, OR TABLE. THE PRODUCT MAY FALL CAUSING SERIOUS PERSONAL INJURY AND SERIOUS DAMAGE TO THE PRODUCT. USE ONLY WITH A CART, STAND, TRIPOD, BRACKET, OR TABLE RECOMMENDED BY THE MANUFACTURER OR SOLD WITH THE PRODUCT. FOLLOW THE MANUFACTURER'S INSTRUCTIONS WHEN INSTALLING THE PRODUCT AND USE MOUNTING ACCESSORIES RECOMMENDED BY THE MANUFACTURER. A PRODUCT AND CART COMBINATION SHOULD BE MOVED WITH CARE. QUICK STOPS, EXCESSIVE FORCE, AND UNEVEN SURFACES MAY CAUSE THE PRODUCT AND CART COMBINATION TO OVERTURN.



WARNING: FCC Regulations state that any unauthorized changes or modifications to this equipment not expressly approved by the manufacturer could void the user's authority to operate this equipment.

CAUTION:

This product satisfies FCC regulations when shielded cables and connectors are used to connect the unit to other equipment. To prevent electromagnetic interference with electric appliances such as radios and televisions, use shielded cables and connectors for connections.

DECLARATION OF CONFORMITY:

SHARP LIQUID CRYSTAL TELEVISION, MODEL LC-47SB57UT

This device complies with Part 15 of the FCC Rules. Operation is subject to the following two conditions: (1) This device may not cause harmful interference, and (2) this device must accept any interference received, including interference that may cause undesired operation.

RESPONSIBLE PARTY:

SHARP ELECTRONICS CORPORATION

Sharp Plaza, Mahwah, New Jersey 07495-1163

TEL: 1-800-BE-SHARP

For Business Customers: URL <http://www.sharppusa.com>

INFORMATION:

This equipment has been tested and found to comply with the limits for a Class B digital device, pursuant to Part 15 of the FCC Rules. These limits are designed to provide reasonable protection against harmful interference in a residential installation. This equipment generates, uses and can radiate radio frequency energy and, if not installed and used in accordance with the instructions, may cause harmful interference to radio communications. However, there is no guarantee that interference will not occur in a particular installation. If this equipment does cause harmful interference to radio or television reception, which can be determined by turning the equipment off and on, the user is encouraged to try to correct the interference by one or more of the following measures:

- Reorient or relocate the receiving antenna.
- Increase the separation between the equipment and receiver.
- Connect the equipment into an outlet on a circuit different from that to which the receiver is connected.
- Consult the dealer or an experienced radio/TV technician for help.

"Note to CATV system installer: This reminder is provided to call the CATV system installer's attention to Article 820-40 of the National Electrical Code that provides guidelines for proper grounding and, in particular, specifies that the cable ground shall be connected to the grounding system of the building, as close to the point of cable entry as practical."

This product utilizes tin-lead solder, and fluorescent lamp containing a small amount of mercury. Disposal of these materials may be regulated due to environmental considerations. For disposal or recycling information, please contact your local authorities, the Electronic Industries Alliance: www.eiae.org, the lamp recycling organization: www.lamprecycle.org or Sharp at 1-800-BE-SHARP
(For U.S.A. only)

TRADEMARKS

• Manufactured under license from Dolby Laboratories. "Dolby" and the double-D symbol are trademarks of Dolby Laboratories.

• "HDMI, the HDMI logo and High-Definition Multimedia Interface are trademarks or registered trademarks of HDMI Licensing LLC."

• Products that have earned the ENERGY STAR® are designed to protect the environment through superior energy efficiency.

DEAR SHARP CUSTOMER

Thank you for your purchase of the Sharp Liquid Crystal Television. To ensure safety and many years of trouble-free operation of your product, please read the Important Safety Instructions carefully before using this product.

IMPORTANT SAFETY INSTRUCTIONS

Electricity is used to perform many useful functions, but it can also cause personal injuries and property damage if improperly handled. This product has been engineered and manufactured with the highest priority on safety. However, improper use can result in electric shock and/or fire. In order to prevent potential danger, please observe the following instructions when installing, operating and cleaning the product. To ensure your safety and prolong the service life of your Liquid Crystal Television, please read the following precautions carefully before using the product.

- 1) Read these instructions.
- 2) Keep these instructions.
- 3) Heed all warnings.
- 4) Follow all instructions.
- 5) Do not use this apparatus near water.
- 6) Clean only with dry cloth.
- 7) Do not block any ventilation openings. Install in accordance with the manufacturer's instructions.
- 8) Do not install near any heat sources such as radiators, heat registers, stoves, or other apparatus (including amplifiers) that produce heat.
- 9) Do not defeat the safety purpose of the polarized or grounding-type plug. A polarized plug has two blades with one wider than the other. A grounding type plug has two blades and a third grounding prong. The wide blade or the third prong are provided for your safety. If the provided plug does not fit into your outlet, consult an electrician for replacement of the obsolete outlet.
- 10) Protect the power cord from being walked on or pinched particularly at plugs, convenience receptacles, and the point where they exit from the apparatus.
- 11) Only use attachments/accessories specified by the manufacturer.
- 12) Use only with the cart, stand, tripod, bracket, or table specified by the manufacturer, or sold with the apparatus. When a cart is used, use caution when moving the cart/apparatus combination to avoid injury from tip-over.
- 13) Unplug this apparatus during lightning storms or when unused for long periods of time.
- 14) Refer all servicing to qualified service personnel. Servicing is required when the apparatus has been damaged in any way, such as power-supply cord or plug is damaged, liquid has been spilled or objects have fallen into the apparatus, the apparatus has been exposed to rain or moisture, does not operate normally, or has been dropped.



Additional Safety Information

- 15) Power Sources—This product should be operated only from the type of power source indicated on the marking label. If you are not sure of the type of power supply to your home, consult your product dealer or local power company. For products intended to operate from battery power, or other sources, refer to the operating instructions.
- 16) Overloading—Do not overload wall outlets, extension cords, or integral convenience receptacles as this can result in a risk of fire or electric shock.
- 17) Object and Liquid Entry—Never push objects of any kind into this product through openings as they may touch dangerous voltage points or short-out parts that could result in a fire or electric shock. Never spill liquid of any kind on the product.
- 18) Damage Requiring Service—Unplug this product from the wall outlet and refer servicing to qualified service personnel under the following conditions:
 - a) When the AC cord or plug is damaged,
 - b) If liquid has been spilled, or objects have fallen into the product,
 - c) If the product has been exposed to rain or water,
 - d) If the product does not operate normally by following the operating instructions.
Adjust only those controls that are covered by the operating instructions as an improper adjustment of other controls may result in damage and will often require extensive work by a qualified technician to restore the product to its normal operation,
 - e) If the product has been dropped or damaged in any way, and
 - f) When the product exhibits a distinct change in performance - this indicates a need for service.
- 19) Replacement Parts—When replacement parts are required, be sure the service technician has used replacement parts specified by the manufacturer or have the same characteristics as the original part. Unauthorized substitutions may result in fire, electric shock, or other hazards.
- 20) Safety Check—Upon completion of any service or repairs to this product, ask the service technician to perform safety checks to determine that the product is in proper operating condition.
- 21) Wall or ceiling mounting—When mounting the product on a wall or ceiling, be sure to install the product according to the method recommended by the manufacturer.
- 22) The apparatus must be connected to a mains socket outlet with a protected earthed connection.
- 23) The appliance coupler is used as the disconnect device of this apparatus, the disconnect device shall remain readily operable.

IMPORTANT SAFETY INSTRUCTIONS

- **Outdoor Antenna Grounding** — If an outside antenna is connected to the television equipment, be sure the antenna system is grounded so as to provide some protection against voltage surges and built-up static charges. Article 810 of the National Electrical Code, ANSI/NFPA 70, provides information with regard to proper grounding of the mast and supporting structure, grounding of the lead-in wire to an antenna discharge unit, size of grounding conductors, location of antenna-discharge unit, connection to grounding electrodes, and requirements for the grounding electrode.

EXAMPLE OF ANTENNA GROUNDING AS PER
NATIONAL ELECTRICAL CODE, ANSI/NFPA 70

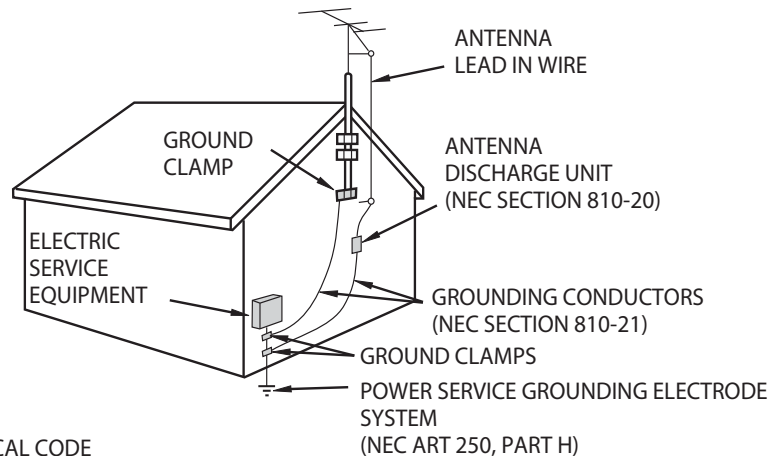

- **Water and Moisture** — Do not use this product near water - for example, near a bath tub, wash bowl, kitchen sink, or laundry tub; in a wet basement; or near a swimming pool; and the like.
- **Stand** — Do not place the product on an unstable cart, stand, tripod or table. Placing the product on an unstable base can cause the product to fall, resulting in serious personal injuries as well as damage to the product. Use only a cart, stand, tripod, bracket or table recommended by the manufacturer or sold with the product. When mounting the product on a wall, be sure to follow the manufacturer's instructions. Use only the mounting hardware recommended by the manufacturer.
- **Selecting the location** — Select a place with no direct sunlight and good ventilation.
- **Ventilation** — The vents and other openings in the cabinet are designed for ventilation. Do not cover or block these vents and openings since insufficient ventilation can cause overheating and/or shorten the life of the product. Do not place the product on a bed, sofa, rug or other similar surface, since they can block ventilation openings. This product is not designed for built-in installation; do not place the product in an enclosed place such as a bookcase or rack, unless proper ventilation is provided or the manufacturer's instructions are followed.
- **The Liquid Crystal panel used in this product is made of glass.** Therefore, it can break when the product is dropped or applied with impact. Be careful not to be injured by broken glass pieces in case the panel breaks.
- **Heat** — The product should be situated away from heat sources such as radiators, heat registers, stoves, or other products (including amplifiers) that produce heat.
- **The Liquid Crystal panel is a very high technology product with 2,073,600 pixels, giving you fine picture details.** Occasionally, a few non-active pixels may appear on the screen as a fixed point of blue, green or red. Please note that this does not affect the performance of your product.
- **Lightning** — For added protection for this television equipment during a lightning storm, or when it is left unattended and unused for long periods of time, unplug it from the wall outlet and disconnect the antenna. This will prevent damage to the equipment due to lightning and power-line surges.
- **Power Lines** — An outside antenna system should not be located in the vicinity of overhead power lines or other electric light or power circuits, or where it can fall into such power lines or circuits. When installing an outside antenna system, extreme care should be taken to keep from touching such power lines or circuits as contact with them might be fatal.
- To prevent fire, never place any type of candle or flames on the top or near the TV set.
- To prevent fire or shock hazard, do not expose this product to dripping or splashing.
No objects filled with liquids, such as vases, should be placed on the product.
- To prevent fire or shock hazard, do not place the AC cord under the TV set or other heavy items.
- Turn off the main power and unplug the AC cord from the wall outlet before handling.
- Use a soft cloth and gently wipe the surface of the display panel. Using a hard cloth may scratch the panel surface.
- Use a soft damp cloth to gently wipe the panel when it is really dirty.
(It may scratch the panel surface when wiped strongly.)
- If the panel is dusty, use an anti-static brush, which is commercially available, to clean it.
- To protect the panel, do not use a dirty cloth, liquid cleaners or chemical cloth to clean it, such materials may damage the panel surface.
- Do not display a still picture for a long time, as this could cause an afterimage to remain.
- Install the product on the place where the AC cord can be unplugged easily from the AC outlet, or from the AC INPUT terminal on the rear of the product.
- When transporting the TV, never carry it by holding or otherwise putting pressure onto the display.
Be sure to always carry the TV by two people holding it with two hands – one hand on each side of the TV.
- Do not insert foreign objects into the product. Inserting objects in the air vents or other openings may result in fire or electric shock. Exercise special caution when using the product around children.

IMPORTANT SAFETY INSTRUCTIONS

CHILD SAFETY

It Makes A Difference How and Where You Use Your Flat Panel Display

Congratulations on your purchase! As you enjoy your new product, please keep these safety tips in mind:



THE ISSUE

- The home theater entertainment experience is a growing trend and larger flat panel displays are popular purchases. However, flat panel displays are not always supported on the proper stands or installed according to the manufacturer's recommendations.
- Flat panel displays that are inappropriately situated on dressers, bookcases, shelves, desks, speakers, chests or carts may fall over and cause injury.

THIS MANUFACTURER CARES!

- The consumer electronics industry is committed to making home entertainment enjoyable and safe.

TUNE INTO SAFETY

- One size does NOT fit all. Follow the manufacturer's recommendations for the safe installation and use of your flat panel display.
- Carefully read and understand all enclosed instructions for proper use of this product.
- Don't allow children to climb on or play with furniture and television sets.
- Don't place flat panel displays on furniture that can easily be used as steps, such as a chest of drawers.
- Remember that children can become excited while watching a program, especially on a "larger than life" flat panel display. Care should be taken to place or install the display where it cannot be pushed, pulled over, or knocked down.
- Care should be taken to route all cords and cables connected to the flat panel display so that they cannot be pulled or grabbed by curious children.

WALL MOUNTING: IF YOU DECIDE TO WALL MOUNT YOUR FLAT PANEL DISPLAY, ALWAYS:

- Use a mount that has been recommended by the display manufacturer and/or listed by an independent laboratory (such as UL, CSA, ETL).
- Follow all instructions supplied by the display and wall mount manufacturers.
- If you have any doubts about your ability to safely install your flat panel display, contact your retailer about professional installation.
- Make sure that the wall where you are mounting the display is appropriate. Some wall mounts are not designed to be mounted to walls with steel studs or old cinder block construction. If you are unsure, contact a professional installer.
- A minimum of two people are required for installation. Flat panel displays can be heavy.



Note: CEA is the preeminent trade association promoting growth in the \$161 billion U.S. consumer electronics industry. More than 2,200 companies enjoy the benefits of CEA membership, including legislative advocacy, market research, technical training and education, industry promotion and the fostering of business and strategic relationships.

QUICK REFERENCE

Supplied Accessories

Make sure the following accessories are provided with the product.

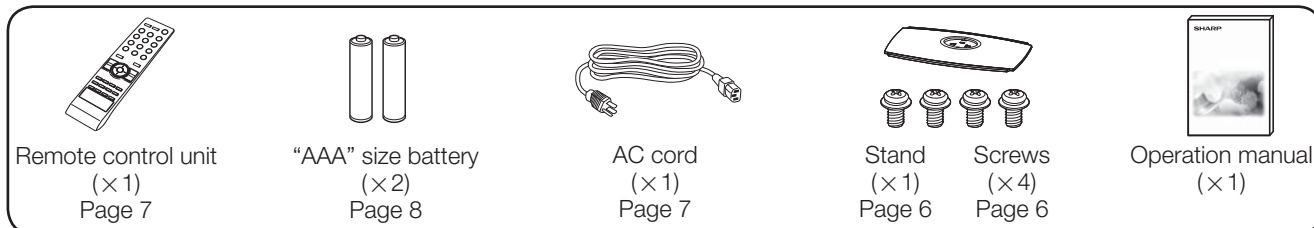

NOTE

- Always use the AC cord supplied with the TV.

Attaching/Detaching the Stand

- Before attaching (or detaching) the stand, unplug the AC cord from the AC INPUT terminal.
- Before performing work spread cushioning over the base area to lay the TV on. This will prevent it from being damaged.

CAUTION

- **Attach the stand in the correct direction.**
- **Be sure to follow the instructions. Incorrect installation of the stand may result in the TV falling over.**

- 1 Confirm that there are 4 screws supplied with the stand unit.



- 2 ① Insert the stand into the openings on the bottom of the TV.

- ② Insert and tighten the 4 screws into the 4 holes on the bottom of the TV.

CAUTION

- **Do not push too hard or put excessive pressure to the stand neck to avoid the damages when you turn the TV for the most comfortable viewing angle.**

NOTE

- To detach the stand, perform the steps in reverse order.

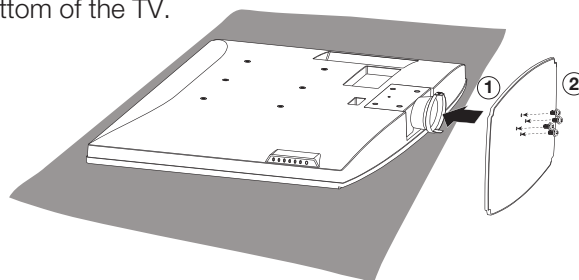

Detaching the stand neck for wall mounting

CAUTION

- **Detach the stand neck in the correct direction.**
- **Do not remove the stand neck from the TV unless using an optional wall mount bracket to mount it.**

1. ① Loosen the 4 screws that secure the stand neck by using a cross-head screwdriver. Remove stand cover from the TV set.
- ② Loosen the 4 screws and pull out hinge plate.
2. Place the stand cover in the TV set and tighten the 4 screws into the 4 holes.

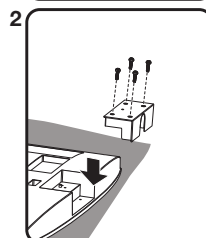
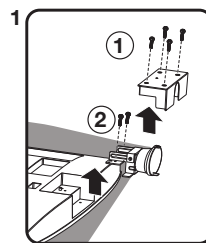

NOTE

- To attach the stand neck, perform the steps in reverse order.

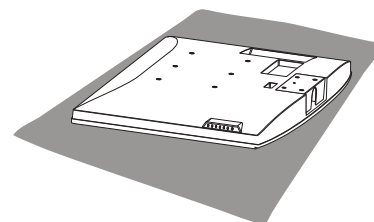

QUICK REFERENCE

Quick Installation Tips

- 1 Attach your antenna to the back of the television.
(See page 8.)
- 2 Connect the AC plug for the television into the AC outlet.

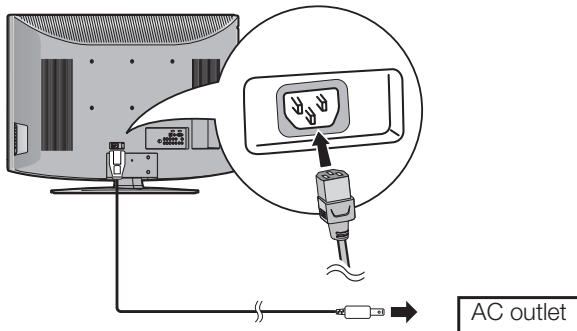

- Place the TV close to the AC outlet, and keep the power plug within reach.
- This product must only be connected to a 120V, 60Hz, grounded (3-prong) outlet. Connecting it to any other kind of outlet will damage the product and invalidate the warranty.

NOTE

- **TO PREVENT RISK OF ELECTRIC SHOCK, DO NOT TOUCH UN-INSULATED PARTS OF ANY CABLES WITH THE AC CORD CONNECTED.**

- 3 Bundle the cords properly with the cable tie.

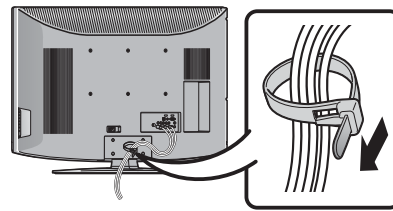

- 4 How to turn on the television for the first time.

- A) Press **POWER** on the television.
- B) The POWER indicator on the front of the television lights BLUE.

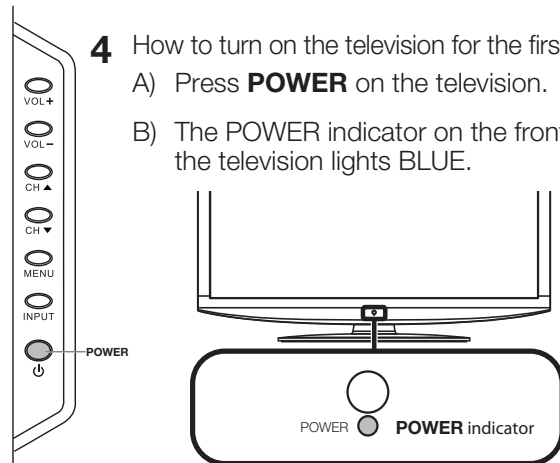

NOTE

- Speakers cannot be detached from the TV.

Using the Remote Control Unit

Use the remote control unit by pointing it towards the remote control sensor on the TV. Objects between the remote control unit and the remote control sensor may prevent proper operation.

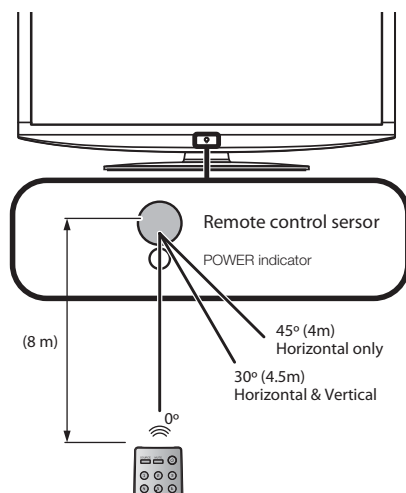

■ Cautions regarding the remote control unit

- Do not expose the remote control unit to shock. In addition, do not expose the remote control unit to liquids, and do not place in an area with high humidity.
- Do not install or place the remote control unit under direct sunlight. The heat may cause deformation of the remote control unit.
- The remote control unit may not work properly if the remote control sensor on the TV is under direct sunlight or strong lighting. In such cases, change the angle of the lighting or the TV, or operate the remote control unit closer to the remote control sensor.

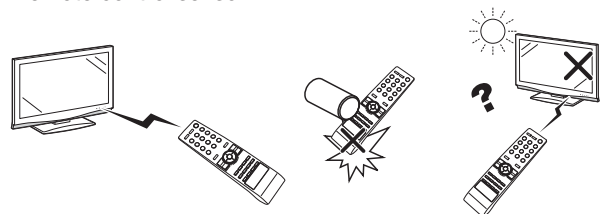

IMPORTANT:

The POWER indicator on the television should light BLUE indicating you have power to the television.

If the POWER indicator on the television still does not light up, press **POWER** on the remote control to turn the power on.

IMPORTANT:

IF THE UNIT DOES NOT POWER ON - UNPLUG THE TELEVISION FROM THE OUTLET AND REPEAT THE INSTALLATION STEPS.

IF YOU STILL ENCOUNTER NO POWER, PLEASE CONTACT US AT 1-800-BE-SHARP.

Preparation

Antennas

To enjoy a clearer picture, use an outdoor antenna. The following is a brief explanation of the types of connections that are used for a coaxial cable. If your outdoor antenna uses a 75-ohm coaxial cable with an F-type connector, plug it into the antenna terminal at the rear of the TV set.

1. A 75-ohm system is generally a round cable with F-type connector that can easily be attached to a terminal without tools (Commercially available).
2. A 300-ohm system is a flat "twin-lead" cable that can be attached to a 75-ohm terminal through a 300/75-ohm adapter (Commercially available).

NOTE

When connecting the RF cable to the TV set, do not tighten F-type connector with tools. If tools are used, it may cause damage to your TV set. (The breaking of internal circuit, etc.)

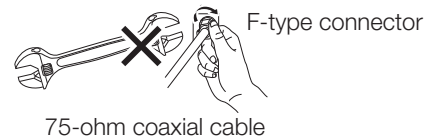
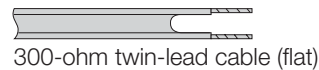
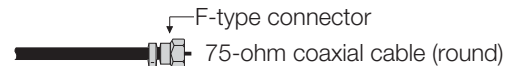

Connecting Antenna

• Connect the antenna cable to the TV using one of the methods in the illustration as shown (①, ②, ③ or ④).

① Cable without a CATV converter

② VHF/UHF antenna

③ Combination VHF/UHF antenna

④ Separate VHF/UHF antenna

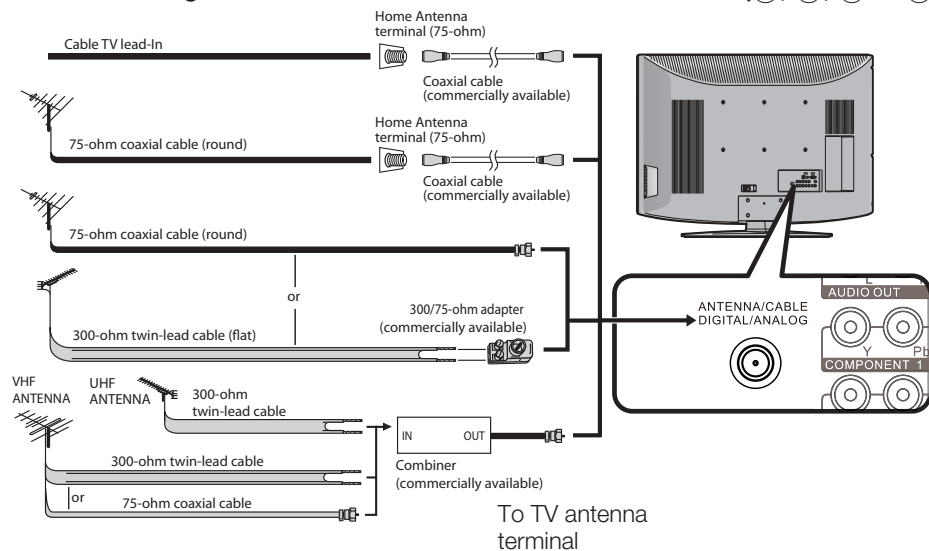

Installing Batteries in the Remote Control Unit

If the remote control fails to operate TV functions, replace the batteries in the remote control unit.

1 Open the battery cover.

2 Insert two "AAA" size batteries (supplied with the product).

3 Close the battery cover.

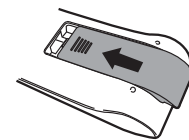
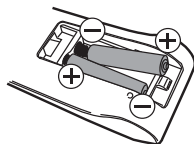
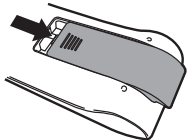

- Place the batteries with their terminals corresponding to the (+) and (-) indications in the battery compartment.

CAUTION

Improper use of batteries can result in chemical leakage or explosion. Be sure to follow the instructions below.

- Do not mix batteries of different types. Different types of batteries have different characteristics.
- Do not mix old and new batteries. Mixing old and new batteries can shorten the life of new batteries or cause chemical leakage in old batteries.
- Remove batteries as soon as they are worn out. Chemicals that leak from batteries come in contact with skin can cause a rash. If you find any chemical leakage, wipe thoroughly with a cloth.
- The batteries supplied with this product may have a shorter life expectancy due to storage conditions.
- If you will not be using the remote control unit for an extended period of time, remove batteries from it.

Contents

IMPORTANT INFORMATION	1
TRADEMARKS	2
IMPORTANT SAFETY INSTRUCTIONS	3
QUICK REFERENCE	6
Supplied Accessories	6
Attaching/Detaching the Stand	6
Detaching the stand neck for wall mounting.....	6
Quick Installation Tips	7
Using the Remote Control Unit	7
Antennas	8
Connecting Antenna Cable	8
Installing Batteries in the Remote Control Unit.....	8
Contents	9
Part Names	10
TV (Front).....	10
TV (Side/Rear).....	10
Remote Control Unit	11
Connecting to External Equipment	12
Watching TV	13
Turning On/Off the Power	13
Initial Setup	13
Direct Button Operation	15
On-Screen Display Menu	19
Menu Items.....	19
For TV Mode.....	19
For PC Mode	19
On-Screen Display Menu Operation.....	20
Menu Operation Button	20
Picture Menu	21
Audio Menu	21
Feature Menu	22
Channel Menu	25
VGA Menu	26
Appendix	27
Troubleshooting.....	27
Specifications	28
PC Compatibility Chart	29
Information on the Software License for This Product	29
Legal notices	30
Calling for Service	31
LIMITED WARRANTY	31

Dimensional Drawings

- The dimensional drawings for the LCD TV set are shown on the inside back cover.

Part Names

TV (Front)

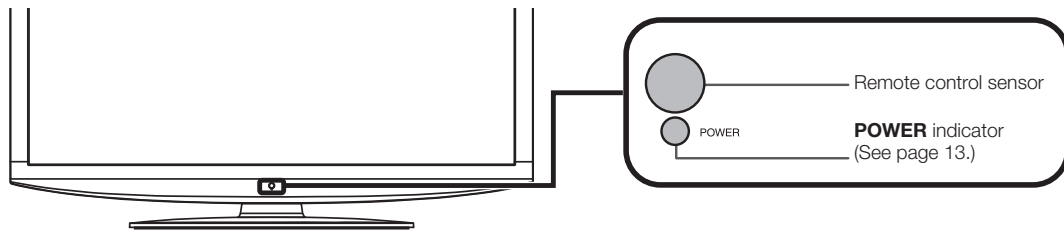

TV (Side/Rear)

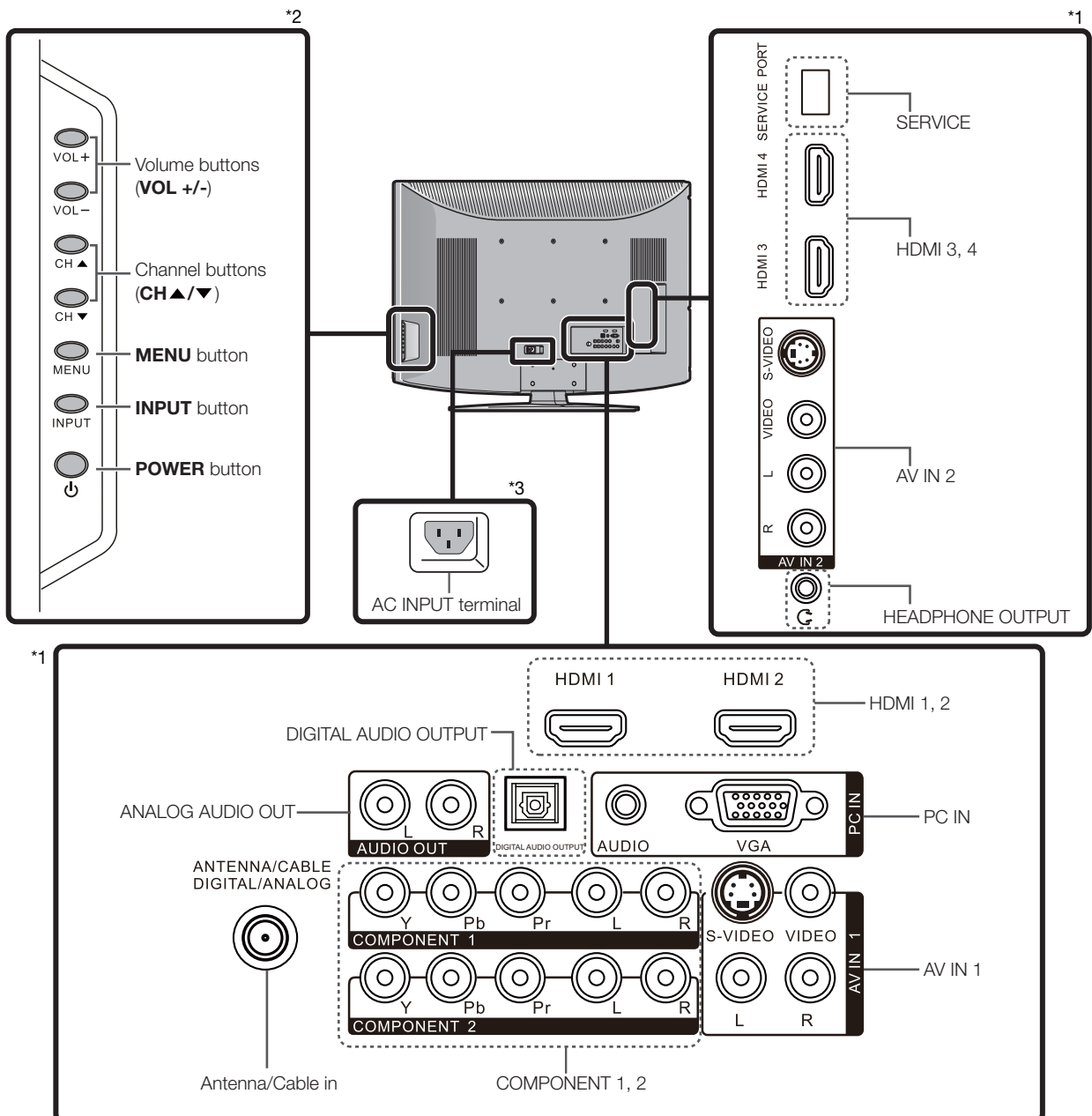

*1: See pages 8 and 12 for external equipment connection.

*2: See page 20 for button operations.

*3: See page 7 for connecting the AC cord.

Part Names

Remote Control Unit

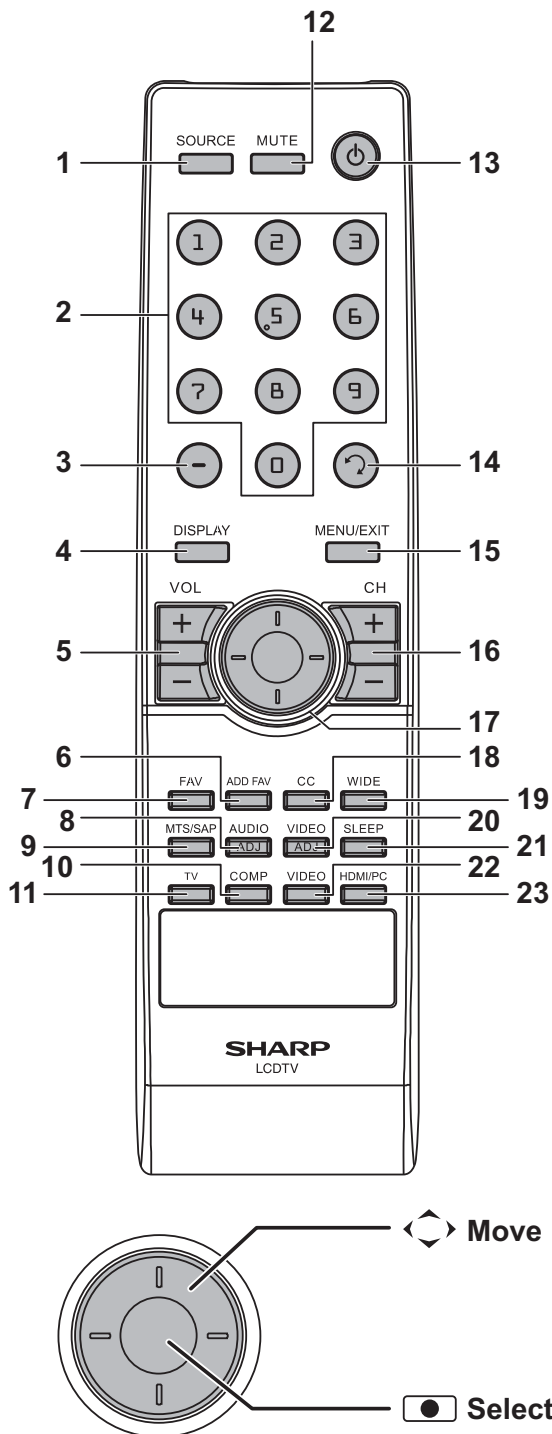

- 1 **SOURCE**: Select a TV input source. (See page 15.)
- 2 **0-9**: Set the channel.
- 3 **- (DASH)**: (See page 15.)
- 4 **DISPLAY**: Display the current channel (or input source) information on the screen.
- 5 **VOL +/-** : Set the volume. (See page 15.)
- 6 **ADD FAV**: Press to add channel to Favorite List.
- 7 **FAV**: Press to display the Favorite Channel List.
- 8 **AUDIO ADJ**: Press to choose preset audio mode from Standard, Movies, News, or Custom. (See page 15.)
- 9 **MTS/SAP**: Display the MTS/SAP setting menu. (See page 16.)
- 10 **COMP**: Press to choose Component 1 or Component 2 source mode.
- 11 **TV**: Press to choose TV source mode.
- 12 **MUTE**: Mute the sound. (See page 15.)
- 13 **POWER**: Switch the power on or enters standby mode. (See page 13.)
- 14 **↶** : Press to display the previous channel.
- 15 **MENU/EXIT**: Display or close the menu screen.
- 16 **CH +/-** : Select the channel. (See page 15.)
- 17 **Navigation Ring**: Select a desired item on the screen.
- 18 **CC**: Display captions during closed-caption source. (See page 16.)
- 19 **WIDE**: Select the screen size. (See page 17-18.)
- 20 **VIDEO ADJ**: Press to choose the Picture Mode from Vivid, Standard, PWR, Theater, Sport, or Custom. (See page 15.)
- 21 **SLEEP**: Allows you to set a time when the TV automatically switches to standby. This display will disappear after a few seconds, and the sleep timer automatically starts counting down. (See page 15.)
 - If you want to adjust the sleep timer again, you can press this button repeatedly then change the time setting.
 - The TV will enter the standby mode when the remaining time reaches zero.
- 22 **VIDEO**: Press to choose AV1 or AV2 source mode.
- 23 **HDMI/PC**: Press repeatedly to choose VGA, HDMI 1, HDMI 2, HDMI 3, or HDMI 4 source mode.

NOTE

- When using the remote control unit, point it at the TV.

Connecting to External Equipment

You can connect many types of external equipment to your TV like a Blu-ray disc player, HD-DVD player, DVD player, VCR, Digital TV tuner, HDMI equipment, game console or camcorder. To view external source images, select the input source from **SOURCE** on the remote control unit or **INPUT** on the TV. (See page 15.)

CAUTION

- To protect equipment, always turn off the TV before connecting any external equipment.
- Please read the relevant operation manual (Blu-ray disc player, etc.) carefully before making connections.

Connecting a Blu-ray disc player, HD-DVD player, DVD player, Digital TV STB (Air or Cable), VCR, game console or camcorder.

Terminal on the TV	Cable	Terminal on external equipment
AV IN 1 or 2 	AV cable (commercially available) 	VIDEO L R AUDIO
COMPONENT 1 or 2 	Component video cable (commercially available) Audio cable (commercially available) 	Y Pb Pr COMPONENT L R AUDIO
AV IN 1 or 2 	S-VIDEO cable (commercially available) Audio cable (commercially available) 	S-VIDEO L R AUDIO
HDMI 1, 2, 3 or 4 	HDMI-certified cable (commercially available) 	HDMI
DIGITAL AUDIO OUTPUT 	Optical or Coaxial cable (commercially available) 	DIGITAL AUDIO INPUT
ANALOG AUDIO OUT 	Audio cable (commercially available) 	L R AUDIO
HEADPHONE OUTPUT 	Headphone cable (commercially available) 	

NOTE

- *1 To enjoy the 1080p display capability, connect your external equipment using a component cable and set the equipment to 1080p output.
- *2 The S-VIDEO terminal takes priority over the video terminals. (AV IN 1 or 2 only)
- *3 When using an HDMI-DVI conversion cable, input the audio signal to AUDIO terminal of HDMI 3 or 4.
To enjoy the 1080p display capability, connect your Blu-ray disc player, HD-DVD player or other external equipment using an HDMI-certified cable and set the equipment to 1080p output.
- *4 Depending on the connected equipment, audio will not output from the DIGITAL AUDIO OUTPUT terminal in HDMI connection. In this case, set the audio formats of the connected equipment to PCM, 32/44.1/48 kHz and 16 bits.
Digital audio cannot be output through the HDMI terminal.
Dolby Digital audio output signals cannot be converted to PCM.

Connecting a PC

Terminal on the TV	Cable	Terminal on PC
PC IN 	RGB cable (commercially available) ø 3.5 mm stereo minijack cable (commercially available) 	ANALOG RGB AUDIO
HDMI 1, 2, 3 or 4 	HDMI-certified cable (commercially available) 	HDMI

NOTE

- The HDMI terminals only support digital signal.
- Refer to page 29 for a list of PC signals compatible with the TV.

Watching TV

Turning On/Off the Power

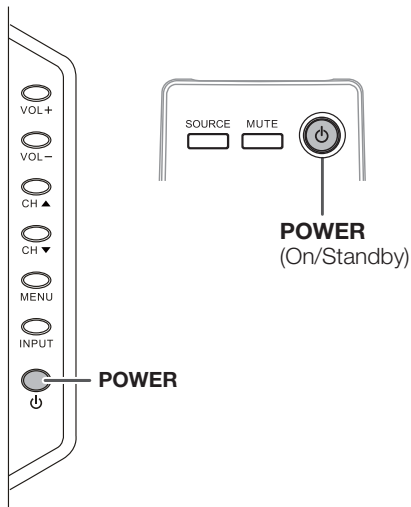

Press **POWER** on the TV, or **POWER** on the remote control unit to turn the power on.

- **POWER** indicator (Blue): The TV is on. (After a few seconds, a window appears with sound.)

Press **POWER** on the TV, or **POWER** on the remote control unit again to turn the power off.

- The TV enters standby and the image on the screen disappears.
- **POWER** indicator (Red): The TV is standby.

NOTE

- If you are not going to use this TV for a long period of time, be sure to remove the AC cord from the AC outlet.
- Weak electric power is still consumed even when the TV is turned off.
- If there is no signal input for 30 minutes, the power will turn to standby mode automatically.

Initial Setup

When you turn on the TV for the first time, it will automatically memorize the broadcasting channels available in the region where you live. Perform the following steps before you press **POWER** on the remote control unit.

1. Insert the batteries into the remote control unit. (See page 8.)
2. Connect the antenna cable to the TV. (See page 8.)
3. Plug in the AC cord to the AC outlet. (See page 7.)

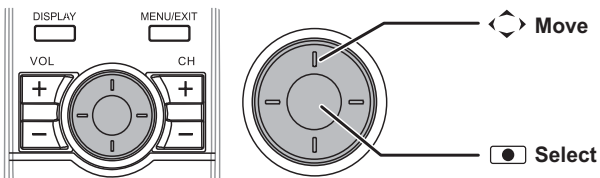

1. Language setting

- Select from among 3 languages: English, Spanish, and French.
- Press ▲/▼ to select the desired language listed on the screen, and then press the **Select** button to the next step.

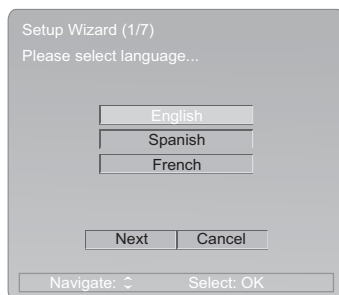

2. Time mode setting

- Press ▲/▼ to select Auto or Manual to set the time mode and press the **Select** button to the next step.
- Press ▲/▼ to select "Previous" and press the **Select** button to go back to the previous setting.

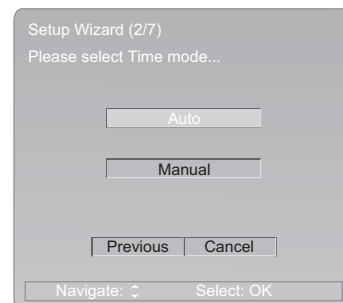

3. Time Zone setting

- Press ▲/▼ to set the time zone and press the **Select** button to the next step.
- Press ▲/▼ to select "Previous" and press the **Select** button to go back to the previous setting.

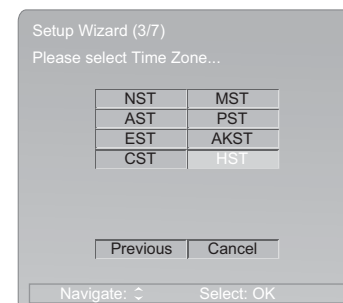

Watching TV

4. Air/Cable (Antenna setting)

- Make sure what kind of connection is made with your TV when selecting “Air” or “Cable”.

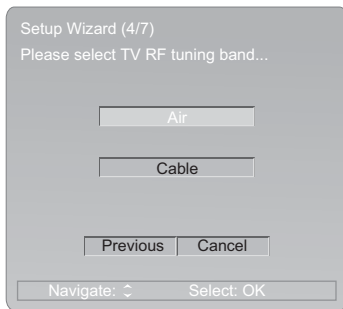

- Press ▲/▼ to select “Air” or “Cable” and press the **Select** button to continue. Press the **Select** button to start the channel searching.

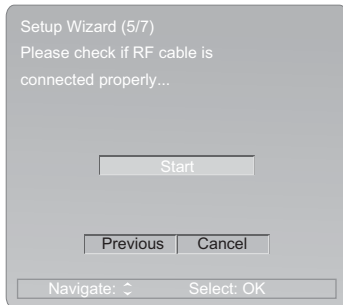

- Press ▲/▼ to select “Previous” and press the **Select** button to go back to the previous setting.

5. Channel Searching

- Wait until the channel search complete or press **Select** to cancel this step.
- If you skip this step, the channel scan can be performed in the Channel Menu. (See page 25.)

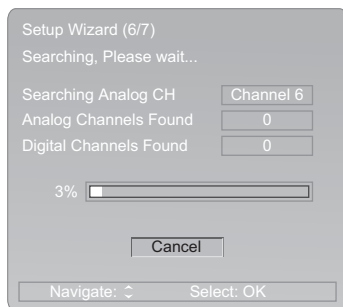

NOTE

- Auto programming may take 20+ minutes to complete. Digital channels will take longer than Analog to find and program. Please wait until you see the Auto programming complete message. The TV will then switch automatically to the first channel found.

Direct Button Operation

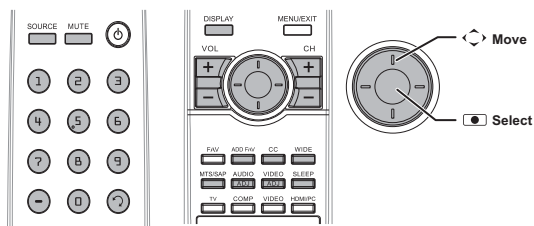

Changing Channels

You can change channels by pressing **CH +/-** or **0-9, - (DASH)**.

Examples:

To select a 1 or 2-digit channel number (e. g., Channel 5):

Press **5** → **Select**.

To select a 3-digit channel number (e. g., Channel 115):

Press **1** → **1** → **5** → **Select**.

To select a 4-digit channel number (e. g., Channel 22-1):

Press **2** → **2** → **- (DASH)** → **1** → **Select**.

NOTE

- When selecting a 1-digit channel number, it is not necessary to press **0** before the number.

Changing Volume

You can change the volume by pressing **VOL +/-** on the TV or on the remote control unit.

- To increase the volume, press **VOL +**.
- To decrease the volume, press **VOL -**.

SOURCE

To view external source images, select the input source using **SOURCE** on the remote control unit or **INPUT** on the TV.

1. Press **SOURCE**.
A list of selectable sources appears.
2. Press **SOURCE** again or press **▲/▼** to select the input source.
 - An image from the selected source automatically displays.
 - Each time **SOURCE** is pressed, the input source toggles.

NOTE

See page 12 for external equipment connection.

MUTE

Mutes the current sound output.

Press **MUTE**.

NOTE

- Mute can be canceled by using the method below.
 - Mute will be canceled if you press **VOL +/-** or **MUTE**.

SLEEP

Allows you to set a time when the TV automatically switches to standby.

Press **SLEEP**.

- The remaining time displays when the sleep timer has been set.
- Each time you press **SLEEP**, the remaining time switches as shown below.
5, 10, 15, 30, 60, 90, 120, 180, 240, Off
- When set, the time automatically starts counting down.
- If you want to adjust the sleep timer, you can press **SLEEP** twice then change the time setting.
- One minute before the time expires, the remaining time displays every second.

NOTE

- Select "**Off**" by pressing **SLEEP** to cancel the sleep timer.
- The TV will enter standby mode (power indicator lights red) when the remaining time reaches zero.

DISPLAY

Press **DISPLAY** to show the information about the input source, TV channel, and current time.

- Press **DISPLAY** again to switch off the information screen.

VIDEO ADJ

VIDEO ADJ gives you viewing options to choose from to best match the surrounding environment of the TV, which can vary due to factors like room brightness, type of program watched or the type of image input from external equipment.

Press **VIDEO ADJ**. Current mode displays.

- Press **VIDEO ADJ** again before the mode displayed on the screen disappears to choose the desired mode.

AUDIO ADJ

AUDIO ADJ gives preset audio options to choose from to best match the program content.

Press **AUDIO ADJ** to display the current AUDIO ADJ mode.

- Press **AUDIO ADJ** again to select the option before the mode display screen disappears to choose the desired mode.

Direct Button Operation

MTS/SAP

■ MTS/SAP stereo mode

The TV has a feature that allows reception of sound other than the main audio for the program. This feature is called Multi-channel Television Sound (MTS). The TV with MTS can receive mono sound, stereo sound and Secondary Audio Programs (SAP). The SAP feature allows a TV station to broadcast other information, which could be audio in another language or something completely different like weather information.

You can enjoy Hi-Fi stereo sound or SAP broadcasts when available.

- **Stereo broadcasts:** View programs like live sporting events, shows and concerts in dynamic stereo sound.
- **SAP broadcasts:** Receive TV broadcasts in either MAIN or SAP sound.
MAIN sound: The normal program soundtrack (either in mono or stereo).
SAP sound: Listen to a second language, supplementary commentary or other information. (SAP is mono sound.)

If stereo sound is difficult to hear.

- Obtain a clearer sound by manually switching to fixed mono-sound mode.

You can change MTS as shown below to match the television broadcast signal.

Press **MTS/SAP** to toggle between audio modes.

Examples: when receiving MTS and SAP

MAIN + SAP mode: MAIN ↔ SAP

MONO mode: MONO

■ Digital broadcasting audio mode

The types of audio transmitted in a digital broadcast include SURROUND as well as MONO and STEREO. In addition, it is possible for multiple audio tracks to accompany a single video track.

Press **MTS/SAP** to toggle between audio modes.

Example: when receiving Digital broadcasting

STEREO (Audio1) → STEREO (Audio2)
← SURROUND (Audio3) ←

NOTE

MTS only operates while in TV mode.

Closed Captions and Digital Closed Captions

Your TV is equipped with an internal Closed Caption decoder. It allows you to view conversations, narration and sound effects as subtitles on your TV. Closed Captions are available on some TV programs and on some VHS home video tapes at the discretion of the program provider.

Digital Closed Caption service is a new caption service available only on digital TV programs (also at the discretion of the service provider). It is a more flexible system than the original Closed Caption system, because it allows for a variety of caption sizes and font styles. When the Digital Closed Caption service is in use, it will be indicated by the appearance of a 3-letter abbreviation that also indicates the language of the Digital Closed Captions: ENG (English), SPA (Spanish), FRA (French) or other language codes.

Not all programs and VHS videotapes offer closed captions. Please press **DISPLAY** and look for CC presence information.

In the Closed Caption system, there can be more than one caption service provided. Each is identified by its own number. The "CC1" and "CC2" services display subtitles of TV programs superimposed over the program's picture.

In the Closed Caption system, the "Text1" or "Text2" services display text that is unrelated to the program being viewed (e.g., weather or news). These services are also superimposed over the program currently being viewed.

1. Press **DISPLAY**.
This will present the Closed Caption information display.
2. Press **CC**.
This will display the current Closed Caption information. Press **CC** repeatedly to choose the mode.

CC Off → CC On → CC On With Mute
↑

NOTE

- The Digital Closed Captions feature only works when using the "TV" input of this television.
- Caption Display will not work when viewing a 480i, 480p, 720p, 1080i or 1080p input via the COMPONENT: Y-PbPr or HDMI inputs.
- Closed Captions and Digital Captions availability and content depends on the broadcaster. Closed Caption are available when the Closed Caption icon is displayed on screen.

Direct Button Operation

WIDE

You can select the screen size.

Press **WIDE**.

- You can sequentially select a viewing mode that has its own aspect ratio.

■ For TV input with SD programs

Example: Screen size images

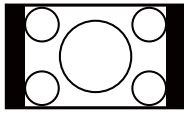
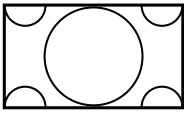
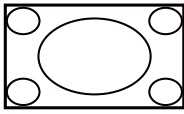
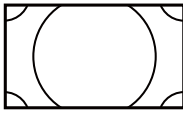
Auto	Side Bar	Stretch	S. Stretch	Zoom
 <p>Use this aspect mode to have the aspect mode change automatically by signal detector.</p>	 <p>Suitable for viewing conventional 4:3 programs in their normal format.</p>	 <p>Use these aspect modes to zoom in and to reduce the black bars.</p>	 <p>The original content in this mode has to fill the entire screen of the display.</p>	 <p>Use these aspect modes to zoom in and to reduce the black bars.</p>

■ For TV input with HD programs

Example: Screen size images

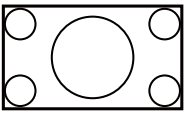
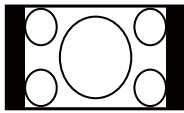
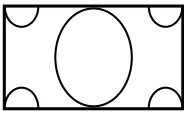
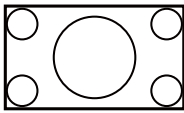
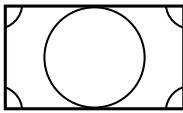
Auto	Side Bar	Stretch	S. Stretch	Zoom
 <p>Use this aspect mode to have the aspect mode change automatically by signal detector.</p>	 <p>Suitable for viewing conventional 4:3 programs in their normal format.</p>	 <p>Use these aspect modes to zoom in and to reduce the black bars.</p>	 <p>The original content in this mode has to fill the entire screen of the display.</p>	 <p>Use these aspect modes to zoom in and to reduce the black bars.</p>

■ For PC input

Example: Screen size images

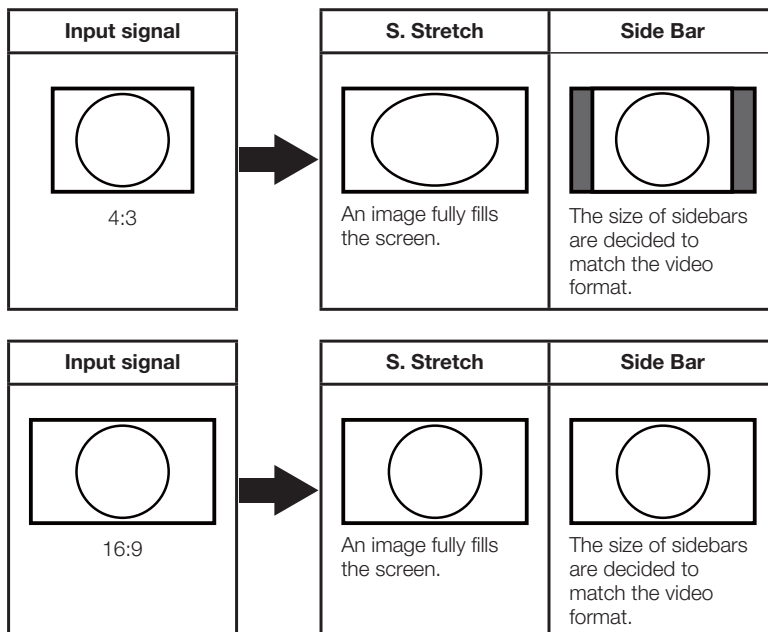

Direct Button Operation

■ For other input with SD programs

Example: Screen size images

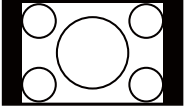
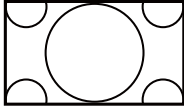
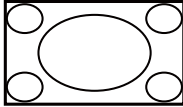
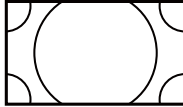
Side Bar	Stretch	S. Stretch	Zoom
 <p>Suitable for viewing conventional 4:3 programs in their normal format.</p>	 <p>Use these aspect modes to zoom in and to reduce the black bars.</p>	 <p>The original content in this mode has to fill the entire screen of the display.</p>	 <p>Use these aspect modes to zoom in and to reduce the black bars.</p>

■ For other input with HD programs

Example: Screen size images

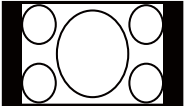
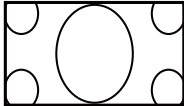
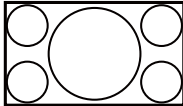
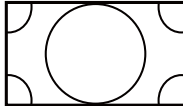
Side Bar	Stretch	S. Stretch	Zoom
 <p>Suitable for viewing conventional 4:3 programs in their normal format.</p>	 <p>Use these aspect modes to zoom in and to reduce the black bars.</p>	 <p>The original content in this mode has to fill the entire screen of the display.</p>	 <p>Use these aspect modes to zoom in and to reduce the black bars.</p>

On-Screen Display Menu

Menu Items

For TV Mode

Picture Menu

Picture Mode.....	21
Brightness.....	21
Contrast.....	21
Sharpness.....	21
Color.....	21
Tint.....	21
Color Temperature.....	21
Warm.....	21
Normal.....	21
Cool.....	21
Backlight.....	21
Aspect ratio.....	17
Auto.....	17
Side Bar.....	17
Stretch.....	17
S. Stretch.....	17
Zoom.....	17
Preset.....	21

Audio Menu

Sound Mode.....	21
Bass.....	21
Treble.....	21
Balance.....	22
Audio Source.....	22
Audio Language.....	22
SPDIF.....	22
Speaker.....	22
AVL.....	22
SRS TurSurround HD Setting.....	22
Preset.....	22

Feature Menu

Menu Language.....	22
Time.....	22
Time Mode.....	22
Time Zone.....	22
Daylight Savings.....	22
Advanced Video.....	22
Noise Reduction.....	22
Adaptive Contrast.....	22
DCR.....	22
SMP.....	22
Preset.....	22
Transparency.....	23
Password Setting.....	23
Parental Control.....	23
Button Lock.....	23
Block Unrated TV.....	23
USA Parental Locks.....	23
Canadian Parental Locks.....	24
Open V-Chip.....	24
Closed Captions.....	24
Analog Captions.....	24
Digital Captions.....	25
Digital Captions Setup.....	25
Style.....	25
Size.....	25
Font.....	25
Text Color.....	25
Text Opacity.....	25
Background Color.....	25
Background Opacity.....	25
Edge Effect.....	25
Edge Color.....	25

Input Labels.....	25
Component Setting.....	25
Phase.....	25
Preset.....	25
Reset to Default.....	25

Channel Menu

Tuning Band.....	25
Channel Strength.....	25
Auto CH Search.....	25
Add on CH Search.....	25
Channels List.....	25
Channel Labels.....	26
FAV Channel Setting.....	26

For PC Mode

Picture Menu

Brightness.....	21
Contrast.....	21
Color Temperature.....	21
Warm.....	21
Normal.....	21
Cool.....	21
Aspect ratio.....	17
S. Stretch.....	17
Side Bar.....	17
Preset.....	21

Audio Menu

Speaker.....	22
SRS TurSurround HD Setting.....	22
Preset.....	22

Feature Menu

Menu Language.....	22
Transparency.....	23
Reset to Default.....	25

VGA Menu

H-Position.....	26
V-Position.....	26
Clock.....	26
Phase.....	26
Auto Adjust.....	26
Preset.....	26

NOTE

Some menu items may not be displayed depending on the selected input source.

On-Screen Display Menu

On-Screen Display Menu Operation

Example

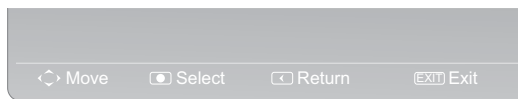
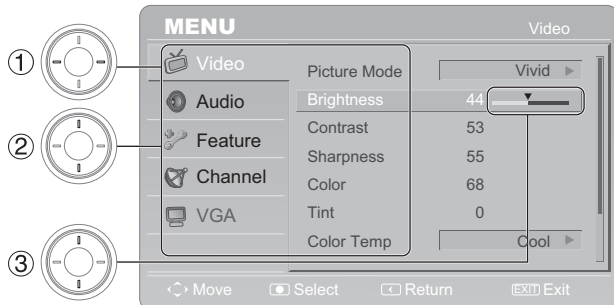

The bar above is an operational guide for the remote control. The bar will change in accordance with each menu setting screen.

- ① Press ◀/▶ to enter the desired item or return to the upper level menu.
- ② Press ▲/▼ to select the desired item.
- ③ Press ◀/▶ to adjust the item.

Example

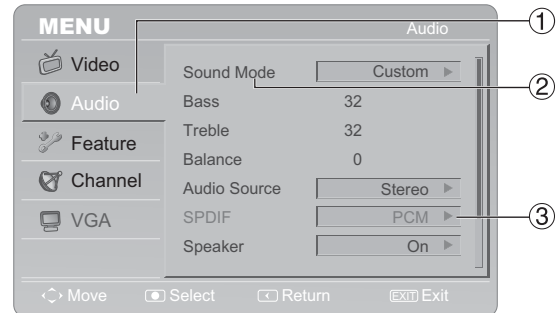

- ① Item displayed in yellow
 - This indicates the item currently selected.
 - Press ▶ to go to the adjustment screen for this item.
- ② Item displayed in blue
 - This indicates that the item can be selected.
- ③ Item displayed in gray
 - This indicates that the item cannot be selected. There are various reasons why the items cannot be selected, but the main reasons are as follows:
 - Nothing is connected to the selected input terminal.
 - The function is not compatible with the current input signal.

NOTE

Menu options differ in the selected input modes, but the operating procedures are the same.

Menu Operation Button

Using the remote control

Use the following buttons on the remote control to operate the menu.

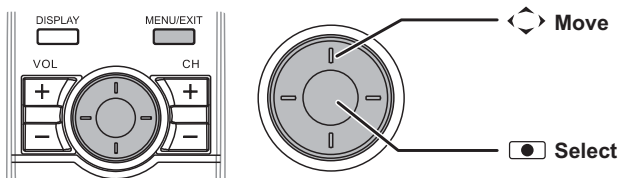

MENU/EXIT: Press to open or close the menu screen.

▲/▼/◀/▶: Press to select a desired item on the screen or adjust a selected item.

SELECT: Press to go to the next step or complete the setting.

Using the control panel of the main unit

You can also operate the menu with the control panel of the main unit.

Button operations on the control panel correspond to the ones on the remote control as shown below.

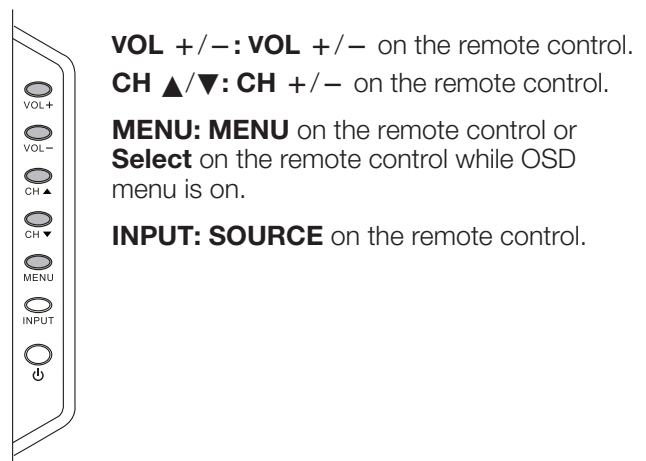

On-Screen Display Menu

Picture Menu

Adjusts the picture to your preference with the following picture settings.

Example

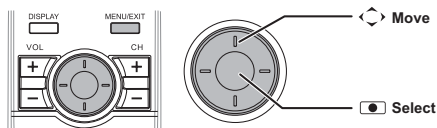
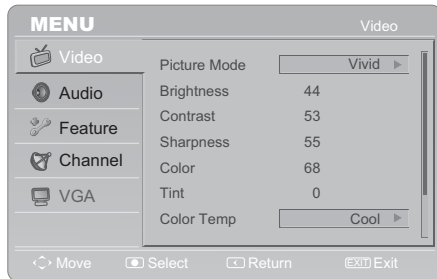

1. Press **MENU/EXIT** to display the MENU screen, and then press **▲/▼** to select "Video" and press **Select** to enter it.
2. Press **▲/▼** to select a specific adjustment item and press **Select** to enter the setting.
3. Press **◀/▶** to adjust the setting and press **Select** or **MENU/EXIT** to return to the upper level menu.
4. Press **MENU/EXIT** to exit.

Selected item	◀ button	▶ button
Brightness	For less brightness	For more brightness
Contrast	For less contrast	For more contrast
Sharpness	For less sharpness	For more sharpness
Color	For less color intensity	For more color intensity
Tint	Skin tones become reddish	Skin tones become greenish
Backlight	For brighter background	For darker background

Picture Mode

Adjust the best picture appearance from selecting the preset value of Vivid, Standard, PWR, Theater, Sport, or Custom.

Color Temperature

For a better white balance, use color temperature correction.

Warm:	White with reddish tone
Normal:	↕
Cool:	White with bluish tone

Aspect Ratio

Changes the format of the picture. (see page 17-18.)

NOTE

Video settings (Sharpness, Color, Tint, and Backlight) are limited when viewing a PC signal input through the HDMI terminal.

Preset

Restore the default picture settings.

Audio Menu

Adjusts the sound quality to your preference with the following settings.

Example

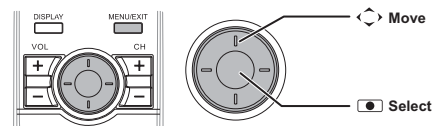
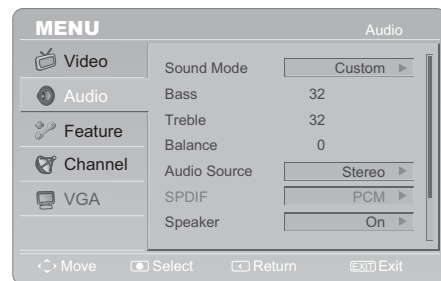

1. Press **MENU/EXIT** to display the MENU screen, and then press **▲/▼** to select "Audio" and press **Select** to enter it.
2. Press **▲/▼** to select a specific adjustment item and press **Select** to enter the setting.
3. Press **◀/▶** to adjust the setting and press **Select** or **MENU/EXIT** to return to the upper level menu.
4. Press **MENU/EXIT** to exit.

Sound Mode

Selects the modes for more spatial or surround sound reproduction depend on the broadcast signals or signals for external inputs received.

Use **▶** to toggle between, "Custom", "Standard", "Movie", and "News" and press **Select** or **MENU/EXIT** to return to upper level.

Bass

Adjust the bass tone from the tuning range 0 to 63.

Treble

Adjust the treble tone from the tuning range 0 to 63.

On-Screen Display Menu

Balance

Adjust audio balance from the tuning range L50 to R50

Audio Source

Use ► to toggle between “Stereo”, “Mono” and second audio program “SAP”, when it is available in analog channel.

Audio Language

Gives you the possibility to swap between main and alternative language, when it is available in digital channel.

SPDIF

Select digital audio output format from RAW and PCM.

Speaker

Choose to turn on / off the TV internal speaker. The digital audio output signals and earphone output signals will not be turned off even though the TV speaker is off. The default setting is On.

AVL

Automatically reduces the volume difference between channels and programs. Use ◀/▶ to toggle between “On” or “Off”.

SRS TurSurround HD Setting

Solutions of processing surround sound effect for playback over two speakers. Select **On** for optimizing bass/treble performance and intelligibility. Select **Off** for keeping current audio performance level.

Preset

Restore the default audio settings.

Feature Menu

Example

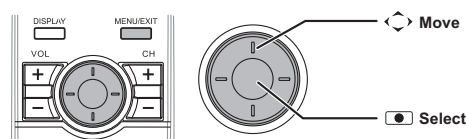
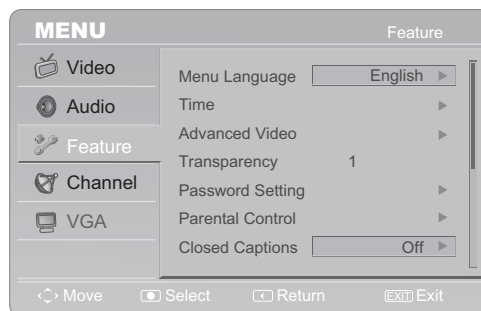

1. Press **MENU/EXIT** to display the MENU screen, and then press ▲/▼ to select “Feature” and press **Select** to enter it.
2. Press ▲/▼ to select a specific adjustment item and press **Select** to enter the setting.
3. Press ◀/▶ to select the setting and press **Select** or **MENU/EXIT** to return to the upper level menu.
4. Press **MENU/EXIT** to exit.

Menu Language

Select the menu display language. (English / Français / Español)

Time

Set current time. The sub-menu includes Time Mode, Time Zone and Daylight Savings.

Time Mode: Choose from Auto or Manual. You can set the Year, Month, Day, and Time as you selecting “Manual”.

Time Zone: Set current time zone.

Daylight Savings: Set to On or Off.

Advanced Video

Provide the Noise Reduction, Adaptive Contrast, DCR, and SMP for enhancing video quality.

Noise Reduction: Gives four NR effect degrees, such as: Low, Mid, High and Off. The default setting is Mid.

Adaptive Contrast: Choose On or off to adjust the brightness and contrast after analyzing the input signal automatically.

DCR: Dynamic Contrast Ratio (DCR) auto adjusts the brightness of the screen. Set to On or Off.

SMP: SMP means “Smart Motion Plus”, gives four motion effect degrees, such as: Low, Mid, High and Off. The default setting is Mid.

Preset: Restore the default advanced video option settings.

On-Screen Display Menu

Transparency

Adjust the transparency of the on-screen menu from range 0 to 10.

Password Setting

1. Enter a 4-digit PIN with the number buttons on the remote control.
If you have a PIN, enter your current PIN.
If you have lose your PIN, enter master code 0711.
2. Enter your new 4-digit PIN and then enter it again to confirm.

Parental Control

Controls special functions for the TV channels.

Example

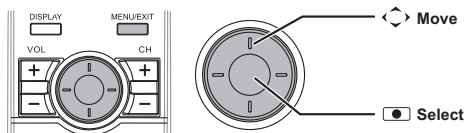
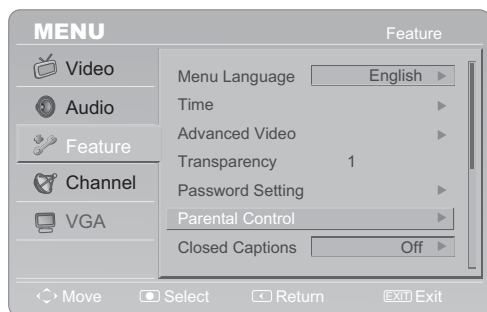

1. Press **MENU/EXIT** to display the MENU screen, and then press **▲/▼** to select "Feature" and press **Select** to enter it.
2. Press **▲/▼** to select "Parental Control" and press **Select** to enter the setting. Enter the password to enter the Parental Control.
3. Press **▲/▼** to select the setting and press **Select** or **MENU/EXIT** to return to the upper level menu.
4. Press **MENU/EXIT** to exit.

Button Lock

Select On or Off to lock or unlock the control buttons on the side panel of the TV. When this function enables, the control buttons on your TV will be locked and TV will be controlled by remote control only.

Block Unrated TV

When Block Unrated TV is set to on, the channel can not be selected using the CH+/- and the number buttons.

USA Parental Locks

Your TV is equipped with a V-chip that allows you to control access to individual programs based on their age rating and content rating. The program content

advisory data are sent by the broadcaster or by the program provider.

If you are receiving channels through a set-top box or cable receiver box connected by HDMI, you cannot use the TV ratings lock. Your set-top box or cable receiver box must be connected through RF or AV connectors.

Age rating	Content rating
All	None
None	None
TV-Y Appropriate for children of all ages with themes and elements suitable for children aged 2-6.	None
TV-Y7 Programs designed for children age 7 and older.	Fantasy Violence (FV)
TV-G Programs suitable for all ages. These programs contain little or no violence, no strong language and little or no sexual dialog or situations.	None
TV-PG Programs contain elements that some parents may find unsuitable for younger children and which may need parental guidance. The program may contain moderate violence, sexual dialog and/or situations and some strong language.	Dialog (D) Language (L) Sex (S) Violence (V)
TV-14 Programs contain elements that may not be suitable for children under 14 years of age. These programs include one or more of the following: intense violence, intense sexual situations, suggestive dialog and strong language.	Dialog (D) Language (L) Sex (S) Violence (V)
TV-MA Programs are designed to be viewed by adults and may be unsuitable for children under the age of 17. These programs may contain graphical violence, explicit sexual activity and/or crude or indecent language.	Language (L) Sex (S) Violence (V)

This section describes how to control viewing of movies based on their Motion Picture Association of America (MPAA) rating.

Movie rating	Description
All	None.
None	None.
G	General audiences. All ages admitted.
PG	Parental guidance suggested. Some material may not be suitable for children.
PG-13	Parents strongly cautioned. Some material may be inappropriate for children under 13.
R	Restricted. Under 17 requires accompanying parent or adult guardian (age varies in some jurisdictions).
NC-17	No one 17 and under admitted.
X	X is an older rating that is unified with NC-17 but may be encoded in the data of older movies.

On-Screen Display Menu

Canadian Parental Locks

Canadian Rating Systems (Canadian English ratings and Canadian French ratings).

- The TV rating systems in Canada are based on the Canadian Radio-Television and Telecommunications Commission (CRTC) policy on violence in television programming.
- While violence is the most important content element to be rated, the structure developed takes into consideration other program content like language, nudity, sexuality and mature themes.
- When setting the V-CHIP on the Canadian system you can choose either the Canadian English ratings or the Canadian French ratings.

Canadian English Ratings

Movie rating	Description
E	Exempt: Includes news, sports, documentaries and other information programming; talk shows, music videos, and variety programming.
C	Children: Intended for younger children under the age of 8 years. Pays careful attention to themes that could threaten their sense of security and well-being.
C8+	Children over 8 years old: Contains no portrayal of violence as the preferred, acceptable, or only way to resolve conflict; nor encourage children to imitate dangerous acts which they may see on the screen.
G	General: Considered acceptable for all age groups. Appropriate viewing for the entire family, contains very little violence, physical, verbal or emotional.
PG	Parental Guidance: Intended for a general audience, but may not be suitable for younger children (under the age of 8) because it could contain controversial themes or issues.
14+	Over 14 years: Could contain themes where violence is one of the dominant elements of the storyline, but it must be integral to the development of plot or character. Language usage could be profane and nudity present within the context of the theme.
18+	Adults: Intended for viewers 18 years and older and might contain depictions of violence, which while related to the development of plot, character or themes, are intended for adult viewing. Could contain graphic language and portrayals of sex and nudity.

Canadian French Ratings

Movie rating	Description
E	Exempt programming.
G	General: All ages and children, contains minimal direct violence, but may be integrated into the plot in a humorous or unrealistic manner.
8ans+	General but inadvisable for young children: May be viewed by a wide public audience, but could contain scenes disturbing to children under 8 who cannot distinguish between imaginary and real situations. Recommended for viewing with parent.
13ans+	Over 13 years: Could contain frequent violent scenes and therefore recommended for viewing with parent.
16ans+	Over 16 years: Could contain frequent violent scenes and intense violence.
18ans+	Over 18 years: Only for adult viewing. Could contain frequent violent scenes and extreme violence.

Open V-Chip

The inhibitive channels or source signals can be unlock.

Closed Captions

This displays the transmitted CC- or CS-text on the screen according to your chosen CC or CS service. This text can either be permanently displayed (assuming that the service is available in the broadcast) or only when mute is active.

Use ► to toggle between “Off”, “On”, and “With Mute”. (See page 16.)

Analog Captions

This allows you to select the Closed captions service levels of analog broadcasting to be displayed. Closed captioning allows you to read the voice content of television programs on the TV screen. Designed to help the hearing impaired, this feature uses on-screen “text boxes” to show dialogue and conversations while the TV program is in progress. Captions will appear on the screen during captioned broadcasts.

- CC1,2,3 or 4
Dialogue (and descriptions) for the action on the captioned TV program shows on screen. Usually CC1 is the most used. CC2 can be used for alternate languages if they are being transmitted.
- TEXT1,2,3 or 4
Often used for channel guide, schedules, bulletin board information for Closed captions programs, news, weather informations or stock market reports. Not all Caption services are necessarily being used by a TV channel during the transmission of a Closed caption program.

On-Screen Display Menu

Digital Captions

This allows you to configure the way you choose to view digital captioning. Select one of the digital service channels made available by the caption provider. There are six standard services. SERVICE 1 is designated as the Primary Caption Service. This service contains the verbatim, or near-verbatim captions for the primary language being spoken in the accompanying program audio. SERVICE 2 is designated as the Secondary Language Service. This service contains captions in a secondary language, which is a translation of the captions in the primary Caption Service. The other service sub channels are not pre-assigned. It is up to the discretion of the individual caption provider to utilize the remaining service channels.

Digital Captions Setup

This allows you to modify how digital captions are displayed on your TV. Select from the following options to change the visual characteristics of the TV's digital captioning

Style: Set to Automatic or Customer mode. If Customer mode is selected, user can modify the detail styles described below. The setting result will be shown immediately on the bottom of the sub-menu OSD. Note: This feature is only available in Digital TV (ATSC) mode.

Size: Selects this option to choose a caption display size according to your own preference. Select "Automatic", "Small", "Normal", or "Large".

Font: Select digital closed caption font style.

Text Color: Choose the caption display text color.

Text Opacity: Select the text opacity.

Background Color: Choose caption display character background color.

Background Opacity: Choose one of the background opacity options.

Edge Effect: Choose one of the edge effect options.

Edge Color: Select one of the caption display edge colors.

Input Labels

User can edit the input labels.

Component Setting

This option only shows and is available in component mode, which provides fine tuning component display.

Phase: Adjust picture phase to reduce horizontal-line noise. The tuning range is from 0 to 100.

Preset: Restore the default component setting values.

Reset to Default

Restore all the default feature settings.

Channel Menu

Example

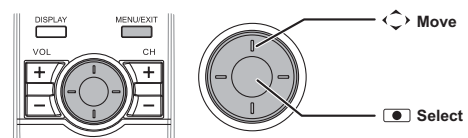
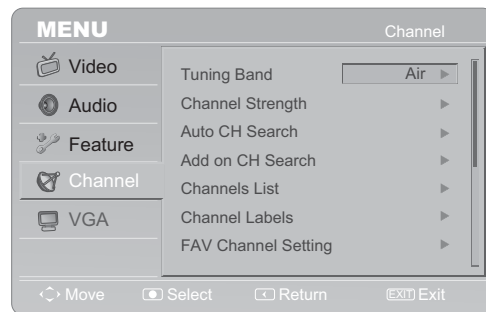

1. Press **MENU/EXIT** to display the MENU screen, and then press **▲/▼** to select "Channel" and press **Select** to enter it.
2. Press **▲/▼** to select a specific item and press **Select** to enter the setting.
3. Press **MENU/EXIT** to exit.

Tuning Band

Select TV source signal from the Air (antenna) or Cable (CATV).

Channel Strength

Show the intensity of the received DTV signal.

Auto CH Search

If initial setup does not memorize all the channels in your region, follow the instructions below to manually memorize the channels.

Air/Cable: Make sure what kind of connection is made with your TV when selecting Air or Cable.

- When Air is selected, the TV detects antenna signals. It searches for NTSC and ATSC channels available in your area.
- When Cable is selected, the TV detects signals supplied by cable. It searches for NTSC, ATSC, and QAM modulated channels available in your area.

Add on CH Search

Search channels which are new found.

Channels List

Show the channel List. User can edit (add/delete) the channel numbers.

On-Screen Display Menu

Channel Labels

Show the NTSC / ATSC TV channel label menu for user modifying channel labels specifically.

FAV Channel Setting (only in TV mode)

This function allows you to program 50 favorite channels. By setting the favorite channels in advance, you can select your favorite channels easily.

To register your favorite channel:

1. Press **MENU/EXIT** on the remote control and select "Channel"/"FAV Channel Setting".
2. Press **▲/▼** to select your desired channel and press **▶** or the **Select** button to confirm.

To delete your favorite channel:

1. Press **MENU/EXIT** on the remote control and select "Channel"/"FAV Channel Setting".
2. Press **▲/▼** to select "All data clear" and press **▶** to start clearing all favorite channel data.

NOTE

- Before setting the channel, select the channel you want to register as a favorite channel.

VGA Menu

This option only shows and is available in VGA mode, which provides several items for the VGA display fine tuning.

H-Position: Adjust the horizontal placement of the picture.

V-Position: Adjust the vertical placement of the picture.

Clock: Eliminates the vertical interfering lines.

Phase: Eliminates the horizontal interfering lines.

Auto Adjust: Automatically adjusts picture to the best image position, phase, and clock setting.

Preset: Restore the default VGA setting values.

Appendix

Troubleshooting

Problem	Possible Solution
<ul style="list-style-type: none"> No power 	<ul style="list-style-type: none"> Check if you pressed POWER on the remote control unit. (See page 13.) If the indicator on the TV does not light up, press POWER on the TV. Is the AC cord disconnected? (See page 7.) Has the power been turned on? (See page 13.)
<ul style="list-style-type: none"> Unit cannot be operated. 	<ul style="list-style-type: none"> External influences such as lightning, static electricity, may cause improper operation. In this case, operate the unit after first turning off the power of the TV or unplugging the AC cord and re-plugging it after 1 or 2 minutes.
<ul style="list-style-type: none"> Remote control unit does not operate. 	<ul style="list-style-type: none"> Is the SOURCE set correctly? Set it to the TV setting position. Are batteries inserted with polarity (+, -) aligned? (See page 8.) Are batteries worn out? (Replace with new batteries.) Are you using it under strong or fluorescent lighting? Is a fluorescent light illuminated near the remote control sensor?
<ul style="list-style-type: none"> Picture is cut off/with sidebar screen. 	<ul style="list-style-type: none"> Are screen mode adjustments such as picture size made correctly? (See page 17-18.)
<ul style="list-style-type: none"> Strange color, light color, or color misalignment 	<ul style="list-style-type: none"> Adjust the picture tone. (See page 21.) Is the room too bright? The picture may look dark in a room that is too bright. Check the input signal setting. (See page 25.)
<ul style="list-style-type: none"> Power is suddenly turned off. 	<ul style="list-style-type: none"> Is the sleep timer set? (See page 15.) The unit's internal temperature has increased. Remove any objects blocking vent.
<ul style="list-style-type: none"> No picture 	<ul style="list-style-type: none"> Is connection to other components correct? (See page 12.) Is correct input signal source selected after connection? (See page 15.) Is the correct input selected? (See page 15.) Is picture adjustment correct? (See page 21.)
<ul style="list-style-type: none"> No sound 	<ul style="list-style-type: none"> Is the volume too low? (See page 15.) Have you pressed MUTE on the remote control unit? (See page 15.)
<ul style="list-style-type: none"> The TV sometimes makes a cracking sound. 	<ul style="list-style-type: none"> This is not a malfunction. This happens when the cabinet slightly expands and contracts according to change in temperature. This does not affect the TV's performance.

Cautions regarding use in high and low temperature environments

- When the unit is used in a low temperature space (e.g. room, office), the picture may leave trails or appear slightly delayed. This is not a malfunction, and the unit will recover when the temperature returns to normal.
- Do not leave the unit in a hot or cold location. Also, do not leave the unit in a location exposed to direct sunlight or near a heater, as this may cause the cabinet to deform and the Liquid Crystal panel to malfunction.
Storage temperature: -4°F to +140°F (-20°C to +60°C)

Appendix

Specifications

Item		Model: LC-47SB57UT		
LCD panel		a-si TFT LCD 47o Class (46 ⁶¹ / ₆₄ " Diagonal)		
Resolution		2,073,600 pixels (1,920 x 1,080)		
TV Function	TV-standard (CCIR)		American TV Standard ATSC/NTSC System	
	Receiving Channel	VHF/UHF	VHF 2-13ch, UHF 14-69ch	
		CATV	1-125ch (non-scrambled channel only)	
		Digital Terrestrial Broadcast (8VSB)	2-69ch	
		Digital cable*1 (64/256 QAM)	1-135ch (non-scrambled channel only)	
Audio multiplex		BTSC System		
Backlight		60,000 hours (at Backlight Standard position)		
Audio out		8W x 2		
Terminals	Rear	COMPONENT 1	COMPONENT in, AUDIO in	
		COMPONENT 2	COMPONENT in, AUDIO in	
		HDMI 1	HDMI in with HDCP, Audio in (Ø 3.5mm jack)	
		HDMI 2	HDMI in with HDCP	
		PC IN	15-pin mini D-sub female connector, Audio in (Ø 3.5mm jack)	
		ANT/CABLE	75 q Unbalance, F Type x 1 for Analog (VHF/UHF/CATV) and Digital (AIR/CABLE)	
		DIGITAL AUDIO OUTPUT	Digital audio output x 1 (PCM/Dolby Digital)	
	Side	AV IN 2	AV in, S-VIDEO in	
		HDMI 3	HDMI in with HDCP	
		HDMI 4	HDMI in with HDCP	
		SERVICE PORT	Software update	
	OSD language		English/French/Spanish	
	Power Requirement		AC 120 V, 60 Hz	
Power Consumption		210 W (<1 W Standby with AC 120 V)		
Weight	TV + stand	52.69 lbs./23.9 kg		
	TV only	44.09 lbs./20.0 kg		
Dimension*2 (W X H X D)	TV + stand	44 ⁹ / ₃₂ X 30 ⁷ / ₃₂ X 12 ⁴ / ₃₂ inch		
	TV only	44 ⁹ / ₃₂ X 28 ³ / ₃₂ X 4 ¹ / ₃₂ inch		
Operating temperature		32°F to + 104°F (0°C to + 40°C)		

*1 Emergency alert messages via Cable are unreceivable.

*2 The dimensional drawings are shown on the inside back cover.

- As part of policy of continuous improvement, SHARP reserves the right to make design and specification changes for product improvement without prior notice. The performance specification figures indicated are nominal values of production units. There may be some deviations from these values in individual units.

Appendix

PC Compatibility Chart

It is necessary to set the PC correctly to display XGA and WXGA signal. Refer to page 12 to set PC input signals.

PC	Resolution		Horizontal Frequency	Vertical Frequency	VESA Standard
PC	VGA	720 x 400	31.469 kHz	70.087 Hz	—
		640 x 480	31.469 kHz	59.940 Hz	○
			37.861 kHz	72.809 Hz	○
			37.500 kHz	75.000 Hz	○
	SVGA	800 x 600	35.156 kHz	56.250 Hz	○
			37.879 kHz	60.317 Hz	○
			48.077 kHz	72.188 Hz	○
			46.875 kHz	75.000 Hz	○
	XGA	1024 x 768	48.363 kHz	60.004 Hz	○
			56.476 kHz	70.069 Hz	○
			60.023 kHz	75.029 Hz	○
	WXGA	1280 x 768	47.396 kHz	59.995 Hz	○
	SXGA	1280 x 1024	63.981 kHz	60.020 Hz	○
WXGA	1440 x 900	55.469 kHz	59.901 Hz	○	
WSXGA+	1680 x 1050	65.290 kHz	59.954 Hz	○	
HDMI	Resolution		Horizontal Frequency	Vertical Frequency	Pixel Clock Freq.
HDMI	VGA	640 x 480	31.469 kHz	60.000 Hz	25.175 MHz
	SVGA	800 x 600	37.879 kHz	60.000 Hz	40.000 MHz
	XGA	1024 x 768	48.363 kHz	60.000 Hz	65.000 MHz
	WXGA	1280 x 768	47.712 kHz	60.000 Hz	85.500 MHz
	1080P	1920 x 1080P	67.500 kHz	60.000 Hz	148.500 MHz
	720P	1280 x 720P	45.000 kHz	60.000 Hz	74.250 MHz
	1080i	1920 x 1080i	33.750 kHz	60.000 Hz	74.250 MHz
	480P	720 x 480P	31.500 kHz	60.000 Hz	27.030 MHz
480i	720 x 480i	15.750 kHz	60.000 Hz	13.510 MHz	
SD/HD	Resolution		Horizontal Frequency	Vertical Frequency	Pixel Clock Freq.
SD/HD	720P	1280 x 720P	45.000 kHz	60.000 Hz	74.250 MHz
	1080i	1920 x 1080i	33.750 kHz	60.000 Hz	74.250 MHz
	480P	720 x 480P	31.500 kHz	60.000 Hz	27.030 MHz
	480i	720 x 480i	15.750 kHz	60.000 Hz	13.510 MHz

DDC is a registered trademark of Video Electronics Standards Association.

Information on the Software License for This Product

■ Software composition

The software included in this product is comprised of various software components whose individual copyrights are held by SHARP or by third parties.

■ Software developed by SHARP and open source software

The copyrights for the software components and various relevant documents included with this product that were developed or written by SHARP are owned by SHARP and are protected by the Copyright Act, international treaties, and other relevant laws. This product also makes use of freely distributed software and software components whose copyrights are held by third parties. These include software components covered by a GNU General Public License (hereafter GPL), a GNU Lesser General Public License (hereafter LGPL) or other license agreement.

■ Obtaining source code

Some of the open source software licensors require the distributor to provide the source code with the executable software components. GPL and LGPL include similar requirements. For information on obtaining the source code for the open source software and for obtaining the GPL, LGPL, and other license agreement information, visit the following website:

<http://www.sharpusa.com/gpl>

We are unable to answer any questions about the source code for the open source software. The source code for the software components whose copyrights are held by SHARP is not distributed.

Appendix

Acknowledgements

The following open source software components are included in this product:

- linux kernel/busybox/uClibc/zlib/libpng/libjpeg

CLEARING THE SECRET NUMBER

If you forget the secret number, clear the secret number using the following procedure.

1. Press **MENU/EXIT** to display the MENU screen, and then press **▲/▼** to select "Feature" and press **▶** to enter it.
2. Press **▲/▼** to select "Password Setting" and press 3448 as a master code.
3. Enter a new PIN. (See page 23.)

The secret number is .

NOTE

- As a precautionary measure, make a note of your secret number above, cut it from this manual, and keep it in a safe place.

Legal notices

FCC Part 15

This device complies with Part 15 of the FCC Rules. Operation of this product is subject to the following two conditions: (1) this device may not cause harmful interference, and (2) this device must accept any interference received, including interference that may cause undesired operation.

This equipment has been tested and found to comply within the limits for a class B digital device, pursuant to Part 15 of the FCC Rules. These limits are designed to provide reasonable protection against harmful interference in a residential installation. This equipment generates, uses, and can radiate radio frequency energy and, if not installed and used in accordance with the instructions, may cause harmful interference to radio communications. However, there is no guarantee that interference will not occur in a particular installation. If this equipment does cause harmful interference to radio or television reception, which can be determined by turning the equipment off and on, the user is encouraged to try to correct the interference by one or more of the following measures:

- Reorient or relocate the receiving antenna.
- Increase the separation between the equipment and receiver.
- Connect the equipment into an outlet on a circuit different from that to which the receiver is connected.
- Consult the dealer or an experienced radio/TV technician for help.

FCC warning

Changes or modifications not expressly approved by the party responsible for compliance with the FCC Rules could void the user's authority to operate this equipment.

Cables

Connections to this device must be made with shielded cables with metallic RF/EMI connector hoods to maintain compliance with FCC Rules and Regulations.

Canadian notice

This Class B digital apparatus complies with Canadian ICES-003.

Cet appareil numérique de la classe B est conforme à la norme NMB-003 du Canada.

"Standard Television Receiving Apparatus-Appareil de reception télévision ordinaire, Canada BETS-7 / NTMR-7".

Dolby License Notice and Trademark Acknowledgement



Manufactured under license from Dolby Laboratories. "Dolby" and the double-D symbol are trademarks of Dolby Laboratories.

HDMI



HDMI, the HDMI logo, and High-Definition Multimedia Interface are trademarks or registered trademarks of HDMI Licensing LLC.

SRS TruSurround HD



is a trademark of SRS Labs, Inc.

TruSurround HD technology is incorporated under license from SRS Labs, Inc.

Calling for Service

For location of the nearest Sharp Authorized Service, or to obtain product literature, accessories, supplies, or customer assistance, please call 1-800-BE-SHARP.

LIMITED WARRANTY

CONSUMER LIMITED WARRANTY

SHARP ELECTRONICS CORPORATION warrants to the first consumer purchaser that this Sharp brand Liquid Crystal Display product (the "Product"), when shipped in its original container, will be free from defective workmanship and materials, and agrees that it will, at its option, either repair the defect or replace the defective Product or part thereof with a new or remanufactured equivalent at no charge to the purchaser for parts or labor for the period(s) set forth below.

This warranty does not apply to any appearance items of the Product or if the serial number or model number affixed to the Product has been removed, defaced, changed, altered or tampered with. This warranty does not cover installation or signal reception problems. This limited warranty will not apply if the Product has been or is being used in a commercial setting or application; this warranty is meant solely for the non-commercial, household use of the Product by consumers in their home or residence. If you intend to or already use this Product for commercial purposes or in a commercial setting, there are warranties available to cover your use of this Product, the terms of which may vary. Please contact **1-888-GO-SHARP** for further information.

In order to enforce your rights under this limited warranty, you should follow the steps set forth below. You must be able to provide proof of purchase to the servicer, which proof must include the date of purchase.

To the extent permitted by applicable state law, the warranties set forth are in lieu of, and exclusive of, all other warranties, express or implied. Specifically ALL OTHER WARRANTIES OTHER THAN THOSE SET FORTH ABOVE ARE EXCLUDED, ALL EXPRESS AND IMPLIED WARRANTIES INCLUDING THE WARRANTIES OF MERCHANTABILITY, FITNESS FOR USE, AND FITNESS FOR A PARTICULAR PURPOSE ARE SPECIFICALLY EXCLUDED. IF, UNDER APPLICABLE STATE LAW, IMPLIED WARRANTIES MAY NOT VALIDLY BE DISCLAIMED OR EXCLUDED, THE DURATION OF SUCH IMPLIED WARRANTIES IS LIMITED TO THE PERIOD(S) FROM THE DATE OF PURCHASE SET FORTH BELOW. THIS WARRANTY GIVES YOU SPECIFIC LEGAL RIGHTS. YOU MAY ALSO HAVE OTHER RIGHTS WHICH VARY FROM STATE TO STATE.

The warranties given herein shall be the sole and exclusive warranties granted by Sharp and shall be the sole and exclusive remedy available to the purchaser and only for the time periods set forth herein. No other representations or promises made by anyone are permitted. Correction of defects, in the manner and for the period of time described herein, shall constitute complete fulfillment of all liabilities and responsibilities of Sharp to the purchaser with respect to the Product, and shall constitute full satisfaction of all claims, whether based on contract, negligence, strict liability or otherwise. Sharp does not warrant nor shall Sharp be liable, or in any way responsible, for Products which have been subject to abuse (including, but not limited to, improper voltage), accident, misuse, negligence, lack of reasonable care, alteration, modification, tampering, misuse, improper operation or maintenance or any damages or defects in the Product which were caused by repairs or attempted repairs performed by anyone other than a Sharp authorized servicer. Nor shall Sharp be liable or in any way responsible for any incidental or consequential economic or property damage. Some states do not allow limits on warranties or on remedies for breach in certain transactions; in such states, the limits herein may not apply.

THIS LIMITED WARRANTY IS VALID ONLY IN THE FIFTY (50) UNITED STATES, THE DISTRICT OF COLUMBIA AND PUERTO RICO.

Model Specific Section

Your Product Model Number & Description:

LC-47SB57UT LCD Color Television

(Be sure to have this information available when you need service for your Product.)

Warranty Period for this Product:

One (1) year parts and labor from the date of purchase.

Additional Exclusions from Warranty Coverage (if any):

In order for the Product to be serviced, the Product must be readily available to the servicer, free and clear of any complex or non-standard installation, mounting or other encumbrance which would unreasonably interfere with servicing the Product. The Servicer will remount the Product after service, provided that such remounting is not into a complex or non-standard installation. Any additional labor and materials required to remove and/or reinstall a Product above and beyond the foregoing are not covered by this warranty, may result in additional charges and are the responsibility of the consumer. Image Retention resulting from a fixed image being displayed for long periods of time is not covered by this Limited Warranty (see Operation Manual on how to prevent this).

Where to Obtain Service:

From a Sharp Authorized Servicer located in the United States. To find the location of the nearest Sharp Authorized Servicer, please call Sharp toll free at 1-800-BE-SHARP.

What to do to Obtain Service:

Contact your Sharp Authorized Servicer to obtain in home service for this product. The Servicer will come to your location and if necessary remove the unit for repair at the Servicer's facility and return the set to you once completed. Be sure to have **Proof of Purchase** available.

TO OBTAIN PRODUCT INFORMATION OR PURCHASE ACCESSORIES AND EXTENDED WARRANTIES, CALL **1-800-BE-SHARP** OR VISIT www.sharpsusa.com

SHARP®

SHARP ELECTRONICS CORPORATION

Sharp Plaza, Mahwah, New Jersey 07495-1163

SHARP CORPORATION

Dimensional Drawings

LC-47SB57UT

Unit: inch/(mm)

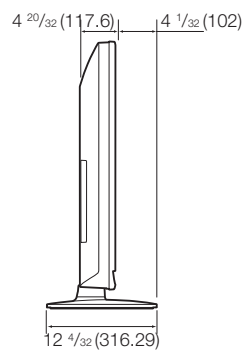
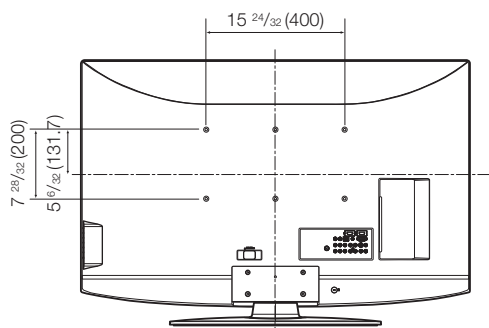
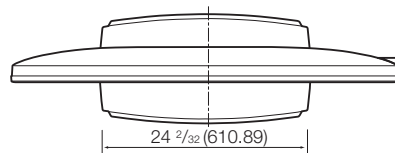
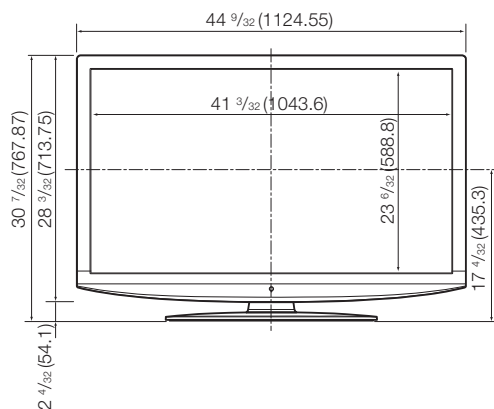

SHARP®

SHARP ELECTRONICS CORPORATION

Sharp Plaza, Mahwah, New Jersey 07495-1163

SHARP CORPORATION

Printed in China
Imprimé au Chine
Impreso en China
TBD

Free Manuals Download Website

<http://myh66.com>

<http://usermanuals.us>

<http://www.somanuals.com>

<http://www.4manuals.cc>

<http://www.manual-lib.com>

<http://www.404manual.com>

<http://www.luxmanual.com>

<http://aubethermostatmanual.com>

Golf course search by state

<http://golfingnear.com>

Email search by domain

<http://emailbydomain.com>

Auto manuals search

<http://auto.somanuals.com>

TV manuals search

<http://tv.somanuals.com>