

SHARP

HOME CINEMA SYSTEM

MODEL

AN-PR1000H

OPERATION MANUAL

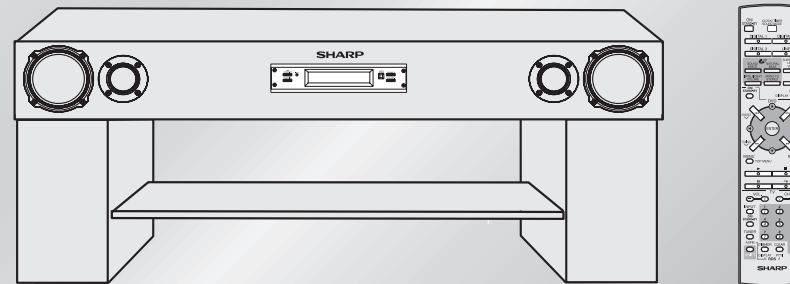

Thank you for purchasing this SHARP product. To obtain the best performance from this product, please read this manual carefully. It will guide you in operating your SHARP product.



Special Notes

"DTS" and "DTS Digital Surround" are registered trademarks of Digital Theatre Systems, Inc.

Manufactured under license from Dolby Laboratories. "Dolby", "Pro Logic", the double-D symbol, Audistry and the sound shell logo are trademarks of Dolby Laboratories.

Warning:

- When the ON/STAND-BY button is set at STAND-BY position, mains voltage is still present inside the unit. When the ON/STAND-BY button is set at STAND-BY position, the unit may be brought into operation by the remote control.
- This unit contains no user serviceable parts. Never remove covers unless qualified to do so. This unit contains dangerous voltages, always remove mains plug from the socket before any service operation and when not in use for a long period.
- To prevent fire or shock hazard, do not expose this appliance to dripping or splashing. No objects filled with liquids, such as vases, shall be placed on the apparatus.

Contents

	Page
■ General Information	
Accessories	3
Precautions	4
Controls and indicators	5 - 9
■ Preparation for Use	
System connections	10 - 12
Falling prevention	13
Audio connections to TVs, DVD players, VCRs, etc.	14 - 16
AC power connection	16
Remote control	17
General control	18
Setting the clock	19
■ Basic Operation	
Listening to the playback sound from DVD players, VCRs, etc.	20
Enjoying surround sound (sound mode)	21 - 25
■ Radio	
Listening to the radio.	26 - 27
■ Advanced Features	
Using the Radio Data System (RDS)	28 - 31
Timer and sleep operation	32 - 34
Operating the TV or DVD player with the remote control	35 - 36
Changing the manufacturer setting of the remote control	37 - 38
■ References	
Troubleshooting chart	39 - 40
Error indicators and warnings	40
Maintenance	41
Specifications	41
WARRANTY	Back Cover

Accessories

AN-PR1000H

Please confirm that the following accessories are included.

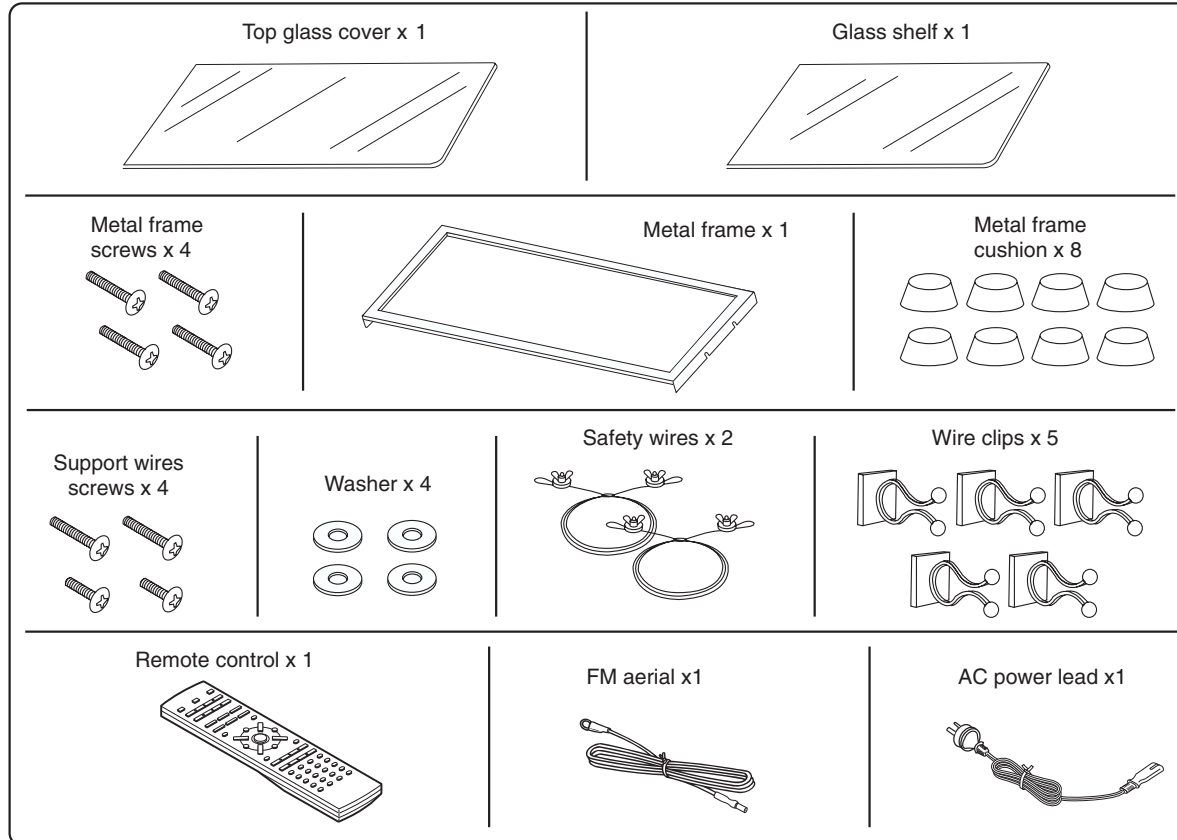
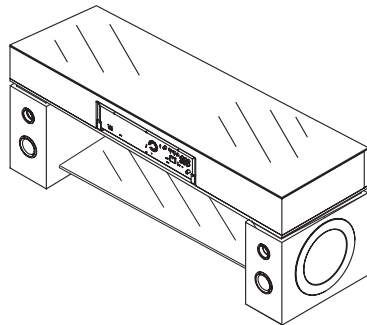
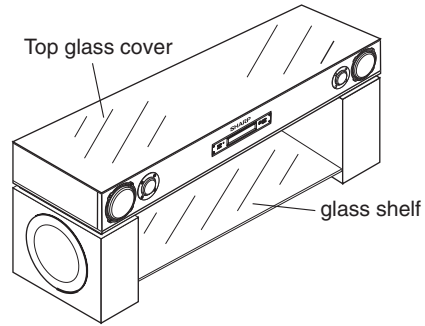

Caution:

Do not use the supplied AC power lead for other equipment. Fire or electric shock may result.

Note:

Only the above accessories are included.

General Information

Precautions

■ General

- Use the unit on a firm, level surface free from vibration.
- Keep the unit away from direct sunlight, strong magnetic fields, excessive dust, humidity and electronic/electrical equipment (home computers, facsimiles, etc.) which generate electrical noise.
- Do not expose the unit to moisture, to temperatures higher than 60°C (140°F) or to extremely low temperatures.

- If the unit does not work properly, unplug and plug it in again. Then turn on the unit.
- In case of an electrical storm, unplug the unit for safety.

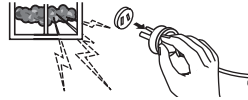

- Hold the AC power plug by the head when removing it from the wall socket, as pulling the lead can damage internal wires.
- The AC power plug is used as disconnect device and shall always remain readily operable.

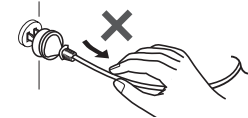

- Do not remove the outer cover, as this may result in electric shock. Refer internal service to your local SHARP service facility.
- The ventilation should not be impeded by covering the ventilation openings with items, such as newspapers, tablecloths, curtains, etc.
- No naked flame sources, such as lighted candles, should be placed on the apparatus.
- Attention should be drawn to the environmental aspects of battery disposal.
- This unit should only be used within the range of 5°C - 35°C (41°F - 95°F).

Warning:

The voltage used must be the same as that specified by this unit. Using this product with a higher voltage other than that specified is dangerous and may result in a fire or other types of accident, causing damage. SHARP will not be held responsible for any damage resulting from the use of this unit with a voltage other than that specified.

■ Cooling fan

This unit is fitted with a cooling fan at the rear for improved cooling. Do not cover the opening in this section with any obstacles.

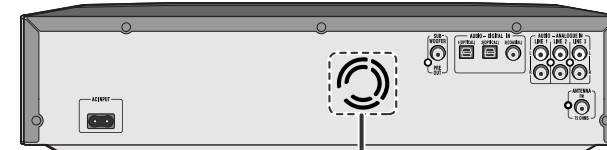

Cooling fan

Caution:

- The unit will get warm whilst being used. Do not touch the warm areas of the unit for prolonged periods to avoid injury.
- This unit is equipped with a special function which protects the amplifier circuit from damages. When it is activated, the sound switch is turned off. In this case, set the unit to the stand-by mode and turn on again.

■ Volume control

The sound level at a given volume setting depends on speaker efficiency, location, and various other factors. It is advisable to avoid exposure to high volume levels. Do not turn the volume on to full at switch on and listen to music at moderate levels.

Controls and indicators

■ Main unit (front panel)

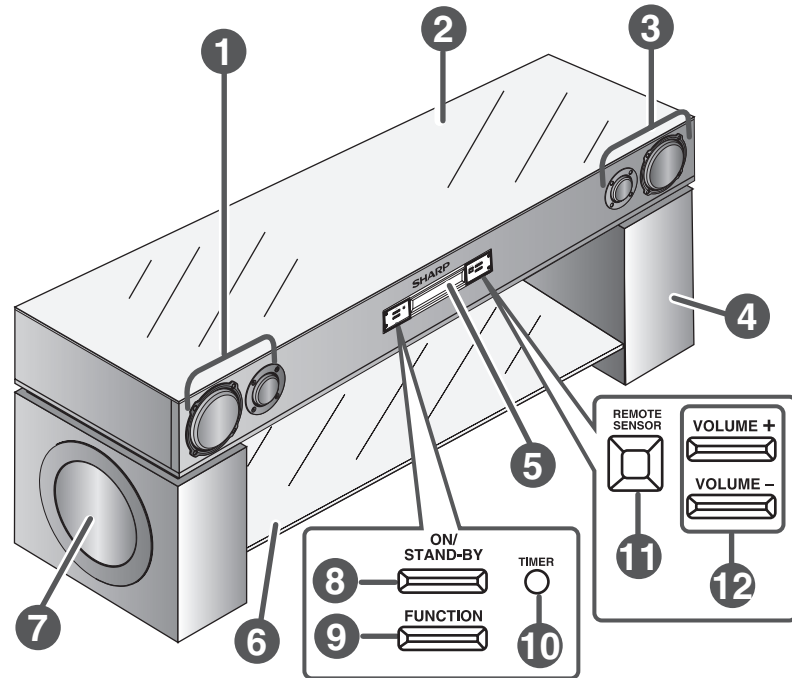

	Reference page
1. Left Front Speakers	
2. Top glass cover	10
3. Right Front Speakers	
4. Right Subwoofer	
5. Display	7
6. Glass shelf	10
7. Left Subwoofer	
8. On/Stand-by Button	16
9. Function Button	20
10. Timer Indicator	34
11. Remote Sensor	17
12. Volume Up and Down Buttons	18

■ Main unit (rear panel)

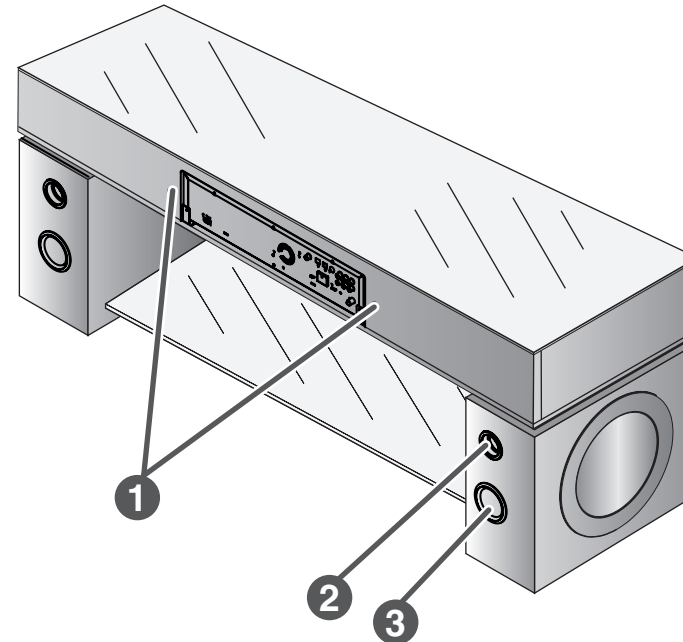

	Reference page
1. Screw Hole for safety wire	13
2. Speaker Terminal	11
3. Bass Reflex Duct	

Controls and indicators (continued)

■ Main unit (rear panel)

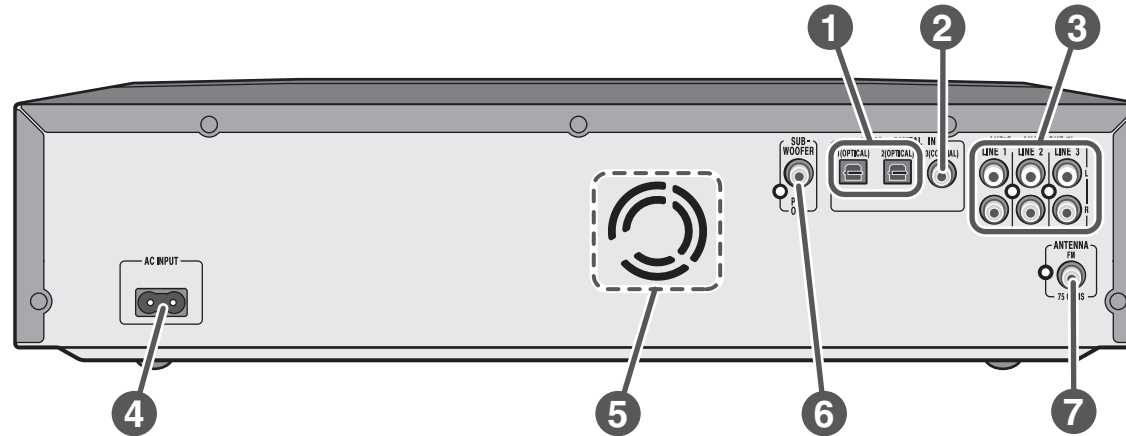

	Reference page
1. Optical Digital Audio Input Sockets	14, 15
2. Coaxial Digital Audio Input Socket	16
3. Audio Line Input Sockets	14, 15
4. AC Power Input Socket	16
5. Cooling Fan	4
6. Subwoofer Pre Output Socket	11
7. FM 75 Ohms Aerial Socket	10

■ Display

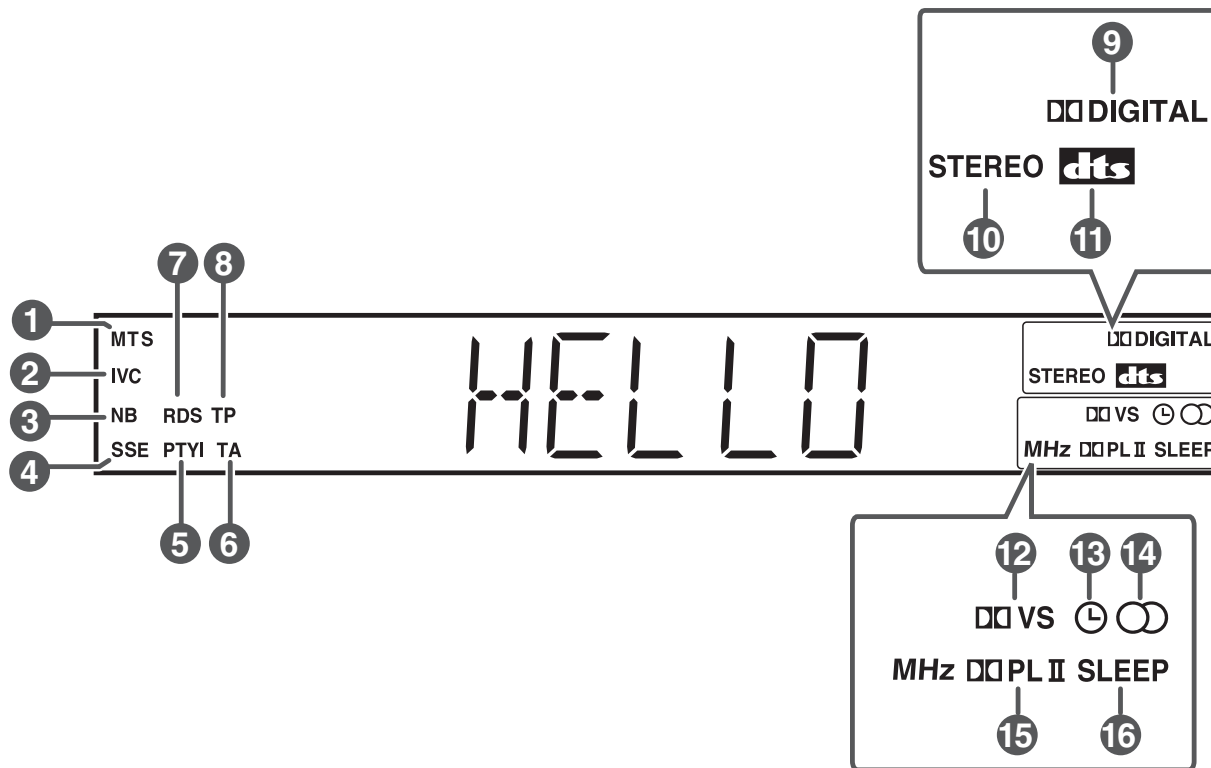

	Reference page
1. Mono to Stereo indicator	24
2. Intelligent Volume indicator	24
3. Natural Bass indicator	24
4. Sound Space indicator	24
5. Dynamic PTY indicator	28
6. Traffic Announcement indicator	28
7. RDS indicator	30
8. Traffic Programme indicator	28
9. Dolby Digital Signal indicator	25
10. FM Stereo Mode indicator	26

	Reference page
11. DTS Signal indicator	25
12. Dolby Virtual Sound indicator	23
13. Timer indicator	32
14. FM Stereo Receiving indicator	26
15. Dolby Prologic II indicator	23, 25
16. Sleep indicator	33

Controls and indicators (continued)

General Information

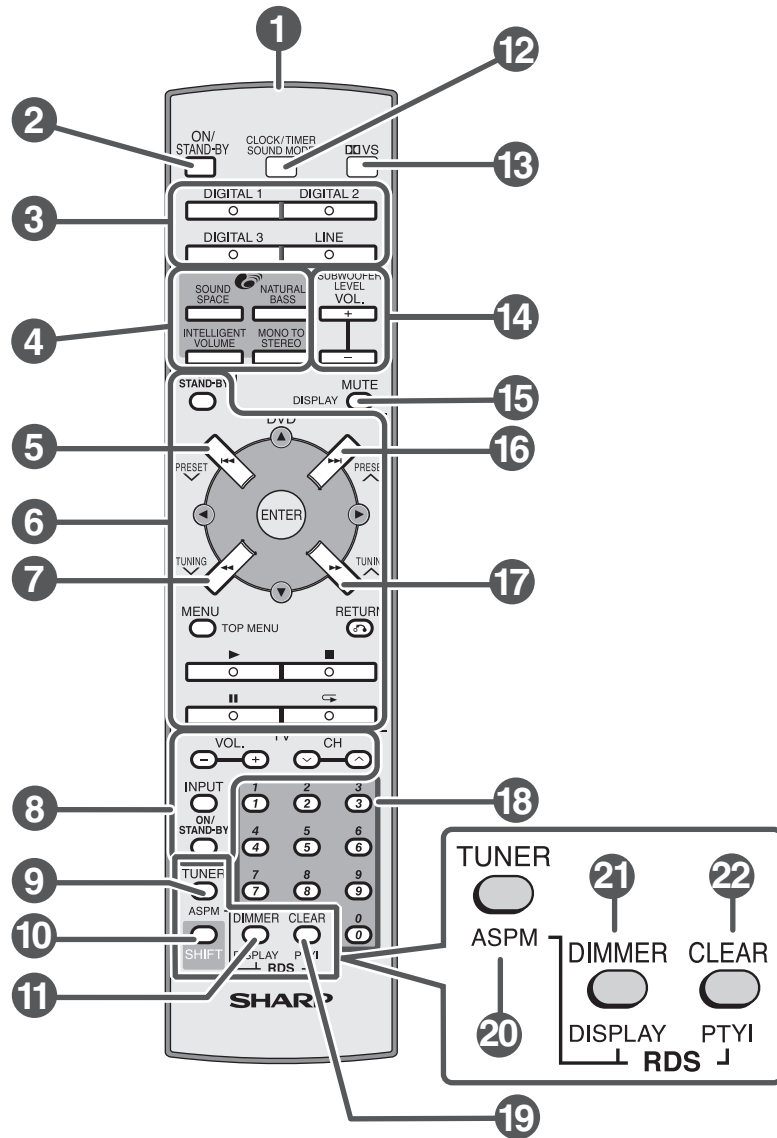

Remote control

	Reference page
1. Remote Control Transmitter	17
2. ON/STAND-BY button	17
3. Input Select Buttons	20
4. Audistry Sound Mode Buttons	24
5. Tuner Preset Down Button	27, 28
6. DVD Player Operation Buttons	35
7. Tuning Down Button	26
8. TV Operation Buttons	35
9. Tuner Button	26
10. Shift Button	18, 26, 28, 32, 35
11. Dimmer Button	18
12. Preset Sound Mode / Clock / Timer Button	19, 22
13. Dolby Virtual Speaker Button	23
14. Volume Up and Down/ Subwoofer Level Up and Down Buttons	18
15. Mute/Display Button	18
16. Tuner Preset Up Button	27, 28
17. Tuning Up Button	26
18. Direct Number Buttons	35, 37
19. Clear Button	31
20. RDS ASPM Button	28
21. RDS Display Button	28
22. RDS PTYI Button	28

DVD Player Operation Buttons (Page 35 - 36)

ON/STAND-BY button



Sets the DVD power to "ON" or "STAND-BY".

Menu/Top Menu Button



Press to display the menu.

Cursor Buttons



Press the button to select menus and items.

Return Button



Press the button to return to the previous step.

Review/Cue Buttons

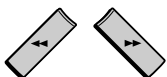

Press to go backward or forward (search).

Play Button



Play back the DVD player.

Chapter (Track) Skip Down/Up Buttons

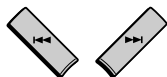

Skip down/up the DVD chapters (tracks).

Stop Button

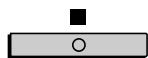

Stops the DVD player.

Enter Button



Press to set a menu or an item.

Pause Button



Press to pause.

Repeat Play Button

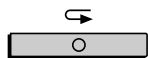

Press to repeat playback.

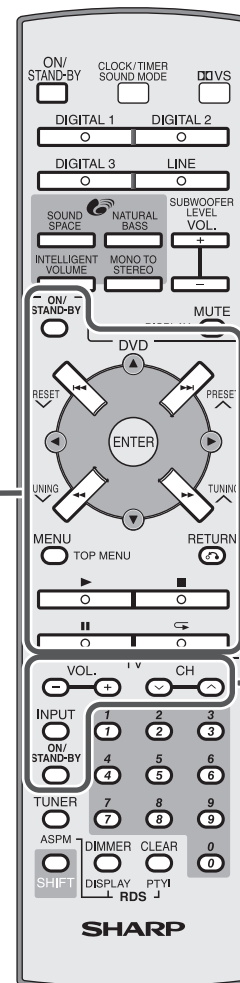

TV Operation Buttons (Page 35)

Volume Up and Down Buttons



Turn down/up the TV volume.

Channel Up and Down Buttons

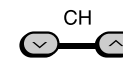

Switch down/up the TV channels.

Input Select Button (TV/VCR)



Press the button to switch the input source.

ON/STAND-BY button



Sets the TV power to "ON" or "STAND-BY".

System connections

■ Installing the main unit and the subwoofer

1. Pull up both speakers outwards.

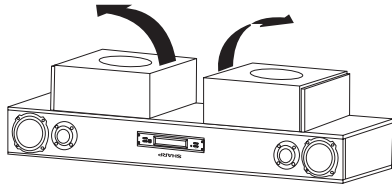

2. Pre-fasten the screw to the speaker box.

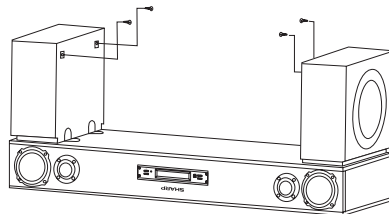

3. Snap the metal frame onto the screw and fasten the screw fully. Then turn the unit.

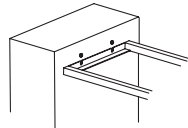

4. Stick the metal frame cushion onto the metal frame and place the glass shelf on top of it.

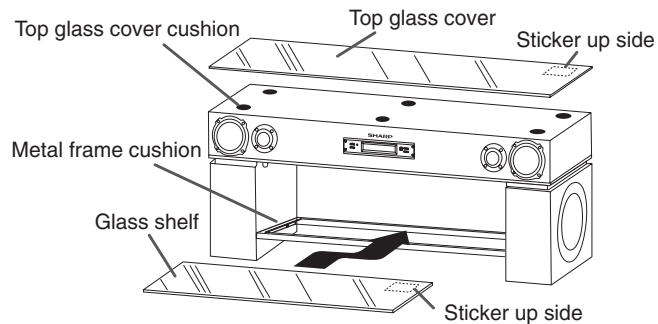

Notes:

- It is advisable for the top glass cover to be carried by 2 persons.
- Top glass with sticker on its surface, must face outwards.

■ Aerial connection

Supplied FM aerial:

Connect the FM aerial wire to the FM 75 OHMS socket and position the FM aerial wire in the direction where the strongest signal can be received.

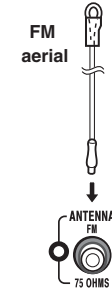

Note:

Placing the aerial on the unit or near the AC power lead may cause noise pickup. Place the aerial away from the unit for better reception.

■ External FM aerial

Use an external FM aerial if you require better reception. Consult your dealer.

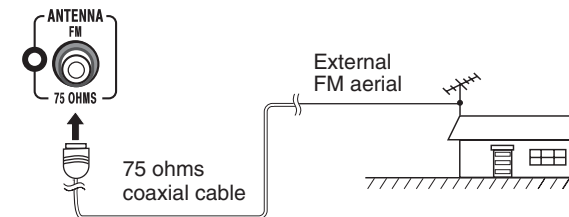

Note:

When an external FM aerial is used, disconnect the supplied FM aerial wire.

■ Subwoofer connection

Make sure to leave the AC power lead disconnected when connecting the subwoofer.

1. Connect the wire to the speaker terminal.

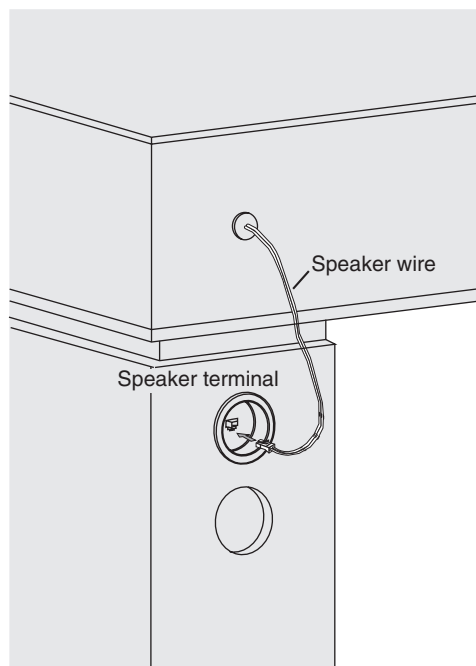

■ Using other subwoofer

You can connect a subwoofer with an amplifier to the SUBWOOFER PRE OUT socket.

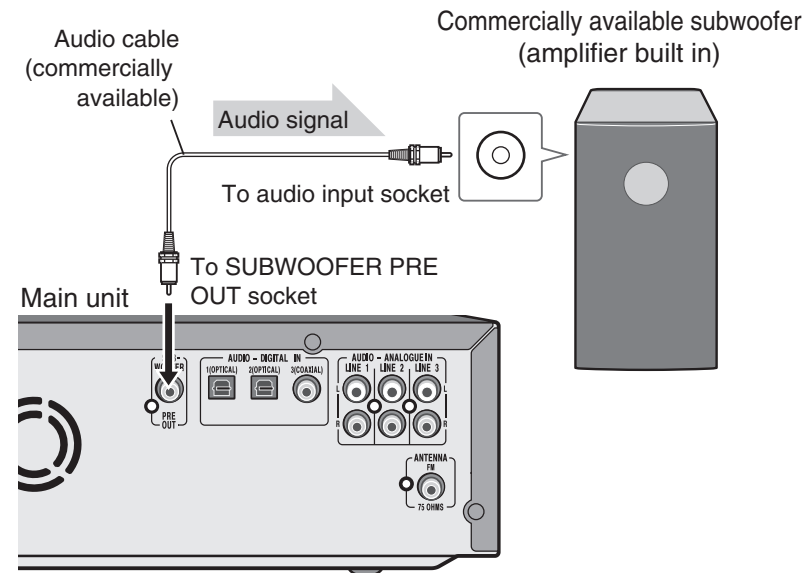

Notes:

- No sound is heard from the subwoofer without a built-in amplifier.
- When not using the supplied subwoofer, disconnect the speaker wire from the main unit.
- You may use the supplied subwoofer and a powered subwoofer at the same time.

System connections (continued)

■ Placing the TV or other equipment

1. Please ensure that the equipment is positioned in a well-ventilated area and ensure that there is at least 10 cm (4") of free space along the sides and back of the equipment.

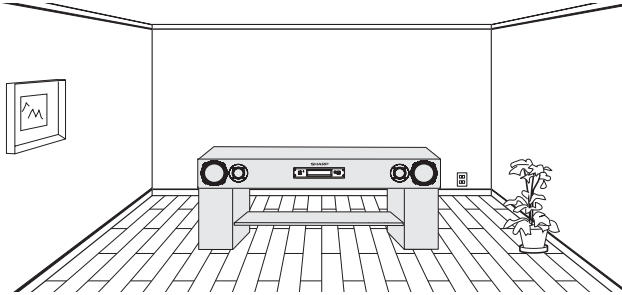

2. Placing the TV, DVD player and etc equipment. Please use anti-slip TV cushion to prevent fall.

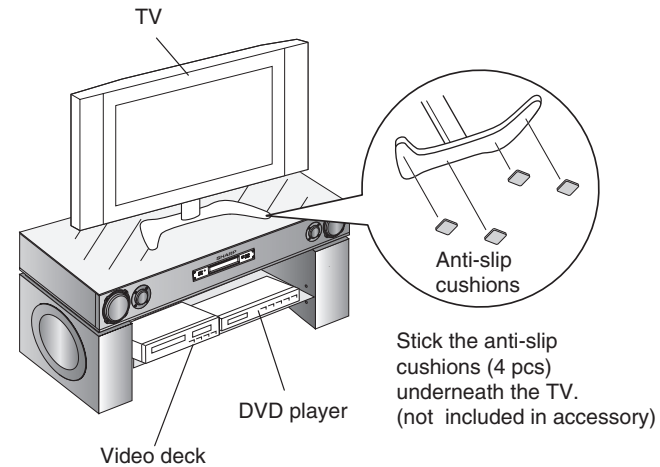

Stick the anti-slip cushions (4 pcs) underneath the TV. (not included in accessory)

Caution:

Before moving the TV away, please ensure that the anti-slip cushions underneath it have been taken out. This is to prevent the top glass cover from falling as it might stick to the TV during shifting.

Falling prevention

AN-PR1000H

Safety wires are useful to prevent the TV from falling off in case of earthquake occurrence.

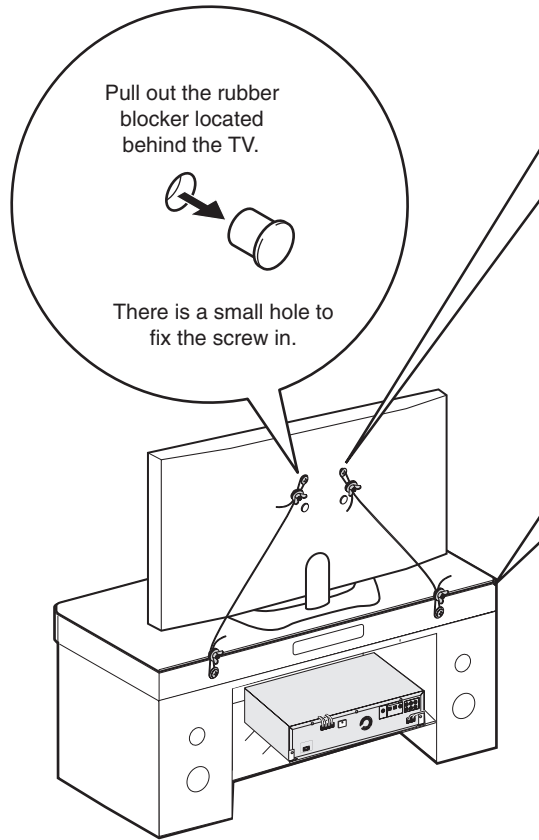

1 Fix the washer and screws behind the TV.

2 Hang the safety wire on the screw, between the washer and the TV. Tighten the screw in.

Screw
Washer
Safety wire

3 At the back of the rack unit, fix in the washer and the screw.

4 Put the safety wire around the screw and washer. Tighten the screw in. Loosen the wing nut and pull the safety wire until it is stretched properly. Tighten back the wing nut.

Washer
Screw
Wing nut

5 Ensure all the screws have been fixed properly.

6 Ensure all the wing nuts have been fixed properly.

Preparation for Use

■ Connecting a DVD player, etc.

Connect to the DVD player with an optical digital audio cable or an audio cable.

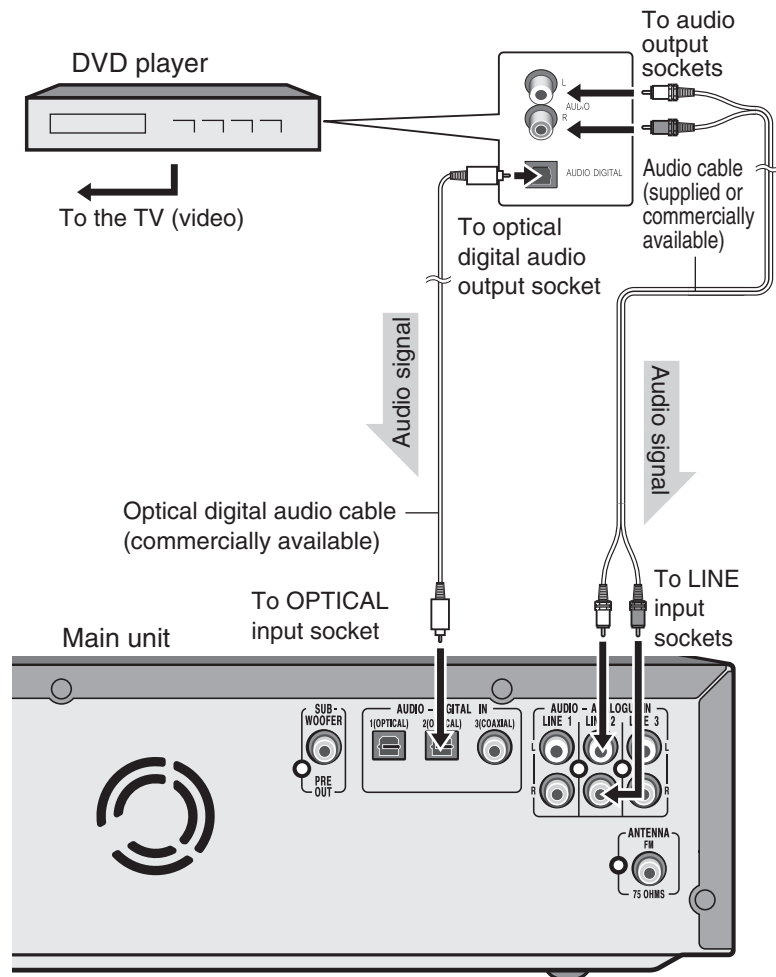

Note:

Connect the DVD video cable directly to the TV (refer to the operation manual for the DVD player).

■ Connecting a VCR, etc.

Connect to the VCR with an audio cable.

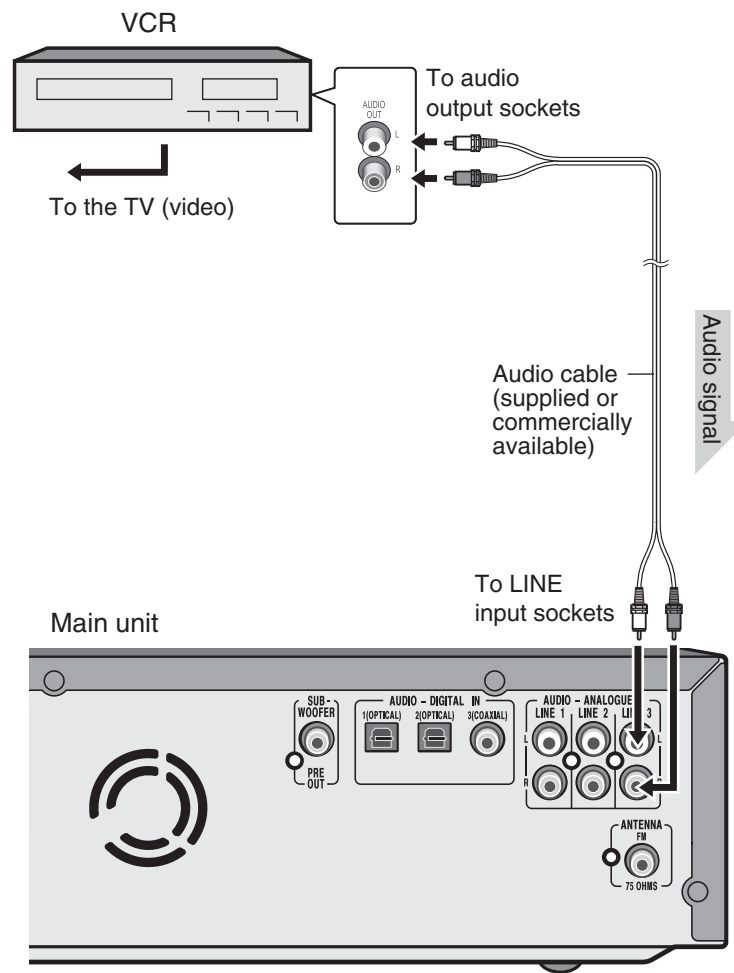

Note:

Connect the VCR video cable directly to the TV (refer to the operation manual for the VCR player).

Audio connections to TVs, DVD players, VCRs, etc. (continued)

■ Connecting a digital tuner, etc.

Connect to the digital tuner, etc. using an optical digital audio cable or a coaxial digital audio cable.

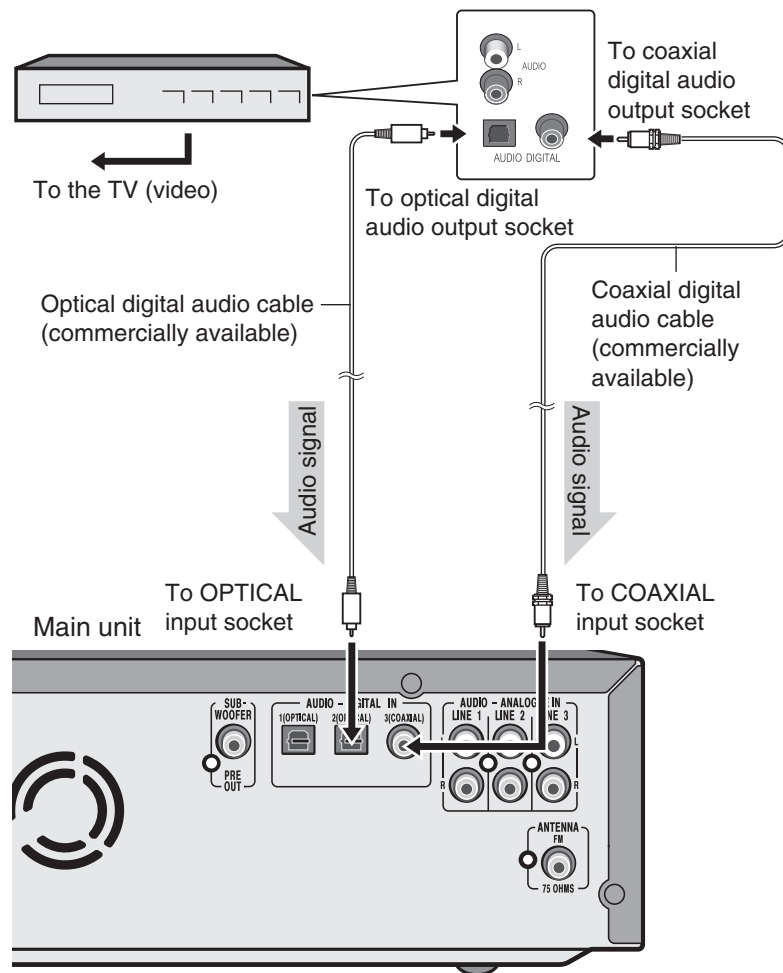

Note:

When connecting with an optical digital cable, set the digital output of the digital tuner to PCM. Refer to the operation manual of the digital tuner.

AC power connection

■ Connecting the AC power lead

After checking all the connections have been made correctly, connect the AC power lead to the AC power input socket, then to the wall socket.

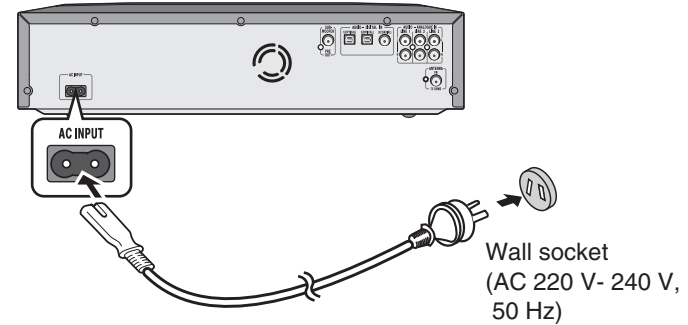

Notes:

- Never use a power lead other than the one supplied. Otherwise, a malfunction or an accident may occur.
- Unplug the AC power lead from the wall socket if the unit will not be in use for a prolonged period of time.

■ To turn the power on

Press the ON/STAND-BY button.

If the power does not turn on, check whether the power lead is plugged in properly.

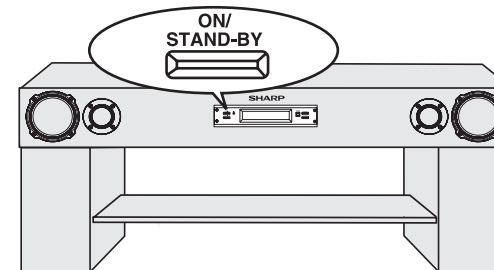

To set the unit to stand-by mode:

Press the ON/STAND-BY button again.

Note:

After the unit enters the power stand-by mode, wait a few seconds to turn on again.

Remote control

AN-PR1000H

■ Battery installation

Use 2 "AAA" size batteries (UM-4, R03, HP-16 or similar).
Batteries are not included.

1 Open the battery cover.

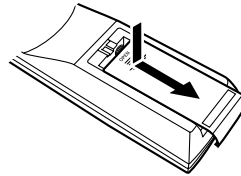

2 Insert the batteries according to the direction indicated in the battery compartment.

When inserting or removing the batteries, push them towards the ⊖ battery terminals.

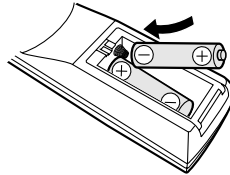

3 Close the cover.

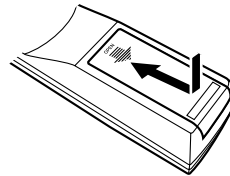

Precautions for battery use:

- Replace all old batteries with new ones at the same time.
- Do not mix old and new batteries.
- Remove the batteries if the unit will not be used for long periods of time. This will prevent potential damage due to battery leakage.

Caution:

- Do not use rechargeable batteries (nickel-cadmium battery, etc.).
- Installing the batteries incorrectly may cause the unit to malfunction.

Notes concerning use:

- Replace the batteries if the operating distance is reduced or if the operation becomes erratic.
- Periodically clean the transmitter on the remote control and the sensor on the unit with a soft cloth.
- Exposing the sensor on the unit to strong light may interfere with operation. Change the lighting or the direction of the unit.
- Keep the remote control away from moisture, heat, shock, and vibrations.

■ Test of the remote control

Point the remote control directly at the remote sensor on the unit.

The remote control can be used within the range shown below:

Press the ON/STAND-BY button. Does the power turn on? Now, you can enjoy your system.

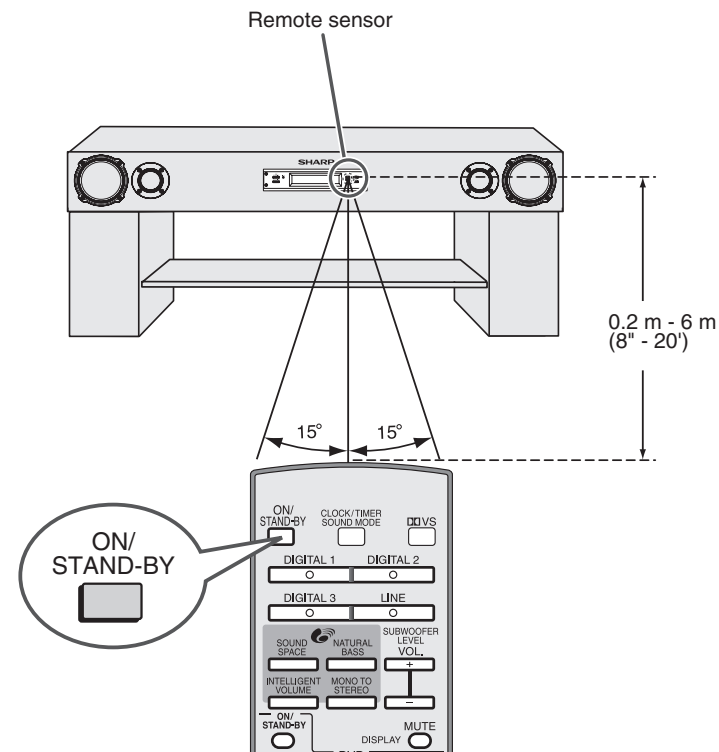

Preparation for Use

General control

Preparation for Use

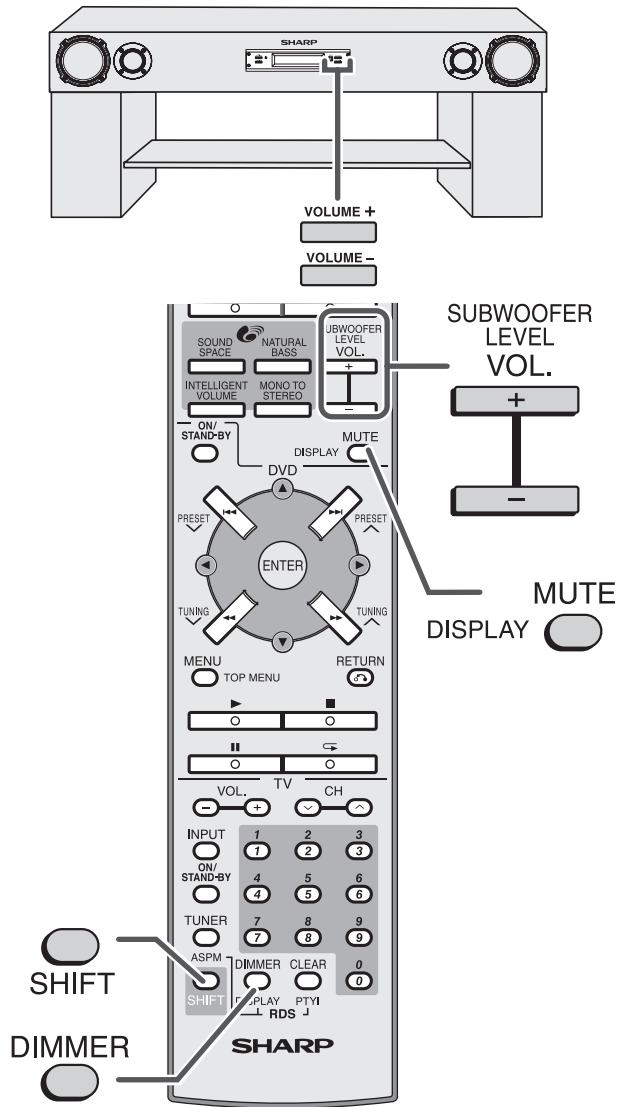

■ Volume control

Main unit operation:

Press the VOL + button to increase the volume and the VOL - button for decreasing.

Remote control operation:

Press the VOL. + button to increase the volume and the VOL. - button for decreasing.



00 ↔ 01 ↔ 02 ↔ 39 ↔ 40

■ Muting

The volume is muted temporarily when pressing the MUTE button on the remote control. Press again to restore the volume.



Notes:

- When you press another button, muting is cancelled. However, it is not cancelled if a button on the TV or DVD player is pressed or the DISPLAY button is pressed with the SHIFT button down.
- When the unit is turned off and back on again, muting is cancelled.

■ Subwoofer level control

The subwoofer level can be adjusted.

To increase the level, hold down the SHIFT button and press the SUBWOOFER LEVEL + button. To decrease the level, hold down the SHIFT button and press the SUBWOOFER LEVEL - button.



-8 ↔ -7 ↔ 7 ↔ 8

Notes:

- When sound from the subwoofer is distorted, decrease the subwoofer level.
- When changing the subwoofer level, the output level of the SUBWOOFER PRE OUT is also changed.

■ To change the display brightness (2 levels)

You can switch the display brightness by pressing the DIMMER button.



■ Display control

This unit clock can be display during power On/Off.

Display clock:

Whilst holding down the SHIFT button, press the DISPLAY button. The time display will appear for about 5 seconds.



Notes:

- If clock not being set before, "ADJUST" will be display for a whilst.
- Whilst the time display (within 5 seconds), press the DISPLAY button whilst holding down the SHIFT button again to cancel the time display manually.

Setting the clock

By setting the unit to the correct time, you can use it not only as a clock but also for timer playback.

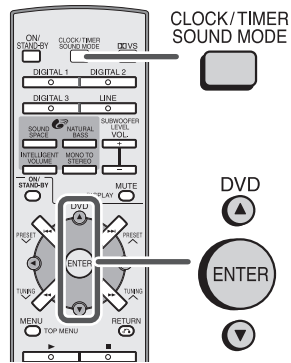

You can set the clock even when the unit is in the stand-by mode. In this example, the clock is set for the 24-hour (0:00) display

1 Hold down the SHIFT button and press the CLOCK button. Within 5 seconds, press the ▲ or ▼ button to select CLOCK ADJUST and then press the ENTER button.

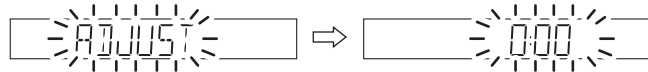

2 Hold down the SHIFT button and press the ▲ or ▼ button to select the 24-hour or 12-hour display and then press the ENTER button.

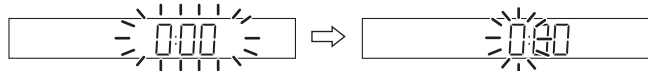

- "0:00" → The 24-hour display will appear. (0:00 - 23:59)
- "AM 12:00" → The 12-hour display will appear. (AM 12:00 - PM 11:59)
- "AM 0:00" → The 12-hour display will appear. (AM 0:00 - PM 11:59)

Note that this can only be set when the unit is first installed or it has been reset (see page 40).

3 Hold down the SHIFT button and press the ▲ or ▼ button to adjust the hour and then press the ENTER button.

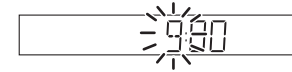

- Press the ▲ or ▼ button once to advance the time by 1 hour. Hold it down to advance continuously.
- When the 12-hour display is selected, "AM" will change automatically to "PM".

4 Hold down the SHIFT button and press the ▲ or ▼ button to adjust the minutes and then press the ENTER button.

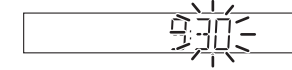

- Press the ▲ or ▼ button once to advance the time by 1 minute. Hold it down to advance continuously.
- The hour will not advance even if minutes advance from "59" to "00".
- The clock starts from "0" second (seconds are not displayed).
- The time disappears after approx.5 seconds.

To confirm the time display:

Hold down the SHIFT button and press the DISPLAY button. The time display will appear for about 5 seconds.

Note:

The "ADJUST" or time will flash at the push of the SHIFT and DISPLAY buttons when the AC power supply is restored after a power failure or unplugging the unit.

To readjust the clock:

Perform "Setting the clock" from step 1. If the "ADJUST" is not flashing in step 1, step 2 (for selecting the 24-hour or 12-hour display) will be skipped.

To change the 24-hour or 12-hour display:

- 1 Clear all the programmed contents. [Refer to "Clearing all the memory (reset)" on page 40 for details].
- 2 Perform "Setting the clock" from the beginning.

Listening to the playback sound from DVD players, VCRs, etc.

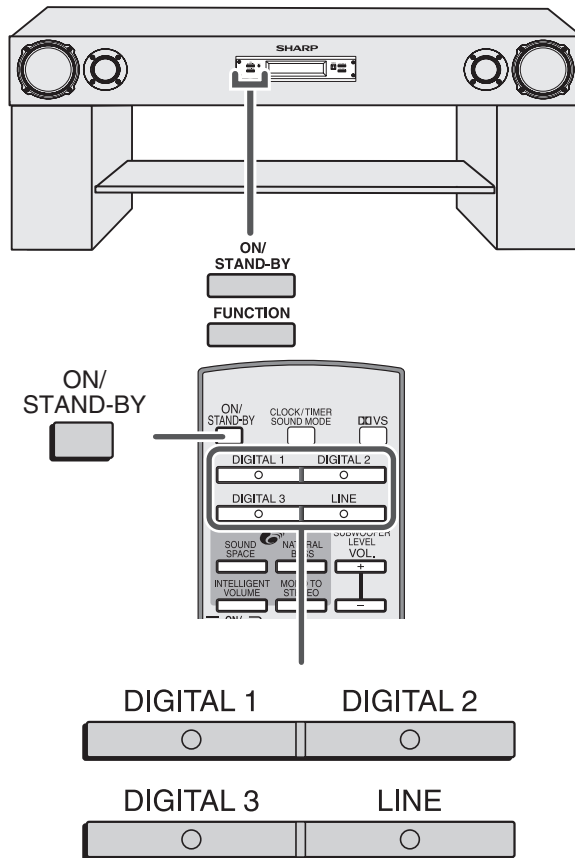

1 Turn on the connected equipment.

2 Press the ON/STAND-BY button to turn the power on.

3 Select the source to be played back.

Remote control operation:

To select a digital source, press the corresponding button.

Press the LINE button repeatedly to select the LINE input.

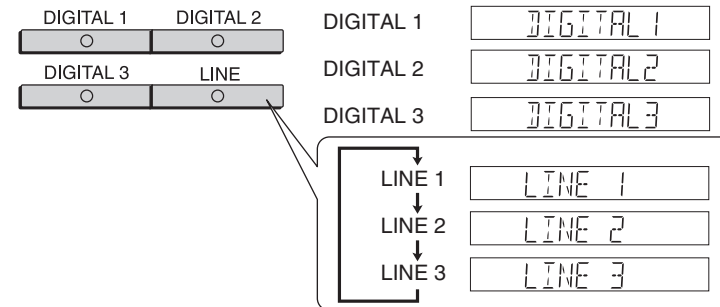

Main unit operation:

Press the FUNCTION button repeatedly to select a source.

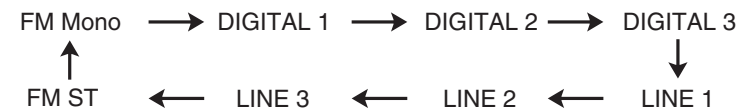

4 Press the play button of the connected equipment.

5 Adjust the volume level with the VOLUME control (see page 18).

6 Enjoy surround sound or various sound qualities (see pages 21 - 25).

7 After use:

Press the ON/STAND-BY button to enter the power stand-by mode.

Note:

Reduce the volume level with the VOLUME control before entering the power stand-by mode.

Enjoying surround sound (sound mode)

■ Preset sound modes and sound image

<p>STANDARD</p>	
<p>You can enjoy normal stereo sounds.</p>	
<p>CINEMA</p>	
<p>Enjoy a wide sound field like 5.1ch as well as enhanced powerful bass sounds. Suitable for movies, etc.</p>	
<p>NEWS</p>	
<p>Easy to listen to bass sounds such as voice of narration (even at low volume) due to well-controlled bass sounds. Suitable for news, etc.</p>	

<p>MUSIC</p>	
<p>Enhanced bass sounds create clear-cut and spacious sounds at 2.1ch. Appropriate for music, etc.</p>	
<p>SPORT</p>	
<p>Voice of narration comes out from the centre; you can hear cheers and feel the atmosphere in the theatre with a wide sound field like 5.1ch. Appropriate for sports broadcasting such as baseball and football.</p>	
<p>NIGHT</p>	
<p>Words are easy to hear and loud sounds are controlled; even at low volume, you can enjoy a wide sound field like 5.1ch. Suitable for listening to sounds of movies at low volume.</p>	

Notes:

- Subwoofer sound levels for preset sound modes are set to the recommended levels.
- You can adjust a subwoofer sound level by each preset sound mode (see page 18). Return the settings to default by resetting (see page 40).

Enjoying surround sound (sound mode) (continued)

■ Preset sound mode

Select any of the 6 preset modes already set to the optimal sound quality levels.

Select a desired sound mode by pressing the **SOUND MODE** button.

Preset sound mode	Display
STANDARD	STANDARD
CINEMA	CINEMA
NEWS	NEWS
MUSIC	MUSIC
SPORT	SPORT
NIGHT	NIGHT

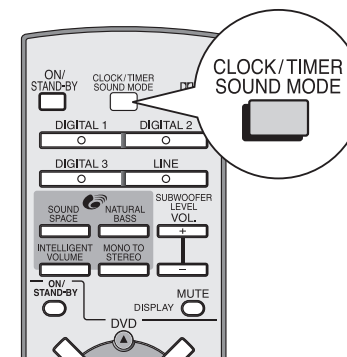
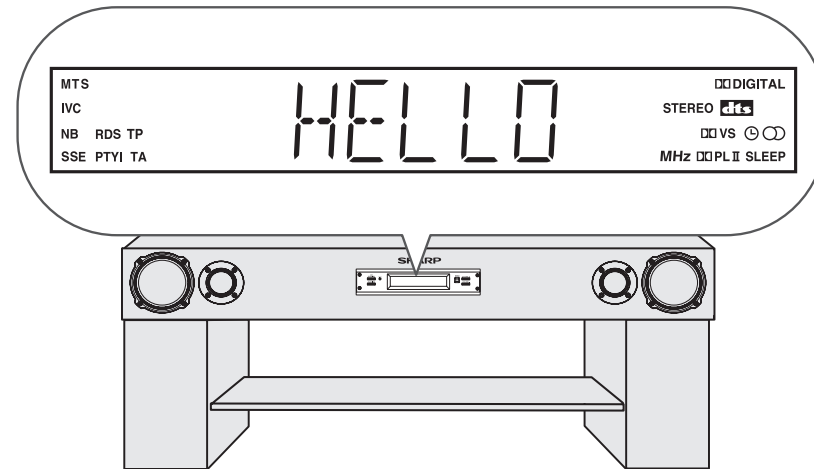

■ Dolby Virtual Speaker (DVS) sound mode

The Dolby Virtual Speaker (DVS) creates virtual surrounds comparable to the 5.1ch sound produced by the 2.1ch speaker.

When setting DVS to "ON" for 2 channel stereo signals, Dolby Pro Logic II (see page 25) brings out virtual sound effects through the signals converted into 5.1ch.

Press the VS button.

The Dolby Virtual Speaker indicator lights up.

Press the  VS button again to return to "OFF".

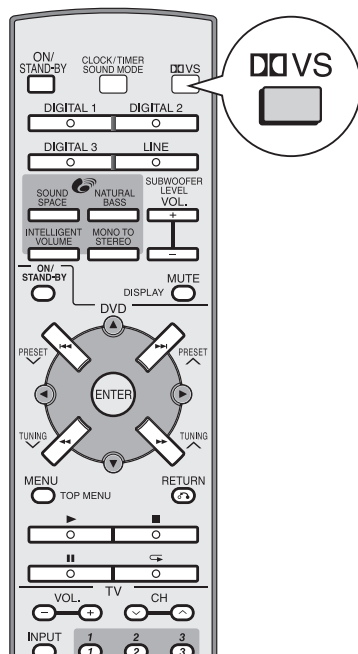

Notes:

- The DVS default setting is "ON".
- When setting the DVS mode to "ON", the preset sound mode and Audistry (SOUND SPACE mode, MONO TO STEREO mode) are cancelled. (The NATURAL BASS mode and the INTELLIGENT VOLUME mode are not cancelled.)
- Monaural signals do not generate surround effects.
- DVS sound effect may not be obtained depending on signal types (the Dolby Virtual Speaker indicator blinks). In this case, set the DVS mode to "OFF".

ON The Dolby Virtual Speaker creates multichannel-like sound effects.

Compared with the cinema mode, the bass sound level is slightly reduced.

The Dolby Pro Logic II indicator also lights up if 2ch sound signals are detected.

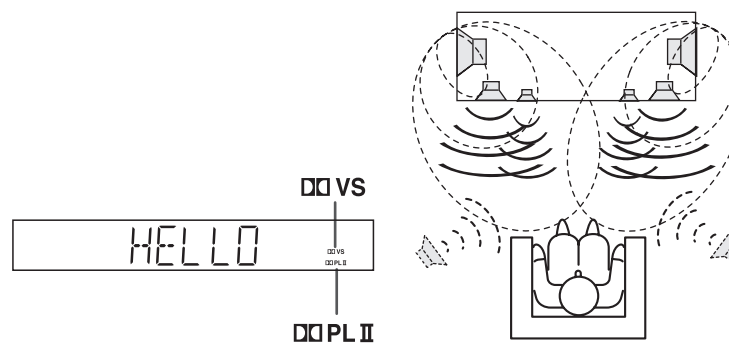

OFF The Dolby Virtual Speaker is deactivated.

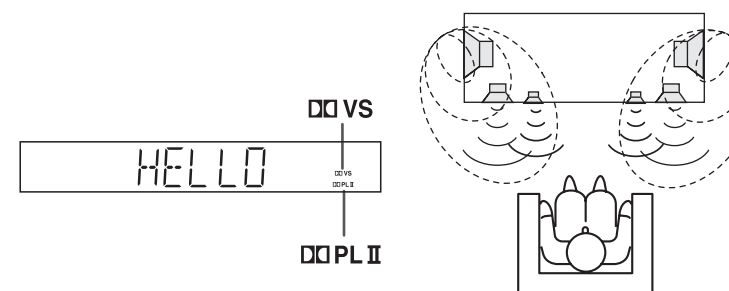

Enjoying surround sound (sound mode) (continued)

■ Audistry sound mode

Enjoy a variety of sounds by each or any combination of the 4 modes.

Press the button for your desired mode.
Press it again to cancel.

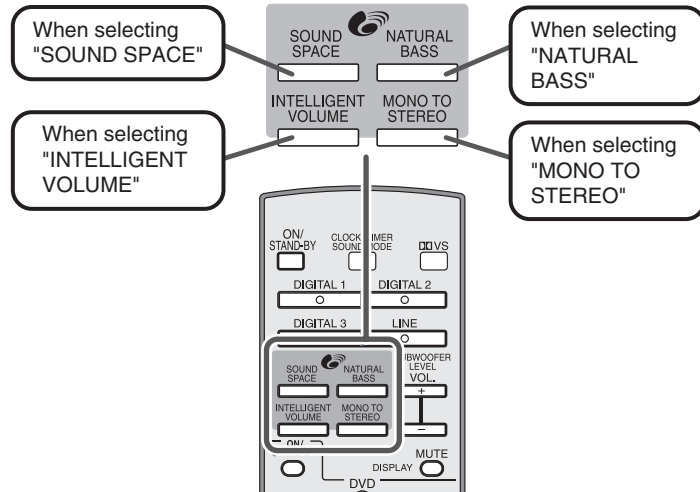

Possible combinations ○ :Enabled × :Disabled

	SOUND SPACE	NATURAL BASS	INTELLIGENT VOLUME	MONO TO STEREO
When you select "SOUND SPACE"	/	○	○	○
When you select "NATURAL BASS"	○	/	○	○
When you select "INTELLIGENT VOLUME"	○	○	/	○
When you select "MONO TO STEREO"	○	○	○	/
When you select "DVS"	×	○	○	×

SOUND SPACE SSE

(Sound stage expansion)

The 4 speakers create spacious stereo sounds.

(The SOUND SPACE indicator lights up.)

NATURAL BASS NB

(Bass sound expansion)

The system's low-frequency characteristics realise the optimal bass sounds.

(The NATURAL BASS indicator lights up.)

INTELLIGENT VOLUME IVC

(Peak limiter and expander)

Appropriate listener-friendly volumes realised; the volume is decreased during loud sounds, and increased during low sounds.

(The INTELLIGENT VOLUME indicator lights up.)

MONO TO STEREO MTS

(Mono→Stereo conversion)

You can enjoy monaural sound sources with a stereo-like effect.

(The MONO TO STEREO indicator lights up.)

Notes:

- When setting each mode of Audistry to "ON", the preset sound mode setting is cancelled.
- When setting the SOUND SPACE or MONO TO STEREO mode to "ON", the DVS setting is also cancelled. (It is not cancelled even if the NATURAL BASS or INTELLIGENT VOLUME mode is set to "ON".)
- The SOUND SPACE or MONO TO STEREO mode may not be activated depending on the input signal type. If the SOUND SPACE or MONO TO STEREO indicator blinks, the effect of these modes cannot be obtained.

This product incorporates decoders supporting the Dolby Digital system and DTS system.

DTS (Digital Theatre Systems)

DIGITAL
dts
SURROUND

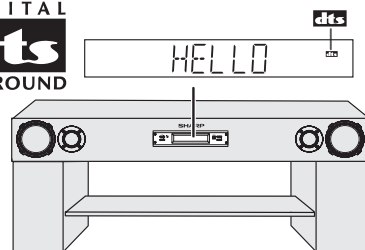

One of the digital audio systems for theatrical use. As the sound quality is emphasised, you can enjoy the realistic sound effect in the home theatre system.

Lights up when detecting DTS signal.

Dolby Digital

DOLBY
DIGITAL

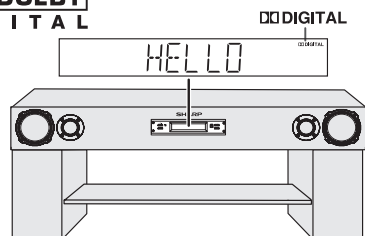

One of the digital audio systems for theatrical use. You can also enjoy the stereophonic effect in the home theatre system.

Lights up when detecting Dolby Digital signal.

Dolby Pro Logic II

DOLBY
DIGITAL
PRO LOGIC II

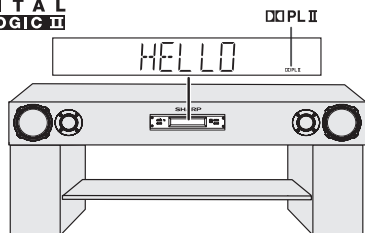

System expanding 2ch stereo sound to more spacious sound. When setting Dolby Virtual speaker to "ON", Dolby Pro Logic II is activated to enjoy the stereo sound effect.

Lights up when Dolby Pro Logic II is activated.

You can enjoy various sounds using the preset sound mode, Dolby Virtual Speaker (DVS), Audyssey, etc. (See pages 21 - 24.)

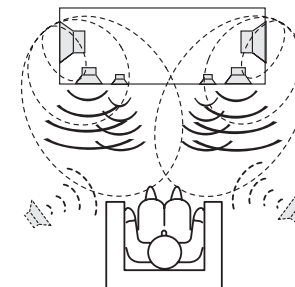

Listening to the radio

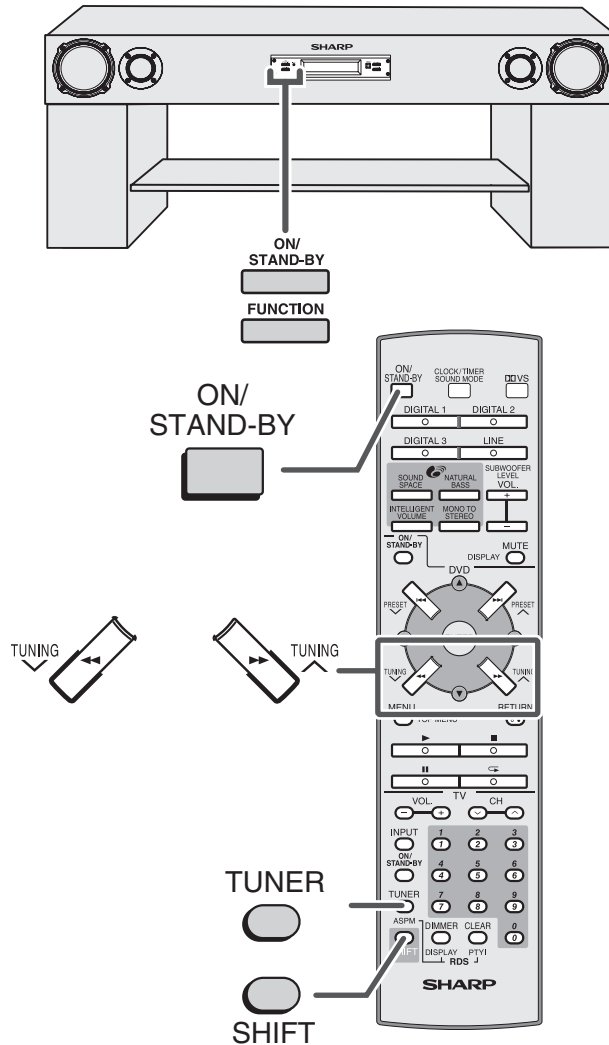
Note:

This product can receive FM stereo/FM monaural broadcasts.

■ Tuning

- 1** Press the ON/STAND-BY button to turn the power on.
- 2** Press the TUNER button repeatedly to select the desired frequency band (FM Stereo/FM Mono).
- 3** Hold down the SHIFT button and press the (TUNING ^ or v) button to tune in to the desired station.

Manual tuning:

Press the (TUNING) button as many times as required to tune in to the desired station.

Auto tuning:

When the (TUNING) button is pressed for more than 0.5 seconds, scanning will start automatically and the tuner will stop at the first receivable broadcast station.

Notes:

- When radio interference occurs, auto scan tuning may stop automatically at that point.
- Auto scan tuning will skip weak signal stations.
- To stop the auto tuning, press the TUNING button again.
- When an RDS (Radio Data System) station is tuned in, the frequency will be displayed first, and then the RDS indicator will light up. Finally, the station name will appear.
- Full auto tuning can be achieved for RDS stations "ASPM", see page 30.

To receive an FM stereo transmission:

Press the TUNER button to display the "STEREO" indicator.

- "∞" will appear when an FM broadcast is in stereo.
- If the FM reception is weak, press the TUNER button to extinguish the "STEREO" indicator. The reception changes to monaural, and the sound becomes clearer.

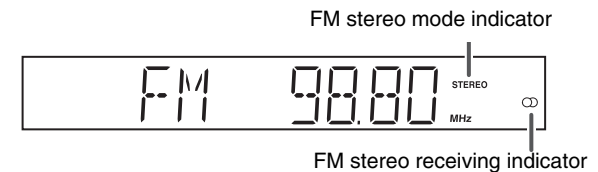

■ Memorising a station

You can store 40 FM stations in memory and recall them at the push of a button. (Preset tuning)

1 Perform steps 1 - 3 in "Tuning" on page 26.

2 Hold down the SHIFT button and press the ENTER button to enter the preset tuning saving mode.



3 Within 5 seconds, press the SHIFT and PRESET (^ or v) buttons to select the preset channel number.

Store the stations in memory, in order, starting with preset channel 1.

4 Within 5 seconds, press the SHIFT and ENTER buttons to store that station in memory.



If the "MEMORY" and preset number indicators disappear before the station is memorised, repeat the operation from step 2.

5 Repeat steps 1 - 4 to set other stations, or to change a preset station.

When a new station is stored in memory, the station previously memorised will be erased.

Note:

The backup function protects the memorised stations for a few hours should there be a power failure or the AC power lead become disconnected.

■ To recall a memorised station

Hold down the SHIFT button and press the PRESET (^ or v) button for less than 0.5 seconds to select the desired station.

■ To erase entire preset memory

- 1 Hold the CLEAR button down for 4 seconds or more.
- 2 Whilst "CLEAR" is flashing, press the SHIFT and ENTER button.

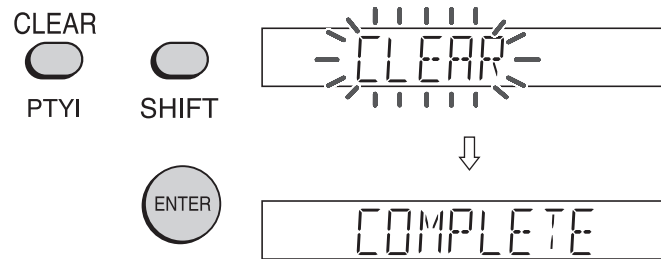

Using the Radio Data System (RDS)

RDS is a broadcasting service which a growing number of FM stations provide. These FM stations send additional signals along with their regular programme signals. They send their station names, and information about the type of programme such as sport, music, etc.

When tuned to an RDS station, "RDS" and the station name will be displayed.

"TP" (Traffic Programme) will appear on the display when the received broadcast carries traffic information, and "TA" (Traffic Announcement) will appear whilst a traffic information is on air.

"PTYI" (Dynamic PTY Indicator) will appear whilst the Dynamic PTY station is received.

You can control the RDS by using the remote control only.

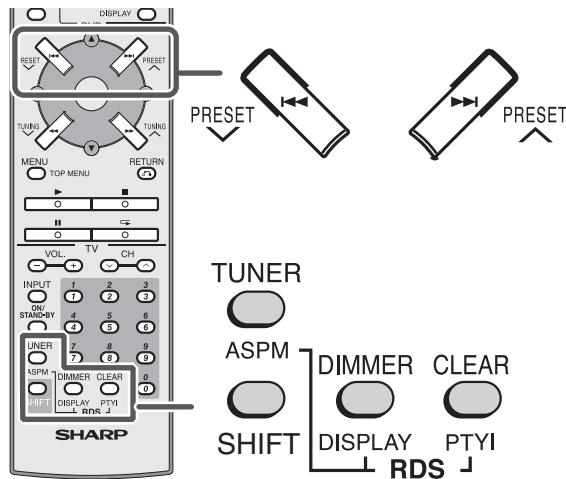

Information provided by RDS

Press the SHIFT button and then the RDS DISPLAY button. The display changes as follows each time they are pressed.

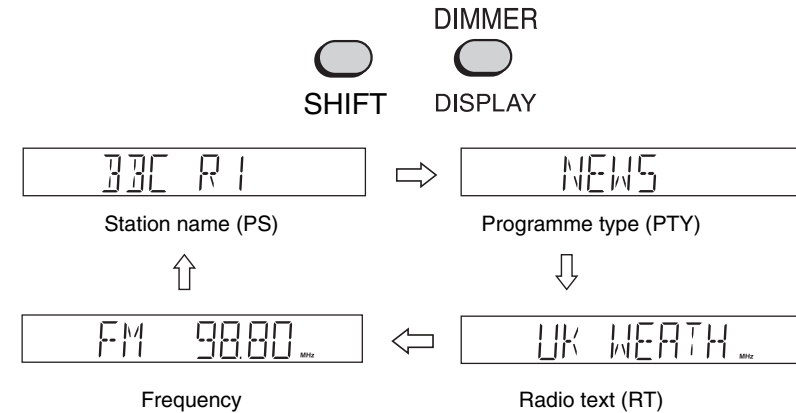

When you are tuning in to a station other than an RDS station or to an RDS station which sends weak signal, the display will change in the following order:

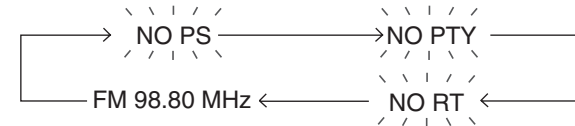

■ Using the Auto Station Programme Memory (ASPM)

Whilst in the ASPM operation mode, the tuner will automatically search for new RDS stations. Up to 40 stations can be stored.

If you have already stored some stations in memory, the number of new stations you can store will be less.

1 Press the TUNER button to select the FM stereo band.

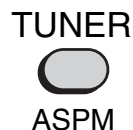

2 Press the SHIFT button, and then hold down the RDS ASPM button for at least 3 seconds.

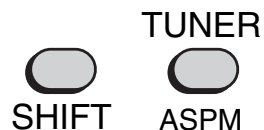

- 1 After "ASPM" has flashed for about 4 seconds, scanning will start (87.50 - 108.00 MHz).



- 2 When an RDS station is found, "RDS" will appear for a short time and station will be stored in memory.

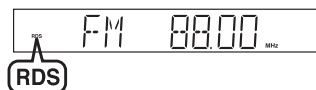

- 3 After scanning, the number of stations stored in memory will be displayed for 4 seconds, and then "END" will appear for 4 seconds.



To stop the ASPM operation before it is complete:

Press the RDS ASPM button whilst it is scanning for stations. The stations which are already stored in memory will be kept there.

Notes:

- If the same station is broadcasting on different frequencies, the strongest frequency will be stored in memory.
- Any station which has the same frequency as one stored in memory will not be stored.
- If 40 stations have already been stored in memory, the scan will be aborted. If you want to redo the ASPM operation, erase the preset memory.
- If no stations have been stored in memory, "END" will appear for about 4 seconds.
- If the RDS signals are very weak, station names may not be stored in memory.

To erase all of the contents of preset memory:

- 1 Hold the CLEAR button down for 4 seconds or more.
 - 2 Within 10 seconds, press the SHIFT and ENTER buttons.
- After performing this operation, all of the preset memory information will be erased.

To store a station name again if the wrong name was stored in memory: It may be impossible to store station names in memory using the ASPM function if there is lots of noise or if the signal is too weak. In this case, perform as follows.

- 1 Hold down the SHIFT button and press the PRESET (^ or v) button to check whether the names are correct.
 - 2 If you find a wrong name during receiving the station, wait until the correct name will be displayed and then press the SHIFT and ENTER buttons.
 - 3 Within 5 seconds, press the SHIFT and ENTER buttons whilst the preset channel number is flashing.
- The new station name has been stored in memory correctly.

Notes:

- The same station name can be stored in different channels.
- In a certain area or during certain time periods, the station names may temporarily be different.

■ Notes for RDS operation

If any of the following events occur, it does not mean that the unit is faulty:

- "PS", "NO PS" and a station name appear alternately, and the unit does not operate properly.
- If a particular station is not broadcasting properly or a station is conducting tests, the RDS reception function may not work properly.
- When you receive an RDS station whose signal is too weak, information like the station name may not be displayed.
- "NO PS" or "NO PTY" will flash for about 5 seconds, and then the frequency will be displayed.

Using the Radio Data System (RDS) (continued)

■ To recall stations in memory

To specify programme types and select stations (PTY search):

You can search a station by specifying the programme type (news, sports, traffic programme, etc. ... see page 31) from the stations in memory.

1 Press the TUNER button to select the FM stereo.

2 Press the SHIFT button and press the RDS PTYI button.



"SELECT" and "PTY TI" will appear alternately for about 6 seconds.

3 Within 6 seconds, press the SHIFT button and PRESET (^ or v) button to select the programme type.



Each time the button is pressed, the programme type will appear. If the button is held down for more than 0.5 seconds, the programme type will appear continuously.

4 Whilst the selected programme type is flashing (within 6 seconds), press the SHIFT button and then the RDS PTYI button.



After the selected programme type has been lit for 2 seconds, "SEARCH" will appear, and the search operation will start.

Notes:

- If the display has stopped flashing, start again from step 2. If the unit finds a desired programme type, the corresponding channel number will flash for about 4 seconds, and then the station name will flash for 7 seconds, which will remain lit.
- If you want to listen to the same programme type of another station, press the SHIFT button and press the RDS PTYI button whilst the channel number or station name is flashing. The unit will look for the next station.
- If no station can be found, "NOTFOUND" will appear for 4 seconds.

If you select the traffic programme:

If you select the traffic programme (TP) in step 3, "TP" will appear. (This does not mean that you can listen to the traffic information at that time.)

When the traffic information is broadcast, "TA" will appear.

To specify station names and select stations manually:

You can select a station by specifying the name (BBC R1, BBC R2, etc.) from the stations stored in memory.

Before starting this operation, you must store one or more station names in memory.

- 1 Press the TUNER button to select the FM band.
- 2 Press the PRESET (^ or v) button to select a desired station.
- 3 The station name will be displayed for 6 seconds. Then the display will change.

Descriptions of the PTY (Programme Type) codes, TP (Traffic Programme) and TA (Traffic Announcement).

You can search for and receive the following PTY, TP and TA signals.

NEWS	Short accounts of facts, events and publicly expressed views, reportage and actuality.
AFFAIRS	Topical programme expanding or enlarging upon the news, generally in different presentation style or concept, including debate, or analysis.
INFO	Programmes whose purpose is to impart advice in the widest sense.
SPORT	Programme concerned with any aspect of sport.
EDUCATE	Programme intended primarily to educate, of which the formal element is fundamental.
DRAMA	All radio plays and serials.
CULTURE	Programmes concerned with any aspect of national or regional culture, including language, theatre, etc.
SCIENCE	Programmes about the natural sciences and technology.
VARIED	Used for mainly speech-based programmes usually of light-entertainment nature, not covered by other categories. Examples include: quizzes, panel games, personality interviews.
POP M	Commercial music, which would generally be considered to be of current popular appeal, often featuring in current or recent record sales charts.
ROCK M	Contemporary modern music, usually written and performed by young musicians.
EASY M	Current contemporary music considered to be "easy-listening", as opposed to Pop, Rock or Classical, or one of the specialised music styles, Jazz, Folk or Country. Music in this category is often but not always, vocal, and usually of short duration.
LIGHT M	Classical music for general, rather than specialist appreciation. Examples of music in this category are instrumental music, and vocal or choral works.
CLASSICS	Performances of major orchestral works, symphonies, chamber music, etc., and including Grand Opera.
OTHER M	Musical styles not fitting into any of the other categories. Particularly used for specialist music of which Rhythm & Blues and Reggae are examples.
WEATHER	Weather reports and forecasts and meteorological information.
FINANCE	Stock Market reports, commerce, trading, etc.

CHILDREN	For programmes targeted at a young audience, primarily for entertainment and interest, rather than where the objective is to educate.
SOCIAL	Programmes about people and things that influence them individually or in groups. Includes: sociology, history, geography, psychology and society.
RELIGION	Any aspect of beliefs and faiths, involving a God or Gods, the nature of existence and ethics.
PHONE IN	Involving members of the public expressing their views either by phone or at a public forum.
TRAVEL	Features and programmes concerned with travel to near and far destinations, package tours and travel ideas and opportunities. Not for use for announcements about problems, delays, or roadworks affecting immediate travel where TP/TA should be used.
LEISURE	Programmes concerned with recreational activities in which the listener might participate. Examples include, Gardening, Fishing, Antique collecting, Cooking, Food & Wine, etc.
JAZZ	Polyphonic, syncopated music characterised by improvisation.
COUNTRY	Songs which originate from, or continue the musical tradition of the American Southern States. Characterised by a straightforward melody and narrative story line.
NATION M	Current Popular Music of the Nation or Region in that country's language, as opposed to International 'Pop' which is usually US or UK inspired and in English.
OLDIES	Music from the so-called "golden age" of popular music.
FOLK M	Music which has its roots in the musical culture of a particular nation, usually played on acoustic instruments. The narrative or story may be based on historical events or people.
DOCUMENT	Programme concerned with factual matters, presented in an investigative style.
TEST	Broadcast when testing emergency broadcast equipment or receivers.
ALARM	Emergency announcement made under exceptional circumstances to give warning of events causing danger of a general nature.
TP	Broadcasts which carry traffic announcements.
TA	Traffic announcements are being broadcast.

Timer and sleep operation

You can use the unit as an alarm clock by setting the timer.

Before setting timer:

- 1 Set the unit to the correct time (page 19).
If it is not set, you cannot use the timer function.
- 2 Prepare the sound source for playback.
- 3 Store radio stations (page 27)

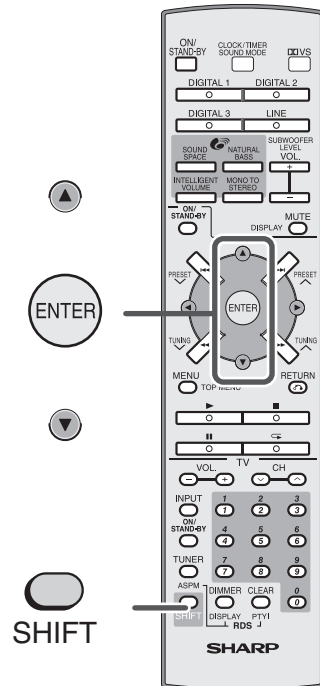

■ Setting the timer

- 1 Turn the power on and hold down the SHIFT button and press the TIMER button.**

Set the unit to the correct time if "TIMER STANDBY" does not appear.

STANDBY

- 2 Within 10 seconds, hold down the SHIFT button and press the ▲ or ▼ button to select "TIMER SET", and press the ENTER button.**

TIMERSET

- 3 Hold down the SHIFT button and press the ▲ or ▼ button to adjust the hour and then press the ENTER button.**

- 4 Hold down the SHIFT button and press the ▲ or ▼ button to adjust the minutes and then press the ENTER button.**

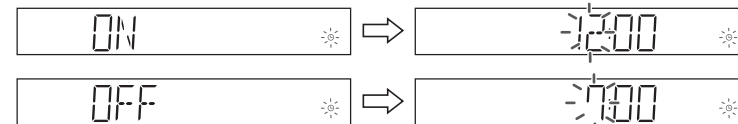

The start time is set and the finish time (1 hour later) will be displayed automatically.

- 5 Set the time to finish as in steps 3 and 4 above.**

- 6 Switch input with the SHIFT and ▲ or ▼ buttons, and then press the SHIFT and ENTER buttons.**

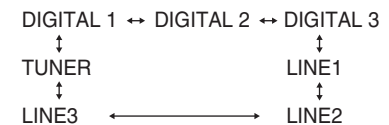

- When you select the tuner, select a station by pressing the SHIFT and ▲ or ▼ buttons, and then press the SHIFT and ENTER buttons.
- If a station has not been programmed, "NO P-SET" will be displayed.

- 7 Adjust the volume with the SHIFT and ▲ or ▼ buttons and press the SHIFT and ENTER buttons.**

Settings are displayed in order and the unit will enter the timer stand-by mode.

Caution:

This unit cannot set the timer of other equipment.

To perform the timer playback using other equipment, you should also set the timer on the equipment separately.

■ Setting the sleep timer

You can set the unit to the power stand-by mode at the specified time.

- 1 During playback, hold down the **SHIFT** button and press the **TIMER** button.

- 2 Within 10 seconds, hold down the **SHIFT** button and press the **▲** or **▼** button to select "SLEEP SET", and press the **ENTER** button.

- 3 Press the **SHIFT** and **▲** or **▼** buttons to select the time.

(Maximum: 2 hours - Minimum: 1 minute)

- 2 hours - 5 minutes → 5-minute intervals
- 5 minutes - 1 minute → 1-minute intervals

- 4 Press the **SHIFT** and **ENTER** buttons.

"SLEEP" will appear.

- 5 The unit will enter the power stand-by mode automatically after the preset time has elapsed.

The volume will be turned down 1 minute before the sleep operation finishes, and then you cannot change the volume.

Caution:

This unit cannot set the sleep timer of other equipment.

To use the sleep timer using other equipment, you should also set the timer on the equipment separately.

To confirm the remaining sleep time:

- 1 Whilst "SLEEP" is indicated, hold down the **SHIFT** button and press the **TIMER** button.
- 2 Within 10 seconds, press the **SHIFT** and **▲** or **▼** buttons to select "SLEEP".

Remaining sleep time

- The remaining sleep time is displayed for about 10 seconds.
- You can change the remaining sleep time whilst it is displayed by pressing the **SHIFT** and **ENTER** buttons (steps 3 - 4).

To cancel the sleep operation:

Press the **ON/STAND-BY** button whilst "SLEEP" is indicated.

To cancel the sleep operation without setting the system to the stand-by mode, proceed as follows.

- 1 Press the **SHIFT** and **TIMER** buttons.
- 2 Within 10 seconds, press the **SHIFT** and **▲** or **▼** buttons to select "SLEEP OFF", and press the **SHIFT** and **ENTER** buttons.

■ To use timer and sleep operation together

You can fall asleep and wake up to the radio.

- 1 Set the sleep timer (steps 1 - 4).

Sleep operation starts.

- 2 Set the timer playback.

("Setting the timer" on page 32, steps 1 - 7)

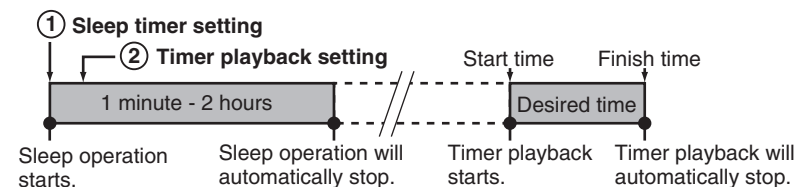

Timer and sleep operation (continued)

After completing the setting

When the timer setting is completed:

The unit is in the timer playback stand-by mode.

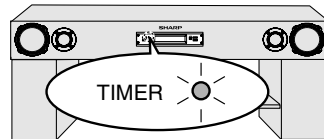

To check the timer setting:

- 1 Whilst in the timer playback stand-by mode, press the SHIFT and TIMER buttons.
- 2 Within 10 seconds, hold down the SHIFT button and press the ▲ or ▼ button to select "TIMER CAL", and press the ENTER button.
The unit returns to the timer playback stand-by mode after the setting contents are displayed in order.

When the start time is reached:

Unit starts automatically and the volume increases gradually.
The unit is operated by the timer.

Timer play indicator flashes

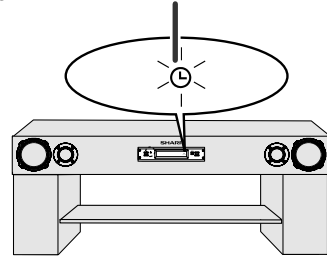

Cancelling the timer playback:

Timer playback is cancelled by turning the power on whilst in the timer playback stand-by mode. The same operation can be performed in the following procedure without turning the power on.

- 1 Press the SHIFT and TIMER buttons.
"TIMER OFF" will appear.
- 2 Within 10 seconds, press the SHIFT and ENTER buttons. Timer playback will be cancelled (the contents of the setting will not be cancelled.)

When the finish time is reached:

The unit is set to the power stand-by mode automatically.

The timer setting is cancelled.

Reusing the timer: Using the same setting;

The timer setting will be memorised once it is entered. To reuse the same setting, perform the following operations.

- 1 Turn the power on and press the SHIFT and TIMER buttons.
"TIMER STANDBY" will appear. If it does not appear, set the unit to the correct time.
- 2 Within 10 seconds, press the SHIFT and ENTER buttons.
After the setting contents are displayed in order, the unit is set to the timer playback stand-by mode.

Changing the setting;

Turn the power on, and repeat the operation from step 1 in "Setting the timer" (page 32).

Caution:

The contents of the setting will be erased if the unit is unplugged or a power failure occurs. In such cases, set the timer again.

Operating the TV or DVD player with the remote control

AN-PR1000H

You can operate Sharp's TVs and DVD players with this system's remote control. If TVs or DVD players of Sharp or other manufacturers cannot be operated by the remote control, change the manufacturer setting code (see pages 37 - 38).

Depending on the model, some or all functions may not be operable using the remote control of this unit. In this case, use the remote control supplied with each product.

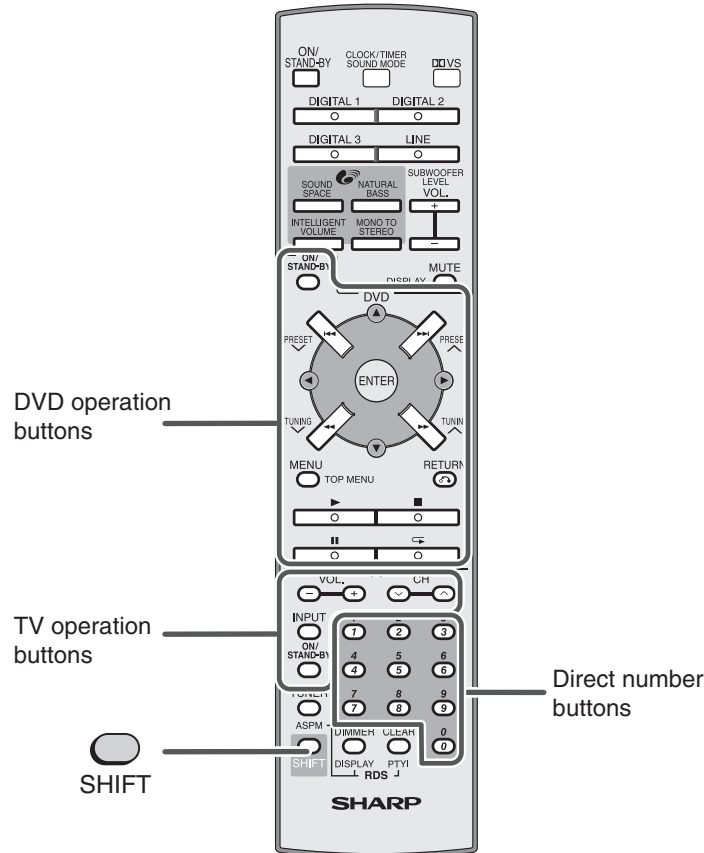

■ Watching TV

Point the remote control at the TV...

1 Press the TV ON/STAND-BY button to turn on the TV.

2 Press the direct number buttons to set the channel.

Pressing the TV CH \downarrow or \uparrow button enables TV channel switching.

3 Press the TV VOL. + or - button to adjust the TV volume.

Other operable button

Input Select Button (TV/VCR)

INPUT

■ Playing a DVD

Point the remote control at the DVD player...

1 Press the DVD ON/STAND-BY button to turn on the DVD.

2 Press the \blacktriangleright button.

Playback starts.







3 Press the \blacksquare button.







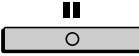



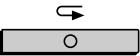







Playback stops.

Operating the TV or DVD player with the remote control (continued)

■ Various operations of DVD player

Depending on the DVD player model, some or all functions may not be operable using the remote control of this unit. In addition, a different function may be activated. In this case, use the remote control supplied with each product. For the detailed operation procedure or operations, refer to the operation manual for your DVD player.

Action	Buttons to be used	Operation procedure
Fast forward (search)		Press during playback. <ul style="list-style-type: none"> Press the ► button to cancel.
Fast reverse (search)		Press during playback. <ul style="list-style-type: none"> Press the ► button to cancel.
To locate the beginning of a chapter (skip)		Press during playback. Skips to the beginning of the next chapter (track).
		Press during playback. Returns to the beginning of the current chapter (track). <ul style="list-style-type: none"> Returns to the beginning of the previous chapter (track) when pressed twice.
Freezing pictures (still picture playback)		Press during playback. <ul style="list-style-type: none"> When playing back a music CD, it enters the pause mode. Press the ► button to cancel. <p>Still picture playback is cancelled, and the playback screen returns.</p>
Advancing frame by frame (frame advance playback)		Press during still picture playback. <ul style="list-style-type: none"> Press the ► button to cancel. <p>Frame advance playback is cancelled, and the playback screen returns.</p>

Action	Buttons to be used	Operation procedure
Playing the title (chapter) repeatedly (repeat play)	   	<ol style="list-style-type: none"> Select and play back the title (track) or chapter to watch repeatedly, then press the ◀ button. Press the ◀ or ► button to select "Playing title" or "Playing chapter", and press the ENTER button. <p>Repeat play is set.</p> <ul style="list-style-type: none"> Press the ◀ button to cancel repeat play.
When the DVD video contains a menu... Playback by selecting a title	 SHIFT  MENU  TOP MENU     	<ol style="list-style-type: none"> Whilst holding down the SHIFT button, press the TOP MENU button. Press the ▲, ▼, ◀ or ► button to select the desired title, and press the ENTER button. <p>The selected title starts playback.</p> <ul style="list-style-type: none"> Press the ■ button to stop playback.
When the DVD video contains a menu... Playback by selecting the disc guide	 MENU  TOP MENU     	<ol style="list-style-type: none"> Press the MENU button. Press the ▲, ▼, ◀ or ► button to select "Subtitle", and press the ENTER button. Press the ▲, ▼, ◀ or ► button to select "Language", and press the ENTER button. <p>Subtitle is displayed in the selected language.</p>

Changing the manufacturer setting of the remote control

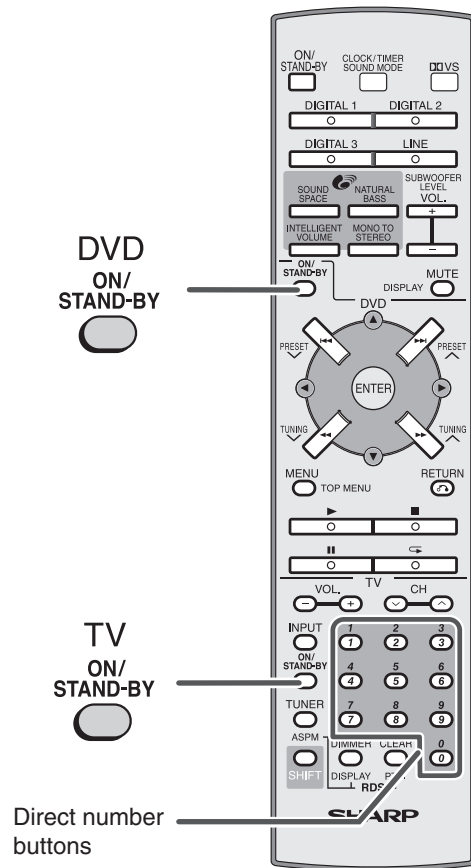

■ To change the TV manufacturer setting

Whilst holding down the TV ON/STAND-BY button, enter the manufacturer setting number (4 digits) with the direct number buttons.

- Check the TV setting number to change the TV manufacturer setting (see page 38).
- After setting, check it operates properly.

■ To change the DVD player manufacturer setting

Whilst holding down the DVD ON/STAND-BY button, enter the manufacturer setting number (4 digits) with the direct number buttons.

- After setting, check it operates properly.

DVD player setting number

Manufacturer name	Setting number	Manufacturer name	Setting number
SHARP	2006(*), 2021	PIONEER	2000, 2009, 2018, 2020
AKAI	2007	RCA	2008, 2011
DAEWOO	2027	SAMSUNG	2005
DENON	2010	SANYO	2024
FUNAI	2025	SONY	2002, 2016
HITACHI	2012	THOMSON	2015
LG	2022	TOSHIBA	2001
MICROSOFT	2017	VICTOR/JVC	2004
MITSUBISHI	2023	YAMAHA	2026
PANASONIC	2003, 2019	ZENITH	2014
PHILIPS	2013		

(*): The default manufacturer numbers are 2006 (SHARP) for DVD player.

Notes:

- Some models of Sharp's TVs and DVD players may not be operable.
- As for manufacturers with 2 or more setting numbers, test them to select the right number.
- Registering the manufacturer number deletes the number previously memorised.
- When replacing the batteries of the remote control, the manufacturer number may return to default. In this case, register it again.
- The manufacturer number cannot be registered depending on the TV or DVD player. Even if the number can be set, some buttons may not work.

Changing the manufacturer setting of the remote control (continued)

TV setting number

Manufacturer name	Setting number	Manufacturer name	Setting number
SHARP	1010(*), 1012, 1018, 1025	FUNAI	1027
AIKO	1019	GE	1000, 1004, 1008, 1013
AKAI	1009	GIBRALTER	1006, 1007, 1009
AOC	1007, 1009	GOLDSTAR	1000, 1002, 1007, 1009, 1015
AUDIOVOX	1004, 1019	GRANDIENTE	1015, 1026
BAUR	1005	HALLMARK	1000
BELCOR	1007	HARMAN/KARDON	1014
BELL & HOWELL	1021	HITACHI	1015, 1020, 1031
BROCKWOOD	1007	INFINITY	1014
BROKSONIC	1003	INTEQ	1006
CANDLE	1009, 1015	INTERFUNK	1005
CARNIVALE	1009	JBL	1014
CARVER	1014, 1026	JCB	1001
CELEBRITY	1001	JVC	1028
CINERAL	1004, 1019	KENWOOD	1007, 1009
CITIZEN	1009, 1015, 1016, 1019	KONIG	1005
CME	1005	KTV	1009
CONCERTO	1015	LG	1002, 1015
CROSLEY	1014	LOEWE	1005
CURTIS MATHES	1004, 1009, 1010, 1013, 1014, 1015, 1016, 1020, 1021	LUXMAN	1015
DAEWOO	1004, 1007, 1017, 1019, 1021	LXI	1000, 1014, 1021, 1022
DAYTRON	1007	MAGNAVOX	1009, 1014
DENON	1020	MARANTZ	1009, 1014
DUMONT	1006, 1007	MEGATRON	1000, 1020
DWIN	1010	MEMOREX	1000, 1015, 1021
ELECTRONBAND	1001	METZ	1000, 1007, 1009
EMERSON	1000, 1003, 1007, 1021	MGA	1007, 1009
ENVISION	1009	MILDLAND	1006, 1013
FISHER	1021	MINUTZ	1008
FORTRESS	1010	mitsubishi	1000, 1005, 1007, 1032
FUJITSU	1023, 1029	MTC	1005, 1007, 1009, 1015, 1016
		NAD	1000, 1022

Manufacturer name	Setting number	Manufacturer name	Setting number
NEC	1007, 1009, 1015, 1026	SANSEI	1004
NIKKO	1000, 1009, 1019	SANYO	1021
NTC	1019	SCIMITSU	1007
OPTIMUS	1021	SCOTCH	1000
OPTONICA	1010, 1025	SCOTT	1000, 1003, 1007
ORION	1003	SEARS	1000, 1014, 1015, 1021, 1022, 1027
OTTO	1005	SEMP	1022
PANASONIC	1013	SHOGUN	1007
PENNEY	1000, 1007, 1008, 1009, 1013, 1015, 1016, 1022	SONY	1001
PHILCO	1007, 1009, 1014, 1020	SOUNDESIGN	1000
PHILIPS	1014, 1033	SQUAREVIEW	1027
PILOT	1007, 1009	SSS	1007
PIONEER	1024	SUPREME	1001
PORTLAND	1007, 1019	SYLVANIA	1009, 1014
PRISM	1013	SYMPHONIC	1027
PROTON	1000	TANDY	1010
PULSAR	1006, 1007	TECHNICS	1013
QUASAR	1013, 1025	TECHWOOD	1013, 1015
QUELLE	1005	TEKNIKA	1007, 1014, 1015, 1016, 1019
RADIO SHACK	1000, 1007, 1009, 1015	TELEFUNKEN	1015
RCA	1007, 1010, 1011, 1013	THORN	1005
REALISTIC	1000, 1007, 1009, 1015, 1021, 1025	TMK	1000, 1015
RUNCO	1006, 1009	TOSHIBA	1016, 1021, 1022
SAMPO	1009	VECTOR RESERCH	1009
SAMSUNG	1000, 1007, 1009, 1015, 1016, 1030	VIDIKRON	1014
		VIDTECH	1000, 1007
		WARDS	1000, 1007, 1008, 1009, 1014, 1015, 1025
		YAMAHA	1007, 1009
		ZENITH	1006, 1019

(*): The default manufacturer numbers are 1010 (SHARP) for TV.

Troubleshooting chart

AN-PR1000H

Many potential problems can be resolved by the owner without calling a service technician.
If something is wrong with this product, check the following before calling your authorised SHARP dealer or service centre.

■ General

Symptom	Possible cause
No sound is heard.	<ul style="list-style-type: none"> ● Is input switching (selection) proper? ● Is muting activated? ● Is the volume level set to "0"?
The sound from subwoofer is not well balanced.	<ul style="list-style-type: none"> ● Is the speaker connection lead connected properly? ● Is the subwoofer sound level set to the minimum or maximum level?
Noise is heard during playback.	<ul style="list-style-type: none"> ● Move the unit away from any computers or mobile phones.
When a button is pressed, the unit does not respond.	<ul style="list-style-type: none"> ● Set this unit to the power stand-by mode and then turn it back on. If the unit still malfunctions, reset it.
The power is not turned on.	<ul style="list-style-type: none"> ● Is the unit unplugged? ● The protection circuit may be activated. Unplug and plug in the power lead again after 5 minutes or more.
The information is not displayed even if the unit is turned on.	<ul style="list-style-type: none"> ● Is the display set to "OFF mode"? Change it to the ON mode.

■ Remote control

Symptom	Possible cause
The remote control does not operate properly.	<ul style="list-style-type: none"> ● Is the battery polarity respected? ● Are the batteries dead? ● Is the distance or angle incorrect? ● Are there any obstructions in front of the unit? ● Is the remote control sensor exposed to strong light (inverter fluorescent light, direct sunlight, etc.)? ● Is the remote control for another equipment used simultaneously?
The unit cannot be turned on with the remote control.	<ul style="list-style-type: none"> ● Is the AC power lead of the unit plugged in? ● Are the batteries inserted?
The TV or DVD player cannot be operated with the remote control.	<ul style="list-style-type: none"> ● Is the manufacturer number correct? Depending on the model, some or all functions may not be operable using the remote control of this unit. In this case, use the supplied remote control.

Troubleshooting chart (continued)

■ If trouble occurs

When this product is subjected to strong external interference (mechanical shock, excessive static electricity, abnormal supply voltage due to lightning, etc.) or if it is operated incorrectly, it may malfunction.

If such a problem occurs, do the following:

- 1 Set the unit to the stand-by mode and turn the power on again.
- 2 If the unit is not restored in the previous operation, unplug and plug in the unit, and then turn the power on.

Note:

If neither operation above restores the unit, clear all the memory by resetting it.

Clearing all the memory (reset)

- 1 Unplug the unit.
- 2 Whilst holding down the FUNCTION button, plug in the AC power lead. "RESET" is displayed on the display for about 1 second, the unit is turned off.
- 3 Press the ON/STAND-BY button again to turn the power on.

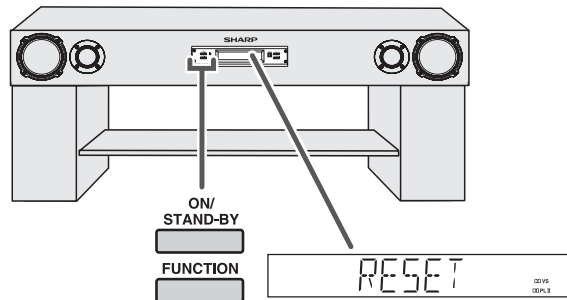

Caution:

If the unit is reset, each setting returns to default.

When the protection circuit is activated:

If the speaker connection lead is short-circuited, the protection circuit will be activated. When the protection circuit functions, the unit is turned off automatically. At that time, the power indicator blinks red and green alternately. Unplug the AC power lead and plug it in again after 5 minutes or more. Then check the operation. (*)

Error indicators and warnings

When you fail to perform operations properly, the following messages are displayed on the unit.

Display	Meaning
FAN LOCK	<ul style="list-style-type: none"> ● The cooling fan at the rear of the unit does not run. Unplug the AC power lead and check if foreign objects get caught around the cooling fan.
ERR 02	<ul style="list-style-type: none"> ● Malfunction of the surround circuit. Place the unit away from noise source and plug the AC power lead into another wall socket. (*)
ERR 07	
ERR 03	<ul style="list-style-type: none"> ● Malfunction of circuits other than the surround circuit. Place the unit away from noise source and plug the AC power lead into another wall socket. (*)
NO SIG	<ul style="list-style-type: none"> ● When there is no input signal. Play back the connected equipment.
	<ul style="list-style-type: none"> ● Nonstandard signal. Cannot be recognised. Signals other than DOLBY DIGITAL, DTS, Linear PCM cannot be recognised.
	<ul style="list-style-type: none"> ● Poor connection of the digital audio input terminal. Turn off the unit and check if the cable is connected properly.
 Power indicator	<ul style="list-style-type: none"> ● When the protection circuit of the amplifier is activated. See left.

(*): Should the same message appear even if the unit is unplugged and plugged in or is set to the stand-by mode and on again, contact your local dealer where you purchased the unit.

Maintenance

■ Cleaning the cabinet

Periodically wipe the cabinet with a soft cloth and a diluted soap solution, then with a dry cloth.

- Do not use chemicals for cleaning (petrol, paint thinner, etc.). It may damage the cabinet finish.
- Do not apply oil to the inside of each component. It may cause malfunctions.

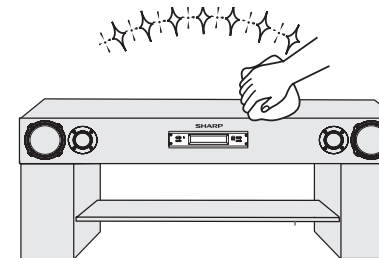

Specifications

As part of our policy of continuous improvement, SHARP reserves the right to make design and specification changes for product improvement without prior notice. The performance specification figures indicated are nominal values of production units. There may be some deviations from these values in individual units.

● Main unit

Amplifier section	
Power source	AC 220 V - 240 V, 50 Hz
Power consumption	Power on: 80 W Power stand-by: 0.6 W
Amplification system	Front speaker: Pulse width modulation Subwoofer: Pulse width modulation
Frequency range	FM : 87.5 - 108 MHz
Output power	Front speaker: RMS: 150W (75W + 75W) (10% T.H.D) Subwoofer: RMS: 150W (75W + 75W) (10% T.H.D)
Audio input terminals	Optical digital input (DIGITAL 1/2): Square type × 2 Coaxial digital input (DIGITAL 3): RCA type × 1 Analog input (LINE 1): RCA type × 1 pair (L/R) Analog input (LINE 2): RCA type × 1 pair (L/R) Analog input (LINE 3): RCA type × 1 pair (L/R)
Audio output terminal	Subwoofer Pre Out: 10 kohms
Front speaker section	
Type	2-way type speaker system (Magnetic shield) 5 cm (2") Tweeter × 1 10 cm (4") Woofer × 1
Impedance	4 ohms

General	
Dimensions	Width: 1230 mm (48-7/16") Height: 476 mm (18-3/4") Depth: 383 mm (15-1/8")
Weight	46.5 kg (102.3 lbs.)

● Subwoofer

Type	Bass reflex system 16 cm (6-1/2") Woofer × 1
Maximum input power	150 W
Impedance	4 ohms

● Remote control

Power source	DC 3V ["AAA" size (UM-4, R03, HP-16 or similar) battery × 2]
---------------------	--

MEMO

SHARP

FOR LOCATION ENQUIRIES WITHIN

AUSTRALIA

REGARDING YOUR LOCAL

SHARP APPROVED SERVICE CENTRE

VISIT OUR WEBSITE AT

www.sharp.net.au

OR CALL SHARP CUSTOMER CARE

1300 135 022

(LOCAL CALL COST APPLY WITHIN AUSTRALIA)

SHARP CORPORATION OF AUSTRALIA PTY LTD

SHARP

FOR LOCATION ENQUIRIES WITHIN

NEW ZEALAND

REGARDING YOUR LOCAL

SHARP APPROVED SERVICE CENTRE

VISIT OUR WEBSITE AT

www.sharp.net.nz

CONTACT YOUR SELLING DEALER/RETAILER

OR CALL

SHARP CUSTOMER SERVICES

TELEPHONE: 09 573 0111

FACSIMILE: 09 573 0113

SHARP CORPORATION OF NEW ZEALAND LIMITED

SPform019(JUNE 2004)

SHARP WARRANTY

Consumer Electronic Products

Congratulations on Your Purchase!

This Sharp product is warranted against faults in materials and manufacture for a period of twelve(12) months from the date of original purchase.

If service is required during the warranty period, please contact your nearest Sharp Approved Service Centre. These repairs would be carried out at no charge to the owner, subject to the conditions specified herein.

The owner is responsible for any transportation and insurance costs if the product has to be returned for repair.

This warranty does not extend to accessories or defects or injuries caused by or resulting from causes not attributable to faulty parts or the manufacture of the product, including but not limited to, defect or injury caused by or resulting from misuse, abuse, neglect, accidental damage, improper voltage, liquid spillage, vermin infestation, software, or any alterations made to the product which are not authorised by Sharp.

Please retain your sales documentation, as this should be produced to validate a warranty claim.

This warranty is in addition to and in no way limits, varies or excludes any express and implied rights and remedies under any relevant legislation in the country of sale.

IMPORTANT DO NOT RETURN THIS DOCUMENT TO SHARP

For your reference, please enter the particulars of your purchase below and retain, with your purchase documentation.

Model No. _____ Date of Purchase _____

Serial No. _____ Retailer _____

SHARP
SHARP CORPORATION OF
AUSTRALIA PTY, LIMITED
ABN 40 003 030 405
1 Huntingwood Drive
Huntingwood NSW 2148
SHARP CORPORATION OF
NEW ZEALAND LIMITED
59 Hugo Johnston Drive
Petrossa, Auckland
SPR00014 (01/01/2004)

IMPORTANT NOTICE: This warranty applies only to products sold in Australia & New Zealand

SHARP

SHARP CORPORATION

TINSEA143AWZZ
06G R AS ①

Free Manuals Download Website

<http://myh66.com>

<http://usermanuals.us>

<http://www.somanuals.com>

<http://www.4manuals.cc>

<http://www.manual-lib.com>

<http://www.404manual.com>

<http://www.luxmanual.com>

<http://aubethermostatmanual.com>

Golf course search by state

<http://golfingnear.com>

Email search by domain

<http://emailbydomain.com>

Auto manuals search

<http://auto.somanuals.com>

TV manuals search

<http://tv.somanuals.com>