

SHARP[®]
Carousel[®]

Models R-1490, R-1491, R1492

microwave

cooking guide



1490
R-1492

FOR CUSTOMER ASSISTANCE

To aid in reporting this microwave oven in case of loss or theft, please record below the model number and serial number located on the unit. We also suggest you record all the information listed and retain for future reference.

MODEL NUMBER _____	SERIAL NUMBER _____
DATE OF PURCHASE _____	
DEALER _____	TELEPHONE _____
SERVICER _____	TELEPHONE _____

TO PHONE:

DIAL 1-800-BE-SHARP (237-4277) for:

SERVICE (for your nearest Sharp Authorized Servicer)
PARTS (for your authorized parts distributor)
ADDITIONAL CUSTOMER INFORMATION

DIAL 1-800-642-2122 for:

ACCESSORIES and COOKBOOK

DIAL (201)529-8703 for :

COOKING ASSISTANCE

TO WRITE:

For cooking and operation questions:

Susan Edwards/Test Kitchen
Sharp Electronics Corporation
Sharp Plaza, Box 650
Mahwah, NJ 07430-2135

For service problems, warranty information, missing items and other assistance:

Sharp Electronics Corporation
Customer Assistance Center
1300 Naperville Drive
Romeoville, IL 60446-1091

Please provide the following information when you write or call: model number, serial number, date of purchase, your complete mailing address (including zip code), your daytime telephone number (including area code) and description of the problem.

TO ACCESS INTERNET: www.sharp-usa.com

PRECAUTIONS TO AVOID POSSIBLE EXPOSURE TO EXCESSIVE MICROWAVE ENERGY

- (a) Do not attempt to operate this oven with the door open since open-door operation can result in harmful exposure to microwave energy. It is important not to defeat or tamper with the safety interlocks.
- (b) Do not place any object between the oven front face and the door or allow soil or cleaner residue to accumulate on sealing surfaces.
- (c) Do not operate the oven if it is damaged. It is particularly important that the oven door close properly and that there is no damage to the: (1) door (bent), (2) hinges and latches (broken or loosened), (3) door seals and sealing surfaces.
- (d) The oven should not be adjusted or repaired by anyone except properly qualified service personnel.

CONTENTS OF OPERATION MANUAL & COOKING GUIDE

For Customer Assistance....	Inside Front Cover	Other Sensor Cooking Settings	12
Precautions to Avoid Possible		Sensor Cooking Chart	12-13
Exposure to Excessive		Sensor Cooking Recipes	14-15
Microwave Energy	Inside Front Cover	CompuCook	16
Contents	1	CompuCook Chart	16-17
Consumer Limited Warranty	2	CompuDefrost	17
Product Information Card	2	CompuDefrost Chart	17-18
Important Safety Instructions	3	Manual Defrost.....	18
Unpacking Instructions	4	Other Convenient Features	16-17
Optional Accessories	4	Minute Plus	19
Grounding Instructions	4	Multiple Sequence Cooking	19
Information You Need to Know	5-7	Demonstration Mode	19
About Your Oven	5	Kitchen Timer	19
About Food	5	Touch On	19
About Microwave Cooking	6	Custom Help	20
About Safety	6	1. Child Lock	20
About Utensils and Coverings	7	2. Audible Signal Elimination	20
About Children and the Microwave	7	3. Auto Start	20
Part Names	8	4. & 5. Language/Weight Selection	20
Touch-Control Panel	9	More or Less Time Adjustment	20
Before Operating	10	Help	20
To Set the Clock	10	Cleaning and Care	21-22
Stop/Clear	10	Service Call Check	23
Manual Operation	10	THE ULTIMATE ACCESSORY	23
Time Cooking	10	Specifications	24
Turntable On/Off	11	Cookbook Order Form	24
Special Features	11-18	Guia Auto-Touch.....	Parte Interior de la Cubierta Trasera
Sensor Cooking	11-12	Auto-Touch Guide.....	Back Cover
Sensor Reheat	12		

INTERACTIVE COOKING SYSTEM

The Interactive Cooking System offers step-by-step instructions in the display for using the oven, from setting the clock to programming each feature. It also includes Custom Help for instructions on using Child Lock, Audible Signal Elimination and Auto Start. There is a choice of English, Spanish or French and a choice of U.S. Customary Unit-pound or Metric-kilograms. Touch Custom Help and follow the directions displayed or check page 20.

CONSUMER LIMITED WARRANTY

SHARP ELECTRONICS CORPORATION warrants to the first consumer purchaser that this Sharp brand product (the "Product"), when shipped in its original container, will be free from defective workmanship and materials, and agrees that it will, at its option, either repair the defect or replace the defective Product or part thereof with a new or remanufactured equivalent at no charge to the purchaser for parts or labor for the period(s) set forth below.

This warranty does not apply to any appearance items of the Product nor to the additional excluded item(s) set forth below nor to any Product the exterior of which has been damaged or defaced, which has been subjected to misuse, abnormal service or handling, or which has been altered or modified in design or construction.

In order to enforce the rights under this limited warranty, the purchaser should follow the steps set forth below and provide proof of purchase to the servicer.

The limited warranty described herein is in addition to whatever implied warranties may be granted to purchasers by law. ALL IMPLIED WARRANTIES INCLUDING THE WARRANTIES OF MERCHANTABILITY AND FITNESS FOR USE ARE LIMITED TO THE PERIOD(S) FROM THE DATE OF PURCHASE SET FORTH BELOW. Some states do not allow limitations on how long an implied warranty lasts, so the above limitation may not apply to you.

Neither the sales personnel of the seller nor any other person is authorized to make any warranties other than those described herein, or to extend the duration of any warranties beyond the time period described above on behalf of Sharp.

The warranties described herein shall be the sole and exclusive warranties granted by Sharp and shall be the sole and exclusive remedy available to the purchaser. Correction of defects, in the manner and for the period of time described herein, shall constitute complete fulfillment of all liabilities and responsibilities of Sharp to the purchaser with respect to the Product, and shall constitute full satisfaction of all claims, whether based on contract, negligence, strict liability or otherwise. In no event shall Sharp be liable, or in any way responsible, for any damages or defects in the Product which were caused by repairs or attempted repairs performed by anyone other than an authorized servicer. Nor shall Sharp be liable or in any way responsible for any incidental or consequential economic or property damage. Some states do not allow the exclusion of incidental or consequential damages, so the above exclusion may not apply to you.

THIS WARRANTY GIVES YOU SPECIFIC LEGAL RIGHTS. YOU MAY ALSO HAVE OTHER RIGHTS WHICH VARY FROM STATE TO STATE.

Your Product Model Number & Description:

R-1490, R-1491 and R-1492 Home Use Carousel Microwave Oven.
(Be sure to have this information available when you need service for your Product.)

Warranty Period for this Product:

One (1) year parts and labor in-home service. The warranty period continues for an additional six (6) years, for a total of seven (7) years, with respect to the magnetron tube in the Product for parts only. Labor and the servicer trip charge are not provided free of charge for this additional period.

Additional Item(s) Excluded from Warranty Coverage (if any):

Accessories, rubber or plastic parts, the turntable, light bulbs, glass parts or any printed materials.

Where to Obtain Service:

From a Sharp Authorized Servicer located In the United States. Be sure to have **Proof of Purchase** available. To find the location of the nearest Sharp Authorized Servicer, call Sharp toll free at 1-800-BE-SHARP (1-800-237-4277). For in-home service, the servicer will come to the unit's location. If it is necessary to remove the unit for repair, the servicer will reinstall the unit at no extra charge, provided it was installed according to Sharp's Installation Instructions.

TO OBTAIN SUPPLY, ACCESSORY OR PRODUCT INFORMATION, CALL 1-800-BE-SHARP OR VISIT www.sharp-usa.com.
SAVE THE PROOF OF PURCHASE AS IT IS NEEDED SHOULD YOUR OVEN EVER REQUIRE WARRANTY SERVICE.

PRODUCT INFORMATION CARD

The Product information card should be completed within ten days of purchase and returned. We will keep it on file and help you access the information in case of loss, damage or theft. This will also enable us to contact you in the unlikely event that any adjustments or modifications are ever required for your oven.

IMPORTANT SAFETY INSTRUCTIONS

When using electrical appliances basic safety precautions should be followed, including the following:

WARNING - To reduce the risk of burns, electric shock, fire, injury to persons or exposure to excessive microwave energy:

1. Read all instructions before using the appliance.
2. Read and follow the specific **“PRECAUTIONS TO AVOID POSSIBLE EXPOSURE TO EXCESSIVE MICROWAVE ENERGY”** on inside front cover.
3. This appliance must be grounded. Connect only to properly grounded outlet. See **“GROUNDING INSTRUCTIONS”** on page 4 and **INSTALLATION INSTRUCTIONS**.
4. Install or locate this appliance only in accordance with the provided installation instructions.
5. Some products such as whole eggs and sealed containers—for example, closed glass jars—may explode and should not be heated in this oven.
6. Use this appliance only for its intended use as described in this manual. Do not use corrosive chemicals or vapors in this appliance. This type of oven is specifically designed to heat, cook or dry food. It is not designed for industrial or laboratory use.
7. As with any appliance, close supervision is necessary when used by children.
8. Do not operate this appliance if it has a damaged cord or plug, if it is not working properly or if it has been damaged or dropped.
9. This appliance should be serviced only by qualified service personnel. Contact nearest Sharp Authorized Servicer for examination, repair or adjustment.
10. Do not cover or block any openings on the appliance.
11. Do not store or use this appliance outdoors. Do not use this product near water—for example, near a kitchen sink, in a wet basement or near a swimming pool, and the like.
12. Do not immerse cord or plug in water.
13. Keep cord away from heated surfaces.
14. Do not let cord hang over edge of table or counter.
15. See door surface cleaning instructions on page 21.
16. To reduce the risk of fire in the oven cavity:
 - a. Do not overcook food. Carefully attend appliance if paper, plastic or other combustible materials are placed inside the oven to facilitate cooking.
 - b. Remove wire twist-ties from paper or plastic bags before placing bag in oven.
 - c. **If materials inside the oven should ignite, keep oven door closed, turn oven off and disconnect the power cord or shut off power at the fuse or circuit breaker panel.**
 - d. Do not use the cavity for storage purposes. Do not leave paper products, cooking utensils or food in the cavity when not in use.
17. Clean ventilation openings and grease filters frequently—Grease should not be allowed to accumulate on ventilation openings, hood (louver) or grease filters.
18. Use care when cleaning the louver and the grease filters. Corrosive cleaning agents, such as lye-based oven cleaners, may damage the louver and the grease filters.
19. When flaming food under the hood, turn the fan on.
20. This appliance is suitable for use above both gas and electric cooking equipment 36” wide or less.

SAVE THESE INSTRUCTIONS

UNPACKING INSTRUCTIONS

Unpacking and Examining Your Oven

Carefully remove oven from carton. **SAVE THE CARTON AS IT MAY MAKE INSTALLATION EASIER.**

Remove:

1. all packing materials from inside the oven cavity; however, **DO NOT REMOVE THE WAVEGUIDE COVER**, which is located on the ceiling in the oven cavity. Check to see that there are Installation Instructions, Wall Template, Top Cabinet Template, bag of Installation Hardware, Charcoal Filter and Exhaust Damper Assembly. Read enclosures and **SAVE** the Operation Manual.
2. the feature sticker from the outside of the door, if there is one.

Check the oven for any damage, such as misaligned or bent door, damaged door seals and sealing surfaces, broken or loose door hinges and latches and dents inside the cavity or on the door. If there is any damage, do not operate the oven and contact your dealer or **SHARP AUTHORIZED SERVICER**.

See Installation Instructions for more details.

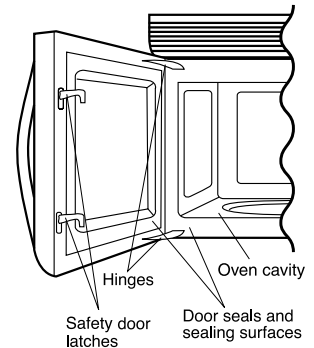

OPTIONAL ACCESSORIES

Two optional accessories are available for this oven.

1. Charcoal Filter (RK-230). This is required when hood exhaust is recirculated. See Charcoal Filter on page 22. If the dealer does not stock the Charcoal Filter, simply call 1-800-642-2122 to order replacement. Have your credit card ready.
2. Filler Panel Kit. For use when the oven is installed in a 36-inch or 42-inch wide opening. The metal filler panels come in 3-inch wide pairs. One set is needed for a 36-inch opening and 2 sets for a 42-inch opening. White and black are available.

To purchase contact: Modern-Aire Manufacturing Corporation
7319 Lankershim Blvd.
North Hollywood, CA 91605
Phone: (818) 765-9870 or (213) 875-1350 Fax: (818) 765-4916

GROUNDING INSTRUCTIONS

This appliance must be grounded. This oven is equipped with a cord having a grounding wire with a grounding plug. It must be plugged into a wall receptacle that is properly installed and grounded in accordance with the National Electrical Code and local codes and ordinances. In the event of an electrical short circuit, grounding reduces risk of electric shock by providing an escape wire for the electric current.

WARNING – Improper use of the grounding plug can result in a risk of electric shock.

Electrical Requirements

Check Installation Instructions for proper location for the power supply.

The electrical requirements are a 120 volt 60 Hz, AC only, 15 amp. or more protected electrical supply. It is recommended that a separate circuit serving only the oven be provided.

The oven is equipped with a 3-prong grounding plug. It must be plugged into a wall receptacle that is properly installed and grounded. **DO NOT UNDER ANY CIRCUMSTANCES CUT OR REMOVE THE GROUNDING PIN FROM THE PLUG.**

Notes: 1. If you have any questions about the grounding or electrical instructions, consult a qualified electrician or service person.

2. Neither Sharp nor the dealer can accept any liability for damage to the oven or personal injury resulting from failure to observe the correct electrical connection procedures.

Radio or TV Interference

Should there be any interference caused by the microwave oven to your radio or TV, check that the microwave oven is on a different electrical circuit, relocate the radio or TV as far away from the oven as feasible or check position and signal of receiving antenna.

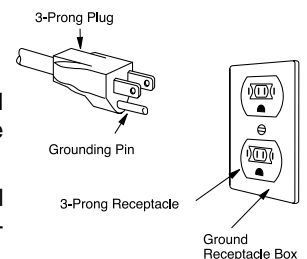

INFORMATION YOU NEED TO KNOW

ABOUT YOUR OVEN

This Operation Manual is valuable: read it carefully and always save it for reference.

A good microwave cookbook is a valuable asset. Check it for microwave cooking principles, techniques, hints and recipes. See pages 23 and 24 for ordering the Ultimate Accessory, the SHARP CAROUSEL MICROWAVE COOKBOOK.

NEVER use the oven without the turntable and support nor turn the turntable over so that a large dish could be placed in the oven. The turntable will turn both clockwise and counterclockwise. See page 11 for complete instructions.

ALWAYS have food in the oven when it is on to absorb the microwave energy.

When using the oven at power levels below 100%, you may hear the magnetron cycling on and off.

Condensation is a normal part of microwave cooking. Room humidity and the moisture in food will influence the amount of moisture that condenses in the oven. Generally, covered foods will not cause as much condensation as uncovered ones. Ventilation openings must not be blocked.

The oven is for food preparation only. It should not be used to dry clothes or newspapers.

Your oven is rated 950 watts by using the IEC Test Procedure. In using recipes or package directions, check food a minute or two before the minimum time and add time accordingly.

About Food

FOOD	DO	DON'T
Eggs, sausages, nuts, seeds, fruits & vegetables	<ul style="list-style-type: none">• Puncture egg yolks before cooking to prevent "explosion".• Pierce skins of potatoes, apples, squash, hot dogs and sausages so that steam escapes.	<ul style="list-style-type: none">• Cook eggs in shells.• Reheat whole eggs.• Dry nuts or seeds in shells.
Popcorn	<ul style="list-style-type: none">• Use specially bagged popcorn for the microwave oven.• Listen while popping corn for the popping to slow to 1 or 2 seconds or use special Popcorn pad.	<ul style="list-style-type: none">• Pop popcorn in regular brown bags or glass bowls.• Exceed maximum time on popcorn package.
Baby food	<ul style="list-style-type: none">• Transfer baby food to small dish and heat carefully, stirring often. Check temperature before serving.• Put nipples on bottles after heating and shake thoroughly. "Wrist" test before feeding.	<ul style="list-style-type: none">• Heat disposable bottles.• Heat bottles with nipples on.• Heat baby food in original jars.
General	<ul style="list-style-type: none">• Cut baked goods with filling after heating to release steam and avoid burns.• Stir liquids briskly before and after heating to avoid "eruption".• Use deep bowl, when cooking liquids or cereals, to prevent boilovers.	<ul style="list-style-type: none">• Heat or cook in closed glass jars or air tight containers.• Can in the microwave as harmful bacteria may not be destroyed.• Deep fat fry.• Dry wood, gourds, herbs or wet papers.

ABOUT MICROWAVE COOKING

- Arrange food carefully. Place thickest areas towards outside of dish.
- Watch cooking time. Cook for the shortest amount of time indicated and add more as needed. Food severely overcooked can smoke or ignite.
- Cover foods while cooking. Check recipe or cook-book for suggestions: paper towels, wax paper, microwave plastic wrap or a lid. Covers prevent splattering and help foods to cook evenly.
- Shield with small flat pieces of aluminum foil any thin areas of meat or poultry to prevent overcooking before dense, thick areas are cooked thoroughly.
- Stir foods from outside to center of dish once or twice during cooking, if possible.
- Turn foods over once during microwaving to speed cooking of such foods as chicken and hamburgers. Large items like roasts must be turned over at least once.
- Rearrange foods such as meatballs halfway through cooking both from top to bottom and from the center of the dish to the outside.
- Add standing time. Remove food from oven and stir, if possible. Cover for standing time which allows the food to finish cooking without overcooking.
- Check for doneness. Look for signs indicating that cooking temperatures have been reached.
 - Doneness signs include:**
 - Food steams throughout, not just at edge.
 - Center bottom of dish is very hot to the touch.
 - Poultry thigh joints move easily.
 - Meat and poultry show no pinkness.
 - Fish is opaque and flakes easily with a fork.

ABOUT SAFETY

- Check foods to see that they are cooked to the United States Department of Agriculture's recommended temperatures.
- ALWAYS use potholders to prevent burns when handling utensils that are in contact with hot food. Enough heat from the food can transfer through utensils to cause skin burns.
- Avoid steam burns by directing steam away from the face and hands. Slowly lift the farthest edge of a dish's covering and carefully open popcorn and oven cooking bags away from the face.
- Stay near the oven while it's in use and check cooking progress frequently so that there is no chance of overcooking food.
- NEVER use the cavity for storing cookbooks or other items.
- Select, store and handle food carefully to preserve its high quality and minimize the spread of foodborne bacteria.
- Keep waveguide cover clean. Food residue can cause arcing and/or fires.
- Use care when removing items from the oven so that the utensil, your clothes or accessories do not touch the safety door latches.

TEMP	FOOD
160°F	... for fresh pork, ground meat, boneless white poultry, fish, seafood, egg dishes and frozen prepared food.
165°F	... for leftover, ready-to-reheat refrigerated, and deli and carry-out "fresh" food.
170°F	... white meat of poultry.
180°F	... dark meat of poultry.

To test for doneness, insert a meat thermometer in a thick or dense area away from fat or bone. NEVER leave the thermometer in the food during cooking, unless it is approved for microwave oven use.

ABOUT UTENSILS AND COVERINGS

It is not necessary to buy all new cookware. Many pieces already in your kitchen can be used successfully in your new microwave oven. Make sure the utensil does not touch the interior walls during cooking.

Use these utensils for safe microwave cooking and reheating:

- glass ceramic (Pyroceram®), such as Corningware®.
- heat-resistant glass (Pyrex®)
- microwave-safe plastics
- paper plates
- microwave-safe pottery, stoneware and porcelain
- browning dish (Do not exceed recommended preheating time. Follow manufacturer's directions.)

These items can be used for short time reheating of foods that have little fat or sugar in them:

- wood, straw, wicker

DO NOT USE

- metal pans and bakeware
- dishes with metallic trim
- non-heat-resistant glass
- non-microwave-safe plastics (margarine tubs)
- recycled paper products
- brown paper bags
- food storage bags
- metal twist-ties

Should you wish to check if a dish is safe for microwaving, place the empty dish in the oven and microwave on HIGH for 30 seconds. A dish which becomes very hot should not be used.

ABOUT CHILDREN AND THE MICROWAVE

Children below the age of 7 should use the microwave oven with a supervising person very near to them. Between the ages of 7 and 12, the supervising person should be in the same room.

The child must be able to reach the oven comfortably; if not, he/she should stand on a sturdy stool.

At no time should anyone be allowed to lean or swing on the oven door.

The following coverings are ideal:

- Paper towels are good for covering foods for reheating and absorbing fat while cooking bacon.
- Wax paper can be used for cooking and reheating.
- Plastic wrap that is specially marked for microwave use can be used for cooking and reheating. DO NOT allow plastic wrap to touch food. Vent so steam can escape.
- Lids that are microwave-safe are a good choice because heat is kept near the food to hasten cooking.
- Oven cooking bags are good for large meats or foods that need tenderizing. DO NOT use metal twist ties. Remember to slit bag so steam can escape.

How to use aluminum foil in your microwave oven:

- Small flat pieces of aluminum foil placed smoothly on the food can be used to shield areas that are either defrosting or cooking too quickly.
- Foil should not come closer than one inch to any surface of the oven.

Should you have questions about utensils or coverings, check a good microwave cookbook or follow recipe suggestions.

ACCESSORIES There are many microwave accessories available for purchase. Evaluate carefully before you purchase so that they meet your needs. A microwave-safe thermometer will assist you in determining correct doneness and assure you that foods have been cooked to safe temperatures. Sharp is not responsible for any damage to the oven when accessories are used.

Children should be taught all safety precautions: use potholders, remove coverings carefully, pay special attention to packages that crisp food because they may be extra hot.

Don't assume that because a child has mastered one cooking skill he/she can cook everything.

Children need to learn that the microwave oven is not a toy. See page 20 for Child Lock feature.

PART NAMES

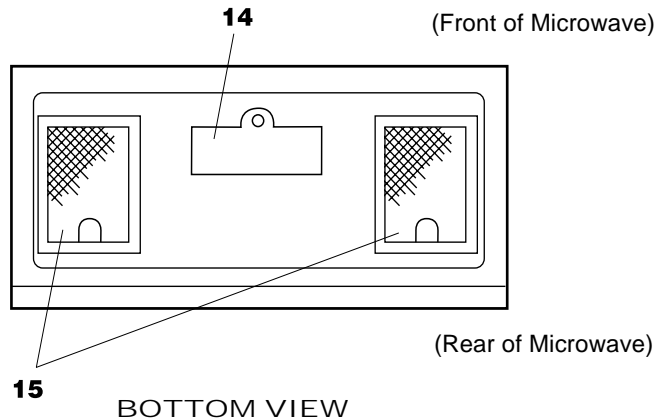
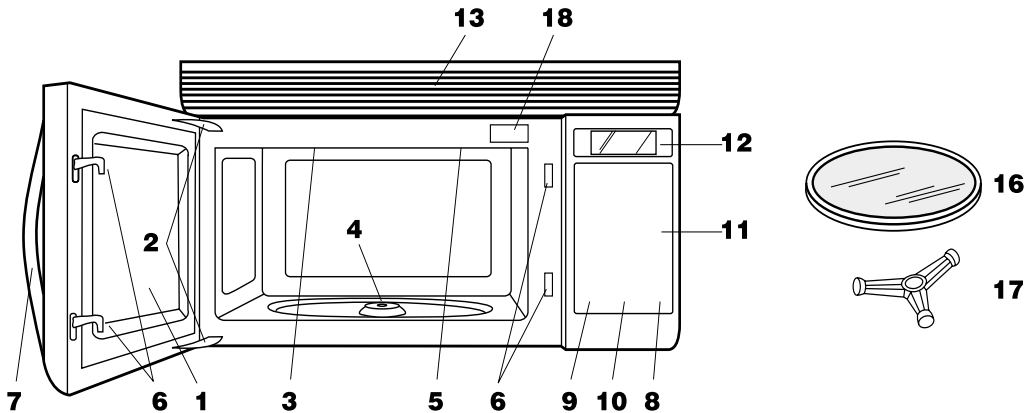

- | | |
|---|---|
| <p>1 Oven door with see-through window</p> <p>2 Door hinges</p> <p>3 Waveguide cover
DO NOT REMOVE.</p> <p>4 Turntable motor shaft</p> <p>5 Oven light
It will light when oven is operating or door is open.</p> <p>6 Safety door latches
The oven will not operate unless the door is securely closed.</p> <p>7 Handle</p> <p>8 Fan pad
Press the Fan Hi/Lo pad to turn on the fan. Press again for low speed. Press a third time to turn the fan off.</p> <p>9 Work light pad
Press the Work Light pad to turn light on or off.</p> | <p>10 Night light pad
Press the Night Light pad to turn light on or off. This setting assures enough light to move about in a darkened kitchen.</p> <p>11 Auto-Touch control panel</p> <p>12 Time display: Digital display, 99 minutes, 99 seconds</p> <p>13 Ventilation openings</p> <p>14 Light cover</p> <p>15 Grease filters</p> <p>16 Removable turntable
The turntable will rotate clockwise or counter-clockwise. Only remove for cleaning.</p> <p>17 Removable turntable support
First, carefully place the turntable support in the motor shaft in the center of the oven floor. Then, place the turntable on the turntable support securely.</p> <p>18 Menu label</p> |
|---|---|

TOUCH CONTROL PANEL

Control panel display

Words will light in the display to indicate features and cooking instructions.

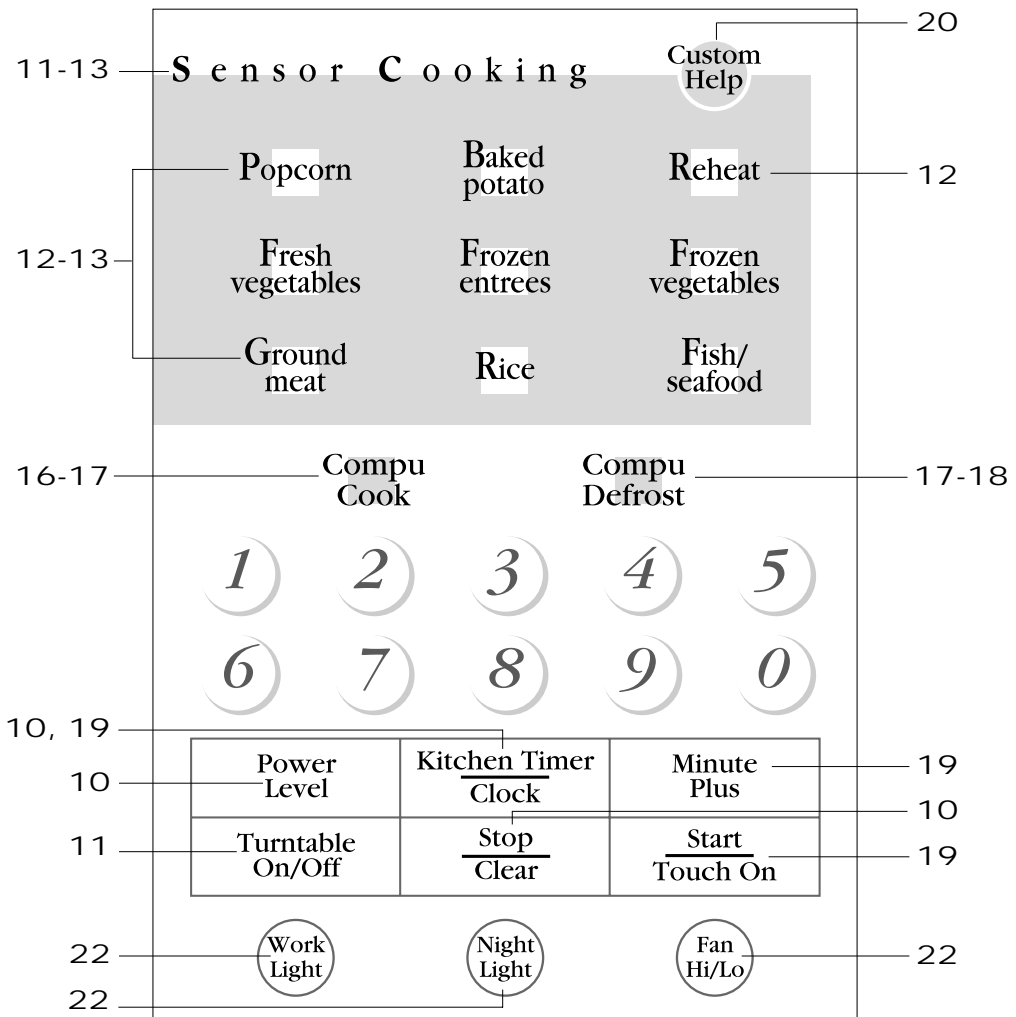

R-1490 / R-1491 / R-1492

Number next to the control panel illustration indicates page on which there are a feature description and usage information.

BEFORE OPERATING

- Before operating your new microwave oven make sure you read and understand this operation manual completely.
- Before the oven can be used, follow these procedures:
 - Plug in the oven. Close the door. The oven display will show **SHARP** **SIMPLY** **THE** **BEST** **PRESS** **CLEAR** **AND** **PRESS** **CLOCK**.
 - Touch the Stop/Clear pad. **:** will appear.
 - Set clock.

TO SET THE CLOCK

- Suppose you want to enter the correct time of day 12:30 (A.M. or P.M.).

PROCEDURE	DISPLAY
1 Touch Kitchen Timer/Clock pad. Press number 2.	TO SET CLOCK PRESS 2 2
2 1 2 3 0 Enter the correct time of day by touching the numbers in sequence.	12:30
3 Kitchen Timer Clock Touch Kitchen Timer/Clock pad again.	12:30

This is a 12 hour clock. If you attempt to enter an incorrect clock time, **ERROR** will appear in the display. Touch the Stop/Clear pad and re-enter the time.

- If the electrical power supply to your microwave oven should be interrupted, the display will intermittently show **SHARP** **SIMPLY** **THE** **BEST** **PRESS** **CLEAR** **AND** **PRESS** **CLOCK** after the power is reinstated. If this occurs during cooking, the program will be erased. The time of day will also be erased. Simply touch Stop/Clear pad and reset the clock for the correct time of day.

NOTE: Your oven can be programmed with the door open except for Start/Touch On, Sensor Cooking and Minute Plus.

STOP/CLEAR

Touch the Stop/Clear pad to:

- Erase if you make a mistake during programming.
- Cancel kitchen timer.
- Stop the oven temporarily during cooking.
- Return the time of day to the display.
- Cancel a program during cooking, touch twice.

MANUAL OPERATION

TIME COOKING

Your oven can be programmed for 99 minutes and 99 seconds (99.99). Always enter the seconds after the minutes, even if they are both zeros.

- Suppose you want to cook for 5 minutes at 100%.

PROCEDURE	DISPLAY
1 5 0 0 Enter cooking time.	5.00
2 Start Touch On Touch Start/Touch On pad.	5.00 <small>COOK</small>

There are eleven preset power levels.

Using lower power levels increases the cooking time which is recommended for foods such as cheese, milk and long slow cooking of meats. Consult cookbook or recipes for specific recommendations.

TOUCH POWER LEVEL PAD ONCE THEN TOUCH	APPROXIMATE PERCENTAGE OF POWER	COMMON WORDS FOR POWER LEVELS
Power Level	100%	High
9	90%	
8	80%	
7	70%	Medium High
6	60%	
5	50%	Medium
4	40%	
3	30%	Med Low/Defrost
2	20%	
1	10%	Low
0	0%	

- Suppose you want to cook for 5 minutes at 30%.







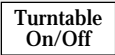

PROCEDURE	DISPLAY
1 5 0 0 Enter cooking time.	5.00
2 Power Level 3 Touch Power Level pad. Enter number 3 for power level.	P-30
3 Start Touch On Touch Start/Touch On pad.	5.00 <small>COOK</small>

MANUAL OPERATION

TURNTABLE ON/OFF

For most cooking, the turntable should be on; however the turntable can be turned off so that it does not rotate when extra large dishes, such as the popular 13 x 9 x 2 glass utility casserole, are used. The casserole should be placed on the turntable so that it is level.

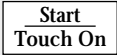
- Suppose you want to cook lasagna in a 13 x 9 x 2 casserole for 45 minutes on 40% power.

PROCEDURE	DISPLAY
1 	
Touch Turntable On/Off pad and note TURNTABLE OFF in the display.	
2 	
Enter cooking time.	
3  	
Touch Power Level pad. Enter number 4 for power level.	
4 	
Touch Start/Touch On pad.	

NOTE:

The door can be opened for checking food and the turntable will stay in the off position. After checking, close door and touch Start/Touch On.

The turntable will stay off for one minute after door is opened when time-of-day appears in the display. It is possible to reprogram the oven during that minute without touching the Turntable On/Off pad. The display indicates when the turntable is off.

Sensor Reheat has 2 options for use with turntable off and a 13 x 9 x 2 glass utility casserole. One setting is for casseroles in which the ingredients can be stirred midway through the cycle, such as for macaroni and cheese. The other is for casseroles which cannot be stirred, such as lasagna. To use these settings, simply touch Turntable On/Off, Reheat and then follow the directions in the Interactive Display. All other special features can only be used with the turntable on.

When cooking large quantities of food which cannot be stirred, it is best to use a lower power level such as 40 or 50%. You may speed cooking or large amount by programming 5 to 10 minutes on 100% power (HIGH) followed by the desired time on lower power. See page 19 for how to program multiple sequences. You may wish to reverse a large casserole once during cooking; simply open door, reposition casserole, close door and touch Start/Touch On.

SPECIAL FEATURES

SENSOR COOKING

Sharp's Sensor is a semi-conductor device that detects the vapor (moisture and humidity) emitted from the food as it heats. The sensor adjusts the cooking times and power level for various foods and quantities.

Using Sensor Settings:

1. After oven is plugged in, wait 2 minutes before using Sensor Cooking.
2. Be sure the exterior of the cooking container and the interior of the oven are dry. Wipe off any moisture with a dry cloth or paper towel.
3. The oven works with foods at normal storage temperature. For example, popcorn would be at room temperature.
4. Any Sensor Cooking selection can be programmed with More or Less Time Adjustment. See page 20.
5. More or less food than the quantity listed in the chart should be cooked following the guidelines in any microwave cookbook.
6. During the first part of Sensor Cooking, food name will appear on the display. Do not open the oven door or touch Stop/Clear during this part of the cooking cycle.

The measurement of vapor will be interrupted. If this occurs, an error message will appear. To continue cooking, touch the Stop/Clear pad and cook manually.

When the sensor detects the vapor emitted from the food, remainder of cooking time will appear. Door may be opened when remaining cooking time appears on the display. At this time, you may stir or season food, as desired.

7. If the sensor does not detect vapor properly when popping popcorn, the oven will turn off, and the correct time of day will be displayed. If the sensor does not detect vapor properly when cooking other foods,  will be displayed, and the oven will turn off.
8. Check food for temperature after cooking. If additional time is needed, continue to cook manually.
9. Each food has a cooking hint. Touch Custom Help when the HELP indicator is lighted in the display.

Covering Foods:

Some foods work best when covered. Use the cover recommended in the chart for these foods.

1. Casserole lid.

SPECIAL FEATURES

2. Plastic wrap: Use plastic wrap recommended for microwave cooking. Cover dish loosely; allow approximately 1/2 inch to remain uncovered to allow steam to escape. Plastic wrap should not touch food.
3. Wax paper: Cover dish completely; fold excess wrap under dish to secure. If dish is wider than paper, overlap two pieces at least one inch to cover.

Be careful when removing any covering to allow steam to escape away from you.

SENSOR REHEAT

You can reheat foods by touching just one pad. You don't need to calculate cooking time or power level.

- Suppose you want to reheat a bowl of soup.

PROCEDURE		DISPLAY	
1	Reheat Touch Reheat pad. When sensor detects the vapor emitted from the food, remainder of reheating time will appear.	SENSOR	REHEAT
2	At end, follow the directions in the display.	LET COVERED	STAND

SENSOR REHEAT CHART

FOOD	AMOUNT	PROCEDURE
Reheat: Turntable On	4 - 36oz	Place in dish or casserole slightly larger than amount to be reheated. Flatten, if possible. Cover with lid, plastic wrap or wax paper. Use covers such as plastic wrap or lids with larger quantities of more dense foods such as stews. After reheating, stir well, if possible. Foods should be very hot. If not, continue to heat with variable power and time. After stirring, re-cover and allow to stand 2 to 3 minutes.
Turntable Off Stirrable	13 x 9 x 2 glass utility casserole	Ideal for reheating stirrable casseroles, such as macaroni and cheese or stew. Cover with vented plastic wrap or wax paper. Touch Turntable On/Off and Reheat. At signal, stir casserole and rotate dish. Touch Start/Touch On. At end, stir and allow to stand, covered, for 5 to 10 minutes.
Non-stirrable	13 x 9 x 2 glass utility casserole	Ideal for reheating non-stirrable casseroles, such as lasagna. Cover with vented plastic wrap or wax paper. Touch Turntable On/Off and Reheat TWICE. At signal, rotate dish. Touch Start/Touch On. At end, allow to stand, covered, for 10 to 15 minutes.

OTHER SENSOR COOKING SETTINGS

Sensor Cooking will automatically compute the microwave power and cooking time for foods shown in the chart below. You don't need to enter the weight or quantity of the food.

- Suppose you want to cook fresh broccoli.

PROCEDURE		DISPLAY	
1	Fresh vegetables Touch Fresh vegetables pad once for soft vegetables. When sensor detects the vapor emitted from the food, remainder of cooking time will appear.	SOFT VEG.	FRESH
2	At end, follow the directions in the display.	STIR STAND	LET COVERED

SENSOR COOKING CHART

FOOD	AMOUNT	PROCEDURE
Popcorn	3.0 - 3.5 oz (Regular) 1.5 - 1.75 oz (Snack)	Use only popcorn packaged for microwave oven use. Try several brands to decide which you like the best. Press Popcorn once for regular size bags, press Popcorn twice for snack size bags. Do not try to pop unpopped kernels.
Baked potato	1 - 6 med.	Pierce. Place on paper-towel-lined turntable. After cooking, remove from oven, wrap in aluminum foil and let stand 5 to 10 minutes.

SPECIAL FEATURES

SENSOR COOKING CHART (continued)

FOOD	AMOUNT	PROCEDURE															
Fresh vegetables: Soft		Wash and place in casserole. Add no water if vegetables have just been washed. Cover with lid for tender vegetables. Use plastic wrap for tender-crisp vegetables. Press Fresh vegetables pad once for soft. After cooking, stir, if possible, let stand, covered, for 2 to 5 minutes.															
Broccoli	.25 - 2.0 lb																
Brussels sprouts	.25 - 2.0 lb																
Cabbage	.25 - 2.0 lb																
Caulif. (flowerets)	.25 - 2.0 lb																
Cauliflower (whole)	1 med.																
Spinach	.25 - 1.0 lb																
Zucchini	.25 - 2.0 lb																
Baked apples	2 - 4 med.	Peel around top and remove core. Place sugar or cinnamon candies in core. Place apples in a glass pie plate. Cover with plastic wrap.															
Fresh vegetables: Hard		Place in casserole. Add 1-4 tbsp water. Cover with lid for tender vegetables. Use plastic wrap cover for tender-crisp vegetables. Press Fresh vegetables pad twice for hard. After cooking, stir, if possible, let stand, covered, for 2 to 5 minutes.															
Carrots, sliced	.25 - 1.5 lb																
Corn on the cob	2 - 4																
Green beans	.25 - 1.5 lb																
Winter squash:																	
diced	.25 - 1.5 lb																
halves	1 - 2																
Frozen entrees	6 - 17 oz	Use this pad for frozen convenience foods. It will give satisfactory results for most brands. You may wish to try several and choose your favorite. Remove package from outer wrapping and follow package directions for covering. After cooking, let stand, covered, for 1 to 3 minutes															
Frozen vegetables	1 - 6 cups	Add no water. Cover with lid or plastic wrap. After cooking, stir and let stand, covered, for 3 minutes. (Help message should say 1-6 cups; not 1-4.)															
Ground meat	.25 - 2.0 lb	Use this setting to cook ground beef or turkey as patties or in a casserole to be added to other ingredients. Place patties on a microwave-safe rack and cover with wax paper. Place ground meat in a casserole and cover with wax paper or plastic wrap. When oven stops and TURN FOOD OVER OR STIR is displayed, turn patties over or stir meat in casserole to break up large pieces. Re-cover and touch Start/Touch On. After cooking, LET STAND COVERED will be displayed.															
Rice	.5 - 2.0 cups	Place rice into a deep casserole and add double quantity of water. Cover with lid or plastic wrap. After cooking, stir, cover and let stand 3 to 5 minutes or until all liquid has been absorbed.															
		<table border="1"> <thead> <tr> <th>Rice</th> <th>Water</th> <th>Size of casserole</th> </tr> </thead> <tbody> <tr> <td>.5 cup</td> <td>1 cup</td> <td>1.5 quart</td> </tr> <tr> <td>1 cup</td> <td>2 cups</td> <td>2 quart</td> </tr> <tr> <td>1.5 cups</td> <td>3 cups</td> <td>2.5 or 3 quart</td> </tr> <tr> <td>2 cups</td> <td>4 cups</td> <td>3 quart or larger</td> </tr> </tbody> </table>	Rice	Water	Size of casserole	.5 cup	1 cup	1.5 quart	1 cup	2 cups	2 quart	1.5 cups	3 cups	2.5 or 3 quart	2 cups	4 cups	3 quart or larger
Rice	Water	Size of casserole															
.5 cup	1 cup	1.5 quart															
1 cup	2 cups	2 quart															
1.5 cups	3 cups	2.5 or 3 quart															
2 cups	4 cups	3 quart or larger															
Fish/seafood	.25 - 2.0 lb	Arrange in ring around shallow glass dish (roll fillet with edges underneath). Cover with vented plastic wrap. After cooking, let stand, covered, for 3 minutes.															
Fillet, steak																	
Shrimp																	
Scallops																	
Clams, fresh		Place in plastic bag. Secure end. Slit bag with a knife. After cooking, let stand, covered approximately 3 minutes.															

SENSOR COOKING RECIPES

Cranberry Fluff

Makes 6 to 8 servings

- | | |
|---|---|
| 2 cups fresh cranberries | 1/2 pint whipping cream, whipped or |
| 1 cup water | 1 carton (8 ounces) non-dairy whipped topping |
| 3/4 cup sugar | |
| 1 carton (3 ounces) orange flavored gelatin | |

- 1 Combine cranberries, water and sugar in a 2-quart casserole. Cover with wax paper. Microwave using Reheat Less. Drain cranberries and reserve liquid.
- 2 Add enough hot water to reserved liquid to make 2 cups. Stir the gelatin into hot liquid until it dissolves. Cover with wax paper. Microwave using Reheat Less.
- 3 Add berries and cool. Refrigerate until thickened. Fold whipped cream into cooled cranberry mixture. Spoon into serving dishes and garnish with extra whipped cream. Refrigerate until ready to serve.

Curry Vegetable Chowder

Makes 4 servings

- | | |
|---|-------------------------------------|
| 6 slices bacon | 3/4 teaspoon salt |
| 1 can (10 3/4 ounces) chicken broth | 1/2 teaspoon curry powder |
| 3 medium potatoes, finely diced (about 2 cup) | 1/8 teaspoon pepper |
| 2 carrots, shredded (about 1 cup) | 1 can (12 ounces) evaporated milk |
| 1 small onion, chopped (about 1/2 cup) | 2 tablespoons chopped fresh parsley |

- 1 Layer 2 paper towels on a microwave-safe plate. Arrange bacon on the towels. Cover with another paper towel. Microwave using HIGH (100%) just until bacon is crisp. Crumble and reserve bacon.
- 2 Combine chicken broth, vegetables and seasonings in 4-quart casserole. Cover with vented plastic wrap. Microwave using Baked potato. Vegetables should be tender.
- 3 Stir in evaporated milk. Re-cover with vented plastic wrap. Microwave using Reheat. Stir in parsley. Let stand, covered, 5 minutes.
- 4 Top each serving with crumbled bacon.

Glazed Apple Slices

Makes 6 to 8 servings

- | | |
|-----------------------------------|--|
| 1/4 cup brown sugar | 3/4 cup orange juice |
| 3 tablespoons margarine or butter | 1 tablespoon cornstarch |
| 2 tablespoons apricot preserves | 4 baking apples (about 1 1/2 pounds), peeled and sliced into 8 pieces each |
| 1/2 teaspoon ground nutmeg | 3 tablespoons chopped green pistachios |
| 1/4 teaspoon salt | |
| 1/2 cup sugar | |

- 1 Combine brown sugar, margarine and apricot preserves in a small bowl. Microwave at HIGH (100%) until margarine melts and preserves soften, 45 seconds to 1 minute. Stir in nutmeg, salt, sugar, orange juice and cornstarch. Microwave at HIGH (100%) until thickened, 4 to 6 minutes, stirring several times.
- 2 Arrange apple slices in a large microwave serving dish. Spread hot sauce over apples. Cover well with vented plastic wrap. Microwave using Fresh vegetables: Soft. Allow to cool 5 minutes before serving.
- 3 Sprinkle with pistachios. Serve alone or over vanilla ice cream or sponge cake.

SENSOR COOKING RECIPES (continued)

Mexican Seasoned Potatoes

Makes 6 to 8 servings

- | | |
|--|-----------------------------|
| 4 medium baking potatoes (8 ounces each) | 1/2 teaspoon oregano leaves |
| 1/4 cup olive oil | 1/4 teaspoon ground cumin |
| 1 tablespoon instant minced onion | 1/2 teaspoon salt |
| 1/2 teaspoon chili powder | |

- 1 Cut each potato lengthwise into 4 equal wedges. Place potato wedges into 10-inch square casserole. Toss potatoes with oil to coat well.
- 2 In small bowl, combine remaining ingredients. Sprinkle over potatoes.
- 3 Cover potatoes with wax paper. Microwave using Baked potato setting. Rearrange potatoes when time appears on display. Let stand, covered, 5 minutes.

Spiced Carrots

Makes 6 to 8 servings

- | | |
|---|-------------------------------|
| 3 cups sliced carrots, 1/4 inch thick | 2 teaspoons vinegar |
| 1/2 cup chopped green pepper, 1-inch cubes | 1 teaspoon soy sauce |
| 1/4 cup finely chopped onion | 1/2 teaspoon salt |
| 3 tablespoons water | 1/2 teaspoon prepared mustard |
| 1 can (7 3/4 ounces) semi-condensed tomato soup | 1/8 teaspoon pepper |
| 1/2 cup sugar | |

- 1 In a 1 1/2-quart casserole, combine carrots, green pepper, onion and water. Cover with lid. Microwave using Fresh vegetables: Hard. Carrots should be tender-crisp. Drain.
- 2 Stir in remaining ingredients. Cover and microwave using Reheat.

Savory Flounder Fillets

Makes 4 servings

- | | |
|-------------------------------|--------------------------|
| 3/4 cup of corn flake crumbs | 1/2 teaspoon paprika |
| 3 tablespoons chopped parsley | 1 pound flounder fillets |
| 2 teaspoons grated lemon peel | 1 egg, slightly beaten |

- 1 On waxed paper, combine corn flake crumbs, parsley, lemon peel and paprika. Dip fillets in beaten egg, then coat with crumb mixture.
- 2 Place fish in a covered, microwave-safe, baking dish. Microwave using Fish/seafood.
- 3 Serve with tartar or cocktail sauce or melted cheese.

Creole Corn

Makes 6 servings

- | | |
|---|-----------------------------------|
| 2 teaspoons oil | 1 teaspoon brown sugar |
| 1/2 cup chopped celery | 1/2 teaspoon onion powder |
| 1/2 cup chopped green pepper | 1/4 teaspoon garlic powder |
| 16 ounce can tomatoes | salt and pepper to taste |
| 4 ounce can mushroom stem and pieces, drained | 1 package (16 ounces) frozen corn |

- 1 In 2-quart casserole, combine oil, celery, green pepper, tomatoes, mushrooms, sugar, onion powder, garlic powder, salt and pepper.
- 2 Microwave using Reheat. Set aside.
- 3 In covered, 1-quart casserole, microwave corn using Frozen vegetables. Drain.
- 4 Combine corn and vegetable-seasoning mixture. Stir and serve immediately.

SPECIAL FEATURES

COMPU COOK

CompuCook will automatically compute the correct cooking/warming time and microwave power level for foods shown in the chart below.

- Suppose you want to use CompuCook to warm 2 frozen rolls.

PROCEDURE	DISPLAY
1 Compu Cook Touch Compu Cook pad.	SELECT FOOD NUMBER SEE LABEL
2 Touch 2 to warm frozen rolls/muffins.	FROZEN ROLL HOW MANY PRESS NUMBER
2 If you want to warm 2 rolls/muffins, touch 2.	2 PRESS START
3 Start Touch On	.55 COOK HELP END

Touch Start/Touch On pad. The heating time will count down. The display will indicate when cooking is complete.

NOTE:

1. CompuCook can be programmed with More or Less Time Adjustment. Touch the Power Level pad once or twice after selecting the amount. See page 20.
2. Each food has a cooking hint. Touch Custom Help when the HELP indicator is lighted in the display.
3. Should you attempt to enter more or less than the allowed amount, an error message will appear in the display.
 More or less than the quantity listed in the chart should be cooked following the guidelines in any microwave book.
4. The final cooking result will vary according to the food condition (e.g. initial temperature, shape, quality). Check food for temperature after cooking. If additional time is needed, continue to cook manually.

COMPU COOK CHART

FOOD	AMOUNT	PROCEDURE
1. Fresh roll - muffin	1 - 8	Use this pad to warm rolls, muffins, biscuits, bagels, etc. Large items should be considered as 2 or 3 regular size. For refrigerated rolls or muffins, it may be necessary to double the entered amount to ensure the proper serving temperature. For example, enter quantity of 2 for 1 refrigerated muffin or roll. Arrange on plate; cover with paper towel.
2. Frozen roll - muffin	1 - 8	Use this pad to warm rolls, muffins, biscuits, bagels, etc. Large items should be considered as 2 or 3 regular size. Arrange on plate; cover with paper towel.
3. Hot cereal	1 - 4 servings	Use individual packets or bulk cereal in your favorite variety: oatmeal, oat bran, cream of wheat, farina or wheatena. Follow package directions for the correct amount of water or milk. To prevent boil overs, it is very important to choose a large container because microwave cooking of cereal causes high boiling. When oven stops, stir and touch Start/Touch On. After cooking, stir and let stand, covered, for 2 minutes.

SPECIAL FEATURES





COMPU COOK CHART (continued)

FOOD	AMOUNT	PROCEDURE
4. Turkey breast	3.0 - 6.0 lb	Place skin side down on a microwave-safe rack. Cover with vented plastic wrap. At signal, turn over. Shield with small, flat pieces of aluminum foil any areas that are cooking too rapidly. Re-cover. After cooking, remove from oven, cover with foil and allow to stand 10 to 15 minutes. Internal temperature should be 170°F.
5. Pork loin	2.0 - 3.5 lb	Boneless pork loin is recommended because it cooks evenly. Place on a microwave-safe rack. Cover with vented plastic wrap. At signal, turn over. Shield with small, flat pieces of aluminum foil any areas that are cooking too rapidly. Re-cover. After cooking, remove from oven, cover with foil and allow to stand 10 minutes. Internal temperature should be 160°F.
6. Meat loaf	1.0 - 2.0 lb	Use your favorite recipe. Mix well and place in microwave-safe loaf dish. Cover with wax paper or vented plastic wrap. Enter weight of meat used in the recipe. After cooking, allow to stand, covered, for 5 minutes. Drain and serve.

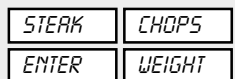

COMPU DEFROST

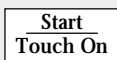
CompuDefrost automatically defrosts foods from the chart on page 18.

- Suppose you want to defrost a 2.0 pound steak.

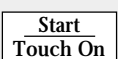

PROCEDURE	DISPLAY
1 Compu Defrost  Touch CompuDefrost pad once. Then touch 2 for steak.	
2  Enter weight by touching the number pads 2 and 0. (Ex: 2.0 lb steak.)	
3  Touch Start/Touch On pad. The oven will stop and directions will be displayed. Follow the indicated message.	

4 After the 1st stage, open the door. Turn steak over and shield any warm portions. Close the door.

Touch Start/Touch On pad.

6 After the 2nd stage, open the door. Shield any warm portions. Close the door.

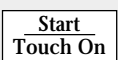
Touch Start/Touch On pad.

7 After defrost cycle ends, cover and let stand as indicated in chart on next page.

NOTE:

1. CompuDefrost can be programmed with More or Less Time Adjustment. See page 20.
2. Each food has a defrosting hint. Touch Custom Help after step 2 above.
3. Should you attempt to enter more or less than the allowed amount, an error message will appear in the display.
4. To defrost other food or foods above or below the weights allowed on the chart, use time and 30% power. See Manual Defrost on page 18.

SPECIAL FEATURES

COMPU DEFROST CHART

FOOD	AMOUNT	PROCEDURE
1. Ground meat	.5 - 3.0 lb	Remove any thawed pieces after each stage. Let stand, covered, for 5 to 10 minutes.
2. Steak, chops or fish	.5 - 4.0 lb	After each stage, rearrange and if there are warm or thawed portions, shield with small flat pieces of aluminum foil. Remove any meat or fish that is almost defrosted. Let stand, covered, for 10 to 20 minutes.
3. Chicken pieces	.5 - 3.0 lb	After each stage, rearrange pieces or remove portions should they become warm or thawed. Let stand, covered, for 10 to 20 minutes.
4. Roast	2.0 - 4.0 lb	Start defrosting with fat side down. After each stage, turn roast over and shield the warm portions with aluminum foil. Let stand, covered, for 30 to 60 minutes.
5. Casserole	2 - 6 cups	After audible signal, stir if possible. At end, stir well and let stand, covered, for 5 to 10 minutes.
6. Soup	1 - 6 cups	After audible signal, stir if possible. At end, stir well and let stand, covered, for 5 to 10 minutes.

NOTE: Check foods when oven signals. After final stage, small sections may still be icy. Let stand to continue thawing. Do not defrost until all ice crystals are thawed. Shielding prevents cooking from occurring before the center of the food is defrosted. Use small smooth strips of aluminum foil to cover edges and thinner sections of the food.

MANUAL DEFROST

If the food that you wish to defrost is not listed on the COMPU DEFROST CHART or is above or below the limits in the "Amount" column on the COMPU DEFROST CHART, you need to defrost manually.

You can defrost any frozen food, either raw or previously cooked, by using Power Level 3. Follow the exact 3-step procedure found under Time Cooking on page 10. Estimate defrosting time and press 3 for 30% when you select the power level.

For either raw or previously cooked frozen food the rule of thumb is approximately 4 minutes per pound. For

example, defrost 4 minutes for 1 pound of frozen spaghetti sauce.

Always stop the oven periodically to remove or separate the portions that are defrosted. If food is not defrosted at the end of the estimated defrosting time, program the oven in 1 minute increments on Power Level 3 until totally defrosted.

When using plastic containers from the freezer, defrost only long enough to remove from the plastic in order to place in a microwave-safe dish.

OTHER CONVENIENT FEATURES

MINUTE PLUS

Minute Plus allows you to cook for a minute at 100% by simply touching the Minute Plus pad. You can also extend cooking time in multiples of 1 minute by repeatedly touching the Minute Plus pad during manual cooking.

- Suppose you want to heat a cup of soup for one minute.

PROCEDURE

Touch Minute Plus pad.



NOTE:

1. To use Minute Plus, touch pad within 1 minute after cooking, closing the door, touching the Stop/Clear pad or during cooking.
2. Minute Plus cannot be used with Special Features.

MULTIPLE SEQUENCE COOKING

Your oven can be programmed for up to 4 automatic cooking sequences, switching from one power level setting to another automatically.

Sometimes cooking directions tell you to start on one power level and then change to a different power level. Your oven can do this automatically.

- Suppose you want to cook roast beef for 5 minutes at 100% and then continue to cook for 30 minutes at 50%.

PROCEDURE



1 First enter cooking time. Then touch Power Level pad twice for 100% power.



 x 2

2 Then enter second cooking time. Touch Power Level pad. Touch number pad 5 for 50% power.



3 Touch Start/Touch On pad.

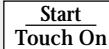

NOTE:

1. If Power Level pad is touched twice, **HIGH** will be displayed.
2. If 100% is selected as the final sequence, it is not necessary to touch the Power Level pad.
3. If you wish to know power level, simply touch the Power Level pad. As long as your finger is touching the Power Level pad, the power level will be displayed.

DEMONSTRATION MODE

To demonstrate, touch Kitchen Timer/Clock, the number **0** and touch Start/Touch On and hold for 3 seconds. **DEMO ON** will appear in the display. Cooking operations and specific special features can now be demonstrated with no power in the oven. For example, touch Stop/Clear and touch Minute Plus, and the display will show **1:00** and count down quickly to **END**.

To cancel, touch Kitchen Timer/Clock, then the number **0** and Stop/Clear. If easier, unplug the oven from the electrical outlet and replug.

KITCHEN TIMER

- Suppose you want to time a 3 minute long distance phone call.

PROCEDURE

1 Touch Kitchen Timer/Clock pad.



Press number 1.



2 Enter time.



3 Touch Start/Touch On pad.

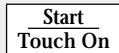

TOUCH ON

Touch On allows you to cook at 100% power by touching the Start/Touch On continuously. Touch On is ideal for melting cheese, bringing milk to just below boiling etc. The maximum cooking time is 3 minutes.

- Suppose you want to melt cheese on toast.

PROCEDURE

1 Continuously touch Start/Touch On pad. The cooking time will begin counting up.

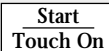

2 When the cheese is melted to desired degree, remove finger from Start/Touch On pad. Oven stops immediately.

NOTE:

1. Note time it takes for frequently used foods and program that time in the future.
2. Touch Touch On pad within 1 minute after cooking, opening and closing the door or touching the Stop/Clear pad.
3. Touch On can only be used 3 times in a row. If more times are needed, open and close door or touch Stop/Clear.

OTHER CONVENIENT FEATURES

CUSTOM HELP

Custom Help provides 5 features which make using your oven easy because specific instructions are provided in the Interactive Display.

1. CHILD LOCK

The Child Lock prevents unwanted oven operation such as by small children. The oven can be set so that the control panel is deactivated or locked. To set, touch Custom Help, the number ① and Start/Touch On. Should a pad be touched, **LOCK** **ON** will appear in the display.

To cancel, touch Custom Help and Stop/Clear.

2. AUDIBLE SIGNAL ELIMINATION

If you wish to have the oven operate with no audible signals, touch Custom Help, the number ② and Stop/Clear.

To cancel and restore the audible signal, touch Custom Help, the number ② and Start/Touch On.

3. AUTO START

If you wish to program your oven to begin cooking automatically at a designated time of day, follow this procedure:

- Suppose you want to start cooking a stew for 20 minutes on 50% at 4:30. Before setting, check to make sure the clock is set correctly.

PROCEDURE	
1 Touch Custom Help pad.	Custom Help
2 Touch the number.	③
3 Enter the start time.	④ ③ ①
4 Touch Kitchen Timer/Clock pad.	Kitchen Timer Clock
5 Enter cooking program.	② ① ① ① Power Level ⑤
6 Touch Start/Touch On pad.	Start Touch On

NOTE:

1. Auto Start can be used for manual cooking and CompuCook, if clock is set.
2. If the oven door is opened after programming Auto Start, it is necessary to touch the Start/Touch

On pad for Auto Start time to appear in the readout so that the oven will automatically begin programmed cooking at the chosen Auto Start time.

3. Be sure to choose foods that can be left in the oven safely until the Auto Start time.
4. If you wish to know the time of day, simply touch the Kitchen Timer/Clock pad. As long as your finger is touching the pad, the time of day will be displayed.

4. & 5. LANGUAGE / WEIGHT SELECTION

The oven comes set for English and U.S. Customary Unit-pounds. To change, touch Custom Help and the number ④. Continue to touch the number ④ until your choice is selected from the table below. Then, touch Start/Touch On.

Touch number ④ for language and standard of weight.

NUMBER	LANGUAGE	STANDARD OF WEIGHT	DISPLAY
Once	English	LB	ENGLISH Lb
Twice	English	KG	ENGLISH KG
3 times	Spanish	LB	ESPAÑOL Lb
4 times	Spanish	KG	ESPAÑOL KG
5 times	French	LB	FRANC. Lb
6 times	French	KG	FRANC. KG

MORE OR LESS TIME ADJUSTMENT

Should you discover that you like any of the CompuCook, CompuDefrost or Sensor Cooking settings slightly **more** done, touch the **Power Level** pad **once** after touching your choice of pads and before touching Start/Touch On.

The display will show **MORE**.

Should you discover that you like any of the CompuCook, CompuDefrost or Sensor Cooking settings slightly **less** done, touch the **Power Level** pad **twice** after touching your choice of pads and before touching Start/Touch On.

The display will show **LESS**.

HELP

Each setting of CompuCook, CompuDefrost and Sensor Cooking has a cooking hint. If you wish to check, touch Custom Help whenever HELP is lighted in the Interactive Display.

CLEANING AND CARE

Exterior

The outside surface is precoated steel and plastic. Clean the outside with mild soap and water; rinse and dry with a soft cloth. Do not use any type of household or abrasive cleaner.

Door

Wipe the window on both sides with a damp cloth to remove any spills or spatters. Metal parts will be easier to maintain if wiped frequently with a damp cloth. Avoid the use of spray and other harsh cleaners as they may stain, streak or dull the door surface.

Touch Control Panel

Care should be taken in cleaning the touch control panel. If the control panel becomes soiled, open the oven door before cleaning. Wipe the panel with a cloth dampened slightly with water only. Dry with a soft cloth. Do not scrub or use any sort of chemical cleaners. Close door and touch STOP/CLEAR.

Interior

Cleaning is easy because little heat is generated to the interior surfaces; therefore, there is no baking and setting of spills or spattering. To clean the interior surfaces, wipe with a soft cloth and warm water. **DO NOT USE ABRASIVE OR HARSH CLEANERS OR SCOURING PADS.** For heavier soil, use baking soda or a mild soap; rinse thoroughly with hot water. **NEVER SPRAY OVEN CLEANERS DIRECTLY ONTO ANY PART OF THE OVEN.**

Waveguide Cover

The waveguide cover is located on the ceiling in the oven cavity. It is made from mica so requires special care. Keep the waveguide cover clean to assure good oven performance. Carefully wipe with a damp cloth any food spatters from the surface of the cover immediately after they occur. Built-up splashes may overheat and cause smoke or possibly catch fire. **DO NOT REMOVE THE WAVEGUIDE COVER.**

Odor Removal

Occasionally, a cooking odor may remain in the oven. To remove, combine 1 cup water, grated peel and juice of 1 lemon and several whole cloves in a 2-cup glass measuring cup. Boil for several minutes using 100% power. Allow to set in oven until cool. Wipe interior with a soft cloth.

Turntable/Turntable Support

The turntable and turntable support can be removed for easy cleaning. Wash them in mild, sudsy water; for stubborn stains use a mild cleanser and non-abrasive scouring sponge as described above. They are also dishwasher-proof. Use upper rack of dishwasher. The turntable motor shaft is not sealed, so excess water or spills should be wiped up immediately.



Turntable

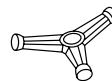

Turntable Support

Grease Filters

Filters should be cleaned at least once a month. Never operate the fan or oven without the filters in place.

1. Pull down slightly on the tab toward the front of the oven and remove the filter. Repeat for the other filter.
2. Soak the filters in a sink or dish pan filled with hot water and detergent. **DO NOT** use ammonia or other alkali; they will react with the filter material and darken it.
3. Agitate and scrub with a brush to remove embedded dirt.
4. Rinse thoroughly and shake dry.
5. Replace by fitting the filter back into the opening.

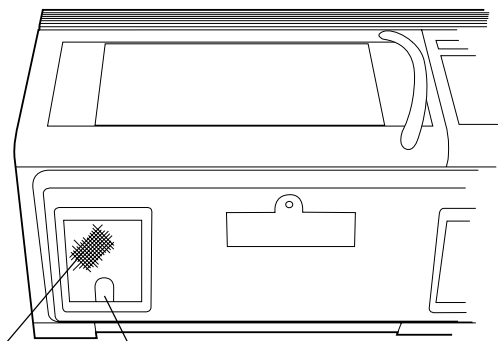

Grease filter

Tab

CLEANING AND CARE

Fan

The fan will automatically start when heat rises from range surface units or burners. This protects the microwave oven from excessive temperature rise. The fan will stay on until the temperature decreases. It cannot be turned off manually during this time.

For other uses, select either HI or LO speed.

Work Light and Night Light

1. To replace light bulbs, first disconnect power to the oven at the circuit breaker panel or by unplugging.
2. To release cover, remove the screw on the light cover. (See illustration.)
3. Replace light bulbs with equivalent watt bulb available from your Sharp Authorized Servicer or parts distributor. Bulbs are also available at most hardware stores or lighting centers. **DO NOT USE A BULB LARGER THAN 30 WATTS.**
4. Close light cover and secure with screw removed in step 2.

CAUTION: Light cover may become very hot. Do not touch glass when light is on.

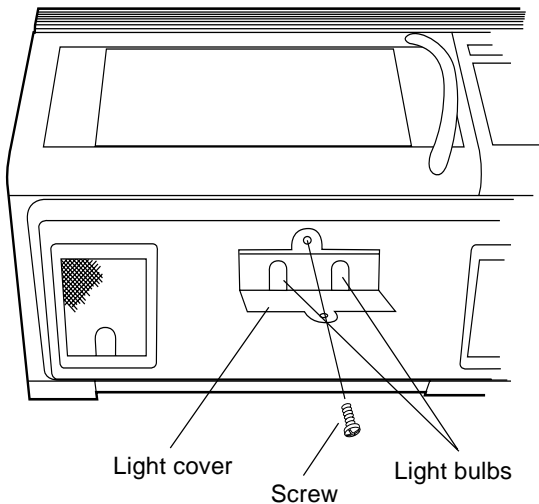

Charcoal Filter

Charcoal Filter, Sharp Part number RK-230, is used for nonvented, recirculated installation. The filter should be changed every 6 to 12 months depending on use.

1. Disconnect power to the oven at the circuit breaker panel or by unplugging.
2. Remove the louver mounting screw from the top center of the louver and push down carefully on the tab at each end of the louver to disengage it. (See illustration.)
3. Pull the louver away from the unit.
4. Change the charcoal filter.
5. Carefully push the louver back into place (engaging both the bottom and top tabs) and replace the screw removed in step 2.

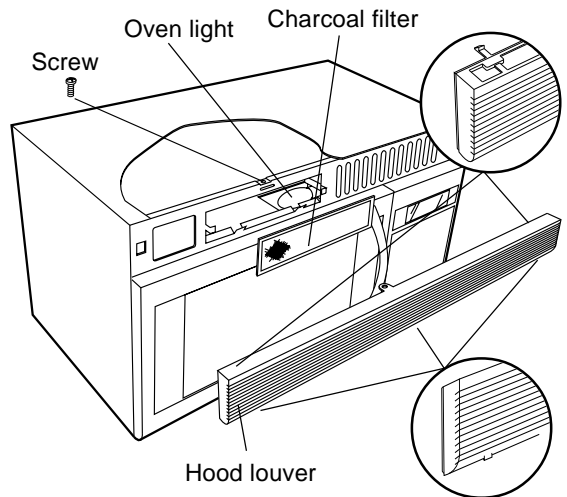

Oven Light

Remove the louver per instructions 1-3 above and charcoal filter, if used.

1. Open light cover located behind filter mounting by carefully pulling up on the front edge.
2. Remove old light bulb and replace only with equivalent watt bulb available from a Sharp Authorized Servicer or parts distributor. Bulbs are also available at most hardware stores or lighting centers. **DO NOT USE BULB LARGER THAN 30 WATTS.**
3. Replace the oven light cover by carefully pushing into place. Replace the charcoal filter, if used. Push the louver back into place and replace the louver mounting screw.

SERVICE CALL CHECK

Please check the following before calling for service:

Place one cup of water in a glass measuring cup in the oven and close the door securely.
Operate the oven for one minute at HIGH 100%.

- A Does the oven light come on? YES _____ NO _____
- B Does the cooling fan work?
(Put your hand on the louver above the Interactive Display.) YES _____ NO _____
- C Does the turntable rotate?
(It is normal for the turntable to turn in either direction unless
the display indicates TURN TABLE OFF .) YES _____ NO _____
- D Is the water in the oven warm? YES _____ NO _____

If "NO" is the answer to any of the above questions, please check electrical outlet, fuse and/or circuit breaker. If they are functioning properly, CONTACT YOUR NEAREST SHARP AUTHORIZED SERVICER. A microwave oven should never be serviced by a "do-it-yourself" repair person.

NOTE: If time appearing in the display is counting down very rapidly, check Demonstration Mode on page 19 and cancel.

THE ULTIMATE ACCESSORY

- ★ Great recipes
- ★ Reliable microwave reference guide
- ★ Many color photos
- ★ Step-by-step instructions
- ★ Nutritional information for each recipe
- ★ Durable wipe-clean soft cover with 128 8 1/2 x 11 pages
- ★ Helpful tips and special techniques

SHARP®

CAROUSEL MICROWAVE COOKBOOK

TO ORDER

Simply call this toll-free number : **1-800-642-2122**.
Please have your credit card ready.

If you prefer to order by mail, complete and return the order form on page 26. Please include check or money order (payable to Sharp Accessories & Supplies Center) for \$6.00 plus \$4.25 shipping & handling and tax, if applicable, per book.

SATISFACTION GUARANTEED

You must be completely satisfied with the Sharp Carousel Microwave Cookbook. If, within 14 days, you are dissatisfied for any reason, simply return the book and we'll gladly refund your \$6.00 plus tax.

(SOLAMENTE ESCRITO EN INGLES!)

SPECIFICATIONS

R-1490 / R-1491 / R-1492

AC Line Voltage:	Single phase 120V, 60Hz, AC only
AC Power Required:	1700W 14.3 amps.
Output Power:	950W* (IEC Test Procedure)
Frequency:	2450 MHz
Outside Dimensions (not including handle):	29 ¹⁵ / ₁₆ "(W) x 16 ³ / ₈ "(H) x 15 ¹ / ₄ "(D)
Cavity Dimensions:	20 ¹ / ₄ "(W) x 8 ³ / ₁₆ "(H) x 14 ¹ / ₂ "(D)
Oven Capacity:	1.4 Cu.Ft.
Cooking Uniformity:	Turntable / Stirrer Fan System
Weight:	Approx. (net) 55 lb, (gross) 63 lb
Work/Night Light:	2 bulbs 30w each (incandescent light bulbs)

★ The International Electrotechnical Commission's standardized method for measuring output wattage. This test method is widely recognized.

In compliance with standards set by:

FCC – Federal Communications Commission Authorized.

DHHS – Complies with Department of Health and Human Services (DHHS) rule, CFR, Title 21, Chapter I, Subchapter J.



– This symbol on the nameplate means the product is listed by Underwriters Laboratories, Inc.

----- Cut along this line. -----

COOKBOOK ORDER FORM

Please send me _____ cookbooks at \$10.25 each \$ _____

Illinois sales tax, (if applicable) per book \$.44 no. of books _____ \$ _____

Other tax, (if applicable) no. of books _____ \$ _____

TOTAL ORDER AMOUNT \$ _____

I have enclosed a check made payable to Sharp Accessories & Supplies Center.

Please bill my VISA MASTERCARD AMERICAN EXPRESS

Acct. No. _____ Expiration date ____ / ____

Signature _____

(All credit card orders must be signed.)

Name _____

Address _____

City _____ State _____ Zip _____

Daytime Phone No. () _____

Mail to: SHARP Accessories & Supplies Center Price is subject to change without notice.
2130 Townline Road
Peoria, Illinois 61615-1560

GUIA AUTO-TOUCH^{MD}

Para mayor informacion y precauciones de seguridad, consulte el Manual de Operaciones.

<h3>FIJACION DEL RELOJ</h3> <p>Si en la pantalla aparece <i>SHARP SIMPLY THE BEST PRESS CLEAR AND PRESS CLOCK</i> pulse primero Stop/Clear.</p> <ol style="list-style-type: none"> 1. Pulse la tecla Kitchen Timer/Clock. 2. Toque el botón ②. 3. Programar la hora correcta pulsando los números en orden. (Ej.: 12:30) 4. Pulse nuevamente la tecla Kitchen Timer/Clock. 	<p style="text-align: center;">Kitchen Timer Clock</p> <p style="text-align: center;">②</p> <p style="text-align: center;">① ② ③ ④</p> <p style="text-align: center;">Kitchen Timer Clock</p>	<h3>COMPU DEFROST</h3> <ol style="list-style-type: none"> 1. Toque el botón COMPU DEFROST una vez. Tóquelo ② veces más para filete. 2. Toque los botones ② y ①. (Ej.: filete de 2.0 libras) 3. Toque el botón START/TOUCH ON. Cuando el microondas se para direcciones serán enseñadas. Sigve el mens je indicado. 	<p style="text-align: center;">Compu Defrost</p> <p style="text-align: center;">②</p> <p style="text-align: center;">② ①</p> <p style="text-align: center;">Start Touch On</p>																								
<h3>OPERACION MANUAL</h3> <h4>Cocinando con energia alta</h4> <ol style="list-style-type: none"> 1. Programe el tiempo para cocinar tocando los botones numéricos. (Ej.: 1 min. 30 seg.) 2. Pulse Start/Touch On. <h4>Cocinando con energia variable</h4> <ol style="list-style-type: none"> 1. Después del paso 1 anterior, pulse la tecla Power Level. 2. Escoja el nivel de energía. (Ej.: 50%) 3. Pulse Start/Touch On. 	<p style="text-align: center;">① ③ ④</p> <p style="text-align: center;">Start Touch On</p> <p style="text-align: center;">Power Level</p> <p style="text-align: center;">⑤</p> <p style="text-align: center;">Start Touch On</p>	<h3>TABLA COMPU DEFROST</h3> <table border="1"> <thead> <tr> <th>NUMERO</th> <th>ALIMENTOS</th> <th>CANTIDAD</th> </tr> </thead> <tbody> <tr> <td>1.</td> <td>Carne molida</td> <td>.5 a 3.0 libras</td> </tr> <tr> <td>2.</td> <td>Filetes, chuletas, pescado</td> <td>.5 a 4.0 libras</td> </tr> <tr> <td>3.</td> <td>Piezas de pollo</td> <td>.5 a 3.0 libras</td> </tr> <tr> <td>4.</td> <td>Asar</td> <td>2.0 a 4.0 libras</td> </tr> <tr> <td>5.</td> <td>Cacerola</td> <td>2 a 6 tazas</td> </tr> <tr> <td>6.</td> <td>Sopa</td> <td>1 a 6 tazas</td> </tr> </tbody> </table>		NUMERO	ALIMENTOS	CANTIDAD	1.	Carne molida	.5 a 3.0 libras	2.	Filetes, chuletas, pescado	.5 a 4.0 libras	3.	Piezas de pollo	.5 a 3.0 libras	4.	Asar	2.0 a 4.0 libras	5.	Cacerola	2 a 6 tazas	6.	Sopa	1 a 6 tazas			
NUMERO	ALIMENTOS	CANTIDAD																									
1.	Carne molida	.5 a 3.0 libras																									
2.	Filetes, chuletas, pescado	.5 a 4.0 libras																									
3.	Piezas de pollo	.5 a 3.0 libras																									
4.	Asar	2.0 a 4.0 libras																									
5.	Cacerola	2 a 6 tazas																									
6.	Sopa	1 a 6 tazas																									
<h3>COCCION MANUAL</h3> <p>Pulse la tecla Start/Touch On y manténgala presionada para cocinar a un 100% del nivel de energía. Al retirar el dedo del botón, el horno se detendrá instantáneamente.</p>	<p style="text-align: center;">Start Touch On</p>	<h3>COCCIÓN CON SENSOR</h3> <ol style="list-style-type: none"> 1. Seleccione la posición deseada de cocción con el sensor. (Ej: toque Popcorn una vez para una porción regular de rosetas o palomitas de maíz.) 2. El horno se pondrá en funcionamiento automáticamente. La pantalla indicará END cuando la cocción se haya terminado. 																									
<h3>MINUTO EXTRA</h3> <p>Toque el botón Minute Plus para un minuto al 100% de energía o para añadir un minuto cuando cocine en el modo manual. Continúe tocándolo para añadir más minutos.</p>	<p style="text-align: center;">Minute Plus</p>	<h3>RECALENTAMIENTO CON EL SENSOR</h3> <ol style="list-style-type: none"> 1. Para recalentar lasaña en una caserola de 13" x 9" x 2". Toque el interruptor Turntable On/Off y el botón Reheat dos veces. 2. El horno se pondrá en funcionamiento automáticamente. Siga las direcciones indicadas en la pantalla. 																									
<h3>COMPU COOK</h3> <ol style="list-style-type: none"> 1. Toque el botón Compu Cook. 2. Seleccione la programación deseada para Compu Cook. (Ej.: toque el botón ② para pan congelado. 3. Toque el botón del número de piezas. (Ej.: ② para pan congelado dos. 4. Toque el botón Start/Touch On. 	<p style="text-align: center;">Compu Cook</p> <p style="text-align: center;">②</p> <p style="text-align: center;">②</p> <p style="text-align: center;">Start Touch On</p>	<h3>TABLA SENSOR COOKING</h3> <table border="1"> <thead> <tr> <th>ALIMENTO</th> <th>CANTIDAD</th> </tr> </thead> <tbody> <tr> <td>Palomitas de maíz</td> <td>3.0 a 3.5 onzas (Normal) 1.5 a 1.75 onzas (Snack)</td> </tr> <tr> <td>Papa asada</td> <td>1 a 6 med.</td> </tr> <tr> <td>Recalentar: Con la mesa girando</td> <td>4 a 36 onzas</td> </tr> <tr> <td>Sin la meas girando</td> <td>13 x 9 x 2 Caserola</td> </tr> <tr> <td>Verdura: Suave</td> <td>.25 a 2.0 libras</td> </tr> <tr> <td>Firme</td> <td>.25 a 1.5 libras</td> </tr> <tr> <td>Platos congelados</td> <td>6 a 17 onzas</td> </tr> <tr> <td>Vedura congelados</td> <td>1 a 6 tazas</td> </tr> <tr> <td>Carne molida</td> <td>.25 a 2.0 libras</td> </tr> <tr> <td>Arroz</td> <td>.5 a 2.0 tazas</td> </tr> <tr> <td>Pescados y mariscos</td> <td>.25 a 2.0 libras</td> </tr> </tbody> </table>		ALIMENTO	CANTIDAD	Palomitas de maíz	3.0 a 3.5 onzas (Normal) 1.5 a 1.75 onzas (Snack)	Papa asada	1 a 6 med.	Recalentar: Con la mesa girando	4 a 36 onzas	Sin la meas girando	13 x 9 x 2 Caserola	Verdura: Suave	.25 a 2.0 libras	Firme	.25 a 1.5 libras	Platos congelados	6 a 17 onzas	Vedura congelados	1 a 6 tazas	Carne molida	.25 a 2.0 libras	Arroz	.5 a 2.0 tazas	Pescados y mariscos	.25 a 2.0 libras
ALIMENTO	CANTIDAD																										
Palomitas de maíz	3.0 a 3.5 onzas (Normal) 1.5 a 1.75 onzas (Snack)																										
Papa asada	1 a 6 med.																										
Recalentar: Con la mesa girando	4 a 36 onzas																										
Sin la meas girando	13 x 9 x 2 Caserola																										
Verdura: Suave	.25 a 2.0 libras																										
Firme	.25 a 1.5 libras																										
Platos congelados	6 a 17 onzas																										
Vedura congelados	1 a 6 tazas																										
Carne molida	.25 a 2.0 libras																										
Arroz	.5 a 2.0 tazas																										
Pescados y mariscos	.25 a 2.0 libras																										

Carousel® y Auto-Touch® son marcas registradas de Sharp Corporation.

AUTO-TOUCH® GUIDE

For more complete information and safety precautions, refer to your Operation Manual.

<p>SET CLOCK</p> <p>If SHARP SIMPLY THE BEST PRESS CLEAR AND PRESS CLOCK is in display, first touch Stop/Clear.</p> <ol style="list-style-type: none"> 1. Touch Kitchen Timer/Clock pad. 2. Press ② to set the clock. 3. Enter correct time of the day by touching numbers in sequence (Ex: 12:30) 4. Touch Kitchen Timer/Clock pad again. 	<p>Kitchen Timer Clock</p> <p>②</p> <p>① ② ③ ④</p> <p>Kitchen Timer Clock</p>	<p>COMPU DEFROST</p> <ol style="list-style-type: none"> 1. Touch CompuDefrost pad once. Then touch ② for steak. 2. Touch number pads ② and ④. (Ex: 2.0 lb steak) 3. Touch Start/Touch On. The oven will stop and directions will be displayed. Follow the indicated message. 	<p>Compu Defrost</p> <p>②</p> <p>② ④</p> <p>Start Touch On</p>																								
<p>MANUAL OPERATION</p> <p>High Power Cooking</p> <ol style="list-style-type: none"> 1. Enter cooking time by touching number pads. (Ex: 1 min. 30 sec.) 2. Touch Start/Touch On pad. <p>Variable Power Cooking</p> <ol style="list-style-type: none"> 1. After Step 1 above, touch Power Level pad. 2. Select power level. (Ex: 50%) 3. Touch Start/Touch On pad. 	<p>① ③ ④</p> <p>Start Touch On</p> <p>Power Level</p> <p>⑤</p> <p>Start Touch On</p>	<p>COMPU DEFROST CHART</p> <table border="1"> <thead> <tr> <th>SETTING</th> <th>FOOD</th> <th>AMOUNT</th> </tr> </thead> <tbody> <tr> <td>1.</td> <td>Ground meat</td> <td>.5 - 3.0 lb</td> </tr> <tr> <td>2.</td> <td>Steak, chops or fish</td> <td>.5 - 4.0 lb</td> </tr> <tr> <td>3.</td> <td>Chicken pieces</td> <td>.5 - 3.0 lb</td> </tr> <tr> <td>4.</td> <td>Roast</td> <td>2.0 - 4.0 lb</td> </tr> <tr> <td>5.</td> <td>Casserole</td> <td>2 - 6 cups</td> </tr> <tr> <td>6.</td> <td>Soup</td> <td>1 - 6 cups</td> </tr> </tbody> </table>		SETTING	FOOD	AMOUNT	1.	Ground meat	.5 - 3.0 lb	2.	Steak, chops or fish	.5 - 4.0 lb	3.	Chicken pieces	.5 - 3.0 lb	4.	Roast	2.0 - 4.0 lb	5.	Casserole	2 - 6 cups	6.	Soup	1 - 6 cups			
SETTING	FOOD	AMOUNT																									
1.	Ground meat	.5 - 3.0 lb																									
2.	Steak, chops or fish	.5 - 4.0 lb																									
3.	Chicken pieces	.5 - 3.0 lb																									
4.	Roast	2.0 - 4.0 lb																									
5.	Casserole	2 - 6 cups																									
6.	Soup	1 - 6 cups																									
<p>TOUCH ON</p> <p>Continuously touch Start/Touch On for 100% power cooking. Remove finger and oven will stop instantly.</p>	<p>Start Touch On</p>	<p>SENSOR COOKING</p> <ol style="list-style-type: none"> 1. Select desired Sensor Cooking setting. (Ex: touch Popcorn once for regular size.) 2. The oven will start automatically. The display will indicate END when cooking is complete. 																									
<p>MINUTE PLUS</p> <p>Touch Minute Plus for one minute at 100% power or to add a minute during manual cooking. Continue to touch for additional minutes.</p>	<p>Minute Plus</p>	<p>SENSOR REHEAT</p> <ol style="list-style-type: none"> 1. To reheat lasagna in 13 x 9 x 2 casserole. Touch Turntable On/Off and Reheat pad twice. 2. The oven will start automatically. Follow the directions indicated in the display. 																									
<p>COMPU COOK</p> <ol style="list-style-type: none"> 1. Touch CompuCook pad. 2. Select desired CompuCook setting. (Ex: touch ② to heat frozen rolls.) 3. Touch number pad for quantity (Ex: ② for two frozen rolls.) 4. Touch Start/Touch On pad. 	<p>Compu Cook</p> <p>②</p> <p>②</p> <p>Start Touch On</p>	<p>SENSOR COOKING CHART</p> <table border="1"> <thead> <tr> <th>FOOD</th> <th>AMOUNT</th> </tr> </thead> <tbody> <tr> <td>Popcorn</td> <td>3.0 - 3.5 oz (Regular) 1.5 - 1.75 oz (Snack)</td> </tr> <tr> <td>Baked potato</td> <td>1 - 6 med.</td> </tr> <tr> <td>Reheat: Turntable On</td> <td>4 - 36 oz</td> </tr> <tr> <td> Turntable Off</td> <td>13 x 9 x 2 casserole</td> </tr> <tr> <td>Fresh vegetables: Soft</td> <td>.25 - 2.0 lb</td> </tr> <tr> <td> Hard</td> <td>.25 - 1.5 lb</td> </tr> <tr> <td>Frozen entrees</td> <td>6 - 17 oz</td> </tr> <tr> <td>Frozen vegetables</td> <td>1 - 6 cups</td> </tr> <tr> <td>Ground meat</td> <td>.25 - 2.0 lb</td> </tr> <tr> <td>Rice</td> <td>.5 - 2.0 cups</td> </tr> <tr> <td>Fish/seafood</td> <td>.25 - 2.0 lb</td> </tr> </tbody> </table>		FOOD	AMOUNT	Popcorn	3.0 - 3.5 oz (Regular) 1.5 - 1.75 oz (Snack)	Baked potato	1 - 6 med.	Reheat: Turntable On	4 - 36 oz	Turntable Off	13 x 9 x 2 casserole	Fresh vegetables: Soft	.25 - 2.0 lb	Hard	.25 - 1.5 lb	Frozen entrees	6 - 17 oz	Frozen vegetables	1 - 6 cups	Ground meat	.25 - 2.0 lb	Rice	.5 - 2.0 cups	Fish/seafood	.25 - 2.0 lb
FOOD	AMOUNT																										
Popcorn	3.0 - 3.5 oz (Regular) 1.5 - 1.75 oz (Snack)																										
Baked potato	1 - 6 med.																										
Reheat: Turntable On	4 - 36 oz																										
Turntable Off	13 x 9 x 2 casserole																										
Fresh vegetables: Soft	.25 - 2.0 lb																										
Hard	.25 - 1.5 lb																										
Frozen entrees	6 - 17 oz																										
Frozen vegetables	1 - 6 cups																										
Ground meat	.25 - 2.0 lb																										
Rice	.5 - 2.0 cups																										
Fish/seafood	.25 - 2.0 lb																										
<p>COMPU COOK CHART</p> <table border="1"> <thead> <tr> <th>SETTING</th> <th>FOOD</th> <th>AMOUNT</th> </tr> </thead> <tbody> <tr> <td>1.</td> <td>Fresh roll - muffin</td> <td>1 - 8</td> </tr> <tr> <td>2.</td> <td>Frozen roll - muffin</td> <td>1 - 8</td> </tr> <tr> <td>3.</td> <td>Hot cereal</td> <td>1 - 4 servings</td> </tr> <tr> <td>4.</td> <td>Turkey breast</td> <td>3.0 - 6.0 lb</td> </tr> <tr> <td>5.</td> <td>Pork loin</td> <td>2.0 - 3.5 lb</td> </tr> <tr> <td>6.</td> <td>Meat loaf</td> <td>1.0 - 2.0 lb</td> </tr> </tbody> </table>		SETTING	FOOD	AMOUNT	1.	Fresh roll - muffin	1 - 8	2.	Frozen roll - muffin	1 - 8	3.	Hot cereal	1 - 4 servings	4.	Turkey breast	3.0 - 6.0 lb	5.	Pork loin	2.0 - 3.5 lb	6.	Meat loaf	1.0 - 2.0 lb					
SETTING	FOOD	AMOUNT																									
1.	Fresh roll - muffin	1 - 8																									
2.	Frozen roll - muffin	1 - 8																									
3.	Hot cereal	1 - 4 servings																									
4.	Turkey breast	3.0 - 6.0 lb																									
5.	Pork loin	2.0 - 3.5 lb																									
6.	Meat loaf	1.0 - 2.0 lb																									

Carousel® and Auto-Touch® are registered trademarks of Sharp Corporation.

SHARP SHARP ELECTRONICS CORPORATION
Sharp Plaza, Mahwah, NJ 07430-2135

TINSEB243MRR0
Printed in USA

Download from www.Somanuals.com. All Manuals Search And Download.



Free Manuals Download Website

<http://myh66.com>

<http://usermanuals.us>

<http://www.somanuals.com>

<http://www.4manuals.cc>

<http://www.manual-lib.com>

<http://www.404manual.com>

<http://www.luxmanual.com>

<http://aubethermostatmanual.com>

Golf course search by state

<http://golfingnear.com>

Email search by domain

<http://emailbydomain.com>

Auto manuals search

<http://auto.somanuals.com>

TV manuals search

<http://tv.somanuals.com>