

OVER THE RANGE MODELS

arouse®

**R-1510, R-1511, R-1514**

microwave  
cooking  
installation guide  
instructions



# FOR CUSTOMER ASSISTANCE

To aid in reporting this microwave oven in case of loss or theft, please record below the model number and serial number located on the unit. We also suggest you record all the information listed and retain for future reference.

<b>MODEL NUMBER</b> _____	<b>SERIAL NUMBER</b> _____
<b>DATE OF PURCHASE</b> _____	
<b>DEALER</b> _____	<b>TELEPHONE</b> _____
<b>SERVICER</b> _____	<b>TELEPHONE</b> _____

## TO PHONE:

**DIAL 1-800-BE-SHARP ( 237-4277 ) for :**

SERVICE (for your nearest Sharp Authorized Servicer)

PARTS (for your authorized parts distributor)

ADDITIONAL CUSTOMER INFORMATION

**DIAL 1-800-642-2122 for :**

ACCESSORIES and COOKBOOK

## TO WRITE:

Sharp Electronics Corporation

Customer Assistance Center

1300 Naperville Drive

Romeoville, IL 60446-1091

**TO ACCESS INTERNET:** [www.sharp-usa.com](http://www.sharp-usa.com)

Please provide the following information when you write or call: model number, serial number, date of purchase, your complete mailing address (including zip code), your daytime telephone number (including area code) and description of the problem.

## PRECAUTIONS TO AVOID POSSIBLE EXPOSURE TO EXCESSIVE MICROWAVE ENERGY

- (a) Do not attempt to operate this oven with the door open since open-door operation can result in harmful exposure to microwave energy. It is important not to defeat or tamper with the safety interlocks.
- (b) Do not place any object between the oven front face and the door or allow soil or cleaner residue to accumulate on sealing surfaces.
- (c) Do not operate the oven if it is damaged. It is particularly important that the oven door close properly and that there is no damage to the: (1) door (bent), (2) hinges and latches (broken or loosened), (3) door seals and sealing surfaces.
- (d) The oven should not be adjusted or repaired by anyone except properly qualified service personnel.

# CONTENTS

<b>For Customer Assistance</b> .....	<b>2</b>	<b>Special Features</b> .....	<b>23-30</b>
<b>Precautions to Avoid Possible</b>		Instant Sensor .....	24
<b>Exposure to Excessive</b>		Sensor Cook Center .....	25
<b>Microwave Energy</b> .....	<b>2</b>	Sensor Cook Recipes .....	26-27
<b>Contents</b> .....	<b>3</b>	Reheat .....	28
<b>Consumer Limited Warranty</b> .....	<b>4</b>	Defrost Center .....	29
<b>Product Information Card</b> .....	<b>4</b>	Keep Warm Plus .....	30
<b>Important Safety Instructions</b> .....	<b>5</b>	Hot Water .....	30
<b>Unpacking and Installation Instructions</b> .	<b>6-14</b>	<b>Other Convenient Features</b> .....	<b>31-32</b>
Unpacking and Examining Your Oven .....	6	Custom Help .....	31
Installation Instructions .....	6-14	Demonstration Mode .....	31
<b>Optional Accessories</b> .....	<b>14</b>	Help .....	31
<b>Information You Need to Know</b> .....	<b>15-17</b>	Multiple Sequence Cooking .....	32
About Your Oven .....	15	Timer .....	32
About Food .....	15	More or Less Time Adjustment .....	32
About Utensils and Coverings .....	16	Minute Plus .....	32
About Children and the Microwave .....	16	Light Hi/Lo .....	32
About Microwave Cooking .....	17	Fan Hi/Lo .....	32
About Safety .....	17	<b>Cleaning and Care</b> .....	<b>33</b>
<b>Part Names</b> .....	<b>18-20</b>	<b>Replacing Parts</b> .....	<b>34</b>
<b>Before Operating</b> .....	<b>21</b>	<b>Service Call Check</b> .....	<b>35</b>
To Set the Clock .....	21	<b>Specifications</b> .....	<b>35</b>
Stop/Clear .....	21	<b>The Ultimate Accessory</b> .....	<b>36</b>
<b>Manual Operation</b> .....	<b>22</b>	<b>Cookbook Order Form</b> .....	<b>36</b>
Time Cooking .....	22	<b>Notes</b> .....	<b>37</b>
To Set Power Level .....	22	<b>Guia Auto-Touch</b> .....	<b>38-39</b>
Manual Defrost .....	22	<b>Auto-Touch Guide</b> .....	<b>39-Back Cover</b>

# CONSUMER LIMITED WARRANTY

SHARP ELECTRONICS CORPORATION warrants to the first consumer purchaser that this Sharp brand product (the "Product"), when shipped in its original container, will be free from defective workmanship and materials, and agrees that it will, at its option, either repair the defect or replace the defective Product or part thereof with a new or remanufactured equivalent at no charge to the purchaser for parts or labor for the period(s) set forth below.

This warranty does not apply to any appearance items of the Product nor to the additional excluded item(s) set forth below nor to any Product the exterior of which has been damaged or defaced, which has been subjected to misuse, abnormal service or handling, or which has been altered or modified in design or construction.

In order to enforce the rights under this limited warranty, the purchaser should follow the steps set forth below and provide proof of purchase to the servicer.

The limited warranty described herein is in addition to whatever implied warranties may be granted to purchasers by law. ALL IMPLIED WARRANTIES INCLUDING THE WARRANTIES OF MERCHANTABILITY AND FITNESS FOR USE ARE LIMITED TO THE PERIOD(S) FROM THE DATE OF PURCHASE SET FORTH BELOW. Some states do not allow limitations on how long an implied warranty lasts, so the above limitation may not apply to you.

Neither the sales personnel of the seller nor any other person is authorized to make any warranties other than those described herein, or to extend the duration of any warranties beyond the time period described above on behalf of Sharp.

The warranties described herein shall be the sole and exclusive warranties granted by Sharp and shall be the sole and exclusive remedy available to the purchaser. Correction of defects, in the manner and for the period of time described herein, shall constitute complete fulfillment of all liabilities and responsibilities of Sharp to the purchaser with respect to the Product, and shall constitute full satisfaction of all claims, whether based on contract, negligence, strict liability or otherwise. In no event shall Sharp be liable, or in any way responsible, for any damages or defects in the Product which were caused by repairs or attempted repairs performed by anyone other than an authorized servicer. Nor shall Sharp be liable or in any way responsible for any incidental or consequential economic or property damage. Some states do not allow the exclusion of incidental or consequential damages, so the above exclusion may not apply to you. THIS WARRANTY GIVES YOU SPECIFIC LEGAL RIGHTS. YOU MAY ALSO HAVE OTHER RIGHTS WHICH VARY FROM STATE TO STATE.

**Your Product Model Number & Description:**

R-1510, R-1511 or R-1514 Home Use Carousel™ Microwave Oven.  
(Be sure to have this information available when you need service for your Product.)

**Warranty Period for this Product:**

One (1) year parts and labor in-home service. The warranty period continues for an additional six (6) years, for a total of seven (7) years, with respect to the magnetron tube in the Product for parts only. Labor and the servicer trip charge are not provided free of charge for this additional period.

**Additional Item(s) Excluded from Warranty Coverage (if any):**

Non-functional accessories, turntable and light bulbs.

**Where to Obtain Service:**

From a Sharp Authorized Servicer located In the United States. Be sure to have **Proof of Purchase** available. For in-home service, the servicer will come to the unit's location. If it is necessary to remove the unit for repair, the servicer will reinstall the unit at no extra charge, provided it was installed according to Sharp's Installation Instructions. To find the location of the nearest Sharp Authorized Servicer, call Sharp toll free at 1-800-BE-SHARP (1-800-237-4277).

TO OBTAIN SUPPLY, ACCESSORY OR PRODUCT INFORMATION, CALL **1-800-BE-SHARP** OR VISIT [www.sharp-usa.com](http://www.sharp-usa.com).  
SAVE THE PROOF OF PURCHASE AS IT IS NEEDED SHOULD YOUR OVEN EVER REQUIRE WARRANTY SERVICE.

## PRODUCT INFORMATION CARD

The product information card should be completed within ten days of purchase and returned. It is necessary to write the model and serial numbers, found on the nameplate in the oven cavity, on the product information card. We will keep it on file and help you access the information in case of loss, damage or theft. This will also enable us to contact you in the unlikely event that any adjustments or modifications are ever required for your oven.

# IMPORTANT SAFETY INSTRUCTIONS

When using electrical appliances basic safety precautions should be followed, including the following:

**WARNING** - To reduce the risk of burns, electric shock, fire, injury to persons or exposure to excessive microwave energy:

1. **READ ALL INSTRUCTIONS BEFORE USING THE APPLIANCE.**
2. Read and follow the specific **“PRECAUTIONS TO AVOID POSSIBLE EXPOSURE TO EXCESSIVE MICROWAVE ENERGY”** on inside front cover.
3. This appliance must be grounded. Connect only to properly grounded outlet. See **“ELECTRICAL GROUNDING INSTRUCTIONS”** on page 7.
4. Install or locate this appliance only in accordance with the provided installation instructions.
5. Some products such as whole eggs and sealed containers—for example, closed glass jars—may explode and should not be heated in this oven.
6. Stir liquids briskly before, during and after heating to avoid eruption. Be careful.
7. Use this appliance only for its intended use as described in this manual. Do not use corrosive chemicals or vapors in this appliance. This type of oven is specifically designed to heat, cook or dry food. It is not designed for industrial or laboratory use.
8. As with any appliance, close supervision is necessary when used by children.
9. Do not operate this appliance if it has a damaged cord or plug, if it is not working properly or if it has been damaged or dropped.
10. This appliance should be serviced only by qualified service personnel. Contact nearest Sharp Authorized Servicer for examination, repair or adjustment.
11. Do not cover or block any openings on the appliance.
12. Do not store or use this appliance outdoors. Do not use this product near water—for example, near a kitchen sink, in a wet basement or near a swimming pool, and the like.
13. Do not immerse cord or plug in water.
14. Keep cord away from heated surfaces.
15. Do not let cord hang over edge of table or counter.
16. See door surface cleaning instructions on page 33.
17. To reduce the risk of fire in the oven cavity:
  - a. Do not overcook food. Carefully attend appliance if paper, plastic or other combustible materials are placed inside the oven to facilitate cooking.
  - b. Remove wire twist-ties from paper or plastic bags before placing bag in oven.
  - c. **If materials inside the oven should ignite, keep oven door closed, turn oven off and disconnect the power cord or shut off power at the fuse or circuit breaker panel.**
  - d. Do not use the cavity for storage purposes. Do not leave paper products, cooking utensils or food in the cavity when not in use.
18. Clean ventilation openings and grease filters frequently—Grease should not be allowed to accumulate on ventilation openings, louver or grease filters.
19. Use care when cleaning the louver and the grease filters. Corrosive cleaning agents, such as lye-based oven cleaners, may damage the louver and the grease filters.
20. When flaming food under the hood, turn the fan on.
21. This appliance is suitable for use above both gas and electric cooking equipment 36” wide or less.

## SAVE THESE INSTRUCTIONS

# UNPACKING AND INSTALLATION INSTRUCTIONS

Open the bottom of the carton, bend the carton flaps back and tilt the oven over to rest on plastic foam pad. Lift carton off oven and remove all packing materials, WALL and TOP CABINET TEMPLATE, Turntable, and Turntable Support. SAVE THE CARTON AS IT MAY MAKE INSTALLATION EASIER.

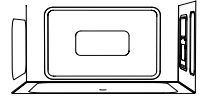

1. Remove the feature sticker from the outside of the door, if there is one.
2. DO NOT REMOVE THE WAVEGUIDE COVER, which is located on the right side wall of the oven cavity. Check to see that there is a WALL TEMPLATE and TOP CABINET TEMPLATE. Read enclosures and SAVE the Operation Manual.

Check the oven for any damage, such as misaligned or bent door, damaged door seals and sealing surfaces, broken or loose door hinges and latches and dents inside the cavity or on the door. If there is any damage, do not operate the oven and contact your dealer or SHARP AUTHORIZED SERVICER. See Installation Instructions for more details.

# UNPACKING AND INSTALLATION INSTRUCTIONS

## 3 ELECTRICAL GROUNDING INSTRUCTIONS

This appliance must be grounded. This oven is equipped with a cord having a grounding wire with a grounding plug. It must be plugged into a wall receptacle that is properly installed and grounded in accordance with the National Electrical Code and local codes and ordinances. In the event of an electrical short circuit, grounding reduces risk of electric shock by providing an escape wire for the electric current.

**WARNING** - Improper use of the grounding plug can result in a risk of electric shock.

### Electrical Requirements

The oven is equipped with a 3-prong grounding plug. **DO NOT UNDER ANY CIRCUMSTANCES CUT OR REMOVE THE GROUNDING PIN FROM THE PLUG.**

The Power Supply Cord and plug must be connected to a separate 120 Volt AC, 60 Hz, 15 Amp, or more branch circuit, single grounded receptacle. The receptacle should be located inside the cabinet directly above the Microwave Oven mounting location as shown in Figure 2.

NOTE:

1. If you have any questions about the grounding or electrical instructions, consult a qualified electrician or serviceperson.
2. Neither Sharp nor the dealer can accept any liability for damage to the oven or personal injury resulting from failure to observe the correct electrical connection procedures.

### Radio or TV Interference

Should there be any interference caused by the microwave oven to your radio or TV, check that the microwave oven is on a different electrical circuit, relocate the radio or TV as far away from the oven as feasible or check position and signal of receiving antenna.

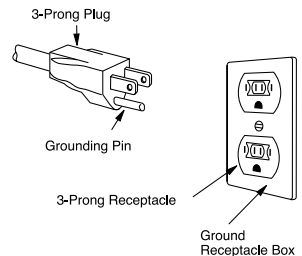
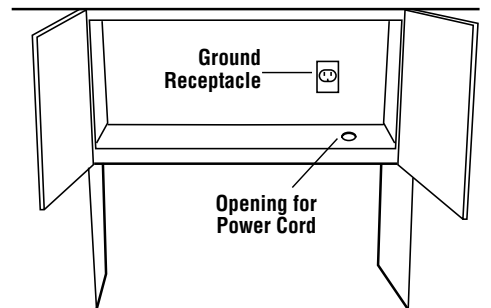

Figure 2



## 4 HOOD EXHAUST DUCT

When the hood is vented to the outside, a hood exhaust duct is required. All ductwork must be metal; absolutely do not use plastic duct. Check that all connections are made securely. Please read the following carefully:







**Exhaust connection:** The hood exhaust has been designed to connect to a standard 3-1/4" X 10" rectangular duct. If round duct is required, a rectangular-to-round adapter must be used.

**Rear exhaust:** If a rear or horizontal exhaust is to be used, care should be taken to align the exhaust with the space between the studs, or wall should be prepared at the time it is constructed by leaving enough space between wall studs to accommodate exhaust.

**Maximum duct length:** For satisfactory air movement, the total duct length of 3-1/4" X 10" rectangular or 6" diameter round duct should not exceed 140 feet.

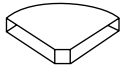
Elbows, adapters, wall caps, roof caps, etc. present additional resistance to air flow and are equivalent to a section of straight duct which is longer than their actual physical size. When calculating the total length, add the equivalent lengths of all transitions and adapters plus the length of all straight duct sections. Figure 3 shows the approximate feet of equivalent length of some typical ductwork parts. Use the values in parentheses for calculating air flow resistance equivalent, which should total less than 140 feet.

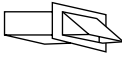
Figure 3

 90° ELBOW (10 FT.)	 45° ELBOW (5 FT.)	 ADAPTOR (5 FT.)	 10" WIDE ELBOW (10 FT.)
 90° ELBOW (25 FT.)	 45° ELBOW (5 FT.)	 WALL CAP (40 FT.)	 ROOF CAP (24 FT.)

# UNPACKING AND INSTALLATION INSTRUCTIONS

## 5 TOOLS RECOMMENDED FOR INSTALLATION

- Phillips Screwdriver
- Electric Drill
- 1/2", 5/8" and 3/32" Drill Bits
- 1-1/2" Wood Bit or Metal Hole Cutter (if metal cabinet is used)
- Saw to cut exhaust opening (if needed)
- Protective Drop Cloth for product and range - you may also use carton for protection
- Scissors
- Pencil
- Measure
- Tape

## 6 INSTALLATION HARDWARE

The INSTALLATION HARDWARE items ① - ⑦ are in a small bag. Items ⑧ - ⑪ are packed separately. All items are in a small carton packed below the oven.

ITEM	NAME	QUANTITY	PART CODE
①	Wood Screw 5 X 30 mm	6	XTSSD50P35000
②	Toggle Bolt with nuts #10 - 24 X 50 mm	4	LX-BZ0195WRE0
③	Top Cabinet Screw 5 X 60 mm	2	XBRSD50P60000
④	Power Cord Hanger	1	LX-MZB001MRE0
⑤	Tapping Screw 4 x 12 mm	3	XOTSD40P12000
⑥	Flat Washer 30 mm diameter	2	XWHSD50-16300
⑦	Grommet	1	LBSHC0040MRE0
⑧	Rear Cushion	1	PCUSUB059MRP0
⑨	Exhaust Damper Assembly	1	FFTA-B005MRK0
⑩	Scale Plate	2	LANG-B002MRP0
⑪	Grease Filter	2	PFIL-B002MRE0

**Figure 4**

Parts shown not to common scale.

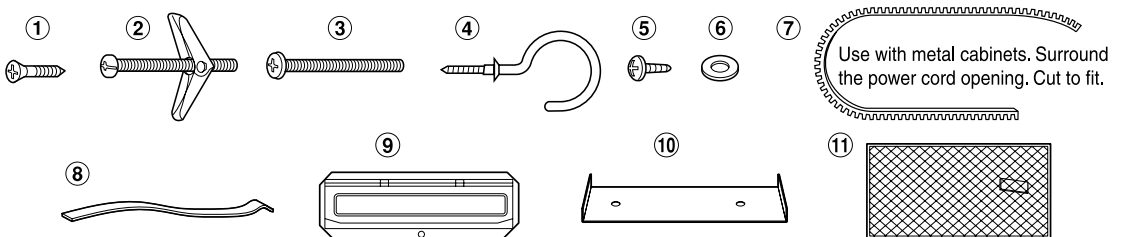



# UNPACKING AND INSTALLATION INSTRUCTIONS

## 7 PREPARATION OF THE OVEN

1. Turn oven on the side. See Figure 5.
2. Follow steps (A)-(D) to remove mounting plate from the back of the oven as shown in Figure 5.
  - (A) Release mounting plate by pulling out the lever that is on the bottom of the oven. See Figure 6.
  - (B) When lever is out, pull that side of the mounting plate away from the oven. See Figure 5.
  - (C) Repeat step (A) on other side.
  - (D) Repeat step (B) on other side.

**Figure 6**

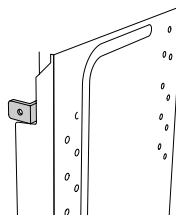

# UNPACKING AND INSTALLATION INSTRUCTIONS

## 8 VENTILATION SYSTEM (PREPARING OVEN FOR INSTALLATION)

This Microwave Oven/Hood is designed for adaptation to three types of hood ventilation systems. Select the type required for your installation.

**Recirculating** — non-vented, ductless. Follow installation procedure (A). Recirculating requires the use of the Charcoal Filter, which has already been installed in the oven.

**Horizontal Exhaust** — outside ventilation. Follow installation procedure (B).

**Vertical Exhaust** — outside ventilation. Follow installation procedure (C).

### (A) RECIRCULATING: Non-Vented, Ductless Operation

The unit is shipped assembled for recirculating.

- NOTE:
1. The Exhaust Damper Assembly ⑨ is not required for recirculating operation.
  2. The Charcoal Filter should be replaced every 6 to 12 months, depending on use.
  3. The Charcoal Filter RK-240 is also sold as an accessory. See Page 14 for ordering information.

### (B) HORIZONTAL EXHAUST: OUTSIDE VENTILATION

1. Remove 2 screws from back edge and 3 screws from the top center of Fan Cover Bracket. Save 2 screws to be used later and discard remaining 3. Remove Fan Cover Bracket by sliding it in the opposite direction of the arrow on the Fan Cover Bracket, as shown in Figure 7.
2. Lift Hood Fan Unit carefully and slip wires out of cavity. See Figure 8. CAUTION: Do not pull or stretch hood fan wiring.
3. Rotate the Hood Fan Unit 180° so that the fan blade openings are facing the back of the oven. See Figure 9 (A). Replace Hood Fan Unit into the oven. Be careful not to pinch the wire and the Hood Fan Unit. See Figure 9 (B).
4. Put the wire back into the cavity. See Figure 10.

Figure 7

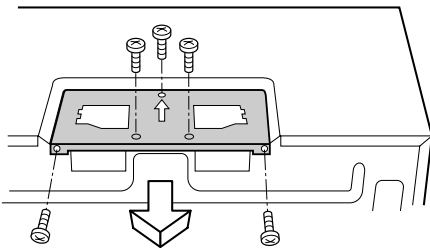

Figure 8

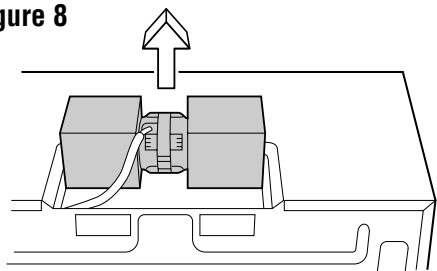

Figure 9

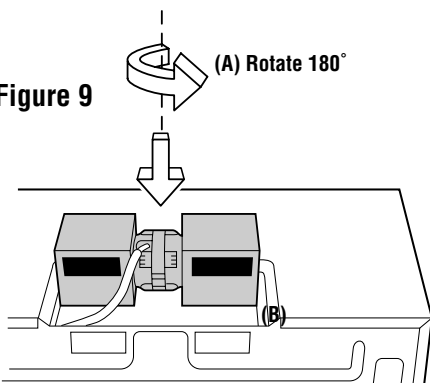
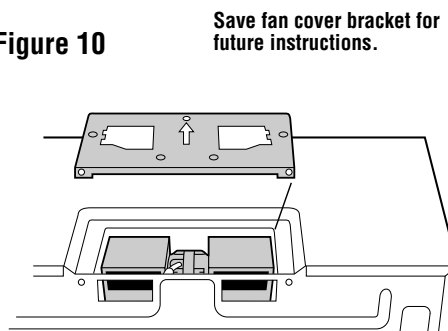

Figure 10



# UNPACKING AND INSTALLATION INSTRUCTIONS

## (C) VERTICAL EXHAUST: OUTSIDE VENTILATION

1. Remove and save 2 screws from back edge and 3 screws from the top center of the Fan Cover Bracket. Remove Fan Cover Bracket by sliding it in the opposite direction of the arrow on the Fan Cover Bracket as shown in Figure 11.
2. Lift Hood Fan Unit carefully and slip wires out of cavity. See Figure 12. CAUTION: Do not pull or stretch hood fan wiring.
3. Rotate the Hood Fan Unit 90° so that the fan blade openings are facing the top of the oven. See Figure 13 (A). Replace Hood Fan Unit into the oven. Be careful not to pinch the lead wire between the inner bracket and the Hood Fan Unit. Put the lead wire into Wire Box. See Figure 13 (B).
4. Replace the Fan Cover Bracket by sliding it into the slits in the same direction as the arrow on the Fan Cover Bracket. Make sure the fan blades are visible through the top openings in the oven before proceeding.
5. Attach the Fan Cover Bracket to unit with the 2 screws from back edge and 3 screws from the top center of the Fan Cover Bracket, which were removed in Step 1 above. See Figure 14. The Hood Fan Unit is now rotated for vertical exhaust operation.
6. Attach the Exhaust Damper Assembly ⑨ to the fan cover on the top of the outercase cabinet by sliding it into the slits in the same direction as the arrow. Use 1 Tapping Screw 4 X12 mm ⑤ from the INSTALLATION HARDWARE and tighten into place. See Figure 15.

Figure 11

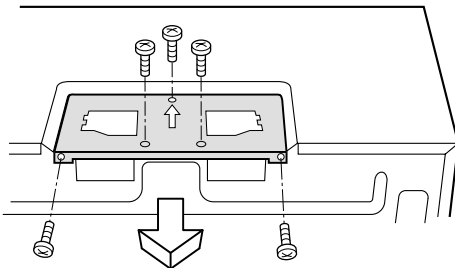

Figure 12

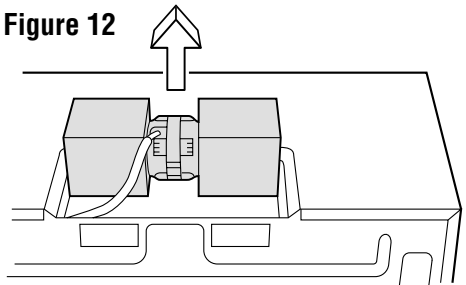

Figure 13

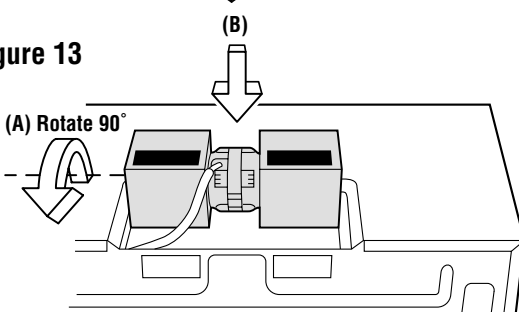

Figure 14

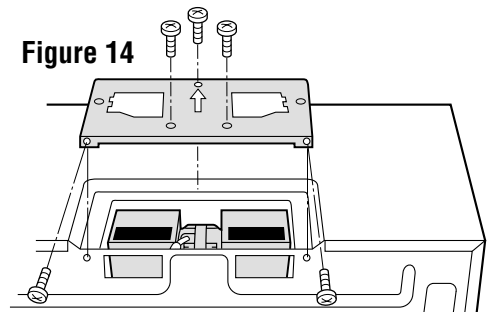
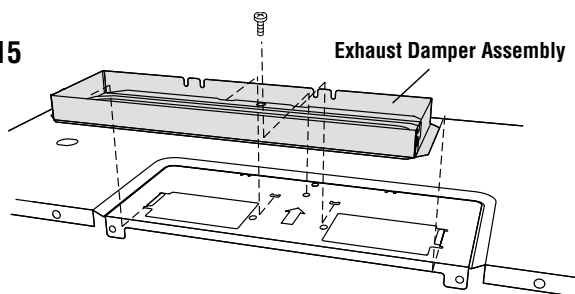

Figure 15



# UNPACKING AND INSTALLATION INSTRUCTIONS

## 9 OVEN INSTALLATION

THIS OVEN CANNOT BE PROPERLY INSTALLED WITHOUT REFERRING TO THE MOUNTING INSTRUCTIONS FOUND ON WALL AND TOP CABINET TEMPLATES.

THE NEXT STEP IS TO READ AND FOLLOW MOUNTING INFORMATION ON WALL AND TOP CABINET TEMPLATES. **THIS OVEN MUST BE ATTACHED TO AT LEAST ONE WALL STUD. SEE WALL CONSTRUCTION ON PAGE 6.**

WHEN DONE WITH TEMPLATES, PROCEED TO MOUNTING SCALE PLATE SECTION.

### MOUNTING SCALE PLATE

Attach 2 Scale Plates ⑩ with tape (not included). See Figure 16 and WALL TEMPLATE for locations.

**Figure 16**

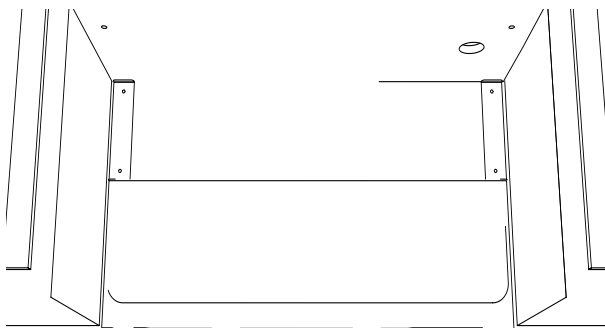

# UNPACKING AND INSTALLATION INSTRUCTIONS

Figure 20

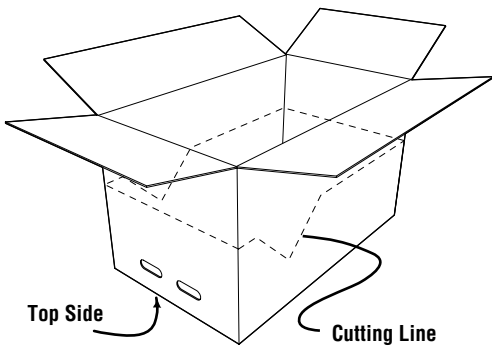
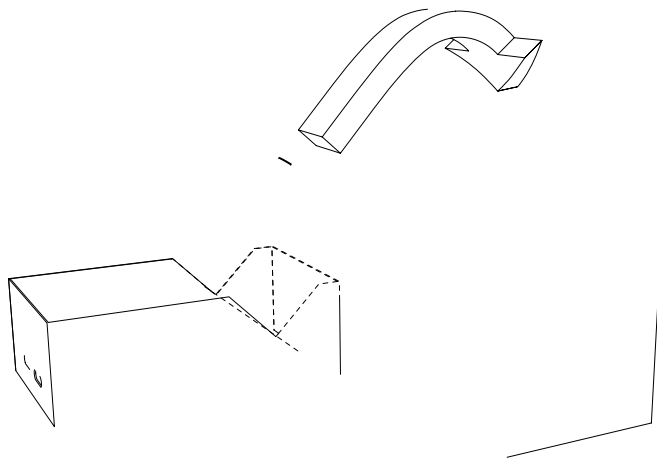
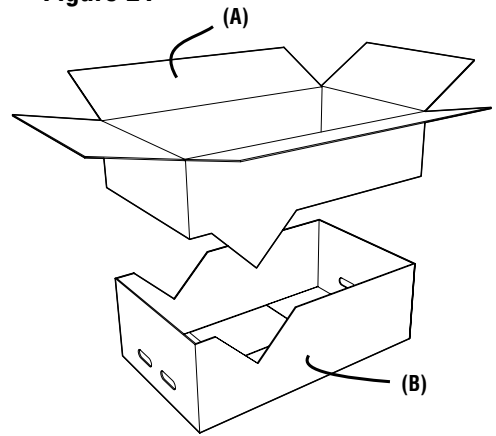

Figure 21



# UNPACKING AND INSTALLATION INSTRUCTIONS

Two people are recommended to attach the Microwave Oven/Hood to the Mounting Plate.

1. Thread the Power Supply Cord through the hole made in the bottom of the top cabinet. Install the oven by snapping it onto the Mounting Plate. See Figure 23.
2. Use two Tapping Screws ⑤ to secure the levers that are on the bottom of the oven. See Figure 24.
3. Use two Top Cabinet Screws ③ and two Flat Washers ⑥, supplied in the INSTALLATION HARDWARE, to attach the unit to the top cabinet. See Figure 25.
4. Make a bundle of the Power Supply Cord and attach it to the inside of the cabinet using the Power Cord Hanger ④. See Figure 25.

**Figure 23**

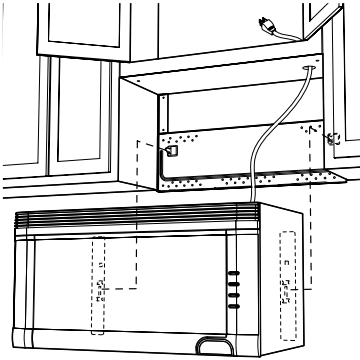

**Figure 24**

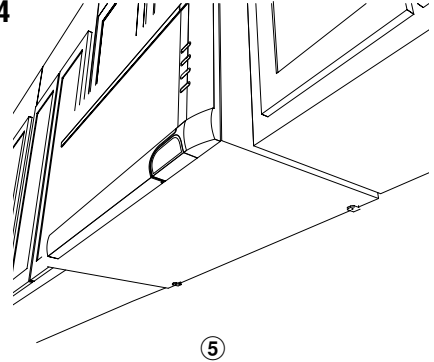

**Figure 25**

## OPTIONAL ACCESSORIES

**Two optional accessories are available for this oven.**

1. Charcoal Filter (RK-240). This is required when hood exhaust is recirculated. See Charcoal Filter on page 34. If dealer does not stock this item, it can be ordered by calling 1-800-642-2122.
2. Filler Panel Kit. For use when the oven is installed in a 36-inch or 42-inch wide opening. The metal filler panels come in 3-inch wide pairs. One set is needed for a 36-inch opening and 2 sets for a 42-inch opening. White and black are available.

To purchase contact:

Modern-Aire Ventilating Corporation  
7319 Lankershim Blvd.  
North Hollywood, CA 91605  
Phone: (818) 765-9870 Fax: (818) 765-4916

# INFORMATION YOU NEED TO KNOW

## ABOUT YOUR OVEN

This Operation Manual is valuable: read it carefully and always save it for reference.

A good microwave cookbook is a valuable asset. Check it for microwave cooking principles, techniques, hints and recipes. See pages 36 for ordering the Ultimate Accessory, the SHARP CAROUSEL MICROWAVE COOKBOOK.

**NEVER** use the oven without the turntable and support nor turn the turntable over so that a large dish could be placed in the oven. The turntable will turn both clockwise and counterclockwise.

**ALWAYS** have food in the oven when it is on to absorb the microwave energy.

When using the oven at power levels below 100%, you may hear the magnetron cycling on and off. It is normal for the exterior of the oven to be warm to the touch when cooking or reheating.

Condensation is a normal part of microwave cooking. Room humidity and the moisture in food will influence the amount of moisture that condenses in the oven. Generally, covered foods will not cause as much condensation as uncovered ones. Ventilation openings must not be blocked.

The oven is for food preparation only. It should not be used to dry clothes or newspapers.

All ovens are rated 1000 watts by using the IEC Test Procedure. In using recipes or package directions, check food a minute or two before the minimum time and add time accordingly.

## ABOUT FOOD

FOOD	DO	DON'T
<b>Eggs, sausages, nuts, seeds, fruits &amp; vegetables</b>	<ul style="list-style-type: none"> <li>• Puncture egg yolks before cooking to prevent "explosion".</li> <li>• Pierce skins of potatoes, apples, squash, hot dogs and sausages so that steam escapes.</li> </ul>	<ul style="list-style-type: none"> <li>• Cook eggs in shells.</li> <li>• Reheat whole eggs.</li> <li>• Dry nuts or seeds in shells.</li> </ul>
<b>Popcorn</b>	<ul style="list-style-type: none"> <li>• Use specially bagged popcorn for the microwave oven.</li> <li>• Listen while popping corn for the popping to slow to 1 or 2 seconds or use special <b>POPCORN</b> pad.</li> </ul>	<ul style="list-style-type: none"> <li>• Pop popcorn in regular brown bags or glass bowls.</li> <li>• Exceed maximum time on popcorn package.</li> </ul>
<b>Baby food</b>	<ul style="list-style-type: none"> <li>• Transfer baby food to small dish and heat carefully, stirring often. Check temperature before serving.</li> <li>• Put nipples on bottles after heating and shake thoroughly. "Wrist" test before feeding.</li> </ul>	<ul style="list-style-type: none"> <li>• Heat disposable bottles.</li> <li>• Heat bottles with nipples on.</li> <li>• Heat baby food in original jars.</li> </ul>
<b>General</b>	<ul style="list-style-type: none"> <li>• Cut baked goods with filling after heating to release steam and avoid burns.</li> <li>• Stir liquids briskly before heating and allow to stand 20 seconds after heating before stirring or drinking to avoid eruption.</li> <li>• Use deep bowl, when cooking liquids or cereals, to prevent boilovers.</li> </ul>	<ul style="list-style-type: none"> <li>• Heat or cook in closed glass jars or air tight containers.</li> <li>• Can in the microwave as harmful bacteria may not be destroyed.</li> <li>• Deep fat fry.</li> <li>• Dry wood, gourds, herbs or wet papers.</li> </ul>

## ABOUT UTENSILS AND COVERINGS

It is not necessary to buy all new cookware. Many pieces already in your kitchen can be used successfully in your new microwave oven. Make sure the utensil does not touch the interior walls during cooking.

### Use these utensils for safe microwave cooking and reheating:

- glass ceramic (Pyroceram®), such as Corningware®.
- heat-resistant glass (Pyrex®)
- microwave-safe plastics
- paper plates
- microwave-safe pottery, stoneware and porcelain
- browning dish (Do not exceed recommended preheating time. Follow manufacturer's directions.)

### These items can be used for short time reheating of foods that have little fat or sugar in them:

- wood, straw, wicker

### DO NOT USE

- metal pans and bakeware
- dishes with metallic trim
- non-heat-resistant glass
- non-microwave-safe plastics (margarine tubs)
- recycled paper products
- brown paper bags
- food storage bags
- metal twist-ties

Should you wish to check if a dish is safe for microwaving, place the empty dish in the oven and microwave on HIGH for 30 seconds. A dish which

becomes very hot should not be used.

### The following coverings are ideal:

- Paper towels are good for covering foods for reheating and absorbing fat while cooking bacon.
- Wax paper can be used for cooking and reheating.
- Plastic wrap that is specially marked for microwave use can be used for cooking and reheating. DO NOT allow plastic wrap to touch food. Vent so steam can escape.
- Lids that are microwave-safe are a good choice because heat is kept near the food to hasten cooking.
- Oven cooking bags are good for large meats or foods that need tenderizing. DO NOT use metal twist ties. Remember to slit bag so steam can escape.

### How to use aluminum foil in your microwave oven:

- Small flat pieces of aluminum foil placed smoothly on the food can be used to shield areas that are either defrosting or cooking too quickly.
- Foil should not come closer than one inch to any surface of the oven.

Should you have questions about utensils or coverings, check a good microwave cookbook or follow recipe suggestions.

**ACCESSORIES** There are many microwave accessories available for purchase. Evaluate carefully before you purchase so that they meet your needs. A microwave-safe thermometer will assist you in determining correct doneness and assure you that foods have been cooked to safe temperatures. Sharp is not responsible for any damage to the oven when accessories are used.

## ABOUT CHILDREN AND THE MICROWAVE

Children below the age of 7 should use the microwave oven with a supervising person very near to them. Between the ages of 7 and 12, the supervising person should be in the same room.

The child must be able to reach the oven comfortably; if not, he/she should stand on a sturdy stool.

At no time should anyone be allowed to lean or swing on the oven door.

Children should be taught all safety precautions: use potholders, remove coverings carefully, pay special attention to packages that crisp food because they may be extra hot.

Don't assume that because a child has mastered one cooking skill he/she can cook everything.

Children need to learn that the microwave oven is not a toy. See page 31 for Child Lock feature.



## ABOUT MICROWAVE COOKING

- Arrange food carefully. Place thickest areas towards outside of dish.
- Watch cooking time. Cook for the shortest amount of time indicated and add more as needed. Food severely overcooked can smoke or ignite.
- Cover foods while cooking. Check recipe or cookbook for suggestions: paper towels, wax paper, microwave plastic wrap or a lid. Covers prevent spattering and help foods to cook evenly.
- Shield with small flat pieces of aluminum foil any thin areas of meat or poultry to prevent overcooking before dense, thick areas are cooked thoroughly.
- Stir foods from outside to center of dish once or twice during cooking, if possible.
- Turn foods over once during microwaving to speed cooking of such foods as chicken and hamburgers. Large items like roasts must be turned over at least once.
- Rearrange foods such as meatballs halfway through cooking both from top to bottom and from the center of the dish to the outside.
- Add standing time. Remove food from oven and stir, if possible. Cover for standing time which allows the food to finish cooking without overcooking.
- Check for doneness. Look for signs indicating that cooking temperatures have been reached.
  - Doneness signs include:**
    - Food steams throughout, not just at edge.
    - Center bottom of dish is very hot to the touch.
    - Poultry thigh joints move easily.
    - Meat and poultry show no pinkness.
    - Fish is opaque and flakes easily with a fork.

## ABOUT SAFETY

- Check foods to see that they are cooked to the United States Department of Agriculture's recommended temperatures.
- ALWAYS use potholders to prevent burns when handling utensils that are in contact with hot food. Enough heat from the food can transfer through utensils to cause skin burns.
- Avoid steam burns by directing steam away from the face and hands. Slowly lift the farthest edge of a dish's covering and carefully open popcorn and oven cooking bags away from the face.
- Stay near the oven while it's in use and check cooking progress frequently so that there is no chance of overcooking food.
- NEVER use the cavity for storing cookbooks or other items.
- Select, store and handle food carefully to preserve its high quality and minimize the spread of foodborne bacteria.
- Keep waveguide cover clean. Food residue can cause arcing and/or fires.
- Use care when removing items from the oven so that the utensil, your clothes or accessories do not touch the safety door latches.

TEMP	FOOD
160°F	... for fresh pork, ground meat, boneless white poultry, fish, seafood, egg dishes and frozen prepared food.
165°F	... for leftover, ready-to-reheat refrigerated, and deli and carry-out "fresh" food.
170°F	... white meat of poultry.
180°F	... dark meat of poultry.

To test for doneness, insert a meat thermometer in a thick or dense area away from fat or bone. NEVER leave the thermometer in the food during cooking, unless it is approved for microwave oven use.

# PART NAMES

FRONT VIEW

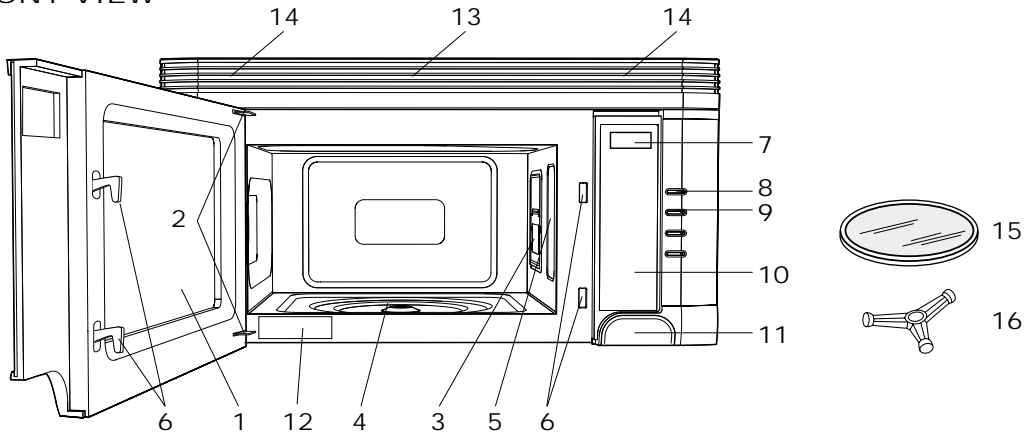

BOTTOM VIEW

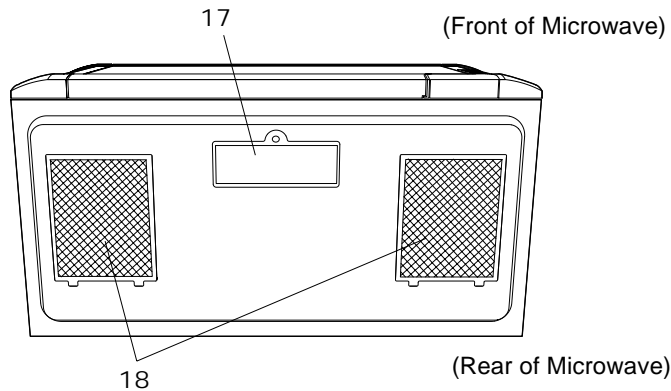

- |   |  |
|---|--|
| <p>1 Oven door with see-through window<br/>Be careful with the edge of the oven door as it is glass and could chip or break.</p> <p>2 Door hinges</p> <p>3 Waveguide cover:<br/>DO NOT REMOVE.</p> <p>4 Turntable motor shaft</p> <p>5 Oven light<br/>It will light when oven is operating or door is open.</p> <p>6 Safety door latches<br/>The oven will not operate unless the door is securely closed.</p> <p>7 Time display: Digital display, 99 minutes, 99 seconds</p> <p>8 LIGHT HI/LO pad<br/>Press the LIGHT HI/LO pad one time for high, twice for low and three times to turn it off.</p> <p>9 FAN HI/LO pad<br/>Press the FAN HI/LO pad to turn on the fan. Press again for low speed. Press a third time to turn the fan off.</p> | <p>10 Auto-Touch control panel</p> <p>11 One touch DOOR OPEN button<br/>Push to open door.</p> <p>12 Nameplate</p> <p>13 Louver</p> <p>14 Louver screws<br/>Remove screws to replace charcoal filter.</p> <p>15 Removable turntable<br/>The turntable will rotate clockwise or counter-clockwise. Only remove for cleaning.</p> <p>16 Removable turntable support<br/>First, carefully place the turntable support in the motor shaft in the center of the oven floor. Then, place the turntable on the turntable support securely.</p> <p>17 Light cover</p> <p>18 Grease filters</p> |
|---|--|

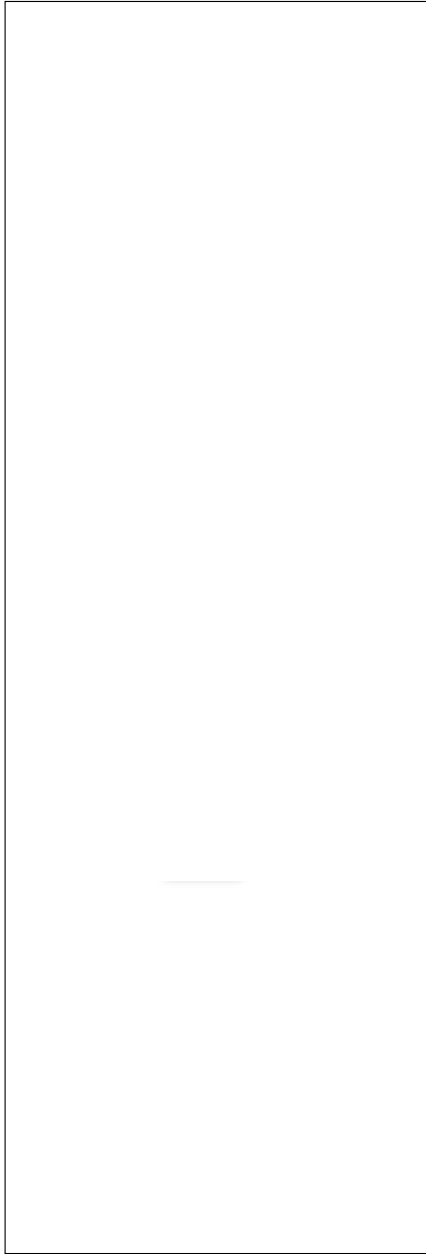

## CONTROL PANEL

Words in the lower portion of the display will light to indicate what function is in progress.

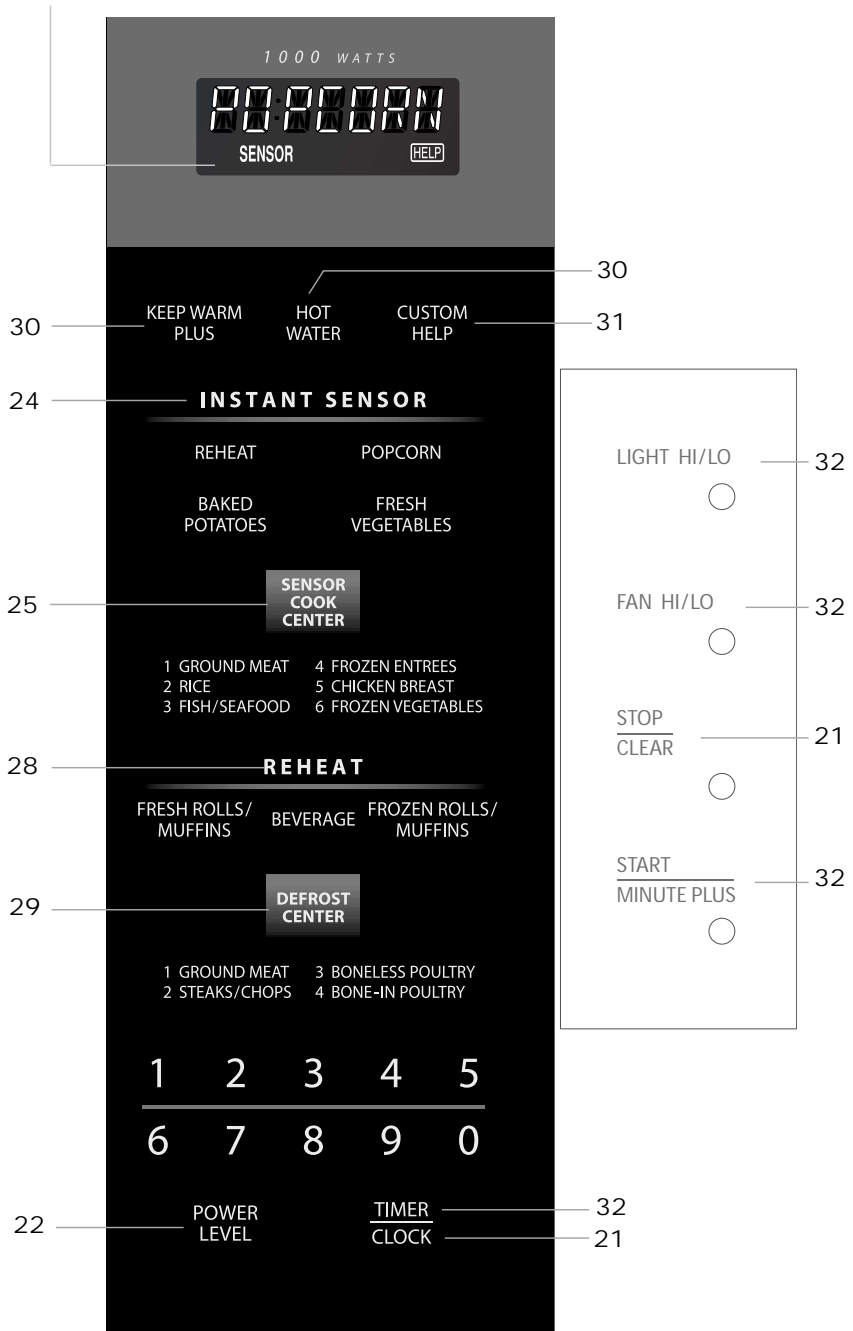

# R - 1 5 1 4

Number next to the control panel illustration indicates pages on which there are feature descriptions and usage information.

# BEFORE OPERATING

- Before operating your new microwave oven make sure you read and understand this operation manual completely.
- Before the oven can be used, follow these procedures:
  1. Plug in the oven. Close the door. The oven display will show **SHARP** **SIMPLY** **THE** **BEST** **PRESS** **CLEAR** **AND** **PRESS** **CLOCK**.
  2. Touch the **STOP/CLEAR** pad. **:** will appear.
  3. Set clock.

## TO SET THE CLOCK

- Suppose you want to enter the correct time of day 12:30 (A.M. or P.M.).

PROCEDURE	DISPLAY
1 <b>TIMER</b> <b>CLOCK</b> <b>2</b> Touch <b>CLOCK</b> pad and number 2.	<b>ENTER</b> <b>TIME</b>
2 <b>1</b> <b>2</b> <b>3</b> <b>0</b> Enter the correct time of day by touching the numbers in sequence.	<b>12:30</b>
3 <b>TIMER</b> <b>CLOCK</b> Touch <b>CLOCK</b> pad again.	<b>12:30</b>

This is a 12 hour clock. If you attempt to enter an incorrect clock time, **ERROR** will appear in the display. Touch the **STOP/CLEAR** pad and re-enter the time.

- If the electrical power supply to your microwave oven should be interrupted, the display will intermittently show **SHARP** **SIMPLY** **THE** **BEST** **PRESS** **CLEAR** **AND** **PRESS** **CLOCK** after the power is reinstated. If this occurs during cooking, the program will be erased. The time of day will also be erased. Simply touch **STOP/CLEAR** pad and reset the clock for the correct time of day.

## STOP/CLEAR

Touch the **STOP/CLEAR** pad to:

1. Erase if you make a mistake during programming.
2. Cancel timer.
3. Stop the oven temporarily during cooking.
4. Return the time of day to the display.
5. Cancel a program during cooking, touch twice.

# MANUAL OPERATION

## TO SET POWER LEVEL

There are eleven preset power levels.

Using lower power levels increases the cooking time which is recommended for foods such as cheese, milk and long slow cooking of meats. Consult cookbook or recipes for specific recommendations.

TOUCH POWER LEVEL PAD NUMBER OF TIMES FOR DESIRED POWER	APPROXIMATE PERCENTAGE OF POWER	COMMON WORDS FOR POWER LEVELS
POWER LEVEL x 1	100%	High
POWER LEVEL x 2	90%	
POWER LEVEL x 3	80%	
POWER LEVEL x 4	70%	Medium High
POWER LEVEL x 5	60%	
POWER LEVEL x 6	50%	Medium
POWER LEVEL x 7	40%	
POWER LEVEL x 8	30%	Med Low/Defrost
POWER LEVEL x 9	20%	
POWER LEVEL x 10	10%	Low
POWER LEVEL x 11	0%	

PROCEDURE	DISPLAY
1 Enter defrosting time.	5.00
2 Touch <b>POWER LEVEL</b> pad eight times or hold down until the desired power level appears.	P-30
3 Touch <b>START</b> pad.	5.00

## MANUAL DEFROST

If the food that you wish to defrost is not listed on the DEFROST CENTER CHART or is above or below the limits in the "Amount" column on the DEFROST CENTER CHART (see page 29), you need to defrost manually.

You can defrost any frozen food, either raw or previously cooked, by using Power Level for 30%. Follow the exact 4-step procedure found under To Set Power Level. Estimate defrosting time and press **POWER LEVEL** pad eight times for 30% power.

For either raw or previously cooked frozen food the rule of thumb is approximately 4 minutes per pound. For example, defrost 4 minutes for 1 pound of frozen

# SPECIAL FEATURES

## SENSOR COOK

Sharp's Sensor is a semi-conductor device that detects the vapor (moisture and humidity) emitted from the food as it heats. The sensor adjusts the cooking times and power level for various foods and quantities.

### Using Sensor Settings:

1. After oven is plugged in, wait 2 minutes before using Sensor Cook.
2. Be sure the exterior of the cooking container and the interior of the oven are dry. Wipe off any moisture with a dry cloth or paper towel.
3. The oven works with foods at normal storage temperature. For example, popcorn would be at room temperature.
4. Any Sensor Cook selection can be programmed with More or Less Time Adjustment. See page 32.
5. More or less food than the quantity listed in the chart should be cooked following the guidelines in any microwave cookbook.
6. During the first part of Sensor Cook, food name will appear on the display. Do not open the oven door or touch **STOP/CLEAR** during this part of the cooking cycle. The measurement of vapor will be interrupted. If this occurs, an error message will appear. To continue cooking, touch the **STOP/CLEAR** pad and cook manually.

When the sensor detects the vapor emitted from the food, remainder of cooking time will appear. Door may be opened when remaining cooking time appears on the display. At this time, you may stir or season food, as desired.

7. If the sensor does not detect vapor properly when popping popcorn, the oven will turn off, and the correct time of day will be displayed. If the sensor does not detect vapor properly when cooking other foods, **ERROR** will be displayed, and the oven will turn off.
8. Check food for temperature after cooking. If additional time is needed, continue to cook manually.
9. Each food has a cooking hint. Touch **CUSTOM HELP** pad when the **HELP** indicator is lighted in the display.

### Covering Foods:

Some foods work best when covered. Use the cover recommended in the Instant Sensor and Sensor Cook Center for these foods.

1. Casserole lid.
2. Plastic wrap: Use plastic wrap recommended for microwave cooking. Cover dish loosely; allow approximately 1/2 inch to remain uncovered to allow steam to escape. Plastic wrap should not touch food.
3. Wax paper: Cover dish completely; fold excess wrap under dish to secure. If dish is wider than paper, overlap two pieces at least one inch to cover.

Be careful when removing any covering to allow steam to escape away from you.

# SPECIAL FEATURES

## INSTANT SENSOR

Instant Sensor allows you to cook or reheat many of your favorite foods by touching just one pad.

- Suppose you want to cook 2 baked potatoes.

### PROCEDURE

1 Touch **BAKED POTATOES** pad.

**BAKED POTATOES**

2 Touch **START/MINUTE PLUS** pad.

**START MINUTE PLUS**

### NOTE:

1. Instant Sensor can be programmed with More or Less Time Adjustment. See page 32.
2. The final result will vary according to the food condition (e.g. initial temperature, shape, quality). Check food for temperature after heating. If additional time is needed, continue to heat manually.

## INSTANT SENSOR CHART

FOOD	AMOUNT	PROCEDURE
REHEAT	4 - 36 oz	Place in dish or casserole slightly larger than amount to be reheated. Flatten, if possible. Cover with lid, plastic wrap or wax paper. Use covers such as plastic wrap or lids with larger quantities of more dense foods such as stews. After reheating, stir well, if possible. Re-cover and allow to stand 2 to 3 minutes. Foods should be very hot. If not, continue to heat with variable power and time.
POPCORN	2.85 - 3.5 oz bag (Regular) 1.5 - 1.75 oz bag (Snack)	Use only popcorn packaged for the microwave. Try several brands to decide which you like. Do not try to pop unpopped kernels. Touch <b>POPCORN</b> pad once for regular size, touch again for snack size.
BAKED POTATOES	1 - 6 med.	Pierce. Place on paper-towel-lined turntable. After cooking, remove from oven, wrap in aluminum foil and let stand 5 to 10 minutes.
FRESH VEGETABLES: Soft		Wash and place in casserole. Add no water if vegetables have just been washed. Cover with lid for tender vegetables. Use plastic wrap for tender-crisp vegetables. Touch <b>FRESH VEGETABLES</b> pad. After cooking, stir, if possible. Let stand, covered, for 2 to 5 minutes.
Broccoli	.25 - 2.0 lb	
Brussels sprouts	.25 - 2.0 lb	
Cabbage	.25 - 2.0 lb	
Caulif. (flowerets)	.25 - 2.0 lb	
Cauliflower (whole)	1 med.	
Spinach	.25 - 1.0 lb	
Zucchini	.25 - 2.0 lb	
Baked apples	2 - 4 med.	
FRESH VEGETABLES: Hard		Place in casserole. Add 1-4 tbsp water. Cover with lid for tender vegetables. Use plastic wrap cover for tender-crisp vegetables. Touch <b>FRESH VEGETABLES</b> pad twice. After cooking, stir, if possible. Let stand, covered, for 2 to 5 minutes.
Carrots, sliced	.25 - 1.5 lb	
Corn on the cob	2 - 4	
Green beans	.25 - 1.5 lb	
Winter squash:		
diced	.25 - 1.5 lb	
halves	1 - 2	



# SPECIAL FEATURES

## SENSOR COOK CENTER

You can cook many foods by touching the Sensor Cook Center pad and the food number. You don't need to calculate cooking time or power level.

- Suppose you want to cook ground meat.

### PROCEDURE

1 Touch **SENSOR COOK CENTER** pad and number **1**. 

2 Touch **START/MINUTE PLUS** pad. 

When the sensor detects the vapor emitted from the food, remainder of cooking time will appear.

### NOTE:

1. Sensor Cook Center can be programmed with More or Less Time Adjustment. See page 32.
2. The final result will vary according to the food condition (e.g. initial temperature, shape, quality). Check food for temperature after heating. If additional time is needed, continue to heat manually.

## SENSOR COOK CENTER CHART

FOOD	AMOUNT	PROCEDURE															
1. GROUND MEAT	.25 - 2.0 lb	Use this setting to cook ground beef or turkey as patties or in a casserole to be added to other ingredients. Place patties on a microwave-safe rack and cover with wax paper. Place ground meat in a casserole and cover with wax paper or plastic wrap. When oven stops, turn patties over or stir meat in casserole to break up large pieces. Re-cover and touch <b>START/MINUTE PLUS</b> . After cooking, let stand, covered, for 2 to 3 minutes.															
2. RICE	.5 - 2.0 cups	Place rice into a deep casserole dish and add double quantity of water. Cover with lid or plastic wrap. After cooking, stir, cover and let stand 3 to 5 minutes or until all liquid has been absorbed. <table border="1" data-bbox="504 1101 1155 1271"> <thead> <tr> <th>Rice</th> <th>Water</th> <th>Size of casserole dish</th> </tr> </thead> <tbody> <tr> <td>.5 cup</td> <td>1 cup</td> <td>1.5 quart</td> </tr> <tr> <td>1 cup</td> <td>2 cups</td> <td>2 quart</td> </tr> <tr> <td>1.5 cups</td> <td>3 cups</td> <td>2.5 or 3 quart</td> </tr> <tr> <td>2 cups</td> <td>4 cups</td> <td>3 quart or larger</td> </tr> </tbody> </table>	Rice	Water	Size of casserole dish	.5 cup	1 cup	1.5 quart	1 cup	2 cups	2 quart	1.5 cups	3 cups	2.5 or 3 quart	2 cups	4 cups	3 quart or larger
Rice	Water	Size of casserole dish															
.5 cup	1 cup	1.5 quart															
1 cup	2 cups	2 quart															
1.5 cups	3 cups	2.5 or 3 quart															
2 cups	4 cups	3 quart or larger															
3. FISH/SEAFOOD	.25 - 2.0 lb	Arrange in ring around shallow glass dish (roll fillet with edges underneath). Cover with plastic wrap. After cooking, let stand, covered, 3 minutes.															
4. FROZEN ENTREES	6 - 17 oz	Use this setting for frozen, convenience foods. It will give satisfactory results for most brands. You may wish to try several and choose your favorite. Remove package from outer wrapping and follow package directions for covering. After cooking, let stand, covered for 1 to 3 minutes.															
5. CHICKEN BREAST	.5 - 2.0 lb	Cover with vented plastic wrap. When oven stops, turn over. Shield with small, flat pieces of aluminum foil any areas that are cooking too rapidly. Re-cover and touch <b>START/MINUTE PLUS</b> . After cooking, let stand, covered 3 to 5 minutes. Chicken should be 160°F.															
6. FROZEN VEGETABLES	.25 - 1.25 lb	Do not add water. Cover with lid or plastic wrap. After cooking, stir and let stand, covered, for 3 minutes.															

## SENSOR COOKING RECIPES

### Mexican Seasoned Potatoes

Makes 6 to 8 servings

- |  |                             |
|--|-----------------------------|
| 4 medium baking potatoes (8 ounces each) | 1/2 teaspoon oregano leaves |
| 1/4 cup olive oil                        | 1/4 teaspoon ground cumin   |
| 1 tablespoon instant minced onion        | 1/2 teaspoon salt           |
| 1/2 teaspoon chili powder                |                             |

- 1 Cut each potato lengthwise into 4 equal wedges. Place potato wedges into 10-inch square casserole. Toss potatoes with oil to coat well.
- 2 In small bowl, combine remaining ingredients. Sprinkle over potatoes.
- 3 Cover potatoes with wax paper. Microwave using **INSTANT SENSOR BAKED POTATOES** setting. Rearrange potatoes when time appears on display. Let stand, covered, 5 minutes.

### Hearty Turkey Chili

Makes 6 servings

- |                            |  |
|----------------------------|--|
| 1 pound ground turkey      | 1 medium zucchini, cut into 1 inch cubes           |
| 1 large onion, chopped     | 1 28 ounce can of tomatoes                         |
| 2 garlic cloves, minced    | 1/3 cup tomato paste                               |
| 2 tablespoons chili powder | 1 15 1/4 to 19 ounce can red kidney beans, drained |
| 1 tablespoon cumin         | 8 ounces frozen corn, thawed                       |

- 1 In 3-quart casserole, place ground turkey, onion, garlic, chili powder and cumin. Mix thoroughly.
- 2 Cover and microwave using **1.GROUND MEAT**. Stir and drain.
- 3 To meat mixture, add zucchini, tomatoes with their liquid, tomato paste, beans and corn. Microwave, covered, using **INSTANT SENSOR REHEAT**.

### Creole Corn

Makes 6 servings

- |   |                                   |
|---|-----------------------------------|
| 2 teaspoons oil                               | 1 teaspoon brown sugar            |
| 1/2 cup chopped celery                        | 1/2 teaspoon onion powder         |
| 1/2 cup chopped green pepper                  | 1/4 teaspoon garlic powder        |
| 16 ounce can tomatoes                         | salt and pepper to taste          |
| 4 ounce can mushroom stem and pieces, drained | 1 package (16 ounces) frozen corn |

- 1 In 2-quart casserole, combine oil, celery, green pepper, tomatoes, mushrooms, sugar, onion powder, garlic powder, salt and pepper.
- 2 Microwave using **INSTANT SENSOR REHEAT**. Set aside.
- 3 In covered, 1-quart casserole, microwave corn using **6.FROZEN VEGETABLES**. Drain.
- 4 Combine corn and vegetable-seasoning mixture. Stir and serve immediately.

### Savory Flounder Fillets

Makes 4 servings

- |                               |                          |
|-------------------------------|--------------------------|
| 3/4 cup of corn flake crumbs  | 1/2 teaspoon paprika     |
| 3 tablespoons chopped parsley | 1 pound flounder fillets |
| 2 teaspoons grated lemon peel | 1 egg, slightly beaten   |

- 1 On waxed paper, combine corn flake crumbs, parsley, lemon peel and paprika. Dip fillets in beaten egg, then coat with crumb mixture.
- 2 Place fish in a covered, microwave-safe, baking dish. Microwave using **3.FISH/SEAFOOD**.
- 3 Serve with tartar or cocktail sauce or melted cheese.

# SPECIAL FEATURES

## SENSOR COOK RECIPES (continued)

### Glazed Apple Slices

Makes 6 to 8 servings

- |                                   |  |
|-----------------------------------|--|
| 1/4 cup brown sugar               | 3/4 cup orange juice   |
| 3 tablespoons margarine or butter | 1 tablespoon cornstarch  |
| 2 tablespoons apricot preserves   | 4 baking apples (about 1 1/2 pounds), peeled and sliced into 8 pieces each |
| 1/2 teaspoon ground nutmeg        | 3 tablespoons chopped green pistachios                                     |
| 1/4 teaspoon salt                 |  |
| 1/2 cup sugar                     |  |

- 1 Combine brown sugar, margarine and apricot preserves in a small bowl. Microwave at HIGH (100%) until margarine melts and preserves soften, 45 seconds to 1 minute. Stir in nutmeg, salt, sugar, orange juice and cornstarch. Microwave at HIGH (100%) until thickened, 4 to 6 minutes, stirring several times.
- 2 Arrange apple slices in a large microwave serving dish. Spread hot sauce over apples. Cover well with vented plastic wrap. Microwave using **INSTANT SENSOR FRESH VEGETABLES**: Soft. Allow to cool 5 minutes before serving.
- 3 Sprinkle with pistachios. Serve alone or over vanilla ice cream or sponge cake.

### Confetti Soup

Makes 6 servings

- |  |                                    |
|--|------------------------------------|
| 3 tablespoons butter or margarine                | 1 teaspoon salt                    |
| 1 cup cubed carrots, 1/4-inch cubes              | 1/2 teaspoon pepper                |
| 1 cup rutabaga, 1/4-inch cubes                   | 1/4 teaspoon sugar                 |
| 1 small zucchini, 1/4-inch cubes                 | 4 cups milk                        |
| 1/2 cup chopped onion                            | 1 cup shredded Cheddar cheese      |
| 1/2 cup chopped celery                           | 1 cup frozen corn, thawed          |
| 1 cup fresh broccoli flowerets or cauliflowerets | 1/2 cup cooked ham, 1/4-inch cubes |
| 1/4 cup all-purpose flour                        | 1/2 cup frozen peas, thawed        |

- 1 Combine butter, carrots, rutabaga, zucchini, onion, celery and broccoli in 3-quart, covered casserole.
- 2 Microwave using **INSTANT SENSOR FRESH VEGETABLES**: Soft. Stir well.
- 3 Stir in flour, salt, pepper, sugar, milk, cheese, corn, ham and peas.
- 4 Microwave using **INSTANT SENSOR REHEAT**. Stir well and serve with croutons.

### Mixed Company Vegetables

Makes 8 servings

- |   |   |
|---|---|
| 3 green onions, diagonally cut into 1-inch pieces | 3/4 pound carrots, cut into 1/4-inch thick slices       |
| 1 teaspoon minced garlic                          | 1 bunch of broccoli, cut into 2-inch by 1-inch pieces   |
| 1/4 teaspoon crushed red pepper                   | 1 medium red pepper, sliced into matchstick-thin strips |
| 2 tablespoons olive oil                           |   |
| 2 tablespoons teriyaki sauce                      | 1/2 pound medium mushrooms, sliced                      |

- 1 In a small, microwave-safe bowl, combine green onions, garlic, crushed red pepper and oil. Microwave on HIGH (100%) for 2 minutes. Stir in teriyaki sauce.
- 2 In a 3-quart casserole, place carrots, broccoli, red peppers and mushrooms. Cover with plastic wrap.
- 3 Microwave using **INSTANT SENSOR FRESH VEGETABLES**: Soft for tender crisp or **INSTANT SENSOR FRESH VEGETABLES**: Hard for softer vegetables.
- 4 Remove from oven and drain. Add green onion mixture and stir to combine. Serve immediately.

# SPECIAL FEATURES

## REHEAT

Reheat allows you to heat three of your favorite foods by touching just one pad.

- Suppose you want to heat 2 fresh rolls or muffins.

	PROCEDURE	DISPLAY
1	<div style="border: 1px solid black; padding: 2px; display: inline-block;">FRESH ROLLS/ MUFFINS</div> x 2	<div style="border: 1px solid black; padding: 2px; display: inline-block;">2 PCS <small>HELP</small></div>
	Select desired setting. Touch <b>FRESH ROLLS/MUFFINS</b> pad 2 times.	
2	<div style="border: 1px solid black; padding: 2px; display: inline-block;">START MINUTE PLUS</div>	Touch <b>START/ MINUTE PLUS</b> pad.

### NOTE:

1. To increase quantity, touch chosen pad until number in display is same as desired quantity to cook. Ex: touch **BEVERAGE** three times for 1.5 cups. More or less food than the quantity listed in the chart should be heated following the guidelines in any microwave cookbook.
2. Reheat can be programmed with More or Less Time Adjustment. See page 32.
3. The final result will vary according to the food condition (e.g. initial temperature, shape, quality). Check food for temperature after heating. If additional time is needed, continue to heat manually.

## REHEAT CHART

FOOD	AMOUNT	PROCEDURE								
FRESH ROLLS/ MUFFINS	1 - 8	Use this pad to warm rolls, muffins, biscuits, bagels etc. Large items should be considered as 2 or 3 regular size. Arrange on plate; cover with paper towel. For refrigerated rolls or muffins, it may be necessary to double the entered amount to ensure the proper serving temperature. For example, enter quantity of 2 for 1 refrigerated muffin.								
BEVERAGE	.5 - 2.0 cups	This setting is good for restoring cooled beverage to a better drinking temperature. Stir liquid briskly before and after heating to avoid "eruption". Touch <b>BEVERAGE</b> pad.  <div style="text-align: center;"><b>Press the pad for amount (cups).</b></div> <table border="1" style="margin-left: auto; margin-right: auto;"> <tr><td>Once</td><td>.5</td></tr> <tr><td>Twice</td><td>1.0</td></tr> <tr><td>3 times</td><td>1.5</td></tr> <tr><td>4 times</td><td>2.0</td></tr> </table>	Once	.5	Twice	1.0	3 times	1.5	4 times	2.0
Once	.5									
Twice	1.0									
3 times	1.5									
4 times	2.0									
FROZEN ROLLS/ MUFFINS	1 - 8	Use this pad to warm rolls, muffins, biscuits, bagels etc. Large items should be considered as 2 or 3 regular size. Arrange on plate; cover with paper towel.								

# SPECIAL FEATURES



## DEFROST CENTER

DEFROST CENTER automatically defrosts all the foods shown in the DEFROST CENTER CHART below.

Round the weight to the nearest half pound. (Ex: if the steak's actual weight is 2.2 lb round to 2.0 lb. If the steak's weight is 2.4 lb round to 2.5 lb).

Touch **DEFROST CENTER** pad and the desired number for food selection. Then enter weight in .1 lb.

- Suppose you want to defrost a 3.0 pound steak.

PROCEDURE	DISPLAY
<p>1 Touch <b>DEFROST CENTER</b> pad and press number <b>2</b> for STEAKS/CHOPS. Enter weight 3.0 lb. Touch <b>START/MINUTE PLUS</b> pad.</p> <p>The oven will stop and directions will be displayed.</p>	
<p>2 After the 1st stage, open the door, turn steak over and shield any warm portions. Close the door.</p> <p>Touch <b>START/MINUTE PLUS</b> pad.</p>	

- 3 After the 2nd stage, open the door and shield any warm portions. Close the door.

**START**  
**MINUTE PLUS**

Touch **START/MINUTE PLUS** pad.

- 4 After defrost cycle ends, cover and let stand as indicated in chart below.

### NOTE:

1. Any Defrost Center choice can be programmed with More or Less Time Adjustment. Touch the **POWER LEVEL** pad once or twice after selecting the amount. See page 32.
2. To defrost other foods or foods above or below the weights allowed on the DEFROST CENTER CHART, use time and 30% power. See MANUAL DEFROST on page 22.

If you attempt to enter more or less than the allowed amount as indicated in the chart below, **ERROR** will appear in the display.

## DEFROST CENTER CHART

FOOD	AMOUNT	PROCEDURE
1. GROUND MEAT	.5 - 2.0 lb	Pull apart and remove any thawed pieces after each stage. Let stand, covered, for 5 to 10 minutes.
2. STEAKS/CHOPS	.5 - 3.0 lb	After each stage, rearrange and if there are warm or thawed portions, shield with small flat pieces of aluminum foil. Remove any meat or fish that is nearly defrosted. Let stand, covered, for 10 to 20 minutes.
3. BONELESS POULTRY	.5 - 2.0 lb	Use boneless breast of chicken or turkey. After each stage, if there are warm or thawed portions, rearrange or remove. Let stand, covered, for 5 to 10 minutes.
4. BONE-IN POULTRY	.5 - 3.0 lb	Arrange pieces with meatiest portions toward outside of glass dish or microwave safe rack. After each stage, if there are warm or thawed portions, rearrange or remove. Let stand, covered, for 10 to 20 minutes.

NOTE: Check foods when oven signals. After final stage, small sections may still be icy. Let stand to continue thawing. Do not defrost until all ice crystals are thawed.

Shielding prevents cooking from occurring before the center of the food is defrosted. Use small smooth strips of aluminum foil to cover edges and thinner sections of the food.

# SPECIAL FEATURES

## KEEP WARM PLUS

KEEP WARM PLUS allows you to keep food warm for 30 minutes.

### DIRECT USE

- Suppose you want to keep a cup of soup warm for 30 minutes.

#### PROCEDURE

1 Touch **KEEP WARM PLUS** pad. 

2 Enter the desired time. 

3 Touch **START/MINUTE PLUS** pad. 

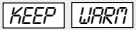
The oven will start. The display will show  and count down.  will be displayed during the countdown.

You can program Keep Warm Plus with manual cooking to keep food warm continuously after cooking.

## WITH MANUAL COOKING

- Suppose you want to cook a cup of soup for 2 minutes at 70% and keep the soup warm for 15 minutes.

#### PROCEDURE

1 Enter cooking time. 

2 Touch **POWER LEVEL** pad 4 times for 70% power.  x 4

3 Touch **KEEP WARM PLUS** pad. 

4 Enter the desired time. 

5 Touch **START/MINUTE PLUS** pad. 

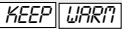
The operation will start. When the cooking time is complete, a long tone will sound and Keep Warm Plus will start.  will appear in the display every 10 seconds and count down for 15 minutes.

NOTE: Keep Warm Plus cannot be programmed with SPECIAL FEATURES.

## HOT WATER

HOT WATER heats 1 to 6 cups of tap water to prepare coffee, tea, bouillon and instant soup as well as heat the water to cook pasta. When preparing individual cups, place instant coffee, tea or bouillon in cup and stir before heating. Allow to stand 20 seconds after heating before stirring and drinking. Stir carefully after removing from the oven. When heating 4 to 6 cups of water, place in large casserole and cover with lid or plastic wrap. When oven signals, add pasta and continue cooking according to package directions. Touch **HOT WATER** pad once for each cup up to 6.

- Suppose you want to heat 3 cups of water.

#### PROCEDURE

1 Touch **HOT WATER** pad 3 times.  x 3

2 Touch **START/MINUTE PLUS** pad. 

# OTHER CONVENIENT FEATURES

## CUSTOM HELP

Custom Help provides 4 features that make using your oven easy because specific instructions are provided in the interactive display.

### 1. CHILD LOCK

The Child Lock prevents unwanted oven operation such as by small children. The oven can be set so that the control panel is deactivated or locked. To set, touch **CUSTOM HELP**, the number **1** and then touch the **START/MINUTE PLUS** pad. Should a pad be touched, **CHILD LOCK ON** will appear in the display.

To cancel, touch **CUSTOM HELP** and **STOP/CLEAR** pad.

### 2. AUDIBLE SIGNAL ELIMINATION







If you wish to have the oven operate with no audible signals, touch **CUSTOM HELP**, the number **2** and **STOP/CLEAR**.

To cancel and restore the audible signal, touch **CUSTOM HELP**, the number **2** and **START/MINUTE PLUS**.

### 3. AUTO START

If you wish to program your oven to begin cooking automatically at a designated time of day, follow this procedure:

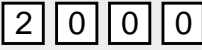
- Suppose you want to start cooking a stew for 20 minutes on 50% at 4:30. Before setting, check to make sure the clock is showing the correct time of day.

PROCEDURE	
1	Touch <b>CUSTOM HELP</b> pad. 
2	Touch number 3. 
3	Enter the start time. 
4	Touch <b>CLOCK</b> pad. 
5	Enter cooking program.  
6	Touch <b>START/MINUTE PLUS</b> pad. 

NOTE:

1. Auto Start can be used for manual cooking if clock is set.

2. If the oven door is opened after programming Auto Start, it is necessary to touch the **START** pad for Auto Start time to appear in the readout so that the oven will automatically begin programmed cooking at the chosen Auto Start time.
3. Be sure to choose foods that can be left in the oven safely until the Auto Start time. Acorn or butternut squash are often a good choice.
4. If you wish to know the time of day, simply touch the **CLOCK** pad. As long as your finger is touching the **CLOCK** pad, the time of day will be displayed.

### 4. LANGUAGE / WEIGHT SELECTION

The oven comes set for English and U.S. Customary Unit-pounds. To change, touch **CUSTOM HELP** and the number **4**. Continue to touch the number **4** until your choice is selected from the table below. Then, touch **START**.

Touch number **4** for language and standard of weight.

NUMBER	LANGUAGE	STANDARD OF WEIGHT	DISPLAY
Once	English	LBS	ENGLISH Lb
Twice	English	KG	ENGLISH KG
3 times	Spanish	LBS	ESPAÑOL Lb
4 times	Spanish	KG	ESPAÑOL KG
5 times	French	LBS	FRANC. Lb
6 times	French	KG	FRANC. KG

## DEMONSTRATION MODE

To demonstrate, touch **TIMER/CLOCK**, the number **0** and then touch the **START** pad and hold for three seconds. **DEMO** will appear in the display. Cooking operations and specific special features can now be demonstrated with no power in the oven. For example, touch **MINUTE PLUS** pad and the display will show **1:00** and count down quickly to **END**.

To cancel, touch **TIMER/CLOCK**, the number **0** and **STOP/CLEAR** pads. If easier, unplug the oven from the electrical outlet and replug.

## HELP

Each setting of INSTANT SENSOR, SENSOR COOK CENTER, REHEAT and DEFROST CENTER has a cooking hint. If you wish to check, touch **CUSTOM HELP** whenever HELP is lighted in the Interactive Display for these and other manual operation hints.

## OTHER CONVENIENT FEATURES

### MULTIPLE SEQUENCE COOKING

Your oven can be programmed for up to 4 automatic cooking sequences, switching from one power level setting to another automatically.

Sometimes cooking directions tell you to start on one power level and then change to a different power level. Your oven can do this automatically.

- Suppose you want to cook roast beef for 5 minutes at 100% and then continue to cook for 30 minutes at 50%.

PROCEDURE													
1	First enter cooking time. Then touch <b>POWER LEVEL</b> once for 100% power.												
	<table border="1"> <tr> <td>5</td> <td>0</td> <td>0</td> </tr> <tr> <td colspan="3" style="text-align: center;"><b>POWER LEVEL</b></td> </tr> <tr> <td colspan="3" style="text-align: right;">x 1</td> </tr> </table>	5	0	0	<b>POWER LEVEL</b>			x 1					
5	0	0											
<b>POWER LEVEL</b>													
x 1													
2	Then enter second cooking time. Touch <b>POWER LEVEL</b> pad 6 times for 50% power.												
	<table border="1"> <tr> <td>3</td> <td>0</td> <td>0</td> <td>0</td> </tr> <tr> <td colspan="4" style="text-align: center;"><b>POWER LEVEL</b></td> </tr> <tr> <td colspan="4" style="text-align: right;">x 6</td> </tr> </table>	3	0	0	0	<b>POWER LEVEL</b>				x 6			
3	0	0	0										
<b>POWER LEVEL</b>													
x 6													
3	Touch <b>START</b> pad.												
	<b>START</b> <b>MINUTE PLUS</b>												

NOTE:

1. If **POWER LEVEL** pad is touched, **P-HI** will be displayed.
2. If 100% is selected as the final sequence, it is not necessary to touch the **POWER LEVEL** pad.
3. Keep Warm can be programmed even if 4 cooking sequences have been set.

### TIMER

- Suppose you want to time a 3-minute long distance phone call.

PROCEDURE					
1	Touch <b>TIMER/CLOCK</b> and number 1 pad.				
	<table border="1"> <tr> <td><b>TIMER</b></td> <td><b>CLOCK</b></td> </tr> <tr> <td colspan="2" style="text-align: right;">1</td> </tr> </table>	<b>TIMER</b>	<b>CLOCK</b>	1	
<b>TIMER</b>	<b>CLOCK</b>				
1					
2	Enter time.				
	<table border="1"> <tr> <td>3</td> <td>0</td> <td>0</td> </tr> </table>	3	0	0	
3	0	0			
3	Touch <b>TIMER/CLOCK</b> pad.				
	<b>TIMER</b> <b>CLOCK</b>				
To cancel the timer, touch the <b>STOP/CLEAR</b> pad once.					
<b>STOP</b> <b>CLEAR</b>					

### MORE OR LESS TIME ADJUSTMENT

Should you discover that you like any of the Cook Center, Defrost Center, Reheat Center, Popcorn or Hot water settings slightly **more** done, touch the **POWER LEVEL** pad **once** after touching your choice of pads or before touching **START** pad. The display will show **MORE**.

Should you discover that you like any of the Cook Center, Defrost Center, Reheat Center, Popcorn or Hot water settings slightly **less** done, touch the **POWER LEVEL** pad **twice** after touching your choice of pads or before touching **START** pad. The display will show **LESS**.

### MINUTE PLUS

Minute Plus allows you to cook for a minute at 100% by simply touching the **START/MINUTE PLUS** pad. You can also extend cooking time in multiples of 1 minute by repeatedly touching the **START/MINUTE PLUS** pad during manual cooking.

- Suppose you want to heat a cup of soup for one minute.

PROCEDURE	
Touch <b>START/MINUTE PLUS</b> pad.	<b>START</b> <b>MINUTE PLUS</b>

NOTE:

1. To use Minute Plus, touch pad within 3 minutes after cooking, closing the door, touching the **STOP/CLEAR** pad or during cooking.
2. Minute Plus cannot be used with special features.

### LIGHT HI/LO

Press the **LIGHT HI/LO** pad one time for high, twice for low and three times to turn off.

### FAN HI/LO

The fan will automatically start when heat rises from range surface units or burners. This protects the microwave oven from excessive temperature rise. The fan will stay on until the temperature decreases. It cannot be turned off manually during this time.

For other uses, press **FAN HI/LO** pad to select fan speed or turn fan off.



# CLEANING AND CARE

## Exterior

The outside surface is precoated steel and plastic. Clean the outside with mild soap and water; rinse and dry with a soft cloth. Do not use any type of household or abrasive cleaner.

## Door

Be careful with the edge of the oven door as it is glass and could chip or break. Wipe the window on both sides with a damp cloth to remove any spills or spatters. Metal parts will be easier to maintain if wiped frequently with a damp cloth. Avoid the use of spray and other harsh cleaners as they may stain, streak or dull the door surface.

### **Stainless Steel Trim (R-1514)**

The exterior should be wiped often with a damp cloth and polished with a soft dry cloth to maintain its beauty. There are also a variety of products designed especially for cleaning and shining the stainless exterior of the oven. We recommend that the cleaner be applied to a soft cloth and then carefully used on the stainless exterior rather than sprayed directly onto it. Follow package directions carefully.

## Touch Control Panel

Wipe the panel with a cloth dampened slightly with water only. Dry with a soft cloth. Do not scrub or use any sort of chemical cleaners. Close door and touch **STOP/CLEAR**.

## Interior

Cleaning is easy because little heat is generated to the interior surfaces; therefore, there is no baking and setting of spills or spattering. To clean the interior surfaces, wipe with a soft cloth and warm water. **DO NOT USE ABRASIVE OR HARSH CLEANERS OR SCOURING PADS.** For heavier soil, use baking soda or a mild soap; rinse thoroughly with hot water. The rack can be cleaned with hot soapy water, rinsed and dried.

## Odor Removal

Occasionally, a cooking odor may remain in the oven. To remove, combine 1 cup water, grated peel and juice of 1 lemon and several whole cloves in a 2-cup glass measuring cup. Boil for several minutes using 100% power. Allow to set in oven until cool. Wipe interior with a soft cloth.

## Turntable/Turntable Support

The turntable and turntable support can be removed for easy cleaning. Wash them in mild, sudsy water; for stubborn stains use a mild cleanser and non-abrasive scouring sponge. They are also dishwasher-proof. Use upper rack of dishwasher. The turntable motor shaft is not sealed, so excess water or spills should be wiped up immediately.

## Waveguide Cover

The waveguide cover is located on the right side wall of the oven cavity. It is made from mica so requires

# REPLACING PARTS

## CHARCOAL FILTER

Charcoal Filter, Sharp part number RK-240 which was installed in your oven, is used for nonvented, recirculated installation. The filter should be changed every 6 to 12 months depending on use. See page 14 for ordering information.

1. Disconnect power to the oven at the circuit breaker panel or by unplugging.
2. Remove the three louver mounting screws and push down carefully on the tab at each end of the louver to disengage it. (See illustration.)
3. Pull the louver away from the unit.
4. Change the charcoal filter.
5. Carefully push the louver back into place (engaging both the bottom and top tabs) and replace the screws removed in step 2.

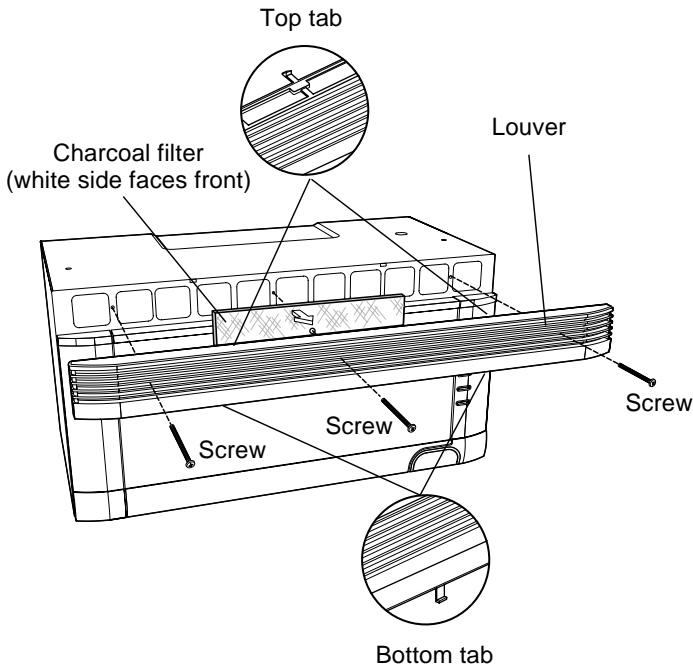

## LIGHT BULBS

1. To replace light bulbs, first disconnect power to the oven at the circuit breaker panel or by unplugging.
2. To release cover, remove the screw on the light cover. (See illustration.)
3. Replace light bulbs with equivalent watt bulb available from your Sharp Authorized Servicer or parts distributor. Bulbs are also available at most hardware stores or lighting centers. **DO NOT USE A BULB LARGER THAN 30 WATTS.**
4. Close light cover and secure with screw removed in step 2.

**CAUTION:** Light cover may become very hot. Do not touch glass when light is on.

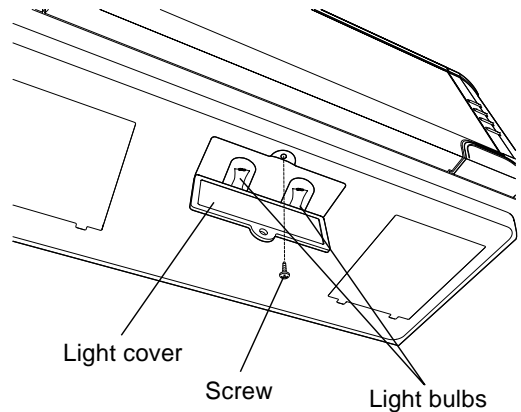

# SERVICE CALL CHECK

Please check the following before calling for service:

Place one cup of water in a glass measuring cup in the oven and close the door securely.  
Operate the oven for one minute at HIGH 100%.

- A Does the oven light come on? YES \_\_\_\_\_ NO \_\_\_\_\_
- B Does the cooling fan work? YES \_\_\_\_\_ NO \_\_\_\_\_  
(Put your hand over the left side of louver.)
- C Does the turntable rotate? YES \_\_\_\_\_ NO \_\_\_\_\_  
(It is normal for the turntable to turn in either direction.)
- D Is the water in the oven warm? YES \_\_\_\_\_ NO \_\_\_\_\_

If "NO" is the answer to any of the above questions, please check electrical outlet, fuse and/or circuit breaker. If they are functioning properly, CONTACT YOUR NEAREST SHARP AUTHORIZED SERVICER. A microwave oven should never be serviced by a "do-it-yourself" repair person.

NOTE: If time appearing in the display is counting down very rapidly, check Demonstration Mode on page 31 and cancel.

## THE ULTIMATE ACCESSORY

- ✦ Great recipes
- ✦ Reliable microwave reference guide
- ✦ Many color photos
- ✦ Step-by-step instructions
- ✦ Nutritional information for each recipe
- ✦ Durable wipe-clean soft cover with 128 8 1/2 x 11 pages
- ✦ Helpful tips and special techniques

### SHARP®

CAROUSEL MICROWAVE  
COOKBOOK

#### TO ORDER

Simply call this toll-free number : **1-800-642-2122**.  
Please have your credit card ready.

If you prefer to order by mail, complete and return the order form below. Please include check or money order (payable to Sharp Accessories & Supplies Center) for \$6.00 plus \$4.25 shipping & handling and tax, if applicable, per book.

#### SATISFACTION GUARANTEED

You must be completely satisfied with the Sharp Carousel Microwave Cookbook. If, within 14 days, you are dissatisfied for any reason, simply return the book and we'll gladly refund your \$6.00 plus tax.

(SOLAMENTE ESCRITO EN INGLES!)

# SPECIFICATIONS

R-1510, R-1511, R-1514

AC Line Voltage:	Single phase 120V, 60Hz, AC only
AC Power Required:	1640 watts, 14.0 amps.
Output Power:	1000 watts* (IEC Test Procedure)
Frequency:	2450 MHz
Outside Dimensions:	29 15/16"(W) x 16 1/4"(H) x 15 9/16"(D)
Cavity Dimensions:	17 1/2"(W) x 9 7/8"(H) x 14 15/16"(D)
Oven Capacity:	1.5 Cu. Ft.
Cooking Uniformity:	Turntable system
Weight:	Approx. 55 lb

★ The International Electrotechnical Commission's standardized method for measuring output wattage. This test method is widely recognized.

In compliance with standards set by:

**FCC** – Federal Communications Commission Authorized.

**DHHS** – Complies with Department of Health and Human Services (DHHS) rule, CFR, Title 21, Chapter I, Subchapter J.



– This symbol on the nameplate means the product is listed by Underwriters Laboratories, Inc.

-----  
Cut along this line.  
-----

## COOKBOOK ORDER FORM

Please send me \_\_\_\_\_ cookbooks at \$10.25 each \$ \_\_\_\_\_

Illinois sales tax, (if applicable) per book \$.44 no. of books \_\_\_\_\_ \$ \_\_\_\_\_

Other tax, (if applicable) no. of books \_\_\_\_\_ \$ \_\_\_\_\_

**TOTAL ORDER AMOUNT \$ \_\_\_\_\_**

I have enclosed a check made payable to Sharp Accessories & Supplies Center.

Please bill my  VISA  MASTERCARD  AMERICAN EXPRESS

Acct. No. \_\_\_\_\_ Expiration date \_\_\_\_ / \_\_\_\_

Signature \_\_\_\_\_

(All credit card orders must be signed.)

Name \_\_\_\_\_

Address \_\_\_\_\_

City \_\_\_\_\_ State \_\_\_\_\_ Zip \_\_\_\_\_

Daytime Phone No. ( ) \_\_\_\_\_

Mail to: SHARP Accessories & Supplies Center  
2130 Townline Road  
Peoria, Illinois 61615-1560

Price is subject to change without notice.









# GUIA AUTO-TOUCH

Para mayor informacion y precauciones de seguridad, consulte el Manual de Operaciones.





## PONER LA HORA

Si en la pantalla se lee *SHARP SIMPLY THE BEST PRESS CLEAR AND PRESS CLOCK* toque primero **STOP/CLEAR**.



- 1 Toque el botón que dice **CLOCK**  .
- 2 Ajuste el reloj en la hora correcta oprimiendo los botones numéricos en el orden respectivo. (Ej: 12:30)    
- 3 Toque nuevamente el botón que dice **CLOCK** .

## OPERACION MANUAL



### Cocimiento con Alta Energia

- 1 Marque el tiempo de cocimiento al oprimir los numeros. (Ej: 1 min. 30 sec.)   
- 2 Pulse la tecla **START/MINUTE PLUS**. 

### Energia de Cocimiento Variable

- 1 Después de realizar el primer paso (Num. 1 arriba), oprima el **POWER LEVEL** ocho veces para 30%.  x 8
- 2 Pulse la tecla **START/MINUTE PLUS**. 







## INSTANT SENSOR

- 1 Pulse el botón **BAKED POTATOES**. 
- 2 Pulse la tecla **START/MINUTE PLUS**. 



## INSTANT SENSOR TABLA

TIPO DE COMIDA	CANTIDAD
REHEAT	4 a 36 onzas
POPCORN	Bolsa de 2,85 a 3,5 onzas Bolsa de 1,5 a 1,75 onzas
BAKED POTATOES	1 a 6 med.
FRESH VEGETABLES	
Suave	0,25 a 2,0 libras
Firme	0,25 a 1,5 libras

## KEEP WARM PLUS

- 1 Pulse la tecla **KEEP WARM PLUS**, esta funcion trabaja hasta por 30 minutos. 
- 2 Capture el tiempo deseado. (Ej: 25:00)    
- 3 Pulse la tecla **START/MINUTE PLUS**. 



## SENSOR COOK CENTER

- 1 Pulse la tecla **SENSOR COOK CENTER** y el numero 1 para albondigas.  
- 2 Pulse la tecla **START/MINUTE PLUS**. 

## SENSOR COOK CENTER TABLA

TIPO DE COMIDA	CANTIDAD
1. GROUND MEAT	0,25 a 2,0 libras
2. RICE	0,5 a 2,0 tazas
3. FISH/SEAFOOD	0,25 a 2,0 libras
4. FROZEN ENTREES	6 a 17 onzas
5. CHICKEN BREAST	0,5 a 2,0 libras
6. FROZEN VEGETABLES	0,25 a 1,25 libras

## REHEAT

- 1 Pulse la tecla **FRESH ROLLS & MUFFINS**. 
- 2 Pulse la tecla **START/MINUTE PLUS**. 

## REHEAT TABLA

TIPO DE COMIDA	CANTIDAD
FRESH ROLLS/MUFFINS	1 a 8
BEVERAGE	0,5 a 2,0 tazas
FROZEN ROLLS/MUFFINS	1 a 8

## MINUTE PLUS

- Oprima **START/MINUTE PLUS** para obtener un minuto al 100% de energia o para agregar otro minuto durante el cocimiento manual. 
- Vuelva a oprimirlo para obtener minutos adicionales.

Carousel® es una marca registrada de Sharp Corporation.

Continuado de la página 38.

## DEFROST CENTER

- 1 Pulse la tecla **DEFROST CENTER** y el numero **2** para Bistec/Costillas. Ingrese el peso correspondiente y a continuacion pulse la tecla.  
 Pulse la tecla **START/MINUTE PLUS**.  
 El horno se detendrá automáticamente y en la pantalla podrá observar diversas indicaciones. Siga los mensajes indicados.
 

**DEFROST CENTER** **2**

**START**  
**MINUTE PLUS**
- 2 Después de concluir la 1ra etapa, abra la puerta y levante el bistec, limpie el agua, coloque nuevamente el bistec. Cierre la puerta. Pulse la tecla **START/MINUTE PLUS**.
 

**START**  
**MINUTE PLUS**
- 3 Después de la 2da etapa, abra la puerta y repita el proceso del paso 2. Cierre la puerta. Pulse la tecla **START/MINUTE PLUS**.
- 4 Después que el ciclo de descongelamiento concluya, deje reposar el alimento.

## DEFROST CENTER TABLA

TIPO DE COMIDA	CANTIDAD
1. GROUND MEAT	0,5 a 2,0 libras
2. STEAKS/CHOPS (PESCADO)	0,5 a 3,0 libras
3. BONELESS POULTRY	0,5 a 2,0 libras
4. BONE-IN POULTRY	0,5 a 3,0 libras

## HOT WATER

- 1 Pulse la tecla **HOT WATER** tres veces para calentar 3 tazas con agua o manténgalo presionado hasta que la cantidad requerida aparezca en pantalla.
 

**HOT WATER** x 3
- 2 Pulse la tecla **START/MINUTE PLUS**.
 

**START**  
**MINUTE PLUS**

Continued from back cover.

## DEFROST CENTER

- 1 Touch **DEFROST CENTER** pad and number **2** for Steaks/Chops. Enter weight 2.0 lb. Touch **START/MINUTE PLUS** pad.  
 The oven will stop and directions will be displayed. Follow the indicated message.
 

**DEFROST CENTER** **2**

**START**  
**MINUTE PLUS**
- 2 After the 1st stage, open the door, turn steak over and shield any warm portions. Close the door. Touch **START/MINUTE PLUS** pad.
 

**START**  
**MINUTE PLUS**
- 3 After the 2nd stage, open the door and shield any warm portions. Close the door. Touch **START/MINUTE PLUS** pad.
 

**START**  
**MINUTE PLUS**
- 4 After defrost cycle ends, cover and let stand.

## DEFROST CENTER CHART



FOOD	AMOUNT
1. GROUND MEAT	.5 - 2.0 lb
2. STEAKS/CHOPS (FISH)	.5 - 3.0 lb
3. BONELESS POULTRY	.5 - 2.0 lb
4. BONE-IN POULTRY	.5 - 3.0 lb

# AUTO-TOUCH GUIDE

For more complete information and safety precautions, refer to your Operation Manual.

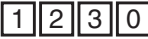

## SET CLOCK

If SHARP SIMPLY THE BEST PRESS CLEAR AND PRESS CLOCK is in the display, first touch **STOP/CLEAR**.

- 1 Touch **TIMER/CLOCK** pad and number **2**. 
- 2 Enter correct time of the day by touching numbers in sequence. (Ex: 12:30) 
- 3 Touch **TIMER/CLOCK** pad again. 

## MANUAL OPERATION



### High Power Cooking

- 1 Enter cooking time by touching number pads. (Ex: 1 min. 30 sec.) 
- 2 Touch **START/MINUTE PLUS** pad. 

### Variable Power Cooking

- 1 After Step 1 above, touch **POWER LEVEL** pad eight times for 30%.  x 8
- 2 Touch **START/MINUTE PLUS** pad. 



## INSTANT SENSOR

- 1 Touch **BAKED POTATOES** pad. 
- 2 Touch **START/MINUTE PLUS** pad. 



## INSTANT SENSOR CHART

FOOD	AMOUNT
REHEAT	4 - 36 oz
POPCORN	2.85 - 3.5 oz bag (reg.) 1.5 - 1.75 oz bag (snack)
BAKED POTATOES	1 - 6 med.
FRESH VEGETABLES	.25 - 2.0 lb (soft) .25 - 1.5 lb (hard)



## HOT WATER

- 1 Touch **HOT WATER** pad three times to heat 3 cups of water or hold down until desired quantity appears.  x 3
- 2 Touch **START/MINUTE PLUS** pad. 

## KEEP WARM PLUS

- 1 Touch **KEEP WARM PLUS** pad to keep food warm for up to 30 minutes. 
- 2 Enter the desired time. (Ex: 25:00) 
- 3 Touch **START/MINUTE PLUS** pad. 



## SENSOR COOK CENTER

- 1 Touch **SENSOR COOK CENTER** pad and number **1** for ground meat. 
- 2 Touch **START/MINUTE PLUS** pad. 

## SENSOR COOK CENTER CHART

FOOD	AMOUNT
1. GROUND MEAT	.25 - 2.0 lb
2. RICE	.5 - 2.0 cups
3. FISH/SEAFOOD	.25 - 2.0 lb
4. FROZEN ENTREES	6 - 17 oz
5. CHICKEN BREAST	.5 - 2.0 lb
6. FROZEN VEGETABLES	.25 - 1.25 lb

## REHEAT

- 1 Touch **FRESH ROLLS & MUFFINS** pad. 
- 2 Touch **START/MINUTE PLUS** pad. 

## REHEAT CHART

FOOD	AMOUNT
FRESH ROLLS/MUFFINS	1 - 8
BEVERAGE	.5 - 2.0 cups
FROZEN ROLLS/MUFFINS	1 - 8

## MINUTE PLUS

- Touch **START/MINUTE PLUS** for one minute at 100% power or to add a minute during manual cooking. Continue to touch for additional minutes. 

Continued on page 39.

Carousel® is a registered trademark of Sharp Corporation.

# SHARP

SHARP ELECTRONICS CORPORATION  
Sharp Plaza, Mahwah, New Jersey 07430-2135

TINSEB316MRK0

Download from [Www.Somanuals.com](http://Www.Somanuals.com). All Manuals Search And Download.





## Free Manuals Download Website

<http://myh66.com>

<http://usermanuals.us>

<http://www.somanuals.com>

<http://www.4manuals.cc>

<http://www.manual-lib.com>

<http://www.404manual.com>

<http://www.luxmanual.com>

<http://aubethermostatmanual.com>

Golf course search by state

<http://golfingnear.com>

Email search by domain

<http://emailbydomain.com>

Auto manuals search

<http://auto.somanuals.com>

TV manuals search

<http://tv.somanuals.com>