

# SHARP

## COMMERCIAL MICROWAVE OVEN



# MODEL R-2398

## OPERATION MANUAL AND COOKING GUIDE

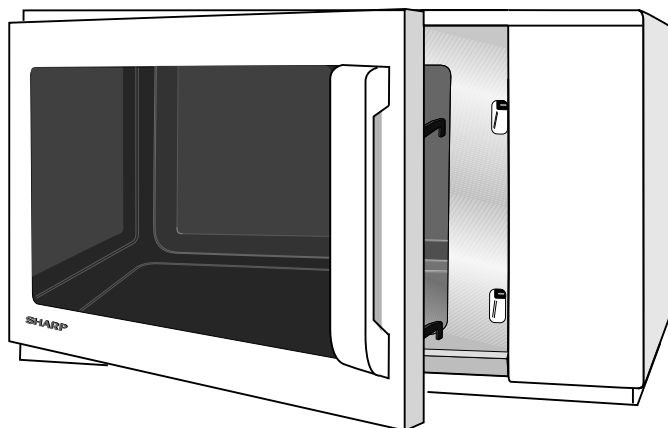

CONTENTS	Page
Warning	1
Special Notes	2
Installation Instructions	3
Oven Diagram	4
Operation of Touch Control Panel	5
Before Operating	5
Volume and Sound Setting	5
Stop/Clear	5
Memory Operation	5
Memory Programme Entry	6
Cooking with Memory	8
Cooking Double Quantity with Memory	8
Memory Check	9
Manual Operation	10
Time Cooking	10
Repeat Cooking	10
Multiple Sequence Cooking	11
Other Convenient Features	12
Express Defrost	12
Express Defrost Chart	12
Counter Check	13
Error Mode	14
Information for Filter Indicator	14
Care and Cleaning	14
Service Call Check	15
Specifications	15
Helpful Hints	16
Cookware and Utensil Guide	17
Warranty	18
Quick Reference Guide	19

# WARNING

Read all instructions before using the appliance.

To reduce the risk of fire in the oven cavity:

- a. Do not overcook food.
- b. Remove wire twist-ties from paper or plastic bags before placing bag in the oven.
- c. Do not heat oil or fat for deep frying. The temperature of the oil cannot be controlled.
- d. Look at the oven from time to time when food is heated in disposable containers made of plastic, paper or other combustible materials for signs of smoke or burning.
- e. If materials inside the oven should ignite, or smoke is observed, keep oven door closed, turn oven off, and disconnect the power cord, or shut off power at the fuse or circuit breaker panel.

To reduce the risk of explosion and sudden boiling:

- a. Do not place sealed containers in the oven. Babies bottles fitted with a screw cap or teat are considered to be sealed containers.
- b. When boiling liquids in the oven, use a wide-mouthed container and stand about 20 seconds at the end of cooking to avoid delayed eruptive boiling of liquids.

This oven is for food preparation only and should only be used for heating, cooking and defrosting food and beverage.

It is not suitable for industrial, laboratory use, or heating therapeutic devices eg. Wheat bags.

Never operate the oven whilst any object is caught or jammed between the door and the oven.

Do not try to adjust or repair the oven yourself because of hazard. The oven must be adjusted or repaired by a qualified service technician trained by SHARP.

Do not operate the oven if it is not working correctly or damaged until it has been repaired by a qualified service technician trained by SHARP. It is particularly important that the oven door closes properly and that there is no damage to:

(1) Door (warped), (2) Hinges and Latches (broken or loosened), (3) Door Seals, Sealing Surfaces and oven cavity (buckled or deformed), (4) Burn marks on the door seal faces.

Do not bump, or catch utensils, loose clothes and your accessories on the door safety latches when removing food from the oven.

Never poke an object, particularly a metal object, through a grille or between the door and the oven while the oven operating.

Never tamper with or deactivate the door safety latches.

Always use oven gloves to prevent burns when handling utensils that are in contact with hot food. Enough heat from the food can transfer through utensils to cause skin burns.

Should the supply cord become damaged, it must be replaced with a special cord supplied by a SERVICE CENTRE APPROVED BY SHARP. And it must be replaced by a qualified service technician trained by SHARP.

Avoid steam burns by directing steam away from the face and hands.

Slowly lift the furthest edge of a dish's cover and microwave plastic wrap and carefully open popcorn and oven cooking bags away from the face.

Make sure that the power supply cord is undamaged, and that it does not run under the oven or over any hot surfaces or sharp edges.

Do not use the oven near the steamer and fryer.

Do not place anything on the outer cabinet.

This appliance must be earthed.

Do not store food or any other items inside the oven.

Make sure the utensil does not touch the interior walls during cooking.

Only allow children to use the oven without supervision when adequate instructions have been given so that the child is able to use the oven in a safe way and understands the hazards of improper use.

This appliance is not intended for use by young children or infirm persons without supervision.

Young children should be supervised to ensure that they do not play with the appliance.

Individuals with PACEMAKERS should check with their doctor or the manufacturer of the pacemaker for precautions regarding microwave ovens.

# SPECIAL NOTES

	DO	DON'T
Eggs, fruits, nuts, seeds vegetables, sausages and oysters	<ul style="list-style-type: none"> <li>* Puncture egg yolks and whites and oysters before cooking to prevent "explosion".</li> <li>* Pierce skins of potatoes, apples, squash, hot dogs, sausages and oysters so that steam escapes.</li> </ul>	<ul style="list-style-type: none"> <li>* Cook eggs in shells. This prevents "explosion", which may damage the oven or injure yourself.</li> <li>* Reheat whole eggs.</li> <li>* Overcook oysters.</li> <li>* Dry nuts or seeds in shells.</li> </ul>
Popcorn	<ul style="list-style-type: none"> <li>* Use specially bagged popcorn for the microwave oven.</li> <li>* Listen while popping corn for the popping to slow to 1-2 seconds.</li> </ul>	<ul style="list-style-type: none"> <li>* Pop popcorn in regular brown bags or glass bowls.</li> <li>* Exceed maximum time on popcorn package.</li> </ul>
Baby food	<ul style="list-style-type: none"> <li>* Transfer baby food to small dish and heat carefully, stirring often. Check for suitable temperature to prevent burns.</li> <li>* Remove the screw cap and test before warming baby bottles. After warming shake thoroughly. Check for suitable temperature.</li> </ul>	<ul style="list-style-type: none"> <li>* Heat disposable bottles.</li> <li>* Overheat baby bottles. Only heat until warm.</li> <li>* Heat bottles with nipples on.</li> <li>* Heat baby food in original jars.</li> </ul>
General	<ul style="list-style-type: none"> <li>* Food with filling should be cut after heating, to release steam and avoid burns.</li> <li>* Stir liquids briskly before and after cooking for even heating.</li> <li>* Use a deep bowl when cooking liquids or cereals to prevent boiling over.</li> <li>* For boiling or cooking liquids see WARNING on page 2.</li> </ul>	<ul style="list-style-type: none"> <li>* Heat or cook in closed glass jars or air tight containers.</li> <li>* Deep fat fry.</li> <li>* Heat or dry wood, herbs, wet papers, clothes or flowers.</li> <li>* Operate the oven without a load (i.e. an absorbing material such as food or water) in the oven cavity.</li> </ul>
Canned foods	<ul style="list-style-type: none"> <li>* Remove food from can.</li> </ul>	<ul style="list-style-type: none"> <li>* Heat or cook food while in cans.</li> </ul>
Sausage rolls, Pies, Christmas pudding	<ul style="list-style-type: none"> <li>* These foods have high sugar and/or fat contents.</li> <li>* Cook for the recommended time.</li> </ul>	<ul style="list-style-type: none"> <li>* Overcook as they may catch fire.</li> </ul>
Meats	<ul style="list-style-type: none"> <li>* Use a microwave proof roasting rack to collect drained juices.</li> </ul>	<ul style="list-style-type: none"> <li>* Place meat directly on the ceramic shelf for cooking.</li> </ul>
Utensils	<ul style="list-style-type: none"> <li>* Check the utensils are suitable for MICROWAVE cooking before you use them.</li> </ul>	<ul style="list-style-type: none"> <li>* Use metal utensils for MICROWAVE cooking. Metal reflects microwave energy and may cause an electrical discharge known as arcing.</li> </ul>
Aluminium foil	<ul style="list-style-type: none"> <li>* Use to shield food to prevent over cooking.</li> <li>* Watch for sparking. Reduce foil or keep clear of cavity walls.</li> </ul>	<ul style="list-style-type: none"> <li>* Use too much.</li> <li>* Shield food close to cavity walls. Sparking can damage the cavity.</li> </ul>
Browning dish	<ul style="list-style-type: none"> <li>* Place a suitable insulator such as microwave and heat proof dinner plate between the ceramic shelf and the browning dish.</li> </ul>	<ul style="list-style-type: none"> <li>* Exceed the preheating time recommended by the manufacturer. Excessive preheating can damage internal parts of the oven.</li> </ul>

# INSTALLATION INSTRUCTIONS

1. Remove all packing materials from the oven cavity. Remove the protective film (blue film) from the outer case cabinet. Check the unit for any damage, such as a misaligned door, damaged door seals around the door or dents inside the oven cavity or on the door. If there is any damage, please do not operate the oven until it has been checked by a SERVICE CENTRE APPROVED BY SHARP and repaired, if necessary.

2. Accessories provided

1) Operation manual and cooking guide

2) Menu sticker

Enter cooking times or dish menus in this sticker and attach to the control panel.

3. The oven should not be installed in any area where excessive heat and steam are generated, for example, next to a conventional oven unit. The oven should be installed so as not to block ventilation openings. Allow at least 25 cm on the top, 5 cm on the both sides and at the rear of the oven for free air space.

4. Neither the manufacturer nor the distributors can accept any liability for damage to the machine or personal injury for failure to observe the correct electrical connecting procedure. The A.C. voltage must be single phase 230-240V, 50Hz.

5. It is recommended that a separate circuit serving only this appliance be provided.

6. Operate the oven from a general purpose outlet.

If a generator is used, do not operate the oven with non-sinusoidal outputs.

7. STACKING PROCEDURE FOR TWO MICROWAVE OVENS

Two units can be installed together by placing one on top of the other. Follow these instructions:

- Place oven A in the desired location. Position Oven B on top of Oven A as shown in the figure.
- Remove Screws (b) from the lower edge of the back of Oven B.
- Loosen Screw (a) which holds Mounting Plate A on the back of Oven A.
- Turn Mounting Plate A 180° so that it is on the lower edge of Oven B.
- Using Screw (b) removed in step b, install Mounting Plate A to the lower edge of Oven B as shown in the figure.
- Tighten Screw (a) which was loosened in step c.
- Remove another Screw (a) which holds Mounting Plate B on the back of Oven B. Remove Mounting Plate B.
- Replace Screw (a) removed in step g and tighten.
- Remove Screw (c) from the rear of Oven A.
- Remove Screw (d) from the rear of Oven B.
- Turn Mounting Plate B and position it on Ovens A and B as shown in the figure. Using Screws (c) and (d), fasten Mounting Plate B in place.

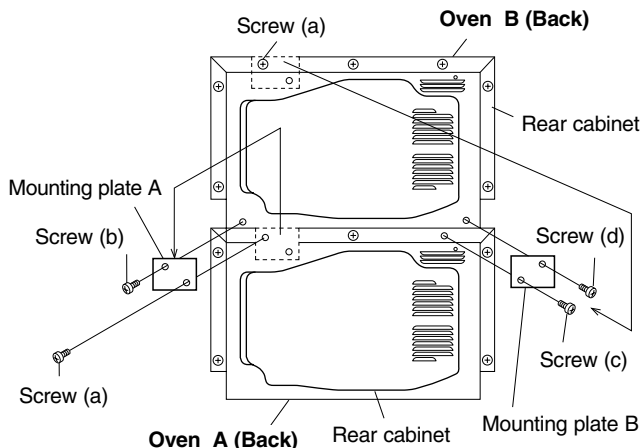

Figure

## WARNING:

When two ovens are installed together by placing one on top of another:

- Always use two mounting plates.
- Make sure that the power supply cords are not caught between the ovens.
- Do not install more than one oven on top of another.

# OVEN DIAGRAM

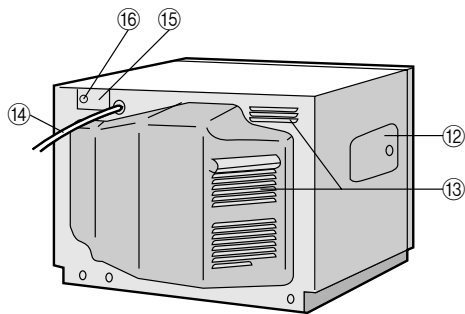
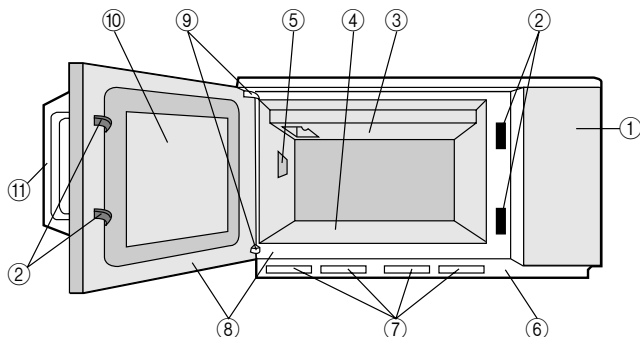

- 1. Touch control panel
- 2. Door safety latches
- 3. Splash cover
- 4. Ceramic shelf
- 5. Oven lamp
- 6. Air intake filter
- 7. Air intake openings
- 8. Door seals and sealing surfaces

- 9. Door hinges
- 10. See through door
- 11. Door handle
- 12. Access cover for oven lamp replacement
- 13. Ventilation openings
- 14. Power supply cord
- 15. Mounting plate
- 16. Screw for mounting plate

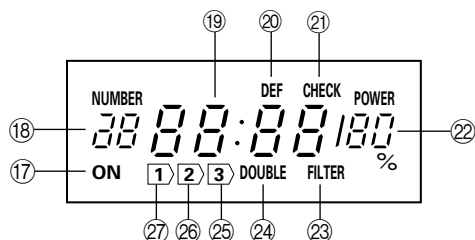

- 17. Heating indicator:  
This indicator shows heating in progress
- 18. Memory number indicator
- 19. TIME display: Lighted digital display
- 20. EXPRESS DEFROST indicator
- 21. Check mode indicator
- 22. POWER LEVEL display:  
Percentage of microwave power is indicated
- 23. Filter indicator
- 24. Double quantity mode indicator
- 25. 3rd sequence indicator
- 26. 2nd sequence indicator
- 27. 1st sequence indicator
- 28. DOUBLE QUANTITY pad
- 29. EXPRESS DEFROST pad
- 30. Ten NUMBER pads for time and memory programming
- 31. SELECT TIME pad
- 32. STOP/CLEAR pad; press to stop operation of oven and clear remaining heating time
- 33. SELECT POWER pad for setting variable power level
- 34. START pad; press to operate oven after door is closed and time is set
- 35. SET pad for setting memory
- 36. CHECK pad for checking memory
- 37. SIGNAL pad for setting sound level

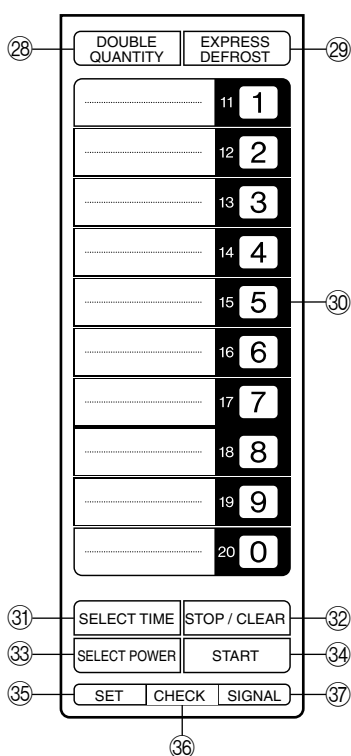

# OPERATION OF TOUCH CONTROL PANEL

The operation of the oven is controlled by pressing the appropriate pads arranged on the surface of the control panel.

An entry signal tone should be heard each time you press the control panel to make a correct entry.

## Before Operating

- When you first connect the microwave oven to an electrical socket, the digital display will show .
- Key pad entries can only be made when the door is shut.
- The oven lamp and cooling fan will continue to operate for 1 minute after cooking or when the door is opened or shut.
- The programme or check mode is cancelled when any pads are not pressed for more than 3 minutes.
- End will appear on the display after the time reaches zero. It will disappear when the oven door is opened or the STOP/CLEAR pad is pressed.

## Volume and Sound Setting

- There are three selectable volume settings for the "beeps" made by the control panel, also you can change the setup to make a series of short "beeps" to signify the end of cooking, quite distinct from normal key entry beeps.  
To change the volume setting, press the SET pad twice within 2 seconds. Then hold your finger on the SIGNAL pad, you will hear the three volume settings, stop on the one you want.  
If you hold your finger on the SIGNAL pad, the sound will change from a steady "beep" to a series of short "beeps", again three volume settings will be heard, stopping on one of these volume settings will change the setup so that the short "beeps" will be heard at the end of cooking. To turn off the short "beeping" feature, repeat the process but stop on one of the first three steady volume settings.
- Any audible signals will not sound when the SET pad is pressed first and then an audible signal will sound when the SET pad is pressed second.

## Stop/Clear

- If you want to stop the oven during cooking:
  1. Press the STOP/CLEAR pad once.
  2. Open the door (except memory cooking).  
To start the oven again, close the door and press the START pad within 1 minute.
- If you open the door during memory cooking, the programme is cancelled.
- If you want to cancel a programme during cooking, press the STOP/CLEAR pad twice.
- If you want to clear a mistake during programming, press the STOP/CLEAR pad once.

## MEMORY OPERATION

- This oven has 20 memory banks (1-20) which can store cooking programmes.
- The memory banks 1-0 have been programmed previously as shown in the table. These pre-programmed memory banks can be changed individually if required.
- In addition for all memory banks a time constant 1.8 for the double quantity is stored. The stored time constant can also be changed individually if required.
- Information in these memory banks is not lost due to power interruptions. If the power goes off, the oven does not need to be reprogrammed. No batteries are necessary for this type of memory.
- If you want to memorise or check the programme or cook using memory 11-20, press the desired NUMBER pad twice within 1 second.

Memory No.	Cook Time	Output Power
1	10 sec.	100%
2	20 sec.	100%
3	30 sec.	100%
4	45 sec.	100%
5	1 min.	100%
6	1 min. 15 sec.	100%
7	1 min. 30 sec.	100%
8	2 min.	100%
9	2 min. 30 sec.	100%
0	3 min.	100%

To check the stored programmes please refer to "Memory check" on page 9.

To change the stored programmes please refer to "Memory programme entry" on pages 6-7.

## Memory Programme Entry

You can change memory programmes for 20 memory banks.  
Your oven can be programmed for up to 3 cooking sequences and has 11 preset microwave power levels.

### COOKING TIME

Cooking Sequence	Microwave power level that can be used.	Cooking time that can be used.
1 Stage only	0-100%	Max. 30 minutes
2 or 3 Stages	0-40% all stages	Max. 30 minutes any stage Max. 60 minutes for two stages Max. 90 minutes for three stages
	50-100%	Max. 30 minutes all stages

Note: If the oven is used with the power level above 40% on any stage, the maximum cooking time is 30 minutes in total.





### COOKING GUIDE AND POWER LEVEL

Use the correct NUMBER pad after pressing the SELECT POWER pad.  
The following chart gives examples of foods typically cooked on microwave power levels.

Number Pads	Microwave Power Levels	Examples of Foods
NONE	100%	Beverage, Fruit, Vegetables, Rice/Pasta
9	90%	
8	80%	
7	70%	Seafood, Cakes, Muffins, Slices, Casseroles, Lasagne
6	60%	
5	50%	
4	40%	
3	30%	Defrosting, Softening butter
2	20%	
1	10%	Keeping food warm
0	0%	No microwave power

## TO PROGRAMME TIME AND POWER LEVEL INTO A MEMORY

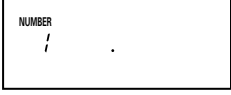
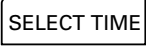
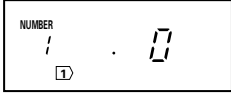
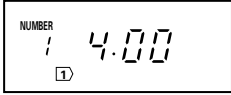
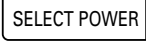
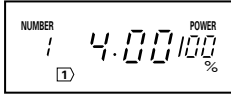
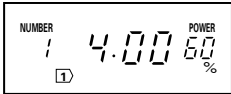
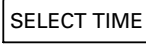
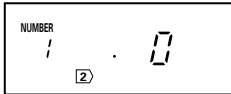
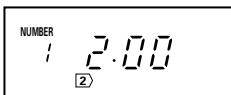
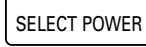
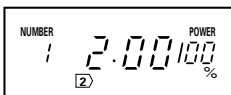
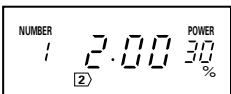
\* Suppose you want to set 4 minutes at 60% at the 1st sequence and 2 minutes at 30% at the 2nd sequence for 1 serving in the memory 1.

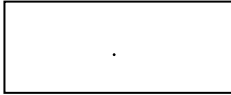
Step	Procedure	Pad Order	Display
1	Press the SET pad twice within 2 seconds.	 X 2	
2	Press the NUMBER pad <b>1</b> .	<b>1</b>	
3	Press the SELECT TIME pad.		
4	Enter desired cooking time for the 1st sequence. (4 minutes)	<b>4</b> <b>0</b> <b>0</b>	
5	Press the SELECT POWER pad.		
6	Enter desired power level for the 1st sequence. (60%)	<b>6</b>	
7	Press the SELECT TIME pad.		
8	Enter desired cooking time for the 2nd sequence. (2 minutes)	<b>2</b> <b>0</b> <b>0</b>	
9	Press the SELECT POWER pad.		
10	Enter desired power level for the 2nd sequence. (30%)	<b>3</b>	
11	Press the SET pad twice to complete the setting.	 X 2	

Note: 1. If the cooking time is over the max. time, the display will show "EE9". See page 14.

2. If your programmed time is over max. time at Double Quantity, you cannot use Double Quantity for the memory. You can cook only 1 serving.

3. It is not necessary to press the SELECT POWER pad for 100%.

4. At step 1, any audible signals will not sound when the SET pad is pressed first and then an audible signal will sound when the SET pad is pressed second.



## Cooking with Memory

\* Suppose you want to cook by using memory 2, which was programmed for 10 seconds at 100%.

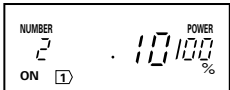
Step	Procedure	Pad Order	Display
1	Press the NUMBER pad <b>(2)</b> .	<b>(2)</b>	

## Cooking Double Quantity with Memory

\* Suppose you want to cook a double quantity using memory 2.

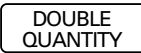
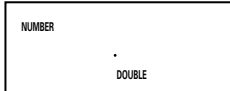
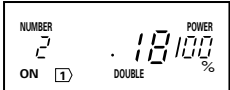





Step	Procedure	Pad Order	Display
1	Press the DOUBLE QUANTITY pad.		
2	Press the NUMBER pad <b>(2)</b> .	<b>(2)</b>	

- Note:
1. If the cooking time of double quantity is over the max. time, the display will show "EE9". See page 14.
  2. Double quantity means best time for cooking double quantity; it is not double the time.
  3. The "MEMORY" cooking system does not require the use of the START pad. MEMORY cannot be used to start the oven if any programme is on display.

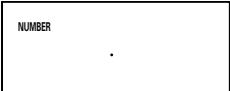
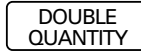
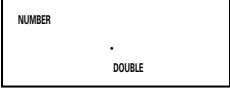
## TO CHANGE THE TIME CONSTANT FOR DOUBLE QUANTITY

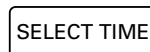
The time constant for double quantity is preset 1.8 times the single quantity cooking time, but you can alter this constant to suit your needs.

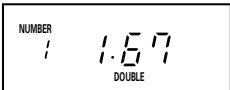
\* Suppose you want to change the time constant to 1.67 in memory 1.

Step	Procedure	Pad Order	Display
1	Press the SET pad twice within 2 seconds.	 X 2	
2	Press the DOUBLE QUANTITY pad.		
3	Press the NUMBER pad <b>(1)</b> .	<b>(1)</b>	
4	Press the SELECT TIME pad.		
5	Set the time constant (1.67).	<b>(1)</b> <b>(6)</b> <b>(7)</b>	
6	Press the SET pad twice to complete the setting.	 X 2	

- Note:
1. In case you want to change the time constant it must be set for each key separately.
  2. The time constant can be set from 0.00 to 9.99.
  3. At step 1, any audible signals will not sound when the SET pad is pressed first and then an audible signal will sound when the SET pad is pressed second.

# Memory Check

You can check the information programmed into the memory.

## CHECKING TIME AND POWER LEVEL

\* Suppose you want to know the information programmed into the memory 1, programmed for 4 minutes at 60% at the 1st sequence and 2 minutes at 30% at the 2nd sequence.

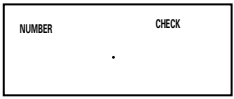
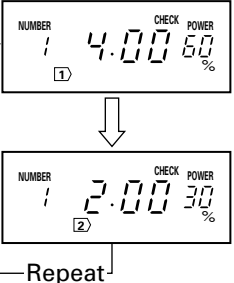
Step	Procedure	Pad Order	Display
1	Press the CHECK pad.	<input type="button" value="CHECK"/>	
2	Press the NUMBER pad <b>1</b> .	<b>1</b>	









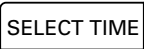
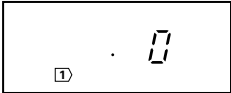

- Note:
1. To cancel MEMORY CHECK, press the CHECK pad.
  2. When  is displayed at Step 1, the memory is not set.
  3. To check the time constant for double quantity, press the DOUBLE QUANTITY pad and the desired NUMBER pad in step 2.

# MANUAL OPERATION

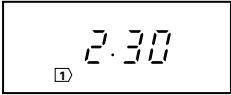
Your oven can be programmed for up to 3 cooking sequences and has 11 preset microwave power levels. See page 6.

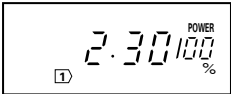
## Time Cooking

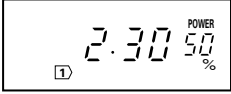

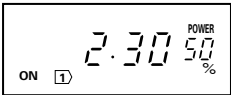
\* Suppose you want to cook for 2 minutes and 30 seconds at 50%.

Step	Procedure	Pad Order	Display
1	Press the SELECT TIME pad.		The oven will display.  After using the oven the display will show the last programme.
2	Enter desired cooking time. (2 minutes 30 seconds)	  	
3	Press the SELECT POWER pad.		
4	Enter desired power level. (50%)		
5	Press the START pad.		

## Repeat Cooking

Your oven can remember the last manual programme.

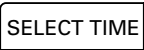
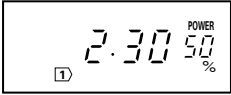

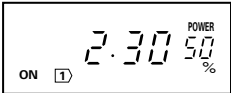







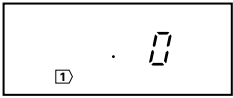

\* Suppose you want to cook with the last programme, which was programmed for 2 minutes and 30 seconds at 50%.

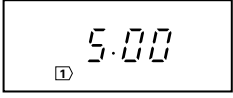
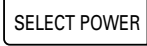
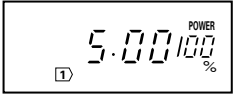
Step	Procedure	Pad Order	Display
1	Press the SELECT TIME pad.		
2	Press the START pad.		

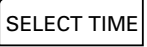
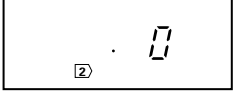
- Note:
1. It is not necessary to press the SELECT POWER pad for 100%.
  2. If the cooking time is over the max. time, the display will show "EE9". See page 14.
  3. During cooking mode, the oven stops when the door is opened, and the programme is cancelled if the START pad is not pressed within 1 minute after the door is closed.

# Multiple Sequence Cooking

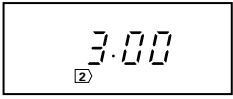
\* Suppose you want to cook for 5 minutes at 70% followed by 3 minutes at 100%

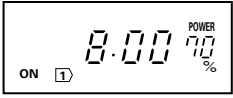
Step	Procedure	Pad Order	Display
1	Press the SELECT TIME pad.		The oven will display.  After using the oven the display will show the last programme.
2	Enter desired cooking time for the 1st sequence.(5 minutes)	  	
3	Press the SELECT POWER pad.		
4	Enter desired power level for the 1st sequence.(70%)		
5	Press the SELECT TIME pad.		
6	Enter desired cooking time for the 2nd sequence.(3 minutes)	  	
7	Press the START pad.		







Note: If you want to programme 3 cooking sequences, repeat step 1-4 after step 6.

# OTHER CONVENIENT FEATURES

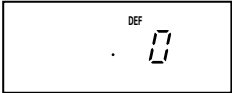
## Express Defrost

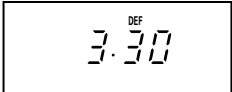
Use Express Defrost to defrost meat and poultry faster and better. Enter desired defrost time, referring to defrost chart.

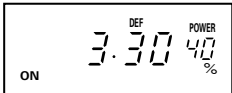
\* Suppose you want to defrost for 3 minutes and 30 seconds.

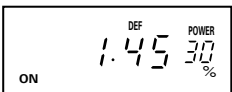
Step	Procedure	Pad Order	Display
1	Press the EXPRESS DEFROST pad.		
2	Enter desired defrost time.		
3	Press the START pad.		
4	Halfway through defrost time CHECK will flash and the oven will "beep". Open the door. Turn food over and shield any warm portions. Close the door.		
5	Press the START pad.		

## Express Defrost Chart

The following chart gives approx times per 500g for defrosting meat.

Food	Time(min./500g)	Procedure
Steak/Chops	4-5 min./500g	<ul style="list-style-type: none"> <li>* Shield thin end of chops or steaks with foil.</li> <li>* Position the food with thinner parts in the centre in a single layer. If pieces are stuck together, try to separate as soon as possible.</li> <li>* Turn food over and rearrange after the oven beeps.</li> </ul>
See Note below		* After defrost time, stand covered with foil for 10-15 minutes.
Poultry	5-7 min./500g	<ul style="list-style-type: none"> <li>* Remove from original wrapper. Shield wing and leg tips with foil.</li> <li>* Place breast side down. Turn food over after the oven beeps.</li> <li>* After defrost time, stand covered with foil for 15-50 minutes.</li> </ul>
		N.B. After standing rinse under cold water to remove giblets if necessary.
Minced Beef	5-7 min./500g	<ul style="list-style-type: none"> <li>* Place frozen minced beef on a defrost rack. Remove defrosted portion of mince, turn food over and shield edges with foil strips after the oven beeps.</li> </ul>
See Note below		* After defrost time, stand covered with foil for 10-15 minutes.
Chicken Pieces	4-5 min./500g	<ul style="list-style-type: none"> <li>* Shield the exposed bone with foil.</li> <li>* Turn food over, rearrange and shield the warm portions after the oven beeps.</li> </ul>
See Note below		* After defrost time, stand covered with foil for 10-15 minutes.
Roast Beef Pork Lamb	6-8 min./500g	<ul style="list-style-type: none"> <li>* Shield the edge with foil strips about 2.5 cm wide.</li> <li>* Place joint with lean side face upwards (if possible).</li> <li>* Turn food over and shield the warm portions after the oven beeps.</li> </ul>
		* After defrost time, stand covered with foil for 10-50 minutes.

Check food after standing. If additional time is needed, continue to defrost with 20% power and additional time. Food not listed in the Chart can be defrosted using 20% setting.

Note: When freezing minced beef, shape it into flat even sizes. For chicken pieces, steaks and chops, freeze separately in single flat layers and if necessary interleave with freezer plastic to separate layers. This will ensure even defrosting. It is also a good idea to label the packs with the correct weights.

## Counter Check

Set the counters to "0" before using your new oven (see COUNTER CLEAR below) to keep a record of the oven use.

### COUNTER CHECK

\* Suppose you want to know the total times the oven was used, and the number of times each programme was used. In the following example, the total time was 8268 and memory 1 was 513.

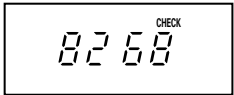
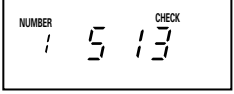
Step	Procedure	Pad Order	Display
1	Press the CHECK pad twice.	<input type="button" value="CHECK"/> X 2	 (Total times used)
2	To check memory 1 usage, press the NUMBER pad <input type="button" value="1"/> .	<input type="button" value="1"/>	 (Times memory 1 was used)

- Note:
- To cancel Counter Check mode, press the CHECK pad.  
Each counter can count the times up to 9999, and it will return to 0 if it is over 9999.
  - To check the times of manual cooking, press the SELECT TIME pad at Step 2 instead of the NUMBER pad.  
To check the times of EXPRESS DEFROST cooking, press the EXPRESS DEFROST pad at Step 2 instead of the NUMBER pad.

### COUNTER CLEAR

Each number of times can be cleared.

\* Suppose you want to clear the times of memory 1.

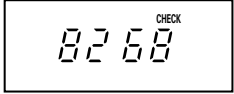
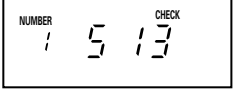
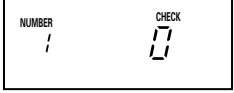
Step	Procedure	Pad Order	Display
1	Press the CHECK pad twice.	<input type="button" value="CHECK"/> X 2	 (Total times used)
2	Press the NUMBER pad <input type="button" value="1"/> .	<input type="button" value="1"/>	 (Times memory 1 was used)
3	Press the SET pad.	<input type="button" value="SET"/>	

- Note:
- To cancel Counter clear mode, press the CHECK pad.
  - To clear the times of manual cooking, press the SELECT TIME pad at Step 2 instead of the NUMBER pad.  
To clear the times of EXPRESS DEFROST cooking, press the EXPRESS DEFROST pad at Step 2 instead of the NUMBER pad.
  - To clear total using times, skip Step 2.

## Error Mode

If ERROR messages are displayed, follow the below instructions.

ERROR MESSAGES	
EE1 EE2 EE3 EE6 EE8 EE0 EE10 EE16	Please contact your dealer or an authorized service agent because the oven is malfunctioning.
EE7	Exhaust air temperature is too high. Check that nothing is blocking the ventilation openings and air intake openings or that room temperature is too hot or that oven cavity is empty during operation. Correct, press the STOP/CLEAR pad and try again after a few minutes.
EE9	Cooking time exceeds the max. time. Press the STOP/CLEAR pad and programme again.
EE17	Magnetron temperature is too high. Press the STOP/CLEAR pad and try again after a few minutes.

## Information for Filter Indicator

1. Clean the air intake filter when the FILTER indicator lights up. See CARE AND CLEANING below. The FILTER indicator will light up when the oven has been operated for about 200 hours in total.
2. To cancel FILTER indicator press the START pad. The oven will start to count the operation time automatically again when the FILTER indicator is cancelled.

## CARE AND CLEANING

### CLEAN THE OVEN AT REGULAR INTERVALS

#### IMPORTANT

- DO NOT OPERATE the oven without the splash cover in place.
- DO NOT REMOVE the splash cover UNLESS THE POWER CORD IS REMOVED FROM THE OUTLET because the rotary antenna, which is located on the ceiling, operates for 1 minute after the door is opened and injury could occur.
- Do not use commercial oven cleaners, abrasive or harsh cleaners or scouring pads on any part of your microwave oven.
- Do not sprinkle water onto the oven directly. It may cause electric shock, leakage of electricity or damage of the oven.

#### Exterior:

The outside may be cleaned with mild soap and warm water, wipe clean with a damp cloth. Avoid the use of harsh abrasive cleaners.

**NOTE:** Please ensure the oven is not splashed with excessive water at all times as it could lead to an electrical failure.

#### Door:

Wipe the door and window on both sides, the door seals and adjacent parts frequently with a damp cloth to remove any spills or spatters. Do not use abrasive cleaner.

#### Touch Control Panel

Care should be taken in cleaning the touch control panel. Open the oven door before cleaning to inactivate the control panel. Wipe the panel with a cloth dampened slightly with water only.

Do not scrub or use any sort of chemical cleaners. Avoid the use of excess water.

#### Interior walls:

To clean the interior surfaces, wipe with a soft cloth and warm water at the end of each day for hygienic reasons. DO NOT USE A COMMERCIAL OVEN CLEANER, ABRASIVE OR HARSH CLEANERS AND SCOURING PADS ON ANY PART OF YOUR MICROWAVE OVEN. NEVER SPRAY OVEN CLEANERS DIRECTLY ONTO ANY PART OF YOUR OVEN.

Avoid using excess water. After cleaning the oven, ensure any water is removed with a soft cloth.

For heavier soil, use mild soap; rinse thoroughly with hot water. Make sure that mild soap or water does not penetrate through the small vents in the walls which may cause damage to the oven.

#### Ceramic shelf:

The ceramic shelf should be kept clean at all times. Minor spills may be wiped with a damp cloth. DO NOT REMOVE THE CERAMIC SHELF FROM OVEN.

## Splash cover:

**AT LEAST ONCE A WEEK, REMOVE THE SPLASH COVER AND WASH BOTH SIDES OF IT IN A MILD DETERGENT SOLUTION. A BUILD UP OF GREASE MAY OVERHEAT AND BEGIN TO SMOKE AND MAY BURN THE SPLASH COVER. THE SPLASH COVER IS LOCATED IN THE TOP OF THE OVEN AND MAY EASILY BE REMOVED. REMEMBER TO UNPLUG THE POWER CORD.**

### Removal:

1. Remove two thumb screws (A) as shown in Fig. 1.
2. Remove the splash cover from the oven.

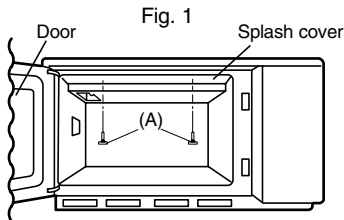

### Reinstall:

1. Insert two projections of the cover (B) into the holes of the oven cavity backplate as shown in Fig. 2.
2. Secure the cover to the oven ceiling with two thumb screws (A) as shown in Fig. 1.

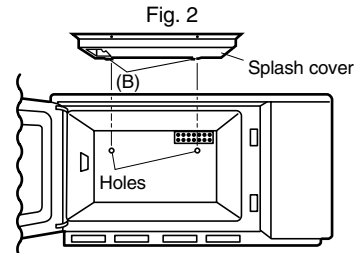

### Air intake filter:

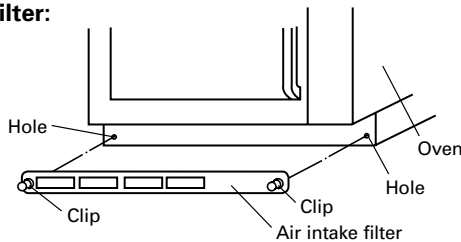

Keep the air intake filter clean. Clean the air intake filter once every two weeks.

Remove the air intake filter by pulling the two (2) clips on the sides of the filter.

Wash the air intake filter in mild soapy water, rinse and dry with a soft cloth.

After cleaning re-install the air intake filter.

**DO NOT OPERATE THE OVEN WITHOUT THE AIR INTAKE FILTER IN PLACE.**

## SERVICE CALL CHECK

Please check the following before calling for service:

1. When the door is opened, does the oven lamp and cooling fan come on for one minute? YES \_\_\_\_\_ NO \_\_\_\_\_
2. Place one cup of water (approx. 250 ml) in a glass measure in the oven and close the door securely. Programme the oven for 1 minute at 100%.

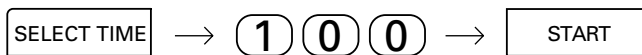

A. Does the oven lamp light?

YES \_\_\_\_\_ NO \_\_\_\_\_

B. Does the cooling fan work?

YES \_\_\_\_\_ NO \_\_\_\_\_

(Put your hand over the rear ventilation openings.)

C. After one minute, did an audible signal sound and heating indicator "ON" go off?

YES \_\_\_\_\_ NO \_\_\_\_\_

D. Is the water inside the oven hot?

YES \_\_\_\_\_ NO \_\_\_\_\_

If "NO" is the answer to any of the above questions, please check your wall socket and the fuse in your meter box. If both the wall socket and the fuse are functioning properly, CONTACT YOUR NEAREST SERVICE CENTRE APPROVED BY SHARP.

## SPECIFICATIONS



AC Line Voltage:

Single phase 230-240 V, 50 Hz

AC Power Required:

2.35 kW

Output Power:

1500 W \*(IEC test procedure)

Microwave Frequency:

2450 MHz \*\*(Class B/Group2)

Outside Dimensions:

510mm(W) x 335mm(H) x 470mm(D)(Single)

510mm(W) x 670mm(H) x 470mm(D)(Two oven stacked)

330mm(W) x 180mm(H) x 330 mm(D)

Cavity Dimensions:

Oven Capacity:

20 litre (0.7 cu.ft)

Cooking Uniformity:

Stirrer fan system

Weight:

Approx. 35 kg

\* When tested in accordance with AS/NZS 2895.1.1995

\*\* This is the classification of ISM(Industrial, Scientific and Medical) equipment described in the International Standard CISPR 11.



# HELPFUL HINTS

## 1. THE ARRANGEMENT

Arrange foods carefully. Place thickest areas toward outside of dish.



## 3. COVERING

Cover foods in the microwave if you would normally cover the food in your ordinary oven, or to retain moisture. Cover foods such as Vegetables, Casseroles, or when Reheating.

Use to cover foods:



LID



PLASTIC WRAP

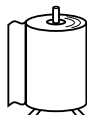

PAPER TOWEL

## 5. SHIELDING

Shield using small pieces of aluminium foil to shield thin areas of meat, fish and poultry or edges of cakes to prevent overcooking.



FISH



CHICKEN

## 7. STIRRING

Stir foods from the outside to the centre of the dish, once or twice during cooking if possible. Eg. Casseroles and Sauces.



## 9. DENSITY

The depth to which microwaves penetrate food varies depending on the food's density. Porous foods like minced beef or mashed potatoes microwave faster than dense ones like steak or whole potatoes

## 11. STARTING TEMPERATURE

Frozen or refrigerated foods take longer to heat than food at room temperature. Cooking times in this book are based on normal storage temperatures. Since rooms, refrigerators and freezers differ in temperature, check cooking result at the minimum time.



## 13. CONDENSATION

Condensation is a normal part of microwave cooking. The humidity and moisture in food will influence the amount of condensation in the oven. Generally, covered foods will not cause as much condensation as uncovered foods. Ensure that the ventilation openings are not blocked.

## 2. TURNING

Foods such as poultry and joints of meat should be turned over after half the cooking time.

## 4. PIERCING

Pierce potatoes, eggs, tomatoes or any foods with a skin or membrane to allow steam to escape.



TOMATO



EGG

## 6. STANDING TIME

Standing time is important. After cooking or defrosting ensure adequate standing time. This allows the food to continue cooking or heating.

## 8. SIZE

Small pieces cook faster than large ones. To speed cooking, cut pieces smaller than 5 cm so microwaves can penetrate to the centre from all sides. For even cooking, make all the pieces the same size.







## 10. FAT AND BONE

Marbling within meat, or a thin, even layer of fat on a roast, speeds cooking. Large fatty areas or excess drippings in dish attract energy away from meat, and slows cooking. Centre bones do not affect cooking, but bone on the side of meat conducts heat to the areas next to it.

## 12. QUANTITY

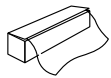
Microwave cooking times are directly related to the amount of food in the oven. Because energy is absorbed by the food itself, one potato or a single piece of chicken cooks rapidly. When the energy is divided among several items, cooking takes more time.

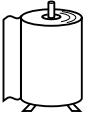
# COOKWARE AND UTENSIL GUIDE

Utensil	Use	Advice
GLASSWARE/ CERAMIC (HEAT RESISTANT)  	YES	<b>GLASSWARE</b> <ul style="list-style-type: none"> <li>• Ordinary glass is not suitable for cooking but may be used for short periods for heating foods.</li> </ul> <b>CERAMIC</b> <ul style="list-style-type: none"> <li>• Most ovenproof china, and ceramics, are suited.</li> <li>• Avoid dishes that are decorated with gold or silver leaf.</li> <li>• Avoid using antique pottery.</li> <li>• If unsure, check with the manufacturer.</li> </ul>
METAL COOKWARE  	NO	<ul style="list-style-type: none"> <li>• Metal cookware should be avoided when cooking in the microwave oven.</li> <li>• Microwave energy is reflected by metal.</li> </ul>
PLASTIC WRAP OVEN BAGS  	YES	<ul style="list-style-type: none"> <li>• Plastic wrap can be used to cover food.</li> <li>• Some shrinkage of the wrap may occur, over an extended cooking time.</li> <li>• When removing wrap, lift it in such a way to avoid steam burns.</li> <li>• Do not tie oven bags with metal twist ties, substitute with string.</li> </ul>
ALUMINIUM FOIL  	FOR SHIELDING	<ul style="list-style-type: none"> <li>• Small amounts may be used to shield certain parts of meat and fish when cooking or defrosting.</li> <li>• Remove food in foil trays, if possible, and place in a microwave safe dish.</li> <li>• If not possible, place the foil tray onto a heat proof plate allowing 2.5 cm room between the walls of the oven.</li> </ul>
STRAW AND WOOD  	NO	<ul style="list-style-type: none"> <li>• Excessive over heating of these materials may cause a fire in the microwave oven.</li> </ul>
PAPER  	YES	<ul style="list-style-type: none"> <li>• Paper towels and waxed paper are suitable to use to prevent splatters.</li> <li>• Ideal for low heat cooking, such as reheating or very short cooking times and for foods with low fat, sugar or water content. Pay special attention as over-heating may cause a fire in your oven.</li> </ul>
PLASTIC COOKWARE MICROWAVE SAFE  	YES	<ul style="list-style-type: none"> <li>• Ideal for cooking, reheating and defrosting.</li> </ul>
THERMOMETERS •MICROWAVE SAFE •CONVENTIONAL	YES NO	

# SHARP

## WARRANTY

### *Consumer Electronic Products*

#### **Congratulations on Your Purchase!**

This Sharp product is warranted against faults in material and manufacture for the period as stated in the table below.

If service is required during the warranty period, please contact your nearest Sharp Approved Service Centre. These repairs would be carried out at no charge to the owner, subject to the conditions specified herein.

This warranty does not extend to defects or injuries caused by or resulting from causes not attributable to faulty parts or the manufacture of the product, including but not limited to, defect or injury caused by or resulting from misuse, abuse, neglect, lack of maintenance, accidental damage, improper voltage, liquid spillage, vermin infestation, software, or any alterations made to the product which are not authorised by Sharp.

Please retain your sales documentation, as this should be produced to validate a warranty claim. This warranty is in addition to and in no way limits, varies or excludes any implied rights and remedies under any relevant legislation in the country of sale.

This warranty does not cover transportation to and from the Sharp Approved Service Centre. Goods presented for repair may be replaced by refurbished goods of the same type rather than being repaired. Refurbished parts may be used to repair the goods. The repair of your goods may result in the loss of user generated data, please ensure that you have saved this data elsewhere prior to repair.

Australian customers: Our goods come with guarantees that cannot be excluded under the Australian Consumer Law. You are entitled to a replacement or refund for a major failure and for compensation for any other reasonably foreseeable loss or damage. You are also entitled to have the goods repaired or replaced if the goods fail to be of acceptable quality and the failure does not amount to a major failure. The criteria of a major failure is defined in the Australian Consumer Law. Should you require any assistance with a major failure please contact Sharp Customer Care.

#### **WARRANTY PERIODS**

Home Theatre Projector	12 months	(excluding lamps and air filters)
Audio/Home Theatre	12 months	
Microwave / Steam Oven	12 months	
Slow Juicer	12 months	
Refrigerator	24 months	
DVD/Blu-ray	12 months	
Washing Machine	24 months	
Portable Air Conditioner	12 months	
LCD Television	12 months	
Air Purifier	12 months	
Vacuum Cleaner	24 months	

**SHARP**  
SHARP CORPORATION OF  
AUSTRALIA PTY. LIMITED  
A/BV 40 003 039 405  
1 Huntingwood Drive  
Huntingwood NSW 2148  
SHARP CORPORATION OF  
NEW ZEALAND LIMITED  
59 Hugo Johnston Drive  
Penrose, Auckland

SPform 040 (SEPT 2013)

**IMPORTANT NOTICE: This warranty applies only to products sold in Australia & New Zealand**

**SHARP®**

FOR LOCATION ENQUIRIES WITHIN

**AUSTRALIA**

REGARDING YOUR LOCAL

SHARP APPROVED SERVICE CENTRE

VISIT OUR WEBSITE AT

**[www.sharp.net.au](http://www.sharp.net.au)**

OR CALL SHARP CUSTOMER CARE

**1300 135 022**

(LOCAL CALL COSTS APPLY WITHIN AUSTRALIA)

SHARP CORPORATION OF AUSTRALIA PTY LTD

**SHARP®**

FOR LOCATION ENQUIRIES WITHIN

**NEW ZEALAND**

REGARDING YOUR LOCAL

SHARP APPROVED SERVICE CENTRE

VISIT OUR WEBSITE AT

**[www.sharp.net.nz](http://www.sharp.net.nz)**

CONTACT YOUR SELLING DEALER/RETAILER

OR CALL

**SHARP CUSTOMER SERVICES**

TELEPHONE: 09 573 0111

FACSIMILE: 09 573 0113

SHARP CORPORATION OF NEW ZEALAND LIMITED

SPform019(JUNE 2004)



## Free Manuals Download Website

<http://myh66.com>

<http://usermanuals.us>

<http://www.somanuals.com>

<http://www.4manuals.cc>

<http://www.manual-lib.com>

<http://www.404manual.com>

<http://www.luxmanual.com>

<http://aubethermostatmanual.com>

Golf course search by state

<http://golfingnear.com>

Email search by domain

<http://emailbydomain.com>

Auto manuals search

<http://auto.somanuals.com>

TV manuals search

<http://tv.somanuals.com>