

SHARP

**OPERATION MANUAL
AND
COOKBOOK**



Carousel™
DOUBLE GRILL CONVECTION
MICROWAVE OVEN

MODELS **R-890N(S)/(W) J**

Download from www.Somanuals.com. All Manuals Search And Download.

SHARP

WARRANTY

Consumer Electronic Products

Congratulations on Your Purchase!

This Sharp product is warranted against faults in material and manufacture for the period as stated in the table below.

If service is required during the warranty period, please contact your nearest Sharp Approved Service Centre. These repairs would be carried out at no charge to the owner, subject to the conditions specified herein.

This warranty does not extend to defects or injuries caused by or resulting from causes not attributable to faulty parts or the manufacture of the product, including but not limited to, defect or injury caused by or resulting from misuse, abuse, neglect, lack of maintenance, accidental damage, improper voltage, liquid spillage, vermin infestation, software, or any alterations made to the product which are not authorised by Sharp.

Please retain your sales documentation, as this should be produced to validate a warranty claim. This warranty is in addition to and in no way limits, varies or excludes any implied rights and remedies under any relevant legislation in the country of sale.

This warranty does not cover transportation to and from the Sharp Approved Service Centre. Goods presented for repair may be replaced by refurbished goods of the same type rather than being repaired. Refurbished parts may be used to repair the goods. The repair of your goods may result in the loss of user generated data, please ensure that you have saved this data elsewhere prior to repair.

Australian customers: Our goods come with guarantees that cannot be excluded under the Australian Consumer Law. You are entitled to a replacement or refund for a major failure and for compensation for any other reasonably foreseeable loss or damage. You are also entitled to have the goods repaired or replaced if the goods fail to be of acceptable quality and the failure does not amount to a major failure. The criteria of a major failure is defined in the Australian Consumer Law. Should you require any assistance with a major failure please contact Sharp Customer Care.

WARRANTY PERIODS

Home Theatre Projector	12 months	(excluding lamps and air filters)
Audio/Home Theatre	12 months	
Microwave / Steam Oven	12 months	
Slow Juicer	12 months	
Refrigerator	24 months	
DVD/Blu-ray	12 months	
Washing Machine	24 months	
Portable Air Conditioner	12 months	
LCD Television	12 months	
Air Purifier	12 months	
Vacuum Cleaner	24 months	

SHARP
SHARP CORPORATION OF AUSTRALIA PTY. LIMITED
A.B.N. 40 003 039 405
1 Huntingwood Drive
Huntingwood NSW 2148
SHARP CORPORATION OF NEW ZEALAND LIMITED
59 Hugo Johnston Drive
Penrose, Auckland

SPform 040 (SEPT 2013)

IMPORTANT NOTICE: This warranty applies only to products sold in Australia & New Zealand

SHARP®

FOR LOCATION ENQUIRIES WITHIN

AUSTRALIA

REGARDING YOUR LOCAL

SHARP APPROVED SERVICE CENTRE

VISIT OUR WEBSITE AT

www.sharp.net.au

OR CALL SHARP CUSTOMER CARE

1300 135 022

(LOCAL CALL COSTS APPLY WITHIN AUSTRALIA)

SHARP CORPORATION OF AUSTRALIA PTY LTD

SHARP®

FOR LOCATION ENQUIRIES WITHIN

NEW ZEALAND

REGARDING YOUR LOCAL

SHARP APPROVED SERVICE CENTRE

VISIT OUR WEBSITE AT

www.sharp.net.nz

CONTACT YOUR SELLING DEALER/RETAILER

OR CALL

SHARP CUSTOMER SERVICES

TELEPHONE: 09 573 0111

FACSIMILE: 09 573 0113

SHARP CORPORATION OF NEW ZEALAND LIMITED

SPform019(JUNE 2004)

INTRODUCTION

SHARP®

INFO DISPLAY COOKING SYSTEM

Thank you for buying a Sharp Microwave Oven. Your new oven has an "Information Display System" which offers you step-by-step instructions to easily guide you through each feature.

Your oven also has a HELP pad for instructions on using Auto Start, Demonstration Mode, Child Lock, Info on pads, Help and Automatic Operations.

We strongly recommend however that you read this operation manual thoroughly before operating your oven, paying particular attention to the safety warnings and special notes.

The manual is divided into two sections:

1. OPERATION (P3~P28)

This section describes your oven and teaches you how to use all the features.

2. COOKING GUIDE

This section is at the back of the manual, it contains the more commonly used information such as how to prepare food, which cooking utensil to use, standing time.

It also contains recipes for automatic cooking.

Please take some time to read your operation manual carefully, the automatic cooking menus programmed into your new oven have been carefully developed to give optimum results when the step-by-step instructions are followed.

When selecting another home appliance, please again consider our full range of Sharp products.

CONTENTS Page

Warranty	Inside of front cover
Introduction	1
Warning	2
Special Notes	3
Installation Instructions	4
Oven Diagram	5
Operation of Touch Control Panel	6
Control Panel Display	6
Touch Control Panel Layout	6
Before Operating	7
Getting Started	7
Clock Set Mode (Clock Setting)	7
Energy Save Mode	8
Power Interruption	8
The Display in Clock Set Mode or Energy Save Mode	8
Stop/Clear	8
To Cancel a Programme During Cooking	8
Manual Operations	9
<Microwave Cooking>	9
Microwave Time Cooking	9
Instant Cook	10
<Heating without Food>	11
<Convection Cooking>	11
To Cook by Convection	11
To Preheat and Cook by Convection	12
Convection and Microwave Cooking	13
<Preheating>	14
<Grill Cooking>	15
<Mix Cooking>	16
<Multiple Sequence Cooking>	17
Automatic Operations	18
Notes for Automatic Operations	18
Instant Action	18
<Automatic Menus>	19
Multi Cook	19
Convenience/Pizza	20
Easy Defrost	21
Other Convenient Features	22
Help Feature	22
Less/More Setting in Automatic Operations	25
Increasing or Decreasing Time During Manual Operations	26
Alarm	26
Care and Cleaning	27
Service Call Check	28
Specifications	28
Cooking Guides	①-③⑨

WARNING

IMPORTANT SAFETY INSTRUCTIONS : READ CAREFULLY AND KEEP FOR FUTURE REFERENCE.

Whenever the top heater, bottom heater or convection symbols are displayed the turntable, turntable support, racks, oven door, outer cabinet, oven cavity and especially bottom heater will become very hot. To prevent yourself from getting burnt use thick oven mittens.

Do not put things on top of the oven or cover the outer cabinet.

Accessible parts (e.g. oven door, turntable and rack) will become hot when in use.

To avoid burns and scalds children should be kept away.

To reduce the risk of fire in the oven cavity:

- a. Do not overcook food.
- b. Remove wire twist-ties from paper or plastic bags before placing bag in the oven.
- c. Do not heat oil or fat for deep frying. The temperature of the oil cannot be controlled.
- d. Look at the oven from time to time when food is heated in disposable containers made of plastic, paper or other combustible materials for signs of smoke or burning.
- e. If materials inside the oven should ignite, or smoke is observed, keep oven door closed, turn oven off, and disconnect the power cord, or shut off power at the fuse or circuit breaker panel.

To reduce the risk of an explosion or delayed eruptive boiling:

Your microwave oven is capable of heating food and beverages very quickly therefore, it is very important that you select the appropriate cooking time and power level for the type and quantity of food to be heated. If you are unsure of the cooking time and power level required, begin with low cooking times and power levels until the food is sufficiently heated evenly throughout.

Additionally:

- a. Do not place sealed containers in the oven. Babies bottles fitted with a screw cap or teat are considered to be sealed containers.
- b. Do not use excessive amount of time.
- c. When boiling liquids in the oven, use a wide-mouthed container.
- d. Stand at least for 20 seconds at the end of cooking to avoid delayed eruptive boiling of liquids.
- e. Stir the liquid before and during cooking. Use extreme care when handling the container or inserting a spoon or other utensil into the container.

This oven is for home food preparation only and should only be used for heating, cooking and defrosting food and beverage. It is not suitable for commercial, laboratory use, or heating therapeutic devices eg. Wheat bags.

Never operate the oven whilst any object is caught or jammed between the door and the oven.

Do not try to adjust or repair the oven yourself.

It is hazardous for anyone other than a qualified service technician trained by SHARP to carry out any service or repair operation. Especially those which involve the removal of a cover which gives protection against exposure to microwave energy are very hazardous.

Do not operate the oven if it is not working correctly or damaged until it has been repaired by a qualified service technician trained by SHARP. It is particularly important that the oven door closes properly and that there is no damage to: (1) Door (warped), (2) Hinges and Latches (broken or loosened), (3) Door Seals, Sealing Surfaces and oven cavity (buckled or deformed), (4) Burn marks on the door seal faces.

Do not bump, or catch utensils, loose clothes and your accessories on the door safety latches when removing food from the oven.

Never poke an object, particularly a metal object, through a grille or between the door and the oven while the oven is operating.

Never tamper with or deactivate the door safety latches.

Always use oven mittens to prevent burns when handling utensils that are in contact with hot food. Enough heat from the food can transfer through utensils to cause skin burns.

Should the power supply cord become damaged, it must be replaced with a special cord supplied by a SERVICE CENTRE APPROVED BY SHARP. And it must be replaced by a qualified service technician trained by SHARP. If the oven lamp fails please consult your dealer or a qualified service technician trained by SHARP.

Avoid steam burns by directing steam away from the face and hands.

Slowly lift the furthest edge of a dish's cover and microwave plastic wrap and carefully open popcorn and oven cooking bags away from the face.

Make sure that the power supply cord is undamaged, and that it does not run under the oven or over any hot surfaces or sharp edges.

Do not place anything on the outer cabinet because the microwave oven will become very hot during the operation.

Do not store food or any other items inside the oven.

Make sure the utensil does not touch the interior walls during cooking.

Only allow children to use the oven without supervision when adequate instructions have been given so that the child is able to use the oven in a safe way and understands the hazards of improper use.

Children should be supervised to ensure that they do not play with the appliance.

This appliance is not intended for use by persons (including children) with reduced physical, sensory or mental capabilities, or lack of experience and knowledge, unless they have been given supervision or instruction concerning use of the appliance by a person responsible for their safety.

SPECIAL NOTES

	DO	DON'T
Eggs, fruits, nuts, seeds, vegetables, sausages and oysters	<ul style="list-style-type: none"> * Puncture egg yolks and whites and oysters before cooking to prevent "explosion". * Pierce skins of potatoes, apples, squash, hot dogs, sausages and oysters so that steam escapes. 	<ul style="list-style-type: none"> * Cook eggs in shells. This prevents "explosion", which may damage the oven or injure yourself. * Reheat whole eggs. * Overcook oysters. * Dry nuts or seeds in shells.
Popcorn	<ul style="list-style-type: none"> * Use specially bagged popcorn for the microwave oven. * Listen while popping corn for the popping to slow to 1-2 seconds. 	<ul style="list-style-type: none"> * Pop popcorn in regular brown bags or glass bowls. * Exceed maximum time on popcorn package.
Baby food	<ul style="list-style-type: none"> * Transfer baby food to small dish and heat carefully, stirring often. Check for suitable temperature to prevent burns. * Remove the screw cap and teat before warming baby bottles. After warming shake thoroughly. Check for suitable temperature. 	<ul style="list-style-type: none"> * Heat disposable bottles. * Overheat baby bottles. Only heat until warm. * Heat bottles with nipples on. * Heat baby food in original jars.
General	<ul style="list-style-type: none"> * Food with filling should be cut after heating, to release steam and avoid burns. * Use a deep bowl when cooking liquids or cereals to prevent boiling over. 	<ul style="list-style-type: none"> * Heat or cook in closed glass jars or air tight containers. * Deep fat fry. * Heat or dry wood, herbs, wet papers, clothes or flowers. * Operate the oven without a load (i.e. an absorbing material such as food or water) in the oven cavity except when conditioning or cleaning the heater elements as described in the operation manual.
Liquids (Beverages)	<ul style="list-style-type: none"> * For boiling or cooking liquids see WARNING on page 2 to prevent explosion and delayed eruptive boiling. 	<ul style="list-style-type: none"> * Heat for longer than recommended time. See REHEATING-FOOD CHART on page 37.
Canned foods	<ul style="list-style-type: none"> * Remove food from can. 	<ul style="list-style-type: none"> * Heat or cook food while in cans.
Sausage rolls, Pies, Christmas pudding	<ul style="list-style-type: none"> * These foods have high sugar and/or fat contents. * Cook for the recommended time. 	<ul style="list-style-type: none"> * Overcook as they may catch fire.
Meats	<ul style="list-style-type: none"> * Use a microwave proof roasting rack to collect drained juices. 	<ul style="list-style-type: none"> * Place meat directly on the turntable for cooking.
Utensils	<ul style="list-style-type: none"> * Check the utensils are suitable for MICROWAVE cooking before you use them. 	<ul style="list-style-type: none"> * Use metal utensils for MICROWAVE cooking. Metal reflects microwave energy and may cause an electrical discharge known as arcing.
Aluminium foil	<ul style="list-style-type: none"> * Use to shield food to prevent over cooking. * Watch for sparking. Reduce foil or keep clear of cavity walls. 	<ul style="list-style-type: none"> * Use too much. * Shield food close to cavity walls. Sparking can damage the cavity.
Browning dish	<ul style="list-style-type: none"> * Place a suitable insulator such as a microwave and heat proof dinner plate between the turntable and the browning dish. 	<ul style="list-style-type: none"> * Exceed the preheating time recommended by the manufacturer. Excessive preheating can cause the glass turntable to shatter and/or damage internal parts of the oven.

INSTALLATION INSTRUCTIONS

1. Remove all packing materials from the oven cavity, (**do not remove the waveguide cover**), and the feature sticker from the outside of the door, if there is one. Check the unit for any damage, such as a misaligned door, damaged door seals around the door or dents inside the oven cavity or on the door. If there is any damage, please do not operate the oven until it has been checked by a **SERVICE CENTRE APPROVED BY SHARP** and repaired, if necessary.

2. Accessories provided

1) Turntable 2) Low rack 3) High rack 4) Combined operation manual and cookbook

3. Since the door may become hot during cooking, you should place or mount the oven so that the bottom of the oven is 85 cm or more above floor. You should also keep children away from the door to prevent them burning themselves.

This oven is designed to be used on a countertop, in a cabinet or built-in. It should not be installed in any area where excessive heat and steam are generated, for example, next to a conventional oven unit. The oven should be installed so as not to block ventilation openings.

For R-890N(S)/(W): Allow a space of at least 40cm on the top, 5cm on both sides and at the rear of the oven for adequate air circulation. When installing in a cabinet, the minimum inside dimension of the cabinet should be 620mm(W) x 709mm(H) x 536mm(D).

When building the oven into a cabinet or wall, a Sharp built-in kit model number EBR-47ST for R-890N(S) and EBR-5000(W) for R-890N(W) are available which enable the microwave oven to be integrated within a kitchen, the kits are available from your retailer. Read carefully the installation instructions for the built-in kit before installation. This built-in kit has been tested according to Australian Standards. Sharp does not recommend the use of any other built-in kit.

If the oven is to be positioned near a conventional oven, ensure that adequate space is allowed, and a suitable heat shield is incorporated between the two to prevent damage to the oven and the built-in kit caused by heat.

WARNING: The electrical outlet must be readily accessible so that the unit can be unplugged easily in an emergency.

4. Neither the manufacturer nor the distributors can accept any liability for damage to the machine or personal injury for failure to observe the correct electrical connecting procedure.

The A.C. voltage must be single phase 230-240V, 50Hz.

5. This appliance must be earthed.

6. Operate the oven from a general purpose domestic outlet. If a generator is used, do not operate the oven with non-sinusoidal outputs.

7. Before using top or bottom heater for the first time, operate the oven without food for 20 minutes using both heaters. This will allow the oil that is used for rust protection to be burned off.

OVEN DIAGRAM

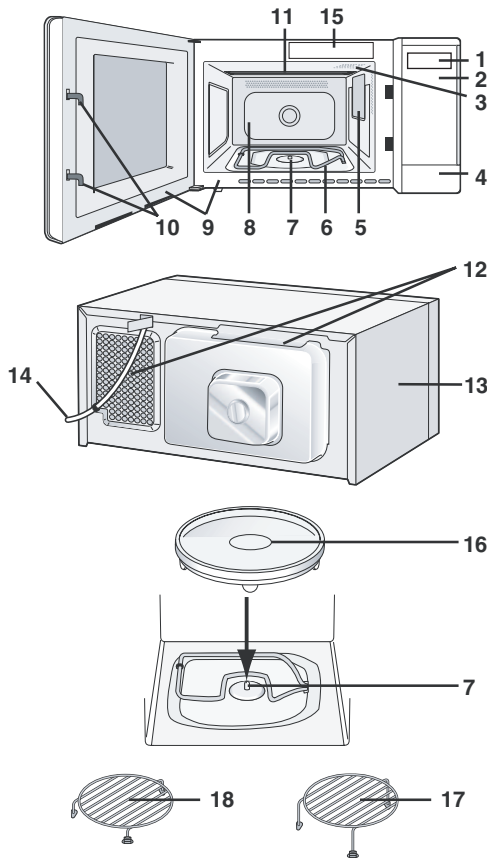

OVEN:

1. Liquid crystal display
2. Control panel
3. Oven lamp
4. Door opening button
5. Waveguide cover (DO NOT REMOVE)
6. Bottom grill heating element
7. Turntable motor shaft
8. Oven cavity
9. Door seals and sealing surfaces
10. Door latches
11. Top grill heating element
12. Ventilation openings
13. Outer cabinet
14. Power cord
15. Menu label

ACCESSORIES:

16. Turntable
 17. High rack
 18. Low rack
- Place the turntable on to the turntable motor shaft, ensuring it is located firmly.
 - To avoid turntable damage, ensure dishes or containers are lifted clear of the turntable rim when removing them from the oven.
 - The racks are for Grill, Mix, Convection and recommended automatic operations.

Never touch the grills when they are hot.

NOTES:

- The waveguide cover is fragile. Care should be taken when cleaning inside the oven to ensure that it is not damaged.
- After cooking fatty foods without a cover, always clean the cavity and especially the grill heating elements thoroughly, these must be dry and free from grease. Built-up grease may overheat and begin to smoke or catch fire.
- Always operate the oven with the turntable fitted correctly. This promotes thorough, even cooking. A badly fitted turntable may rattle, may not rotate properly and could cause damage to the oven.
- The turntable rotates clockwise or anti-clockwise. The rotary direction may change each time you start the oven. This does not affect cooking performance.

Warning:

The accessories will become very hot whenever the top heater, bottom heater or convection symbols are lighted in the display and use thick oven mittens when inserting/removing the food or turntable from the oven to PREVENT BURNS.

OPERATION OF TOUCH CONTROL PANEL

The operation of the oven is controlled by pressing the appropriate pads arranged on the surface of the control panel. An entry signal tone should be heard each time you press the control panel to make a correct entry. In addition the oven will beep for approximately 2 seconds at the end of the cooking cycle, or 4 times when a cooking procedure is required.

Control Panel Display

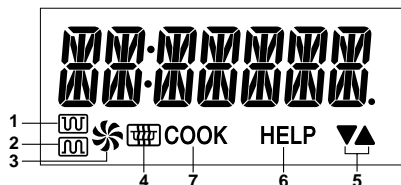

1. TOP GRILL SYMBOL
It will appear when setting a programme using the top grill, or when the top grill is in use.
2. BOTTOM GRILL SYMBOL
It will appear when setting a programme using the bottom grill, or when the bottom grill is in use.
3. CONVECTION SYMBOL
It will appear when setting a programme using the convection mode, or when in a convection cooking.
4. MICROWAVE SYMBOL
It will appear when setting a programme using the microwave mode, or when in a microwave cooking.
5. MORE (▲)/LESS (▼) indicators
They will appear when setting the MORE or LESS function.
6. HELP indicator
It will appear when setting the HELP feature or an automatic operation.
7. COOK indicator
It will light up when cooking.

Touch Control Panel Layout

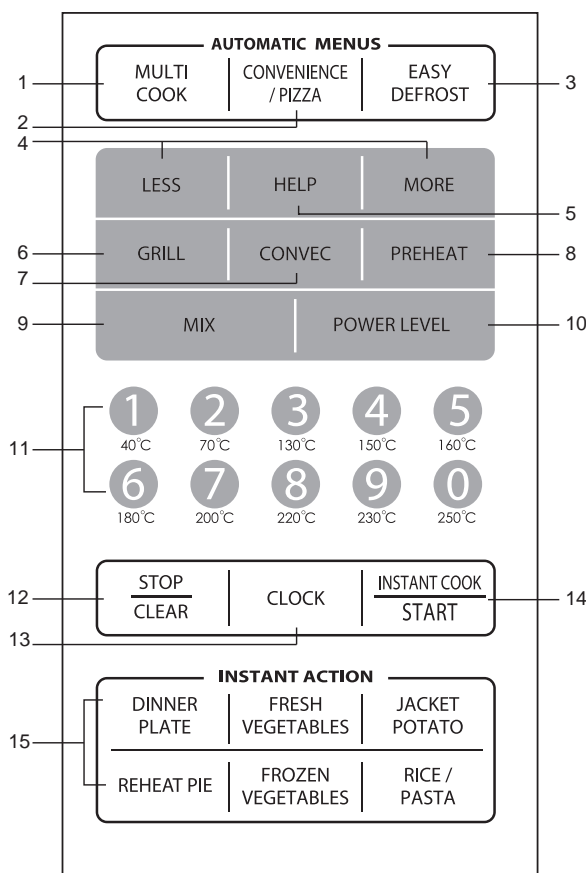

1. MULTI COOK PAD
Press to select Multi Cook mode.
2. CONVENIENCE/PIZZA pad
Press to select 6 popular menus.
3. EASY DEFROST pad
Press to defrost meat by entering weight.
4. MORE, LESS pads
Press to adjust the doneness of food in one minute increments during cooking or to increase/decrease the time whilst programming the automatic operations.
5. HELP pad
Press to select auto start, child lock demonstration modes or info on pads. Press to obtain cooking information.
6. GRILL pad
Press to select grill cooking.
7. CONVEC pad
Press to select convection cooking.
8. PREHEAT pad
Press to preheat the oven prior to cooking.
9. MIX pad
Press to select mix cooking.
10. POWER LEVEL pad
Press to select microwave power setting. If not pressed, 100% is automatically selected.
11. NUMBER AND TEMPERATURE pads
Press to enter cooking times, clock time, convection temperature, weight or quantity of food.
12. STOP/CLEAR pad
Press to clear during programming. Press once to stop operation of oven during cooking; press twice to cancel cooking programme.
13. CLOCK pad
Press to set clock time.
14. INSTANT COOK/START pad
Press once to cook for 1 minute at 100% power level or increase by 1 minute multiples each time this pad is pressed during manual cooking. Press to start oven after setting programs.
15. INSTANT ACTION pads
Press once to cook or reheat 6 popular menus.

BEFORE OPERATING

Getting Started

Your oven has an Energy Save Mode. This facility saves electricity when the oven is not in use.

Step	Procedure	Pad Order	Display
1	Plug the oven into a power point and switch on the power.		Nothing will be shown in the display.
2	Open the door.		ENERGY, SAVE, MODE, TO, CANCEL, ENERGY, SAVE, MODE, SET THE, CLOCK will be displayed.
3	Close the door.		





CAUTION:

In Energy Save Mode, if you do not operate the oven for 3 minutes or more (i.e. after closing the door, or pressing the STOP/CLEAR pad, or at the end of cooking), you will not be able to operate the oven until you open and close the oven door again.

NOTE: When you set Child Lock or Demonstration Mode, Energy Save Mode will be cancelled temporary.

Clock Set Mode (Clock Setting)

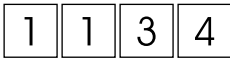
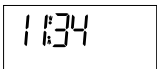
* To enter the present time of day 11:34 (AM or PM).

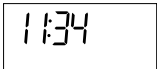
Step	Procedure	Pad Order	Display
1	Press the CLOCK pad.		
2	Enter the correct time of day by pressing the numbers in sequence.		 The dots (:) will flash on and off.
3	Press the CLOCK pad again.		

This is a 12 hour clock. If you attempt to enter an incorrect clock time (Eg. 13:45) ERROR will appear in the display. Press the STOP/CLEAR pad and re-enter the time of day (Eg. 1:45).

If the clock is set, when cooking is complete, the display will show the correct time of day. If the clock has not been set, the display will only show "0" when cooking is complete. If the electrical power supply to your microwave oven is interrupted, plug in the oven again, then open the door. The display will show: ENERGY SAVE MODE TO CANCEL ENERGY SAVE MODE SET THE CLOCK. If this occurs during cooking, the programme will be erased. The time of day will also be erased. The clock of the oven works based on the frequency of power source. So it may gain or lose in some area where the frequency varies. It is recommended that you should adjust the time occasionally.

HELPFUL HINTS:

If you wish to know the time of day during the cooking or timer mode, press the CLOCK pad.

As long as your finger is pressed the CLOCK pad, the time of day will be displayed, if the clock is set.

Energy Save Mode



Your oven has an Energy Save Mode. In Energy Save Mode approximately 0.1 watt is used, when blank shows in the display. While in Clock Set Mode approximately 3 watt is used as the time will be shown. The Display in Clock Set Mode or Energy Save Mode under different conditions is listed below for your reference.

In Energy Save Mode, if you do not operate the oven for 3 minutes or more (i.e. closing the door, pressing the STOP/CLEAR pad), the display will be blank and the oven cannot be used. To restore power on, open and then close the door, “. 0” will be displayed and the oven is ready for use.

If you set the clock, Energy Save Mode will be cancelled.

To start Energy Save Mode manually, follow the instructions below.

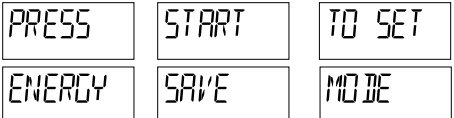
* To start the Energy Save Mode (the display shows the time of day).

Step	Procedure	Pad Order	Display
1	Press the CLOCK pad twice.	 x 2	
2	Press the INSTANT COOK/ START pad.		 The power will be off and the display will show nothing.

Power Interruption

If the power goes off or the display is blank, refer to Step 2 and 3 in the Getting Started on page 7 to resume normal operation. Your oven works normally, however there is a case that previous setting such as Child Lock, Auto Start, and Demonstration Mode will be cancelled. The Display in Clock Set mode and Energy Save Mode under different conditions is listed below for your reference.

The display in Clock Set Mode or Energy Save Mode

Condition \ Mode	Clock Set Mode	Energy Save Mode
No cooking or no operating (Expect Child Lock, Demo)	Current time	".0" or Blank (without operating over 3 minutes)
Child Lock setting	Current time (Lock will be displayed by pressing a pad each time.)	".0"
Auto Start setting	Setting time	Auto Start can not be set in Energy Save Mode.
Demonstration Mode setting	DEMO MICROWAVE OVEN	
Power Interruption	Blank	

Stop/Clear

Press the STOP/CLEAR pad once to:

1. Stop the oven temporarily during cooking.
2. Clear if you make a mistake during programming.
3. Clear the message on the display after cooking.

To Cancel a Programme During Cooking

Press the STOP/CLEAR pad twice.

MANUAL OPERATIONS

<Microwave Cooking>

Microwave Time Cooking

This is a manual cooking feature, first enter the cooking time then the power level.

You can programme up to 99 minutes, 99 seconds.

There are five different power levels.

Power level	LOW	M•LOW	MEDIUM	M•HIGH	HIGH
Approximate percentage of microwave power	10%	30%	50%	70%	100%
Display	10 P	30 P	50 P	70 P	100 P
Examples of foods typically cooked on different microwave power levels	Keeping food warm	Defrosting Softening butter	Casseroles Seafood	Cakes Muffins Slices	Fruit Vegetables Rice/Pasta

This variable cooking control allows you to select the rate of microwave cooking.

If a power level is not selected, then 100% power level is automatically used.

*Suppose you want to cook for 10 minutes at 100% power level.

Step	Procedure	Pad Order	Display
1	Enter desired cooking time.	1 0 0 0	10:00
2	Press the INSTANT COOK/START pad.	INSTANT COOK START	10:00 COOK The timer begins to count down.

To lower the power press the POWER LEVEL pad once. Note the display will indicate "100P". To lower to "70P" press the POWER LEVEL pad again. Repeat as necessary to select "50P", "30P" or "10P" power levels.

* Suppose you want to cook Fish Fillets for 10 minutes at 50% power level.

Step	Procedure	Pad Order	Display
1	Enter desired cooking time.	1 0 0 0	10:00
2	Select power level by pressing the POWER LEVEL pad as required (for 50% power level press three times).	POWER LEVEL x 3	50 P
3	Press the INSTANT COOK/START pad.	INSTANT COOK START	10:00 COOK The timer begins to count down.

If the door is opened during the cooking process, the cooking time in the display automatically stops. The cooking time starts to count down again when the door is closed and the INSTANT COOK/START pad is pressed.

HELPFUL HINTS:

If you want to check the power level during the cooking, press POWER LEVEL pad.



As long as your finger is pressing the POWER LEVEL pad, the power level will be displayed.

Instant Cook™

For your convenience Sharp's Instant Cook allows you to easily cook for one minute at 100% power level. Instant Cook function is 2 operation methods below and each time the INSTANT COOK/START pad is pressed, the cooking time is increased by 1 minute up to 99minutes.







<Not during cooking>

* Suppose you want to cook 1 minute at 100% power level.

Step	Procedure	Pad Order	Display
1	Press the INSTANT COOK/START pad. Within 3 minutes of closing the door, cooking completion or pressing the STOP/CLEAR pad.		 The timer begins to count down.





<During cooking in Manual Operation>

* Suppose you want to cook for 2 minutes 30 seconds at 100% power level and add 2 minutes during cooking.

Step	Procedure	Pad Order	Display
1	Enter desired cooking time.		
2	Press the INSTANT COOK/START pad.		 The timer begins to count down.
			
3	Press the INSTANT COOK/START pad twice.	 x 2	

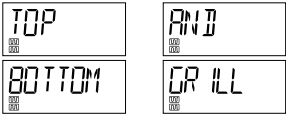
<Heating without Food>

Before the first use and after cleaning the top and bottom heaters must be conditioned. The procedure involves heating the heaters for a period of 20 minutes. You may notice some smoke and odour during this process, this is normal, the oven is not out of order. Follow the procedure below.

Step	Procedure	Pad Order	Display
1	Ensure that no food is in the oven. Press the GRILL pad three times.	 X3	
2	Enter the heating time (20 min.).		
3	Press the INSTANT COOK/START pad. IMPORTANT: During this operation, some smoke and odour will occur. Therefore open the windows or run the ventilation fan in the room.		 The timer begins to count down to zero. When timer reaches zero, all indicators will go out and the oven will "beep". END will be displayed.
4	Open the door to cool the oven cavity. The cooling fan will remain on until the oven cavity has cooled. WARNING: The oven door, outer cabinet, turntable and oven cavity will be hot to PREVENT BURNS allow the oven to cool.		







<Convection Cooking>

Please consult your Convection Microwave Cookbook for more specific cooking instructions and procedures.

To Cook by Convection

Your Convection Microwave Oven can be programmed for ten different convection cooking temperatures (250, 230, 220, 200, 180, 160, 150, 130, 70, 40 °C) up to 99 minutes, 99 seconds.

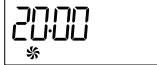
* Suppose you want to cook for 20 minutes at 180°C.

Step	Procedure	Pad Order	Display
1	Place turntable in the oven. Press the CONVEC pad.		
2	Enter desired temperature.		
3	Enter desired cooking time.		
4	Press the INSTANT COOK/START pad.		 The timer begins to count down to zero. When timer reaches zero, all indicators will go out and the oven will "beep". END will be displayed. The cooling fan will remain on and NOW COOLING may be displayed until the oven cavity has cooled.

WARNING:

The oven cavity, door, turntable, racks, dishes and especially the bottom heater will become very hot, use thick oven mittens when inserting/removing the food or turntable from the oven to PREVENT BURNS.











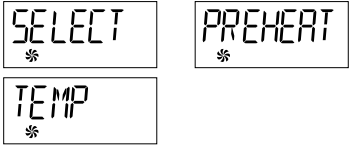

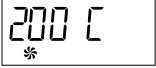
HELPFUL HINTS:

If you are cooking and wish to check the temperature you have programmed, simply press the CONVEC pad. The programmed temperature will be displayed as long as CONVEC pad is pressed.

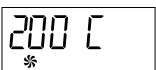
NOTE: During preheating and convection cooking, you will hear the cooling fan cycling on and off. This is completely normal and will not affect the cooking.

To Preheat and Cook by Convection

* Suppose you want to preheat the oven to 200°C then cook for 20 minutes at 200°C.

Step	Procedure	Pad Order	Display
1	Press the PREHEAT pad.		
2	Press desired preheat temperature pad.		
3	Press the CONVEC pad.		
4	Press desired cooking temperature pad.		
5	Enter desired cooking time.		
6	Press the INSTANT COOK/START pad. When "ADD FOOD" is displayed, the oven is preheated. If the oven door is not opened, the oven will automatically hold at the preheat temperature for 30 minutes.		 will be displayed repeatedly. When preheat is over, the oven will "beep" 4 times and ADD FOOD will be displayed.
7	Open the door. Place food in oven. Close the door.		PRESS START will be displayed.
8	Press the INSTANT COOK/START pad.		 The timer begins to count down to zero and all indicators will go off and the oven will "beep" and END will be displayed. The cooling fan will remain on and NOW COOLING may be displayed until the oven cavity has cooled.

WARNING:









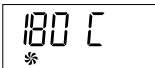
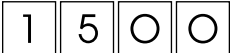
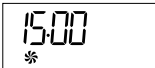

The oven cavity, door, turntable, racks, dishes and especially the bottom heater will become very hot, use thick oven mittens when inserting/removing the food or turntable from the oven to PREVENT BURNS.

NOTE: During preheating and convection cooking, you will hear the cooling fan cycling on and off. This is completely normal and will not affect the cooking.

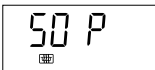
Convection and Microwave Cooking

Your oven can be programmed to combine convection and microwave cooking operations.

* Suppose you want to roast chicken pieces for 15 minutes at 180°C and then cook at 8 minutes at 50% power level.

Step	Procedure	Pad Order	Display
1	Press the CONVEC pad.		
2	Enter desired convection temperature.		
3	Enter desired convection cooking time.		
4	Select microwave cooking and power level by pressing the POWER LEVEL pad as required (for 50% power level press three times.)	 x 3	
5	Enter desired microwave cooking time.		
6	Press the INSTANT COOK/START pad.		 The timer begins to count down to zero. When it reaches zero,  The timer begins to count down to zero and all indicators will go off and the oven will "beep" and END will be displayed. The cooling fan will remain on and NOW COOLING may be displayed until the oven cavity has cooled.

Do not use plastic (non-heat proof) cookware if combining Convection and Microwave mode.

WARNING:







The oven cavity, door, turntable, racks, dishes and especially the bottom heater will become very hot, use thick oven mittens when inserting/removing the food or turntable from the oven to PREVENT BURNS.

NOTE: During Preheating and Convection cooking, you will hear the cooling fan cycling on and off. This is completely normal and will not affect the cooking.

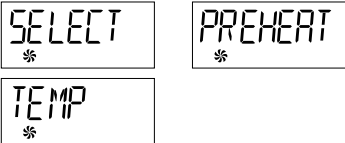







<Preheating>

For best results, preheat to the required temperature with the turntable in the oven. Add food after preheating.

* To preheat the oven to 200°C

Step	Procedure	Pad Order	Display
1	Press the PREHEAT pad.		
2	Select preheating temperature.		
3	Press the INSTANT COOK/ START pad.		
4	Preheat is over. If the oven door is not opened, the oven will automatically hold at the preheat temperature for 30 minutes.		

After preheating, Suppose you want to cook profiteroles for 20 minutes on convection 200°C.

5	Open the door and place food. Close the door.		
6	Press the CONVEC pad.		
7	Enter desired temperature.		
8	Enter desired cooking time.		
9	Press the INSTANT COOK/ START pad.		 The timer begins to count down and all indicators will go off and the oven will "beep" and END will be displayed. The cooling fan will remain on and NOW COOLING may be displayed until the oven cavity has cooled.

HELPFUL HINTS:

If you are in the process of preheating and wish to check the actual oven temperature, simply press the CONVEC pad. The actual oven temperature will be displayed as long as the CONVEC pad is pressed.

If the oven temperature is below 40°C at this time,  will be displayed.

NOTES:

MIX, GRILL or MICROWAVE function can be used with Preheat function by pressing MIX, GRILL or MICROWAVE pad instead of CONVECTION pad at step 6.

During Preheating and Convection Cooking, you will hear the cooling fan cycling on and off. This is completely normal and will not affect the cooking.

WARNING:

The oven cavity, door, turntable, racks, dishes and especially the bottom heater will become very hot, use thick oven mittens when inserting/removing the food or turntable from the oven to PREVENT BURNS.





<Grill Cooking>

Your oven has three grill cooking modes. Select the desired grill mode by pressing the GRILL pad.

Grill cooking Mode	press the GRILL pad
Top Grill Mode	Once
Bottom Grill Mode	Twice
Top and Bottom Grill Mode	3 times

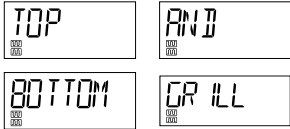
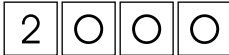
It is not necessary to preheat for grill cooking.

* Suppose you want to cook for 20 minutes using the top and bottom heaters.

Step	Procedure	Pad Order	Display
1	Press the GRILL pad three times.	 x 3	
2	Enter desired cooking time.		
3	Press the INSTANT COOK/START pad.		 The timer begins to count down. When it reaches zero, all indicators will go off and the oven will "beep". The cooling fan will remain on and NOW COOLING may be displayed until the oven cavity has cooled.

WARNING:

The oven cavity, door, turntable, racks, dishes and especially the bottom heater will become very hot, use thick oven mittens when inserting/removing the food or turntable from the oven to PREVENT BURNS.





<Mix Cooking>

Your oven has four preprogrammed settings that make it easy to cook with both grill heaters and microwave.

Select the desired mix setting by pressing the MIX pad. It is not necessary to preheat for the mix cooking.

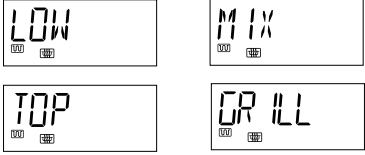
Setting	The times pressing MIX pad	Preset programme	
		Microwave power	Grill heater
HIGH MIX TOP GRILL	Once	70%	Top heater
LOW MIX TOP GRILL	Twice	50%	Top heater
HIGH MIX BOTTOM GRILL	three times	50%	Bottom heater
LOW MIX BOTTOM GRILL	four times	10%	Bottom heater

* Suppose you want to cook for 6 minutes on LOW MIX TOP GRILL.

Step	Procedure	Pad Order	Display
1	Press the MIX pad twice.	 x 2	
2	Enter desired cooking time.		
3	Press the INSTANT COOK/START pad.		 The timer begins to count down. When it reaches zero, all indicators will go off and the oven will "beep". END will be displayed. The cooling fan will remain on and NOW COOLING may be displayed until the oven cavity has cooled.

WARNING:

















The oven cavity, door, turntable, racks, dishes and especially bottom heater will become very hot, use thick oven mittens when inserting/removing the food or turntable from the oven to PREVENT BURNS.

<Multiple Sequence Cooking>

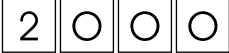
Preheating, Microwave Cooking, Convection Cooking, Grill Cooking or Mix Cooking can be programmed up to 4 automatic cooking sequences, switching from one variable power setting.

Note that POWER LEVEL must be entered first when programming sequence cooking.

* Suppose you want to cook for 10 minutes at 50% power level, cook 5 minutes at 100% power level and cook with Top Grill for 20 minutes.

Step	Procedure	Pad Order	Display
1	Select microwave cooking and desired power level by pressing the POWER LEVEL pad (for 50% power level press three times).	 x 3	
2	Enter desired cooking time.		
3	For second sequence, select microwave cooking and power level (for 100% power level press the POWER LEVEL pad once)		
4	Enter desired cooking time for the second sequence.		
5	For third sequence, press the GRILL pad.	 x 1	
6	Enter desired cooking time.		
7	Press the INSTANT COOK/START pad.		<p> The timer begins to count down to zero. When it reaches zero,</p> <p> the second sequence will be displayed and the timer will begin counting down to zero again.</p> <p> And then the third sequence will be displayed and the timer will begin counting down to zero. All indicators will go off and the oven will "beep" and END will be displayed. The cooling fan will remain on and NOW COOLING may be displayed until the oven cavity has cooled.</p>

WARNING:

The oven cavity, door, turntable, racks, dishes and especially bottom heater will become very hot, use thick oven mittens when inserting/removing the food or turntable from the oven to PREVENT BURNS.

AUTOMATIC OPERATIONS

Notes for Automatic Operations

1. ERROR will be displayed if:
More or less than the quantity or weight of foods suggested in the MULTI COOK, CONVENIENCE/PIZZA or EASY DEFROST MENU GUIDE are programmed when the INSTANT COOK/START pad is pressed.
To clear, press the STOP/CLEAR pad and reprogramme.
2. When using AUTOMATIC MENUS (Multi Cook, Convenience / Pizza, Easy Defrost) or INSTANT ACTION, carefully follow the details provided in each MENU GUIDE to achieve the best result.
If the details are not followed carefully, the food may be overcooked, undercooked or ERROR may be displayed.
3. Food weighing more or less than the quantity or weight listed in each MENU GUIDE, cook manually. Refer to manual cooking charts in RECIPES section.
4. When entering the weight of the food, round off the weight to the nearest 0.1kg(100g). For example, 1.65kg would become 1.7kg.
5. To change the final cooking or defrosting result from the standard setting, press the MORE or LESS pad prior to pressing the INSTANT COOK/START pad in AUTOMATIC MENUS, or before pressing the desired INSTANT ACTION pad or within 2 seconds after pressing the INSTANT ACTION pad in INSTANT ACTION. See page 25.
6. The final cooking result will vary according to the food condition (e.g. initial temperature, shape, quality). Check the food after cooking and if necessary continue cooking manually.

Instant Action

INSTANT ACTION		
DINNER PLATE	FRESH VEGETABLES	JACKET POTATO
REHEAT PIE	FROZEN VEGETABLES	RICE / PASTA

Press once to cook 6 popular menus. Follow the details provided in INSTANT ACTION MENU GUIDE on page ④ - ⑤ in the cooking guides.

* Suppose you want to cook 1.0 kg Fresh Vegetables.

Step	Procedure	Pad Order	Display
1	Press the INSTANT ACTION pad for Fresh Vegetables (within 3 minutes of closing the door, pressing the STOP/CLEAR pad or cooking completion).	<div style="border: 1px solid black; padding: 5px; display: inline-block;">FRESH VEGETABLES</div> x 10	<div style="border: 1px solid black; padding: 5px; display: inline-block;"> 10:10 <small>COOK HELP</small> </div> <div style="border: 1px solid black; padding: 5px; display: inline-block;"> 9:40 <small>COOK HELP</small> </div> The timer begins to count down. When the cooking time reaches zero, STAND, COVERED, 1-5MIN, THEN, STIR, ENJOY, YOUR, VEGETABLES will be displayed.

HELPFUL HINT:

You can get a cooking hint by pressing the HELP pad before pressing the desired INSTANT ACTION pad. See page 24.

NOTE:

Press the desired pad in INSTANT ACTION to enter quantity until desired quantity is shown in the display.

<AUTOMATIC MENUS>

Multi Cook







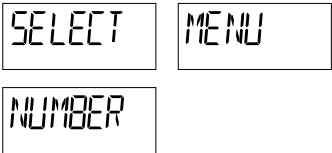

MULTI
COOK

- | | |
|------------------|---------------------------|
| 1. Roast Beef | 4. Roast Pork |
| 2. Roast Lamb | 5. Grilled Steak/Chops |
| 3. Roast Chicken | 6. Grilled Chicken Pieces |

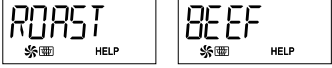
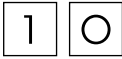
Press to select 6 popular Grill and Mix cooking menus.

Follow the details provided in MULTI COOK MENU GUIDE on page ⑥ - ⑦ in the cooking guides.

* Suppose you want to cook 1.0 kg Roast Beef (Medium).

Step	Procedure	Pad Order	Display
1	Press the MULTI COOK pad.		
2	Select food category for Multi Cook. Press 1 to cook Roast Beef.		
3	Enter the weight.		
4	Press the INSTANT COOK/START pad.		 The timer begins to count down. The oven will "beep" 4 times and will stop. TURN, BEEF, OVER will be displayed repeatedly.
5	Open the door. Turn over the meat. Close the door.		PRESS START will be displayed repeatedly.
6	Press the INSTANT COOK/START pad.		 When the cooking time reaches zero, STAND, COVERED, WITH, FOIL, 5-15, MIN, ENJOY, YOUR, BEEF will be displayed repeatedly.

HELPFUL HINT:

You can get a cooking hint whenever HELP is lit in the display in AUTOMATIC MENUS. See page 24.

WARNING:

The oven cavity, door, turntable, racks, dishes and especially bottom heater will become very hot, use thick oven mittens when inserting/removing the food or turntable from the oven to PREVENT BURNS.

NOTE:

After cooking completion at step 6 and removing food, there is a case that the cooling fan remains on and NOW COOLING is displayed until the oven cavity has cooled.







Convenience / Pizza

CONVENIENCE
/ PIZZA

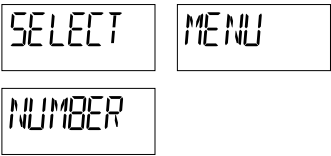
- 1.Frozen Pizza
- 2.Fresh Pizza
- 3.Fries
- 4.Frozen Pasta
- 5.Crumbed Fish
- 6.Finger Food

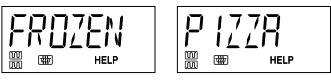
Press to select 6 popular menus.
Follow the details provided in CONVENIENCE / PIZZA MENU GUIDE on page ⑧ in the cooking guides.

* Suppose you want to cook 0.5 kg Frozen Pizza.

Step	Procedure	Pad Order	Display
1	Press the CONVENIENCE / PIZZA pad.		
2	Select food category for Convenience / Pizza. Press 1 to cook Frozen Pizza.		
3	Enter the weight.		
4	Press the INSTANT COOK/START pad.		 The timer begins to count down. When the cooking time reaches zero, ENJOY, YOUR, PIZZA will be displayed repeatedly.

HELPFUL HINT:

You can get a cooking hint whenever HELP is lit in the display in AUTOMATIC MENUS. See page 24.

WARNING:

The oven cavity, door, turntable, racks, dishes and especially bottom heater will become very hot, use thick oven mittens when inserting/removing the food or turntable from the oven to PREVENT BURNS.

NOTE:

After cooking completion at step 6 and removing food, there is a case that the cooling fan remains on and NOW COOLING is displayed until the oven cavity has cooled.

Easy Defrost







EASY
DEFROST

Steak/Chops
Minced Meat (Beef)
Roast Meat
(Beef/Lamb/Pork)
Chicken Pieces
Poultry

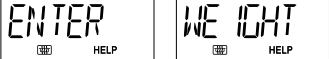
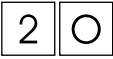
The Easy Defrost feature allows you to defrost meats by entering weight.

Follow the details provided in EASY DEFROST MENU GUIDE on page ⑨ in the cooking guides.

* Suppose you want to defrost 2.0 kg Poultry.

Step	Procedure	Pad Order	Display
1	Press the EASY DEFROST pad.		
2	Press number pads to enter weight.		
3	Press the INSTANT COOK/START pad.		 The cooking time will begin counting down. The oven will “beep” 4 times and will stop. REMOVE, DE-, FROSTED, PORTION, TURN, FOOD, OVER, SHIELD, EDGES, OF, WARM, PORTION, WITH, FOIL will be displayed repeatedly.
4	Open the door. Turn over meat. Close the door.		PRESS, START will be displayed repeatedly.
5	Press the INSTANT COOK/START pad.		 The cooking time will begin counting to zero, when it reaches zero, the oven will “beep”. STAND, COVERED, WITH, FOIL, 5-50, MIN will be displayed repeatedly.

HELPFUL HINT:

You can get a cooking hint whenever HELP is lit in the display in AUTOMATIC MENUS. See page 24.

OTHER CONVENIENT FEATURES

Help Feature























HELP

The HELP feature has 5 different programs.

Auto Start

The Auto Start feature allows you to set your oven to start automatically.

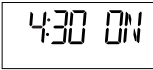
* Suppose you want to start cooking a casserole for 20 minutes at 50% power level at 4:30. (AM or PM)
(Check that the correct time of day is displayed.)

Step	Procedure	Pad Order	Display
1	Press the HELP pad.		AUTO, START, PRESS 1, LOCK, PRESS 2, DEMO, PRESS 3, INFO ON, PADS, PRESS, DESIRED, PAD will be displayed repeatedly.
2	Press the number 1 pad.		 
3	Enter the desired start time.	  	 The dots (:) will flash on and off.
4	Press the CLOCK pad.		
5	Set the desired cooking mode. (for microwave cooking at 50% power level, press the POWER LEVEL pad 3 times)	 x3	
6	Enter the desired cooking time.	   	
7	Press the INSTANT COOK/START pad.		   The oven will start cooking at 4:30.  The timer begins to count down. When the timer reaches zero, all indicators will go off and the oven will "beep". END will be displayed.

HELPFUL HINT:

To check the current time, simply press the CLOCK pad, the time will be displayed.

NOTE:



If the door is opened after step 7, close the door and press the START pad to continue with Auto Start. Press the STOP/CLEAR pad to cancel Auto Start.

The correct time of day must be set before using Auto Start, see clock setting on page 7.

Child Lock

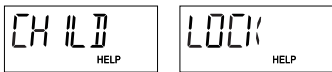

If the oven is accidentally started with no food or liquid in the cavity, the life of the oven can be reduced. To prevent accidents like this, your oven has a "Child Lock" feature that you can set when the oven is not in use.

* To set the Child Lock.
After step 1 for Auto Start.

Step	Procedure	Pad Order	Display
2	Press the number 2 pad.		
3	Press the INSTANT COOK/START pad.		 The time of day will be displayed.

The control panel is now locked, each time a pad is pressed, the display will show "LOCK".





* To cancel the Child Lock.
After step 2 for Child Lock.

Step	Procedure	Pad Order	Display
3	Press the STOP/CLEAR pad.		 The time of day will be displayed. The oven is ready to use.

Demonstration Mode



This feature is mainly for use by retail outlets, and also allows you to practice key operations.

* To demonstrate.
After step 1 for Auto start.



Step	Procedure	Pad Order	Display
2	Press the number 3 pad.		 DEMO, MODE, TO TURN, ON, PRESS, START, TO TURN, OFF, PRESS, CLEAR will be displayed repeatedly.
3	Press the INSTANT COOK/START pad.		 Then DEMO, MICRO-, WAVE, OVEN will be displayed repeatedly.

Cooking operations can now be demonstrated with no power in the oven.

* Suppose you demonstrate Instant Cook.
After step 3 for Demonstration Mode on page 23.

Step	Procedure	Pad Order	Display
4	Press the INSTANT COOK/START pad.		 The cooking time will begin counting down to zero at ten times the speed. When the timer reaches zero, END will be displayed.

* To cancel the Demonstration Mode.
After step 2 for Demonstration Mode on page 23.

Step	Procedure	Pad Order	Display
3	Press the STOP/CLEAR pad.		 The time of day will be displayed.

Info on Pads

Each pad carries useful guide.

* To get the guide for CONVEC pad. After step 1 for Auto Start on page 22.

Step	Procedure	Pad Order	Display
2	Press the CONVEC pad.		PRESS, TO COOK, ON, CONVEC, TEMP, 40 C-, 250 C will be displayed twice.

The guide message will be repeated twice, and then the display will show the time of day.
If you want to cancel the guide, press the STOP/CLEAR pad.

Help

Each setting of Automatic Operations has a cooking hint.
If you wish to check, press the HELP pad whenever HELP is lit in the display.

Less/More Setting in Automatic Operations

LESS

MORE









The cooking times programmed into Automatic Operations are tailored to the most popular tastes. To adjust the cooking time to your individual preference use the “more” or “less” feature to either add (more) or reduce (less) cooking time.

The LESS/MORE pads can be used to adjust the cooking time of the following features

- INSTANT ACTION – MULTI COOK
- CONVENIENCE / PIZZA – EASY DEFROST

To adjust cooking time, press the LESS or MORE pad prior to pressing the INSTANT COOK/START pad at step 4 in AUTOMATIC MENUS, or before pressing the desired INSTANT ACTION pad or within 2 seconds after pressing the desired INSTANT ACTION pad in INSTANT ACTION.

* Suppose you want to defrost 0.5 kg Roast Meat for less time than the standard setting.

Step	Procedure	Pad Order	Display
1	Press the LESS pad.		
2	Press the EASY DEFROST pad.		
3	Press number pad to enter weight. EX: 0.5kg Roast Meat.		
4	Press the INSTANT COOK/START pad.		

NOTE: When the LESS or MORE pad is pressed twice, the less or more setting is canceled. Skip step 3 and 4 in INSTANT ACTION.











Increasing or Decreasing Time During Manual Operations

LESS

MORE

Microwave, Convection, Grilling or Mix time can be added or decreased during a cooking programme using the "MORE" or "LESS" pads.

* Suppose you want to increase cooking time by 2 minutes during 5 minutes at 50% power level.

Step	Procedure	Pad Order	Display
1	Select microwave cooking and power level by pressing the POWER LEVEL pad as required. (for 50% power level press three times)	 x3	
2	Enter desired cooking time.	  	
3	Press the INSTANT COOK/START pad.		 The timer starts to count down. 
4	Press the MORE pad twice to increase time by two minutes.	 x2	

Alarm

Your oven has an alarm function. If you leave food in the oven after cooking, the oven will "beep" 3 times and REMOVE FOOD will be displayed after 2 minutes.

If you do not remove the food at that time, the oven will "beep" 3 times after 4 minutes and 6 minutes.

CARE AND CLEANING

Disconnect the power supply cord before cleaning or leave the door open to inactivate the oven.
Before cleaning ensure oven cavity is cool.

OVEN INTERIOR:

- It is important to clean the interior of your microwave oven after each use.
- To clean the oven interior, use a mild detergent solution, such as washing-up liquid, with warm water on a soft cloth.
- Heat up your oven regularly by using the grill. Remaining food or fat splashed can cause smoke or bad smell.
- Food and liquid splashes will build-up on the oven walls and ceiling. If grease, fat and food debris is allowed to build-up in the oven interior it may overheat, smoke or even catch fire when next using the oven.
- Keep the **waveguide cover** clean at all times. The waveguide cover is constructed from a fragile material and should be cleaned with care (follow the cleaning instructions above).

NOTE: Excessive soaking may cause disintegration of the waveguide cover. The waveguide cover is a consumable part and without regular cleaning, will need to be replaced.

- Food will release steam during cooking and cause condensation inside the oven and door. It is important to wipe the oven dry. A build-up of condensation will eventually lead to rust forming on the oven interior.
- **Do not allow grease or dirt to build-up on the door seals or areas around the door. This may prevent the door from closing correctly and may cause a leakage of microwaves (follow the cleaning instructions below).**
- Ensure the accessories are cleaned after every use with a mild washing-up liquid solution and dried. This will prevent the build-up of grease and food debris. The accessories are dishwasher safe.
- **Clean the oven at regular intervals and remove any food deposits. Failure to maintain the oven in a clean condition could lead to a deterioration of the surface that could adversely affect the life of the appliance and possibly result in a hazardous situation.**

OUTER CABINET:

- Wipe the outside of the microwave oven with a mild detergent solution, such as washing-up liquid, with warm water on a soft cloth.
- The control panel must be wiped clean and dried with the door open, therefore inactivating the oven.

DOOR:

- To remove all trace of dirt, regularly clean both sides of the door, the door seals and adjacent parts with a soft, damp cloth.
- Do not use harsh abrasive cleaners or sharp metal scrapers to clean the oven door glass since they can scratch the surface, which may result in shattering of the glass.

NOTES:

- Never use spray cleaners, oven pads or abrasive scourers as these damage the surface of the oven.
- A steam cleaner should not be used.
- Take care not to let soapy water drip through the small holes in the oven walls and the cavity floor. Excess water spillage through these holes will cause damage to the oven interior.
- Slight tarnishing of the oven cavity, around the area of the grills, is likely to occur. This is normal and will not affect the ovens performance.

Warning:

Before cleaning, make sure the oven cavity, door, oven cabinet, accessories and especially the grills are completely cool.

SERVICE CALL CHECK

Check the following before calling service:

1. Does the display light? Yes_____ No_____
2. When the door is opened, does the oven lamp come on? Yes_____ No_____
3. Place one cup of water (approx. 250 ml) in a glass measure in the oven and close the door securely. Press the INSTANT COOK / START.
 - A. Does the oven lamp light? Yes_____ No_____
 - B. Does the cooling fan work? Yes_____ No_____

(Put your hand over the rear ventilation openings.)
 - C. Does the turntable rotate? Yes_____ No_____

(The turntable can rotate clockwise or counterclockwise. This is quite normal.)
 - D. Does the COOK indicator light? Yes_____ No_____
 - E. After one minute, did an audible signal sound? Yes_____ No_____
 - F. Is the water inside the oven hot? Yes_____ No_____
4. Remove water from the oven and programme the oven for 3 minutes on GRILL mode using top and bottom heaters.
 - A. Do the top and bottom heater symbols and COOK indicator light? Yes_____ No_____
 - B. After 3 minutes, do the both heaters become red? (Pay special attention to prevent burns when checking the bottom heater) Yes_____ No_____

If "NO" is the answer to any of the above questions, please check your wall socket and the fuse in your meter box. If both the wall socket and the fuse are functioning properly, CONTACT YOUR NEAREST SERVICE CENTRE APPROVED BY SHARP.

NOTE: 1. If time in the display is counting down very rapidly, check Demonstration Mode. (Please see page 23 for detail.)

2. The following thing is not trouble;

Each cooking mode has a maximum cooking time. If you operate the oven longer than the maximum time, the power will automatically be reduced. The table below shows the maximum time for each cooking mode.

Cooking mode	Maximum cooking time
Microwave 100% Cooking	20 min.
Grill Cooking	
Top heater	15 min.
Bottom heater	15 min.
Top and bottom heaters	Top heater 6 min. Bottom heater 6 min.
Mix Cooking Low Mix BTM Grill	Bottom heater 15 min.

SPECIFICATIONS

AC Line Voltage	: Single phase 230 - 240V, 50Hz.
AC Power Required	:
Microwave	— 1.50 kW
Grill	— 1.76 - 1.91 kW (Top and Bottom grill)
Convection	— 1.76 - 1.91 kW
Output Power	:
Microwave	— 900 W* (IEC test procedure)
Grill Heater	— 1100 - 1200 W (Top heater) 600 - 650 W (Bottom heater) 1700 - 1850 W (Top and bottom heater) 1700 - 1850 W (Convection)
Microwave Frequency	: 2450 MHz (Class B/Group 2)**
Outside Dimensions	: 520 mm(W) x 309 mm(H) x 486 mm(D)
Cooking Uniformity	: Turntable (325 mm in diameter) system
Weight	: Approx. 19 kg

* When tested in accordance with AS/NZS 2895.1.2007

** This is the classification of ISM (Industrial, Scientific and Medical) equipment described in the International Standard CISPR11.

GLOSSARY OF TERMS

SPOON MEASURES

1 tablespoon	=	20 mL
1 teaspoon	=	5 mL
1/2 teaspoon	=	2.5 mL
1/4 teaspoon	=	1.25 mL

LIQUID MEASURES

Cups	Metric	Imperial
1 cup	= 250 mL	= 8 fl. oz.
1/2 cup	= 125 mL	= 4 fl. oz.
1/3 cup	= 80 mL	= 2.5 fl. oz.
1/4 cup	= 60 mL	= 2 fl. oz.

DRY INGREDIENTS

Metric		Imperial
15 g	=	1/2 oz.
30 g	=	1 oz.
60 g	=	2 oz.
90 g	=	3 oz.
125 g	=	4 oz.
185 g	=	6 oz.
250 g	=	8 oz.
500 g	=	1 lb.
1000 g (1 kg)	=	2 lb.

CUP MEASURES

	Metric	Imperial
1 cup flour	140 g	4 1/2 oz.
1 cup sugar	250 g	8 oz.
1 cup brown sugar	185 g	6 oz.
1 cup icing sugar	185 g	6 oz.
1 cup butter/margarine	250 g	8 oz.
1 cup honey/golden syrup	375 g	12 oz.
1 cup fresh breadcrumbs	60 g	2 oz.
1 cup crushed biscuits	125 g	4 oz.
1 cup uncooked rice	220 g	7 oz.
1 cup mixed fruit	185 g	6 oz.
1 cup chopped nuts	125 g	4 oz.
1 cup coconut	90 g	3 oz.

NOTE

- Recipes in this book use standard metric equipment approved by the Australian Standards Association.
- All spoon and cup measures are level.
- All recipes in this book that include eggs require 55 g unless otherwise specified.

GRILLING CHART

FOOD	AMOUNT	STAGE	COOKING TIME AND POWER LEVEL	INSTRUCTIONS
Bacon	2 rashers 4 rashers		6 minutes on TOP and BOTTOM GRILL 8 minutes on TOP and BOTTOM GRILL	Place directly onto turntable
Sausages (thick, thin)	per/500g	1. 2.	10 minutes on TOP and BOTTOM GRILL 6 minutes on TOP and BOTTOM GRILL	Place directly onto turntable, pierce 3 times. Turn over after stage 1, drain juices, and pierce skin again 3 times. Continue cooking.
Steak/Chops	per/500g		14-15 minutes on TOP and BOTTOM GRILL	Place directly onto turntable.
Chicken Breasts	1-2 breasts	1. 2.	8 minutes on TOP and BOTTOM GRILL 8 minutes on TOP and BOTTOM GRILL	Place directly onto turntable. Turn over after stage 1. continue cooking.
Grilled Tomato	per/4 tomatoes halved	1. 2.	5 minutes on TOP and BOTTOM GRILL 5 minutes on TOP and BOTTOM GRILL	Place directly onto turntable. Spray with non-stick cooking spray. Turn over after stage 1, continue cooking.
Mixed Grill	per/1serve (includes: 1 steak, 1 chop, 1 sausage 1 rasher bacon and 1 egg)	1. 2.	10 minutes on TOP and BOTTOM GRILL 6 minutes on TOP and BOTTOM GRILL	Place directly onto turntable. Turn over after stage 1. Drain juices. Add egg, and continue cooking.
Toasted Sandwiches	1-2 (whole) (filling: cheese, ham, tomato)		5 minutes on TOP and BOTTOM GRILL	Place directly onto turntable.
OpenToasted Sandwiches	1-2 (open) (filling: cheese, ham, tomato)		5 minutes on TOP and BOTTOM GRILL	Place directly onto turntable.

REHEATING CONVENIENCE – FOOD CHART DEFROSTING CONVENIENCE

FOOD	WEIGHT	COOKING TIME AND POWER LEVEL	SPECIAL INSTRUCTIONS	STANDING TIME
Beverage (room temp.) 250 mL per cup	1 cup 2 cups	2 minutes on 100% 4 minutes on 100%	Stir after heating.	—
Canned Food (room temp.) (e.g. Spaghetti, Baked Beans)	1 cup 2 cups	5-5½ minutes on 50% 10 minutes on 50%	Place food in bowl. Cover plastic wrap or lid. Stir halfway.	1-2 minutes
Canned Soup (room temp.) 250 mL per cup	1 cup 2 cups	2-2½ minutes 100% 5 minutes on 100%	Stir halfway through cooking. Stir after heating.	—
Meat Pie (refrigerated) Individual 180 g each	1 pie 4 pies	2-2½ minutes on 50% followed by 4-4½ minutes on TOP/BOTTOM GRILL 6-6½ minutes on 50% followed by 6-6½ minutes on TOP/BOTTOM GRILL	Place directly on turntable, face side down. When oven stops, turn pie over and continue cooking.	1-3 minutes
Frozen Pasta Dinners (e.g. Lasagne)	300-500 g 500-750 g	5-7 minutes on 100% followed by 4-6 minutes on 50%, and 3-4 minutes on TOP/BOTTOM GRILL 7-9 minutes on 100% followed by 6-8 minutes on 50%, and 3-5 minutes on TOP/BOTTOM GRILL	Remove from foil container. Place in a dish same size. Allow to stand.	2-3 minutes
Pizza (refrigerated) 100 g per slice	1 slice 2 slices	1-2 minutes on 70% 1½-2½ minutes on 70%	Place on paper towel. Place directly on turntable. Allow to stand.	—
Dinner Plate (refrigerated) 350 g-400 g per serve	1 serve	6½-7 minutes on 50%	Slice potato. Cover plate with plastic wrap. Place directly on turntable. Allow to stand.	2 minutes
Casserole (refrigerated) 250 g per serve	1 serve 2 serves	6-7 minutes on 50% 11-12 minutes on 50%	Place in a bowl, cover with plastic wrap. Place directly on turntable. Stir halfway. Allow to stand, then stir.	1-2 minutes
Croissants (frozen)	1 2	40 sec-1 minute on 30% 1¼-1½ minutes on 30%	Place between paper towels. Place directly on the turntable.	—
Fruit Pie whole (frozen)	600 g	10 minutes on LOW MIX TOP GRILL followed by 2 minutes on TOP/BOTTOM GRILL	Keep in foil container. Place on turntable. Allow to stand. Remove from foil container. Place directly on the	2-3 minutes
Fruit Pie individual (frozen) 135 g each	1 2	1½ minutes on 50% followed by 4 minutes on TOP/BOTTOM GRILL	turntable. Allow to stand. Remove from foil container. Place on dinner plate. Allow	1-2 minutes
Danish Pastry whole (frozen)	400 g	4½ minutes on 70% followed by 5 minutes on TOP GRILL	to stand.	2-3 minutes

NOTE: Room Temperature +20°C
 Refrigerator Temperature +3°C
 Frozen Temperature -18°C

FROZEN VEGETABLE CHART

1. Place vegetables in a dish. Cover with a lid.
2. Allow to stand 1-3 minutes before serving.

VEGETABLE	WEIGHT	MICROWAVE TIME AT HIGH (100%)	SPECIAL PROCEDURES
Asparagus	500 g	7-8 minutes	
Beans (green, cut)	500 g	8-9 minutes	
Broccoli	500 g	8-8½ minutes	Break apart as soon as possible. Arrange with flower towards the centre.
Brussels sprouts	500 g	7½-8½ minutes	
Carrots (whole)	500 g	7-8 minutes	
Carrots (sliced)	500 g	8-9 minutes	
Cauliflower	500 g	8-10 minutes	Break apart as soon as possible. Arrange with flower towards the centre.
Corn (on cob)	4 pieces (500 g)	7½-8½ minutes	
(kernel)	500 g	8-9 minutes	Add 1 teaspoon of butter.
Peas (green)	500 g	8-9 minutes	
Spinach	250 g	5-6 minutes	Break apart as soon as possible.
Mixed Vegetables	500 g	9-10 minutes	Break apart as soon as possible.

RICE AND PASTA COOKING CHART

FOOD	OTHER INGREDIENTS	COOKING TIME
1 cup white rice	2 cups hot water	12-13 minutes on HIGH
1 cup brown rice	2 cups hot water	23-25 minutes on HIGH
1 cup macaroni	4 cups boiling water	11-13 minutes on HIGH
250 g spaghetti	4 cups boiling water	9-11 minutes on HIGH
250 g fettuccine	4 cups boiling water	9-11 minutes on HIGH
⅓ cup quick-cooking oats	¾ cup water/milk	1-2 minutes on HIGH
1 cup quick-cooking oats	2¼ cups water/milk	5½-6½ minutes on HIGH

Procedure:

Place rice/pasta/oats in a large bowl with water. Cook uncovered, stirring twice during cooking. Allow to stand 2 minutes.

GUIDE TO COOKING EGGS

SCRAMBLED EGG GUIDE

Place butter, eggs, and milk in a small bowl.

Beat with a fork until well combined and yolks of eggs are completely stirred in. Cook uncovered, stirring halfway through cooking.

Egg(s)	Butter	Milk	Cook MEDIUM HIGH (70%)
1	1 tsp.	3 tsp.	1¾ min.
2	1½ tsp.	3 tsp.	2¼ min.
3	2 tsp.	1 tbsp.	3¾ min.
4	2½ tsp.	⅓ cup	4 min.

FRESH VEGETABLE CHART

VEGETABLE	AMOUNT	MICROWAVE TIME AT HIGH (100%)	COOKING PROCEDURE
Asparagus	500 g	3-3½ minutes	Wash and place in a freezer bag. Allow to stand 3 minutes before serving.
Beans	500 g	5-5½ minutes	Cut into 4 cm pieces. Place in a dish with 1 tablespoon water. Cook covered. Allow to stand 3 minutes before serving.
Broccoli	500 g	3-3½ minutes	Cut into uniform florets. Arrange with flower towards centre. Cook covered. Allow to stand 3 minutes before serving.
Brussels sprouts	500 g	3-4 minutes	Arrange in a 23 cm flan dish. Arrange with stalk towards outside. Cook covered. Allow to stand 3 minutes before serving.
Cabbage	500 g	7-8 minutes	Shred and cook in a dish with 2 tablespoons water. Cook covered. Allow to stand 3 minutes before serving.
Carrots	500 g	4-6 minutes	Peel and slice. Arrange in a dish. Cook covered. Allow to stand 3 minutes before serving.
Cauliflower	500 g	5-6 minutes	Cut into uniform florets. Arrange with flower towards centre, with 1 tablespoon water. Cook covered. Allow to stand 3 minutes before serving.
Chokos	500 g (2)	5-6 minutes	Cut into quarters. Place in a 20 cm pie plate with 1 tablespoon of water. Cook covered. Allow to stand 3 minutes before serving.
Corn (on cob)	500 g (2)	7-8 minutes	Arrange in a dish with ¼ cup water. Cook covered. Turn over during cooking. Allow to stand 3 minutes before serving.
	1 kg (4)	15-17 minutes	Arrange in a dish with ⅓ cup water. Cook covered. Turn over during cooking. Allow to stand 5 minutes before serving.
Eggplant	500 g	4-5 minutes	Cut into 2 cm cubes. Place in a dish with 2 tablespoons water. Cook covered. Allow to stand 3 minutes before serving.

VEGETABLE	AMOUNT	MICROWAVE TIME AT HIGH (100%)	COOKING PROCEDURE
Mushrooms	500 g	4-5 minutes	Sliced or whole. Place in a dish with 2 teaspoons butter. Cook covered Allow to stand 3 minutes before serving.
Peas - Green - Snow	500 g	4-5 minutes	Cook in a dish with 1 teaspoon sugar and 1 tablespoon water. Cook covered. Allow to stand 1-5 minutes before serving.
	500 g	3-4 minutes	Remove string from pod. Cook in a dish with 1 tablespoon water. Cook covered. Allow to stand 3 minutes before serving.
Potatoes (jacket) (baked)	2 medium 4 small	5-5½ minutes	Pierce skin with a fork. Place on turntable. Turn over halfway through cooking. Allow to stand wrapped in foil 3 minutes.
	2 medium 4 small	5-6 minutes	Peel and quarter potatoes. Cook in a dish with ⅓ cup water. Cook covered. Allow to stand 3 minutes before serving.
Pumpkin	500 g	9-10 minutes	Peel and cut into serving-size pieces. Place in a dish and cook covered. Allow to stand 1-5 minutes before serving.
Spinach	500 g	5-6 minutes	Wash and shred. Cook, covered, in a dish with 2 tablespoons water. Allow to stand 3 minutes before serving.
Squash	500 g	4-5 minutes	Wash and place in a dish. Pierce whole squash with a fork. Cook covered. Allow to stand 3 minutes before serving.
Sweet Potato	500 g 1 kg	5-6 minutes 12-14 minutes	Peel and quarter potatoes. Cook, covered, in a dish with ½ cup water. Allow to stand 3-5 minutes before serving.
Tomatoes	500 g	2½-3½ minutes	Cut into quarters. Place in a dish. Season and cook covered. Allow to stand 3 minutes before serving.
Zucchini	500 g	4-5 minutes	Cut into uniform-size pieces. Place in a dish with 1 tablespoon covered water and 1 tablespoon butter. Cook covered. Allow to stand 3 minutes before serving.
Vegetables (canned)	500 g	2-4 minutes	Drain, reserving 2 tablespoons liquid. Place vegetables and reserved liquid in a dish and cook covered. Allow to stand 3 minutes before serving.

CHARTS

DEFROSTING FROZEN FOODS

Procedure:

1. Remove wrapping from meat.
2. Place frozen meat on a defrost rack. Shield.
3. Defrost using MEDIUM LOW/DEFROST power level (30%).
4. Halfway through defrosting, remove any defrosted portions, e.g. steak, mince. Turn over and shield. Continue defrosting.

DEFROSTING TIMES AND TECHNIQUES FOR MEAT AND POULTRY

CUT	MICROWAVE TIME	STANDING TIME
BEEF (Roast)	10-12 minutes/500 g	10-15 minutes
Steaks	8-9 minutes/500 g	5-10 minutes
Minced Beef	10-12 minutes/500 g	5-10 minutes
PORK (Roast)	7-9 minutes/500 g	10-15 minutes
Chops	6-8 minutes/500 g	7-9 minutes
Ribs	8-10 minutes/500 g	5-10 minutes
Minced Pork	10 minutes/500 g	5-10 minutes
LAMB (Roast)	10-12 minutes/500 g	10-15 minutes
Shoulder	8-10 minutes/500 g	10-15 minutes
Chops	8-10 minutes/500 g	7-9 minutes
POULTRY		
Turkey Pieces	8-10 minutes/500 g	10-15 minutes
Chicken (Whole)	10-12 minutes/500 g	9-11 minutes
Pieces	8-12 minutes/500 g	10-15 minutes
Duck	10-12 minutes/500 g	8-10 minutes

DEFROSTING TIMES AND TECHNIQUES FOR SEAFOOD, BREAD AND PIES

SEAFOOD	MICROWAVE TIME	STANDING TIME	PROCEDURES
Whole Fish	4-6 minutes/500 g	5 minutes	Shield head and tail with foil. Separate and rearrange halfway through defrosting.
Scallops	6-8 minutes/500 g	2-3 minutes	Separate as soon as possible.
Prawns	4-6 minutes/500 g	2-3 minutes	Separate as soon as possible.

BREAD	MICROWAVE TIME	PROCEDURES
2 slices	30 seconds	Place between paper towel directly on turntable.
4 slices	50 seconds	
Bread Rolls	30 seconds per roll	

PIES	MICROWAVE TIME	PROCEDURES
Individual	4-5 minutes	Place between paper towel on a rack. Allow to stand 5 minutes before reheating.
Whole	8-10 minutes	

APRICOT WHEATGERM CRUNCHIES

Makes18

125 g butter
³/₄ cup brown sugar, lightly packed
¹/₂ teaspoon vanilla essence
1 egg
¹/₂ cup self-raising flour, sifted
³/₄ cup wheatgerm
¹/₃ cup desicated coconut
¹/₃ cup rolled oats
125 g dried apricots, chopped
1¹/₂ cups cornflakes

1. Preheat oven to 200°C.
 2. Cream butter and sugar together until light and fluffy. Add vanilla and egg. Beat well.
 3. Mix in flour, wheatgerm, coconut, rolled oats, apricots and cornflakes.
 4. Shape tablespoonfuls of mixture into balls.
 5. Place on a greased pizza tray: flatten slightly with a fork.
 6. Place on the low rack. Bake for 12-14 minutes on CONVECTION 200°C.
- NOTE: Cook in the two batches.

CHOCOLATE CHIP COOKIES

Makes24

125 g butter
¹/₂ cup caster sugar
¹/₂ cup brown sugar, lightly packed
¹/₂ teaspoon vanilla essence
1 egg
1³/₄ cups self-raising flour, sifted
¹/₂ teaspoon salt
125 g choc bits
60 g walnut pieces

1. Preheat oven to 200°C.
 2. Cream butter, sugars and vanilla until light and fluffy. Beat in egg.
 3. Mix in flour, salt, choc bits and walnut pieces.
 4. Shape tablespoonfuls of mixture into balls. Place on a lightly greased pizza tray: press down slightly, allowing room for spreading.
 5. Place on the low rack. Bake for 12-14 minutes on CONVECTION 200°C.
- NOTE: Cook in the two batches.

MUESLI CUSTARD DELIGHT

Serves 6-8

300 g carton, sour cream
3 x 410 g can, sliced peaches, drained
1 cup butter cake mix
2 cups toasted muesli
¹/₂ cup coconut
175 g butter, melted

1. Spread sour cream evenly over base of a 20 cm glass pie plate. Sprinkle with drained peaches.
2. Combine butter cake mix, muesli, coconut and butter in a small bowl. Mix well.
3. Spread muesli mixture over peaches.
4. Cook on the low rack for 6 minutes on 100% and 4 minutes on TOP GRILL.
5. Stand 5 minutes before serving.

CHOCOLATE SELF-SAUCING PUDDING

Serves 4-6

60 g butter
1 1/2 cups self-raising flour
1/2 cup caster sugar
1/4 cup cocoa powder
3/4 cup milk
1 teaspoon vanilla essence
1 cup brown sugar
1/3 cup cocoa powder, extra
2 cups boiling water

1. Place butter in a large microwave safe pudding bowl; melt for 40 seconds on 100%.
2. Stir in flour, sugar, cocoa, milk and vanilla. Beat until smooth.
3. Combine brown sugar and extra cocoa and boiling water. Pour over pudding mixture.
4. Cook for 12 minutes on 100%. Allow to stand for 5 minutes before serving.
5. Serve hot with ice-cream.

BREAD AND BUTTER PUDDING

Serves 4-6

6 slices multigrain bread, crusts removed
butter
3 tablespoons caster sugar
1/4 cup sultanas
2 cups milk
1/2 teaspoon vanilla essence
3 eggs, lightly beaten
3 tablespoons brown sugar
1/4 teaspoon nutmeg

1. Spread bread with butter and cut into 2 cm cubes.
2. Place bread, sugar and sultanas in a 2 litre pudding bowl.
3. Heat milk and vanilla in a small microwave safe bowl for 3 minutes on 100%. Gradually whisk into eggs, then pour over bread mixture.
4. Sprinkle with brown sugar and nutmeg.
5. Cook on low rack for 25-28 minutes on 30%.
6. Allow to stand for 5 minutes before serving.

CARAMEL RICE PUDDING

Serves 4-6

1 cup arborio rice
3 cups water
395 g can condensed milk
20 g butter
1 tablespoon lemon juice
3 eggs, separated
1 tablespoon vanilla essence
2 tablespoons caster sugar
cinnamon sugar

1. Place rice and water in a large microwave safe glass bowl. Cook for 12-15 minutes on 100%, or until tender. Stir at halfway. Drain.
2. Mix condensed milk and butter together. Cook for 4-6 minutes on 100%, stirring every 20 seconds. (Caramel will boil over if not stirred.)
3. Stir cooked rice, lemon juice, egg yolks and vanilla essence into caramel. Pour into a 2-litre pudding bowl.
4. Beat egg whites until stiff, gradually beat in sugar. Spoon over rice pudding.
5. Sprinkle with cinnamon sugar. Cook for 3-5 minutes on 50% and 3 minutes on TOP GRILL.
6. Stand 5 minutes before serving.

CHOCOLATE MOUSSE

Serves 4

200 g cooking chocolate
2 tablespoons water
2 tablespoons rum
1/4 cup caster sugar
3 egg whites
300 mL carton thickened cream
extra cream for decoration
30 g chocolate, grated

1. Place chocolate, water and rum in a large microwave safe bowl. Melt for 30 seconds-1 minute on 100%. Stir in sugar.
2. Allow mixture to cool, then whip until aerated.
3. Beat egg whites until stiff peaks form.
4. Whip the cream until thick but not stiff. Fold cream and beaten egg whites into chocolate mixture.
5. Divide mixture evenly between four dessert glasses. Refrigerate until set.
6. Serve decorated with cream and chocolate shavings.

DESSERTS

CALIFORNIAN APPLE CRUNCH

Serves 6-8

800 g can pie apple
1½ cups White Wings buttercake mix
125 g hard butter, cut into thin slices
3 tablespoons brown sugar
3 tablespoons coconut
2 tablespoons crushed nuts
1 teaspoon cinnamon

1. Place pie apple in a shallow casserole dish.
2. Sprinkle evenly with dry cake mix.
3. Layer sliced butter over cake mix, covering completely.
4. Combine last 4 ingredients and sprinkle over sliced butter.
5. Cook on the low rack for 6 minutes on 100% and 3½ minutes on TOP GRILL.
6. Serve warm with whipped cream.

AUSTRALIAN FRUIT CAKE

Serves 4-6

1 kg mixed fruit	1 cup plain flour, sifted
1 cup brown sugar	1 teaspoon baking powder
250 g butter, chopped	salt
2 tablespoons brandy	½ teaspoon nutmeg
4 eggs, lightly beaten	1 teaspoon cinnamon
2 teaspoons parisienne essence	2 tablespoons brandy, extra

1. Preheat oven to 180°C.
2. Combine the first 4 ingredients in a large microwave safe bowl. Cover and cook for 5 minutes on 100%, stirring once. Allow to cool slightly.
3. Stir in eggs and parisienne essence, followed by dry ingredients.
4. Pour into a greased 20cm square cake tin.
5. Cook for 55 minutes on CONVECTION 180°C.
6. Using a 3 cm foil strip, place around the outside of cake container at halfway of cooking time. (This will prevent the outside from overcooking before the centre is cooked.)
7. Stand covered for 15 minutes before turning out.
8. Pour over extra brandy. Decorate with extra glacé fruits if desired.

BAKED APPLES

Serves 4

¾ cup walnuts	4 large apples
¼ cup brown sugar	2 tablespoons lemon juice
2 teaspoons mixed spice	30 g butter, melted

1. Place walnuts, sugar and mixed spice in a blender or food processor, process until nuts are finely chopped.
2. Peel and core apples, brush with lemon juice.
3. Brush apples with butter. Toss in walnut mixture until evenly coated.
4. Place in base of a 20 cm glass pie plate. Fill centre of apples with any remaining walnut mixture.
5. Cook for 4-6 minutes on 100% and 6-8 minutes on TOP GRILL. Allow to stand for 5 minutes.
6. Serve with whipped cream.

CHOCOLATE CAKE

175 g Nestlé Milk Choc Melts	2 eggs, lightly beaten
100 g butter	2½ cups self-raising flour, sifted
125 mL (½ cup) sour cream	1 cup brown sugar
1¼ cups warm water	½ teaspoon baking powder

ICING

250 g chocolate
2 tablespoons black coffee
50 mL sour cream

1. Place chocolate and butter in a large microwave safe bowl. Melt for 1-1½ minutes on 100%, stirring during cooking.
2. Add sour cream and water. Cook a further 1 minute on 100%. Mix well.
3. Stir in eggs, flour, sugar and baking powder.
4. Mix well, pour into a greased microwave safe gugelhopf container.
5. Cook for 13 minutes on 50% followed by 13 minutes on CONVECTION 130°C. Allow to stand 10 minutes before turning out.
6. Allow to cool before icing.

ICING

1. Melt chocolate and coffee for 1-2 minutes on 100%.
2. Add sour cream and beat well.

POTATOES PIZZAIOLA

Serves 4-6

4 large potatoes
20 g butter
1 clove garlic, crushed
400 g can tomatoes, roughly chopped
2 teaspoons fresh (or 1/2 teaspoon dried) oregano
ground black pepper

1. Peel and dice potatoes into 1.5 cm cubes, rinse and place in a large microwave safe bowl with 2 tablespoons of water, cover and cook for 8 minutes on 100%, stirring halfway through cooking. Drain.
2. In a small microwave safe bowl, combine butter and garlic and cook for 50 seconds on 100%.
3. Combine oregano and pepper to garlic mixture.
4. Add tomatoes and garlic mixture to potatoes, ensuring potatoes are well coated.
5. Cook, uncovered, for 10 minutes on 100%, stirring halfway through cooking.

GRILLED TOMATOES

Serves 4

2 tomatoes

1. Cut tomatoes in half.
2. Place directly onto turntable.
3. Cook for 5 minutes on TOP and BOTTOM GRILL.
4. Turn over, cook for 5 minutes on TOP and BOTTOM GRILL.

SOY AND SESAME GREEN BEANS

Serves 4

300 g green beans
1 tablespoon soy sauce
1 tablespoon olive oil
sesame seeds, to garnish

1. Cut the ends off beans and rinse well.
2. Place beans in a large square casserole dish. Pour soy sauce and oil and toss well.
3. Cook on the low rack for 12 minutes on LOW MIX TOP GRILL, mixing halfway through.
4. Sprinkle with sesame seeds.

PUMPKIN SALAD

Serves 6-8

1 kg pumpkin, peeled and cubed
3/4 cup walnuts
6 shallots, chopped
1/4 cup finely chopped parsley
1/2 teaspoon nutmeg
ground black pepper
1 cup mayonnaise

1. Place pumpkin in large microwave safe bowl, add 2 tablespoons of water, cover and cook for 12-14 minutes on 100% or until pumpkin is just cooked, but still firm.
2. Refresh by running cold water over pumpkin. Drain and chill.
3. Mix walnuts, shallots, parsley, nutmeg and pepper with mayonnaise.
4. Fold mayonnaise mixture gently into the pumpkin. Serve chilled.

ROAST VEGETABLES

Serves 4

300 g baby potatoes, cut in half
300 g sweet potatoes, peeled
250 g parsnips, peeled
2 tablespoon olive oil
1 teaspoon oregano
1 teaspoon parsley
pinch of salt

1. Cut sweet potato lengthwise and into 2 cm chunks. Cut parsnips into quarters.
2. Add potatoes, sweet potatoes and parsnips into a large shallow square casserole dish. Cook, covered for 8-10 minutes on 100%, drain.
3. Combine oil, oregano, parsley and salt. Pour over vegetables, coat evenly.
4. Cook, uncovered for 26 minutes on TOP and BOTTOM GRILL, mixing half way through.

SQUASH WITH YOGHURT

Serves 4-6

500 g squash
200 g carton natural yoghurt
2 teaspoons seeded mustard
ground black pepper

1. Wash and trim squash. Slice thinly, place in a microwave safe glass pie plate.
2. Cover and cook for 4-6 minutes on 100%, or until just tender. Drain juice prior to adding yoghurt.
3. Combine yoghurt, mustard and pepper and gently fold through the squash.
4. Serve hot.

HONEY GINGERED VEGETABLES

Serves 6

1/2 cup salad dressing
2 teaspoons grated ginger
2 tablespoons honey
1 tablespoon soy sauce
2 tablespoons lemon juice
500 g butternut pumpkin, peeled and thinly sliced
1 cup frozen beans
2 zucchinis, sliced
1/2 cup pecans

1. In a large microwave safe bowl, heat dressing, ginger, honey, soy sauce and lemon juice for 3-4 minutes on 100%.
2. Add pumpkin and cook covered 4-6 minutes on 100%, until just tender.
3. Stir in beans and zucchinis, cook covered a further 6-7 minutes on 100%.
4. Spoon onto a serving plate. Sprinkle with pecans.

GRILLED ZUCCHINI WITH FETA AND MINT

Serves 2

300 g zucchini
approximately 100 g feta
olive oil, to brush
handful of fresh mint finely chopped

1. Cut zucchini in half, and then cut lengthwise to make 4 slices.
2. Brush each side of the zucchini with olive oil.
3. Arrange zucchini on the high rack in a circle. Cook for 20 minutes on TOP GRILL, turning half way through.
4. Place zucchini in a bowl. Add crumbled feta and garnish with fresh mint.

POTATO, AVOCADO AND ONION SALAD Serves 6

1 kg small new potatoes
1 large onion, sliced into rings
1 tablespoon caster sugar
20 g butter
1/2 cup mayonnaise
150 mL sour cream
black pepper
1 large avocado, cubed
chives, to garnish

1. Cut unpeeled potatoes in half. Place in a large microwave safe bowl and cover with water. Cook, covered with a lid, for 18-20 minutes on 100% (potatoes should be tender but holding their shape). Drain.
2. Place onion rings, caster sugar and butter in a microwave safe glass bowl. Cook for 4-5 minutes on 100%, stirring halfway through.
3. Combine mayonnaise, sour cream and black pepper. Pour over potatoes.
4. Toss in onions and avocado; sprinkle with chives.
5. Chill serve.

STUFFED MUSHROOMS Serves 4

2 slices white bread	1 tablespoon Worcestershire sauce
2 rashers bacon, chopped	1 tablespoon chopped fresh parsley
2 shallots, finely chopped	8 large flat mushrooms, stalks removed (approx. 80g each)
1/2 cup grated cheddar cheese	20 g butter
1 tablespoon grated parmesan cheese	

1. Process the bread into fine crumbs. Set aside.
2. Place the bacon between sheets of paper towel. Cook for 2 minutes on 100%.
3. Place the shallots and bacon in a small microwave safe glass bowl. Cook for 1 minute on 100%.
4. Mix the breadcrumbs, bacon, shallot, cheeses, Worcestershire sauce and parsley until well combined.
5. Spoon the mixture into the mushrooms.
6. Cut the butter into 8 equal cubes and place on each mushroom.
7. Place the filled mushrooms directly onto the turntable. Cook for 4 minutes on BOTTOM GRILL and then 8 minutes on TOP and BOTTOM GRILL.

CHUNKY VEGETABLE SOUP Serves 6

1/2 cup oil	2 zucchinis, chopped
60 g butter	1/4 cabbage, shredded
2 onions, peeled and chopped	3 cups beef stock
3 carrots, finely chopped	2 x 400 g cans peeled tomatoes
1 potato, peeled and chopped	salt and pepper
3 sticks celery, chopped	parmesan cheese

1. Combine oil, butter and onion in a large casserole dish. Cook for 2-3 minutes on 100%.
2. Add carrots and potato. Cover and cook for 5 minutes on 100%.
3. Add celery, zucchini and cabbage. Cover and cook for 3 minutes on 100%. Add stock, undrained tomatoes, salt and pepper. Cook, covered, for 20-25 minutes on 100%, stirring occasionally.
4. Serve hot, topped with parmesan cheese.

STUFFED BAKED POTATOES Serves 4

4 large potatoes
1/4 cup milk
1/4 cup cream
1/2 cup grated cheddar cheese
30 g butter
2 teaspoons dried parsley flakes
1/4 teaspoon dry mustard
paprika

1. Pierce potatoes with a fork; place on turntable. Cook for 10-12 minutes on 100%. Stand in foil for 5 minutes.
2. Cut a thin slice from top of each potato; scoop out cooked potato with a spoon, leaving a thin shell.
3. Stir milk, cream, half the cheese, butter, parsley, mustard and potato. Mix well until no lumps remain.
4. Spoon mixture into each potato shell. Place on the low rack.
5. Sprinkle with remaining cheese and paprika. Cook for 2-3 minutes on 100% and 8 minutes on TOP GRILL.

VEGETABLES

CAULIFLOWER AU GRATIN

Serves 4-6

500 g cauliflower florets
30 g butter
2 tablespoons flour
1 cup milk
1 teaspoon mustard
1/2 cup grated cheese
paprika

1. Place cauliflower in a glass pie dish. Cover and cook on the low rack for 4-6 minutes on 100%, until tender. Drain.
2. Melt butter in a microwave safe glass jug for 40-50 seconds on 100%.
3. Stir in flour. Cook for 1 minute on 100%.
4. Gradually stir in milk and mustard. Cook for 2-2 1/2 minutes on 100%, stirring every minute.
5. Stir in cheese until melted.
6. Pour over cauliflower. Sprinkle with paprika.
7. Cook for 6-8 minutes on TOP GRILL.

EASY HOME-MADE RICE RISOTTO

Serves 6-8

1 onion, diced
60 g butter
4 rashers bacon, diced (optional)
(or 1 cup cooked chicken or ham)
3 chicken or beef stock cubes
2 cups boiling water
1 cup long-grain rice, well washed
1 cup assorted finely chopped vegetables,
e.g. carrots, zucchinis, mushrooms

1. Place onion, butter and bacon in large casserole dish. Cook for 3-4 minutes on 100%. Stir well.
2. Dissolve stock cubes in boiling water; add to onion and bacon. Add all other ingredients. Cover with a lid and cook for 16-18 minutes on 100%. Do not stir while cooking.
3. At the end of this time, all the liquid will have been absorbed.
4. Leave to stand for 5 minutes and stir with a fork before serving.

SCALLOPED POTATOES

Serves 4-6

3 large potatoes (approx. 500 g), peeled and sliced thinly
1/4 cup water
1 large onion, sliced
200 g carton light sour cream
1 egg
90 g cheddar cheese, finely grated
paprika

1. Place potatoes in a round or oval shallow dish, add water, cover, and cook for 6-8 minutes on 100% on the low rack.
2. Drain off water.
3. Arrange sliced onion over potatoes.
4. Combine sour cream and egg. Mix well and pour over potatoes. Sprinkle with cheese and a little paprika if desired.
5. Cook uncovered, 6 minutes on HIGH MIX TOP GRILL and 8-10 minutes on TOP GRILL.

HONEY CARROTS

Serves 4

500 g carrots, sliced lengthwise
60 g butter
1 tablespoon honey

1. Combine all ingredients in a casserole dish.
2. Cover and cook for 6-8 minutes on 100%.
3. Stand covered for 3 minutes before serving.

VEGETABLE PLATTER

Serves 4

200 g carrots, sliced
200 g broccoli, cut into florets
100 g zucchinis, sliced

1. Arrange vegetables in a glass pie dish with the harder vegetables positioned around the outside and the softer vegetables in the centre.
2. Cover with plastic wrap.
3. Cook for 4 1/2-5 1/2 minutes on 100%.
4. Stand covered for 3 minutes before serving.

OYSTERS KILPATRICK

Serves 1-2

3 rashers bacon, chopped
1 dozen oysters in the half shell
2 tablespoons worcestershire sauce

1. Place bacon in a small microwave safe bowl, cover and cook for 3 minutes on 100%.
2. Sprinkle bacon over top of oysters, and add sauce. Place on the high rack and cook for 8-10 minutes on TOP GRILL.

PRAWN CUTLETS

Serves 4

16 green king prawns
1 cup breadcrumbs
1/2 cup plain flour
1 egg (lightly beaten)
2 tablespoons olive oil

1. Peel prawns, leaving tails intact and devein.
2. Cut prawn down the back, flatten slightly with hand to form a cutlet shape.
3. Dust prawns lightly with flour, dip into egg, and coat with breadcrumbs.
4. Spray turntable with non-stick spray.
5. Place directly onto turntable, cook for 7 minutes on BOTTOM GRILL.
6. Turn over and lightly brush each side with oil, cook for a further 7 minutes on BOTTOM GRILL.
7. Serve with tartare sauce.

SQUID IN TOMATO AND WINE SAUCE Serves 6

500 g squid tubes
1 tablespoon soy sauce
1 tablespoon cornflour
1 tablespoon olive oil
1 shallot, chopped

1 clove garlic, crushed
400 g can tomato, diced
1/4 cup dry white wine
2 tablespoons tomato paste
1 tablespoon chopped fresh basil

1. Cut squid tubes into rings. Sprinkle with combined soy sauce and cornflour. Refrigerate for 30 minutes.
2. Combine oil, onion and garlic in a large microwave safe bowl. Cook for 1 minute on 100%.
3. Stir in tomatoes, white wine and tomato paste. Cook for 5-6 minutes on 100%.
4. Stir in squid. Cook for 10-12 minutes on 50%, tossing every minute until squid is firm.
5. Sprinkle with fresh basil.
6. Serve with French bread and tossed salad.

BOUILLABAISSE Serves 8

6 mussels
750 g scallops
500 g green prawns,
peeled and deveined
500 g firm fish fillets,
cut into bite-size pieces
5 crab sticks, sliced
6 oysters
1 tablespoon olive oil
1 onion, finely chopped

1 clove garlic, crushed
1 1/2 cups fish stock
425 g can tomatoes, puréed
1/2 cup white wine
2 tablespoons tomato paste
1/4 teaspoon turmeric
grated rind of 1 lemon
salt and pepper
1/4 cup chopped fresh basil

1. Wash and clean seafood.
2. Cook oil, onion and garlic in a large casserole dish for 1-2 minutes on 100%.
3. Stir in fish stock, tomatoes, white wine and tomato paste. Cover and cook for 8 minutes on 100%, stirring halfway through cooking.
4. Place mussels into hot stock, cover and simmer for 8-10 minutes on 70% or until mussels open. Discard any which stay closed.
5. Stir in scallops, prawns, turmeric, lemon rind, salt and pepper. Cover and cook for 5-6 minutes on 70%.
6. Stir in fish fillets, crab sticks and oysters. Cover and cook for 14-16 minutes on 70% or until fish flakes.
7. Garnish with fresh basil.

CURRIED SCALLOPS Serves 4

40 g butter
1 onion, finely chopped
1/2 teaspoon ground cumin
1/2 teaspoon ground coriander
1/2 teaspoon ground turmeric
1/2 lemon, juiced
1/4 cup cream
500 g scallops
1 tablespoon fresh coriander

1. In a large microwave safe glass bowl, combine the butter, onion, cumin, ground coriander, turmeric and lemon juice. Cover and cook for 5-6 minutes on 100%.
2. Stir in the cream, blending well.
3. Add the scallops. Cook for 8-10 minutes on 50%, stirring every 2 minutes.
4. Serve with rice and garnish with fresh coriander.

SEAFOOD LASAGNE

Serves 6-8

125 g butter
1½ cups plain flour
1 teaspoon dry mustard
4 cups milk
500 g seafood marinara
1 packet fresh lasagne sheets
1½ cups grated tasty cheese

1. Melt butter in a large microwave safe bowl for 1-2 minutes on 100%.
2. Stir in flour and dry mustard. Cook for 1½ minutes on 100%.
3. Gradually stir in milk. Cook for 6-8 minutes on 100% or until sauce is thick. Stir every 2 minutes.
4. Stir in marinara. Cook for 4-6 minutes on 50%.
5. Layer sheets over base of a 2 litre square casserole dish.
6. Cover noodles with ⅓ marinara sauce and ½ cup cheese. Repeat process, ending with marinara sauce and cheese.
7. Cook for 16-19 minutes on HIGH MIX TOP GRILL and 3 minutes on TOP GRILL.
8. Allow to stand for 10 minutes before serving.

SESAME PRAWNS

Serves 4

24 green king prawns (approx. 1 kg)
1 clove garlic
1 tablespoon ketjap manis
2 teaspoons sesame oil
1 tablespoon sesame seeds
6 bamboo skewers

1. Peel prawns, leaving tails intact, and devein. Place in a shallow dish.
2. Combine garlic, ketjap manis, sesame oil and sesame seeds. Pour over prawns. Cover and refrigerate for 1-2 hours.
3. Thread 3-4 prawns onto each bamboo skewer. Coat in sesame seeds.
4. Place skewers on the high rack. Cook for 15-17 minutes on TOP GRILL. Turn over halfway.
5. Serve with satay sauce and rice.

CRAB MORNAVY

Serves 6

60 g butter
⅓ cup plain flour
½ teaspoon dry mustard
2 cups milk
1 onion, finely chopped
2 x 170 g cans crab meat, drained
salt and pepper
½ cup finely grated cheese
2 tablespoons cornflake crumbs

1. In a large microwave safe bowl, melt butter for 1-1½ minutes on 100%. Stir in flour and mustard. Cook for a further 1 minute on 100%.
2. Gradually stir in milk. Cook for 4-5 minutes on 100%, stirring every 2 minutes.
3. Stir in onion, crab meat, salt and pepper and ¼ cup cheese.
4. Place into a 1 litre serving dish. Sprinkle with cornflake crumbs and remaining cheese.
5. Cook for 13-15 minutes on LOW MIX TOP GRILL.
6. Serve with fresh garden salad.

GARLIC MUSSELS

Serves 4 as entree

500 g mussels
1 cup wine
2 cups water
1 clove garlic, crushed
GARLIC BUTTER
40 g butter
2 tablespoons olive oil
2 cloves garlic, crushed
pepper

1. Wash mussels under running water; remove all traces of mud, seaweed and barnacles with brush or knife; remove beards. Discard cracked, broken or open mussel shells.
2. In a large microwave safe bowl, cover mussels with wine, water and garlic. Cook for 16-18 minutes on 50% or until open, removing from liquid as they open. Discard unopened mussels.

GARLIC BUTTER

1. Melt butter in a microwave safe jug for 30 seconds on 100%, add oil, garlic and pepper. Pour ½ garlic sauce over mussels; toss well.
2. Arrange mussels in serving bowl and pour remaining sauce over mussels.

SCALLOPS IN BLACK BEAN SAUCE Serves 4

1 tablespoon oil
2 spring onions, finely sliced
1 chilli, seeded and finely chopped
1 tablespoon cornflour

2 teaspoons sugar
1 tablespoon soy sauce
2 tablespoons black bean sauce
500 g scallops

1. In a large microwave safe bowl combine oil, onions and chilli; cook for 1 minutes on 100%.
2. Stir in cornflour, sugar, soy sauce and black bean sauce.
3. Add scallops; stir well.
4. Cook for 10-12 minutes on 50%, stirring twice during cooking.

CRISPY MARINATED CRAB STICKS Makes 24

12 crab sticks
2 tablespoons lemon juice
1 clove garlic, crushed
2 teaspoons grated ginger

1 teaspoon sugar
1/4 cup oil
1 tablespoon soy sauce
8 rashers bacon, rind removed

1. Cut crab sticks in half.
2. Place lemon juice, garlic, ginger, sugar, oil and soy sauce in a bowl. Mix well.
3. Place crab sticks in marinade and allow to stand 2 hours. Drain.
4. Cut bacon into 3 pieces. Wrap each piece around each crab stick; secure with a toothpick.
5. Place on the low rack.
6. Cook for 14-16 minutes on LOW MIX TOP GRILL.
7. Cook for 1½ minutes on TOP GRILL.

TAGLIATELLE AND CRAB SALAD Serves 6-8

500 g tagliatelle pasta
12 crab sticks, sliced
1/2 cup toasted pine nuts
6 shallots, chopped

1/2 cup French dressing
300 mL cream
salt and pepper

1. Place tagliatelle into a large microwave safe bowl. Cover with hot tap water. Cook for 14-16 minutes on 100%, until tender. Drain well.
2. Toss sliced crab sticks, pine nuts and shallots through pasta.
3. Mix French dressing and cream. Season with salt and pepper. Pour over pasta. Toss well.

PRAWN CREOLE Serves 4

20 g butter
1 medium onion, chopped
1 capsicum, chopped
1 stick celery, sliced
2 tablespoons flour
400 g can whole tomatoes
1/2 cup tomato paste

1 cup chicken stock
1 tablespoon parsley
2 teaspoons sugar
1/2 teaspoon salt
1/2 teaspoon chilli powder
500 g green prawns, peeled and deveined

1. In a large microwave safe bowl, combine butter, onion, capsicum and celery. Cook for 4-5 minutes on 100%.
2. Stir in flour, tomatoes, tomato paste, chicken stock, parsley, sugar, salt and chilli powder; mix well.
3. Cook, uncovered, for 5 minutes on 100%, stirring once.
4. Add prawns and cook for 18-20 minutes on 50%, stirring twice. Serve with rice.

SEAFOOD

MARINATED BABY OCTOPUS

Serves 2

400 g baby octopus
2 tablespoons balsamic vinegar
1 clove garlic, crushed
2 tablespoons chopped fresh coriander
1 fresh chilli seeded and chopped
extra coriander, to garnish
lime wedges, to serve

1. Rinse the octopus thoroughly, making sure the heads are clean. Large pieces of octopus should be cut into smaller pieces to ensure even cooking.
2. In a large bowl, combine balsamic vinegar, garlic, coriander and chilli.
3. Transfer the rinsed octopus to the bowl containing the sauces. Cover and refrigerate for at least 2 hours, or overnight.
4. Arrange the marinated octopus in a shallow microwave safe glass dish. Place on the high rack. Cook for 6-8 minutes on TOP and BOTTOM GRILL, turning half way through; a shorter or longer cooking time may be necessary depending on your preference of texture.
5. Garnish with the coriander leaves and serve with the lime wedges or salad greens.

CHEESY SALMON CANNELLONI

Serves 4-6

ROLLS

120 g cannelloni
250 g ricotta cheese
90 g cheddar cheese, grated
salt and pepper to taste
2 eggs, lightly beaten
210 g can red salmon, drained
2 teaspoons lemon juice
2 tablespoons cheddar cheese, extra

1. Combine ricotta cheese, cheddar cheese, salt and pepper, eggs, salmon and lemon juice; mix well.
2. Place a spoonful of salmon mixture into each cannelloni. Place in a single layer in a shallow heat-proof dish.

SAUCE

1. Combine cornflour with 2 tablespoons of tomato purée to form a smooth paste. Stir in remaining purée and parsley.
2. Pour tomato purée over salmon rolls and cook covered for 16-18 minutes on 70% or until cannelloni is tender.
3. Sprinkle the extra cheese over the pasta. Cover and cook for 2-3 minutes on 70%.

GARLIC PRAWNS

Serves 4

24 green king prawns
40 g butter
3 cloves garlic, crushed
 $\frac{1}{3}$ cup olive oil
1 tablespoon chopped parsley

1. Peel and devein prawns, leaving tails intact.
2. Combine butter and garlic in a large microwave safe bowl. Cook for 1 $\frac{1}{2}$ -2 minutes on 100%.
3. Stir in oil and prawns.
4. Cook for 4-6 minutes on 50%, tossing every 2 minutes. Sprinkle with parsley.
5. Serve in individual dishes with garlic bread.

CHICKEN CACCIATORE

Serves 6

6 chicken thighs
1/4 cup flour
1 tablespoon Season All salt
1 onion, sliced
30 g butter
1 clove garlic, crushed

2 tablespoons tomato paste
440 g can peeled tomatoes
2 chicken stock cubes
1/2 cup white wine
1 green capsicum, thinly sliced
6 black olives, sliced

1. Place chicken, flour and season all salt into a freezer bag. Toss until chicken is coated.
2. Combine chicken thighs, remaining flour, onion, butter, garlic, tomato paste, juice from tomatoes, stock cubes and white wine in a 5 litre casserole dish.
3. Cover and cook for 26-28 minutes on 70%. Stir 2-3 times during cooking.
4. Add capsicum and chopped tomatoes. Cover and cook a further 10-12 minutes on 70%.
5. Garnish with black olives.

CRUNCHY CAMEMBERT CHICKEN

Serves 6

125 g camembert cheese, finely chopped
2 rashers bacon, finely chopped
1/2 cup toasted, slivered almonds
2 tablespoons seeded mustard
No.15 chicken
2 tablespoons honey

1. Mix camembert, bacon, almonds and 1 tablespoon mustard together in a small bowl.
2. Press camembert mixture between skin and flesh of chicken. Tie chicken legs together.
3. Mix remaining mustard and honey. Brush over chicken.
4. Place breast side down on the low rack, cook for 12-14 minutes on HIGH MIX TOP GRILL.
5. Turn chicken over and brush with remaining mixture.
Cook for a further 12-14 minutes on HIGH MIX TOP GRILL.
6. Allow to stand covered with foil for 10 minutes before serving.

CHICKEN FILLET BURGERS

Serves 4

4 chicken breast fillets (approx. 500 g)
2 tablespoons flour
1 teaspoon paprika
2 slices ham, sliced in half
2 slices pineapple, sliced in half
4 slices processed cheese

1. Place chicken, flour and paprika into a freezer bag. Toss until chicken is coated.
2. Place chicken fillets on the low rack.
3. Cook for 8-10 minutes on 70%, turning over halfway through cooking.
4. Place ham and pineapple slices on top of each chicken piece.
5. Top with cheese.
6. Cook for 10 minutes on TOP GRILL.
7. Serve on a hamburger bun with lettuce and tomato.

ROAST CHICKEN

Serves 4

Approx. 1.5 kg chicken
30 g butter, melted
Season All salt

1. Wash and dry chicken well.
2. Tie legs of chicken together with string.
3. Place breast-side down on the low rack.
4. Baste with butter and sprinkle with Season All salt.
5. Cook for 12-14 minutes on HIGH MIX TOP GRILL and 7 minutes on TOP GRILL.
6. Turn chicken over. Baste with butter and sprinkle with Season All salt.
7. Cook a further 12-14 minutes on HIGH MIX TOP GRILL and 7 minutes on TOP GRILL.
8. Allow to stand covered with foil for 10 minutes before serving.

CHICKEN AND MACARONI BAKE Serves 4-6

1 cooked chicken (approx. 1.5 kg)
20 g butter, melted
2 cups macaroni
1/4 cup plain flour
300 mL sour cream
1 cup chicken stock
1 cup grated cheese
1 tablespoon chopped parsley

1. Place macaroni in a large microwave safe bowl. Cover with hot water. Cook for 16 minutes on 100%, stirring half way through or until pasta is tender. Drain.
2. Remove flesh from chicken.
3. Mix together plain flour, sour cream and chicken stock.
4. Combine chicken, macaroni and sauce mixture in a 3 litre casserole dish. Sprinkle with cheese and cook for 10-12 minutes on 70% and 4-5 minutes on TOP GRILL.
5. Sprinkle with parsley.
6. Serve immediately with a tossed salad.

APRICOT CHICKEN Serves 4

4 chicken thighs
1 packet French onion soup
2 tablespoons plain flour
125 mL apricot nectar
825g can apricot halves, drained

1. Toss chicken in combined French onion soup and plain flour.
2. Place in a 3 litre casserole dish and put on low rack.
3. Cook chicken for 13-15 minutes on 70%. Turn chicken over.
4. Pour over apricot nectar and apricots.
5. Cook, covered, for 13-15 minutes on 70%.
6. Serve hot with pasta.

CHEESE AND HERB CHICKEN LEGS Serves 4

2 tablespoons chopped parsley
1 teaspoon basil
2 teaspoons tarragon
2 teaspoons dill
2 teaspoons mustard powder
1 teaspoon paprika
salt and pepper
1 teaspoon sesame seeds
90 g butter, melted
8 large chicken drumsticks
125 g country cheese biscuits, crushed

1. Mix parsley, basil, tarragon, dill, mustard powder, paprika, salt and pepper, sesame seeds and one-third of butter together in a small bowl.
2. Using a sharp knife, lift skin back from the chicken drumsticks.
3. Spread a teaspoon of herb mixture between skin and chicken.
4. Brush chicken with remaining butter, coat with biscuit crumbs.
5. Place on the low rack, cook for 16-18 minutes on HIGH MIX TOP GRILL and 4-5 minutes on TOP GRILL.
6. Turn over and cook for a further 6 minutes on TOP GRILL.
7. Allow to stand for 5-10 minutes before serving.

HONEY CHICKEN LEGS Serves 4

250 mL soy sauce
4 tablespoons honey
1 tablespoon lemon juice
1 clove garlic, crushed
1/2 teaspoon freshly grated ginger
2 tablespoons oil
8 large chicken legs
sesame seeds

1. Combine soy sauce, honey, lemon juice, garlic, ginger and oil in a small bowl. Pour over chicken and marinate for 2-3 hours.
2. Arrange chicken legs on the low rack. Cook for 18-20 minutes on HIGH MIX TOP GRILL and 8 minutes on TOP GRILL.
3. Turn chicken over and cook for a further 8 minutes on TOP GRILL.
4. Sprinkle with sesame seeds.

CHICKEN PROVENCALE

Serves 4

1/2 cup white wine
425 g can peeled tomatoes
1 large onion, chopped
1 apple, peeled and chopped
1/2 cup black olives

1 teaspoon curry powder
1.25 kg chicken pieces, skin removed (or 4 marylands)
250 g button mushrooms, sliced
chopped parsley

1. In a large jug combine wine, tomatoes, onion, apple, olives and curry powder. Mix well.
2. Arrange chicken pieces in a casserole dish. Pour over sauce. Cover and cook for 27-29 minutes on 70%. Stir once during cooking.
3. When oven stops, stir in mushrooms. Cover and cook for a further 5-7 minutes on 70%.
4. Sprinkle with parsley.

CHICKEN TERRINE

Serves 6-8

60 g butter
6 shallots, chopped
1/2 cup flour
1 cup chicken stock
1 cup milk
1/4 teaspoon tabasco sauce
pepper

250 g cream cheese, softened
1 cooked chicken, chopped
2 teaspoons green peppercorns, chopped
3 teaspoons gelatine
1/2 cup water
6 rashers bacon

1. Melt butter in a microwave safe bowl for 40 seconds on 100%. Add shallots and flour. Cook for 1 minute on 100%.
2. Gradually stir in stock and milk. Cook for 4-5 minutes on 100%, stirring every 2 minutes.
3. Stir in tabasco sauce and pepper.
4. Beat cream cheese. Gradually stir in the sauce. Add chicken and peppercorns.
5. In a small microwave safe bowl dissolve gelatine in water. Cook for 40 seconds - 1 minute on 100%; add to chicken mixture.
6. Line 25 cm x 11 cm loaf dish with paper towel and place bacon across paper towel.
7. Cover with paper towel and cook for 3-5 minutes on 100%.
8. Remove top layer of paper towel.
9. Pour in chicken mixture. Refrigerate overnight.
10. Turn out and slice. Serve with Melba toast.

WHOLEMEAL CHICKEN

Serves 4

1 kg chicken thighs
100 g butter, melted
1/4 cup finely grated parmesan cheese
1 cup wholemeal flour
1 tablespoon chopped parsley

1. Dip chicken thighs in butter.
2. Coat with combined cheese, flour and parsley.
3. Place on the low rack. Cook for 14 minutes on HIGH MIX TOP GRILL and 5-6 minutes on TOP GRILL.
4. Turn over and cook for a further 8-9 minutes on TOP GRILL.

TANDOORI CHICKEN

Serves 4-6

2 fresh red chillies, seeded
1 onion
2 cloves garlic, crushed
2 teaspoons crushed ginger
2 tablespoons lemon juice
2 teaspoons ground cumin
1/2 teaspoon black pepper
3 teaspoons ground coriander
2 whole cloves

1/4 teaspoon cinnamon
1 bay leaf
1/2 teaspoon turmeric
1/2 teaspoon nutmeg
2 teaspoons paprika
6 chicken thighs, skin removed
1 tablespoon vinegar
200 g low-fat yoghurt

1. Purée chillies, onion, garlic, ginger and lemon juice until smooth.
2. Mix cumin, pepper, coriander, cloves, cinnamon, bay leaf, turmeric, nutmeg and paprika in a small microwave safe bowl.
3. Cook for 1 minute on 100%, stirring halfway through cooking. Remove bay leaf and cloves.
4. Combine chilli mixture and spices together. Spread over chicken.
5. Sprinkle with vinegar and pour over yoghurt. Cover and marinate overnight, stirring occasionally.
6. Place on the low rack, cook for 20-22 minutes on HIGH MIX TOP GRILL and 9 minutes on TOP GRILL.
7. Turn over and cook for 10 minutes on TOP GRILL.
8. Serve with boiled rice.

POULTRY

CHICKEN IN A POT

Serves 4-6

1.5 kg chicken thighs
1/4 cup plain flour
2 rashers bacon, finely chopped
1 green capsicum, diced
1 onion, finely chopped
400 g can peeled tomatoes

2 tablespoons tomato paste
2 chicken stock cubes
1 tablespoon soy sauce
salt and pepper
200 g mushrooms, sliced

1. Toss chicken thighs in flour.
2. Combine all ingredients, except mushrooms, in a 3 litre casserole dish.
3. Cover and cook on low rack for 30 minutes on 70%. Stir 2-3 times during cooking.
4. Add mushrooms. Cook, uncovered, a further 5-7 minutes on 70%.

CHICKEN FRICASSEE

Serves 4

1 large cooked chicken
60 g butter
3 tablespoons flour
2 cups chicken stock
1 egg yolk

1/4 cup cream
1/4 teaspoon nutmeg
300 g jar artichoke hearts, halved
4 slices processed cheese
chopped parsley

1. Remove meat from chicken and chop into cubes.
2. Melt butter for 40-50 seconds on 100% in a microwave safe jug. Stir in flour; cook a further 40 seconds.
3. Gradually stir in chicken stock. Cook for 5-6 minutes on 100%, stirring halfway through cooking.
4. Stir in chopped chicken, egg yolk, cream, nutmeg and artichokes.
5. Pour into a 2 litre casserole dish. Cover and cook for 4-6 minutes on 70%. Stir well.
6. Lay cheese slices across middle of dish. Cook a further 10-12 minutes on 70%.
7. Sprinkle with parsley.

CHICKEN WITH BACON AND LEEK SEASONING

Serves 4

Approx. 1.5 kg chicken
60 g butter, melted
1 leek, finely chopped
2 rashers bacon, chopped

1 1/2 cups wholemeal breadcrumbs
1 egg yolk
salt and pepper

1. Combine butter, leek and bacon in a microwave safe bowl. Cook for 1-2 minutes on 100%.
2. Stir in breadcrumbs, egg yolk and seasonings. Mix well.
3. Fill cavity of chicken with stuffing and secure with a toothpick.
4. Place chicken on the low rack, breast-side down, cook for 12-14 minutes on HIGH MIX TOP GRILL and 7 minutes on TOP GRILL.
5. Turn over, cook a further 12-14 minutes on HIGH MIX TOP GRILL and 7 minutes on TOP GRILL.
6. Stand covered with foil for 10 minutes before carving.

CHICKEN AND APRICOT SALAD

Serves 6

Approx. 1.5 kg chicken
20 g butter
1/2 cup mayonnaise
1/4 cup sour cream
1 tablespoon lemon juice
6 ripe fresh apricots, cut into wedges
2 sticks celery, thinly sliced
1/4 teaspoon dried tarragon

1. Melt butter in a microwave safe bowl for 20 seconds on 100%, brush chicken with butter. Cook on the low rack for 12-14 minutes on HIGH MIX TOP GRILL and 7 minutes on TOP GRILL.
2. Turn over, brush chicken with butter, and cook for a further 12-14 minutes on HIGH MIX TOP GRILL and 7 minutes on TOP GRILL. Cool.
3. Remove chicken flesh from the bone.
4. Combine mayonnaise, sour cream and lemon juice. Stir in apricots, chicken, celery and tarragon until coated. Chill for 1-2 hours.
5. To serve, line a salad bowl with lettuce leaves. Spoon in salad.

NOTE: Leftover turkey may be substituted for chicken.

HAMBURGER

Serves 6

500 g mince
1 onion, chopped
1 egg
1 tablespoon tomato sauce
1 teaspoon mixed herbs
1 teaspoon seasoned pepper
 $\frac{3}{4}$ cup breadcrumbs

1. In a large bowl, combine mince, onion, egg, tomato sauce, mixed herbs, seasoned pepper and breadcrumbs.
2. Shape into 6 equal patties. Place directly onto turntable. Cook for 8-9 minutes on TOP and BOTTOM GRILL.
3. Drain juices, turn patties over and cook for a further 8-9 minutes on TOP and BOTTOM GRILL.
4. Serve on hamburger bun with lettuce and tomato.

GRILLED KEBABS

Serves 4

400 g lamb
1 large onion, coarsely chopped
1 green capsicum, coarsely chopped

1. Cut lamb into cubes.
2. Thread capsicum, onion and chicken onto 8 skewers.
3. Place on the high rack and cook for 10-15 minutes on TOP GRILL.
4. Turn over and cook for a further 10-15 minutes on TOP GRILL.
5. Serve on a bed of rice.

PORK RIBS WITH CHILLI PLUM SAUCE

Serves 4

750 g pork ribs
1 tablespoon oyster sauce
2 tablespoons dry sherry
1 tablespoon soy sauce
3 teaspoons black beans sauce
1 $\frac{1}{2}$ teaspoons five spice powder
 $\frac{1}{2}$ teaspoon pepper
 $\frac{1}{4}$ teaspoon salt

CHILLI PLUM SAUCE

2 teaspoons oil
1 clove garlic
 $\frac{1}{2}$ teaspoon grated green ginger
2 shallots, chopped
210 mL bottle plum sauce
 $\frac{1}{2}$ teaspoon chilli sauce
1 chicken stock cube
 $\frac{1}{3}$ cup water
2 teaspoons soy sauce
2 teaspoons cornflour

Sauce Method

1. In a large microwave safe bowl combine the oil, crushed garlic, ginger, chopped shallots. Cook for 1-2 minutes on 100%.
2. Add plum and chilli sauce, stir until combined.
3. Combine water, stock cube, soy sauce and cornflour. Add to mixture. Cook for a further 2 minutes on 100%, until mixture begins to thicken.

Method

1. Remove excess fat from ribs.
2. In a large bowl combine oyster sauce, sherry, soy sauce, black beans sauce, five spice powder, pepper and salt.
3. Dip each rib into black bean mixture. Cook for 12-14 minutes on TOP and BOTTOM GRILL.
4. Turn ribs over, brush each side with chilli plum sauce. Cook for a further 12-14 minutes on TOP and BOTTOM GRILL until golden brown.
5. Serve with remaining sauce.

MIXED GRILL

Serves 1

1 steak
1 chump chop
1 rasher bacon
1 thick sausage
1 egg

1. Place steak, chop, sausage (pierced 3 times) and bacon directly onto turntable. Cook for 8-10 minutes on TOP and BOTTOM GRILL.
2. Turn steak, chop, and sausage over, and pierce 3 times again. Drain juices. Add egg.
3. Cook for 6 minutes on TOP and BOTTOM GRILL.

APRICOT AND ALMOND CRUSTY LAMB

Serves 4

- 200 g dried apricots, finely chopped**
- 1 cup fresh breadcrumbs**
- 1/2 cup ground almonds**
- 2 teaspoons dried rosemary**
- 1 egg, lightly beaten**
- 1 rack of lamb (approx. 8 chops)**
- 1 tablespoon apricot jam**

1. Mix together in a small bowl, apricots, breadcrumbs, ground almonds, rosemary and egg.
2. Brush lamb with apricot jam.
3. Place apricot crust on top of lamb.
4. Place on the low rack. Cook for 22-24 minutes on 50% and 3 minutes on TOP GRILL. Allow to stand 10 minutes covered with foil before carving.

FILLET MIGNON

Serves 4

- 4x scotch fillet steaks, approx 2.5 cm thick (approx. 200 g each)**
- 4 rashers bacon**

1. Remove rind of bacon.
2. Wrap 1 rasher of bacon around each fillet, secure with a toothpick.
3. Place directly onto turntable.
4. Cook for 10 minutes on TOP and BOTTOM GRILL.
5. Turn over and drain juices, cook for a further 6-8 minutes on TOP and BOTTOM GRILL.
6. Remove toothpick before serving.
7. Serve with mushroom sauce.

HONEY ROAST LAMB

Serves 4-6

- 1.5 kg leg lamb**
- 3 tablespoons honey**
- 1 tablespoon Dijon mustard**

1. Combine honey and Dijon mustard in a small bowl.
2. Place fat-side down on the low rack.
3. Cook for 14 minutes on HIGH MIX TOP GRILL and 3 minutes on TOP GRILL. Turn meat over, brush combined ingredients over leg of lamb, and shield shank with foil to prevent over cooking. Cook for a further 14 minutes on HIGH MIX TOP GRILL and 3 minutes on TOP GRILL (for medium). Or cook for 16-18 minutes on HIGH MIX TOP GRILL and 3 minutes on TOP GRILL. Turn meat over, brush combined ingredients over leg of lamb, and shield shank with foil to prevent overcooking. Cook for a further 16-18 minutes on HIGH MIX TOP GRILL and 3 minutes on TOP GRILL (for well done).
4. Allow to stand 10 minutes covered with foil before carving.

SPINACH LOIN OF LAMB

Serves 4-6

- 1.0 kg loin of lamb**
- 1 large spinach leaf, shredded**
- 20 g butter**
- 1 large onion, chopped**
- salt and pepper**

1. Butterfly loin of lamb and flatten slightly with a meat mallet.
2. Spread with shredded spinach.
3. Place butter and onion in a microwave safe glass bowl. Cook for 3 minutes on 100%. Sprinkle over spinach.
4. Season with salt and pepper.
5. Roll up loin and secure with string.
6. Place on the low rack, fat-side down, cook for 14-16 minutes on 70% and 3 minutes on TOP GRILL. Turn over and cook for a further 14-16 minutes on 70% and 5 minutes on TOP GRILL (for medium). Or cook for 17-19 minutes on 70% and 5 minutes on TOP GRILL. Turn over and cook for a further 17-19 minutes on 70% and 3 minutes on TOP GRILL (for well done).

BEEF MADEIRA

Serves 4-6

750 g blade or round steak, cubed
1/4 cup plain flour
1 large onion, sliced
2 carrots, thinly sliced
1 clove garlic, crushed

1/2 cup beef stock
1/2 cup madeira or sherry
1/2 teaspoon paprika
350 g beans, washed and sliced
1 green capsicum, sliced

1. In a 3 litre casserole dish, combine meat and flour; mix well.
2. Add onions and carrots.
3. In a jug, combine garlic, beef stock, madeira or sherry, and paprika; stir well. Pour over beef.
4. Cook, covered, for 20-22 minutes on 50%, stirring 2-3 times during cooking.
5. Add beans and capsicum. Cover and cook a further 24-26 minutes on 50%, stirring twice during cooking.

TROPICAL LAMB CURRY

Serves 4-6

1 onion, thinly sliced
1 kg lamb, trimmed and cubed
1 cup chicken stock
1 teaspoon chicken stock powder, extra
3 teaspoons curry powder
810 g can apricot halves, drained, reserving 1/2 cup syrup
2 tablespoons arrowroot

1. Place onion, lamb, chicken stock, stock powder and curry powder into a 3-litre casserole dish.
2. Cover and cook for 28-30 minutes on 50%; stir twice during cooking.
3. Drain lamb and reserve 1/2 cup of liquid.
4. Combine liquid, apricot syrup and arrowroot. Cook for 1-2 minutes on 100%.
5. Combine lamb, apricots and stock mixture and liquid, together in a 3 litre casserole dish and cover.
6. Heat through for 12-14 minutes on 50%.
7. Serve with boiled rice.

MINTED PICNIC LOAF

Serves 6-8

2 cups stale breadcrumbs
1/2 cup milk
1 large potato, grated
500 g sausage mince

500 g minced beef
1/2 cup tomato sauce
2 tablespoons chopped fresh mint

TOPPING

1 cup grated fresh parmesan cheese
1 cup stale breadcrumbs
1 tablespoon chopped fresh mint

1. Combine breadcrumbs and milk in large bowl; stand for 5 minutes.
2. Add potato, mince, tomato sauce and mint to breadcrumb mixture; mix well.
3. Press mixture into an 11 cm x 25 cm loaf dish lined with baking paper.
4. Place on low rack. Cook for 25-28 minutes on 50%.
5. Drain excess liquid from loaf dish.

TOPPING

1. Combine topping ingredients and press evenly over loaf. Cook for a further 3-4 minutes on TOP GRILL.
2. Allow to stand 10 minutes before turning out. Serve hot or cold.

CHILLI CON CARNE

Serves 4-6

1 kg mince
1 large onion, finely chopped
825 g can peeled tomatoes
salt and pepper
1-2 teaspoons chilli powder

1 tablespoon vinegar
1 teaspoon sugar
375 g jar tomato paste
425 g can red kidney beans, drained

1. Mix mince and onion together in a large microwave safe bowl. Cook for 10-12 minutes on 70%, stirring every 2 minutes.
2. Stir in tomatoes, salt and pepper, chilli powder, vinegar, sugar, tomato paste and kidney beans.
3. Cook for 20-22 minutes on 70%, stirring twice during cooking.
4. Serve with boiled rice.

VEAL À LA MEDALLION

Serves 4-6

1 kg veal, cubed
1/2 cup plain flour
salt and pepper
3/4 cup water
1 cup finely chopped shallots
2 carrots, thinly sliced

1/2 teaspoon grated lemon rind
2 rashers bacon, chopped
250 g fresh mushrooms, sliced
300 mL carton sour cream
1 tablespoon chopped chives

1. Toss veal in flour. Place in a 3 litre casserole dish. Stir in salt, pepper, water, shallots, carrots, lemon rind and bacon.
2. Cover and cook for 40 minutes on 50%, stirring 2-3 times during cooking.
3. Stir in mushrooms and sour cream.
4. Cover and cook a further 5-7 minutes on 50%.
5. Sprinkle with chives.

VEAL AND PINEAPPLE

Serves 4-6

2 tablespoons flour
2 teaspoons mixed herbs
1 teaspoon chicken stock powder
black pepper
750 g veal, diced
4 rashers bacon, chopped
3 shallots, chopped
440 g can pineapple pieces, drained
1 cup tomato sauce
2 tablespoons chopped parsley

1. Mix first 4 ingredients together in a large casserole dish.
2. Add the veal; toss to coat in the seasonings. Stir in bacon, shallots, pineapple pieces and tomato sauce.
3. Cover and cook for 35 minutes on 50%, stirring 2-3 times during cooking.
4. Sprinkle with parsley and serve with rice.

HERBED LOIN OF LAMB

Serves 8

1/2 cup white wine
1/4 cup oil
3 cloves garlic, crushed
freshly ground black pepper
1 teaspoon rosemary spikes
1 kg loin of lamb

1. Mix all ingredients except lamb together to form a marinade in a small bowl.
2. Place loin of lamb in a large shallow dish and pour over marinade; leave overnight.
3. Remove loin of lamb from marinade and roll loin tightly, securing with string.
4. Place on the low rack. Cook for 10-12 minutes on HIGH MIX TOP GRILL and 3 minutes on TOP GRILL. Turn meat over and cook for a further 10-12 minutes on HIGH MIX TOP GRILL and 3 minutes on TOP GRILL. (for medium). Or cook for 14-16 minutes on HIGH MIX TOP GRILL and 3 minutes on TOP GRILL. Turn meat over and cook for a further 14-16 minutes on HIGH MIX TOP GRILL and 3 minutes on TOP GRILL (for well done).
5. Allow to stand 10 minutes covered with foil before carving.

ITALIAN SPAGHETTI SAUCE

Serves 4-6

500 g topside mince
1 onion, chopped
1 clove garlic, crushed
400 g can whole tomatoes
1/2 cup tomato paste
100 g mushrooms, sliced
1 tablespoon chopped parsley
1 teaspoon salt
1/2 teaspoon dried oregano leaves
1/2 teaspoon dried basil leaves

1. Mix mince, onion and garlic together in a large microwave safe bowl. Cook for 8-10 minutes on 70%, stirring every 2 minutes. Drain well.
2. Stir in canned tomatoes, tomato paste, mushrooms, parsley, salt, oregano and basil.
3. Cook a further 8-11 minutes on 70%. Stir halfway through cooking.
4. Serve over hot spaghetti.

SPRINGTIME LAMB CASSEROLE

Serves 4

1 packet (40 g) French onion soup
1/4 cup plain flour
750 g lamb, cubed
4 spring onions, quartered
2 carrots, thinly sliced
1 cup chicken stock
310 g can corn kernels, drained
2 sticks celery, finely chopped
300 mL carton sour cream

1. Combine French onion soup mix and flour in a 2-3 litre casserole dish. Toss the lamb in flour mixture, coating thoroughly.
2. Add onions and carrots, stir in chicken stock and mix well.
3. Cover and cook for 22-24 minutes on 50%, stirring during cooking.
4. Add corn, celery and sour cream. Mix well.
5. Cook a further 16-18 minutes on 50%.

CURRIED SAUSAGES

Serves 4-6

1 kg sausages
40 g butter
2 onions, chopped
1 small Granny Smith apple, peeled and finely chopped
3 teaspoons curry powder
1/4 cup sultanas
1 beef stock cube
1 1/2 cups water
1/4 cup flour

1. Pierce sausages with a fork twice. Arrange sausages on the low rack.
2. Cook for 14-16 minutes on 50%, turning halfway through cooking. Cut sausages into thirds.
3. In a 2-3 litre casserole dish, place butter, onions, apple, curry powder and sultanas; mix well. Cover and cook for 4-6 minutes on 100%.
4. Dissolve stock cube in water.
5. Mix in flour and stock, cover and cook for 4-5 minutes on 100%, stirring once.
6. Add sausages and stir.
7. Cover and cook for an extra 6-7 minutes on 50%. Serve with boiled rice or noodles.

BEEF STROGANOFF

Serves 6

1 kg rump steak, cut into strips
1/2 cup plain flour
salt and pepper
1 onion, finely chopped
2 tablespoons tomato purée
1 1/2 cups beef stock
1/4 cup red wine
100 g mushrooms, thinly sliced
300 mL sour cream

1. Toss steak with flour, salt and pepper in a freezer bag until evenly coated.
2. Place steak, left-over flour, onion, tomato purée, beef stock and red wine in a 3 litre casserole dish.
3. Cook, covered, for 35 minutes on 50%, stirring twice during cooking.
4. Stir in mushrooms and sour cream. Cook for a further 4-5 minutes on 50%.
5. Serve with boiled rice.

CORNED BEEF

Serves 6-8

2 tablespoons brown sugar
2 tablespoons malt vinegar
3 cups hot water
1.5 kg corned beef

1. Place corned beef in a casserole dish just large enough to contain it.
2. Combine brown sugar, malt vinegar and hot water. Pour over corned beef.
3. Cover with lid and cook for 70 minutes on 50%, turning over halfway through cooking. Allow to stand covered with foil for 10 minutes before serving.
4. Serve with white sauce.

MEAT

CRUSTY ROSEMARY LAMB

Serves 4-6

- 1/4 cup brown sugar**
- 2 tablespoons seeded mustard**
- 1 tablespoon lemon juice**
- 2 tablespoons chopped fresh rosemary**
- 1.5 kg leg lamb**

1. Combine brown sugar, mustard, lemon juice and rosemary in a small bowl.
2. Place fat side down on the low rack.
3. Cook for 14 minutes on HIGH MIX TOP GRILL and 3 minutes on TOP GRILL. Turn over, shielding shank with foil to prevent overcooking. Spread combined ingredients over leg of lamb. Cook for a further 14 minutes on HIGH MIX TOP GRILL and 3 minutes on TOP GRILL (for medium). Or cook for 16 minutes on HIGH MIX TOP GRILL and 3 minutes on TOP GRILL. Turn over, shielding shank with foil to prevent overcooking. Spread combined ingredients over leg of lamb. Cook for a further 16 minutes on HIGH MIX TOP GRILL and 3 minutes on TOP GRILL (for well done).
4. Allow to stand 10 minutes covered with foil before carving.

SHEPHERD'S PIE

Serves 6-8

- | | |
|---------------------------------------|------------------------------------------|
| 4 large potatoes (approx.1 kg) | 1 tablespoon gravy powder |
| 20 g butter | 2/3 cup tomato sauce |
| 1 tablespoon milk | 1 tablespoon Worcestershire sauce |
| salt and pepper | 1 tomato, chopped |
| 1 kg minced beef | 2 tablespoons parsley |
| 1 onion, chopped | 1 egg, beaten |

1. Peel and cut potatoes into 2.5 cm cubes. Place in a large microwave safe bowl. Add 2 tablespoons water; cover and cook for 12-14 minutes on 100% or until tender. Drain.
2. Mash potatoes; add butter, milk, salt and pepper.
3. In a large bowl, combine mince and onion and cook for 10-12 minutes on 70%, stirring every 2 minutes. Drain juices from meat.
4. Add gravy powder, tomato sauce, Worcestershire sauce, tomato and parsley. Mix well.
5. Spoon mixture into a 25 cm x 20 cm rectangular dish.
6. Spread mashed potato evenly over top of mixture. Brush with beaten egg.
7. Cook for 23-25 minutes on HIGH MIX TOP GRILL and 4 minutes on TOP GRILL.
8. Allow to stand covered with foil for 10 minutes before serving.

LASAGNE

Serves 4-6

MEAT SAUCE INGREDIENTS

- 30 g butter**
- 1 onion, chopped**
- 1 kg topside mince**
- 1/4 cup tomato paste**
- 375 g jar bolognese sauce**
- 280 g can champignons, drained**
- 1 clove garlic, crushed (optional)**

CHEESE SAUCE INGREDIENTS

- 90 g butter**
- 1/3 cup flour**
- 1 3/4 cups milk**
- 125 g tasty cheese, grated**
- 250 g packet instant lasagne sheets**
- 100 g mozzarella cheese, grated**

MEAT SAUCE METHOD

1. Place butter and onion in a microwave safe glass bowl. Cook for 2-3 minutes on 100%.
2. Stir in mince. Cook, uncovered, for 12-14 minutes on 70%, stirring every 2 minutes. Drain excess fat.
3. Stir in tomato paste, bolognese sauce, champignons and garlic.

CHEESE SAUCE METHOD

1. Melt butter for 50-60 seconds on 100%. Stir in flour; cook for further 1 minute on 100%.
2. Gradually stir in milk. Cook for 4-6 minutes on 100%, stirring every minute.
3. Stir in tasty cheese.

TO COMBINE

1. Use a 25 x 25 cm deep casserole dish.
2. Dip lasagne sheets in hot water, then cover base of dish.
3. Spoon over sheets one-third of meat sauce. Cover with one-third of cheese sauce.
4. Repeat the process 3 times, ending with the cheese sauce.
5. Sprinkle with mozzarella cheese.
6. Cook for 24-26 minutes on HIGH MIX TOP GRILL and 4 minutes on TOP GRILL.
7. Allow to stand 10 minutes before serving.
8. Serve with a fresh garden salad and bread.

APPETISERS

QUICK NACHOS

Serves 4

- 200 g packet corn chips**
- 250 g jar of salsa**
- 1/2 cup sour cream**
- 2 tablespoons tomato paste**
- 1/4 cup grated tasty cheese**

1. Place corn chips in base of a glass pie dish.
2. Mix salsa and sour cream together in a small bowl. Pour over corn chips.
3. Spread tomato paste over the top of salsa.
4. Sprinkle with cheese.
5. Place on the LOW rack and cook for 6 1/2 minutes on TOP GRILL.
6. Serve immediately with guacamole.

GARLIC AND HERB FOCACCIA

- 1 focaccia (rectangular)**
- 100 g margarine**
- 2 cloves garlic, crushed**
- 1 teaspoon mixed herbs**

1. Carefully cut bread in half.
2. Mix margarine, garlic and herbs together in a small bowl.
3. Spread evenly over focaccia. Place onto the high rack side by side.
4. Cook for 4-5 minutes on TOP GRILL.
5. Cut into strips and serve hot.

VEGETABLE FRITTATA

Serves 4

- 2 large potatoes, peeled and thinly sliced**
- 1 onion, thinly sliced**
- 5 eggs**
- 450 mL sour cream**
- 330 g can asparagus spears, drained**
- 1/2 red capsicum, cut into strips**
- 2 zucchinis, cut into strips**
- 2 tablespoons parmesan cheese**

1. Arrange potatoes and onion over base of greased 23 cm glass pie plate.
2. Combine eggs and sour cream. Pour half the mixture over potatoes.
3. Cook for 10-12 minutes on 70% on the low rack.
4. Arrange asparagus, capsicum and zucchinis in a circle over potato. Pour over remaining egg mixture. Sprinkle with cheese.
5. Cook on the low rack for 10-12 minutes on HIGH MIX TOP GRILL, and 4 minutes on TOP GRILL.
6. Stand covered with foil for 5 minutes.
7. Cut into wedges.

RECIPES

INDEX

APPETISERS

GARLIC AND HERB FOCACCIA
QUICK NACHOS
VEGETABLE FRITTATA

MEAT

APRICOT AND ALMOND CRUSTY LAMB
BEEF MADEIRA
BEEF STROGANOFF
CHILLI CON CARNE
CORNEB BEEF
CRUSTY ROSEMARY LAMB
CURRIED SAUSAGES
FILLET MIGNON
GRILLED KEBABS
HAMBURGER
HERBED LOIN OF LAMB
HONEY ROAST LAMB
ITALIAN SPAGHETTI SAUCE
LASAGNE
MINTED PICNIC LOAF
MIXED GRILL
PORK RIBS WITH CHILLI PLUM SAUCE
SHEPHERD'S PIE
SPINACH LOIN OF LAMB
SPRINGTIME LAMB CASSEROLE
TROPICAL LAMB CURRY
VEAL À LA MEDALLION
VEAL AND PINEAPPLE

POULTRY

APRICOT CHICKEN
CHEESE AND HERB CHICKEN LEGS
CHICKEN AND APRICOT SALAD
CHICKEN AND MACARONI BAKE
CHICKEN CACCIATORE

POULTRY continued

CHICKEN FILLET BURGERS
CHICKEN FRICASSEE
CHICKEN IN A POT
CHICKEN PROVENCALE
CHICKEN TERRINE
CHICKEN WITH BACON AND
LEEK SEASONING
CRUNCHY CAMEMBERT CHICKEN
HONEY CHICKEN LEGS
ROAST CHICKEN
TANDOORI CHICKEN
WHOLEMEAL CHICKEN

SEAFOOD

BOUILLABAISSÉ
CHEESY SALMON CANNELLONI
CRAB MORNAY
CRISPY MARINATED CRAB STICKS
CURRIED SCALLOPS
GARLIC MUSSELS
GARLIC PRAWNS
MARINATED BABY OCTOPUS
OYSTERS KILPATRICK
PRAWN CUTLETS
PRAWN CREOLE
SCALLOPS IN BLACK BEAN SAUCE
SEAFOOD LASAGNE
SESAME PRAWNS
SQUID IN TOMATO AND WINE SAUCE
TAGLIATELLE AND CRAB SALAD

VEGETABLES

CAULIFLOWER AU GRATIN
CHUNKY VEGETABLE SOUP
EASY HOME-MADE RICE RISOTTO
GRILLED TOMATOES
GRILLED ZUCCHINI WITH FETA AND MINT

VEGETABLES continued

HONEY CARROTS
HONEY GINGERED VEGETABLES
POTATOES PIZZAIOLA
POTATO, AVOCADO AND ONION SALAD
PUMPKIN SALAD
ROAST VEGETABLES
SCALLOPED POTATOES
SOY AND SESAME GREEN BEANS
SQUASH WITH YOGHURT
STUFFED BAKED POTATOES
STUFFED MUSHROOMS
VEGETABLE PLATTER

DESSERTS





APRICOT WHEATGERM CRUNCHIES
AUSTRALIAN FRUIT CAKE
BAKED APPLES
BREAD AND BUTTER PUDDING
CALIFORNIAN APPLE CRUNCH
CARAMEL RICE PUDDING
CHOCOLATE MOUSSE
CHOCOLATE CAKE
CHOCOLATE CHIP COOKIES
CHOCOLATE SELF-SAUCING PUDDING
MUESLI CUSTARD DELIGHT

CHARTS

DEFROSTING CHARTS
FRESH VEGETABLE CHART
FROZEN VEGETABLE CHART
GLOSSARY OF TERMS
GRILLING CHART
GUIDE TO COOKING EGGS
REHEATING CONVENIENCE
DEFROSTING CONVENIENCE-FOOD CHART
RICE AND PASTA COOKING CHART

EASY DEFROST MENU GUIDE

EASY
DEFROST

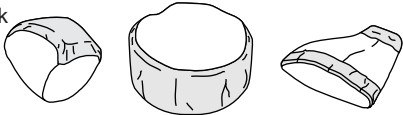
Menu		Quantity min-max (kg's)	Procedure	Standing Time (minutes)
Minced Meat Beef		0.1-3.0	<ul style="list-style-type: none"> Place shielded frozen minced meat on a defrost rack. When the oven has stopped, remove defrosted portions of mince, turn over and shield edges with foil strips. After defrost time, stand covered with aluminium foil. See NOTE below. 	10-15
Steak/Chops		0.1-3.0	<ul style="list-style-type: none"> Shield thin end of chops or steaks with foil. Position the food with thinner parts in the centre in a single layer on a defrost rack. If pieces are stuck together, try to separate as soon as possible. When the oven has stopped, remove defrosted pieces, turn over and shield the warm portions of remaining pieces. After defrost time, stand covered with aluminium foil. See NOTE below. 	10-15
Chicken Pieces		0.1-3.0	<ul style="list-style-type: none"> Shield the exposed bone with foil. Place chicken pieces on a defrost rack. When the oven has stopped, remove any defrosted pieces, turn over and shield the warm portions of remaining pieces. After defrost time, stand covered with aluminium foil. See NOTE below. 	5-15
Poultry		1.0-3.0	<ul style="list-style-type: none"> Remove from original wrapper. Shield wing and leg tips with foil. Place breast side down on a defrost rack. When the oven has stopped, turn over and shield the warm portions. After defrost time, stand covered with aluminium foil. <p>N.B. After standing run under cold water to remove giblets if necessary.</p>	15-50
Roast Meat Beef/Lamb/Pork		0.5-3.0	<ul style="list-style-type: none"> Shield the bone and the edge with foil strips about 2.5cm wide. Place joint with lean side face upwards (if possible) on a defrost rack. When the oven has stopped, turn over and shield the warm portions. After defrost time, stand covered with aluminium foil. 	15-50

Foods not listed in the Guide can be defrosted using M•LOW setting.

NOTE: When freezing minced meat, shape it into flat even sizes.

For chicken pieces, steaks and chops, freeze separately in single flat layers and if necessary interleave with freezer plastic to separate layers.

This will ensure even defrosting.



It is also a good idea to label the packs with the correct weights.



CONVENIENCE/PIZZA MENU GUIDE

CONVENIENCE
/ PIZZA

1. Frozen Pizza
2. Fresh Pizza
3. Fries
4. Frozen Pasta
5. Crumbed Fish
6. Finger Food

To cook the following CONVENIENCE/PIZZA menus.
Press the CONVENIENCE/PIZZA pad and the number pad of the menu.

No.	Menu	 Weight Range	 Initial Temperature (approx.)	Cooking Method	Procedure	 Standing Time (minutes)
1	Frozen pizza	0.2 - 0.5 kg	-18 °C Frozen temperature	Micro Top/bottom grill Top grill	<ul style="list-style-type: none"> Remove from package. Place directly onto turntable. 	
2	Fresh pizza Topping include: Ham Cheese Onion Olives Capsicum Mushrooms Peperoni Cabanossi Pineapple	1 pizza (500 - 700g)	+ 3 °C Refrigerated	Top/bottom grill Top grill	<ul style="list-style-type: none"> Add paste and toppings of your choice to fresh pizza base. Place directly onto turntable. 	
3	Fries Includes: Wedges Crinkle cut Shoe string	0.1 - 0.5kg	-18 °C Frozen temperature	Micro Top/bottom grill Top grill	<ul style="list-style-type: none"> Place directly onto turntable. When oven stops and TURN FRIES, OVER is displayed, turn over fries and continue cooking. 	
4	Frozen Pasta Includes: Lasagne Cannelloni	0.2 - 1.0kg	-18 °C Frozen temperature	Micro Mix	<ul style="list-style-type: none"> Remove the pasta from foil tray and place in a heat - resistant ceramic dish. Place on the low rack. Do not cover. After cooking, stand 	2-5
5	Crumbed Fish Includes: Fish fingers Battered Fish	0.1 - 0.5kg	-18 °C Frozen temperature	Micro Top/bottom grill Top grill	<ul style="list-style-type: none"> Remove from package. Place directly onto turntable. 	
6	Finger Food Includes: Party pies Party sausage rolls Cocktail spring rolls Mini chicken drum sticks Sea shantys Chicken chippees, Calamari	0.2 - 0.8kg	-18 °C Frozen temperature	Micro Top/bottom grill Top grill	<ul style="list-style-type: none"> Remove from package. Place directly onto turntable. 	



No.	Menu	 Weight Range	 Initial Temperature (approx.)	Cooking Method	Procedure	 Standing Time (minutes)
4	Roast Pork	0.5 - 3.0 kg	+3°C Refrigerated	Mix	<ul style="list-style-type: none"> • Tie meat with string (loins only). • Brush rind lightly with oil and season with salt. • Place rind side down on the low rack. • When oven stops and TURN PORK, OVER is displayed, turn pork over. • After cooking, stand covered with aluminium foil. 	5-15
5	Grilled Steak/Chops Includes: T-bone Steak Rump Steak Pork Chops Lamb Chump Chops Lamb loin Chops	0.3 - 1.0 kg	+3°C Refrigerated	Micro Top/bottom grill	<ul style="list-style-type: none"> • Place directly onto turntable. • When oven stops and DRAIN, JUICES, TURN, STEAK CHOPS, OVER is displayed, DRAIN FAT JUICES and turn meat over. 	
6	Grilled Chicken Pieces	0.3 - 1.0 kg	+3°C Refrigerated	Mix Top grill	<ul style="list-style-type: none"> • Place chicken skin side down on the high rack and season. • When oven stops and TURN, CHICKEN, PIECES, OVER is displayed, turn chicken over and season. • After cooking, stand covered with aluminium foil. 	5



MULTI COOK MENU GUIDE

MULTI
COOK

- 1. Roast Beef
- 2. Roast Lamb
- 3. Roast Chicken
- 4. Roast Pork
- 5. Grilled Steak/Chops
- 6. Grilled Chicken Pieces

When you cook the following menus with MULTI COOK, press the MULTI COOK pad and the number pad of the menu.

No.	Menu	 Weight Range	 Initial Temperature (approx.)	Cooking Method	Procedure	 Standing Time (minutes)
1	Roast Beef Medium	0.5-3.0 kg	+3°C Refrigerated	Mix	<ul style="list-style-type: none"> Tie meat with string. Place fat side down on the low rack. When oven stops and TURN BEEF, OVER is displayed, turn beef over. After cooking, stand covered with aluminium foil. 	5-15
2	Roast Lamb Medium	0.5-2.5 kg	+3°C Refrigerated	Mix	<ul style="list-style-type: none"> Place fat side down on the low rack. When oven stops and TURN LAMB, OVER is displayed, turn lamb over. After cooking, stand covered with aluminium foil. 	5-15
3	Roast Chicken	1.0-2.0 kg	+3°C Refrigerated	Mix	<div style="border: 1px solid black; padding: 5px; margin-bottom: 5px;"> <p>Preparation before cooking</p> <ul style="list-style-type: none"> Remove neck and excess fat from chicken. Wash and dry chicken. Tie legs together. </div> <ul style="list-style-type: none"> Place breast side down on the low rack. When oven stops and TURN, CHICKEN OVER is displayed, turn chicken over. After cooking, stand covered with aluminium foil. 	5-15





Menu	 Weight Range	 Initial Temperature (approx.)	Cooking Method	Procedure	 Standing Time (minutes)				
Rice/Pasta (Rice)	1 - 4 serves (1 serve = 1/2 cup)	+60°C Hot tap water or soup stock	Micro	<ul style="list-style-type: none"> • Wash rice until water runs clear. • Place into a microwave safe glass bowl and cover with hot soup stock or with hot tap water. • Cook uncovered. • When oven stops and STIR is displayed, stir and continue cooking. • After cooking, stand and stir. 	1-5				
<table border="1"> <tr> <td data-bbox="131 395 382 463">Rice</td> <td data-bbox="382 395 653 463">Soup stock or Hot tap water (1 cup = 250ml)</td> </tr> <tr> <td data-bbox="131 463 382 576"> 1/2 cup 1 cup 1 1/2 cups 2 cups </td> <td data-bbox="382 463 653 576"> 1 cup 1 1/2 cups 2 cups 4 cups </td> </tr> </table>	Rice	Soup stock or Hot tap water (1 cup = 250ml)	1/2 cup 1 cup 1 1/2 cups 2 cups	1 cup 1 1/2 cups 2 cups 4 cups					
Rice	Soup stock or Hot tap water (1 cup = 250ml)								
1/2 cup 1 cup 1 1/2 cups 2 cups	1 cup 1 1/2 cups 2 cups 4 cups								
(Pasta)	1 - 4 serves (1 serve = 1/2 cup)	+60°C Hot tap water	Micro	<ul style="list-style-type: none"> • Place into a microwave safe glass bowl and cover with hot tap water. • Cook uncovered. • When oven stops and STIR is displayed, stir and continue cooking. • After cooking, stand and stir. 	1-5				
<table border="1"> <tr> <td data-bbox="131 710 382 779">Pasta</td> <td data-bbox="382 710 653 779">Hot tap water (1 cup = 250ml)</td> </tr> <tr> <td data-bbox="131 779 382 891"> 1/2 cup 1 cup 1 1/2 cups 2 cups </td> <td data-bbox="382 779 653 891"> 2 cups 2 cups 3 cups 4 cups </td> </tr> </table>	Pasta	Hot tap water (1 cup = 250ml)	1/2 cup 1 cup 1 1/2 cups 2 cups	2 cups 2 cups 3 cups 4 cups					
Pasta	Hot tap water (1 cup = 250ml)								
1/2 cup 1 cup 1 1/2 cups 2 cups	2 cups 2 cups 3 cups 4 cups								

INSTANT ACTION MENU GUIDE

INSTANT ACTION		
DINNER PLATE	FRESH VEGETABLES	JACKET POTATO
REHEAT PIE	FROZEN VEGETABLES	RICE / PASTA

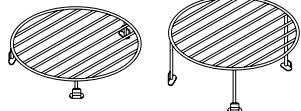
Menu	Weight Range	Initial Temperature (approx.)	Cooking Method	Procedure	Standing Time (minutes)									
Dinner Plate <table border="1" style="width: 100%; border-collapse: collapse;"> <thead> <tr> <th>MEAT</th> <th>POTATO</th> <th>VEGETABLES</th> </tr> </thead> <tbody> <tr> <td>175-180g</td> <td>125g</td> <td>100g</td> </tr> <tr> <td>Beef, Lamb Chicken, T-Bone</td> <td>sliced</td> <td>2 varieties eg. sliced Carrot, Zucchini Broccoli</td> </tr> </tbody> </table>	MEAT	POTATO	VEGETABLES	175-180g	125g	100g	Beef, Lamb Chicken, T-Bone	sliced	2 varieties eg. sliced Carrot, Zucchini Broccoli	1 serve (1 serve = 400 g)	+3°C Refrigerated	Micro	<ul style="list-style-type: none"> • Cover with plastic wrap. • Place on the low rack. • After cooking, stand covered. 	2
MEAT	POTATO	VEGETABLES												
175-180g	125g	100g												
Beef, Lamb Chicken, T-Bone	sliced	2 varieties eg. sliced Carrot, Zucchini Broccoli												
Fresh Vegetables Carrots } Potato } hard vegetables Beans } Brussels Sprouts } Broccoli } medium vegetables Cauliflower } Zucchini } Spinach } soft vegetables Cabbage } Squash }	0.1-1.0 kg	+3°C Refrigerated	Micro	<ul style="list-style-type: none"> • Wash the vegetables. • Pierce skin of squash with folk. • Arrange the vegetables in a shallow dish in the following way : hard vegetables around the outside, soft vegetables in the centre, medium vegetables in-between. • Cover with a glass lid or plastic wrap. • After cooking, stand covered and stir. 	1-5									
Jacket Potato Potato (whole)	1-8 pieces (1 piece = 180 - 200 g)	+20°C Room temperature	Micro	<ul style="list-style-type: none"> • Use washed new potatoes. • Pierce twice with fork on each side. • Place on outside of turntable. • When oven stops and TURN, POTATO OVER is displayed, turn over potatoes and continue cooking. • After cooking, stand, covered with aluminium foil. 	3-10									
Reheat Pie meat	1-4 pieces (1 piece = 160 - 200 g)	-18°C Frozen	Micro Top/bottom grill	<ul style="list-style-type: none"> • Remove from package. • Place upside down directly onto turntable. • When oven stops and TURN, PIE OVER is displayed, turn over pies and continue cooking. • After cooking, stand. 	1-3									
Frozen Vegetables Carrots } hard vegetables Beans } Brussels Sprouts } Broccoli } medium vegetables Cauliflower } Corn } Green Peas } soft vegetables Mixed Vegetables }	0.1-1.0 kg	-18°C Frozen	Micro	<ul style="list-style-type: none"> • Before cooking, separate vegetables eg. broccoli as much as possible. • Arrange the vegetables in a shallow dish in the following way : hard vegetables around the outside, soft vegetables in the centre, medium vegetables in-between. • Cover with a glass lid or plastic wrap. • After cooking, stand covered and stir. 	1-5									

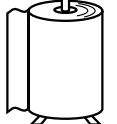
COOKWARE & UTENSIL GUIDE

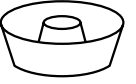
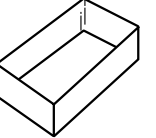
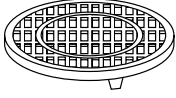
		MICROWAVE	GRILL	MIX COOKING	CONVECTION
		YES (LOW RACK ONLY)	YES	YES	YES
OVENPROOF GLASS	METAL RACKS	YES	YES	YES	YES
		NO	YES	*1 YES	YES
CAKE TIN	PIZZA TRAY	YES	NO	NO	NO
		For Shielding	YES	For Shielding	YES
PAPER TOWEL	FOIL	YES	NO	NO	NO
		*2 YES (microwave safe wrap only)	NO	NO	NO
RING CENTRE DISH	SQUARE DISH	YES	NO	NO	NO
		*3 YES	NO	NO	NO
DEFROST RACK		YES NO	NO NO	NO NO	NO NO

*1 When using metal utensil, place a heat resistant dish between the metal utensil and the rack (refer to page ②).

*2 For cooking food with high fat contents, do not bring the wrap in contact with the food as it may melt.

*3 Some microwave safe plastic cookware are not suitable for cooking foods with high fat and sugar content.

HELPFUL HINTS

GRILL COOKING

1. Use thick oven mittens when removing the food or turntable from the oven to **PREVENT BURNS**. Because the oven cavity, door, turntable, turntable support, racks, dishes and especially bottom heater will become very hot.
2. Foods may be cooked either directly on turntable, or using the high or low racks.

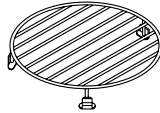

LOW RACK

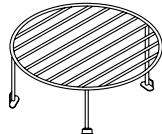

HIGH RACK

MIX COOKING

1. There are four automatic, preprogrammed mix settings.
 - a) High mix top grill - Top Grill with 70% microwave power.
 - b) Low mix top grill - Top Grill with 50% microwave power.
 - c) High mix bottom grill - Bottom Grill with 50% microwave power.
 - d) Low mix bottom grill - Bottom Grill with 10% microwave power.
2. Use thick oven mittens when removing the food or turntable from the oven to **PREVENT BURNS**. Because the oven cavity, door, turntable, turntable support, racks, dishes and especially bottom heater will become very hot.
3. Metal cookware can be used.
During mix cooking some metal utensils may cause arcing when they come in contact with oven walls or accessory racks. To prevent arcing when using a metal tin, place a heat resistant dish (microwave safe glass pie plate, dinner plate) between the tin and the rack.

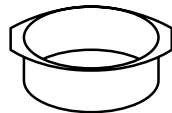

CAKE TIN



PIZZA TRAY

CONVECTION COOKING

1. Use thick oven mittens when removing the food or turntable from the oven to **PREVENT BURNS**. Because the oven cavity, door, turntable, turntable support, racks, dishes and especially bottom heater will become very hot.
2. For best results, preheat to required temperature with the turntable in the oven. Add food after preheating.
3. Metal cookware can be used. Round pizza trays are excellent cooking utensils for cooking.

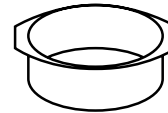

CAKE TIN

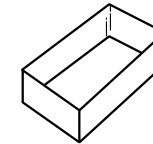

SQUARE DISH



PIZZA TRAY

4. If you are cooking and wish to check the temperature you have programmed, simply press the **CONVEC** pad. The programmed temperature will be displayed as long as **CONVEC** pad is pressed.
5. Do not cook 2 layers of eg. biscuits at the same time.

HELPFUL HINTS

MICROWAVE COOKING

1. ARRANGEMENT

Arrange foods carefully. Place thickest areas toward outside of dish.

Eg. Arrange vegetables in a shallow dish in the following way:

Hard Vegetables around the outside, Soft Vegetables in the centre, Medium Vegetables in-between.



2. TURNING

Foods such as poultry and joints of meat should be turned over after half the cooking time.

3. COVERING

Cover foods in the microwave if you would normally cover the food in your ordinary oven, or to retain moisture. Cover foods such as Vegetables, Casseroles, or when Reheating.

Use to cover foods:



LID



PLASTIC WRAP

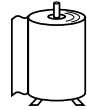

PAPER TOWEL

4. PIERCING

Pierce potatoes, eggs, oysters, tomatoes or any foods with a skin or membrane to allow steam to escape.



TOMATO



EGG

5. SHIELDING

Shield using small pieces of aluminium foil to shield thin areas of meat, fish and poultry or edges of cakes to prevent overcooking.



FISH



CHICKEN

6. STANDING TIME

Standing time is important. After cooking or defrosting ensure adequate standing time. This allows the food to continue cooking or heating. Refer to cooking guides for each menu or according to manufacturers instructions.

7. STIRRING

Stir foods from the outside to the centre of the dish, once or twice during cooking if possible.

Eg. Casseroles and Sauces.



STIR

8. SIZE

Small pieces cook faster than large ones. To speed cooking, cut pieces smaller than 5 cm so microwaves can penetrate to the centre from all sides. For even cooking, make all the pieces the same size.

9. DENSITY

The depth to which microwaves penetrate food varies depending on the food's density. Porous foods like minced beef or mashed potatoes microwave faster than dense ones like steak or whole potatoes.

10. FAT AND BONE

Marbling within meat, or a thin, even layer of fat on a roast, speeds cooking. Large fatty areas or excess drippings in dish attract energy away from meat, and slows cooking. Centre bones do not affect cooking, but bone on the side of meat conducts heat to the areas next to it.

11. STARTING TEMPERATURE

Frozen or refrigerated food takes longer to heat than food at room temperature. Cooking times in this book are based on normal storage temperatures. Since rooms, refrigerators and freezers differ in temperature, check for doneness at the minimum time.



12. QUANTITY

Microwave cooking times are directly related to the amount of food in the oven. Because energy is absorbed by the food itself, one potato or a single piece of chicken cooks rapidly. When the energy is divided among several items, cooking takes more time.

13. CONDENSATION

Condensation is a normal part of microwave cooking. The humidity and moisture in food will influence the amount of condensation in the oven. Generally, covered foods will not cause as much condensation as uncovered foods. Ensure that the ventilation openings are not blocked.

14. GENERAL

Your microwave oven is capable of heating food and beverages very quickly therefore, it is very important that you select the appropriate cooking time and power level for the type and quantity of food to be heated. If you are unsure of the cooking time and power level required, begin with low cooking times and power levels until the food is sufficiently heated evenly throughout.

SHARP

COOKING GUIDES



CONTENTS COOKING GUIDE

HELPFUL HINTS ①	COOKWARE AND UTENSIL GUIDE ③	INSTANT ACTION MENU GUIDE ④	MULTI COOK MENU GUIDE ⑥	CONVENIENCE/PIZZA MENU GUIDE ⑧	EASY DEFROST MENU GUIDE ⑨	RECIPES ⑩ - ③⑨
--------------------	------------------------------------	-----------------------------------	-------------------------------	--------------------------------------	---------------------------------	-------------------

QUICK REFERENCE GUIDE

FEATURE	QUICK OPERATION GUIDE
Convenience/Pizza Multi Cook	<p>Menu Number → Weight → INSTANT COOK START</p> <p>MULTI COOK → [1] → [1] [0] → INSTANT COOK START</p> <p>eg. Roast Beef eg. 1.0kg</p>
Easy Defrost	<p>Weight → INSTANT COOK START</p> <p>EASY DEFROST → [1] [0] → INSTANT COOK START</p> <p>eg. 1.0kg</p>
Variable Cooking Control	<p>To soften Cream Cheese or Butter for 40 seconds at 30% power level (M•LOW).</p> <p>Cooking Time → POWER LEVEL → INSTANT COOK START</p> <p>[4] [0] → POWER LEVEL → INSTANT COOK START</p> <p>eg. 40 seconds x 4</p>
Preheat	<p>Temp → INSTANT COOK START</p> <p>PREHEAT → [5] [160°C] → INSTANT COOK START</p> <p>eg. 160°C</p>
Manual Convection Cooking	<p>Temp → Cooking Time → INSTANT COOK START</p> <p>CONVEC → [6] [180°C] → [1] [5] [0] [0] → INSTANT COOK START</p> <p>eg. 180°C eg. 15 minutes</p>
Grill Cooking	<p>Grill Mode → Cooking Time → INSTANT COOK START</p> <p>GRILL → [1] [5] [0] [0] → INSTANT COOK START</p> <p>x 1 eg. Top Grill eg. 15 minutes</p>
Mix Cooking	<p>Mix Setting → Cooking Time → INSTANT COOK START</p> <p>MIX → [1] [5] [0] [0] → INSTANT COOK START</p> <p>x 1 eg. High mix top grill eg. 15 minutes</p>

SHARP

SHARP

SHARP CORPORATION OSAKA, JAPAN

TINS-A759WRRZ-J81
PRINTED IN THAILAND

Free Manuals Download Website

<http://myh66.com>

<http://usermanuals.us>

<http://www.somanuals.com>

<http://www.4manuals.cc>

<http://www.manual-lib.com>

<http://www.404manual.com>

<http://www.luxmanual.com>

<http://aubethermostatmanual.com>

Golf course search by state

<http://golfingnear.com>

Email search by domain

<http://emailbydomain.com>

Auto manuals search

<http://auto.somanuals.com>

TV manuals search

<http://tv.somanuals.com>