

# SHARP®



## ELECTRONIC ORGANIZER

### OPERATION MANUAL

Quick Start .....	8
Getting Started .....	41
General Operation .....	55
Time Management .....	69
Creating Your Own Database .....	95
Memo and Outlining .....	103
Desk Accessories .....	117
Money & Account Management .....	133
Features and Utilities for	
Added Power .....	161
Using the Optional Peripherals .....	169
Personalizing Your Organizer .....	183
Appendices .....	191

**SHARP®**

**SHARP ELECTRONICS CORPORATION**

Sharp Plaza, Mahwah, New Jersey 07430-2135.

**SHARP CORPORATION**

PRINTED IN JAPAN  
95G16T(TINSE1240PCZZ) ①

# Introduction

Congratulations on purchasing the OZ-5500 Organizer.

Please read this operation manual thoroughly to familiarize yourself with all the features of the unit and to ensure years of reliable operation. You may also find it useful to keep this operation manual on hand for reference.

Some of the accessories described in this manual may not be available at the time you purchase this product.

Check with your local SHARP dealer concerning availability.

All company and/or product names are trademarks and/or registered trademarks of their respective manufacturers.

## NOTICE

- SHARP strongly recommends that you keep separate permanent written records of all important data. Data may be lost or altered in virtually any electronic memory product under certain circumstances. Therefore, SHARP assumes no responsibility for data lost or otherwise rendered unusable whether as a result of improper use, repairs, defects, battery replacement, use after the specified battery life has expired, or any other cause.

- SHARP assumes no responsibility, directly or indirectly, for financial losses or claims from third persons resulting from the use of this product and any of its functions, such as stolen credit card numbers, the loss or alteration of stored data, etc.
- The information provided in this manual is subject to change without notice.

# Contents

<b>Introduction</b> .....	<b>1</b>	Setting the Start-up Display .....	48
<b>Contents</b> .....	<b>2</b>	Setting the Password and Locking the Organizer .....	49
<b>Quick Start</b> .....	<b>8</b>	Setting the World City .....	49
<b>Answers to Commonly Asked Questions</b> ....	<b>32</b>	To start working with the Organizer .....	49
<b>What Your Organizer Can Do</b> .....	<b>36</b>	Turning the Organizer on and off .....	50
<b>About this Manual</b> .....	<b>37</b>	Setting the LCD contrast to suit various lighting conditions .....	50
<b>Conventions Used in this Manual</b> .....	<b>39</b>	Turning off the initial display .....	50
<b>Caring for the Organizer</b> .....	<b>40</b>	Turning the key beep on and off .....	51
<b>Chapter 1 Getting Started</b> .....	<b>41</b>	<b>Getting to Know Your Organizer</b> .....	<b>51</b>
Part Names and Functions .....	42	Applications .....	51
Getting the Organizer Up and Running .....	43	Menu operations .....	52
Installing the batteries .....	43	Pop-up menus .....	52
Initializing .....	44	The keyboard .....	52
Setting up the Organizer after Initialization .	45	Display symbols .....	53
Welcome messages and instructions .....	45	Built-in help and other messages .....	53
Setting the Owner's Information .....	45	<b>Chapter 2 General Operation</b> .....	<b>55</b>
Setting the Clock .....	46	Opening an Application .....	55
Setting the User's Preferences .....	47	Selecting the Display Modes .....	56
Tel/User File Templates .....	47	Index mode .....	56
		View mode .....	57
		Edit mode .....	57
		Creating a New Entry .....	58

Editing an Existing Entry .....	59	The Monthly view .....	70
Editing Techniques .....	59	The Monthly view: Monthly Goals display .....	70
Fields .....	59	The Weekly view .....	71
The cursor .....	60	The Daily view .....	71
Typing in text .....	60	Finding entries using the Calendar views .....	72
Moving around the display .....	61	Selecting a date .....	72
Inserting and overwriting text .....	61	Making new Schedule, To Do and	
Deleting text .....	61	Ann entries .....	72
Working with blocks of text .....	61	The Calendar application menu .....	73
Scrolling the display .....	62	The Schedule Application .....	74
Finding Specific Entries in Your Organizer ..	63	Making new entries .....	74
Using Index mode .....	63	Finding Schedule entries .....	75
Using keywords .....	63	Moving appointments and editing entries .....	75
By date .....	64	Deleting entries .....	76
Deleting Entries .....	65	Selecting a specific date .....	77
Deleting single entries .....	65	Making entries for recurring and extended	
Deleting entries using the application menu ..	65	events .....	77
Checking the Time and Date .....	66	Setting a Schedule alarm .....	79
Checking the Memory .....	67	The Schedule application menu .....	80
The TOOLS Menu - the Organizer's Basic		The To Do Application .....	80
Utilities .....	68	Making new entries .....	80
<b>Chapter 3 Time Management .....</b>	<b>69</b>	Finding entries using Index mode .....	82
The Calendar Application .....	69	Controlling how the Calendar displays	
Selecting a Calendar view .....	69	To Do information .....	83
		Using keywords .....	83

Editing entries .....	84	Customizing the Index display .....	101
Checking off completed entries .....	84	Modifying the Index sort order .....	101
Using categories .....	85	Modifying the templates .....	102
Deleting To Do entries .....	88		
The To Do application menu .....	89	<b>Chapter 5 Memo and Outlining .....</b>	<b>103</b>
The Ann (Anniversary) Application .....	90	The Memo Application .....	103
Making new entries .....	90	Creating documents .....	103
Finding entries .....	91	Finding entries .....	104
Editing Ann entries .....	92	Editing Memo entries .....	105
Deleting Ann entries .....	92	Deleting Memo entries .....	105
The Ann application menu .....	93	Changing the way text is displayed .....	106
		Turning word wrap on and off .....	107
<b>Chapter 4 Creating Your Own Database .....</b>	<b>95</b>	The Memo application menu .....	107
The Tel and User File Applications .....	95	The Outline Application .....	107
Selecting a file .....	96	Creating an outline .....	107
Creating new entries .....	96	Locating outlines .....	109
Finding entries .....	96	Displaying full topics .....	109
Editing entries .....	97	Revising outlines .....	110
Deleting file entries .....	98	Deleting Outline topics .....	112
The Tel application menu .....	98	Using subtopics (children) .....	113
The User File application menu .....	98	The Outline application menu .....	116
Customizing the Tel and User File		<b>Chapter 6 Desk Accessories .....</b>	<b>117</b>
Applications .....	99	The Calc (Calculator) Application .....	117
Changing file names .....	99	Using the arithmetic calculator .....	117
Configuring fields .....	100	The paperless printer .....	118

Calculating dates .....	120
Using the Calculator with other applications .....	121
When E appears .....	122
Cost/Selling price/Markup and Cost/ Selling price/Margin calculations .....	122
Setting the number of decimal places .....	123
Calculation examples .....	124
The Calc application menu .....	125
<b>The Clock Application .....</b>	<b>126</b>
Changing the Local city .....	126
Setting the time and date .....	127
Checking the time in a city .....	128
Adding a User-defined city .....	129
Daylight Saving Time (DST) .....	130
Setting daily alarms .....	130
The Clock application menu .....	132

## **Chapter 7 Money & Account**

### **Management .....**

<b>Money Tracking application .....</b>	<b>133</b>
What it can do .....	133
Introducing Money Tracking concepts .....	133
Things to Know about Money Tracking .....	134
Setting up Money Tracking accounts .....	135

Viewing account information .....	137
Editing or viewing account details .....	137
Entering Money Tracking transaction .....	137
Viewing account transactions .....	140
Displaying transactions in detail:	
View mode .....	141
Editing/updating existing transactions:	
Edit mode .....	141
Listing all transactions .....	142
A closer look at Money Tracking transactions .....	142
Using the Filter to display selected transactions .....	143
Canceling an active Filter .....	145
<b>About Categories .....</b>	<b>145</b>
Using the pre-defined Categories .....	145
Adding your own Categories .....	146
Editing Category names .....	146
Using Categories .....	147
The SPLIT function .....	147
Automatic transfers .....	149
Making a transfer for a SPLIT transaction ...	151
<b>Account balancing &amp; reconciliation .....</b>	<b>152</b>
Performing account balancing .....	152
Marking transactions as CLEARED .....	152

Postponing the ACCOUNT BALANCING procedure .....	153
Balancing the account and reconciling the transactions .....	154
Handling unbalanced accounts .....	155
Removing transactions after account balancing .....	156
When the Organizer is Locked .....	156
Deleting Money Tracking entries .....	157
Money Tracking application menu .....	160

## **Chapter 8 Features and Utilities for**

<b>Added Power .....</b>	<b>161</b>
Copying or Moving Blocks of Text .....	161
Copying or Moving Entries .....	162
The Time Stamp and Date Stamp Functions .....	163
The Word Key .....	164
Defining your words or phrases .....	164
Inserting a word or phrase .....	164
Editing a word or phrase .....	165
Deleting a word or phrase .....	165
The Filter Function .....	165
Turning the Filter on .....	165
Turning the Filter off .....	166

Deleting filtered entries .....	166
Special Characters .....	167

## **Chapter 9 Using the Optional**

<b>Peripherals .....</b>	<b>169</b>
The Peripherals Menu .....	169
Printing from the Organizer .....	170
Setting printer emulation .....	170
Printing the current display .....	171
Printing a single entry .....	171
Printing a specified group of To Do entries .....	171
Printing Schedule entries for specific periods .....	172
Printing all entries .....	172
Transferring Data .....	173
Transferring between OZ-5500 Organizers .....	174
Exchanging data with other Organizers .....	176
The IN BOX and IN BOX VIEWER .....	178
Removing entries to their destination application .....	178
Assigning entries to IN BOX from applications .....	179
Exchanging Information with a Personal	



Computer .....	180	B. Resetting the Organizer .....	196
Points to remember when using		All reset operation .....	197
peripherals .....	181	C. Troubleshooting .....	198
<b>Chapter 10 Personalizing Your</b>		D. Battery Replacement .....	198
<b>Organizer .....</b>	<b>183</b>	General guidelines .....	198
The Start-Up Display .....	183	Replacing the operating batteries .....	199
Selecting the start-up display .....	183	Replacing the memory backup battery .....	200
Responses to the start-up display .....	184	E. Specifications .....	202
Setting the Owner's Information .....	185	<b>Index .....</b>	<b>205</b>
Locking the Organizer .....	186		
Turning on the Lock .....	186		
Marking/unmarking entries as Secret .....	187		
Accessing Secret entries .....	187		
Automatic Relocking .....	188		
Changing or deleting the password .....	188		
If you forget your password... ..	188		
Changing the Calendar Display Format ....	189		
Setting the monthly format .....	189		
Setting up the default Calendar view .....	189		
Setting up the date format .....	190		
Selecting the Bold display font .....	190		
<b>Appendices .....</b>	<b>191</b>		
A. List of Key Notations .....	191		

# Quick Start

## Important things to do

1. Complete and return the Blue registration card. This allows Sharp to notify you of new products and accessories for your Organizer as they become available.
2. Please read through this Quick Start section. Even if you hate reading manuals, this section will get you up and running with your Organizer in just a few minutes. The Organizer has been carefully designed to be extremely easy to use, but it will help you greatly to go through this quick introduction to setting up and using your Organizer.
3. Read through the section for answers to commonly asked questions. There is a good chance that many general questions you may have about your Organizer will be answered in this section.
4. Press **2nd** **H**<sup>HELP</sup> any time you need help using a particular application on the Organizer. The on-screen help facility provides you with a quick reference guide explaining various options and their functions.

## Installing or replacing the batteries

1. Set the battery replacement switch on the bottom of the Organizer to "REPLACE BATTERIES" (so the red dot appears). (Fig. 1)
2. Remove the operation battery cover and remove old batteries. (Fig. 1)

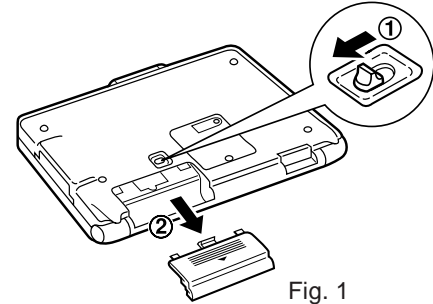

Fig. 1

3. Insert the two batteries on top of the ribbon tab, as shown in the diagram (Fig. 2)

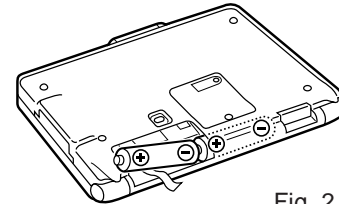

Fig. 2

4. Replace the operation battery cover. (Fig. 3)
5. Set the battery replacement switch to "NORMAL OPERATION". (Fig. 3)

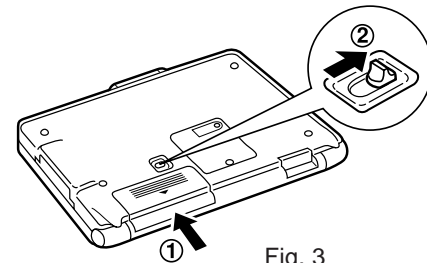
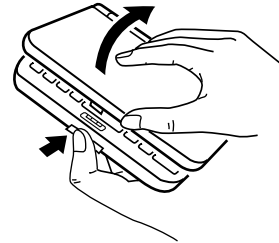

Fig. 3

## Initializing the Organizer

After you install the batteries for the first time, you must initialize the Organizer before using it.

1. Press the LOCK button and open the Organizer.



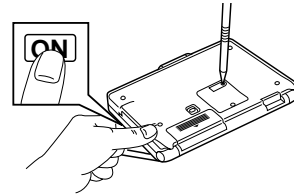

2. While holding down the **ON** key on the keyboard, push the RESET button on the back of the Organizer with a pen or a similar object.



3. When the confirmation message appears, press **Y** to initialize the Organizer.

The Organizer then takes you through the set up procedure, starting with adjusting the LCD contrast.

#Q-3-3

4. Press  or  to adjust the LCD contrast to your liking.

#Q-3-4

5. Press .

You may have to wait for about 10 seconds before the next screen appears.

Note that the Start-up continues with “Setting up the Organizer” on p.12.

## Setting up the Organizer

After initializing the Organizer and adjusting the LCD contrast, or after restarting with the SET UP option selected for START-UP mode, the following steps occur.

1. The welcome screen appears, introducing you to the Organizer's features. Press **ENTER** to continue.
2. After the User Setup introduction appears, press **ENTER** to continue.
3. After you have read the User Setup Basic Instructions, press **ENTER** to continue.
4. Enter the Owner Information, pressing **NEXT** to move to the next field. (Don't worry if you make a mistake, you can change the Owner Information anytime; see Chap.10.)
5. Press **ENTER** to store the information you entered.
6. After the Owner Information confirmation screen appears, press **ENTER** to proceed with setting the Clock.

#Q-4-1

#Q-4-2

#Q-4-3

7. You must select your local city before setting the time. If your city is not shown, press **[SPACE]** and select USER CITY2, then set up your city later (see “Adding a User-defined city” in the **Clock** application, Chap.6).

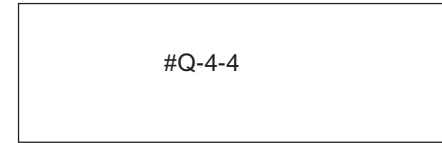

8. Press **[ENTER]** when your city is selected.

9. If your country is currently using Daylight Saving (Summer) Time, press **[Y]**, otherwise press **[N]**.

10. Next, enter the current time in your city, then press **[NEXT]**.

Single-digit hours or minutes should be preceded by “0”, eg. 0533. Press **[AM]** or **[PM]** for AM or PM respectively.

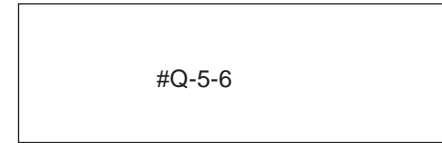

11. Select the time system you want to use, ie. 12- or 24-hour clock. Press **[NEXT]**.

12. Press **[~]** and select today's date from the pop-up calendar, then press **[ENTER]**.

Use **[PREV]** and **[NEXT]** to select the month and the cursor keys to select the day.

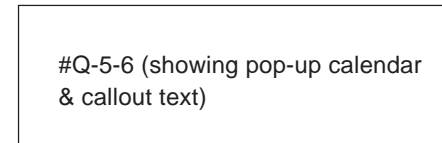

13. Press **[ENTER]** to save.

14. The User Setup screen is displayed. After reading, press **[ENTER]** to continue customizing your unit with User's Preferences.

# User's Preferences

#Q-6-2

## 1. TEMPLATES

Built-in templates have been created for the **Tel** and **User File** applications. There are three telephone files and three user files that can be customized to meet your specific needs.

To customize your **Tel** files highlight TEL TEMPLATE and press **ENTER**. Use the cursor to highlight the file you would like to customize. Press **~** to bring up a list of template options. Highlight your choice and press **ENTER** to save.

To customize your **User File** files, highlight USER FILE TEMPLATE and press **ENTER**. Follow the steps above.

## 2. START-UP DISPLAY

Highlight START-UP DISPLAY and press **ENTER**. This allows you to choose what you want to see when you turn on the Organizer. Highlight your choice and press **ENTER** to save.

START-UP	ON: displays Owner Information on start-up and requires password if ASK PASSWORD is set to ON.
	OFF: Background appears only.
	SETUP: displays User Setup screens on start-up.



BACKGROUND – User can select the background to be displayed on start-up.

ASK PASSWORD – ON: A password is required on start-up if START-UP is also set to ON.  
OFF: No password is required.

### 3. MORE CLOCK SETTINGS

Allows you to choose the World city to be used in the clock display. Use **PREV** and **NEXT** to scroll through the cities. Highlight your choice and press **ENTER** to save.

### 4. LOCK ORGANIZER



Allows you to assign a password which will be needed in order to access entries marked as Secret.

### 5. START ORGANIZING

At any time you can start to actually use the Organizer by highlighting START ORGANIZING and pressing **ENTER**.

The **Calendar** application opens with today's date selected.

## Making your first entry (in the Tel application)



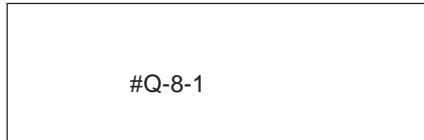

1. Press .
2. Press .
3. Type in the name, telephone number and address of the person or company you want to store.



#Q-8-1



The dark outline around a field indicates that it is selected for entering information.

Indicates that the entry is in Edit mode, so it is being added or can be modified.

Use  to move between fields. Use  or  to correct mistakes. Use  to move to a new line in the name and address fields.

4. Press  when finished to store the new entry.

## Recording an appointment

1. Press  <sup>SCHEDULE</sup>, then press **NEW**.
2. Today's date has been given automatically. If you want to use a different date, move up to the DATE field and press .  
  
Press **NEXT** or **PREV** to select the desired month, then use the arrow keys to select the day of the appointment. Press **ENTER** when done.
3. Move to the TIME field and type in the start and end times for your appointment, then press **NEXT**.
4. Type in a description for the appointment (eg. "Meeting with John").
5. Press **ENTER** to store the entry.

#Q-9-1

#Q-9-2

## Changing an appointment

Appointment times can frequently change. Instead of re-typing a new appointment and deleting the old one, you can change an existing appointment easily.

1. Find the **Schedule** entry you want to move.
2. Press **EDIT**.
3. If the appointment time has changed, enter the new start and/or end times.
4. If the date has changed, move to the DATE field, press **~** and select the new date from the pop-up calendar, then press **ENTER**.
5. Press **ENTER** to store the revised appointment.

#Q-10-1

#Q-10-2 (showing pop-up  
calendar and new date selected)



#Q-10-3 (with new date)

## Entering a To Do item

1. Press  then press **NEW**.
2. Enter a description of the task to be done, then press **NEXT**.
3. Enter the DUE DATE, which is the date by which the task must be completed.

#Q-11-1

You can assign a priority number which can be used to sort the entries in Index mode.

Press   to mark any entry as completed.

Up to five category fields can be used to selectively access groups of entries using the Filter function.

4. If desired, enter any other information.
5. Press **ENTER** to store the entry.
6. Press  .  
The **To Do** index appears, showing you the list of all **To Do** items.

#Q-11-2

## Using the Calendar views

The **Calendar** provides three different views: Monthly, Weekly and Daily. Each of these views allows you to see information stored using the **Schedule**, **To Do** and **Ann** applications.

1. Press **Calendar**. If the Monthly view does not open, select it by pressing <sup>PC-LINK</sup> **MENU**, selecting VIEWS and then MONTHLY.

White-on-black display indicates an **Ann** entry recording an anniversary or some other annual event.

An exclamation mark indicates a **To Do** item on this day.

An upper dot indicates a **Schedule** entry during the morning.

A lower dot indicates a **Schedule** entry during the afternoon or evening.

#Q-12-1

If you de-select HIDE MONTHLY GOALS from the menu, the next-month view will be replaced by the MONTHLY GOALS.

2. Use the cursor to highlight a date, then press **ENTER** to switch to the Weekly view.



#Q-12-2

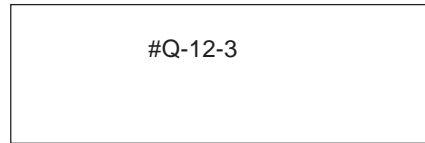

Press **▶** to display additional information for this day.

3. Use the cursor to move to a selected day of the week, then press **ENTER** to switch to the Daily view for that day.



Shaded areas on the time bar indicate appointments. Black areas indicate appointment conflicts.

Press   to mark the selected entry as completed.

4. Use  and  to select an entry, then press **ENTER** to display its full details in the application used to create it.

You can also switch views by pressing .

You can press **NEW** to open CALENDAR ACTIVITIES, which allows you to make a new entry for the **Schedule**, **To Do** and **Ann** applications.

## Editing an entry

1. Find an entry that you wish to change (a change of address in the **Tel** application is shown here as an example).
2. Press **EDIT** to go to Edit mode.
3. Move to the field you want to change.

#Q-14-1 (TEL entry with description highlighted)

4. Make any desired changes.

NOTE: You can clear any field by pressing **↑** **NEW**. You can highlight any text using **↑** and the cursor keys, and then delete the text (by pressing **DEL**) or cut the text (by pressing **2nd** **X**<sup>CUT</sup>) to paste it elsewhere.

If you make a mistake and want to restore the original entry, simply press **CANCEL** **ON**.



## Deleting an entry

1. In any application, select an entry that you want to delete in Index mode, or display it in View mode.
2. Press .

A confirmation message appears.



#Q-15-1

3. Press  to confirm the deletion.

## Deleting multiple entries

1. Switch to the application in which you want to delete multiple entries.
2. Press <sup>PC-LINK</sup> and select DATA DELETION then press .
3. Select the group of entries you want to delete and press .  
(The menu choices will vary depending on the application.)
4. A confirmation message will appear. Press  to delete the selected items.

#Q-15-2

## Searching for information anywhere in the Organizer

1. Press **2nd** **S**<sup>SEARCH</sup>.
2. Type in any text stored in the entries you want to find.
3. Press **▬** and select the application to want to search in using **▼** and **▲**, then press **ENTER**.

The application you were using last will always appear as the default.

4. Press **ENTER** to begin the search.
5. Press **NEXT** to see additional entries that contain the searched text, then press **ENTER** when you find the desired entry.

#Q-16-1

#Q-16-2

## Finding an entry using Index mode

The Index modes for **Schedule**, **Tel**, **User File**, **Ann**, **Memo**, **Outline**, and **Money Tracking** are very similar.

1. Select an application and press   to go to Index mode if it is not already displayed.

#Q-17-1

2. Use  and  to scroll through the list until you find the entry you want.

Type the first letter of the entry to jump to the closest position in the Index list.

3. Press  to view the desired entry once it is selected.

#Q-17-2





You can also press  to edit the entry, or  to delete it.

## Copying and pasting text between applications

You may want to copy text from one place to another in the Organizer.

1. Display in Edit mode the entry containing the text you want to copy.
2. Move to the start of the text you want to copy.
3. While holding down , use the cursor keys to select the text you want to copy.

Selected text is displayed in reverse (white-on-black).

4. Press   to copy the selected text.
5. Display in Edit mode the entry to which you want to add the copied text.
6. Move the cursor to the position you want the copied text to begin, and press  .

#Q-18-1

#Q-18-2





#Q-18-3

## Using the Calculator

In addition to working like a standard calculator, the Organizer's **Calculator** can work with figures created in another application.

1. In Edit mode, find an entry containing some figures you want to calculate.
2. Use  and the cursor keys to select the figures.

#Q-19-1



3. Press   to copy the figures.
4. Press  repeatedly until the **Calculator** screen appears.
5. Press  to bring in the copied figures to the **Calculator**.

#Q-19-2

You can use the result to perform any other calculations you wish.

# Creating a new Money Tracking account

Accounts must be set up before new transactions can be entered.

1. Press  .
2. Press , select SET UP ACCOUNT and press **ENTER**.
3. When the ACCOUNT LIST appears, press **NEW**.
4. Enter the name you want to give the new account, then press **NEXT**.
5. In the TYPE field, press  and select the account type from the pop-up list, then press **ENTER** followed by **NEXT**.

The type of the account affects the way in which the account is used. (See Chap.7 for an explanation of account types.)

#Q-20-1

#Q-20-2

6. Press **ENTER** to store the account.









If a BANK or CREDIT CARD account, enter the account's opening balance as it appears on your latest statement.

Enter any important account information, such as the account number.

Enter any other useful information describing the account.

## Entering a new Money Tracking transaction

You can keep track of your account activities by entering transactions.

1. Press  .
2. Press , select SET UP ACCOUNT and press  .
3. From the ACCOUNT LIST, select the account for which you want to enter the new transaction, then press  .
4. Press  to start entering a new transaction.
5. Today's date appears in the DATE field as the default, but it can be changed if desired. Press  when done.  
  
To change the date, press  and use the cursor keys to select the desired date from the pop-up calendar, then press  .
6. Enter any other information desired in the appropriate fields, pressing  to move to the next field.

#Q-21-1



7. After you enter the AMOUNT, press **NEXT**. The remaining fields are displayed.

#Q-21-2

Use **←** and **→** to select. Wording used varies according to account type, although the debit appears on the left and credit on the right.

Correct punctuation is inserted automatically.

Optional category used to select certain groups of entries using the Filter.

Enter any text you want to describe the transaction.

Used for account balancing; change this to CLEARED when you have checked the transaction on your statement (if applicable).

8. Select an optional CATEGORY by pressing **~**, or type in a new category name. Press **NEXT**.
9. Enter additional information in the SPECIAL field if desired.
10. Press **ENTER** to store the transaction.

# Answers to Commonly Asked Questions

**Q: My batteries only lasted for two months. Is there something wrong? Will I lose data in memory when I change the batteries?**

A: There is probably nothing wrong with your Organizer. Battery life will vary from user to user. A number of factors will affect battery life, especially how much the Organizer is used. The battery life is rated at 70 hours of continuous use. Assuming an average of one hour per day of continuous use, you would get about two months of battery life.

When you change the main operating batteries, the back-up battery will protect data in memory. Be sure to follow the directions carefully when changing the batteries.

An optional battery case is available, which will extend the life of your operating batteries.

**Q: I have an older model of the SHARP Organizer and imported the data into this Organizer. But when I went to the Tel application in my new Organizer, all of my entries looked strange. Some words were split in two and some lines ended too early.**

**The entries don't look like this in the other Organizer. What can I do?**

A: In certain applications, such as Tel, the number of characters allowed per line is different from that of other Organizer models. This means that the new line characters you entered in the older Organizer will not produce the same formatting in this unit. You will need to edit the relevant entries and reformat them by deleting old new line characters and entering new ones.

**Q: I saw the message "There is not enough memory..." after trying to store an entry. What does this mean?**

A: You have filled your unit with information. Here are some things you should try in order to free up some memory:

1. Check for old Schedule items. Delete those you no longer need. You can delete all Schedule entries for an entire month using the Calendar menu.
2. Check for completed To Do items. You can delete all completed To Do items using the To Do menu.
3. Check for old Money Tracking transactions. If they have cleared, you should remove them after performing Account Balancing.

**Q: I want to print out my information. What do I need?**

A: Here are the things you will need:

1. The SHARP CE-IR1 wireless interface for printers.
2. A standard PC printer cable.
3. Any parallel PC printer that emulates one of the following printers:

Canon	BJ-10e series
IBM	ProPrinter series
Epson	FX series, LQ series
Hewlett-Packard	LaserJet series

Most printers, including portable ink-jet printers on the market today, emulate at least one of these printers. Check with your local computer dealer for more information about printers.

**Q: How can I back up my data?**

A: It is important to always have a back-up of your important information. Here are some ways of doing this:

1. You can print out a hard copy using the optional accessories. See p.170.
2. You can use PC or Macintosh link software either

from SHARP or a third party. You will also need one of the various PC-Link cables or the CE-IR2 wireless interface for computers. Check with your local dealer regarding features and availability of these products.

**Q: I can't seem to turn my Organizer on. I changed the batteries but still nothing happens. What should I do?**

A: Check the following before sending the unit in for service:

- c Check that the battery replacement switch on the back of the unit is in the NORMAL OPERATION position. If the switch is in the REPLACE BATTERIES position, the Organizer cannot be turned on.
- c Check or replace the operating batteries, even if you have just replaced the batteries. It is possible that the batteries were not fresh when you purchased them.
- c Press the RESET switch. If the Organizer has been dropped, for example, it may have to be reset. This will not delete your data (as long as you type **N** at the Initialization prompt). If for any reason data is missing after resetting the Organizer, it was lost before you pressed the RESET switch. The RESET

switch simply re-starts the Organizer.

If none of the above procedures work, you will need to send the Organizer to a service center. Check the back page of this operation manual for the location of your nearest service center and call for more information.

**Q: What happens if I am working on an entry and the auto power off function shuts off the Organizer before I store the entry?**

A: You will not lose any information. The next time you turn the Organizer on you will be able to resume exactly where you left off.

**Q: Why should I send in the Blue registration card included with the Organizer?**

A: This is your way of registering your product with SHARP, and allows SHARP to keep you informed about new products and software available for your Organizer. It also gives SHARP valuable information about our users so that we can design products that continue to meet your needs.

**Q: What is the Outline application? Why would I want to use it instead of Memo?**

A: The Outline application allows you to group and categorize information using a hierarchical structure. Everyone has a lot of small but important pieces of information that have to be memorized or kept track of in a written record, for example, important personal information: Social Security number, credit card numbers, various ID numbers, account numbers, clothing sizes, etc. Using the Organizer, you could make a number of Memo entries for each piece of information, but a better way to manage the information would be to make a single Outline file called "Personal Information". This file could then contain a number of headings (such as Car info., Travel info., Health info., Financial info., etc.), under which relevant pieces of information could be stored. This makes it easier to access information and prevents your Organizer from becoming cluttered with hundreds of individual entries. Additional Outline files could also be made, including: favorite movie list, project management file, To Do lists, price lists, product line-up and specification file, business plans, product proposals, and meeting notes. Many types of information can be more easily and efficiently managed in an Outline structure.

Another use of the Outline application is document

preparation. Many times you might want to write a memo, letter, proposal, marketing plan, etc., but find it difficult to write an entire document from scratch. The Outline application allows you to capture your thoughts and ideas, then rearrange and categorize them at any time. You can also copy an Outline file and paste it into the Memo application to finish the document there, adding text to the major topics.

# What Your Organizer Can Do

The OZ-5500 is a full-featured, pocket-size information manager with a large, easy-to-read screen. It provides built-in wireless communications facilities for exchanging data with other compatible Organizers and personal computers.

To help you better manage your time and activities, you can record appointments, meetings, or any other information relating to a specific date in the **Schedule** application; the **To Do** application helps you track tasks and goals arranged in a priority you assign to them; the **Ann** application helps you to remember important annual events such as anniversaries, birthdays or even tax preparations; and the **Calendar** displays your **Schedule**, **To Do**, and **Ann** entries clearly in a daily, weekly, or monthly format.

The **Tel** application is the Organizer's built-in address book, used to store names, phone numbers and addresses, while the **User File** application is a simple and easy-to-use database for any important information, entered into categories you set up yourself. Both can be configured flexibly to store and recall the information most important for you.

The Organizer also provides a useful word processing facility. The **Memo** application allows you to use the Organizer for everything from simple note taking to creating

professional, full-size letters, and the **Outline** application lets you record and organize your thoughts and ideas using topics and subtopics, easily reorganizing them at any time.

The **Calculator** performs a full range of mathematical functions as well as convenient date and cost calculations, and the built-in **Clock** keeps track of both local and international time.

The Organizer's **Money Tracking** application allows you to monitor and manage your business and personal finances.

The Organizer combines quick access to your information with the ability to search files using a keyword or heading. The Filter function makes it possible to select and work with specified entries. You can also share information within or between entries and files. And when a printer is connected to the Organizer (using the optional CE-IR1 wireless interface), you can print your information.

# About this Manual

This manual is designed to help you to fully understand the features and use of your Organizer. The first two chapters provide a general introduction and instructions about set-up and initialization, including an overview of the keyboard, the display, and the operations.

Other chapters are organized according to the type of task (for example, **Time Management** and **Creating Your Own Database**), so that you can concentrate on those functions and features that you specifically need.

This manual consists of 10 chapters and a set of appendices:

## Chapter 1. Getting Started

Introduces part names and functions, and shows you how to set up and initialize the Organizer, including how to install the batteries and set the built-in clock.

## Chapter 2. General Operation

Introduces the Organizer's basic concepts and operations, including opening an application, using menus, and the built-in help feature.

## Chapter 3. Time Management

Explains those features that help you structure your time

and keep track of appointments and important events: the **Calendar**, **Schedule**, **To Do**, and **Ann** applications.

## Chapter 4. Creating Your Own Database

Explains the **Tel** and **User File** applications, which not only store information such as addresses and phone numbers, but can also be configured to manage almost any type of information.

## Chapter 5. Memo and Outlining

Explains the **Memo** application, and how to structure your ideas and writings using a simple outline form in the Outline application.

## Chapter 6. Desk Accessories

Explains the **Calculator** and **Clock** applications that can be used whenever they are needed.

## Chapter 7. Money & Account Management

Explains the **Money Tracking** application, the Organizer's sophisticated money and account management utility.

## Chapter 8. Features and Utilities for Added Power

Explains how to copy information and other useful features and utilities, filtering selected entries, and more.

## **Chapter 9. Using the Optional Peripherals**

Explains how to print using the Organizer and how to transfer data to and from other Organizers (including previous models).

## **Chapter 10. Personalizing Your Organizer**

Explains how to change the opening display and **Calendar** display format, and how to use the Secret function as well as the password security.

## **Appendices**

- A List of Key Notations
- B Resetting the Organizer
- C Troubleshooting
- D Battery Replacement
- E Specifications



# Conventions Used in this Manual

The following keyboard and symbol conventions are used throughout this manual:

**ON**, **ENTER** and other similar notations indicate keys on the keyboard that should be pressed to perform operations.



Letters and numbers to be entered in examples are shown in italics. For example: *lunch* indicates that l-u-n-c-h should be typed. Words shown in bold letters such as **Calendar** indicate names of applications. Words shown in UPPERCASE indicate menus or menu functions.

Some keys have more than one function, accessed by using them in combination with **↑** or **2nd**. 'H', for example, accesses the HELP screen when the **2nd** key is used with it. When a key's second function is referred to in an explanation, only that function is shown, not the key itself. For example, the instruction to see the HELP screen would be shown as **2nd** **HELP**, not as **2nd** **H**.

The  symbol indicates a tip or an important point you should note.

The Organizer often lets you perform operations in more than one way. These alternatives are indicated by the  symbol.

Cross-references to helpful information elsewhere in this guide are marked by the  symbol.

-  Information messages displayed for the user are given in quotation marks, eg. "Stored!".
-  For a full list of key notation, see Appendix A, p.191.

# Caring for the Organizer

The Organizer contains sophisticated circuitry and a glass display panel which can be damaged if not handled with care. A few precautions should be taken regarding the Organizer's care to ensure it gives you many years of reliable and trouble-free use.

- Keep the Organizer away from extreme heat. Do not leave it on the dashboard of a car or near any source of heat. Do not leave it in any place that is extremely damp or dusty.
- Do not drop the Organizer or subject it to severe impact or extreme force. Bending the Organizer unduly can damage it.
- Do not use extreme force when pressing the keys. Do not use any sharp, pointed object or even your fingernails to press them.

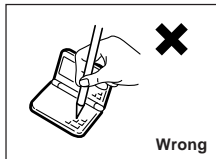
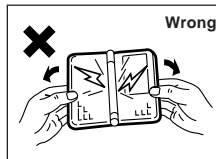
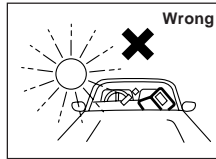

- Sharp or hard objects can scratch and damage the Organizer. Make sure it is adequately protected when carried with other objects. Do not carry it loose in a bag or briefcase: find a pocket or secure compartment within your bag.

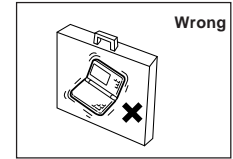

- Clean the Organizer only with a soft, dry cloth. Do not use solvents.

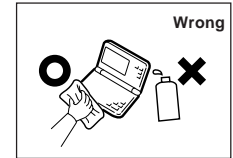

- Do not carry the Organizer around in your back pocket, as it may break when you sit down. The display is made of glass and is very delicate.

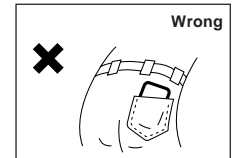

- ➡ Replace the batteries as soon as they become weak (see p.198). Failing to replace weak batteries may result in leakage or lost data.

# CHAPTER 1

## Getting Started

This chapter explains everything you need to know to set up and begin working with your Organizer, from installing the batteries to initialization. The chapter also includes a labeled illustration of the parts of the Organizer, and basic explanation of its key features, from the keyboard to the display and its symbols.

## Part Names and Functions

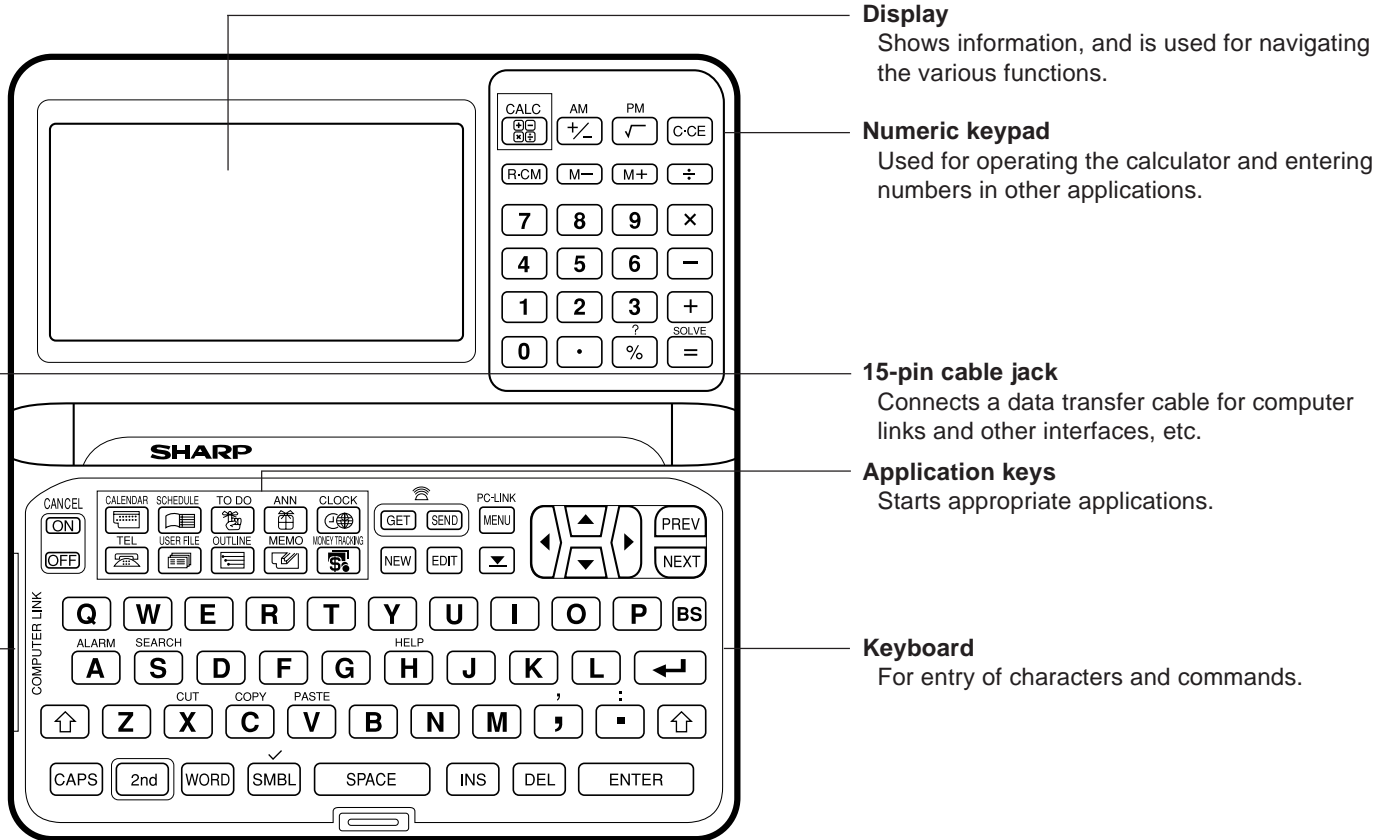

### Display

Shows information, and is used for navigating the various functions.

### Numeric keypad

Used for operating the calculator and entering numbers in other applications.

### 15-pin cable jack

Connects a data transfer cable for computer links and other interfaces, etc.

### Application keys

Starts appropriate applications.

### Keyboard

For entry of characters and commands.

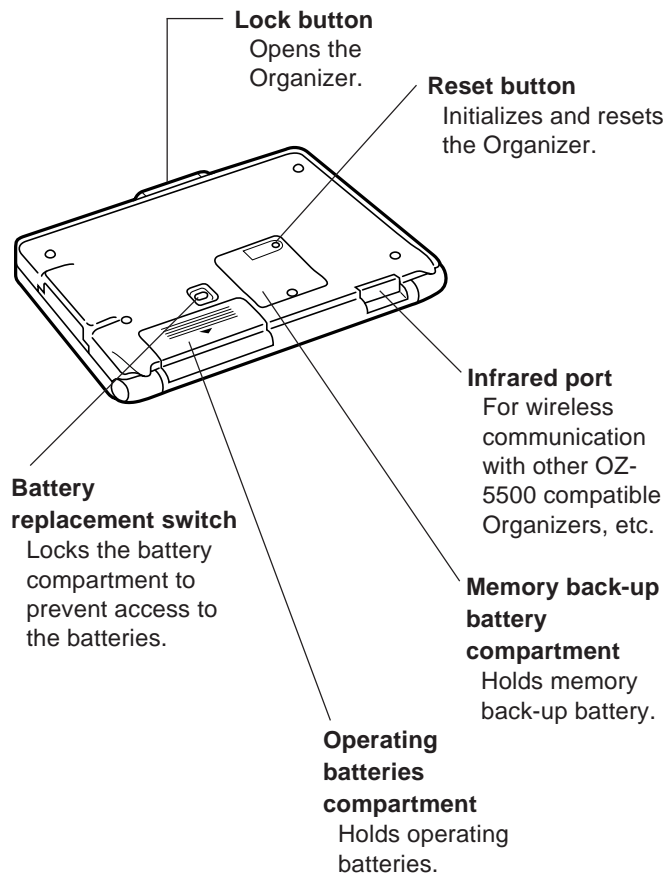

## Getting the Organizer Up and Running

### Installing the batteries

1. Set the battery replacement switch on the back of the Organizer to REPLACE BATTERIES (the red dot becomes visible).
2. Slide off the operating batteries cover.

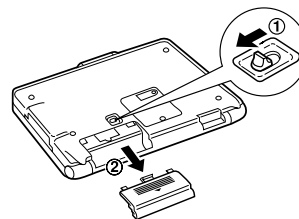

3. Insert the two batteries on top of the ribbon tab, making sure they are positioned correctly according to plus (+) and minus (-) polarity, as shown below.

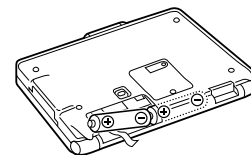

4. Replace the cover.
5. Set the battery replacement switch back to NORMAL OPERATION (the red dot disappears).

☞ The Organizer will not function unless the battery replacement switch is in the NORMAL OPERATION position.

The Organizer then automatically starts the SETUP utility, so that the owner information, the time and date and various other settings are defined before use.

## Initializing

The Organizer must be initialized when it is used for the first time.

1. Press and hold the **ON** key.
2. While holding down the **ON** key, push the RESET button on the bottom of the Organizer using a pen or some other pointed object. The following message will appear.

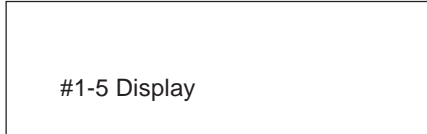

3. Press **Y** to initialize the Organizer.

The LCD Contrast screen then appears.

4. If the display is not clear, press **~** and **↵** until the display is satisfactory.
5. Press **ENTER** when ready.

The message "Working..." appears for at least 10 seconds while the Organizer proceeds with the initialization procedure.

## Setting up the Organizer after Initialization

The Organizer takes you through the various steps needed to set up the Organizer before use. These steps are described below. We strongly recommend that you complete the entire SET UP procedure before starting to actually use your Organizer.

- \* Welcome messages and instructions
- \* Setting the Owner Information
- \* Setting the Clock
- \* User's Preferences

### Welcome messages and instructions

After completing the LCD Contrast setting above, the Organizer displays the following welcome message, briefly outlining its functions.



#1-6 Display

Press **ENTER** to proceed with the User Setup.

The User Setup introduction appears to explain the operations you are about to carry out.

Press **ENTER** to continue.

The User Setup Basic Instructions appear to instruct you how to move around the screen during User Setup and

normal use.

You can use **←** **→** **↑** **↓** to move around the screen. You can also use **PREV** and **NEXT** to move from field to field.

Press **ENTER** to proceed with setting the Owner Information (or **CANCEL** to exit the SETUP procedure).

### Setting the Owner's Information

The Owner Information comprises your name, address and telephone number. You can choose to have this information displayed each time you turn the Organizer on.

☞ If you make a mistake while entering the Owner Information, don't worry! You can amend the Owner Information easily during normal use, so just proceed with the rest of the User Setup. (see PREFERENCES, p.185)

1. After pressing **ENTER** after the previous Basic Instructions screen, the Set Owner Information screen appears.



#1-7 Display

2. Enter your name, then press **NEXT**.

The cursor moves to the TEL NO. field.

3. Enter your telephone number, then press **NEXT**.

The cursor moves to the ADDRESS field.

4. Enter your full address.

 Press **↵** to move the start of the next line in ADDRESS.

5. Press **ENTER** when done.

A message appears confirming the Owner Information has now been set.

Press **ENTER** to proceed with setting up the **Clock** as described below (or **CANCEL** to quit the User Setup procedure).

## Setting the Clock

In order for the **Calendar**, **Schedule**, **To Do**, and other time-based applications to work correctly, the built-in clock must be set to the correct time, date and city. The **Clock** application displays the time in two different cities: the Local city, where the user normally lives or works, and the World city, which is any other city of the user's choice. When the Organizer is first initialized, the Local city is automatically set to New York, and the World city is London. Before setting the **Clock**'s correct time, you should first select the Local City for which you want to set the time.

After entering the Owner Information above, the following list of cities appears:

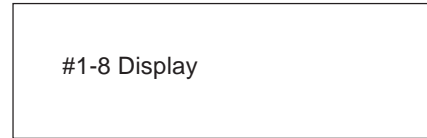

6. If the desired city does not appear, press **PREV** or **NEXT** to display more cities.

 You can jump to a particular country by pressing the first letter of that country's name.

7. Select the desired city by moving the cursor to it.

 If your city does not appear in the list, press **SPACE** to display the User Cities list, then select USER CITY2. You can change the name to your city later, using the **Clock** application menu.

8. Press **ENTER**.

The Daylight Saving Time screen appears.

9. If your city is currently on Daylight Saving Time, press **Y**, otherwise press **N**.

The ADJUST TIME/DATE window then appears.

10. Enter the local time, preceding single-digit hours and minutes with "0".

11. Press **PM** to select PM or **AM** for AM, then press **NEXT**.

12. Select the time system you want the **Clock** to use, then press **NEXT**.



13. In the LOCAL DATE field, press **[ ]** to display the pop-up calendar. Use **[PREV]** and **[NEXT]** to select the current month, then use the arrow keys to select today's date.
14. Press **[ENTER]** once the date has been selected.

The pop-up calendar disappears and the date now appears in the LOCAL DATE field.

15. Press **[ENTER]**.

A message appears briefly to inform you that the time and date have now been set.

A new screen then appears to inform you that the basic setup procedure is now complete, and the Organizer is ready for use. However, there are other areas in which you can customize your Organizer further by setting various options.

Press **[ENTER]** to continue.

## Setting the User's Preferences

The USER'S PREFERENCES display then appears. There are six choices available.

- \* **Tel** Templates
- \* **User File** Templates
- \* Start-up Display
- \* Lock Organizer
- \* More Clock Setting
- \* START ORGANIZING

If you do not wish to set the User Preferences at this time, select START ORGANIZING and press **[ENTER]**. The **Calendar** application display then appears, and you can begin to use your Organizer.

To set one of the User Preferences, move to the appropriate option and press **[ENTER]**.

## Tel/User File Templates

The **Tel** and **User File** applications each support three files, called 1, 2 and 3, each of which can be used to store different kinds of information. The Organizer comes with six different pre-defined formats which allow you to choose what kind of information you want to store in each of the files. See chapter 4, p.95 for details of the various templates.

### For SELECT TEL TEMPLATES

- File 1 = "TELEPHONE"
- File 2 = "CONTACTS"
- File 3 = "PERSONAL".

### For SELECT USER FILE TEMPLATES

- File 1 = "RESTAURANT"
- File 2 = "HOME INV."
- File 3 = "USER FILE"

Each template contains certain fields which determine the kind of information that can be stored in the file. You can change your mind later and switch to using a different template, but some data in your existing entries may be lost as a result.

1. With File 1 selected, press .

The pop-up template list appears.

If you wish to select a different template, select the desired template from the list and press .

2. Press .
3. Repeat the above steps for File 2 and File 3 if necessary.
4. Press  when done.

## Setting the Start-up Display

You can control the way Organizer behaves each time you turn it on, including the background that appears, whether your personal information is displayed and whether a password is required to access the Organizer's information. The Start-up display offers three options:

ON – The owner information (name, address, tel.) is displayed each time the Organizer is turned on. This will be useful in case you lose the Organizer, as anyone finding it would then be able to return it to you.

OFF – The owner information is suppressed and the Organizer returns to the most recently used application.

SET UP – The Organizer will automatically perform the User Setup and User Preferences procedure (ie.

what you are doing now) the next time it is turned on. However, note that after this has been completed once, the Start-up Display is automatically set to OFF.

1. In the START-UP field, move to the desired option and press .
2. In the BACKGROUND field, you can choose a decorative background to be displayed each time the Organizer is turned on, then press .
3. In the ASK PASSWORD field, select ON if you want to set a password to protect the information in your Organizer from unauthorized access.

 The Organizer only asks for a password if both the START-UP and ASK PASSWORD fields are set to ON.

If you set ASK PASSWORD to ON, you must then select LOCK ORGANIZER from the User Preferences menu, in order to define the password to be used each time the Organizer is turned on.

4. Press  when finished.

The User's Preferences screen reappears.

## Setting the Password and Locking the Organizer

The Organizer provides two levels of security. The first is the password required when the Organizer is turned on whenever the ASK PASSWORD option is set.

The second is the Lock Organizer function, which hides any data entries that have been previously marked as Secret. Once the Organizer is locked, the Secret entries cannot be accessed until the Organizer is Unlocked, for which the password must be given.

Select this option if you want to define a password and lock the Organizer.

1. From the User's Preferences screen, select LOCK ORGANIZER.

The Set Password and Lock Organizer screen appears.

2. Enter the password you wish to use whenever the ASK PASSWORD option is set or in order to unlock the Organizer whenever it has been locked, then press **ENTER**.

A message appears reminding you to remember your password or keep it in a safe place.

3. Press **ENTER**.

The User's Preferences screen reappears.

4. Select LOCK ORGANIZER once again in order to Unlock the Organizer by giving the correct password.

## Setting the World City

As well as setting the Local city previously, you can also select the World city, used to display the time in another city of your choice alongside the Local time. When the Organizer is initialized, the World city is set to London.

To select the World city:

1. Select MORE CLOCK SETTING from the User's Preferences screen.

The CHANGE WORLD CITY screen appears. A list of six capital cities is given, with four cities displayed at one time.

2. If the city you wish to select does not appear in the list, type the first letter of the desired country and select the desired city from the full list.
3. Press **ENTER** once you have selected the desired city.

## To start working with the Organizer

After initialization and the User's Preferences have been set, the Organizer is ready to be used for normal work, such as the entry of information.

1. Select START ORGANIZING.

The **Calendar** application opens in the Monthly view.

2. Select any application you wish to use by pressing the corresponding key.

## Turning the Organizer on and off

Press **ON** to turn the power on and **OFF** to turn the power off. The Organizer will not operate if the battery replacement switch is in the REPLACE BATTERIES position.

### Auto power off

To conserve battery power, the Organizer will turn itself off if it has not been used for about 12 consecutive minutes. However, in order to avoid accidentally interrupting data transfers, the auto power-off function is disabled while communicating with other devices.

If the Organizer's power goes off automatically before an entry you have been working with is stored in an application, the data will not be lost. When you press **ON**, the Organizer will return to the same operating state as before the power turned off automatically.

## Setting the LCD contrast to suit various lighting conditions

From time to time, the contrast of the LCD display may have to be adjusted for ideal readability. You may find, for example, that a contrast setting that was fine for the home or office is not adequate when outdoors or when travelling

on public transportation. Follow the procedure below to adjust the LCD contrast.

1. Press **MENU** three times to open the TOOLS menu.
2. Highlight ADJUST LCD CONTRAST, then press **ENTER**.
3. Adjust the contrast by pressing **+** or **-**.
4. Press **ENTER** when you are satisfied with the contrast.

 If for some reason the display is too light or dark for you to read the display and operate the Organizer, you can adjust the contrast easily by first turning off the Organizer, then holding down **MENU** on the keyboard while pressing **ON**.

## Turning off the initial display

The initial display shows the Owner's Information and today's date, and appears each time the Organizer is turned on, unless the display option is turned off by the user.

You may find that you wish to turn off the initial display, so you can resume work immediately the Organizer is turned on.

### To turn off the initial message:

1. Press **MENU** twice to open the PREFERENCES menu.

2. Select SET START-UP DISPLAY, then press **ENTER**.

The SET START-UP DISPLAY window opens.

3. In the START-UP field, select OFF, then press **ENTER**.

If you make a mistake, press **CANCEL** and start again.

4. Press **ENTER**.

The initial display is now disabled.

→ For more information about configuring the start-up display, see p.183.

## Turning the key beep on and off

The Organizer can be set to make a sound (a beep) each time a key is pressed. This may help you to know whether a key has been pressed properly. The default setting is on, indicated by a musical symbol  $\epsilon$  on the top of the display. You can use the TOOLS menu to change the setting.

1. Press **MENU** three times to open the TOOLS menu.
2. Highlight KEY SOUND ON and press **ENTER** to deselect it. (✓ indicates that the option is currently set.)

The key beep is now turned off and the musical symbol  $\epsilon$  disappears from the top line of the display.

## Getting to Know Your Organizer

The OZ-5500 Organizer is a compact yet sophisticated information management device that you can use anytime, anywhere. Its applications and utilities allow you to enter and organize information, and it has powerful communications facilities that enable you to put that information to optimum use when you return to your home or office. You can quickly update your computerized mailing lists, for example, or print out your weekly schedule, or even transfer your notes, letters and memos onto a PC for further processing. The OZ-5500 even has its own word processor that allows you to create finished documents for printing out later.

## Applications

Operations on the Organizer are performed using applications. The Organizer's **Calendar** and **Schedule**, for example, are applications that record and display time-related information. To start an application, press the corresponding key on the top of the keyboard.

When working in one application, you can switch to another application simply by pressing that application key. Data being processed in the first application will be saved, even if the entry is not complete.

#1-7A

## Menu operations

Another powerful aspect of using the Organizer is its menu system, which can be used to quickly issue commands and perform operations. Two universal menus, PREFERENCES and TOOLS, are available from all applications. In addition, all applications have a menu for functions and commands that are specific to each application.

Pressing **MENU** once displays the application menu, which contains the operations and commands specific to the particular application. Pressing **MENU** successively displays the PREFERENCES, TOOLS and PERIPHERALS menus.

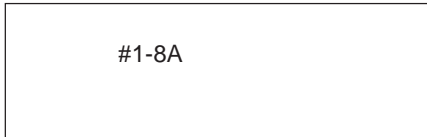

Items that are not currently available in a menu are shown dimmed.

Indicates that there is a submenu for that menu item.

## Pop-up menus

The Organizer's pop-up menus offer a convenient and efficient method of selecting options from pre-defined lists, similar to many of the latest personal computer application software packages. Most applications and functions contain some pop-up fields. When the user moves to one of these fields, the pop-up symbol appears on the right of the field. Pressing **⇧** causes the pop-up menu to appear,

containing a list of options or values currently available for that field. You can then select the desired item from the list, without having to type any text.

In addition, all date fields function as pop-up fields. Whenever a date can be entered, the user can press **⇧** to display the special pop-up one-month calendar. You can use **PREV** and **NEXT** to select the desired month, then the arrow keys to select the desired date. You may find this more convenient than typing in the date directly, since the pop-up calendar also shows the days of the week.

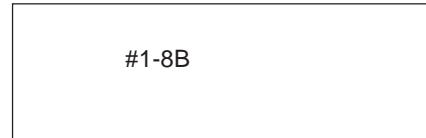

## The keyboard

The Organizer's keyboard has a standard layout, just like a typewriter or computer. **⇧** works just like the Shift key on a typewriter or computer, and **CAPS** is like the Caps Lock key.

Above the keyboard are the special keys used to start the Organizer's various applications, work with the various menus and control the cursor on the screen.

Symbols in white above a key such as ' or : can be accessed by holding down **⇧** and then pressing the appropriate key.

Functions in blue above a key, such as HELP, can be accessed by pressing the particular key after pressing **2nd**. There is no need to hold down **2nd** while you press the desired key.

- Special symbols and characters, such as “&”, “?” and “/”, can also be entered by using **SMBL**. For a full explanation, see p.167.

## Display symbols

The following symbols appear at the top of the screen to indicate various operating conditions.

- ★ This symbol appears at the top of the display to indicate that the current entry (in View or Edit mode) has been marked as Secret.
- ← → ↑ ↓ These symbols indicate that all information in an entry cannot be shown simultaneously on the display. The additional entries or fields which cannot fit onto the display can be viewed by pressing the displayed arrow key.
- 2nd** The **2nd** key has been pressed.
- BATT** The operating batteries are weak and need to be replaced (see p.199).
- CAPS** **CAPS** has been pressed. In caps lock mode, all typed letters will be in upper case. Press **CAPS** again to turn off caps lock.



The Organizer is locked. Entries marked as secret cannot be accessed without first entering the password and unlocking the Organizer (see p.186).



The key sound is on (see p.51).



All alarms are enabled. When this symbol is not shown, the alarm sound for any alarms that have been set is disabled (see p.131).

## Built-in help and other messages

The Organizer has a built-in help feature which acts as a convenient, on-line reference manual. You can call up the Help feature at any time simply by pressing **2nd** **HELP**. On-line help is quite extensive, so you may have to call up more than one screen to find the information you require.

### When built-in help is not available

On-line help is only available when called from an application screen, ie. not while performing a menu command or some other operation. Pressing **2nd** **HELP** when there is no application display on the screen will have no effect. Help is also not available within the **Clock** application.

## How to use built-in Help

If you press **2nd** **HELP** from any application screen (excluding **Clock**), the HELP INDEX appears:

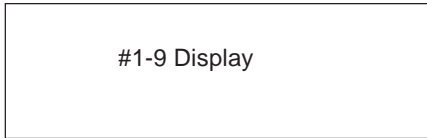

To get Help, press the number corresponding to the menu option describing the kind of Help you want. Pressing **CANCEL** takes you back to the display you were in previously. After selecting a number, the first page of help for corresponding topic is displayed.

If you make a selection from the above menu, the display that appears will resemble the following example:

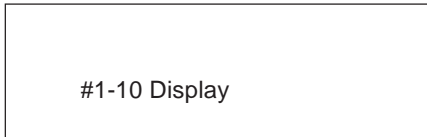

In this type of display, pressing **NEXT** takes you to the next page of the display, pressing **PREV** takes you to the previous page, and pressing **CANCEL** takes you back to the HELP INDEX menu.

From time to time during normal operation, the Organizer will display messages to guide you through necessary

tasks. Many of these messages will give you a choice of commands or ask you to confirm important operations, while others will simply display information for you to read. In most cases, you must make a selection or simply acknowledge the message before continuing.

Other messages may display information briefly before disappearing.



## CHAPTER 2

# General Operation

**T**his chapter introduces most of the Organizer's basic operations. The **Tel** application will be used for the examples. However, most of the techniques described here can be applied to all of the Organizer's applications. Each application is described in detail later on in the manual.

→ For a full explanation of the **Tel** application, see p.95.

## Opening an Application

To start an application, simply press the corresponding key, located on the top of the keyboard. Each time you press **CALENDAR**, **SCHEDULE**, **TO DO**, **ANN**, **CLOCK**, **TEL**, **USER FILE**, **OUTLINE**, **MEMO**, **MONEY TRACKING** or **CALC**, the selected application will appear. Any application already being displayed will be hidden whenever a new application is selected. You can always return to another application at the exact point where you left off simply by pressing its key again. However, only one application at a time can ever be displayed.

## Selecting the Display Modes

Once an application is open, you can switch between three basic display modes: Index, View and Edit. Each display mode has its own unique appearance and particular purpose. Index mode is normally the default view when an application is opened, and provides a summary of the individual entries that have been created. Pressing **ENTER** after selecting a particular entry causes the entry to be displayed in View mode, which shows the full details of the entry. During View mode, the word VIEW appears at the top of the screen, and no entry details may be altered.

Pressing **EDIT**, either when an entry is displayed in View mode or is selected in Index mode, causes the entry to be displayed in Edit mode. The entry's details can then be altered as desired. During Edit mode, the word EDIT appears at the top of the screen. Edit mode is also used when an entry is being created (by pressing **NEW**).

☞ The **Calc** and **Clock** applications do not have Index, View or Edit modes.

## Index mode

Index mode shows you a one line view of each entry within the application. This allows you to easily find a particular entry, which you can then display in full (View mode) by pressing **ENTER**.



The currently selected entry.

Other operations:

- NEW** Creates a new entry for the current application (in Edit mode).
- EDIT** Displays the currently selected entry and edits it (Edit mode).
- DEL** Deletes the currently selected entry.
- PREV** Displays any previous/subsequent entries not shown.
- NEXT** Displays any previous/subsequent entries not shown.
- ↑** **~** Selects an entry.

## View mode

View mode allows you to see the full details of an entry, without being able to edit or change it.

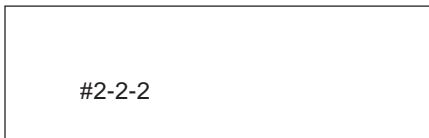

Other operations:

**NEW** Creates a new entry for the current application (in Edit mode).

**EDIT** Edits the currently displayed entry.

**DEL** Deletes the currently selected entry.

**PREV** Displays any previous/subsequent entries not shown.  
**NEXT**

**↑** **~** Displays any information not shown within an entry.  
**'** **\$**

## Edit mode

Edit mode is used to create a new entry or edit an existing entry.

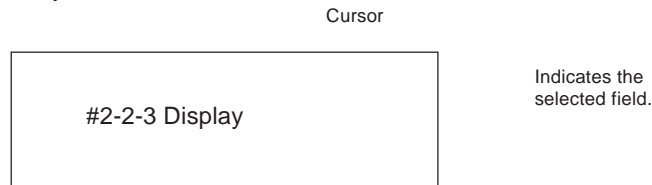

Other operations:

**↑** **NEW** Clears a selected field.

**CANCEL** Clears an entry without storing it or cancels an operation and returns to the previous view mode.

**ENTER** Stores an entry in the Organizer's memory or initiates an operation.

**~** Activates the pop-up menu for a field displaying the "pop-up" symbol.

**↑** **~** Moves the cursor.  
**'** **\$**

**PREV** Selects a field.  
**NEXT**

## Creating a New Entry

In Index or View mode, pressing **NEW** opens a blank form for creating a new entry.

Make the following new **Tel** entry:

Name *John Smith*

Tel. *201-529-8200*

Fax. *201-529-9695*

Address *123 Main Street, Mahwah, NJ 07430*

1. Press **TEL** to open the application.

The application opens in Index mode.

2. Press **NEW** on the keyboard.

A blank form opens in Edit mode.

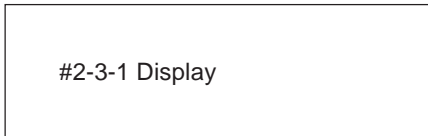

3. Type in the name *Smith, John*.

4. Press **~** or **NEXT** to move to the NUMBER field.

5. Type in *201-529-8200* and then press **↵**.

Notice that the cursor has moved to the next line and the size of the field box has been automatically adjusted.

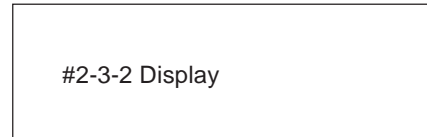

6. Type in *201-529-9695 FAX*.

7. Press **~** or **NEXT** to move to the ADDRESS field.

8. Type in *123 Main Street* followed by **↵**.

Type in *Mahwah, NJ 07430*.

9. Press **ENTER** to store the entry.

The message "Stored!" appears briefly. The entry is now stored in the Organizer's memory and displayed in Index mode.

→ For other useful methods available in Edit mode, see below.

## Editing an Existing Entry

To edit an entry already stored in memory, you must first access the entry in Edit mode (in which it was originally created).

1. Press **TEL** to open the application.
2. Select the desired entry in Index mode.
3. Press **EDIT** to open the entry in Edit mode.
4. Make any necessary changes.
5. Press **ENTER** to store the changes when you are finished.

The new, edited entry is now stored, replacing the original entry.

## Editing Techniques

This section explains all the general editing techniques used in Edit mode when making a new entry or editing an existing entry in all of the applications. (The **Memo** application has many additional features for working with text; see p.103 for more information.)



### Fields

Most applications divide the display into field boxes. The number of fields in each application varies, as do the types of fields. The different types of field include text fields, a date field, time fields and pop-up fields. There are also a few special types of text fields. In the **Tel** and **User File** applications, you can define the number and names of fields according to your preferences (see p.100).

You can type any character into a text field. The size of a text field is limited only by the size of the entry. Text fields adjust their size automatically to accommodate the number of lines entered.

Only a date can be entered in a date field, usually in the format MM/DD/YYYY. For example, you would type *06231996* to enter June 23, 1996.



Only a time of day can be entered in the time field, in the format of HH:MM followed by **AM** or **PM** (for AM and PM). For example, to enter 9:00 AM, you would type *0900* then press **AM**.

When the pop-up symbol  appears by a field while editing an entry, this indicates that a pop-up menu is available for the field. The pop-up menu contains a list of values available for the field, and is used by pressing  and selecting the desired value from the pop-up list. Note that the pop-up symbol only appears next to a field in Edit mode, when the field is selected. When you move out of a pop-up field, the pop-up symbol disappears.



 While most pop-up fields require you to select an item from the pop-up menu list, a small number allow to type in text in addition to selecting from the menu.

## The cursor

The cursor is used to work with text, indicating the position where text will be entered or deleted. It is also used to select items from menus or lists.

In text fields, where there is no restriction on the type of text (letters or numbers) that can be entered, the cursor appears as  in insertion mode, or as  in overwrite mode (see p.61).





In the date and time fields, the cursor appears as , indicating that numbers only should be entered in a specified format (see above).

 In some text fields or boxes when there is no character at the cursor position, the cursor appears as .

## Typing in text

Typing in text is simple and straightforward. The Organizer's keyboard layout is just like the keyboard on a typewriter or computer.

### Letters (lower-case and upper-case)



Any of the standard letters (A to Z) can be entered by pressing the corresponding key. All letters will normally appear in lower case. Hold down either of the  keys while pressing letter key(s) to enter upper-case letters.  functions like a "Caps lock" key on a typewriter or computer. Once pressed, the symbol CAPS will appear in the display. Any letters typed while the Organizer is in CAPS mode will appear in upper case. To switch back to lower-case mode, simply press  again. To enter lower-case letters while in CAPS mode, hold down  while pressing a letter key.

### Numbers





Numbers are entered using the numeric keypad located to the right of the display. The numbers are entered regardless of whether CAPS mode is on or off.

### Symbols









The symbols that appear in white above certain keys can be entered directly from the keyboard. Holding down  while pressing the appropriate key will allow you to enter these symbols. Colons can be entered by holding down

 and pressing the  key. In addition, a large number of special symbols are available by pressing  (see p.167).



## Moving around the display



You can move the cursor around the display with the cursor keys , , , and . In addition, you can hold any cursor key down for continuous rapid movement.

The following convenient keyboard shortcuts are also available in Edit mode:

-   Moves the cursor to the end of the line.
-   Moves the cursor to the beginning of the line.
-   Moves the cursor to the first line of a field (or the last line of the previous field if the cursor is already positioned on the first line of a field).
-   Moves the cursor to the last line of a field (or the first line of the next field if the cursor is already positioned on the last line of a field).







## Inserting and overwriting text

To insert text into some existing text, move the cursor past the character after which you wish to insert text and begin typing. Insertion mode is the Organizer's default setting, indicated by the triangle cursor . To switch to the overwrite mode, press . Any text you enter will replace

the existing text. The cursor appears as  in the overwrite mode. To switch back to the previous mode, press  again.

## Deleting text

If you make a mistake while entering text, use the following keys to erase the incorrect text, then enter the correct text:

-  Deletes the character before the cursor.
-  Deletes the character at the cursor's current location.
-   Deletes the entire line the cursor is on.
-   Clears the currently selected field.

## Working with blocks of text

Working with a block of text is sometimes easier and more convenient than working with characters one by one. The first step is to select the text to work with.

1. Hold down the  key while using the cursor keys to move over the entire text that you want to work with. This will "highlight" the text (display it in reverse white on black).

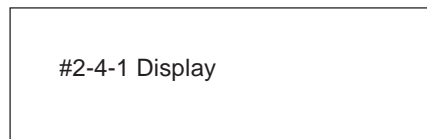

2. You can now perform a number of operations on the selected text:

**BS** or **DEL**

Deletes the selected text.

**2nd** **COPY**

Copies the selected text to the clipboard so that it can later be pasted to another location.

**2nd** **CUT**

Deletes the selected text from its current location and moves it to the clipboard.



**2nd** **PASTE**

Replaces the selected text with whatever is currently in the clipboard.

Once text is selected, any new text that is typed in will replace the selected text. This can be useful if you are replacing one block of text with another, as selecting the old text and then typing the new text saves you the trouble of actually deleting it first.

→ For a full explanation of the Cut/Copy/Paste functions, see p.161.

## Scrolling the display

If there is more information than can be displayed at one time, an arrow will appear at the top of the display. The arrows indicate the direction you need to scroll in. Press  or  to scroll the information one line at a time.



## Finding Specific Entries in Your Organizer

There are a number of ways that you can locate entries and information in your Organizer. One is to scroll between entries using the **NEXT** and **PREV** keys. Others are as follows.

### Using Index mode

Index mode gives you a listing of all the entries in a particular application.

Index mode gives you a listing of all the entries in a particular application. It is useful for providing a summary list of the entries contained for that application, from which a desired entry may be selected.

Many applications open in whichever mode was active when they were last used, ie. View, Edit or Index mode.

1. Press the desired application key.
2. If it is not already displayed, switch to Index mode by pressing **CANCEL**.

A list of the existing entries appears.

3. If the desired entry is not displayed, you can scroll the list of entries by pressing **↑** and **↓**.

#2-5-1 Display

4. When the desired entry is displayed, select it and press **ENTER** to see the entry in full.

### Using keywords

If you have no idea where an entry is or what letters it begins with, you can use the Search function to find your information easily. For example, suppose that you find a piece of paper with a phone number but no name, and who want to know whose number it is.

1. Press **2nd** **SEARCH**.

The Search window will open.

#2-5-2 Display

2. Enter the phone number you have found. For example, type *529-8200*.

 To search only secret entries (see p.186), press **2nd** **-** to check the SECRET ONLY box.

3. Press **[ESC]**, select TELEPHONE and press **[ENTER]** to close the pop-up list and then again to begin the search operation. If you are not sure about which application to search, select ALL to search all applications.

#2-5-3 Display

The Organizer will now display the first entry that contains the text or “keyword” that you entered.

#2-5-4 Display

If there is more than one entry that contains the keyword, press **[NEXT]** until you find the entry you are looking for. Then press **[ENTER]** when you have finished searching.

 If you highlight text in an entry before pressing **[2nd]** **[SEARCH]** to begin a search, the text is automatically entered as the search keyword.

## By date

You can use the various **Calendar** views to quickly and easily find information related to a time and/or date.

1. Press **[CALENDAR]**.

The calendar appears in the preset view.

#2-5-5 Display

2. Select a day using the cursor keys, then press **[ENTER]** to see the Weekly view.

#2-5-6 Display

3. Press **[ENTER]** again to see the Daily view.

#2-5-7 Display

4. In the Daily view, highlight an entry and press **ENTER** to display the details of the entry.
- For more information about using the **Calendar** application, see p.69.
-  You can open the **Calendar** menu by pressing **MENU** to select the desired **Calendar** view.

## Deleting Entries

Entries in the Organizer can be deleted using either the **DEL** key or the application menu.

### Deleting single entries

1. Open the desired application.
2. Select the entry in Index mode.
3. Press **DEL** on the keyboard.

A confirmation message appears asking if you are sure you want to delete the selected entry.

4. Press **Y** (or **N** to cancel the deletion).

### Deleting entries using the application menu

You can also make deletions using the application menu. The DATA DELETION submenu allows you to do this flexibly and easily.

1. Open the desired application.
2. Select the entry in Index mode or display it in View mode.
3. Press **MENU** to open the application menu.
4. Select DATA DELETION, then press **ENTER**.

The submenu appears.

#2-6-1 Display

Deletes a selected entry.

Deletes Filtered entries.

Deletes all entries in TEL 1, TEL 2 or TEL 3 file.

Deletes all entries in all TEL files.

5. Select SELECTED ENTRY, then press **ENTER**.

A warning message appears asking if you are sure you want to delete the entry.

6. Press **Y** (or **N** to cancel the deletion).

## Checking the Time and Date

1. To check the current date and time, press **CLOCK**.

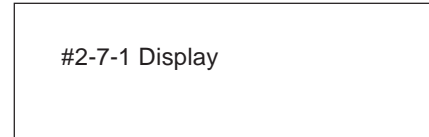

2. Press any other application key to close the **Clock** application.

→ For a full explanation of the **Clock** application, see p.126.

## Checking the Memory

The Organizer has a certain memory capacity in which operations are carried out and data that has been entered, such as phone numbers and memos, are stored. When the amount of data already stored approaches the Organizer's maximum memory capacity, you may not be able to store an entry or the data being processed may be lost when you change applications. To avoid these problems, you should check the remaining memory space regularly and free up space when necessary by deleting out-of-date entries. The Check Memory function allows you to easily check the amount of free memory available in the Organizer, and thus avoid the inconvenience of running out of memory and losing data.

1. Press **MENU** three times to display the TOOLS menu.
2. Select CHECK MEMORY, then press **ENTER**.

The display shows the summary of the Organizer's memory usage and availability.

#2-8-1 Display

3. Press **ENTER** or **CANCEL** to close the display.



Even if the display shows a small amount of free memory available, that amount may be insufficient for certain operations to work properly. You are strongly recommended to carry out regular "housekeeping" by deleting unwanted or out-of-date information to prevent the memory becoming full.

## The TOOLS Menu - the Organizer's Basic Utilities

Many of the Organizer's basic utilities are accessed through the TOOLS menu. The menu is also used to set up and configure certain features, such as the display contrast and the **WORD** key. An illustration and summary of the TOOLS menu (including page references where full explanations can be found) are provided below.

Adjusts the contrast of the LCD display (see p.50).



#2-9-1 Display

Stores entries transferred from other units (see p.178).

Shows the amount of free and used memory (see p.67).

Displays all characters in bold type (see p.190).

Use to assign words to the WORD key (see p.164).

Turns the alarm sound for stored alarms on and off (see p.131).

Turns the key beep on and off (see p.51).

Other important facilities and functions are provided via the PREFERENCES menu, which allows you to tailor the Organizer and is described in Chapter 10, and the PERIPHERALS menu, which provides commands for printing and data transfer, described in Chapter 9.

## CHAPTER 3

# Time Management

The Organizer's **Calendar**, **Schedule**, **To Do**, and **Ann** (Anniversary) applications let you structure and manage your time easily, whether scheduling appointments or giving reminders about important people and events. The explanations and examples in this chapter will give you the information you need to make all of the time management features of these applications work for you on a daily basis.

## The Calendar Application

The **Calendar** represents the Organizer's most central utility. It serves as a calendar that you can reference at any time for the correct date, and also as a time management utility, indicating important dates so that you can keep track of your time and appointments. The application performs as a highly sophisticated calendar that can display details of any month from January 1901 to December 2099. The **Calendar** also provides you with a convenient way of accessing, viewing and making new entries in the **Ann**, **Schedule**, and **To Do** applications.

### Selecting a Calendar view

The **Calendar** application is used to display and indirectly access information about time and dates. The **Calendar** provides you with three ways of viewing the information: Daily, Weekly, and Monthly. The default view is the Monthly view with the next month displayed as well, but you can customize the **Calendar** to display the desired view each time you open the application.

The different views are linked by the selected date, which means that you can switch from one view to another and the selected date will not change.

To change from the monthly view, select the desired date then press the **ENTER** button to display the Weekly view. Pressing the **ENTER** button again will display the Daily view for the selected date.

 You can also use the menu to select a particular **Calendar** view directly, regardless of which view you are already using.

1. Press **MENU** to open the application menu.
2. Select VIEWS and press **ENTER**.
3. Select VIEWS and select the desired view in the sub menu and press **ENTER**.

 You can change **Calendar** application's initial display. Select SET UP MONTHLY VIEW from the **Calendar** menu, then select the preferred default view (Monthly or Daily).

## The Monthly view

The Monthly view is the **Calendar** application's default view, and provides a complete summary of the days, dates and various activities entered for a given month.

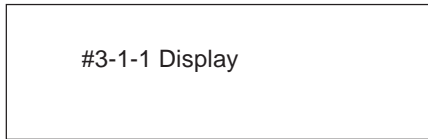

The number of days in the year that have passed, the number remaining, and in which week the currently selected day falls.

The flashing date indicates the currently selected date. A highlighted day indicates there is an **Ann** entry on that day (see p.90). The ! symbol indicates that the day is a due date

for a **To Do** entry (see p.80). On the right of the display, the Monthly Goal box shows any Monthly Goals created in the **To Do** application for that month.

An upper dot next to a date indicates a **Schedule** entry for that morning (AM), and a lower dot indicates one in the afternoon or evening (PM) (see p.74).

 You can use **PREV** or **NEXT** to move forward or backwards one month at a time.

## The Monthly view: Monthly Goals display

The Monthly view normally provides you with the details of the selected month together with a summary of the month following it. However, if you choose to display the Monthly Goals (made within the **To Do** application), it will be displayed in place of this 2nd-month calendar.

To display the Monthly Goals in place of the 2nd-month calendar:

1. Press **MENU**.

On the **Calendar** menu, ✓ appears next to HIDE MONTHLY GOALS.

2. Select HIDE MONTHLY GOALS then press **ENTER**.

The 2nd-month calendar disappears, and the Monthly Goals are displayed in its place.

When you press **MENU** again, notice that ✓ no longer appears next to HIDE MONTHLY GOALS.



☞ If you re-select HIDE MONTHLY VIEWS from the application menu, the 2nd-month calendar will reappear.

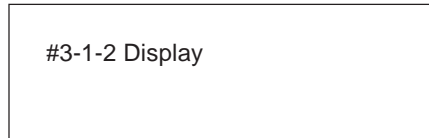

Monthly Goals in the To Do application.

You can use **PREV** or **NEXT** to move forward or backwards by one month at a time.

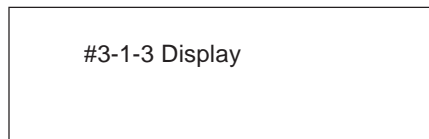

## The Weekly view

The Weekly view shows the schedule over a one-week period. To open the Weekly view, highlight a date in the Monthly view and press **ENTER**.



Selected date

Press **PREV** or **NEXT** to display the preceding or following weeks, respectively.

- When  appears, press  to view additional entries for that day.
- Press **CANCEL** to return to the Monthly view or press **ENTER** to go to the Daily view for the highlighted date.

## The Daily view

The Daily view is convenient for viewing all entries for a single day. It can be accessed from the Weekly view by highlighting a day and pressing **ENTER**.

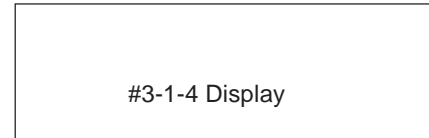





The number of entries for the current day.

Time bar for Schedule entries.

Selected entry

Shaded portions on the bar graph indicate times of the day when you have appointments or other commitments. These are shown to the nearest five minutes. Portions that are blackened indicate that you have more than one appointment during that period.

- Press  to display the bar graph for the morning and  to display the bar graph for the evening.
- To select an entry, use  and  to step through the entries, then press **ENTER** to display the entry in the View mode of the application that was used to create it.
- Press **CANCEL** to return to the Weekly view.



You can also step through days one by one using **NEXT** and **PREV**.

## Finding entries using the Calendar views

Individual entries in the **Schedule**, **To Do**, and **Ann** applications can be recalled from the **Calendar**'s Daily view.

In the **Calendar** application:

1. Go to the Daily view.



Ann entry  
Schedule entries  
To Do entry

2. Select the entry you wish to see in full.
3. Press **[ENTER]**.

The selected entry is displayed in detail.

☞ An overdue entry in the **To Do** application (an entry for which the due date has passed) will always be displayed when today's date is viewed in the **Calendar**. This serves as a reminder that the **To Do** task is still outstanding.

## Selecting a date

From any view, you can scroll to the previous or next time period (whether the next month, week, or day) by pressing **[PREV]** or **[NEXT]**, then moving the cursor to a specific

date to select it for display in another **Calendar** view. However, another convenient way of selecting a date that is not on the display is using **GO TO A SPECIFIC DATE** in the **Calendar** application menu.

1. Press **[MENU]** in any **Calendar** view, and select **GO TO A SPECIFIC DATE**, then press **[ENTER]**.

A date entry window appears.

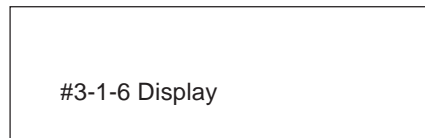

2. Enter the date you want to select in the order of month, day, and year. Single-digit months and days should be preceded by a "0".
3. Press **[ENTER]**.

The selected date will appear in the current **Calendar** view.

→ You can calculate a date some time in the future or the past using the **Calc** function. See p.120.

## Making new Schedule, To Do and Ann entries

As well as displaying a variety of time management information, the **Calendar** also allows you to create new entries for any of the Organizer's other time management applications.

To create a new **Calendar** entry:

1. From any Calendar view, press **NEW**, or select CREATE ACTIVITIES from the application menu.

The CALENDAR ACTIVITIES window appears.

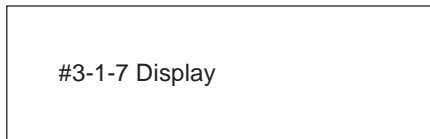

2. Type in a description of the event to be entered, then press **ENTER**.

☞ If you made another entry this way previously, the description text for that entry appears highlighted on the screen. You can use the arrow keys to edit the description if desired. Otherwise, typing in a new description will automatically cause the old text to be discarded.

If new text was entered, the message “Stored!” appears briefly, followed by the Select Application window.

3. Press **←**, select the application for which you want to create the new entry, then press **ENTER**.

The selected application appears in the application box.

4. Press **ENTER** to proceed (or **CANCEL** to cancel the new entry).

A new entry for the selected application appears in Edit mode.

5. Enter the date/time details as required for the particular application, then press **ENTER**.

The new entry is then stored, together with the description you entered in step 2 above.

## The Calendar application menu

Goes directly to today's date in the Monthly view.

Selects the Calendar view (see p.69).

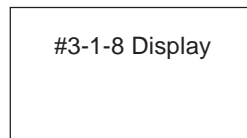

Goes directly to a particular date (see p.72).

Selects Two-month view or one month view with Monthly Goals (see p.70).

Sets the Calendar's default view (see p.70).

Makes new Schedule, To Do and Ann entries (see p.72).

Deletes selected Schedule entries (see p.76).

## The Schedule Application

The **Schedule** application allows you to enter appointments, times and dates for meetings, parties and events, and also to set an alarm to sound prior to or at the time of a scheduled entry. This makes it easy to organize your entire day and manage your appointments.

**Schedule** entries are indicated on the **Calendar's** Monthly view by a small black dot next to the date of an entry, providing an overview of your schedule.

### Making new entries

A **Schedule** entry has three fields for the date, time, and a description of the event.

There are three basic steps to making a new entry in the **Schedule** application: selecting the date, entering the starting and ending time, and entering a description of the event. (Entering a starting and ending time is optional, but you must enter a description.)

Enter the following information:

Date	<i>October 31, 1996</i>
Time	<i>8:30 p.m. – 12:00 a.m.</i>
Description	<i>Halloween Party</i>

1. Press **[SCHEDULE]**.

2. Press **[NEW]**.

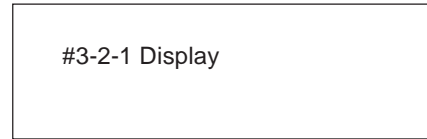

#3-2-1 Display

3. Press **[PREV]** to move to the date field.
4. Use the keyboard or press **[ ]** to select *October 31, 1996*, then press **[NEXT]** to move back to the time field.
5. Enter the start time *0830* and press **[PM]** then enter *1200* (the default is AM).
6. Press **[NEXT]** to move to the DESCRIPTION field and enter *Halloween Party*.
7. Press **[ENTER]**.

The new entry is now stored.



#3-2-2 Display

Indicates the starting time of the currently displayed entry.

Press **[NEW]** if you want to make another entry on the same day and enter the new details.

→ You can also select a date for the new entry using the application menu. See p.77.

## Finding Schedule entries

There are three convenient ways to find particular schedule entries, depending on the situation you are in. These are: Index mode, **Calendar** view and searching using keywords.

### Using Index mode

1. Go to Index mode by pressing **CANCEL** (if it is not already displayed).

The entries you have made are listed in chronological order. If you do not see the entry you want to view, press **PREV** or **NEXT** to scroll through the entries until you find it.

2. Select the desired entry.
3. Press **ENTER**.

The complete entry is displayed.

→ You can also jump to entries by specifying the date. See p.77.

### Using the Calendar view

You can access the **Schedule** entries from the Daily view of the **Calendar** application by selecting the desired entry and pressing **ENTER**. (See p.72 for details.)

### Searching using keywords

Even if you cannot remember the date of an event or appointment, if you know the subject and/or a single word

that appears in the **DESCRIPTION** field of the entry, you can find the entry by searching for it.

1. Press **2nd** **SEARCH**.

The Search window appears.

2. Type in any word that you think appears in the **DESCRIPTION** field of the entry you are looking for.
3. Press **ENTER**.

If you still do not see the desired entry, press **NEXT** to display subsequent matching entries.

4. Press **ENTER** when you find the entry you want.

☞ The Search function does not distinguish between upper- and lower-case letters.

## Moving appointments and editing entries

You can easily keep track of schedule changes, by editing entries, including the date and time, without having to re-enter all the information from the beginning. If the time and/or date of a **Schedule** entry is changed, the entry is automatically re-sorted for display in the correct chronological order with other entries.

1. Select the entry you want to change in Index mode.
2. Press **EDIT**.
3. Move to the field you want to change.

4. Make the desired changes.

5. Press **ENTER**.

The new edited entry is now stored.

 You can also use cut and paste to move appointments.

## Deleting entries

You can delete single entries or groups of entries.

→ For a full explanation of deleting Filtered entries, see p.166.

### Deleting single entries

1. In the **Schedule** application, select the entry you want to delete in Index mode or display it in View mode.

Or

In the **Calendar** application, select the entry you want to delete in the Daily or Weekly view.

2. Press **MENU** to open the application menu, select DATA DELETION and press **ENTER**.

A submenu opens.

#3-2-3 Display

3. Select SELECTED ENTRY, then press **ENTER**.

A warning message will appear asking if you are sure you want to delete the entry.

4. Press **Y** (or **N** to cancel the deletion).

 You can also delete an entry by pressing **DEL** after selecting it in Index mode or displaying it in View mode.

### Deleting all entries

All **Schedule** entries can be deleted at one time using the menu.

1. Press **MENU** in Index or View modes to open the application menu.

2. Select DATA DELETION, then press **ENTER**.

A submenu appears.

3. Select ALL SCHEDULE ENTRIES, then press **ENTER**.

A confirmation message will appear asking if you are sure you want to delete all the entries in the application.

4. Press **Y** (or **N** to cancel the deletion).

 It is not possible to delete all entries (using ALL SCHEDULE ENTRIES) if the unit is locked. See p.186.

## Deletion of entries over a specific period

You can delete all **Schedule** entries for a period of a month or a single day using the **Calendar** application.

1. Press **CALENDAR** and select a date which falls within the period in which you want to delete all **Schedule** entries.
2. Press **MENU** and select DATA DELETION, then press **ENTER**.

A submenu appears.

3. Select the desired period for deletion.

A warning message appears asking if you are sure you want to delete all the entries for the selected period.

4. Press **Y** (or **N** to cancel the deletion).
- Deletion of entries over a specific period cannot be done if the Organizer is locked (see p.186).
  - To delete all **Schedule** entries over a specific period, you must be in a **Calendar** view which includes the entire period you want to delete. For example, you cannot delete entries for an entire month while in the Daily view.

## Selecting a specific date

If you want to jump to a specific date to find entries or make a new entry, you can do it easily using the application menu.

1. In Index or View mode of the **Schedule** application, press **MENU**, and select GO TO A SPECIFIC DATE, then press **ENTER**.

A date entry window appears.

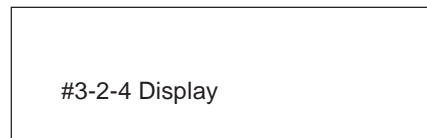

2. Enter the date you want to go to.
3. Press **ENTER**.

The first entry on that day is selected in Index mode, or displayed in View mode.

If you would like to make a new entry, press **NEW**, or if you would like to view other entries on that date, press **NEXT** or **PREV**.

## Making entries for recurring and extended events

Using the **Schedule** application's Repeat function, you can copy entries to other days or dates without having to type in each one individually. This is convenient for those appointments, meetings, and other events that are held regularly. The Repeat function can also be used to enter an event that spans a period of a few days or a few weeks,

such as a business trip or vacation. Six different types of repeating events include:

### Daily

Repeats on the following one or more days for events that span consecutive days.

### Work day

The same as Daily repeat, but excludes weekends.

### Weekly

Repeats the same day each week for regular weekly events.

### Bi-weekly

Repeats every other week.

### Monthly by day

Repeats the same day of each month (for example, the first Tuesday) for regular monthly events on a specific day.

### Monthly by date

Repeats the same date each month (for example, the 10th) for regular monthly events on a specific date.

For example, if you have a five-day vacation beginning on June 24th:

1. Select the date when the entry will occur for the first time in the **Schedule** application.
2. Press **NEW**.
3. Move to the DESCRIPTION field.
4. Enter the description. Type *Vacation*.
5. Press **ENTER**.
6. Press **MENU** and select REPEAT THIS ENTRY, then press **ENTER**.

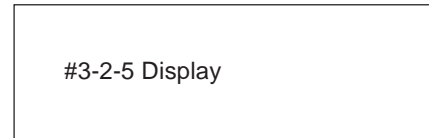

7. Press **~** to display the pop-up list, then select DAILY.
8. Enter the number of additional days on which the event will be repeated. An entry can be repeated up to 999 times. In this case, type 4 (together with the original entry, the event will occur on five days).

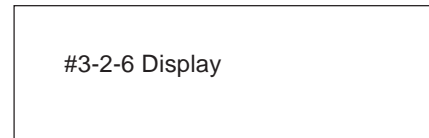

9. Press **ENTER**.



Your five-day vacation is now stored.

You can confirm that your vacation has been entered by checking the **Calendar** monthly view.

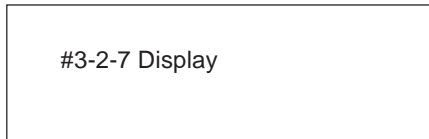

- To repeat an entry that has already been stored, select it in Index mode, then proceed from step 6 above.
- Events like the second and fourth Thursday of each month can be generated by making two different schedule entries and repeating each one.

## Setting a Schedule alarm

A **Schedule** alarm can be set to remind you of scheduled events such as appointments and meetings. You can set an alarm for any entry that has a starting time set. Alarms that have been set will sound even if the unit is turned off. After setting the alarm for a scheduled event, the (🔔) will appear next to the event in Index mode and in the **Calendar**'s Daily view.

Enter the following information with an alarm set for one hour in advance:

Date *March 16, 1996*

Time *1:00 – 2:00 pm*

Description *Lunch with Sally*

1. In the **Calendar** or **Schedule** applications, select the desired date and press **NEW**.
2. Enter the starting time and ending time, each followed by **PM**.

The cursor moves to the alarm time field. When this field is empty, this means that no alarm is currently set.

3. Enter the desired alarm. Type *1200* and press **PM**.

💡 If you want to set the alarm at the schedule's starting time, skip step 3 above and press **2nd** **ALARM**.

👉 Note that the alarm 🔔 symbol is different from the bell which appears at the top of the display to indicate that any alarms already marked as set throughout the Organizer will sound at the designated time.

5. Move to the DESCRIPTION field and type *Lunch with Sally*.
6. Press **ENTER**.

To set an alarm for an entry that has already been stored, display the entry in Edit mode and enter the desired alarm time in the alarm field or press **2nd** **ALARM** to set the alarm at the entry's starting time.

→ You can also set alarms separately from **Schedule** entries. See p.178.

### Clearing a set alarm

To clear an alarm that has been set for a **Schedule** entry, display the entry in Edit mode, then press **[2nd] [ALARM]**.

→ You can disable all set alarms simultaneously. See p.179.

## The Schedule application menu



Selects the Calendar view (see p.69).

Shows today's Schedule entries.

Goes directly to particular date.

Used to enter events that occur regularly, or mark an event that spans a period of time (see p.77).

Selects the specific entries for deletion (see p.76).

## The To Do Application

The **To Do** application is a valuable organizational tool to help you meet deadlines and to add structure and efficiency to your work as well as the goals that you set for yourself. This application allows you to organize and track tasks and objectives, assign them priorities, and assign up to five categories to each entry, making it possible to access them selectively in a variety of ways. To help you in this task, entries are identified as TO BE DONE, DONE, or MONTHLY GOALS.

### Making new entries

Entries in the **To Do** application contain nine fields: Description, Due Date, Priority, Done indicator, and five fields for categories. These categories, which you can define yourself and assign as you like, can be used to manage tasks according to project, the personnel involved in them, or any other groupings you wish to define.

The way in which **To Do** entries are displayed in the **Calendar** views will differ depending on the contents of the Due Date field, as follows:

- Entries with no due date are always shown on the display for today's date.
- Entries with a due date (month, day, and year) are shown only on that date.

- Entries for which only a month and year (no day) have been entered are considered to be Monthly Goals and are displayed in a special box for monthly goals which appears in the **Calendar's** Monthly view.

This system provides the flexibility for an entry to be displayed according to the type of task. For example, you could enter a daily task, leaving the DUE DATE field blank, and it would be displayed every day as part of that day's schedule; or for a long-term project, enter the month in the DUE DATE field without a specific date and it will be shown only in the Monthly view as a Monthly Goal.

### Assigning priority to entries

In the PRIORITY field you can enter a number (0-9) or letter (A-Z) (but not special or accented characters), which then indicate the importance of a task or project. (Numbers are given priority over letters.)

Enter the following information:

Description	<i>Prepare Alpha project proposal for John</i>
Priority	1

1. Press **TO DO**.
2. Press **NEW**.

The **To Do** entry display opens.

#3-3-1 Display

3. Enter the description of the entry. Type *Prepare Alpha project* **↵** *proposal for John*.
4. Skip the DUE DATE field and move to the PRIORITY field.
5. Type *1*.

#3-3-2 Display

6. Press **ENTER**.

The entry is now stored.

### Assigning due dates to entries

A **To Do** entry must be given a due date (or month) so the Organizer knows how to classify it and the **Calendar** knows when it becomes due. The due date can be entered either by typing in the actual date, or by selecting the date from the pop-up calendar and using the arrow keys to select the desired month and day.

Enter the following information:

Description	<i>Sales report</i>
Due Date	<i>Mar 10, 1996</i>

In the **To Do** application:

1. Press **NEW**.
2. Type *Sales report*.
3. Move to the DUE DATE field. Enter the due date in the order of month, day, year. Type *03101996*, or press **←**, use **PREV** and **NEXT** to display March 1996, then use **↑** **~** **S** **'** and to move to the 10th of the month.
4. Press **ENTER**.

### Entering a monthly goal

If you enter only the month and year in an entry's DUE DATE field (with no specific date), the entry becomes a monthly goal, and will appear in the **Calendar**'s Monthly view when HIDE MONTHLY GOALS is deselected.

You have a manuscript you have to read by the end of August.

In the **To Do** application:

1. Press **NEW**.

2. Enter a description. Type *Read manuscript*.
3. Move to the DUE DATE field.
4. Enter the month when you want to accomplish this. Type *08*.
5. Press **↑** twice (skipping the date) and enter the year. Type *1996*.
6. Press **ENTER**.

The entry is now stored.

Now check that the entry you made is displayed on the **Calendar**.

7. Press **CALENDAR**.

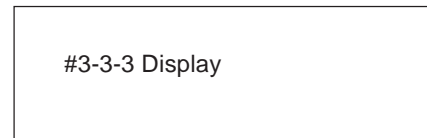

Monthly goal entries are displayed within a box.

### Finding entries using Index mode

1. Go to Index mode.

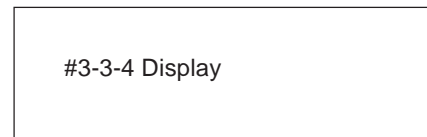

Index mode in the **To Do** application can show entries based either on their priority level or their due date. In the default setting, entries with an assigned priority are displayed first (in the order of number, then letter), followed by entries with no assigned priority. Select INDEX BY from the application menu, then DATE from the submenu to display entries in chronological order based on the due date. To return to a display based on priority, select INDEX BY from the menu, then PRIORITY from the submenu. This means you can access entries in the way that is most convenient for you.

2. Press **MENU** and from the VIEWS submenu, select the file you want to review and press **ENTER**.
3. If you want to see the details of an entry, select the entry and press **ENTER**.

The entry is displayed in View mode.

## Controlling how the Calendar displays To Do information

**To Do** entries are indicated with ! beside their due dates in the **Calendar**'s Monthly views. The **Calendar** application can also display a reminder of any Monthly Goals that have been set.

To display the Monthly Goals:

1. From the **Calendar** application, press **MENU**.

The application menu appears.

2. Select HIDE MONTHLY GOALS and press **ENTER**.

The Monthly Goals will then be displayed the next time the **Calendar**'s Monthly view is selected.

3. Press **MENU** again to confirm that no ✓ appears next to HIDE MONTHLY GOALS, indicating the option has been deselected.

 To select HIDE MONTHLY GOALS, repeat the above procedure. The ✓ will then appear on the menu.

An overdue entry (ie. an entry for which the due date has passed) will always be shown in the **Calendar** views on the display for today's date as well as on its due date.

## Using keywords

Using the contents of any fields, including the DUE DATE and PRIORITY fields, you can access desired entries directly.

In the **To Do** application:

1. Press **2nd** **SEARCH**.

The Search window appears.

2. Type in any word you remember in the entry you are looking for. This word may occur in any field of the entry.
3. Press **ENTER**.

If you still do not see the desired entry, press **NEXT** to display the following matching entries.

4. Press **ENTER** when you find the entry you want.

 The Search function does not distinguish between upper- and lower-case letters.

## Editing entries

1. Select the entry you want to change in Index mode.

2. Press **EDIT**.

The selected entry opens in Edit mode.

3. Make the desired changes.

4. Press **ENTER**.

The updated entry is now stored.

## Checking off completed entries

Once you have reached a target or goal you set for yourself, it is a good idea to check off the entry as completed so that you can concentrate on things still to be done. Any entry marked as done will remain displayed on the done date in the **Calendar**. This allows you to go back and review entries that have already been completed.

This operation can be done either using the **Calendar**, which makes it easy to check completed entries when you check your schedule for the day, or in the **To Do**

application, which lets you check off a monthly goal entry or a task that you have completed before its due date.

## Checking off entries using the Calendar

1. Press **CALENDAR**.



2. Go to the Daily view.

3. Display the date you want to check.

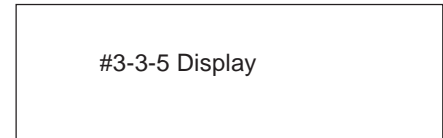
If the entry you want to check off is not displayed, press  until it appears.



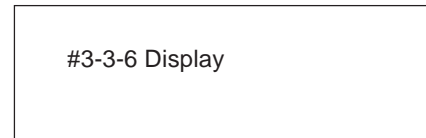

Check box to mark task as completed

4. Go to the entry you have completed and press  .



The box is now marked with , and the entry is marked as having been completed today.

 If you mistakenly check off an entry as completed, you can uncheck the entry by pressing  .

again. However, if you do this, the entry will be stored without a due date.

### Checking off entries in the To Do application

1. Select the entry in Index mode.

Check box

#3-3-7 Display

2. Press  .

The entry is checked off and the box is marked with ✓. The DUE DATE field name changes to DONE DATE and today's date appears in it.

3. Press .

☞ If you mistakenly check off an entry as completed, you can uncheck the entry by pressing   again. However, if you do this, the entry will be stored without a due date.

→ Once a project or task is completed, and you no longer need the **To Do** reminder, you can delete the entry, or groups of entries, which will free up memory in the Organizer. See p.88.

## Using categories

A category is a name that you assign to an entry so it can be grouped with other entries for subsequent selective access. You can use categories to organize your information, for example, to group tasks by project, personnel, or other criteria that you may find useful. Up to 32 different categories can be used in the To Do application, and up to five categories can be assigned to each entry. Once a word is entered within an entry as a category, that word is automatically stored and sorted alphabetically in the category list, from which you can select a category to assign to an entry. You can also manually add a word directly to the category list, as well as editing and deleting words in the list.

☞ Be careful when manually adding categories because the Organizer distinguishes between upper- and lower-case letters for category names. For example, "For John" and "for john" are treated as different categories.

### Making entries using categories

Enter the following:

Description	<i>Call Frank re: Alpha Project</i>
Due Date	<i>Mar 15, 1996</i>
Category 1	<i>Phone Call</i>
Category 2	<i>Alpha Pro.</i>

1. Press **NEW**.
2. Enter the description and due date. Type *Call Frank*  
re: **←** *Alpha Project* **▾** *03151996*.
3. Move to the CATEGORY 1 field.
4. Enter the category. Type *Phone Call*.
5. Move to CATEGORY 2. Type *Alpha Pro*.

#3-3-8 Display

6. Press **ENTER**.

The entry is stored and, at the same time, the two categories you entered are stored in the category list.

7. Press **ENTER** to return to Index mode.

The Index view for the To Do application appears.

8. Press **MENU**, select CATEGORIES and press **ENTER**.

The CATEGORIES window appears.

9. Press **▾** to display the pop-up category list.

#3-3-9 Display

☞ You cannot use the same category more than once within the same entry.

### Assigning categories using the category list

1. When entering or editing an entry in Edit mode, move to any of the five CATEGORY fields.

The pop-up symbol appears at the right.

2. Press **▾**.

The Category window opens with the first category selected. Categories are listed in alphabetical order.

#3-3-10 Display

3. Select the desired category and press **ENTER**.

The category window closes and the selected category appears in the field.

4. Press **ENTER**.



☞ You cannot use the same category more than once in the same entry.

### Updating the Category list

Since the number of categories and the Organizer's memory are both limited, you may wish to delete unused categories. Also, you may wish to define a number of new categories without creating a new **To Do** entry, or even edit the names of existing categories.

1. From the **To Do** application's Index view, press **[MENU]**.
2. Select CATEGORIES and press **[ENTER]**.

The CATEGORIES window appears.

3. Make the desired change to the category list:

To enter a new category: Press **[NEW]**, type in the new category name, then press **[ENTER]**.

To edit an existing category: Press **[\_]**, select the desired category from the list and press **[ENTER]**. The selected category appears in the category box. Press **[EDIT]**, make the necessary changes then press **[ENTER]** to store the edited entry.

To delete an existing category: Press **[\_]**, select the desired category from the list and press **[ENTER]**. The selected category appears in the category box. Press

**[DEL]**. A confirmation message appears. Press **[Y]** to confirm the deletion (or **[N]** to cancel the operation).

☞ If the Category is currently in use by one or more entries, a warning message will be displayed and it will not be deleted.

4. Press **[CANCEL]** when you have finished making your changes.

The **To Do** Index view appears.

☞ When you edit a category name, any **To Do** entries that refer to that category are automatically updated to reflect the change.

### Accessing the To Do entries by category

You can choose to view only those entries that have been assigned a specific category.

1. Press **[MENU]** to open the application menu. The VIEWS command should already be selected. Press **[ENTER]**.

The VIEWS submenu appears.

2. Move to BY CATEGORY, then press **[ENTER]**.

The category window appears.

3. Press **[\_]** to open the category list.

The pop-up category list appears.

4. Select the category whose **To Do** entries you want to view, then press **[ENTER]**.

All entries that have been assigned the selected category are then shown in Index mode.

## Deleting To Do entries

### Deleting single entries

1. Select the desired entry in Index mode or display it in View mode.
2. Press **[MENU]**, select DATA DELETION, then press **[ENTER]**.

A submenu opens.

3. Select SELECTED ENTRY, then press **[ENTER]**.

A warning message will appear asking if you are sure you want to delete the entry.

4. Press **[Y]** (or **[N]** to cancel the deletion).

 You can also delete single entries in Index mode by selecting the entry to be deleted and pressing **[DEL]**.

### Deleting To Do entries by type

You can delete only TO BE DONE, DONE, or MONTHLY GOAL entries simply by selecting the desired type of entry from the application menu, then deleting the currently viewed entries. This is especially convenient for deleting all

entries that have been checked off as completed.

1. Press **[MENU]**, select VIEWS and press **[ENTER]**.
2. Select the type of entries you want to delete (DONE, TO BE DONE, or MONTHLY GOALS), then press **[ENTER]**.
3. Press **[MENU]**, select DATA DELETION then press **[ENTER]**.
4. Select ALL IN CURRENT VIEW then press **[ENTER]**.

A warning message will appear asking if you are sure you want to delete all the entries in the selected file.

5. Press **[Y]** (or **[N]** to cancel the deletion).

 It is not possible to delete all entries in a file simultaneously if the Organizer is locked. See p.186.

### Deleting To Do entries by Category

You can delete those entries in a particular Category.

1. From Index or View mode, press **[MENU]**, select VIEWS then press **[ENTER]**.
2. Select BY CATEGORY then press **[ENTER]**.

The CATEGORIES window appears.

3. Press **[ ]**, select the desired category from the list and press **[ENTER]**.

4. Press **ENTER**.

Only **To Do** entries in the selected Category are displayed.

5. Press **MENU**, select DATA DELETION and press **ENTER**.
6. From the submenu, select ALL IN CURRENT VIEW and press **ENTER**.

A confirmation message appears.

7. Press **Y** (or **N** to cancel the deletion).

### Deleting all To Do entries

You can delete all of the **To Do** entries in all files.

1. Press **MENU**, select DATA DELETION then press **ENTER**.
2. Select ALL TO DO ENTRIES then press **ENTER**.

A warning message will appear asking if you are sure you want to delete all **To Do** entries.

3. Press **Y** (or **N** to cancel the deletion).

☞ It is not possible to delete all entries simultaneously if the Organizer is locked. See p.186.

## The To Do application menu

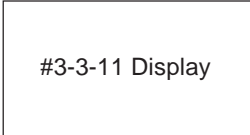

#3-3-11 Display

Selects TO BE DONE, DONE or MONTHLY GOALS entries.  
Sets the Index sorting order by date or by priority (see p.83).  
Opens the CATEGORIES window so you can add, edit, delete or select categories (see p.85).  
Selects the specific entries for deletion (see p.88).

## The Ann (Anniversary) Application

The **Ann** (Anniversary) application makes it easy for you to keep track of annual events, such as wedding anniversaries and birthdays of friends, relatives and business associates. Once entered, the dates of annual events are displayed on the **Calendar** highlighted white-on-black, giving you plenty of warning to prepare for them well in advance every year.

### Making new entries

There are two files in the **Ann** application, each of which stores different kinds of anniversaries: those which occur on a specific date every year, and those which occur on a particular day. The first file, ANN 1, stores and displays entries that occur on a specific date, and the second, ANN 2, stores and displays entries that occur on a specific day, for example, the third Thursday in November. ANN 1 is the default file, but you can easily change between them whenever you like.

#### Making new entries in the ANN 1 file

Enter the following in the ANN 1 file:

Date	<i>May 17</i>
Description	<i>Sally's Birthday</i>

1. Press **ANN**.

Index mode opens in the ANN 1 file.

2. Press **NEW**.

Edit mode opens.

#3-4-1 Display

3. Enter the date in the order of month, day (there is no year entry). Type *0517*.
4. Move to the DESCRIPTION field.
5. Enter the description of the event. Type *Sally's Birthday*.

#3-4-2 Display

6. Press **ENTER**.

The entry is now stored.

#### Making new entries in the ANN 2 file

Enter the following in the ANN 2 file:

Date	<i>The second Sunday in May</i>
Description	<i>Mother's Day</i>

In the **Ann** application:

1. Press **MENU**, select VIEWS and press **ENTER**.
2. Select ANN 2 BY DAY then press **ENTER**.
3. Press **NEW**.

Edit mode opens.

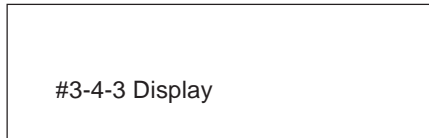

4. In the MONTH field, press **↓** and select the month from the pop-up list (choose "MAY"). Press **ENTER** followed by **NEXT**.
5. In the WEEK field, press **↓** and select the week of the month in which you want to record the anniversary (choose "2nd"). Press **ENTER** followed by **NEXT**.
6. In the DAY OF THE WEEK field, press **↓** and select the day of the week for which you want to record the anniversary (choose "SUNDAY"). Press **ENTER** followed by **NEXT**.
7. In the DESCRIPTION field, enter the description of the anniversary. Type Mother's Day, then press **ENTER**.

The anniversary is stored.

## Finding entries

Entries are stored in chronological order in each file.

### Using Index mode

1. Go to Index mode.
2. Press **MENU**, select VIEWS then press **ENTER**.
3. Select the file you want then press **ENTER**.
4. Select the desired entry then press **ENTER** to display it in full.

### Using the Calendar view

In the **Calendar's** Monthly view, **Ann** entries are indicated by dates highlighted in white-on-black, clearly showing that you have important annual events on those days.

You can access the **Ann** entries from the Daily view in the **Calendar** application by pressing **ENTER** after highlighting the desired entry. (See p.72 for details.)

### Using keywords

If you cannot remember the exact date of an important anniversary, eg. a friend's birthday, you can search for the anniversary using the following procedure.

1. Press **2nd** **SEARCH**.

The Search window appears.

2. Type in any word that you think appears in the DESCRIPTION field of the anniversary entry you are looking for.
3. Press **ENTER**.

If you still do not see the desired entry, press **NEXT** to display the following matching entries.

4. Press **ENTER** when you have selected the desired entry.

 This function does not distinguish between upper- and lower-case letters.

## Editing Ann entries

1. Select the file in which the desired entry is stored.
2. Select the entry in Index mode.
3. Press **EDIT** to open Edit mode.
4. Make the desired changes.
5. Press **ENTER**.

The new, correct entry is now stored.

## Deleting Ann entries

### Deleting single entries

1. Highlight the entry in Index mode or display it in View mode.

2. Press **MENU** and select DATA DELETION.

A submenu opens.

3. Select SELECTED ENTRY, then press **ENTER**.

A confirmation message will appear asking if you are sure you want to delete the entry.

4. Press **Y** (or **N** to cancel the deletion).

 In Index mode, you can also delete single entries by pressing **DEL** after selecting the entry to be deleted.

### Deleting all entries

1. Press **MENU**, select DATA DELETION, then press **ENTER**.

A submenu appears.

2. Select ALL ANN 1 BY DATE or ALL ANN 2 BY DAY as required, then press **ENTER**.

A confirmation message appears asking if you are sure you want to delete all entries in the file.

3. Press **Y** (or **N** to cancel the deletion).

 You can also delete all entries in both ANN files at once. Simply select ALL ANN FILES in step 2 above.

 It is not possible to delete all entries simultaneously if the unit is locked. See p.186.

## The Ann application menu

#3-4-4 Display

Selects ANN 1 file or ANN 2 file (see p.91).

Selects the specific entries for deletion (see p.92).





## CHAPTER 4

# Creating Your Own Database

**T**his chapter describes using the **Tel** (Telephone) and **User File** applications. These two applications are actually identical in the way that they function, except that they have different default file and field names designed to handle different types of information. The flexibility of these applications allows you to manage a wide range of information, from a simple address book to an extensive restaurant guide or even a listing of your important business contacts.

## The Tel and User File Applications

Each application provides three different files for the entries it will store.

Each file in either application can be named and set up from a built-in list of six types, or templates. These templates are pre-defined for each application as follows.

For the **Tel** application: Telephone, Office, Contacts, Business, Personal and Family.

For the **User File** application: Travel, Restaurant, A/V Guide, Home Inventory, Inventory and Product.

The three **Tel** files are each set up automatically to provide a simple address book. The default files set up on initialization are:

- TEL 1 Telephone template comprising three fields: Name, Number and Address.
- TEL 2 Contacts template comprising 12 fields: Company, Contact, Title, Department, Tel Number, Extension, Fax Number, Other Number, E-Mail, Assistant, Address and Notes.
- TEL 3 Personal template comprising nine fields: Name, Home number, Work number, Cellular phone number, Other number, Address, Spouse, Children and Notes.

The three **User File** directories are set up automatically as follows:

- USER FILE 1 Restaurant guide template comprising seven text fields: Cuisine, Name, Number, Address, Prices, Attire and Remarks.
- USER FILE 2 Home Inventory template comprising ten text fields: Item name, Location, Description, Manufacturer, Serial #, Place purchased, Date purchased, Cost, Estimated value and Notes.
- USER FILE 3 Free-format template comprising five text fields.

You can store information in any file you want according to your preferences.

→ Note that you can rename any file or field names according to your preferences. See p.99 for more information on customizing these applications.

## Selecting a file

Before beginning a particular operation, you must first select the file you want to work with.

1. Press **TEL** or **USER FILE** to open the desired application.
2. Press **MENU** to open the application menu and then select VIEWS. The currently selected file is marked

with an asterisk.

3. Select the desired file and press **ENTER**.



You can also press **TEL** or **USER FILE** to switch between the various files in the respective application.

## Creating new entries

In the **Tel** or **User File** application:

1. Select the file in which you want to store the information using the procedure shown above.

2. Press **NEW**.

Edit mode opens.

3. Type in the appropriate information in each field.

In the Name field of a **Tel** entry, enter the last name first if you want the entries to be sorted in last name order.

You must always enter information in the first field of any file.

4. Press **ENTER** when you are finished.

The message "Stored!" will appear briefly, indicating that the entry is now stored in memory.

## Finding entries

Entries in the **Tel** and **User File** applications are stored alphabetically based on whichever field has been selected

as the index (using the INDEX BY command in the CONFIGURE menu). There are two basic ways to find and display an entry.

### Using Index mode

1. Go to Index mode.
2. Select the file you believe the entry is in.
3. Press the key for the first letter of the field selected as the index (using the INDEX BY command in the CONFIGURE menu). (The first entry closest alphabetically to the key you pressed is displayed.)

If you do not see the entry you are looking for, press  until it is displayed.

4. Highlight the entry, then press  to see it in detail.

### Using keywords

If you are not sure of the name or the contents of the first field of an entry, but you do know a word that appears in the entry, then you can use the Search function to find it.

1. Press  .

The Search window appears.

2. Type in a word that appears in the entry you are looking for.

3. Press .

If you do not see the entry you are looking for, press  until it is displayed.

4. Press  when you find the entry.

 The Search function does not distinguish between upper- and lower-case letters.

### Editing entries

1. Select the entry in Index mode or display it in View mode.

2. Press .

The entry opens in Edit mode with the cursor in the first field.

3. Make any desired changes.

Press  at any time to discard any changes you have made.

4. Press  when you have finished.

The message “Stored!” will appear briefly, indicating that the changes are now saved in memory.

 If you changed the contents of the first field, the entry is resorted based on the changes.

## Deleting file entries

### Deleting single entries

1. Select the entry you want to delete in Index mode, or display it in View mode.
2. Press **[MENU]**, highlight DATA DELETION then press **[ENTER]**.
3. Highlight SELECTED ENTRY then press **[ENTER]**.

A warning message will appear asking if you are sure you want to delete the entry.

4. Press **[Y]** (or **[N]** to cancel the deletion).

 You can also delete single entries by highlighting the entry in Index mode and pressing **[DEL]**.

### Deleting all entries

1. Press **[MENU]**, select VIEWS then press **[ENTER]**.
2. Select the file in which you want to delete all the entries then press **[ENTER]**.
3. Press **[MENU]**, highlight DATA DELETION, then press **[ENTER]**.
4. From the submenu, highlight ALL IN SELECTED FILE, then press **[ENTER]**.

A warning message will appear asking if you are sure you want to delete all entries in the selected file.

5. Press **[Y]** (or **[N]** to cancel the deletion).

### Deleting all entries in all files

1. Press **[MENU]**, highlight DATA DELETION, then press **[ENTER]**.
2. From the submenu, highlight ALL TEL FILES or ALL USER FILES then press **[ENTER]**.

A warning message will appear asking if you are sure you want to delete all entries in the files.

3. Press **[Y]** (or **[N]** to cancel the deletion).

 It is not possible to delete all entries either in a single file or in all three files simultaneously if the Organizer is locked. See p.186.

## The Tel application menu



Selects TEL 1, TEL 2 or TEL 3 files (see p.96).

Defines the field, index and sorting format for each file (see p.99).

Selects the specific entries for deletion (see p.98).

## The User File application menu



Selects USER FILE 1, USER FILE 2 or USER FILE 3 (see p.96).

Defines the field, index and sorting format for each file (see p.99).

Selects the specific entries for deletion (see p.98).

## Customizing the Tel and User File Applications

You can customize the **Tel** and **User File** applications in the following five ways:

**File names:** You can give each file a name of up to 10 characters of your choice.

**Fields:** You can change the field names (up to 12 characters per field), and the number of fields that each entry can have (up to 16).

**Index mode display:** You can specify which fields (up to 3) are displayed in Index mode and how many characters are displayed for each field (up to 38 characters in total).

**Sorting order:** You can specify which fields are used to sort the entries displayed in Index mode.

**Template:** You can specify which of the six templates to use as a template for each of the application's three files. In order to select a particular template, you must first select the file for which it is to be applied. Note that the six templates are different for **Tel** and **User File**.

## Changing file names

1. Press **TEL** or **USER FILE** to start the application containing the file whose name you want to change.
2. Press **MENU**, select one of the three CONFIGURE commands corresponding to the file you wish to modify, then press **ENTER**.

The CONFIGURE submenu appears.



3. If the FILE NAME field is not already selected, move to it using **↑** and **←**, and then press **ENTER**.

The FILE NAME window opens.

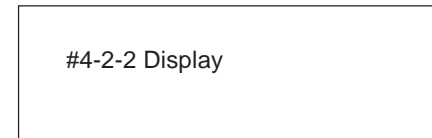

Current file name

4. Press **↑** **NEW** to clear the current name.
5. Enter the new name (up to 10 characters).

Letters, numbers, and symbols can all be entered.

6. Press **ENTER** to store the new name. (Or **CANCEL** to cancel any changes and leave the original file name.)

## Configuring fields

If you do not want to change the number of entry fields, skip steps 1-6 below.

1. Press **TEL** or **USER FILE** to open the application that you want to set up the fields in.
2. Press **MENU**, select one of the three CONFIGURE menus corresponding to the file you wish to modify, then press **ENTER**.

The CONFIGURE submenu appears.

3. Highlight FILE NAME and press **ENTER**.

The FILE NAME window opens.

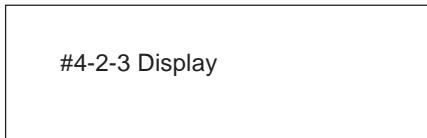

#4-2-3 Display

Number of fields currently set and used in this file.

4. Move down to NUMBER OF FIELDS and press **UP** **NEW** to clear the current number in the field.
5. Enter the number of fields that you want your entries to have.

☞ If you decrease the number of fields for a file that already has some entries stored, fields and any information they contain will be deleted from the bottom of each entry until the decreased number of fields is reached. Since the data in these fields are lost, care should be taken when reducing the file size.

6. Press **ENTER** to store the number of fields you entered. (Or **CANCEL** to cancel any changes and leave the original number of fields.)
7. Press **MENU**, select one of the three CONFIGURE commands for the appropriate file, then press **ENTER**.

The CONFIGURE submenu appears.

8. Select FIELD NAME and press **ENTER**.

The FIELD NAME window opens.

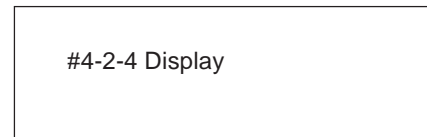

#4-2-4 Display

Current field names

9. Move to the desired fields and change them as required.

Use **UP** **NEW** to clear the current name.

Enter the new name (up to 12 characters). The name can contain letters, numbers, and symbols.

10. Press **ENTER** when you have finished. (Or **CANCEL** to cancel the changes and leave the fields as they were.)

## Customizing the Index display

You can set up a different Index format for each of the three files in the **Tel** and **User File** applications, designating up to three fields you want displayed in Index mode and the number of characters for each field.

In the **Tel** or **User File** application:

1. Press **MENU**, select one of the three CONFIGURE menus then press **ENTER**.
2. Select INDEX FORM then press **ENTER**.

The INDEX FORM window opens.

Field name	Number of characters currently set to be displayed for each entry in Index mode.
#4-2-5 Display	

- From one to three fields can be displayed in Index mode.
- The total number of characters you can have for all fields is 38.

3. Select and enter 0 in whichever fields you do not want to appear in Index mode.
4. Select which fields you want to appear in Index mode, and enter the number of characters that you want the field to be able to hold. Remember that the total maximum number of characters for all fields together is 38.

If the desired fields are not all displayed, use **←** and **→** to scroll one line at a time.

5. Press **ENTER** when you have finished (or **CANCEL** to cancel the changes).
  - You can set any text fields to be displayed in Index mode. No matter which fields appear in the Index, entries are sorted and accessed according to the contents of the first field.
  - You must set at least one field to be displayed.

## Modifying the Index sort order

The **Tel** and **User File** applications allow you to define the way in which your entries are sorted in Index mode. You can specify which of the displayed fields should be used as the first sorting key, and optionally specify second and (when appropriate) third fields for further ordering.

For example, in the **Tel** application, you might decide you want your Contacts list (initially configured as TEL2) to be

sorted alphabetically first by COMPANY, then by NAME (as opposed to the default, which is by COMPANY only, so that for each company, the names are displayed in the order in which they were created).

1. Press **TEL** repeatedly until the CONTACTS file (file 2) is displayed.
2. Press **MENU** and select CONFIGURE TEL FILE 2, then press **ENTER**.
3. In the submenu, select INDEX BY and press **ENTER**.

The SORTING ORDER window appears.

4. In the COMPANY field, make sure "1" appears to indicate that the entries should first be sorted by COMPANY.
5. Press **NEXT**.
6. In the CONTACT field, enter 2 to indicate that this field should be used as the second sorting key for the entries within each company.
7. Press **ENTER**.

The Index view reappears with the entries sorted first by Company, then by Contact name.

## Modifying the templates

For each file used in the **Tel** and **User File** applications, you can choose one of the six built-in templates supplied with the Organizer. Although these templates are selected during User Set-up, you can change to another template at any time. Refer to the QUICK START section at the front of this manual on how to run the User Set-up.



## CHAPTER 5

# Memo and Outlining

This chapter explains the features of the **Memo** application, the Organizer's basic word processing utility, and the **Outline** application, a powerful application for structuring your thoughts, ideas, and written work. When used together, eg. first outlining a document using **Outline** and then developing it using **Memo**, these two applications provide powerful word processing capabilities in a hand-held device.

## The Memo Application

The Organizer's **Memo** application provides you with a simple yet powerful means of recording information, from meeting notes to memorandums and letters. With a printer connected to the unit, this gives you the capability to print out impressive full-scale letters, reports and other documents (see p.170).

Before reading this chapter, be sure you have read Editing Techniques in Chapter 2. More advanced editing features are used in this chapter. Be sure you have a good understanding of the Organizer's basic editing procedures before beginning to use the **Memo** application.

### Creating documents

1. Press **MEMO** to open the application.

The **Memo** application opens in Index mode.

2. Press **NEW**.

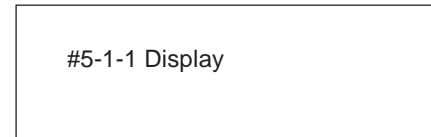

3. Type in the following letter (pressing **↵** to move to a new line):

May 10, 1996  
Mr. Frank Smith  
Chairman  
ABC Co. Ltd.

Dear Mr. Smith:

Thank you for your fax of May 5th, 1996 regarding the Alpha Project.

We agree that it is too difficult to answer your questions about our new project properly based on the available information. We will receive the proper documentation within the next week.

This shouldn't cause any delay in our production schedules.

Sincerely,

☞ It is not necessary to press  at the end of each line. The unit will automatically perform word wrapping onto the next line when the current line is full.

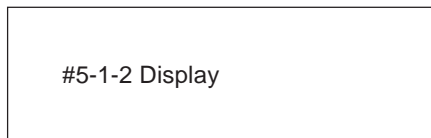

#5-1-2 Display

4. Press  when you have finished entering the text.

The **Memo** Title window then appears.

5. Type in the title *Letter to Frank*.
6. Press .

The entry is then stored and displayed in View mode.

## Finding entries

**Memo** entries can be sorted for display in two ways: alphabetically according to their title, and by date of entry. You can choose whether to display the entries in date order or alphabetical order to make finding the desired entry as easy as possible, depending on the situation.

## Changing the Index order

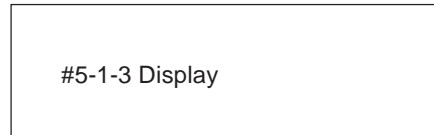

1. Go to Index mode.

Title



#5-1-3 Display

The date on which the entry was created or last edited.

2. Press , select INDEX BY and press .
3. Select the desired sorting method (DATE or TITLE), then press .

The MEMO index view is redisplayed, with the contents sorted according to the selected method.

4. Select the desired entry, then press **ENTER** to see it in detail.

The full entry is displayed.

If an entry is too long to fit on the screen at one time, you can press **↑** or **↓** to scroll the display.

☞ When Index mode entries are sorted according to title, you can jump to any entry in the list by pressing the first letter of its title.

### Using keywords

If you cannot remember the exact title of an entry, but you know a word or words that appear somewhere in the entry (including its TITLE field), you can use the Search function to find the entry.

1. Press **2nd** **SEARCH**.

The Search window appears.

2. Type in the words you remember in the entry you are looking for.
3. Press **ENTER**.

If you still do not see the desired entry, press **NEXT** to display the subsequent matching entries.

4. Press **ENTER** when you find the entry.

☞ The Search function does not distinguish between upper- and lower-case letters.

### Editing Memo entries

1. Select the entry in Index mode.
2. Press **EDIT**.

The entry opens in Edit mode.

3. Make any desired changes.

If you are working with a long piece of text that goes off the display, use **↑** or **↓** to scroll up or down line by line or use **2nd** **↑** or **2nd** **↓** to move to the first or last line of the text.

4. Press **ENTER** when you are finished.

☞ Press **CANCEL** at any time to discard any changes you have made. If you do press **CANCEL** after making some changes, a confirmation will be displayed asking if you are sure you want to discard your changes.

### Deleting Memo entries

#### Deleting single entries

1. Select the entry you want to delete in Index mode or display it in View mode.
2. Press **MENU**, select DATA DELETION then press **ENTER**.

The DATA DELETION submenu appears.

3. Select SELECTED ENTRY then press **ENTER**.

A confirmation message appears asking if you are sure you want to delete the entry.

4. Press **Y** to delete the selected entry (or **N** to cancel the deletion).

 You can also delete single entries by selecting the entry in Index mode and pressing **DEL**.

### Deleting all entries

1. Press **MENU**, select DATA DELETION then press **ENTER**.

The DATA DELETION submenu appears.

2. Select ALL MEMO ENTRIES then press **ENTER**.

A confirmation message appears asking if you are sure you want to delete all entries in the application.

3. Press **Y** to delete all **Memo** entries (or **N** to cancel the deletion).

 It is not possible to delete all entries simultaneously if the Organizer is locked. See p.186.

## Changing the way text is displayed

The Organizer's screen is 40 characters wide. If you select WORD WRAP ON from the menu, then when 40 characters have been entered and it reaches the end of the line, the text will wrap to the beginning of the next line.

However, there may be times during editing when you want the text on the screen to behave as if it was being viewed on a standard PC screen, which is 80 characters wide. For example, if you were writing a letter containing some rows or columns of prices, you might want to see exactly where the line breaks occurred, (ie. where one line ends and another begins), to make sure the letter was laid out correctly.

You can do this easily by changing the display width, so that 80 characters can be shown on the display.

1. In Edit mode only, press **MENU**, select DISPLAY WIDTH and press **ENTER**.

The DISPLAY WIDTH submenu appears. An asterisk appears next to the current selection.

2. Select 80 CHARACTERS from the submenu and press **ENTER**.

The text will be then displayed in 80-character-wide lines. Since the Organizer's display is only 40 characters wide, you can use the **←** and **→** keys to scroll the display right and left to view the text that cannot fit on the display.

When you want the text to wrap normally at the end of the line, repeat the above steps but select 40 CHARACTERS from the DISPLAY WIDTH submenu.

## Turning word wrap on and off

Word wrap automatically moves text which will not fit onto the end of a line to a new line, preventing words from being split when you type. This allows you to type text without having to worry about when to insert a carriage return to move to the next line. The default setting for the Organizer's word wrap function is on. There may be times, however, when you want to turn off the word wrap function. This can be done for each individual entry.

1. In Edit mode, press **[MENU]**.
2. Select WORD WRAP ON then press **[ENTER]**.

A ✓ will no longer appear next to WORD WRAP ON whenever you view the application menu in Edit mode.

☞ To turn word wrap back on for an entry, repeat the procedure. The ✓ next to WORD WRAP ON will now appear.

## The Memo application menu

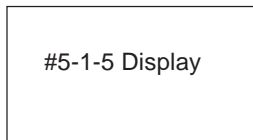

Turns WORD WRAP on and off (see above)  
 Displays 40 or 80 characters in one line in Edit mode (see p.106).  
 Sets the index sorting order by date or by title (see p.104).  
 Selects specific entries for deletion (see p.105).

## The Outline Application

The Organizer's Outline application is a simple, convenient tool to help you arrange the information or key points of your ideas and writing into a clear, easy-to-understand hierarchical structure. This is ideal for organizing your goals and ideas, and the application provides the flexibility to restructure the outline whenever necessary.

An outline structure consists of a title and one or more topics, which in turn can have one or more subtopics. These topics can be rearranged, grouped together, or even hidden from view, so that you can manage a lot of information easily and efficiently.

Within an outline, you can enter, edit, or delete topics while maintaining an overview of the entire outline and its topics.

## Creating an outline

Shown below is an example of how a price list might look in the **Outline** application in full view mode.

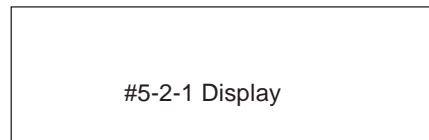

Title  
 Indicates a topic

Each individual topic heading is marked with a diamond.  
 Each outline title can be up to 20 characters long, and each

topic can contain up to 2,048 characters.

To enter the outline shown above:

1. Press **OUTLINE** to start the application.
2. Press **NEW**.

A title window appears.

#5-2-2 Display

3. Type in the title you want to give to your outline.
4. Press **ENTER**.

The View mode opens with the title as the first topic in the new outline. A flashing diamond prompts you to enter a subtopic.

#5-2-3 Display

5. Type the name of the first subtopic, pressing **↵** at the end of each line.

#5-2-4 Display

6. Press **ENTER**.

Alternatively, you can press **CANCEL** to discard the text you have entered. This will not cancel the entire outline but only the topic that is about to be stored.

If the second and subsequent lines of the topic just entered disappear from view, this is because only the first line of each topic is being shown. This feature allows you to have a lot of information on one page but to see only the first line (heading) of each topic. However, this single-line subtopic display is an option controlled by the user, who can also have all topics displayed in full instead. To do this, select **SHOW FULL TOPIC** from the application menu. Repeat this procedure to display only the first lines of subtopics, ie. to deselect **SHOW FULL TOPIC**.

7. Enter the other topics in the list above. Be sure to press **ENTER** after entering each one.

Notice there is no final command to store the outline. The outline you are currently working on will be stored automatically whenever you exit the outline by displaying another entry, change to Index mode, or start a new outline by pressing **NEW**.

- ☞ If you want to view the entire contents of a particular topic, select the topic, then press . Press  or  to return to the regular display.
- Text first entered as the title can be edited to extend up to 2,048 characters.

## Locating outlines

**Outlines** are stored in alphabetical order according to their titles.

### Using Index mode to find an outline

1. Go to Index mode. (If you are currently viewing an outline, simply press .)
2. If necessary, press the first letter of the desired outline name to jump to that entry in the list.
3. Select the desired entry and press  to see it in detail.

### Using keywords

If you know a word or words that appear within an entry even though you cannot remember the exact title, you can use the Search function to find the entry.

1. Press  .

The Search window appears.

2. Type in any words you remember in the entry you are looking for.
3. Press .

If you still do not see the desired entry, press  to display the subsequent matching entries.

4. Press  when you find the entry you want.

☞ The Search function does not distinguish between upper- and lower-case letters.

## Displaying full topics



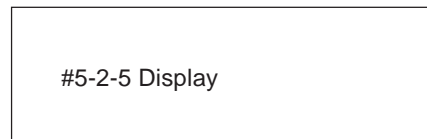

In the default settings, the **Outline** application is set to display only the first line of each topic. You can change this to display an outline in full.

1. Display the outline you want to work with.
2. Press , select SHOW FULL TOPIC and press . A ✓ symbol will appear next to the item on the menu.



All lines in all the topics are displayed.

To return to the one-line view, repeat the above procedure. The ✓ disappears from the menu.

To see contents that are off the display, use the cursor keys. You can also press   or   to move to the first or last topic.





 Changing the view mode in an outline does not affect the view mode setting of other outlines you have already created. However, a new entry will use the same view mode as the outline that was previously displayed.

## Revising outlines

Once an outline has been created, it is easy to revise either the text in the outline or the outline structure itself. This is why making outlines can be so useful. The text of topics and subtopics can be revised one at a time in Edit mode.

### Selecting topics

The flashing diamond indicates the currently selected topic. You can also move between topics one by one, using the cursor keys.

Press   to move directly to the last topic and   to move directly to the first topic, ie. the title.

### Editing text

Only one topic can be edited at a time.



1. Display the outline you want to revise.

If the entry is in the one-line view mode, select full view mode (see p.109) to display all the hidden text of the outline.

2. Select the topic you want to edit and press .

The block cursor appears at the start of the text.

3. Make any necessary changes.

4. Press  (or  to discard the changes).

The new, edited topic is now stored.

### Adding new topics



As your plans and ideas develop, you may wish to add topics to an existing outline. To add a topic at the end of an outline, display the outline in View mode, and then press  until you pass the last topic. Begin typing when the new diamond appears.



To insert a new topic anywhere else in the outline, use the following procedure. Note that only one new topic can be inserted at a time.

1. Display the outline in which you want to add a topic.
2. Press .

A white-on-black "I" is displayed to indicate the insertion position.





3. Move to the desired location using  and .
4. Type in the new topic.
5. Press .



Press  at any time before pressing  to cancel the insertion.

### Moving topics



Even after you have stored a topic, you can change its location easily.



1. Select the topic you want to move.
2. Press  .

The entire topic is momentarily highlighted, then replaced by a white-on-black "F".

3. Move to the new location using  and .
4. Press .

The entire topic now appears at the selected position.

Press  at any time before pressing  to cancel the move (the topic will reappear in its original position).

 As well as pressing  , you can also select MOVE from the application menu in step 2 above.



 Topics cannot be moved above the title.

### Joining two topics into one

You can join (merge) any two consecutive topics into one using the application menu. A selected topic is joined to the topic above it.

1. Select the topic you want to join to the one above it.

If the entry is in the one-line view mode, select full view mode (see p.109) to display all of the outline's hidden text.

2. Press , select JOIN/SPLIT TOPICS then press .

A submenu appears.

3. Select JOIN 2 TOPICS then press .

The topic you selected becomes joined to the one above it.



Beginning of topic selected for joining.

No space is inserted between the two topics when they are joined, so you might wish to add a space or a paragraph between them.

 If you attempt to join two topics which, when joined, will exceed the limit of 2,048 characters, the operation will be automatically canceled and no change will be made.

## Splitting one topic into two

A single topic can be easily divided (split) into two.

1. Select the topic you want to split.
2. Press **MENU** to display the application menu, select JOIN/SPLIT TOPICS then press **ENTER**.

A submenu appears.

3. Select SPLIT 1 TOPIC INTO 2 then press **ENTER**.

The selected topic is displayed with the cursor positioned on the first character. (Instructions are given at the top of the screen.)

4. Move the cursor to the point where you want to split the topic (on the last character of the first topic).

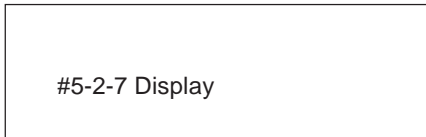

5. Press **ENTER**.

The part of the topic following the cursor position becomes a new topic.

-  If a topic that contains subtopics (see p.113) is split, the subtopics are assigned to the second (ie. new) topic.

## Deleting Outline topics

A FAMILY is the name given to a topic that contains one or more subtopics.

To delete a topic and its subtopics:

1. Select the topic you want to delete.
2. Press **MENU**, select DATA DELETION then press **ENTER**.

A submenu appears.

3. Select SELECTED FAMILY then press **ENTER**.

The selected topic is highlighted, and a confirmation message appears asking if you are sure you want to delete it.

4. Press **Y** (or **N** to cancel the deletion).

 You can also delete a selected topic (family) by pressing **DEL** in step 2 or 3 above.

 If you select a topic for deletion, all the subtopics (see p.113) below it will also be deleted. You may want to rearrange an outline beforehand to prevent this (see p.114).

## Deleting an outline

1. Select the outline you want to delete in Index mode or display it in View mode.

2. Press **MENU**, select DATA DELETION then press **ENTER**.

A submenu appears.

3. Select SELECTED OUTLINE then press **ENTER**.

A confirmation message appears asking if you are sure you want to delete the outline.

4. Press **Y** (or **N** to cancel the deletion).



You can also delete an outline by pressing **DEL** in Index mode.

### Deleting all outlines

1. In Index or View mode press **MENU**, select DATA DELETION then press **ENTER**.

A submenu appears.

2. Select ALL OUTLINES then press **ENTER**.

A confirmation message appears asking if you are sure you want to delete all outlines in the application.

3. Press **Y** (or **N** to cancel the deletion).



It is not possible to delete all outlines simultaneously if the Organizer is locked. See p.186.

## Using subtopics (children)

The examples used so far have only contained one level of topics (excluding the title, which is always on the first level by itself). This simple outline form may be all you need to organize your information. You can, however, create subtopics for greater flexibility. Each subtopic belongs to the particular topic that is on the next level above it. A subtopic can, in turn, have its own subtopics: these can continue for 15 levels below the title. Subtopics are referred to as children, the topic they belong to as the parent, and parents and children together as a family.

The example below shows an outline illustrating these points.

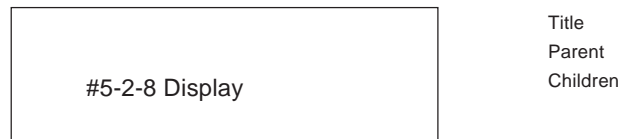

The hollow diamond indicates that the topic is a parent (has subtopics) while a solid diamond indicates that the topic has no children. This is useful because a topic's children may be hidden from view.

You can create a subtopic by pressing **'** before creating or moving a topic. The new subtopic will be a child of the topic directly above it. If you decide to reorganize an outline later, you can promote a subtopic to the same level as its

parent topic using the MOVE command within the application menu.

### Entering subtopics

To create the example shown above:

1. Press **OUTLINE** to start the application.
2. Press **NEW** and type in a title for the outline, then press **ENTER**.
3. Type in the first topic, then press **ENTER**.
4. Press **'** to make the second topic a child (subtopic) of "Northeast".

The cursor is now indented by one character.



# 5-2-9 Display

5. Now type in the text of the topic, and press **ENTER** when done.
6. Continue entering the outline until you reach the word "Central".
7. Press **\$** to place the new topic "Central" on the same level as "Northeast".



#5-2-10 Display

8. Continue and complete the outline in this manner.

### Collapsing families

As an outline grows in size and depth, you may find it difficult to manage. The collapse function allows you to condense the view and later expand only those topics and families that you wish to see.

Collapsing an outline hides all subtopics from view, displaying only first-level topics and the title.

1. Display the outline in the View mode.
2. Press **MENU**, select COLLAPSE ALL, then press **ENTER**.

All subtopics are collapsed into their topics and eliminated from the display.



#5-2-11 Display



If you want to collapse only one specific family, select its parent topic and then press **2nd** **E** or select

EXP/COL from the application menu. All subtopics belonging to that topic will be hidden from view.

### Expanding families

All subtopics that have been collapsed in a family or in the entire outline can be expanded.

1. Display the collapsed outline in View mode.
2. Select the particular topic you want to expand, or the title if you want to expand the entire outline.
3. Press **MENU**, select EXPAND FAMILY, then press **ENTER**.

All subtopics of the selected topic are displayed to the furthest level beneath the topic.

 You can also expand a family to display only the next-level subtopics below the parent topic. Select the topic whose next-level subtopics you want to see and press **2nd E** or select EXP/COL from the application menu.

### Restructuring families

You can move, delete, join and divide families just as you can with topics. You can also use **S** to move directly from a selected topic to its parent. However, these operations will affect the entire family regardless of whether or not the topic is collapsed and its subtopics are visible. Therefore, some care must be taken, since these

operations affect information that may not be visible. The following restrictions apply when working with families:

1. You may not be able to change the level of a collapsed family in certain situations. No other topics may be moved into a family unless the family is expanded. In general, if you are having problems with moving, expand all of the families (see above) and then try the desired move again.
2. You cannot insert a topic between a parent and its child at the same level as a parent. To do so would in effect split the relationship between the parent topic and its child. Thus pressing **S** in the situation illustrated below would not move the flashing diamond to the left.

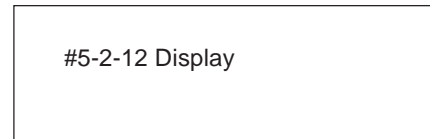

When moving topics (or families):

- A. You cannot indent a topic more than one character to the right of the topic directly above it.
- B. You cannot indent a topic directly below a collapsed family. You first have to expand the family.
- C. You cannot move a topic one character to the left if this action would split up a parent and a child.

Instead, move the selected topic to another location and then promote it.

If you divide a topic that has subtopics (children), the second half of the divided topic will become the parent of these subtopics. The two parts of the original topic remain on the same level.

You should not attempt to join a topic with a collapsed topic above it. If you do, the Organizer will ask for confirmation that this is what you really want to do. If you continue, it will combine that topic with the last topic in the preceding topic's family. It is therefore a good idea to first expand the collapsed topic's family, in order to see the topic and subtopics you are combining with.

## The Outline application menu

#5-2-13 Display

Moves the selected topic to the new location (see p.111).

Fully displays or collapses the subtopics of the selected topic (see p.114)

Displays single-line or full view of an entry (see p.109).

Displays all subtopics that have been collapsed (see p.115).

Collapses all subtopics (see p.114).

Combines or splits topics (see p.111).

Selects the specific entries for deletion (see p.112).

## CHAPTER 6

# Desk Accessories

The Organizer's desk accessories are a set of valuable utilities for everyday use. The **Calc** (Calculator) can perform calculations on figures entered either using the number keys or copied over from other applications. The **Clock** can simultaneously display the day, date, and time in any two cities of your choice. This chapter provides all the information you need to enjoy full use of these very useful applications.

## The Calc (Calculator) Application

The Organizer provides a 10-digit calculator which performs mathematical operations, including square root and percentage calculations, and can also calculate duration of time periods based on given dates, such as the number of days you have to complete a project. In addition, it has a paperless printer feature, which shows all calculations in a vertical column on the display, just as they would appear on a desk-top calculator's built-in printer-roll. The **Calc** application also provides support for cost/selling price markup and margin calculations.

There are five different display options in the **Calc** application, and the application always opens with the most recently used display.



To move between the different calculator modes, either press **CALC** repeatedly until the desired mode appears, or select VIEWS from the calculator menu and then select the desired mode.

### Using the arithmetic calculator

1. Press **CALC** to start the application.

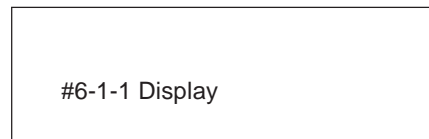

2. Perform the calculation using the numeric and mathematical symbol keys on the keyboard, just as you would with a regular electronic calculator.

To quit the **Calc** application, simply change to any other application by pressing the corresponding key.

- To clear an entered value, press  $\boxed{CzCE}$  once. To clear an entire calculator operation, press  $\boxed{CzCE}$  twice.
- Calculations are performed in the order of entry, not according to algebraic operator precedence, i.e., the calculation  $8 + 2 \times 3$  is performed as:  $(8 + 2) \times 3$  not  $8 + (2 \times 3)$ . This is just as for a regular electronic calculator.
- An M shown on the display indicates that a value is stored in the calculator's memory. Press  $\boxed{RzCM}$  twice to clear the memory.
- Press  $\boxed{\cdot}$  to erase the last digit typed.
- An E shown on the display indicates an error, usually an overflow error (when no more digits can be displayed). When this happens, the calculator will usually ignore any subsequent input until the error is cleared. Press  $\boxed{CzCE}$  to clear the error.
- Press  $\boxed{+/-}$  to change the sign of a displayed value.

→ For further information on other calculator operations, see p.124.

## The paperless printer

In the basic calculator mode, only the results of a calculation are displayed. Using the paperless printer, each step within a calculation are retained for reference so you can later edit specific parts of the calculation. This allows you to change numbers and operators (+, -, x, ÷, =), and even to undo interim steps within a calculation so that you do not then have to reenter the entire calculation.

Pressing  $\boxed{=}$  terminates a calculation sequence, and a value entered after any of these keys has been pressed begins a new calculation.

Up to 50 steps can be stored for a calculation. (Power calculations must be carried out by successively pressing  $\boxed{\times}$ , as opposed to using  $\boxed{=}$  as in the calculator mode. Otherwise, the functions are the same as those for the basic calculator mode.)

### Performing calculations

1. Press  $\boxed{CALC}$  repeatedly until the PAPERLESS PRINTER appears.
2. Enter the following calculation:  $25 \times 3$

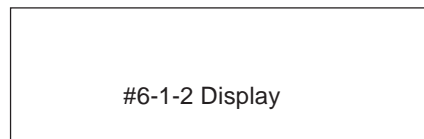

The number of steps that have been entered.  
Entered value



Operators



The symbol  in the paper-roll on the left of the display marks the starting entry. The value shown in the keypad window is either the value you have just entered or final result of the calculation, as indicated by ENTRY or ANSWER, respectively.

3. Press  to get the result.

### Checking intermediate results

1. Press  or  until you reach the line of the calculation you want to check.

The total up to and including the highlighted line is displayed. The number of the step you have highlighted appears in the small box to the right of the display's paper-roll.



Indicates the current step.

2. Press  once to return to the display of the final result, and again to clear the display.

### Inserting new figures

You can add new steps to a series of calculations recorded on the paperless printer.

1. Move to the line before which you want to insert the new value.
2. Press .

INSERT MODE briefly appears on the calculator's display.



3. Enter the operator and the value to be inserted then press .



The value is now included in the calculation.

4. Press  again to get the new total.

Once the total has been calculated the insert mode automatically changes back to the normal Entry mode. To return to the entry mode while editing a calculation, press  again.

### Changing part of a calculation

1. Move to the line you want to change using .
2. Enter the new operator and value then press .
3. Press  again to get the new answer.

 If you press  by mistake and move into Insert mode, press  again to return to normal Entry mode.

## Deleting a line

1. Move to the line you want to delete using **PREV**.
2. Press **DEL**.

The selected line is removed from the display.

3. Press **ENTER** to get the new total.

## Calculating dates

As well as performing standard arithmetic calculations, the **Calc** application lets you determine the period of time (in days) between two specific dates, and also what the date will be a certain number of days before or after a particular date.

### Calculating the number of days between two dates

1. Press **CALC** a few times until the date calculator appears.

The current date appears as the default starting date.

Follow step 2 below if you wish to change the starting date. If you want the calculation to start from the current date, skip step 2 instead.

#6-1-4 Display

Starting date

2. Press **CANCEL** once to clear the starting date field and then enter the desired starting date. Prefix a single-digit month or day with a "0".
3. Press **~**.
4. Enter the ending date.
5. Press **=**.

 If you wish to have today's date as the ending date (when the starting date is prior to today), use **2nd D** to enter today's date.

The number of days between the two dates is shown.

-  • If you make a mistake, press **CANCEL** to return to a previous step.
- If you enter an invalid date or other value, for example if you forget to enter the year, the operation will not be performed and nothing will happen when you press **ENTER**.

### Calculating a date by specifying a number of days

1. Press **CALC** a few times until the date calculator appears.

The today's date appears as the default starting date. If you want to calculate a date starting from today's date, skip the next step.

2. Press **CANCEL** to clear the starting date field and enter the desired starting date. Prefix a single-digit month or date with a "0".
3. Press **+** to enter a number of days in the future, or **-** for a number of days prior to today.

#6-1-5 Display

4. Enter the number of days to base your calculation on.
5. Press **=**.

The calculated date is displayed, together with the day of the week.

 You can continue to calculate dates in the future or past using the calculated date as a new starting date; after a date is calculated, press **+** or **-**, as desired. The most recently calculated date is automatically entered in the FROM field. Simply enter the number of days to be calculated and press **=**.

 If you make a mistake, press **CANCEL** to return to a previous step.

## Using the Calculator with other applications

The **Calc** application can perform calculations that have been written out as text within another application.

### Transferring data from an application entry into Calc

1. Open the application containing the text to be calculated.
2. Highlight the calculation text.

#6-1-6 Display

3. Press **2nd** **COPY** to copy the text.
4. Press **CALC** to open the Calc application and press **2nd** **PASTE** to bring in or paste the copied calculation.

The copied calculation is performed automatically, and the result is displayed.

#6-1-7 Display

## When E appears

When any of the following situations occur, the error indicator E is displayed and calculations are suspended. Press **[CzCE]** to clear the error.

- The integer part of the calculation result is within the range of 11 to 20 digits (a rough calculation is obtained).

Example: 4567890123 **[x]** 456 **[=]**

208.2957896 is displayed with E, which indicates that the rough result is:

208.2957896 x 10<sup>10</sup> (ie. 2,082,957,896,000)

- In paperless printer mode, no rough calculation can be obtained.
- The integer part of the calculation result exceeds 20 digits.
- The integer part of the numerical value in the memory exceeds 10 digits.
- A number is divided by "0".

## Cost/Selling price/Markup and Cost/Selling price/Margin calculations

The **Calc** application provides a useful function for making markup and margin calculations, based on figures that you supply via the keyboard. The way it works is simple: you enter two of the values that you already know for either the cost, selling price or markup/margin, and the calculator works out and displays the missing value. For example, if you enter the cost and the selling price, it will tell you the percentage markup or margin based on those two values. If you enter the selling price and the markup or margin, it will tell you the cost.

1. Press **[CALC]** several times until the COST/S.PRICE/MARKUP display or the COST/S.PRICE/MARGIN display appears, as required.

#6-1-8 Display

2. Use **[←]** **[→]** to move to the fields whose values you already know, and enter the values.
3. Press **[SOLVE]** to calculate the missing value.

The missing value is displayed in the appropriate field.

☞ Note that you must move out of a field in which you have just entered a value before the calculation can be performed.

### Re-calculating using different values

Once you have made a Markup/Margin calculation, you can recalculate using new values without having to start from the beginning.

1. Move to whichever field(s) whose values you want to change, and enter the new values.

☞ Press  **NEW** to clear the contents of a field before entering a new value.

2. Move to the field whose new value you want to calculate, and press  to indicate the missing value.

3. Press **SOLVE**.

The new value is calculated and appears in the field.

### Setting the number of decimal places

When using the Cost/Selling price/Markup and Cost/Selling price/Margin calculator, you can choose whether the number of decimal places used in calculations is 0 or 2.

In either Cost/Selling price/Markup or Cost/Selling price/Margin calculator mode:

1. Press **MENU**, select DECIMAL POINT SETTINGS and press **ENTER**.
2. Select the desired setting and press **ENTER**.

The desired number of decimal points is applied.

☞ Note that when no decimal points are used (ie. DECIMAL POINT : 0 is selected), pressing the decimal point key will have no effect, but any numbers entered subsequently will be treated as integers. For example, typing 12.75 will be treated as 1,275, which will produce a very different calculation result.

## Calculation examples

Calculation	Example	Operation	Display (answer)
Arithmetic	$12 \times 3 + 5 =$ $(-24) \div 4 - 2 =$	$12 \boxed{\times} 3 \boxed{+} 5 \boxed{=}$ $24 \boxed{+/-} \boxed{\div} 4 \boxed{-} 2 \boxed{=}$	41. -8.
Constant	$34 + \underline{57} =$ $45 + \underline{57} =$  $68 \times 25 =$ $68 \times 40 =$	$34 \boxed{+} 57 \boxed{=}$ The addend becomes a constant. $45 \boxed{=} \boxed{=}$  (Subtraction and division are performed in the same manner.)  $68 \boxed{\times} 25 \boxed{=}$ The multiplicand becomes a constant. $40 \boxed{=} \boxed{=}$	91. 102.  1,700. 2,720.
Percentage	What is 10% of 200? What percentage is 9 of 36?	$200 \boxed{\times} 10 \boxed{\%}$ $9 \boxed{\div} 36 \boxed{\%}$	20. 25.
Add-on	What results from a 10% increase of 200?	$200 \boxed{+} 10 \boxed{\%}$ (or $200 \boxed{\times} 10 \boxed{\%} \boxed{+} \boxed{=}$ )	220.
Discount	What is 500 after a 20% discount?	$500 \boxed{-} 20 \boxed{\%}$ (or $500 \boxed{\times} 20 \boxed{\%} \boxed{-} \boxed{=}$ )	400.
Square root	$\sqrt{25 - 9} =$	$25 \boxed{-} 9 \boxed{=} \boxed{\sqrt{\quad}}$	4.
Power	$(4^3)^2 =$	$4 \boxed{\times} \boxed{=} \boxed{=} \boxed{\times} \boxed{=}$	4,096.
Reciprocal	$1/8 =$	$8 \boxed{\div} \boxed{=}$	0.125

Calculation	Example	Operation	Display (answer)
Memory	Summation	<p>Clears the memory before performing any calculations.</p> <p>RzCM RzCM</p> <p>25 [x] 5 [M+]</p> <p>84 [ ] 3 [M-]</p> <p>68 [+] 17 [M+]</p> <p>RzCM</p> <p>RzCM RzCM</p> <p>14 [M+] 3 [x] 2 [M-]</p> <p>52 [-] 35 [x] [RzCM] [=]</p>	<p>125.<sup>M</sup></p> <p>28.<sup>M</sup></p> <p>85.<sup>M</sup></p> <p>182.<sup>M</sup></p> <p>6.<sup>M</sup></p> <p>136.<sup>M</sup></p>
	<p>25 x 5 =</p> <p>-) 84 ÷ 3 =</p> <p>+ ) 68 + 17 =</p> <hr/> <p>(Total) =</p> <p>Temporary memory</p> <p>(14 - 3 x 2) x</p> <p>(52 - 35) =</p>		

## The Calc application menu

#6-1-9 Display

Selects the basic, paperless, date, cost/sell/margin or cost/sell/markup calculator mode.

Selects the entry mode in the paperless calculator.

Selects the insert mode in the paperless calculator.

Sets the number of decimal places (see p.123).

# The Clock Application

The unit's built-in clock makes it possible not only to know the correct time and date in your area, but also to know the time in other cities or any region around the world. The **Clock** is used as the reference time by the **Calendar**, **Schedule**, and **To Do** applications. In addition to these features, daylight saving time (DST) can be enabled for any city you designate, for those countries that use an annual Daylight Saving Time adjustment.

As an aid to international business and travel, the Organizer is set to display the time in any other city you choose (called the World City) as well as your own city (the Local City). In addition, the Organizer comes with a pre-defined list of countries and cities. If the city you want is not in the pre-defined list, you can add your own User-defined city by specifying the city name, country and time relative to GMT (Greenwich Mean Time) (see p.130).

To view the Clock, simply press **CLOCK**.

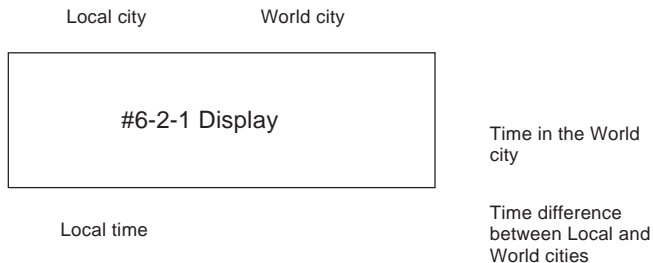

## Changing the Local city

The Local city is the city selected to provide the local time. When you first use your Organizer, the default Local city is set as New York. To change this setting:

1. Press **MENU** to open the **Clock** menu.
2. Select SET CLOCK then press **ENTER**.
3. Select CHANGE LOCAL CITY then press **ENTER**.

A list of cities appears. The currently selected city is at the top of the list. The cities are listed in alphabetical order by country and then by city name.

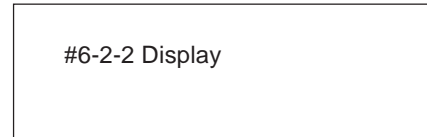

4. Type the first letter of the name of the country in which the target city is located. (For example, if you wanted to select San Francisco, you would type *U* for United States.) Then use **PREV** and **NEXT** to display the city you want.
5. Use **↑** and **↓** to select a city. You can also use **PREV** and **NEXT** to move up and down the list.
6. If the selected city observes Daylight Saving Time, press **↵** to indicate this.



This advances the Local time by one hour. A symbol appears beside the city to indicate that daylight saving time has been set.

7. Press **ENTER**.

The **Clock** window appears briefly, showing the new Local city. The time is automatically adjusted.

☞ • If you have defined a User city and want to select it as the Local city, press **SPACE** to access the user-defined cities (see p.129).

• Certain countries will be abbreviated as follows:

Federal Republic of Germany	GERMANY, F.R.
Papua New Guinea	PAPUA N.GUINEA
Czech Republic	CZECH REP.
Republic of Trinidad and Tobago	TRINID. & TOB.
Dominican Republic	DOMINICAN REP.
French Polynesia	FR. POLYNESIA
United Arab Emirates	U.A. EMIRATES
United States of America	USA

• Country and city names in the list and their relative time differences are current as of January 1992.

## Setting the time and date

1. Press **MENU** to open the **Clock** menu.
2. Select SET CLOCK and press **ENTER**.
3. Select ADJUST TIME/DATE and press **ENTER**.

The ADJUST TIME/DATE window opens.



The window has three fields: Local Time, Time System, and Local Date.

4. Enter the current time and press **AM** or **PM** (for AM or PM). Be sure to enter a 0 before a single-digit hour or minute entry.
5. Move to the TIME SYSTEM field. Press **S** or **'** to indicate whether you want the time shown in 12- or 24-hour format.
6. Move to the LOCAL DATE field. Enter the current month and day in two digits, and the year in four digits. You can also select the date by pressing **-** to display the pop-up calendar. (Use **PREV** and **NEXT** to display the desired month, then **↓** **-** **S** **'** to move to the current day.)

You can set any date from January 1st, 1901 to December 31st, 2099.

7. Press **ENTER** (or **CANCEL**) to cancel the changes).

The time and date are now stored.

- You can access CHANGE LOCAL CITY from this display by pressing **2nd** **W**. Because the Organizer automatically adjusts the time after the Local city is changed, you should select the Local city before setting the time and date.
- Changing the setting in the TIME SYSTEM field also changes the time display format for all the Organizer's time-related applications and functions, such as **Schedule** and Time Stamp.

## Checking the time in a city

You can find out the time anywhere in the world using the **Clock** application by selecting another city, called the World city. Selecting a city as the World city will display the time in that city as well as the Local city when you press **CLOCK**. The Organizer also shows you the time difference between the current World city and the Local city. When you first use the Organizer, the default World city is London.

To change the World city:

1. Press **MENU** to open the **Clock** menu.

2. Select SET CLOCK and press **ENTER**.

3. Select CHANGE WORLD CITY and press **ENTER**.

A list of four cities appears. These will be the four cities you most recently selected, or checked the time in. The currently selected World city appears at the top of the list.

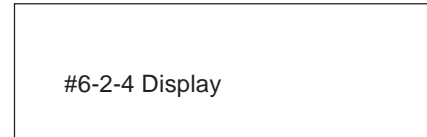

4. If the city you want to select as your World city is on the list, select it and then proceed from step 7 below. If not, press **SPACE** or type the first letter of the country containing the target city.



A list of cities appears. The first three cities are User cities which you can specify (see below). Just as for the LOCAL CITY list, all cities in this list are in alphabetical order according to country name.

Use **↑**, **↓**, **PREV** and **NEXT** to display the city you want.



5. Select the desired city.
6. If Daylight Saving Time (DST) is observed by the selected city, press  to indicate this.

A symbol appears beside the city, indicating that DST has been set.

7. Press .



The city is selected as the World city and the window closes.

The **Clock** window briefly appears, indicating the time in the selected World city. The time difference relative to the Local city is displayed below the World city time.

 While selecting a city from the list, you can press  at any time to return to the first page of the list.

## Adding a User-defined city



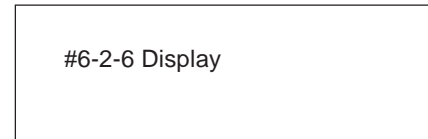

Since some cities you may wish to use might not appear in the Organizer's built-in pre-defined list of cities, the **Clock** application lets you define your own cities, called User cities, for use as the Local and World cities.

1. Press  to open the **Clock** menu.
2. Select SET CLOCK and press .
3. Select ADD USER'S CITY and press .

The ADD USER'S CITY window opens.



You can set up to three cities by entering information in the three fields. In the unit's default settings, New York has been designated as USER CITY1.

4. Move to the field you would like to change for USER CITY1, 2, or 3.
5. Press   to delete the current name and enter the name of your desired city.
6. Move to the COUNTRY field.
7. Delete the current setting and enter the name of the country where the city is located.
8. Move to the GMT (Greenwich Mean Time) field.
9. Enter the time difference between the user city and Greenwich Mean Time (the international time reference). Press  before a number to indicate a negative time difference (ie. the time in the selected city is earlier than GMT). You can specify any value from -11.5 to +12 to the nearest half-hour.
10. Press .

The city you entered is then stored as a User city, and is listed on the first page on both the Local and World city lists.

→ To select the User city you have just entered as the Local or World city, see p.126 or p.128, respectively.

## Daylight Saving Time (DST)

### Assigning DST to a city

Designating Daylight Saving Time (DST) for a city automatically sets the time for that city one hour ahead of its regular time.

1. Press **MENU**, select SET CLOCK then press **ENTER**.
2. Select either CHANGE LOCAL CITY or CHANGE WORLD CITY (it doesn't matter which you choose) then press **ENTER**.
3. Select the desired city using **↑**, **↓**, **PREV** and **NEXT**.
4. Press **↵**.

A symbol appears to the left of the city, indicating that DST is in effect.

5. Press **ENTER**.

To de-assign a city's DST setting, simply follow the above procedure and press **↵** again (this toggles DST between

on and off).

### Enabling and disabling DST

Once DST is assigned to a city, it remains in effect until it is de-assigned. Once a year, cities using DST will switch back to regular time. Rather than having to de-assign DST for each city separately, you can simply disable the Organizer's DST feature itself, which then applies to all cities within the Organizer. When these cities switch back to DST, you can simply re-enable the feature without having to change any city's entry.

1. Press **MENU** to open the **Clock** menu.
2. The current DST setting (enabled or disabled) is indicated by a tick. Select ENABLE DST to change the setting.

When DST is disabled, the DST symbol disappears from the **Clock** display.

### Setting daily alarms

You can set alarms just like on a regular clock, separately from **Schedule** events, using the **Clock** menu. Set alarms will sound even if the Organizer is turned off.

This can be especially convenient, for example, when you need an alarm as a simple reminder or to wake you up, but do not want to make a full **Schedule** entry.

1. Press **MENU** to open the **Clock** menu and select SET DAILY ALARMS, then press **ENTER**.

The SET DAILY ALARMS window opens. You can set up to five alarms.



2. Enter the time for the desired alarm, followed by **AM** or **PM** for AM or PM.
3. Press **↵** to set the alarm.
4. Move to the next field and set any other alarms you want using the same procedure.
5. Press **ENTER** (or **CANCEL** to cancel the setting).

### Turning alarms on and off

To turn off an alarm that is sounding, press **ON**. Alarms will turn off automatically after sounding for 15 seconds.

To unset an alarm, select SET DAILY ALARMS from the **Clock** menu, select the alarm you want to turn off, and press **↵** (alarms are indicated as set or unset in the display's middle field).

### Disabling all alarms

Once you have set an alarm, it will sound at the appropriate time whether the Organizer is turned on or off. When the Organizer is on,  at the top of the display indicates that any alarm that is set will sound at the appropriate time.

There may be times when you do not want to hear any of the set alarms. You can disable all **Schedule** and Daily Alarm sounds easily with a single operation.

1. Press **MENU** three times to open the TOOLS menu.

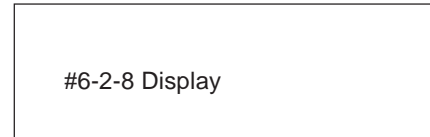

2. Select ENABLE ALL ALARMS and press **ENTER**.

The  disappears from the display. All alarm sounds are now turned off, ie. no audible alarm will sound, until you use the above procedure to turn them on again by re-selecting ENABLE ALL ALARMS. However, each alarm will still be displayed when it reaches its set time, even when the unit is turned off. This means the alarm sounds are disabled, but not the alarms themselves.

## The Clock application menu

#6-2-9 Display

Sets the built-in clock.

Sets and controls up to five alarms to sound daily (see p.130).

Turns all DST settings on or off.

## CHAPTER 7

# Money & Account Management

The OZ-5500 Organizer's **Money Tracking** application provides you with a sophisticated and easy-to-use tool for managing your personal and business finances. It offers comprehensive facilities for recording cash, bank and credit card transactions. It also helps you reconcile account balances. It can even automatically create a corresponding transaction to transfer funds from one account to another.

## Money Tracking application

### What it can do

Transactions are stored against accounts that you create and manage. Once the accounts are set up and the transactions recorded, you can monitor and print summaries or details of all your financial activities and balances. The **Money Tracking** application can help you balance your accounts at the touch of a few buttons. You can even transfer information between your money management software on your desktop computer (Quicken®, MS-Money®) and the OZ-5500 using the optional Link software.

### Introducing Money Tracking concepts

The **Money Tracking** application utilizes two main concepts for organizing its information: Accounts and Transactions. In **Money Tracking**, Accounts are used like any other accounts you use: bank accounts for checking and savings, credit cards, and cash accounts for the money you carry. The **Money Tracking** can support up to 16 different accounts.

Whenever you use an account either to make or receive a payment, this represents a Transaction. Just like any bank account, **Money Tracking** records different transactions against various accounts, and allows you to see when, where, how, to whom and why various payments were

made or received for a given account, conveniently and reliably.

You may view each account and related transactions by pressing the **MONEY TRACKING** key. To display the next account in alphabetical order, simply press the **MONEY TRACKING** key again. To view the details of a transaction simply select the transaction using **←** and **→** and press **ENTER**.

☞ Since up to 16 accounts can be created, when looking for a particular account you may find it quicker to press **2nd** **MONEY TRACKING** to move through the accounts in reverse alphabetical order.

The **Money Tracking** operations described in this chapter are:

- \* Things to Know about **Money Tracking**
- \* Setting up **Money Tracking** accounts
- \* Viewing account information
- \* Editing or viewing account details
- \* Entering **Money Tracking** transactions
- \* Viewing account transactions
- \* Displaying transactions in detail: View mode
- \* Editing/updating existing transactions: Edit mode
- \* Listing all transactions
- \* A closer look at **Money Tracking** transactions
- \* Using the Filter to display selected transactions
- \* Canceling an active Filter
- \* About Categories
- \* Using the pre-defined Categories

- \* Adding your own Categories
- \* Editing Category names
- \* Using Categories
- \* The SPLIT function
- \* Automatic transfers
- \* Making a transfer for a SPLIT transaction
- \* Account balancing and reconciliation
- \* Deleting **Money Tracking** information

## Things to Know about Money Tracking

- When to begin using the money tracking application  
  
Begin using the **Money Tracking** application after you have balanced your last statement for the account.
- Enter the Opening Balance as the ending balance of that statement
- Enter all transactions that have occurred since your last account statement  
  
Be careful to enter all transactions in to the OZ-5500 so that you can carefully maintain your account balance and so that when you get your next statement to balance your account.
- Save time by using the Word Key  
  
Store your commonly used phrases including Payee names, Memo's or Special information in the Word area. Please see p. 143 for further details.



- Memory is full – What can I do

Removing reconciled transactions from memory will free up memory space. Make sure you back up these transactions for future reference either by printing or saving to your computer with the optional Link software.

- Sharing information with my desktop money management software

The optional Link software will enable you to transfer the OZ-5500 transactions to your computer using the standard QIF format. After being uploaded to the computer you can then import them into your money management software using the Import feature. You can also Export transactions from your desktop software to your OZ-5500.

- How secret works with **Money Tracking**

If your organizer is locked, the account balances will be displayed as ##,###,###.## until the organizer is unlocked.

## Setting up Money Tracking accounts

All **Money Tracking** transactions are recorded against accounts set up by the user. There are no default accounts. The first step in using the **Money Tracking** application is to set up your personal accounts.

To enter a new account:

1. Press **MONEY TRACKING** to open the **Money Tracking** application.
2. Press **MENU** and select SET UP ACCOUNT followed by **ENTER**.

The ACCOUNT LIST appears, with the name, type and current balance of any existing accounts. When defining an account for the first time, the list will be empty.

3. Press **NEW**.

The ACCOUNT INFORMATION window is displayed.

#7-1-1

☞ When you use the **Money Tracking** application for the first time, there are no accounts set up. When you press **ENTER** or **NEW** for the first time after opening the application, you will be warned there are no accounts set up. The procedure to create new accounts will then be initiated automatically after you press **ENTER** once more.

4. Enter the name you wish to give the new account (up to 15 characters long) and press **NEXT**.

The cursor moves to the TYPE field.

5. Press  , select the desired account TYPE from the list, press  to close the list and then press .

#7-1-2

 The account type describes the purpose of the account and determines the exact terms used to describe debit and credit transactions. [eg. Credit Card=Charge/Payment, Bank=Payment/Deposit, Cash=Spend/Receive).

The account type is also one of the selection criteria used for the Filter function (see p.143)

The cursor moves to the OPENING BAL field.

6. Enter the account's OPENING BALANCE (maximum 8 digits plus 2 decimal places) followed by .

#7-1-3

 Take care when entering the opening balance for a new account, as an incorrect value will cause subsequent account operations to result in further

incorrect balances. The method of determining the starting balance depends on the account type:

- BANK** – Use the “Closing Balance” shown on your most recent bank statement.
- CREDIT**– Use the “New Balance” shown on your latest credit card statement. Even though this represents a debit ie. an amount that you owe, you should enter the amount as it appears on your statement, ie. without a minus sign “-”. When performing account calculations, the Organizer knows that an amount in a CREDIT CARD account is actually a debit.
- CASH** – Enter the total amount of cash you have at the present time.

The cursor moves to the ACCOUNT DATA field.

7. The ACCOUNT DATA (up to 25 characters) is optional and designed to supplement the NAME and TYPE fields. This field could be used to record the account number, for instance. Press .

The cursor moves to the NOTE field.

8. Again the NOTE field (up to 25 characters) is optional. It is designed to provide further information about the purpose and usage of the account (eg. account phone number).

9. Press  to store the new account details.

The Account List is displayed, showing the summary of the new account just created and the new total balance.



### Viewing account information

A summary of existing accounts may be viewed at any time after they have been set up.

1. Press **MENU**.
2. Select SET UP ACCOUNT and press **ENTER**.

The ACCOUNT LIST is displayed, showing name, type and current balance of all existing accounts.

☞ Press **MONEY TRACKING** to switch between displaying the Opening or Current account balance.

### Editing or viewing account details

The details any account may be edited or viewed at any time after it has been set up. This would usually be in order to view or change the ACCOUNT DATA, NOTE or TYPE fields, since the other fields are unlikely to require updating unless they were originally entered incorrectly. However, since this involves the account setup information and not the actual transactions, this is an operation the user would only use occasionally.

1. Press **MENU**, select SET UP ACCOUNT and press **ENTER**.

The ACCOUNT LIST is displayed.

2. Select the desired account and press **EDIT**.

A message appears, warning you that editing certain fields may cause a discrepancy in the reported account balance.

3. Press **ENTER** to proceed.

The ACCOUNT INFORMATION screen appears in Edit mode.

4. Make any desired changes, then press **ENTER** to store your changes (or **CANCEL** to retain the original details).

The message "Stored!" appears.

☞ Press **MONEY TRACKING** to switch between displaying the Opening or Current account balance.

### Entering Money Tracking transactions

Once you have set up the desired account, you are ready to enter **Money Tracking** transactions to record the use of the account.

To enter a new **Money Tracking** transaction:

1. Press **MENU**, select SET UP ACCOUNT and press **ENTER**.

The ACCOUNT LIST is displayed.

2. Select the desired account from the list, then press **ENTER**.

 You may also select the desired account by skipping steps 1 & 2 and instead pressing **MONEY TRACKING** (or **2nd** **MONEY TRACKING**) until the account is displayed.

The Index view for the selected account appears.

3. Press **NEW** to enter a new transaction for this account.

The blank MONEY TRACKING display appears in Edit mode.

#7-1-5

The name of the selected account appears in the ACCOUNT NAME field.

 If you change your mind and wish to enter this transaction for a different account instead, simply move to the ACCOUNT field, press **←**, then select the desired account from the list and press **ENTER**.

 If you press **NEW** to create a new transaction while displaying ALL transactions (ie. no account is

currently selected), the name of the account for which the most recently created transaction was assigned is appears in the ACCOUNT NAME field as the default.

The cursor appears in the DATE field, which already contains today's date as the default.

4. Enter the date of the transaction (if you do not wish you use today's date). You can enter a date either via the keyboard or by pressing **←** and selecting the date from the pop-up calendar.
5. Press **NEXT** to move to the REF./NUMBER field. Enter an optional reference number for the transaction, then press **NEXT**.

The cursor moves to the PAYEE field.

6. Enter the name and details of the PAYEE of the transaction (up to 27 characters). This will be the name of the person or company who either pays you the amount of the transaction (for a credit) or to whom you are paying (for a debit). Press **NEXT** to move to the next field.

The cursor moves to the TYPE field.

7. Use **\$** and **'** to indicate whether this represents a debit or credit transaction. Press **NEXT** to move to the next field.

 Note that the exact words appearing in the TYPE field to represent the debit and credit transactions vary according to the TYPE of the ACCOUNT for which the

current transaction is being assigned. For example, if the account type is CASH, a debit is SPEND and a credit is RECEIVE.

8. Enter the transaction amount and press **NEXT**.

The cursor moves to the CATEGORY field.

9. Enter the optional CATEGORY for the transaction by pressing **⏏** and selecting the desired category from the pop-up menu.

#7-1-6

- ☞ When selecting a category from the pop-up list, you can jump to a particular category by pressing the letter key corresponding to the first letter of the desired category name. To skip to the end of the Category list, press **2nd** **NEXT**, or press **2nd** **PREV** to jump back to the top of the list.

Since CATEGORY is an optional field, select <NONE> if the transaction is not to be assigned to any category.

Select {SPLIT} if you wish the transaction being entered to be assigned to multiple categories. When {SPLIT} is selected, the SPLIT window is displayed, allowing the user to specify up to 10 sub-amounts and corresponding categories for the transaction. The total of the 10 sub-

amounts should equal the full amount entered in the transaction.

- 💡 The pop-up list contains those categories already defined (via the CATEGORIES function) in the **Money Tracking** application menu. Instead of using the pop-up list, you can enter a new category in this field. Any category you type in will be added automatically to the category list if it does not already exist.

➔ For more detailed description of using categories with money tracking transactions, see “About Categories” on p.145.

10. Press **NEXT** to move to the MEMO field.
  11. You may enter some descriptive text in the MEMO field (up to 27 characters) to remind you of the reason, purpose or other explanation of this transaction, then press **NEXT** to move to the next field.
  12. For the CLEARED field, press **⏏** and select the appropriate transaction clearance status from the list. The default value is NOT CLEARED. Press **NEXT** to move to the next field.
- ➔ For a more detailed description of the CLEARED field, see “A closer look at Money Tracking transactions” on p.142.
13. Enter any further descriptive information in the

SPECIAL field to remind you of the purpose or some other relevant data about this transaction.

☞ Note that any text you provide in the MEMO and SPECIAL fields can be used by the Filter function to selectively access particular transactions.

14. Press **ENTER** to store the transaction details, or **CANCEL** to discard the changes.

A message confirming the transaction has been successfully stored in memory is briefly displayed, and the transaction then appears in View mode.

## Viewing account transactions

The Index mode view for a particular account provides a useful summary of the main details of all the transactions on that account. This is the quickest way to gain a broad picture of the status and operations on the account, and also allows you to select particular transactions for which you wish to view the full details.

To view a particular account's details in Index mode:

1. Press **MENU**, select SET UP ACCOUNT and press **ENTER**.

The account list is displayed.

2. Select the desired account from the list, then press **ENTER**.

The Index mode view of the account then appears, with the account name displayed at the top of the screen. Each row represents the summary of a different transaction, sorted in ascending date order (ie. oldest first).

3. Since not all the information for each transaction can be displayed on the screen at one time, press **↑** to view the rest of the transaction summary, and press **↓** to go back. Press **←** and **→** to scroll the transactions when there are too many to be displayed at one time.

The CLEARED field is shown as a summary, with a single character to represent the current status.

Transaction amounts are displayed differently depending on the type of account. Bank and Cash accounts display debits (Payments or Spend) with a preceding minus sign, and credits (Deposits or Receive) without a sign. Credit Card accounts show charges without a sign and payments with a preceding minus sign.

The description given in the amount heading is determined by the TYPE field in the ACCOUNT INFORMATION window defining the account.

#7-1-4A

## Displaying transactions in detail: View mode

Account Index mode described above provides single-line summaries of all the transactions in a given account. You can then easily select any transaction in the displayed list to view its full details in View mode. Note that for each transaction, although the REF./NUMBER field holds up to six characters, only the last four characters are displayed in Index mode.

1. Follow the above procedure for displaying an account in Index mode.
2. Select the desired transaction and press **ENTER**.

The **Money Tracking** transaction screen appears, with the full details of the selected transaction displayed in View mode.

3. Press **←** and **↑** to scroll the display to view those fields that cannot fit on the display.

 Press **□** to view the details of a transaction with SPLIT Categories.

→ See p.147 below for information on SPLIT transactions.

4. When you have finished viewing the transaction, press **ENTER** to return to the account Index mode, or press **CANCEL** to display the ALL account transaction view.

 When viewing a given transaction, you can use **NEXT** and **PREV** to view successive and previous

transactions in the same account, without having to return to the account's Index mode to select a different transaction. The Organizer warns you if you reach the first or last transaction entry in an account.

## Editing/updating existing transactions: Edit mode

All transactions can be edited once they have been created, in order to update any or all of their fields when certain details change. For instance, you may wish to amend a transaction entry to reflect the fact that a transaction that was previously NOT CLEARED is now CLEARED.

To edit an existing transaction entry:

1. In account Index mode: highlight the transaction to be edited and press **EDIT**.

In transaction View mode: press **EDIT**.

The transaction is then displayed in Edit mode.

#7-1-7

2. Use **NEXT** and **PREV** or the arrow keys to move to any fields to be edited.

☞ When editing text fields or the amount, you can use  **NEW** to clear the field before typing in new text.

3. Press **ENTER** to store the edited transaction entry, or **CANCEL** to discard the changes.

When **ENTER** is pressed, a message indicating the entry has been successfully stored briefly appears. The transaction is then displayed in View mode.

## Listing all transactions

Although every transaction must be assigned to a specific account, the **Money Tracking** application allows you to view summaries of all transactions in date order, regardless of the account to which they belong.





1. Press **MONEY TRACKING** repeatedly until "ALL" appears in place of an account name.

☞ If you pass the ALL display by mistake, press **2nd** **MONEY TRACKING** to move through the accounts in the reverse order.



A summary of all transactions appears in Index mode, with one line per transaction.

💡 If you are currently in transaction View mode, you can jump directly to the ALL account transaction view by pressing **CANCEL**.

2. Press  to view those transaction details that cannot fit on the display. Press  to redisplay the original group of transaction details.
3. If necessary, use  and  to scroll the display up and down to display any additional transactions that may not fit onto the display.

## A closer look at Money Tracking transactions

Each **Money Tracking** entry contains certain fields with special functions to allow the user to control the exact status of transactions requiring further processing.

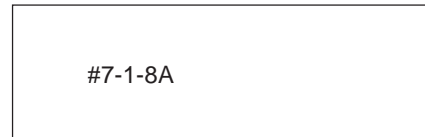

- \* **CLEARED** - Indicates the status of the transaction with the bank or credit card company. The options are **NOT CLEARED**, **CLEARED** and **RECONCILED**. Using the example of a checking account, when you write a check the status is **NOT CLEARED**. After the check returns to your bank and the money has been withdrawn from your account, the check status is **CLEARED**. When you receive your statement from the bank and you reconcile



the statement with your records, the transaction becomes RECONCILED.

The OZ-5500 can handle these steps for you. When you create a transaction, the default is NOT CLEARED.

When you receive your statement from the bank, you may perform the account balancing procedure on the OZ-5500. The first step is to verify that the transactions listed on the statement agree with the transactions listed in the OZ-5500. During this step of the Account Balancing procedure, the transactions are marked as CLEARED. When all the transactions have been correctly marked and the account is balanced, the status is automatically changed to RECONCILED. (See Account Balancing p.152)

- \* SPECIAL - allows you to provide additional information to describe the purpose of the transaction (up to 27 characters). These transactions can later be accessed as a group using the Filter function. For example, to track all business expenses for a certain client you may put the client's name in SPECIAL and later use the Filter function to list all the transactions for the client.

SPECIAL could also be useful for business people and others who incur regular expenses for which they are reimbursed at a later date. After you incur a business expense, you usually need to submit an expense claim in order to be reimbursed later. When entering a transaction for a business expense, you could set this field to NOT SUBMITTED. Once you submit your

expense claim, you can update this to SUBMITTED, to reflect the change. When the expense is later settled and you receive payment, you can update the field to indicate that you have been REIMBURSED.



To make this even easier, you could set up the words NOT SUBMITTED, SUBMITTED and REIMBURSED using the WORD key. You could then recall these words easily when tracking the progress of your expense claim.

→ Refer to the WORD key function (p.164) for more details.

## Using the Filter to display selected transactions

The Filter function allows you to see only those transactions that meet selection criteria that you specify. This makes it faster and easier to access the information that you want.

Transactions may be filtered by any or all of the following fields: Account, (within a) date range, Payee name, Category, Memo, Cleared status, Special and Secret status.

To activate the Filter:

1. Press **MENU** twice to open the PREFERENCES menu, select SET FILTER STATUS and press **ENTER**.

The SET FILTER STATUS window appears.

- To specify only transactions from a particular account, press  and select the desired account. Select ALL (which is the default) to indicate that the selected transactions can be from any account.



- Specify any other fields for the remainder of the selection criteria, then press .

The message “Filtering...” appears briefly. All transactions that satisfy the selection criteria are then displayed in Index mode. Since the total balance shown at the top of screen is for Filtered transactions only, it is labeled FILTERED.





-  Note that in the CLEARED field, the pop-up menu contains items which do not appear when entering **Money Tracking** transactions. These extra items represents a combination of possible values for the field, allowing the user to specify more than one value for the selection criteria.

If a Category used for the Filter selection criteria occurs as one of the Split components of a transaction amount, the entire transaction amount will be added to the Filtered Balance, not just the split amount corresponding to the selected Category.



A date range may be used to make the Filter selection more specific. The FROM date is the date at which the Filter selection should start. The TO date is the latest date at which the Filter should end. Either field may be left blank to allow the Filter to have no starting or ending date limit.

-  Note that the more detailed the selection criteria (ie. the more fields you specify for the Filter), the more selectively the Filter will operate and the quicker you will find the information you are looking for. However, if you specify more than one selection criterion, any filtered items will have to meet all of the selection criteria, not just any of them.

- To display a particular transaction in View mode, select the transaction and press .

The selected transaction appears in View mode. The word FILTERED appears in the top-right of the screen to remind you that a filter is in effect, and that some transactions may

not be displayed (ie. those not meeting the selection criteria).

5. Use  and  to display those fields which cannot be displayed at one time.

Use  and  to display full details of previous and subsequent transactions that also meet the Filter's selection criteria.

### Canceling an active Filter

While a filter is in effect, the word FILTERED appears at the top of the screen and a ✓ appears in the **Money Tracking** menu next to SET FILTER STATUS. When you have accessed the information you were looking for, you may want to turn off or cancel an active Filter.

To cancel a Filter:

1. Press  twice to display the PREFERENCES menu.

The **Money Tracking** menu appears. A ✓ is displayed next to the SET FILTER STATUS command.

2. Select SET FILTER STATUS and press .

The Filter is canceled, and the Account List is displayed. If you display the PREFERENCES menu again, the ✓ will no longer appear next to the SET FILTER STATUS.

## About Categories

The CATEGORY field provides a useful way of associating various transactions in different accounts according to a common purpose, customer/client or some other type. While the **Money Tracking** application provides a comprehensive list of default categories ready for your use, you can also define your own categories as required. Careful defining and assigning of categories allows you to make the best use one of **Money Tracking's** most powerful facilities - the Filter function (see p.143) - to selectively access various transactions after they have been entered.

The Organizer provides a comprehensive built-in list of 41 pre-defined categories. In addition, you can add, edit and delete Category names as required.

### Using the pre-defined Categories

The pre-defined categories are built-in to the **Money Tracking** application, and are installed automatically upon initialization. However, you may wish to delete all the built-in and user-defined Categories and then add them again later. You can do this by issuing a simple command from the menu.

1. Press , select CATEGORIES and press .
2. Select APPEND PRESET CATEGORIES and press .

The message “Working...” appears for more than 10 seconds.

3. To see the newly-added Categories, press **MENU**, select CATEGORIES then press **ENTER**.
4. Select NEW/EDIT CATEGORIES and press **ENTER**.

The NEW/EDIT CATEGORIES window appears.

5. Press **□** to display the Category list. Use **NEXT** and the arrow keys to scroll down the list.
-  You can also use **2nd** **NEXT** to jump directly to the bottom of the Category list (where the transfer account Categories are located) and **2nd** **PREV** to jump to the top of the list.

## Adding your own Categories

To define a new category in the **Money Tracking** application:

1. In Index mode, press **MENU**, select CATEGORIES then press **ENTER**.

The CATEGORIES submenu appears.

2. Select NEW/EDIT CATEGORY and press **ENTER**.

The CATEGORIES window appears.



3. Press **NEW** and enter the name of the new category you wish to create, then press **ENTER** (or **CANCEL** to discard the new category).

The CATEGORIES window reappears, with the new category name displayed.

4. Press **CANCEL** to close the CATEGORIES window.

 You can also define a new category while editing a new or existing transaction entry. Simply type the new category name in the CATEGORY field (instead of selecting an existing name from the pop-up list). The new category you enter will be automatically added to the existing category list.

## Editing Category names

You can edit any existing category name as necessary. When you edit a category name, a transaction using that category is automatically updated to use the edited category name instead.

1. Press **MENU**, select NEW/EDIT CATEGORIES then press **ENTER**.

The CATEGORIES window appears.

2. Press , select the desired category from the pop-up menu list, then press .

The selected category is displayed in the CATEGORIES box.

3. Press .

The EDIT CATEGORY window appears, with the selected category name.

4. Make any necessary changes to the name, then press .

The NEW/EDIT CATEGORIES window reappears, containing the edited category name.

5. Press  to close the CATEGORIES window.

## Using Categories

The most effective use of categories is through the Filter function. In this way, transactions in different accounts which may appear to be unrelated may be grouped into the same category. For example, this may be useful for tracking transactions in different accounts involving different payees, but which were all incurred within a specific project. The project name could be set up and used as the category for all project-related transactions, so that the Filter function could later be used to select only those transactions. This is also a valuable tool when transferring transactions between your Money Management software (Quicken®, MS-Money®) and the OZ-5500.

## The SPLIT function

There may be times when you wish to enter a single transaction that actually comprises several different components. For example, you may spend \$100 in a department store. However, of that amount, \$40 may have been spent on clothes, \$25 spent on purchasing a gift and \$35 for general household items. You may wish to categorize the clothing and gift purchases separately.

### Creating a SPLIT transaction

1. Press  to create a new Money Tracking transaction. Enter the information as for a regular transaction.
2. Enter in the AMOUNT field the total amount of the transaction. Using the previous example this would be \$100.00.
3. In the CATEGORY field, press  and select {SPLIT} from the category list.

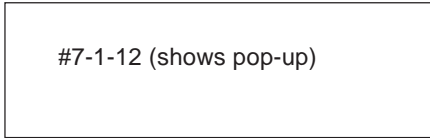

#7-1-12 (shows pop-up)

4. Press .

The SPLIT window appears.

#7-1-13

The UNASSIGNED field shows the value within the total amount that has not yet been assigned to a split transaction.

The value of UNASSIGNED is 100.00, ie. the total amount appearing in the AMOUNT field.

5. In the first AMOUNT field, enter the amount of the first category to be entered. In this example, we'll enter the clothing first, so enter *40.00*, then press **NEXT**.

The value in UNASSIGNED changes to 60.00.

#7-1-14

6. In the first CATEGORY field, press **⇩** and select the category you use to track clothing purchases then press **ENTER**.

#7-1-15

- ☞ If the category you want to use has not yet been defined, you can create a new category simply by typing in the new category name in the CATEGORY field. This applies whenever the CATEGORY field is used.

7. Press **NEXT**. Enter the second category AMOUNT field In this example, enter *35.00* and press **NEXT**.

#7-1-16

The value in UNASSIGNED changes to 25.00.

8. In the second CATEGORY field, press **⇩** and select the category you use to track gifts. Press **ENTER** then **NEXT**.
9. In the third AMOUNT field, enter *25.00* and press **NEXT**.

The value in UNASSIGNED changes to 0.00.

10. In the third CATEGORY field, press **⇩** and select the category you use to record household expenses then press **ENTER** to close the list.

#7-1-17

11. Press **ENTER** to store the SPLIT transaction details and proceed with completing the rest of the transaction.

#7-1-18



- If the total amount given in the AMOUNT field of the **Money Tracking** transaction is not equal to the sum of the split amounts (ie. some split amount details have not been entered), the outstanding amount will be added automatically to the next available Split field, but with no category given. A warning message will advise you of this, and suggest that you check the Split information.
  - The Split function supports up to 10 amount/ categories. If there is an amount outstanding when less than ten split entries have already been made, the outstanding amount is added to the last entry automatically and a warning message is displayed advising the user to check the entry.
  - If there is an unassigned amount outstanding when ten entries have already been made, a warning message appears and the user is forced to resolve the discrepancy before the transaction can be stored.
- The UNASSIGNED field is displayed only during Edit mode. If you view an existing transaction containing a SPLIT field in View mode and access the Split information, no value for UNASSIGNED will appear.

## Automatic transfers

One of Money Tracking's most powerful and useful features is the Transfer facility. Sometimes, you may wish to transfer funds from one of your accounts to another. This single transaction actually involves one account being debited, and another account being credited by the same amount.

For example, if you pay your monthly credit card bill by check, this involves a debit from your checking account for the payment amount, and a corresponding credit to your credit card account. Using the transfer facility, the **Money Tracking** application can automatically credit your credit card account when you create the transaction in the checking account. This not only saves you extra work, but also ensures that the amount of the two corresponding transactions are identical, thus eliminating troublesome discrepancies which could later interfere with successful account balancing and reconciliation.

Account transfers always consist of a source account transaction, which is created by the user, and a matching transaction for a destination account.

Whenever a new account is created in the **Money Tracking** application, a special category is automatically created specifically for account transfers. Such categories are indicated by square brackets, ie. if you define an account called CHECKING, a category [CHECKING] is created automatically.

A transaction can be created automatically when the destination account is given in the CATEGORY field (eg. [CHECKING]). The user is asked whether a corresponding destination transaction should be created automatically. If the source transaction is a debit, the destination transaction created automatically will be a credit, and vice versa. When the destination transaction is created, the text "TRANSFERRED DATA" appears in the MEMO field.

The following example assumes that accounts called CHECKING and MASTERCARD have been created. If you enter the following transaction for a \$250 check submitted as a credit card repayment, the **Money Tracking** application will automatically create a corresponding \$250 deposit into your credit card account:

1. Press **MONEY TRACKING** repeatedly until you see the CHECKING account Index view.

 If you pass the CHECKING account by mistake, press **2nd** **MONEY TRACKING** to move through the accounts in the reverse order.

2. Press **NEW** to start a new Money Tracking transaction for that account.

The new transaction window appears, with CHECKING as the ACCOUNT NAME.

3. Select PAYMENT in the TYPE field, and all of the other fields as usual, except the CATEGORY field.
4. Enter 250 for the AMOUNT and move to the next field.
5. In the CATEGORY field, press **□** and select the [MasterCard] category from the list (note the square brackets), then press **ENTER** to close the list.

#7-1-19

 You cannot transfer data from and to the same account. For example, when you are entering a CHECKING account transaction, you cannot specify [CHECKING] as the category. If you do so, a warning message will appear, asking you to check the Category field.

6. After ensuring that all other fields are entered as necessary, press **ENTER** to store the transaction.

A message then appears informing you that a corresponding destination transaction can be created in the transfer account.



7. Press **Y** to confirm the transaction should be created (or **N** to skip).

The messages “Working...” followed by “Stored!” appear briefly. The transaction is then displayed in View mode.

#7-1-20

- ☞ Note that the ACCOUNT NAME, TYPE, DATE, PAYEE, AMOUNT, CATEGORY and MEMO fields are assigned for the destination transaction. In addition, if the source transaction was marked as a Secret transaction, the destination transaction will be also.

Remember that if you subsequently edit a source or destination transaction, the change will not be reflected automatically in the parallel transaction. To maintain the correspondence between the two transactions, you should manually edit the other transaction also.

8. To check the automatically created transfer transaction, press **ENTER** to return to the Index view for the source account.
9. Press **MONEY TRACKING** repeatedly until the Index view for the transfer account (which in this case was the CREDIT CARD account) appears.

- ☞ If you pass the desired transfer account by mistake, press **2nd** **MONEY TRACKING** to move through the

accounts in the reverse order.

The latest transaction will be the transfer transaction, showing the same PAYEE and the same amount, \$250. However, while the original transaction was a payment, the transfer transaction’s amount is a DEPOSIT. Also, the MEMO field will contain the text “TRANSFERRED DATA”.

- ☞ Although one of the transfer transactions is created automatically, the two transactions are treated as separate transactions and are not linked to each other. This means one transaction can be deleted without the other being affected.

## Making a transfer for a SPLIT transaction

You can make a transfer for an amount within a Split field. Simply specify the destination transfer account as the category for the particular split entry amount you want to be transferred. The transfer itself works just as it would for a non-Split field.

#7-1-21

When you set or unset Secret status for a source or destination transaction, its corresponding destination or source transaction has the same change applied automatically.

## Account balancing & reconciliation

The automatic account balancing and reconciliation functions are one of the **Money Tracking** application's most powerful and useful facilities. It works by comparing the difference between an account's (usually a checking account) starting and ending balances with the sum of the transactions (eg. checks and deposits) marked as cleared as recorded in the Organizer. If the amounts are the same, then all transactions have been accounted for and thus the account is reconciled. If there is a discrepancy, however, the user is alerted and must then specify what action should be taken to resolve the discrepancy.

There are two main advantages to using **Money Tracking** to perform account balancing and reconciliation:

1. By identifying any discrepancies between the bank statement details and the cleared transactions stored in the Organizer, the **Money Tracking** application can ensure that the Organizer's record of account transactions is complete, up-to-date and consistent.
2. Once the account has balanced correctly, reconciled transactions can be removed from the Organizer while maintaining the correct account balance, thus freeing valuable memory and ensuring that only up-to-date transactions are stored in memory (thus preventing the excessive build-up of unnecessary information).

☞ Since transactions cannot be retrieved once they are removed or deleted, you may want to store or back up the transactions before removing them by transferring them to a PC or even printing out the details.

### Performing account balancing

Account balancing and reconciliation can be carried out once you have received your bank statement detailing the various checks and other transactions in that account.

Account balancing is performed in two stages:

- A. Reconciling the account: Comparing the transactions on your Account Statement with the transactions in the OZ-5500 and marking them as CLEARED
- B. Balancing the Account: Entering the ENDing BALance from your Statement and having the OZ-5500 calculate its ending balance and having them match.

### Marking transactions as CLEARED

1. From the SETUP ACCOUNT list, select the desired account, press **[MENU]** and select ACCOUNT BALANCING then press **[ENTER]**.

#7-1-22

 You can also use the keyboard shortcut **[2nd] [Y]** to initiate ACCOUNT BALANCING.

The STATEMENT BALANCES window appears. The START BAL field is the OPENING BAL of the account (as shown in the ACCOUNT LIST) plus the sum of all transactions marked as RECONCILED. Note that this field is calculated automatically, and cannot be modified by the user.

2. In the END BAL field, enter the ending or closing balance as shown on the bank statement you have received, then press **[ENTER]**.

The account index view appears, showing the index view summary of all transaction (except those marked as RECONCILED, which are hidden). However, instead of the account balance being shown at the top right of the display, the text “[SMBL] to clear” appears.

 Use **[']** and **[\$]** to view those details which cannot fit on the screen at one time.

3. Check each transaction in turn. If the details of any transaction are incorrect, select the transaction and press **[EDIT]** to update the details. If any transaction appears in the statement but not in the account list display, create it by pressing **[NEW]** and adding the necessary details.

When you finish checking each transaction, mark it as CLEARED by selecting the transaction and pressing **[SMBL]**.

The status of the transaction changes to “C” on the display.



 Press **[SMBL]** again to cancel the status of a transaction already marked as CLEARED.

## Postponing the ACCOUNT BALANCING procedure

Once the ACCOUNT BALANCING command has been selected, the Organizer will remain in account balancing mode until either the account is balanced and the user selects FINISH BALANCING or postpones account balancing.

For example, if you begin to balance your account but then realize you don't have all the information you need to balance the account or you are interrupted and need to postpone the process until later, you may do so by selecting POSTPONE BALANCING.

To postpone account balancing after the ACCOUNT BALANCING command has already been issued:

1. Press **[MENU]**.

The **Money Tracking** menu appears. Note that the

ACCOUNT BALANCING command is faded out, indicating it cannot be selected.

2. Select POSTPONE BALANCING and press **ENTER**.

 You can also use the keyboard shortcut **2nd** **Y** to initiate POSTPONE BALANCING.

 If you Postpone balancing after already marking some transactions as Cleared, their Cleared status will be preserved when you reinitiate account balancing. The Cleared transactions will still be marked as Cleared.

## Balancing the account and reconciling the transactions

When you are satisfied that all data in the statement has been checked and all appropriate transactions marked as Cleared:

1. Press **MENU**.

The **Money Tracking** menu appears.

2. Select FINISH BALANCING and press **ENTER**

 You can also use the keyboard shortcut **2nd** **R** to initiate FINISH BALANCING.

 The commands FINISH BALANCING and POSTPONE BALANCING cannot be selected from the menu unless ACCOUNT BALANCING has already been carried out.

The Organizer then calculates the sum of the transactions marked CLEARED, and compares this to the difference between the START BAL and END BAL (given in step 3 above).

If there is no difference, this means the account has been balanced successfully. A congratulations message is displayed. (If a difference was detected, see “Handling unbalanced accounts” below.)

#7-1-23

3. Press **ENTER** to acknowledge this message.

The display returns to the Index view for the account. All transactions which were marked as CLEARED (C) are now marked as RECONCILED (R), indicating that they have been reconciled. The account balancing process is now complete.

#7-1-24

## Handling unbalanced accounts

When the sum of the cleared transactions does not equal the difference between the START BAL and the END BAL amounts, this means that the account is out of balance and the account's transactions have not been correctly reconciled. The Organizer indicates this has occurred, but it is up to the user to locate and rectify the cause of the problem.

### If a difference was detected:

A warning message is displayed to informing the user of the problem, together with the amount of the discrepancy.

1. Press **ENTER** to proceed with checking the problem.
2. Select the desired option and press **ENTER**:

**POSTPONE** – returns to the account's index view. All transactions are displayed. The Balancing operation is terminated.

**RETURN TO BALANCING** – returns the user to the account Index view to recheck the **CLEARED** transactions.

**ADJUST BALANCE** - the Organizer asks for confirmation that an adjustment transaction should be created. The **PAYEE** of the account is given as **<ADJUSTMENT>**, and the amount necessary to balance the account is shown in the **AMOUNT** field.

3. Press **Y** to proceed with creating this special transaction to balance the account (or **N** to reselect an option from the list in step 2 above).



When the adjustment transaction is created, all other fields in the transaction are blank, except for: **DATE** = (today's date), **ACCOUNT** = (currently selected account), **TYPE** = (depends on whether the amount is credit or debit), **CLEARED** = "R".

A final message appears asking the user to confirm to creation of the adjustment transaction.

4. Press **Y** to proceed with creating this transaction to balance the account (or **N** to reselect an option from the list in step 2 above).

The adjustment transaction is created automatically. A message of congratulations appears, informing the user that the account is now balanced.

5. Press **ENTER** to acknowledge this message.

The display returns to the Index view for the account. All transactions which were marked as **CLEARED (C)** are now marked as **RECONCILED (R)**, indicating that they have been reconciled. The account balancing process is now complete.

## Removing transactions after account balancing

Since the Organizer contains limited memory capacity, it is important to delete unwanted or out-of-date data from the **Money Tracking** application just as for other applications. However, one important advantage to having RECONCILED transactions is that they are probably no longer required, since they have all be successfully accounted for. The **Money Tracking** applications offers a useful facility of removing RECONCILED and/or other transactions after adding their total value to the existing OPENING BALance to create a new OPENING BALance. This opening balance will be used the next time account balancing is performed.

☞ Since transactions cannot be retrieved once they are removed or deleted, you may want to store or back up the transactions before removing them by transferring them to a PC or even printing out the details.

To remove transactions:

1. Select REMOVE TRANSACTIONS from the **Money Tracking** application menu, then press **ENTER**.

The REMOVE TRANSACTIONS window appears.

2. In the ACCOUNT field, press **←** and select the account in which you want to remove transactions, or select ALL to remove transactions from all accounts. Press **NEXT**.

3. In the BEFORE field, enter the date before which you want to remove transactions. You can either enter the date directly from the keyboard or press **←** and use the arrow keys to select the date from the pop-up calendar. Press **NEXT**.
- ☞ Transaction on or after the date you specify in the BEFORE field will not be removed. For example, if you specify BEFORE 1/1/97, then transactions up to and including 12/31/96 will be removed.
4. In the CONDITION field, specify the types of transactions you wish to remove, according to their status. Press **ENTER**.

Note the default is REMOVE RECONCILED.

☞ Note that while the removal of transactions maintains the correct overall account balance, this is completely different from deleting transactions, which causes the balance to be reduced accordingly.

## When the Organizer is Locked

Like most other applications within the Organizer, the **Money Tracking** application allows you to define certain information as Secret, so that it will be subsequently hidden when the Organizer is Locked. However, locking the Organizer causes certain changes to the **Money Tracking** application's behavior. These changes are discussed below.

## Transaction view

When the Organizer is in its Unlocked state, any transactions that have been marked as Secret are marked with an asterisk in the top left corner of the display. When the Organizer is Locked, Secret transactions are hidden from view and therefore cannot be accessed at all.

## Account list

When the Organizer is Locked, all account balances and the total balance shown on the SET UP ACCOUNT list are hidden. Instead, the balance is shown as `##,###,###.##` appears. The account balances cannot be viewed until the Organizer is Unlocked.

Also, certain operations on particular accounts are not allowed (such as editing or deleting). A warning message is displayed if they are attempted while the Organizer is locked. However, new accounts can be set up (by pressing **NEW**) and the full details entered.

## Transaction Index view

This view shows summary details of individual transactions, after selecting a particular account from the account list. When the Organizer is Locked, any transactions which were previously marked as Secret are hidden from view. Since some transactions may be hidden, the total balance usually given at the top of the list cannot be given, and instead shows `##,###,###.##` when the Organizer is locked.

This reminds the user that there may be hidden transactions whose balances are not available.

☞ When the Organizer is Locked, all balances are given as `##,###,###.##`, even if there are no transactions for that account that are actually marked as Secret and therefore hidden.

The maximum amount that can be displayed in the balance field is 99,999,999.99. However, if the total balance exceeds this amount, an overflow occurs and the balance appears as `**,**,***.**` to indicate the total amount cannot be displayed.

## Deleting Money Tracking entries

Deleting transactions allows the user to erase unwanted transactions. Use REMOVE TRANSACTIONS to get rid of old transactions that were valid but are no longer required (usually after Account Balancing). Use DATA DELETION for a transaction that is not valid (eg. duplicate transactions, voided checks and transactions entered incorrectly or by mistake). When a transaction is deleted, its amount is deducted from the account balance, as if it never existed. But when a transaction is Removed, the account's current balance does not change.

### Deleting single entries

1. In Index mode for the account, select the transaction to be deleted.

2. Press **MENU**, select DATA DELETION and press **ENTER**.

The Data Deletion submenu opens.

3. Highlight SELECTED ENTRY and press **ENTER**.

A confirmation message appears, asking if you are certain you want to delete the selected entry.

4. Press **Y** to delete (or **N** to cancel the deletion).

If **Y** was pressed, the entry is deleted. The message "Deleted!" appears briefly. The display is updated by removing the deleted entry.

 You can also delete individual transactions easily by selecting the transaction in Index mode or displaying it in View mode, then pressing **DEL**.

### Deleting all transactions within an account

1. From the Index view of the corresponding account, press **MENU**, select DATA DELETION and press **ENTER**.

The Data Deletion submenu opens.

2. Select ALL IN SELECTED ACCOUNT and press **ENTER**.

A deletion confirmation message is displayed.

3. Press **Y** to delete all the transactions in the account (or **N** to cancel without deleting).

The message "Deleted!" appears briefly. The display is updated to show the appropriate entries have been deleted.

### Deleting Filtered transactions

When the Filter is turned on, only certain transactions (those meeting the current Filter selection criteria) are displayed. To delete only these filtered transactions:

1. Press **MENU**, select DATA DELETION and press **ENTER**.

The DATA DELETION submenu appears.

2. Select ALL FILTERED ENTRIES then press **ENTER**.

A deletion confirmation message appears. Press **Y** to delete (or **N** to cancel). The Filtered transactions are deleted from the Organizer. The message "Deleted!" appears briefly. The Index view for the account is displayed, showing that the Filtered transactions have been deleted.

 This command is only available when the Filter is in effect. The Filter function is automatically canceled when Filtered transactions are deleted by the above procedure.

### Deleting all transactions

1. Press **MENU**, Select DATA DELETION and press **ENTER**.



The DATA DELETION submenu is displayed.

2. Select ALL TRANSACTIONS and press **ENTER**.

A confirmation message appears to ask if you are certain you wish to delete all the transactions.

3. Press **Y** to confirm or **N** to cancel the operation.

If **Y** was pressed, the message "Deleted!" appears briefly and all transactions are deleted.

### Deleting all categories

You can delete all **Money Tracking** categories if they are not being used by transactions entries.

1. Press **MENU**, select DATA DELETION and press **ENTER**.

The DATA DELETION submenu appears.

2. Select ALL CATEGORIES and press **ENTER**.

A deletion confirmation message appears.

3. Press **Y** to proceed with deletion (or **N** to cancel).

All preset and user-defined categories are deleted.

 Note that Categories cannot be deleted if they are currently being used by transaction entries.

### Deleting all Money Tracking accounts

This command is used to delete all **Money Tracking** accounts and any transactions they contain. If you issue this command, you will lose all your **Money Tracking** information.

1. Press **MENU**, Select DATA DELETION and press **ENTER**.

The DATA DELETION submenu appears.

2. Select ALL MONEY TRACKING FILES and press **ENTER**.

A confirmation message appears asking if you are certain you want to delete all **Money Tracking** files (accounts).

3. Press **Y** to delete or **N** to cancel the operation.

If **Y** was pressed, all **Money Tracking** accounts, transactions and Categories are deleted.

## Money Tracking application menu



Lists existing accounts and allows accounts to be added or updated.

Allows Categories to be added, edited, selected and deleted, and preset categories to be reloaded.

Commences account balancing by allowing transactions to be marked as Cleared.

Determines whether account is in balance and if so, marks cleared transactions as Reconciled.

Cancels account balancing until a later time but preserves changes already made.

Deletes transactions marked as Reconciled after account balancing but while maintaining total balance.

Selects the specific entries for deletion (see p.157).

In addition to its basic functions, the Organizer also provides an wide range of utilities and features to give you even greater control over your information. This chapter introduces and describes these features, which include text cutting, copying, and pasting, filtering of selected entries, and many more. Most people will not need to use all of these features on a daily basis. You can pick and choose from among them to find the features that best suit your current task and your own way of working.

In general, all of the Organizer's applications share the features explained in this chapter, while exceptions are clearly noted.

## Copying or Moving Blocks of Text

The Organizer lets you cut, copy, or paste blocks of text. The first step in cutting, copying, and pasting is to select the block of text you want to work with.

Text that has been cut or copied is stored on the unit's internal clipboard. Only one block of text can be stored in the clipboard at a time, and it will remain there until a new block of text is cut or copied. There is no limit to the number of times you can paste the same text from the clipboard.

You can copy or move blocks of text in virtually any application.

1. Select an entry in its application's Index mode then display it in Edit mode.
2. Make sure the cursor is placed at the start of the text you want to select.
3. Hold  down while moving the cursor across the desired text to select it.
4. Press **2nd** **CUT** to move the selected text to a new location (ie. remove it from its original location).

Press **2nd** **COPY** if you want to make a copy of the text (and leave the original text unchanged).

The selected text is stored in the clipboard.

5. Press **ENTER** if you want to store the original entry with any changes you have made (including moving or copying the selected text), or press **CANCEL** to discard all the changes you have made to the original entry. Note that even if you press **CANCEL**, the text you selected will remain in the clipboard for you to use.
6. Move the cursor to the location where you want to place the text, either within the same entry or in another entry.
7. Press **2nd PASTE**.

The text you selected is now pasted into the new location.

8. Press **ENTER** to store the amended entry with the pasted text.
-  • Pasted text is inserted into existing text regardless of whether the insertion or overwriting mode is selected. However, by highlighting some text before pressing **2nd PASTE**, it can be replaced with the pasted text. Thus you can easily replace one block of text with another by highlighting it before pasting.
- Pasted calculations can be performed in the **Calc** application. However, only numbers and operators can be pasted in the **Calc** application. Any text that is pasted will be ignored.

## Copying or Moving Entries

The CUT/COPY/PASTE operations provide a quick, convenient way for you to copy or move an entire entry to another location. Entries do not have to be in the same file or even in the same application, since CUT/COPY/PASTE work across virtually all applications.

1. Select an entry that you want to copy or move in Index mode.
  2. Press **2nd CUT** if you want to move the entry. A message will ask if you are sure you want to delete the entry from its present location. Press **Y** to proceed (or **N** to cancel the operation).
- Press **2nd COPY** if you want to make a copy of the entry.
3. Press **NEW** in the application you want to move or copy the entry to. You can also append the copied/cut entry to an existing entry. Open an entry in Edit mode, and move the cursor to the position where you want to append the entry.
  4. Press **2nd PASTE**.
  5. Make any necessary changes to the moved/copied entry. Press **ENTER** to store the entry when you have finished.

The entry you selected is now moved or copied to the new location.



- In the Outline application's Edit mode, to copy or move an entire outline, you must begin by selecting its title.
- If you select a topic in the outline, only the selected topic and its subtopics will be copied.

## The Time Stamp and Date Stamp Functions

The time and date stamp functions can be used to insert or stamp the current time and date anywhere in an entry, including time/date fields in applications such as **Schedule** and **To Do**. This is very convenient for keeping track of such things as telephone conversations or when tracking expenses, as it saves you the trouble of finding out the time/date and entering them manually.

1. When working in an application's Edit mode, place the cursor at the location where you want to insert the time or date.
2. Press **2nd** **T** to insert the time, or **2nd** **D** to insert the date, or both. When you store the entry, the time and date stamps will be stored with it.



Time and date stamps inserted into an entry are included in any printout of the entry.

# The Word Key

You may sometimes find yourself having to enter the same word over and over again in letters or lists, for example or you may have several memos or letters you have to write that are all on the same topic. Using the **WORD** key, you can easily insert words, names, numbers, and phrases (up to 32 characters long) in an entry with just the press of a key.

## Defining your words or phrases

There are no default words assigned to the Organizer's **WORD** key function, so you must first define your own words or phrases.

1. Press **MENU** three times to open the TOOLS menu. Select SET UP WORD KEY and press **ENTER**.

A list appears which is used to define your own words or phrases. The list will be empty when you use the function for the first time.

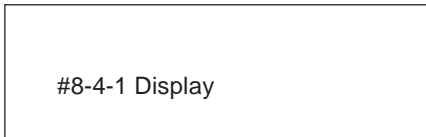

2. Press **NEW**.

A NEW WORD window opens.

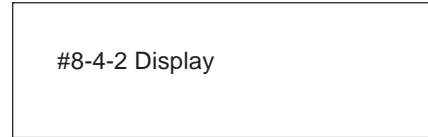

3. Enter any word, name, number, or phrase (up to 32 characters) that you want to be able to recall using the Word key.
4. Press **ENTER**.
5. Repeat steps 2 to 4 above to define any other words you might like to insert into a document either now or in the future using **WORD**.

Words are stored alphabetically.

6. Press **CANCEL** when you are finished.

## Inserting a word or phrase

1. When entering or editing an entry in Edit mode, place the cursor where you want a word to be entered.
2. Press **WORD**.

The word list window opens, showing an alphabetical list of all the words that have been previously defined.

3. Select the particular word you want to insert. Press **PREV** or **NEXT** to display more words if necessary.
4. Press **ENTER**.

The word is inserted at the cursor position.

## Editing a word or phrase

You can edit a word or phrase using a similar procedure to adding a word or phrase (see above), but instead of pressing **NEW** to open the NEW WORD window, select the word in the list you want to edit and press **EDIT**. An EDIT WORD window then opens. Make any desired changes and press **ENTER**. After the change has been stored, press **CANCEL** to close the window.

## Deleting a word or phrase

If you find that you no longer need a particular word or phrase, it is easy to delete it. Select SET UP WORD KEY from the TOOLS menu, highlight the word or phrase you want to delete, and press **DEL**. A confirmation message appears asking if you are sure you want to delete the selected word or phrase. Press **Y** (or **N** to cancel the deletion). Then press **CANCEL** to close the window.

## The Filter Function

The Organizer's Filter function allows you to selectively access only those entries containing particular information in an application. The Filter function does this by hiding all entries that do not match specified criteria from all the display modes of an application until the Filter is turned off.

You can edit the displayed entries normally while the Filter is turned on.

The Filter function is available only in the **Schedule**, **Money Tracking**, **Memo**, **Tel**, and **User File** applications.

## Turning the Filter on

1. Open the application containing the entries you want to work with. Go to Index mode.
2. Press **MENU** twice to display the PREFERENCES menu, select SET FILTER STATUS, then press **ENTER**.

In the **Tel** and **User File** application, a window opens for the user to enter the appropriate selection criteria, as shown below:



In the **Schedule**, **Money Tracking** and **Memo** applications, a window opens for the user to enter a date range and/or description as the selection criteria, as shown below:

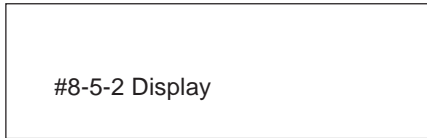

4. Press **[2nd]** **[−]** to check the SECRET ONLY box and extract secret entries only (see p.186). (This box will not be displayed if the Organizer is locked.) You can extract all the secret entries in the application by skipping step 5 below.

(Press **[2nd]** **[−]** again to deselect the feature.)

5. Enter the information you want to use as the filter's selection criteria.

In the **User File** or **Tel** application, enter any keywords for the fields defined for that user file. The more fields you enter keywords for, the more selective the filtering process will be.

In the **Schedule**, **Money Tracking** and **Memo** applications, you may specify a range of dates as well as a keyword. To do so, enter the FROM and TO dates by either typing the dates in the respective fields or selecting the dates using **[−]** and the arrow keys. Any keyword(s) you wish to specify must appear in the DESCRIPTION field of the

**Schedule**, **Money Tracking** and **Memo** entries.

6. Press **[ENTER]**.

The application returns to Index mode, but now only those entries that meet the Filter's selection criteria are displayed.

Within the PREFERENCES menu, SET FILTER STATUS is now displayed with a ✓ to indicate that the Filter function is turned on.

If no matching entries are found, a message indicates this.

- ☞ If a new entry is made or an entry is transferred from another device while the Filter function is on, the entry will be displayed even though it may not meet the criteria. If you want to remove these new entries, first turn the Filter function off then repeat the above procedure.

## Turning the Filter off

To turn off the Filter function, deselect SET FILTER STATUS in the PREFERENCES menu.

## Deleting filtered entries

The Filter function also makes it possible to delete a group of entries related to one or several topics. This can be extremely useful, for example, if you complete a project that has several entries relating to it, saving you time by deleting them as a group instead of individually.



In the **Schedule, Money Tracking, Memo, Tel, or User File** applications:

1. Turn on the Filter using keywords to collect the entries you want to delete.
2. Press **MENU** to display the application menu, select DATA DELETION then press **ENTER**.

A submenu appears.

3. Select ALL FILTERED ENTRIES then press **ENTER**.

A message appears asking you to confirm you want to delete all filtered entries from the application.

4. Press **Y** (or **N** to cancel the procedure).

All the filtered entries are deleted and the Filter function is turned off.

## Special Characters

The Organizer has a list of 159 symbols and accented characters, such as “&”, “?”, and “/”. These symbols and accented characters can be easily accessed and inserted into an entry. Selecting any of these special characters inserts it at the cursor’s current location.

1. When entering data or editing an entry in any application in Edit mode, position the cursor where you want to insert a symbol or special character.
2. Press **SMBL** on the keyboard.

The Symbol window appears.

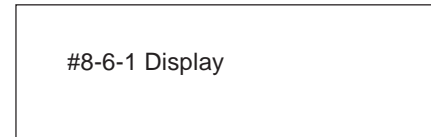

3. Press **PREV** or **NEXT** until you see the character you want to enter, then use **◀** **~** **§** **⋄** to select it.
4. Press **ENTER** to use the selected symbol.

The symbol window closes and the selected character is entered at the current cursor position.

5. If the symbol you just selected is an accent mark (˘, ^, ˙, ˚, or \_), it will flash on the display. Type the letter for which you want that accent mark to be used.



- When you next open the Symbol menu, the character you selected will be selected again as the default.
- When printing an entry containing symbols, certain symbols and characters may not be printed if they are not supported by your printer. Consult your printer manual for detailed information on character support.
- You can use the following keyboard shortcuts:

Accent	Keyboard shortcut (followed by the desired letter)
~	2nd L
`	2nd J
´	2nd K
¨	2nd B
^	2nd N

## CHAPTER 9

# Using the Optional Peripherals

Your Organizer is a powerful pocket-size computer with built-in functions that make it possible to accomplish a broad range of tasks, including printing. It has the flexibility to connect to other Organizers and transfer data to desktop computers using data transfer facilities, which are accessed through the PERIPHERALS menu. This chapter provides descriptions and examples to get you up and running quickly with these powerful features.

## The Peripherals Menu

#9-1-1 Display

Sets up data exchange with PCs (see p.180).

Prints entries in an application (see p.170).

Transfers data with other OZ-5500 Organizers (see p.174).

Selects the printer type (see p.170).

Selects a "generic" printer type/character set and the paper type (see p.171).

Configures data transfer to/from other OZ-5500 Organizers via infrared port or cable (see p.174).

## Printing from the Organizer

The Organizer offers a wide range of printing options, ranging from the current contents of the display to individual entries to all the entries within an application. The actual printing options available depend on which particular application you are using.

Entries and information can be printed on any standard parallel PC printer connected to the Organizer via the optional CE-IR1 wireless interface. The Organizer has built-in printer drivers (a printer driver is a special program that tells a particular type of printer how to format and print data correctly) for the following printers:

Canon BJ-10e Series

IBM Proprinter Series

Epson FX-80, FX-850 and LQ-510

Hewlett Packard LaserJet II and III Series

The Organizer also works with printers that can emulate any of the above printers (consult your

printer's manual regarding the emulation modes it supports). For information about other specific models supported by the Organizer, consult your local SHARP dealer.

The following restriction also applies for the Proprinter Series:

The Organizer supports the Proprinter X24E only. Printers that emulate other Proprinter models may not function properly.

To print from the Organizer to a printer, the optional SHARP CE-IR1 wireless interface is required, as well as a standard computer printer cable. See the CE-IR1 operation manual regarding use with a printer.

Hardware compatibility between the printer and the CE-IR1 may affect printing capability.

### Setting printer emulation

1. Press **MENU** four times to open the PERIPHERALS menu.

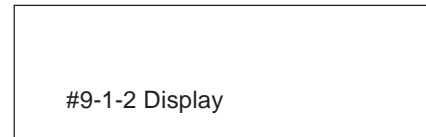

2. Select SET PRINTER EMULATION and press **ENTER**.

The printer emulation menu appears.

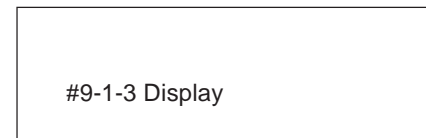

3. Select your printer type or one that your printer emulates (refer to your printer's manual regarding the emulation modes it supports).

 If your printer does not support any of the printer models listed, select [MORE EMULATIONS] and OTHER (US CHARACTERS) to print U.S. character codes or OTHER (INTERNATIONAL) to print other character code sets. The OTHER settings make use of the Organizer's built-in universal printer driver which may work for your printer. In addition, because of differences in the way data sent by the Organizer is converted to characters on the printer, information in the final printed copy may not appear exactly as it does in the Organizer.

To print secret entries, the Organizer must first be unlocked (see p.187). If you try to print a group of entries or all entries when the Organizer is locked, only the non-secret entries will be printed.

Entries are printed in the same format as for their Edit mode. For example, a collapsed **Outline** entry would be printed without its hidden subtopics, etc.

## Printing the current display

Virtually any display on the Organizer can be printed as it appears, with the exception of the confirmation prompt (Yes/No) displays, and other information messages.

1. Open the display that you want to print.
  2. Press **[2nd] [P]**.
-  Press **[ON]** at any time to cancel printing.

## Printing a single entry

1. Select the entry that you want to print in Index mode or display it in View mode.
  2. Press **[2nd] [SEND]**.
-  • Press **[ON]** at any time to cancel printing.
- If you are in an application other than **Memo** or **Outline**, you may have to remove the paper manually after printing (ie. no automatic form feed is sent). However, if you are using Hewlett Packard LaserJet Series printer, the paper will feed automatically after printing.

 You can also print single entries using the PERIPHERALS menu. After selecting or displaying the entry, select PRINT from the menu, then SELECTED ENTRY (or SELECTED OUTLINE) from the submenu.

## Printing a specified group of To Do entries

In the **To Do** application, you can also print entries that match specific selection criteria that you decide.

### In the To Do application:

1. Press **MENU**, select VIEWS then press **ENTER**.
  2. Select TO BE DONE ITEMS, DONE ITEMS, MONTHLY GOALS, or BY CATEGORY for a category containing the entries you want to print then press **ENTER**.
  3. Press **MENU** four times to display the PERIPHERALS menu, select PRINT, then press **ENTER**.
  4. Select ALL IN CURRENT VIEW, then press **ENTER**.
-  Press **ON** at any time to cancel printing.

### Printing Schedule entries for specific periods

1. Press **CALENDAR** to start the application.
  2. Select the date containing the entries you want to print, or a date that is included in the weekly or monthly period of entries that you want to print.
  3. Press **MENU** four times to display the PERIPHERALS menu, select PRINT then press **ENTER**.
  4. Select ALL IN SELECTED DAY/WEEK/MONTH and press **ENTER**.
-  Press **ON** at any time to cancel printing.

### Printing all entries

All entries in an application (or in a selected file in the **Ann**, **Tel** and **User File** applications) can be printed.

To print all entries in an application:

1. Open the application containing the entries you want to print.

In the **Schedule**, **Tel** and **User File** applications, make sure that the Filter function is turned off (see p.166).

2. Press **MENU** four times to display the PERIPHERALS menu, select PRINT then press **ENTER**.
3. Select ALL [application name] ENTRIES and press **ENTER**.

To print all entries in a file in the **Ann**, **Tel** or **User File** application,

1. Open the application containing the file you want to print and select the file.
  2. Press **MENU** four times, select PRINT then press **ENTER**.
  3. For the **Ann** application:  
Select ALL ANN1 BY DATE or ALL ANN2 BY DAY then press **ENTER**.
- For the **Tel** or **User File** application:  
Select ALL [file name] ENTRIES then press **ENTER**.

 Press **ON** at any time to cancel printing.

## Transferring Data

There are several ways to transfer information – whether specific entries or entire files – between the Organizer and other information processing devices, including personal computers and other SHARP Organizers. In this way, you

can back up your information to guard against losing it, or copy information so that you or someone else can work with it on another device. A summary of transfer devices, transferable data, and tasks to which a transfer device is most suited is provided in the table below.

Transfer device	Transferable data and direction of transfer (→: sent from 5500, ←: received in 5500)	Peripherals required	Most suitable task
Another OZ-5500 Organizer, OZ-6500, ZR-5000 and OZ-9000 series Organizer (See p.174 and p.176)	Single entries, entire files/ applications → ←	None for infrared transfers; CE-315L for cable transfers	Exchanging data with other OZ-5500 Organizers, OZ-6500, ZR-5000 and OZ-9000 series Organizers
Personal computer (See p.180)	Single entries, entire files/ applications → ←	Software* + CE-IR2 or compatible Organizer link cables or CE-137T + RS-232C interface cable	Backup, archiving, printing and emulation of the Organizer on a computer.

\* Depending upon the SHARP or third-party software you are using, some features and capabilities may vary.

☞ The auto power off function (see p.50) is disabled in all transfer modes.

When transferring data from other models, only entries in a mode (application) supported on the OZ-5500 Organizer

can be sent. However, the Notebook application on some other models corresponds to the **Memo** application on the OZ-5500 Organizer.

## Transferring between OZ-5500 Organizers

Data can be transferred directly between two OZ-5500 Organizers via the infrared port. Single entries or all the entries in an application can be transferred in the **Schedule, To Do, Ann, Memo, Money Tracking** and **Outline** applications; and single entries or all the entries in a file can be transferred in the **Tel** and **User File** applications.

The transfer procedure differs according to whether single entries or complete files are to be transferred.

- ☞ Press **ON** at any time to interrupt and cancel a transfer.
- After a transfer, the display returns to the application being used before the transfer procedure was begun.
- Data received from another Organizer is automatically assigned to the Organizer's IN BOX so that it can be checked before being moved to the appropriate application (except **Money Tracking** data, which is stored directly in the **Money Tracking** files).
- In the **Tel** or **User File** applications, the contents of fields that have not been set up in the receiving file cannot be transferred. Also, if the type of a field is different in the two units, the information cannot be transferred.

- No peripheral devices are required to transfer data via the infrared port. However, infrared transfers are easily affected by ambient conditions which may interfere with this type of transfer. Connecting the two units directly using the optional CE-315L cable will ensure a more reliable transfer. See p.176.

### Initial set-up

There is no special hardware set-up involved in infrared transfers. And if you only want to transfer single entries using **GET** and **SEND**, there is no software set-up either: all you have to do initially is set up the units properly so they use the same path (step 4 below). For all other infrared transfers, follow the procedure below.

- Press **MENU** four times on both units to open the PERIPHERALS menu.
- Select SET UNIT TO UNIT PATH and press **ENTER**.

A submenu opens.

- Select VIA INFRARED PORT and press **ENTER**.
- Place the two Organizers so that their infrared ports are facing each other and are no more than 80 cm apart.

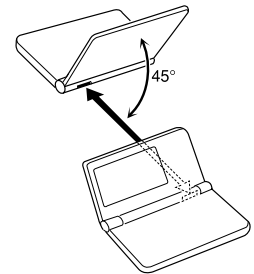





- During transfers, do not leave the cover more than three-quarters open or it will interrupt the infrared transfer.
- When transferring entire applications or files, or entries marked as secret, both Organizers must be unlocked (see p.187).
- Avoid direct sunlight.
- Keep the infrared port clean with a soft, dry cloth. Dust on the port could cause a transfer to fail.
- Although infrared transfer requires no special hardware, it is easily affected by ambient conditions and other factors such as external light, weak batteries, large transfer distance, transfer angle, etc. As a result, while infrared transfer is very convenient, there is a strong likelihood of data transfer failure, incomplete data transfer (missing data) or other errors occurring. It is therefore recommended that you check the received data thoroughly after making an infrared transfer.

### Transferring single entries

Single entries can be transferred in all applications.

1. Turn on both Organizers.
2. On the sending Organizer, select the entry you want to send.

3. Press **GET** on the receiving Organizer.
4. Press **SEND** on the sending Organizer.

The selected entry is transferred and appended to data in the appropriate application.



You can also transfer single entries using UNIT TO UNIT TRANSFER in the PERIPHERALS menu. In step 3, after opening the same application as on the sending Organizer, select GET DATA (APPEND) on the receiving Organizer. Then, in step 4, select SEND SELECTED ENTRY on the sending Organizer.

### Transferring all entries in an application

With the exception of the **Tel** and **User File** applications, all entries in any application can be transferred. In **Tel** and **User File**, all entries in particular files can be transferred.

1. Turn on both Organizers.
2. Open the same application on each Organizer.
3. On the receiving Organizer, press **MENU** four times to open the PERIPHERALS menu. Select UNIT TO UNIT TRANSFER and press **ENTER**.

A submenu opens.

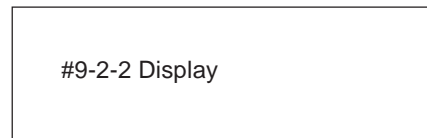

4. Select GET DATA (APPEND), and press **[ENTER]**.
5. On the sending Organizer, press **[MENU]** four times to open the PERIPHERALS menu. Select UNIT TO UNIT TRANSFER, and press **[ENTER]**.

A submenu opens.

6. Select SEND ALL IN THIS MODE, or SEND ALL IN THIS FILE in the **Tel** and **User File** applications.

All entries in the application or in the selected file are transferred.

☞ If the Filter function is turned on while using **Tel** or **User File**, select SEND ALL IN THIS MODE if you want only the filtered entries to be transferred.

For more reliable data transfer, you can connect two OZ-5500 Organizers using the optional CE-315L cable.

To set up the Organizers for data transfer via direct cable:

1. Turn off both Organizers.
2. Open the cover of the 15-pin cable jack on each Organizer.
3. Plug each end of the

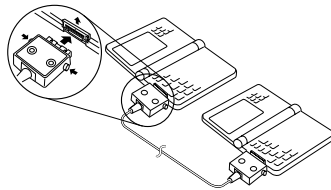

4. Turn on both Organizers.
5. Press **[MENU]** four times to display the PERIPHERALS menu.
6. Select SET UNIT TO UNIT PATH, then press **[ENTER]**.
7. Select VIA DIRECT CABLE then press **[ENTER]**.
  - ☞ • To conserve battery power, disconnect the cable as soon as a transfer is completed.
  - The **[GET]** and **[SEND]** keys are used only for infrared transfers, not for cable transfers. You must use the PERIPHERALS menu to transfer data via cable. Using the **[GET]** and **[SEND]** keys always initiates an infrared transfer, regardless of the selection for SET UNIT TO UNIT PATH or whether or not the cable is connected.
8. Transfer the data by following the same menu procedure as for the infrared transfer shown on p.175.

## Exchanging data with other Organizers

You can send information to and receive information from ZR-5000, OZ-6500 or 9000 series Organizers. However, the OZ-5500 cannot handle graphic data from other Organizer models. This type of transfer requires the optional CE-315L cable if you choose not to use the Infrared (IR) transfer.

### Initial set-up

1. Turn off both Organizers.

2. Open the cover of the 15-pin cable jack on each Organizer.
3. Plug each end of the cable into the cable jack on each Organizer.

 To conserve battery power, disconnect the cable as soon as a transfer is completed.

### Transferring data

1. Turn on both Organizers.
2. On the OZ-5500 Organizer, open the application in which you want to receive the data.

Only data corresponding to the application selected on the receiving Organizer will be transferred (regardless of which applications were selected on the sending unit).

In the **Tel** and **User File** applications, use the menu to switch to the correct destination file.

3. On the OZ-5500 Organizer:

Press **MENU** four times to open the PERIPHERALS menu.

Select UNIT TO UNIT TRANSFER and press **ENTER**.

A submenu opens.

Select GET DATA (APPEND) and press **ENTER**.

A message appears, informing you that the Organizer is attempting to make a connection and receive data from the sending unit.

4. On the sending unit:

Press **MENU** and select PERIPHERALS. Select UNIT TO UNIT TRANSFER, then select the preferred SEND option.

Repeat the steps above for all applications you want to import to your Organizer.

-  • **Memo** entries from Organizers other than the OZ-5500 will be transferred to the **Memo** application. All other matching applications will share the same name.
- There are some other restrictions. See p.181.
- Since the **Memo** application does not support formatting (tabs, indents, etc.) and styles (bold, italics, etc.), such information contained in entries received from other Organizer models will be ignored and lost.
- On the OZ-5500 Organizer, all applications that allow entry of text provide automatic word wrapping at the end of each line. However on 6500 and 9000-Series Organizers, this is not supported. As a result, any entries transferred between these models and the OZ-5500 may be displayed differently in the corresponding applications to the original versions.



Single entries or entire files can also be transferred between an OZ-5500 and an OZ-6500, ZR-5000 or OZ-9000-Series Organizer via the infrared link.

The procedures for this transfer are essentially the same as those given in the preceding sections on the OZ-5500 side. Refer to the operation manuals for the OZ-6500, ZR-5000 or OZ-9000-Series Organizers to set up these devices for data transfer.

## The IN BOX and IN BOX VIEWER

Any entries transferred to the Organizer are stored in their corresponding applications and also listed in a special location called the IN BOX. The IN BOX VIEWER allows you to see the application and title of each entry that has been received, and to decide whether you want to keep or delete each entry.

### Removing entries from the IN BOX

Since entries received via data transfer are stored in their corresponding applications and listed in the IN BOX, you should remove each item from the IN BOX if you decide you want to keep the transferred entry.

To use the IN BOX VIEWER:

1. Press **MENU** three times to display the TOOLS menu.
2. Select IN BOX VIEWER and press **ENTER**.

The IN BOX is displayed. Each item listed in the IN BOX corresponds to an entry that has already been stored in the application indicated by the displayed symbol.

3. Select any specific entry you want to remove, the press **ENTER**.
4. **To remove a specific entry:** select REMOVE THIS ENTRY and press **ENTER**.

**To remove all entries in the IN BOX:** select REMOVE ALL ENTRIES and press **ENTER**.

**To delete all entries from the IN BOX and from their corresponding applications:** select DELETE ALL ENTRIES and press **ENTER**, then confirm you want to permanently delete the entries from the Organizer.

## Assigning entries to the IN BOX from applications

You can easily send entries from a variety of applications to the IN BOX, so that you can transfer them to another Organizer in a single operation.

1. Select an entry to be transferred in Index mode or display it in View mode.
2. Press **2nd** **F**.

A copy of the entry is sent to the IN BOX (the original entry remains unaffected). The message "Filed!" appears briefly.

3. Repeat the above steps for any other entries in other applications to be sent to the IN BOX.
4. Press **MENU** three times to display the TOOLS menu. Select IN BOX VIEWER and press **ENTER**.

The IN BOX VIEWER displays the entries you filed in Index mode, with a symbol to identify the application each entry belongs to.

-  To transfer the entries in the IN BOX to another Organizer, press **MENU**, select SEND ALL ENTRIES VIA IR and press **ENTER**.

## Exchanging Information with a Personal Computer

Using SHARP's optional Organizer Link software and cable package or certain third-party software packages, you can exchange data with a personal computer. Certain software will allow you to exchange data with a personal computer via the Organizer's infrared port using the optional CE-IR2 wireless interface. This makes it possible, for example, to use the unit when outside your home or office, then later transfer the data you have entered on the Organizer to your desktop computer.

To setup the Organizer for use with the Organizer Link:

1. Make sure the unit is turned off.
2. For infrared transfer, set up the Organizer with the CE-IR2 wireless interface. (See the CE-IR2 manual for details.)

For a cable transfer, connect the Organizer Link cable to the Organizer's 15-pin cable jack. (See the Organizer Link manual for details.)

3. Press **[ON]**.
4. Press **[MENU]** four times to display the PERIPHERALS menu.
5. Select PC-LINK and press **[ENTER]**.

The SELECT PC-LINK PATH window appears.



You can also press **[2nd]** **[MENU]** to access the PC-LINK.

6. Select IR for infrared transfer or DIRECT CABLE for cable transfer and press **[ENTER]**.

#9-3-1 Display

Your Organizer is now ready to transfer data. Consult the Organizer Link manual regarding subsequent transfer procedures.

Press **[ON]** at any time to exit the PC Link mode.

If you leave the Organizer in PC Link mode, more power is consumed from the batteries than usual, and the auto power off function does not work.

To conserve battery power, always press **[ON]** to leave the PC Link mode as soon as you have finished transferring data.

## Points to remember when using peripherals

### When using Organizer Link software designed for an Organizer other than the OZ-5500:

- Data in applications that are not compatible with the Organizer Link cannot be transferred.
- You cannot transfer an entry from USER FILE 1 of the **User File** application if it has no data in its NAME field. It is also impossible to transfer any complete file that contains such an entry.

### When receiving data from an Organizer other than the OZ-5500s or when using an Organizer Link designed for another Organizer:

- If an **Outline** entry is more than 32 Kbytes in size, only the first 32 Kbytes of data will be received by an OZ-5500. Any subsequent text will not be transferred.
- Only data in applications/modes can be transferred.
- If you have used free fields in Telephone or User File on your other unit, you must set the number of fields in Telephone (or User File) on the OZ-5500 Organizer to be the same BEFORE transferring the information to the OZ-5500. Otherwise the data in the free fields will not be transferred to the OZ-5500. Also, if the type of a field (text or picture) is different in the two Organizers, it cannot be transferred.





Now that you have an understanding of all of the Organizer's functions and its operation, let's take a look at the various ways you can customize the Organizer to suit your personal preferences: the display can show selected user information at start-up; entries can be made secure through password protection and by marking them as secret; the **Calendar** display can be set to a default view that you prefer; and a bold font can be selected for the Organizer's display.

The Organizer offers two levels of security for its entries and operations. The first is the ASK PASSWORD option, which requires the correct password, previously set up by the user, to be given each time the Organizer is turned on. Thus, overall access to the Organizer's information and operations is restricted. The second is to define particular entries within various applications as secret, and then enable the LOCK ORGANIZER option within the TOOLS menu. This is independent of whether the ASK PASSWORD option is set, and provides another layer of security.

## The Start-Up Display

The Organizer can display your name, telephone number, and address every time it is turned on, set against one of three built-in graphic backgrounds. If you ever lose or misplace your Organizer, this could significantly increase the chances of being it returned to you.

### Selecting the start-up display

1. Press **MENU** twice to open the PREFERENCES menu, select SET START-UP DISPLAY, then press **ENTER**.

SET START-UP DISPLAY contains several fields. Current selections are shown in reverse.

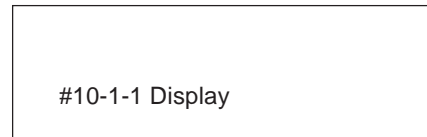

### START-UP

**ON:** Enables a user-specified display upon start-up. The owner's name, telephone number and address will then be displayed each time the Organizer is turned on. Also, if the ASK PASSWORD option is **ON** (see below), the Organizer will prompt the user for the correct password upon start-up.

OFF: Even if ASK PASSWORD (see below) is set to ON, no password will be required. The Organizer then starts in the application or display mode that was most recently used.

SETUP: Sets the Organizer to run through the set up procedure at start-up. This is the default display. This provides an overview of how to use the Organizer, and is very useful for new users as it goes directly to those screens allowing user customization. After this has been done once and the user reached the USER SETUP completed screen, START-UP is changed automatically from SETUP to OFF.

## BACKGROUND

You may choose one of the three built-in backgrounds to be displayed at start-up (when the Organizer is turned on).

## ASK PASSWORD

ON: After registering a password (see p.255), you will be prompted to enter that password upon start-up (if START-UP is also set to ON). The Organizer cannot be used if the password is not entered correctly. This is an important security feature for users whose Organizers contain sensitive information.

OFF: You will not be prompted to enter your password upon start-up.

2. Select the desired setting in each field.
3. Press **ENTER** to store the settings (or **CANCEL** to cancel any changes).

## Responses to the start-up display

If you have set START-UP and ASK PASSWORD to ON, and entered your personal information, a display similar to the one below will appear each time the Organizer is turned on.

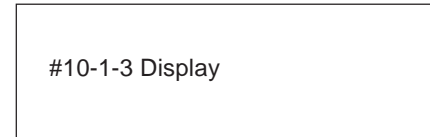

To use the Organizer:

1. Type in the password as used for the Secret function. You must enter the password exactly as you registered it, including upper- and lower-case letters.

2. Press **ENTER**.

The ENTER PASSWORD prompt disappears.

3. Press **ENTER** to go directly to the **Calendar** or press the key for any application you want to use.

- ☞ If no password has been registered, the prompt for the password will not be displayed even if ASK PASSWORD and START-UP have been set to ON.
- If you set ASK PASSWORD to ON with START-UP set to ON and you forget your registered password, you will have to reset it, which means erasing all the data stored in it (see p.197). This is one reason why it is a good idea to make periodic backups (transfers of your Organizer's stored information) to a PC or some other Organizer, so that the information can be reloaded in case the Organizer has to be reset.

## Setting the Owner's Information

The Owner's Information comprises your name, address and telephone number. You can choose whether to have this information displayed each time you turn the Organizer on, by setting the START-UP option to ON using the above procedure.

1. Press **MENU** twice to display the PREFERENCES menu.
2. Select SET OWNER INFORMATION and press **ENTER**.

The cursor starts in the NAME field.

3. Enter your name, then press **NEXT**.

The cursor moves to the telephone number field.

4. Enter your telephone number, then press **NEXT**.

The cursor moves to the address field.

5. Enter your full address.

💡 Press **↵** to move the start of the next line.

6. Press **ENTER** when done.

A message appears confirming the owner information has been set.

## Locking the Organizer

The Organizer's LOCK function allows you to keep selected information in your Organizer secure by locking it with a password that you specify. Entries that you have marked as secret cannot be accessed until the Organizer is unlocked using the password. Individual entries can be marked as secret, so that only someone who knows the password can access them by unlocking the Organizer. Note that this password is completely different from the one used for the ASK PASSWORD feature within the SET START-UP DISPLAY options (see p.183). Marking entries as secret has no effect until the Organizer is locked.

### Turning on the Lock

1. Press **MENU** twice to open the PREFERENCES menu.
2. Select SECRET from the menu, then press **ENTER**.

The SECRET submenu appears.

3. Select LOCK ORGANIZER, then press **ENTER**.

The LOCK ORGANIZER window appears prompting you to enter a password.

#10-2-1 Display

4. Enter any password up to seven characters long. Letters, numbers, and symbols can all be used. This text box is case-sensitive, which means that upper- and lower-case letters are treated differently. The password "SHARP", for example, is different from the passwords "Sharp" or "sharp".  
 Choose your password carefully. If you forget your password, there is no way to bypass the Secret function or enter a new password without losing all data marked as Secret. It is strongly recommended that you use a password that you will always be able to remember, but which other people will be unable to guess.
5. Press **ENTER** to store the password (or **CANCEL** to cancel the operation).

All entries marked as secret throughout the Organizer will then be hidden and will not be accessible until the Organizer is unlocked by giving the correct password.

A message appears warning you not to forget the password. If you have any doubt about whether or not you will always be able to recall this password, write it down and keep it in a safe place.

6. Press **ENTER**.

 appears on the display, indicating that any information you mark as secret will now be hidden. The unit itself can still be accessed until you turn on the ASK PASSWORD

feature in the SET START-UP DISPLAY window. See p.184.

## Marking/unmarking entries as Secret

You can mark or unmark any entry as secret in Edit mode.

1. Open the application containing the entry you want to mark as secret.
2. Display the entry in Edit mode.
3. Press **MENU** twice to display the PREFERENCES menu, select SET SECRET STATUS and press **ENTER**.

☞ If the Organizer has been locked (which hides all secret entries) an entry which has just been marked as secret will remain displayed until you move to another entry. Once you leave the entry marked as secret, it will be hidden together with all other secret entries (for more information, see the next section).

## Accessing Secret entries

Entries marked as secret are not shown in any of the Organizer's display modes when it is locked, and cannot be accessed using any of the search methods. To be able to recall and access secret entries, the Organizer must first be unlocked.

1. Press **MENU** twice to open the PREFERENCES menu. Select SECRET then press **ENTER**.

The SECRET submenu appears.

2. Select LOCK ORGANIZER then press **ENTER**.

A window appears, prompting you to enter your password.

3. Enter your password exactly as you registered it (remember that the password is case-sensitive, distinguishing between upper- and lower-case letters).
4. Press **ENTER**.

If the password is correct, **T** disappears.

If the password is incorrect, a message appears indicating this.

5. After unlocking the Organizer, access any entry you want using the normal procedures.

☞ If you forget your password, you will not be able to unlock the Organizer and access your secret information. If this happens, you will have to delete the old password to be able to continue to use the Secret function. This will also delete all entries marked as secret. For a full explanation of what to do if this occurs, see below, p.188.

→ You can use **2nd SEARCH** to find only those entries marked as secret once the Organizer is unlocked (see p.63).

## Automatic Relocking

Once a password has been registered, even if you unlock the Organizer using the procedure above, the Organizer will automatically lock itself each time you turn it off. This automatic relock feature protects your secret data in case you forget to relock the unit. The feature remains in effect as long as a password is registered. To disable this feature, the password must be deleted once the Organizer is unlocked.

You can also lock the Organizer yourself at any time:

1. Press **MENU** twice to open the PREFERENCES menu.
2. Select SECRET then press **ENTER**.

The SECRET submenu appears.

3. Select LOCK ORGANIZER and press **ENTER**.

**T** appears, indicating that the Organizer is now locked.

## Changing or deleting the password

To register a new password, the current one must first be deleted.

1. Press **MENU** twice to open the PREFERENCES menu.
2. Select SECRET then press **ENTER**.

The SECRET submenu appears.

3. Select DELETE PASSWORD, and press **ENTER**.



4. Enter your password exactly as you registered it (remember that the text box is case sensitive distinguishing between upper- and lower-case letters).
5. Press **ENTER**.

A message appears indicating that the Organizer is unlocked. Entries that were marked as secret can be accessed until a new password is registered (to register a new password, use the procedure for Registering a password on p.186).

☞ Remember that if you delete a password while the Organizer is locked, all secret entries will be deleted as well. The Organizer will not remind you of this!

## If you forget your password...

If you have forgotten your password, the only way you will be able to delete it and continue to use the Secret function is to delete all entries marked as secret.

1. Press **MENU** twice to open the PREFERENCES menu.
2. Select SECRET then press **ENTER**.

The SECRET submenu appears.

3. Select DELETE ALL SECRET DATA, and press **ENTER**.

A warning message appears asking if you are sure you want to delete all the secret entries. If you have forgotten your password, you have no choice but to proceed.

4. Press **Y** to delete all secret entries. This will then allow you to enter a new password.

☞ If you set ASK PASSWORD in the SET START-UP display to ON, and forget your password, you will have to reset the entire Organizer, thereby erasing all the stored entries and information (see p.197).

## Changing the Calendar Display Format

The Organizer lets you change the default **Calendar** display to one you find more convenient. There are two aspects to changing the display: setting the monthly format, and setting up the **Calendar**. You can use these options to set up a way of working that you prefer.

### Setting the monthly format

You can set the Monthly and Two-month views in the **Calendar** application to show the weeks in either a Sunday-to-Saturday format (this is the default) or a Monday-to-Sunday format.

In the **Calendar** application:

1. Press **MENU**, select SET UP WEEKLY FORMAT, then press **ENTER**.

A submenu appears. The current setting is indicated by an asterisk.

2. Select the desired format and press **ENTER**.

The Monthly view is then displayed accordingly.

### Setting up the default Calendar view

You can set up the **Calendar** to show either a Monthly or Daily view each time the **Calendar** application is opened. The default setting after initialization is the Monthly view.

In the **Calendar** application:

1. Press **MENU**, select SET UP DEFAULT VIEW then press **ENTER**.

A submenu appears. The current setting is indicated by an asterisk.

2. Select the desired format and press **ENTER**.

The current calendar view does not change. However, the desired format is used the next time the Calendar application is opened.

## Setting up the date format

Almost all Organizer applications require a date to be entered at some point. The default format for date entry is “MM/DD/YYYY”, where MM is the two-digit month, DD is the two-digit day of the month and YYYY is the four-digit year. The date will be displayed as “MMM DD, YYYY”, where MMM is the three-character abbreviation for the month name. However, you can choose instead to have the date entered in the format “DD.MM.YYYY”, which will then be displayed in the format “DD MMM YYYY”.

For example, in MM/DD/YYYY format, the date July 4th, 1996 will be entered as “7/4/1996” and displayed as “JUL 7, 1996”. However in DD.MM.YYYY format, the same date will be entered as “4.7.1996” and displayed as “4 JUL 1996”.

1. Press **MENU** twice to display the PREFERENCES menu.
2. Select SET UP DATE FORMAT and press **ENTER**.  
A submenu appears. The current selection is marked with an asterisk.
3. If the desired format is not already selected, move to it and press **ENTER**.

## Selecting the Bold display font

Since the Organizer’s display is fairly small, you may find the displayed information easier to read if all characters appeared in a bold style, which is slightly thicker than normal.

1. Press **MENU** three times to display the TOOLS menu.

If bold font has not yet been selected, no ✓ will appear next to the menu item SET BOLD FONT.

2. Select SET BOLD FONT and press **ENTER**.

All characters on the display will then appear in bold style.







☞ This option only affects the way information appears on the Organizer’s display, and does not affect the way the actual information is stored or printed.











# Appendices

- A. List of Key Notations
- B. Resetting the Organizer
- C. Troubleshooting
- D. Battery Replacement
- E. Specifications

## A. List of Key Notations

Key	Representation in Text	Function
	CALENDAR	Opens the <b>Calendar</b> application.
	SCHEDULE	Opens the <b>Schedule</b> application.
	TO DO	Opens the <b>To Do</b> application.
	ANN	Opens the <b>Ann</b> application. Subsequent presses switch between ANN1 and ANN2 files.
	TEL	Opens the <b>Tel</b> application. Subsequent presses switch between TEL1, TEL2 and TEL3 files.
	USER FILE	Opens the <b>User File</b> application. Subsequent presses switch between USER FILE 1, 2 and 3.
	CLOCK	Opens the <b>Clock</b> application to display the time and date on the built-in clock.

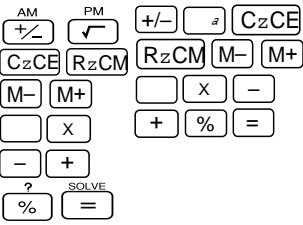
Key	Representation in Text	Function
	<b>MEMO</b>	Opens the <b>Memo</b> application.
	<b>OUTLINE</b>	Opens the <b>Outline</b> application.
	<b>MONEY TRACKING</b>	Opens the <b>Money Tracking</b> application. In Index mode, subsequent presses display each account's Index view, as well as the All transaction list. When Account information is displayed, subsequent presses alternate between displaying the current and opening account balances.
	<b>MENU</b>	Opens application's menu, PREFERENCES, TOOLS and PERIPHERALS menus.
	<b>2nd</b> <b>SEARCH</b>	Calls the Search function.
	<b>CALC</b>	Opens the <b>Calc</b> application. Subsequent presses switch to paperless printer mode, to date calculator mode, cost/sell/margin calculation, then to cost/sell/markup calculation, then back to standard Calc Mode.

Key	Representation in Text	Function
<b>ON</b>	<b>ON</b>	Turns the Organizer on. Interrupts printing or data transfer.
<b>OFF</b>	<b>OFF</b>	Turns the Organizer off.
		Calculator application function keys.
	<b>AM</b> <b>PM</b>	AM/PM selection. Automatically activated in appropriate applications.
<b>CANCEL</b> <b>ON</b>	<b>CANCEL</b>	Clears an unstored entry. Cancels a selection, menu, or operation to return to the previous display.
<b>NEW</b>	<b>NEW</b>	Opens a new entry in an application.
	<b>NEW</b>	Clears field contents when entering or editing data.

Key	Representation in Text	Function
		Edits the currently selected or currently displayed entry.
		Displays the pop-up list containing available choices for the currently selected field. Only works for currently selected field. Only works for currently selected pop-up fields, indicated by ~.
		Moves the cursor one character to the left.
		Moves the cursor to the beginning of a line.
		Selects text for deleting, cutting or copying.
		Moves the cursor one line up. Scrolls the display up.
		Moves the cursor to the first line of a display in the <b>Memo</b> application. Moves the cursor to the first line of a field in other applications.

Key	Representation in Text	Function
		Selects text for deleting, cutting or copying.
		Moves the cursor one line down. Scrolls the display down.
		Moves the cursor to the last line of a display in the <b>Memo</b> application. Moves the cursor to the last line of a field in other applications.
		Selects text for deleting, cutting or copying.
		Moves the cursor one character to the right.
		Moves the cursor to the end of a line.
		Selects text for deleting, cutting or copying.
		Steps up through entries/screens. Continues to search backwards for a keyword.

Key	Representation in Text	Function
		Steps down through entries/screens. Continues to search forwards for a keyword.
-     -		Enters numerals 1-0.
		The backspace key. Deletes the character to the left of the cursor.
-     -		Enter the letters A-Z.
		Stamps the current local time at the cursor location in an entry.
		Prints the current display when a printer is connected.
		Stamps the current local date at the cursor location in an entry.
		Calls the on-line help feature.

Key	Representation in Text	Function
		Enters accent marks: ` , ` ~ ` , ` ^, respectively. Press the key then type a letter to create accented characters.
		Switches the letter keys between upper and lower case when pressed. Enters a symbol in white above a key when held while the key is pressed.
		Cuts a specified text/picture or a selected entry to the clipboard for pasting to another location.
		Copies a specified text/picture or a selected entry to the clipboard for pasting to another location.
		Places a text/picture in the clipboard at the cursor location.

Key	Representation in Text	Function
		Checks off the <b>SECRET ONLY</b> box in the Search and Filter functions.
		Moves topics in the <b>Outline</b> application.
		Expands/collapses topics in the <b>Outline</b> application.
		Enters the French character ç.
		Enters a comma.
		Enters the German character ß.
		Enters apostrophe.
		Enters a period. In calculations, the period entered from the keyboard acts as a decimal point.
		Enters colon.
		Caps lock key. Switches the letter keys between upper- and lower-case modes.

Key	Representation in Text	Function
		Press this key then another key to access any second function indicated in blue above the key. Also accesses keyboard shortcuts.
		Accesses a user word list.
		Accesses the symbol menus.
		Checks off the <b>To Do</b> entries. Enters “✓” as a symbol.
		The space key.
		Toggles between insert and overwrite mode when entering/editing data. Creates a new topic in the Outline application.
		Deletes a character at the cursor position when entering/editing data. Deletes entries when viewing data.
		Deletes a line at the cursor location.

Key	Representation in Text	Function
<b>ENTER</b>	<b>ENTER</b>	Executes operations. Stores entries in memory. Opens the Edit mode.
	<b>2nd</b> <b>ENTER</b>	Stores an edited entry as new, leaving the original unchanged.
<b>GET</b>	<b>GET</b>	Receives data via the infrared port from an OZ-5500.
<b>SEND</b>	<b>SEND</b>	Sends data via the infrared port to an OZ-5500.
	<b>2nd</b> <b>SEND</b>	Prints the selected entry when a printer is connected.

## B. Resetting the Organizer

A strong impact, exposure to an electrical field, or other unusual conditions may render the unit inoperative, and pressing the keys will have no effect. If this occurs, you will have to press the RESET switch at the bottom of the unit using a pen or similar object to be able to continue to use the unit.

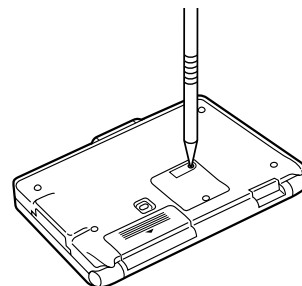

- A condition that makes the unit inoperative may erase some or all of the data stored in memory.
- Do not use anything breakable, anything with a sharp tip or anything that might break to press the RESET switch.

## All reset operation

If the unit still fails to function after it has been reset using the procedure above, or you have forgotten the password to be entered in the start-up display, you will have to reset it using a slightly more complicated procedure:

1. While pressing and holding **ON**, press and release the RESET switch.

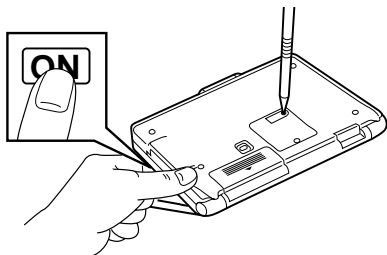

A message appears.

2. Release **ON**.
3. Press **N**.

The built-in clock and any set daily alarms are reset.



- Do not press **Y** in step 3. Doing so will delete all data in the unit.
- However, if you have forgotten the password required at start-up, you have no choice but to press **Y** in order to use the unit, but losing all your data in the process.

## C. Troubleshooting

Refer to the list below for solutions when the unit is not functioning properly before contacting your local SHARP dealer.

Problem	Solution
The display remains blank after pressing <b>ON</b> .	<ul style="list-style-type: none"><li>• Adjust the LCD contrast (see p.50).</li><li>• Install new batteries (see p.199).</li></ul>
Poor display contrast.	Adjust LCD contrast (see p.50).
The Organizer is turned on, but pressing keys has no effect.	Reset the Organizer (see p.196).
“Not enough memory” displayed.	The Organizer’s memory is full or nearly full. Delete unnecessary data. (You can check the amount of free memory using CHECK MEMORY in the TOOLS menu. See p.67.)
The alarm does not sound at the set time.	Enable alarms using the TOOLS menu (see p.131).

## D. Battery Replacement

### General guidelines

The Organizer uses the following types of batteries:

Use	Type	Size/Model	Qty.
General operation	Alkaline batteries	LR03 (L30)	2
Memory backup	Lithium battery	CR2032	1

There are some extremely important points to remember when installing new batteries:

- ☞ Do not remove the operating and backup batteries at the same time. Doing so will result in the loss of all data stored in the unit’s memory.
- Backup all important data before replacing the batteries.
- Replace the two operating batteries at the same time with new batteries of the same type.
- The memory backup battery installed at the factory at the time of manufacture may have become depleted during shipment and may not have the full battery life indicated in the specifications.



### Caution:

- Keep batteries out of the reach of children.
- Remove batteries from the unit when they become weak or when the unit will not be used for a long period of time. Leaving weak batteries in the unit may cause battery leakage and damage from corrosion.
- Do not dispose of batteries by fire as they may explode.

## Replacing the operating batteries

When using the Organizer, if the **BATT** symbol appears at the top of the display, the operating batteries should be replaced as soon as possible. To confirm this, turn the Organizer off and then on again. If the display shown below appears, replace both of the operating batteries immediately.

#Display E-2

1. Turn off the Organizer.
2. Set the battery replacement switch on the bottom of the Organizer to REPLACE BATTERIES (a red dot will appear).

3. Slide off the operating batteries cover.

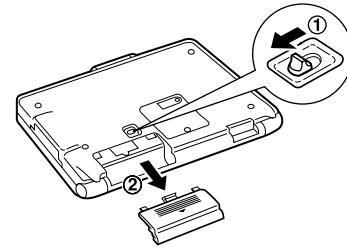

4. Remove the old batteries by pulling the ribbon tab.
5. Insert the two new batteries on top of the ribbon tab, taking care to position them correctly according to the plus (+) and minus (-) terminals, as shown below.

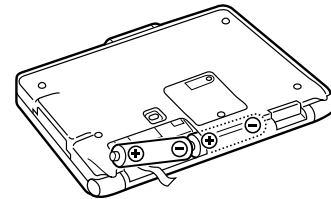

6. Replace the cover.
7. Set the battery replacement switch to NORMAL OPERATION.

If nothing happens when you press **ON**:

- Setting the battery replacement switch to REPLACE BATTERIES shuts off power to the unit. Check that the battery replacement switch is set to NORMAL OPERATION.
- Repeat the above battery replacement procedure step by step.

## Replacing the memory backup battery

The Organizer's memory backup battery has an expected life of approximately five years under normal conditions (temperature extremes can shorten the life of the battery). Replace the memory backup battery every five years or whenever the following display appears.

#Display E-5

### WARNING:

When the operating batteries are depleted, replace them promptly with new batteries. If depleted batteries are not replaced, the memory backup battery will be drained more quickly than normal. This in turn could cause you to lose all your data when the operating batteries are replaced.

Memory backup battery life:

- ✦ Approx. 4 months (when the operating batteries are depleted)
- ✦ Approx. 5 years (when the depleted operating batteries are promptly replaced)

☞ Do not try to replace the memory backup battery if the operating batteries are weak. Doing so may result in the loss of all data in the unit. If necessary, replace the operating batteries before replacing the memory backup battery.

1. Turn off the Organizer.
2. Set the battery replacement switch on the back of the unit to REPLACE BATTERIES (a red dot will be visible).
3. Remove the screw holding the memory backup battery cover in place.

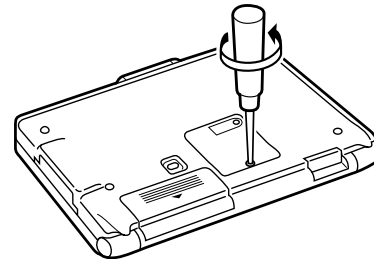

4. Remove the memory backup battery cover.

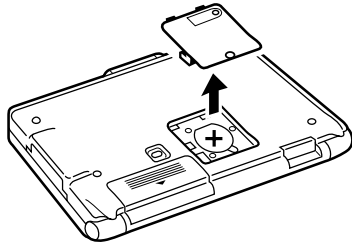

5. Remove the old battery using a pen or a similar object.

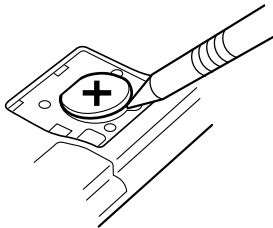

6. Insert a new battery with the plus (+) side up.
7. Replace the memory backup battery cover and secure it with the screw.
8. Set the battery replacement switch to NORMAL OPERATION.

**If nothing happens when you press ON:**

- Setting the battery replacement switch to REPLACE BATTERIES shuts off power to the unit. Check that the battery replacement switch is set to NORMAL OPERATION.
- Repeat the above battery replacement procedure step by step.

## E. Specifications

Model	OZ-5500
Display	240 x 79 dot matrix liquid crystal display
Electronic unit section	
Applications	Calendar, Schedule, To Do, Clock, Anniversary, Telephone, User File, Memo, Outline, Money Tracking, Calc
Memory capacity	256 Kbytes (User area: Approx. 206 Kbytes) Schedule application capacity: Approx. 3,260 entries Tel application capacity: Approx. 3,040 entries These capacities assume the following average entry sizes and only apply when all the available memory is committed to a single function. Schedule: 32 characters/entry Tel: 16 characters/entry in the name field 12 characters/entry in the number field

Maximum data size per entry	Memo: 16 Kbytes Outline: 32 Kbytes for an entire outline 2 Kbytes for each topic Tel/User File: 2 Kbytes for text data Other applications: 2 Kbytes
User interfaces	Keyboard
Other features	Secret function, data transfer, search function, help function, et al.

### Calculator

Digits	10
Functions	Addition, subtraction, multiplication, division, constant, square root, percent, memory calculation, date calculation, paperless printer, cost/sell/margin calculation, cost/sell/markup calculation.

### Clock

Crystal oscillation frequency	32,768 Hz
Accuracy	Average variance per day, 1.5 seconds (at 25°C/77°F)

Display information	Year, month, day, day of the week, hours, minutes, AM/PM, city names.
Time system	12-hour or 24-hour
Other functions	Display of date and time for various cities around the world. Enable/disable daylight saving time.

### Peripherals and data transfer interface

IR transfer	Up to a distance of approx. 80 cm.
Cable jack	15-pin connector

### Common

Power	Battery: Main supply: 3 V $\dots$ DC, alkaline batteries (LR03 x 2) Memory backup: 3 V $\dots$ DC, lithium battery (CR2032 x 1)
Power consumption	0.23 W

### Battery life

Battery life may vary depending on usage.

Operating batteries:

- Approx. 80 hours (2 months of 1 hour continuous use per day)  
Continuous display at an ambient temperature of 23°C (73°F)
- Approx. 55 hours (1.5 months of 1 hour continuous use per day)  
Searching data for 5 minutes and display on for 55 minutes per hour, at an ambient temperature of 23°C (73°F)

Memory backup battery:

- Approx. 4 months (when operating batteries are depleted)
- Approx. 5 years (when depleted operating batteries are promptly replaced)

Operating temperature

0°C to 40°C (32°F to 104°F)

Dimensions	Open	160(W) x 164(D) x 9.2(H) mm 6-5/16(W) x 6-15/32(D) x 3/8(H) inch
	Closed	160(W) x 89(D) x 18.4(H) mm 6-5/16(W) x 3-1/2(D) x 23/32(H) inch
Weight	245 g (0.54 lb) (including batteries)	
Accessories	Alkaline batteries LR03 x 2, lithium battery CR2032 x 1 (installed), operation manual	

# Index

## A

- Accessing
  - Secret entries 187
- Accounts (see under Money Tracking)
- Adding
  - Accounts
    - (see under Money Tracking)
  - Categories: Money Tracking
    - (See under Money Tracking)
  - Categories: To Do 85
  - Topics 110
  - Transactions
    - (see under Money Tracking)
  - User's city 129
- Alarms
  - Daily 130
  - Disabling all alarm sounds 131
  - Schedule 79
- All reset 197
- Ann(iversary) application 90
- Application 51
  - Opening 55
  - Keys 42
- Assigning
  - Due date 81
  - Priority 81

Auto power off 50

## B

- Battery
  - Installing 43
  - Life 203
  - Memory backup 200
  - Operating 199
  - Replacement 198
- Blocks
  - Copying/moving 161
  - Working with blocks of text 61
- Bold Font 190

## C

- Calc(ulator) application 117
  - Date calculations 120
  - Using with other applications 121
- Calculations
  - Changing part of 119
  - Examples 124
  - Inserting figures into 119
  - Performing 117
    - Date calculations 120
    - Cost/price/margin calculations 122
    - Cost/price/markup calculations 122
    - Paperless printer mode 118
- Calendar application 69
  - Setting up the initial display 70, 189

## Calendar view

Daily 71

Monthly 70

Monthly Goals 70

Selecting 69

Two-month 70

Weekly 71

## Caring for the Organizer 40

### Categories

#### Money Tracking application:

Accessing by category (Filter) 143, 147

Adding 146

Assigning to transactions 139

Category list 139

Deleting 159

Editing 146

Preset 145

#### To Do application:

Accessing by category (Filter) 87

Adding 87

Assigning to entries 85

Category list 86

Deleting 87

Editing 87

## Changing

(see also Customizing)

Bold text 190

Calendar format 189

Display width 106

Local city (Clock) 126

## Checking

Current time/date 66

Intermediate results of a calculation 119

Memory 67

Time in a city 128

Checking off To Do entries 84

Clock application 126

Collapsing outline families 114

## Copying

Blocks of text 61, 161

Entries 162

Create Activities (Calendar) 72

Cursor 60

## Customizing

Index display 101

Tel/User File applications 102

Cut 62, 161, 162

## D

### Daily alarms

Setting 130

Turning on/off 131

Daily view 71

Date calculation 120

Date format 59

Setting 190

Date stamp 163

Daylight Saving Time (DST) 130

Assigning to a city 130



- Enabling/disabling 130
- Decimal point setting 123
- Deleting
  - All entries in an application 65, 76, 88, 92, 98, 106, 113, 158
  - All To Do entries in current view 88
  - All Secret entries 189
  - Money Tracking Categories 159
  - Filtered entries 166
  - Line in a calculation 120
  - Schedules over a specific period 77
  - Single entries 65, 76, 88, 92, 98, 105, 112, 157
  - Text 61
  - Topics 112
  - Using the application menu 65
- Display
  - Setting the LCD contrast 50
  - Symbols 53
- Display modes 56
  - Edit mode 57
  - Index mode 56
  - View mode 57

## **E**

- Edit mode 57
- Editing techniques 59
- Editing
  - (see also Revising)
  - Categories 87, 146

- Entries 75, 84, 92, 97, 105, 110, 141
- Emulation
  - Printer 170
- Entering
  - Monthly goals 82
  - Subtopics 114
- Error indicator 122
- Expanding families 115

## **F**

- Families
  - Collapsing 114
  - Expanding 115
  - Restructuring 115
- Fields 59
- Filter function 165
  - Deleting filtered entries 166
  - Turning off 166
  - Turning on 165
- Finding entries 63, 72, 75, 82, 91, 96, 104, 109
  - (see also Search)
  - By date 64
  - Using keywords 63, 75, 83, 91, 97, 105, 109
  - Using the Calendar views 72, 75, 83, 91
  - Using the Index mode 63, 75, 82, 91, 97, 104, 109, 137, 140
- Font
  - Changing Bold style 190

## H

Help 53  
Index 54

## I

IN BOX 178  
IN BOX Viewer 178  
Index mode 56  
Infrared transfer  
    Setting up 174  
    Notes on 175  
Initializing 10, 44  
Inserting  
    Text 61  
    Topic 110  
Installing  
    Batteries 9, 43

## J

Joining two Outline topics into one 111

## K

Key beep 51  
Keyboard 52  
    Function/notation list 191

## L

Local city 46, 126  
Locking the Organizer 186

## M

Manual  
    Conventions used 39  
    Organization 37  
Marking entries as secret 187  
Memo application 103  
Memory check 67  
Menu 52  
    Application 73, 80, 89, 93, 98, 107, 116, 125, 132, 160  
    Peripherals 169  
    Tools 68  
Money Tracking application 133  
    Accounts:  
        Adding new 135  
        Balances 136  
        Balancing and Reconciliation 152  
        Deleting 158  
        Editing 137  
        Index mode 137  
        List 137  
    Categories:  
        (See under Categories)  
    Transactions:  
        Adding new 137  
        Deleting 157  
        Editing 141  
        Index mode 140  
        Removing 156  
        Special fields 143

- Split function 147
  - Viewing in detail 141
- Monthly goals (To Do) 70
  - Entering 82
- Monthly view 70
- Moving
  - Appointments 75
  - Blocks of text 161
  - Entries 162
  - Topics 111

## **N**

- New entries
  - Making 58, 72, 74, 80, 90, 96, 103, 107, 137

## **O**

- Organizer Link 180
- Overwriting text 61
- Owner Information 45, 185

## **P**

- Paperless printer 118
- Part names and functions 42
- Password
  - Deleting/changing 188
  - Forgotten 188
  - Registering 186
- Paste 62, 162
- PC Link 180

- Peripherals menu 169
- Pop-up list/menu 52
- Power
  - Auto power off 50
  - Turning on and off 50
- Printing 170
  - All entries 172
  - Current display 171
  - Groups of entries 171, 172
  - Single entries 171

## **R**

- Replacing
  - Memory backup battery 200
  - Operating batteries 199
- Revising
  - (see also Editing)
  - Outlines 110

## **S**

- Schedule alarms 79
  - Clearing 80
  - Setting 79
- Schedule application 74
- Scrolling the display 62
- Search
  - (see also Finding)
  - By keyword 63
  - By date 64

Search function 63, 75, 83, 91,  
97, 105, 109

Secret function 186

Selecting

Calendar views 69

Date 72

Display modes 56

Topics 110

Setting

Clock 46, 126

Date format 190

LCD contrast 50

Local city 126

Monthly format 189

Owner's Information 45, 185

Password 186

Schedule alarms 79

Start-up display 48, 183

World city 49, 128

Setting up

Calendar's initial display 70, 189

For data transfer 174, 176

For printing 170

Organizer 12

Splitting one topic into two 112

Start-up display 48, 183

Responses to 184

Setting 183

Subtopics 113

Entering 114

Symbols

On the display 53

Entering 167

## T

Templates

Tel 47, 95

User File 47, 96

Tel application 95

Time stamp 163

To Do application 80

Tools menu 68

Topics

Adding 110

Joining two into one 111

Moving 111

Splitting one into two 112

Subtopics 113

Transactions (see under Money Tracking)

Transferring data 173

Between two OZ-5500

Organizers 174

With an Organizer other than

OZ-5500 176

Points to remember when 181

Single entries 175

Via infrared 174

With a personal computer 180

- Turning on/off
  - Daily alarms 131
  - Key beep 51
  - Power 50
  - Setup display 48
  - Word wrap 107
- Typing in text 60

## **U**

- Unlocking the Organizer 187
- User File application 95
- User File templates 47, 96
- User's city 129
- User's preferences 47

## **W**

- Weekly format 189
- Weekly view 71
- Wireless interface 174
- Word key
  - Inserting words/phrases in an entry 164
  - Deleting words/phrases 165
  - Registering words/phrases 164
- Word wrap 107
- World city 128



## Free Manuals Download Website

<http://myh66.com>

<http://usermanuals.us>

<http://www.somanuals.com>

<http://www.4manuals.cc>

<http://www.manual-lib.com>

<http://www.404manual.com>

<http://www.luxmanual.com>

<http://aubethermostatmanual.com>

Golf course search by state

<http://golfingnear.com>

Email search by domain

<http://emailbydomain.com>

Auto manuals search

<http://auto.somanuals.com>

TV manuals search

<http://tv.somanuals.com>