

TALKSWITCH DOCUMENTATION

---

# VOIP NETWORK CONFIGURATION GUIDE

RELEASE 6.10

CT.TS005.002606

talkswitch®



ANSWERS WITH INTELLIGENCE®

# INTRODUCTION

## About this guide

This guide will help you plan and configure a TalkSwitch system to use VoIP (Voice over IP) in order to:

- Use IP phones as external IP extensions.
- Set up a multi-location TalkSwitch VoIP network.
- Subscribe to a VoIP service provider.

## Where to go for further information

You can find additional documentation:

- Within the TalkSwitch management software by clicking the **Help** icons.
- By choosing **Start > Programs > TalkSwitch 6.10 > Documentation**.
- On the TalkSwitch management software CD.

## Documentation

In addition to this guide, the following documentation is available:

- *Adding IP Phones to TalkSwitch* describes configuring IP extensions.
- IP phone guides show how to use IP extensions.
- Guides containing VoIP service provider configurations are available at **[www.talkswitch.com/support](http://www.talkswitch.com/support)** (United States and Canada) or **<http://global.talkswitch.com>**.
- The *TalkSwitch Start Guide* shows how to install and set up a TalkSwitch system.
- The *TalkSwitch User Guide* provides complete information about the TalkSwitch system.
- Help built into the TalkSwitch management software describes each window.

## Contacting Technical Support

If you encounter difficulties with the installation or management of your TalkSwitch system, consult the documentation. If you still have questions:

- Contact your authorized TalkSwitch reseller.
- If you purchased directly from TalkSwitch, e-mail **[support@talkswitch.com](mailto:support@talkswitch.com)**, providing your company name and TalkSwitch product information.

## ABOUT VOIP

VoIP-enabled TalkSwitch units route VoIP calls over the Internet or private IP network, and other calls over the traditional telephone network.

VoIP-enabled TalkSwitch units use the industry-standard Session Initiation Protocol (SIP) for VoIP calls. In this guide the term SIP is often used in place of VoIP.

### About SIP servers

A VoIP network requires a SIP server to manage calls across the network. The SIP server contains registration information for all SIP devices in the network. When making a VoIP call, a device will contact the SIP server to get contact information for the destination. The device will then establish a connection with the destination. The SIP server is also involved with call termination.

All VoIP-enabled TalkSwitch units have built-in SIP servers to manage a TalkSwitch VoIP network, but you must designate only *one* TalkSwitch unit as the SIP server. TalkSwitch systems at other locations are configured as SIP clients.

**Note:** For VoIP calls made through a VoIP service provider, the service provider is the SIP server.

### Selecting a location for the SIP server

Any VoIP-enabled TalkSwitch unit on the network can be designated as the SIP server.

To simplify network operation and reliability, we recommend that you choose a location that has a static, rather than a dynamic, public IP address. A static public IP address does not change, providing a consistent connection address for each location to communicate with the SIP server. See *Setting the public IP address* on page 6.

## CONNECTING TO A NETWORK

Each location requires a high-speed connection to the Internet or private IP network that is sufficient for VoIP calls. This is required for a location using an external IP extension, TalkSwitch VoIP network, or service provider VoIP network.

### Connecting to local and IP networks

Set up a LAN (local area network) with an Ethernet switch, router, and modem or gateway. The Ethernet switch can be integrated into the router. Connect a computer to the LAN for configuring the TalkSwitch unit and other equipment. Optional IP phones can be connected as well. Use the provided RJ-45 Ethernet cable to connect the TalkSwitch unit to the LAN. To ensure reliability, all equipment should be connected to a UPS (uninterrupted power supply).

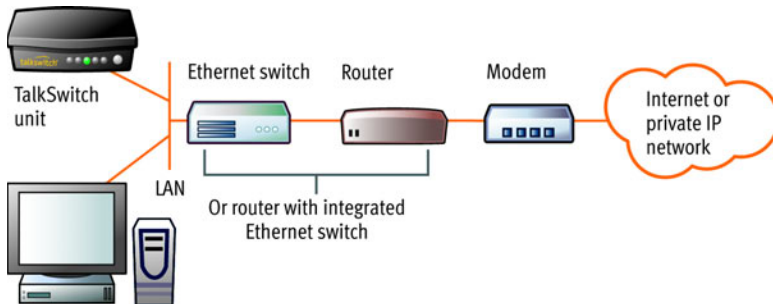

Figure 1: Local and IP network setup

### Connecting a VoIP gateway

In order to connect to a TalkSwitch VoIP network, a location can use a SIP-compatible VoIP gateway instead of a VoIP-enabled TalkSwitch unit. For example, the Mediatrix® 2102 is a TalkSwitch-certified third-party VoIP gateway that is suitable for small branch offices or teleworkers.

### Confirming network capacity

Ensure the LAN in each location has a reliable high-speed broadband connection to the Internet or private IP network. The quality of VoIP calls, especially on mixed voice and data networks, depends on high data-transfer rates across the network. The limiting factor is the upstream bandwidth to the ISP (Internet Service Provider). 'Lite' broadband connections (128 Kbps or less) are not suitable for simultaneous voice and data traffic.

To test the VoIP call capacity based on your Internet connection speed, perform the test available on our website at: [www.talkswitch.com/voip/voip\\_test.asp](http://www.talkswitch.com/voip/voip_test.asp).

# CONFIGURING IP ADDRESSES

## Starting the TalkSwitch management software

1. Double-click the **TalkSwitch Configuration 6.10** icon on your desktop. You can also select **Start > Programs > TalkSwitch 6.10 > TalkSwitch Configuration 6.10**. The **TalkSwitch Management Software** window appears, and the software attempts to detect your TalkSwitch unit.
2. Select your language. You can select *English*, *Français* or *Español*.
3. Once the software detects your TalkSwitch unit, click **Configure Auto-Detected TalkSwitch System**. The **About** page appears.

If the software was unable to detect your TalkSwitch unit, follow the procedures in *Step 3 — Open the TalkSwitch Management Software* in the *TalkSwitch Start Guide*.

## Setting the system IP settings

Each TalkSwitch unit must be configured with a local IP address. These addresses are used to direct VoIP calls to the appropriate location.

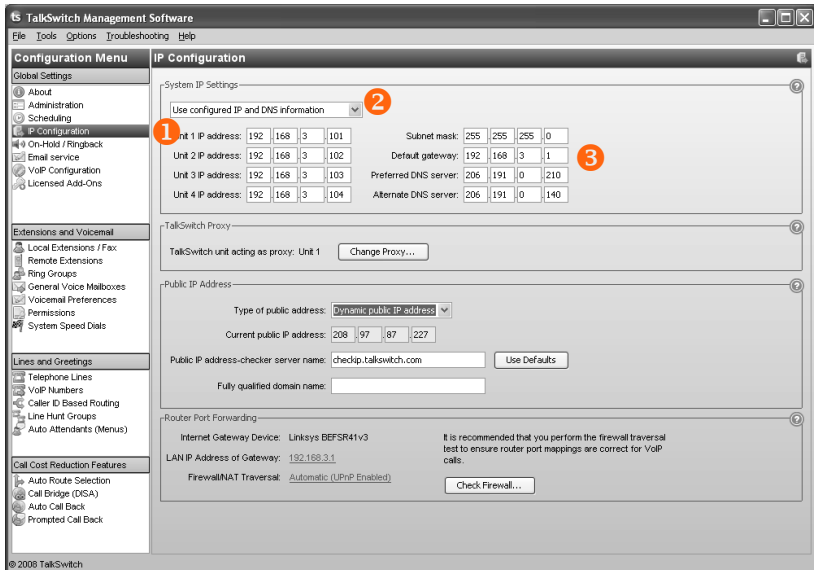

1. Select the **IP Configuration** page. By default, *Obtain IP and DNS information automatically* is selected and the area shows IP addresses from the router.
2. Change *Obtain IP and DNS information automatically* to *Use configured IP and DNS information* in order to lock in the IP addresses.
3. In some cases, the *System IP Settings* area may be blank because your router has not delivered the IP addresses. If so, enter the following IP addresses from your LAN administrator:
  - a) Enter a static IP address for each TalkSwitch unit in the *Unit IP address* boxes.
  - b) Enter the *Subnet mask* for the LAN. This address determines the subnet that the unit IP addresses belong to.
  - c) Enter the IP address of the *Default gateway* on your network. A gateway is a hardware device that connects the office network to the Internet. The router may act as default gateway.
  - d) Enter the IP address of the *Preferred DNS server*. DNS is a service that is used to resolve a domain name to an IP address. The router may act as DNS server.
  - e) If applicable, enter the IP address of the *Alternate DNS server*.

## Setting the public IP address

If you are setting up an external IP extension, or the SIP server of a TalkSwitch VoIP network, you must configure a public IP address for the TalkSwitch system. Some service provider VoIP networks also require the TalkSwitch system to have a public IP address.

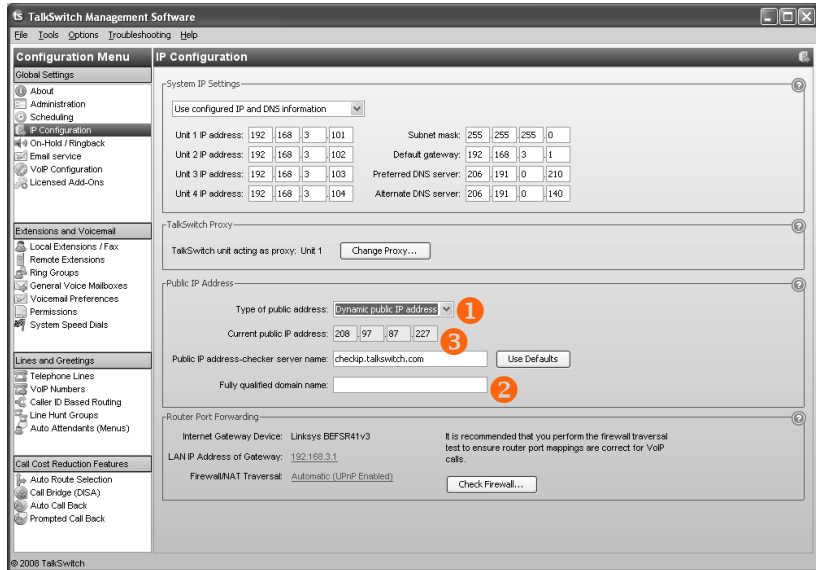

1. Set the *Type of public address*. Choices are:

- *Dynamic public IP address* — This is the default setting. Your ISP (Internet Service Provider) will assign different public IP addresses to your location. The TalkSwitch system will check its public IP address every few minutes. When the public IP address changes, the TalkSwitch system will automatically use the new one, in order to manage VoIP calls properly.

If *Dynamic public IP address* is selected, the window completes the *Current public IP address*, and sets *Public IP address-checker server name* to **checkip.talkswitch.com**. This server runs an IP checker application that provides public IP addresses to TalkSwitch systems.

- *Static public IP address* — A static IP address is fixed. Your Internet Service Provider assigns the static IP address. If this location will have the SIP server for a TalkSwitch VoIP network, we recommend using a static IP address.

If *Static public IP address* is selected, the window allows you to enter the *Current public IP address*, and disables the *Public IP address-checker server name* box.

2. If you selected *Dynamic public IP address*, enter the *Fully qualified domain name* (FQDN). Get the FQDN from your ISP.

A DDNS (Dynamic Domain Name Service) provider such as **www.dyndns.com** matches your dynamic IP addresses to your FQDN, so your TalkSwitch VoIP network or external IP phones will continue to work when the IP address changes.

If your router supports DDNS, ensure it supports your DDNS provider, and configure it to update the DNS servers.

If your router does not support DDNS, download one of the applications specified on **www.dyndns.com**. To update the DNS servers, the application needs to run on a PC connected to the same LAN as the TalkSwitch system.

3. If you selected *Static public IP address*, enter the *Current public IP address* from your Internet Service Provider. Leave the *Fully qualified domain name* box blank.

If the TalkSwitch unit is not behind a router, or if a private virtual network is used, the public IP address is the local IP address of the TalkSwitch unit acting as local proxy.

Note that it will take up to one minute for the new static public IP address to take effect.

4. Record the *Current public IP address* or the *Fully qualified domain name*.

If you are setting up an external IP extension, you will need the public IP address or FQDN of the TalkSwitch system.

If you are setting up a TalkSwitch VoIP network, the TalkSwitch profiles of the SIP clients must be configured with the public IP address or FQDN of the SIP server.

## CONFIGURING THE ROUTER

The *Router Port Forwarding* area of the **IP Configuration** page displays the type of gateway device (i.e. the type of router), the IP address of the gateway (i.e. router), and whether router configuration is required.

A router is a gateway between the local area network and the Internet. Most routers have a firewall to block unwanted data from the Internet. For voice data to reach the TalkSwitch system through the firewall, port forwarding is required. Port forwarding allows the router to map ports to the IP addresses of the TalkSwitch units. Valid Internet data will use the ports to go through the firewall to the TalkSwitch units.



If you are setting up external IP extensions, a TalkSwitch VoIP network, or a VoIP service that doesn't handle port forwarding, port forwarding is required.

If port forwarding is required, and your router supports uPNP (Universal Plug and Play), ensure uPNP is enabled. The TalkSwitch system will use uPNP to automatically set up port forwarding, and the **Automatic (uPNP Enabled)** link will appear. No router configuration is required.

If port forwarding is required but your router doesn't support uPNP, or automatic port forwarding doesn't work, the **Manual Port Mapping Required** link will appear. You will need to configure the router as described below.

1. Select the **IP Configuration** page.
2. If required, click the **Manual Port Mapping Required** link. The **Manual Port Mapping** window appears. It lists the packet type, port number, IP address and protocol of each required port.

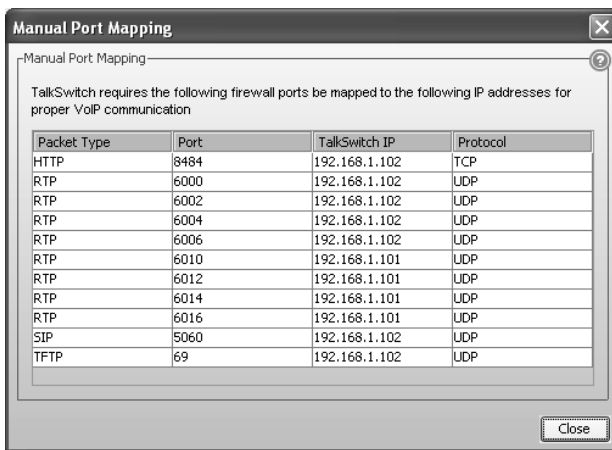

3. To access the router configuration:
  - a) Click the link containing the IP address of the gateway. The default browser starts, and prompts you for the router's user name and password.
  - b) Enter the router's user name and password. The browser shows a setup screen.
  - c) Navigate to the screen used to set up port forwarding. See your router documentation.

d) Set up port forwarding using the information from the **Manual Port Mapping** window. See your router documentation for instructions on how to map ports. For information on configuring routers and mapping ports, visit [http://www.portforward.com/english/routers/port\\_forwarding/routerindex.htm](http://www.portforward.com/english/routers/port_forwarding/routerindex.htm).

4. To check the status of each port through the firewall, click **Check Firewall**. The **Test Firewall** window appears.



5. Select the services you want to check.
6. Click **Test Ports**. The system will check the ports for the selected services.

### Configuring the router manually

If you cannot access the router configuration through the **IP Configuration** page, configure the router manually.

1. Open the router configuration and navigate to the screen used to set up port forwarding. See your router documentation.
2. Map port 5060 (Type: UDP) to the TalkSwitch unit acting as local proxy. Port 5060 is the default port for forwarding SIP signaling data to the TalkSwitch system.

If required, you can map a different port. In this case, enter the port in the *SIP signalling port* box of the **VoIP Settings** window.

3. Map the following ports (Type: UDP) to the TalkSwitch units. These RTP ports forward voice traffic to the TalkSwitch system by default.

VoIP Lines/ Unit	Unit 1	Unit 2	Unit 3	Unit 4
4	6000–6006	6010–6016	6020–6026	6030–6036
8	6100–6114	6200–6214	6300–6314	6400–6414

If required, you can map different ports. In this case enter the first port in the *Starting RTP port* box of the **VoIP Settings** window.

4. If you are setting up external IP extensions, map port 69 (Type: UDP) to the TalkSwitch unit acting as local proxy. Port 69 allows the TalkSwitch system to configure external IP extensions.
5. If you are setting up TalkSwitch IP phones as external IP extensions, map port 8484 (Type: TCP) to the TalkSwitch unit acting as local proxy. Port 8484 allows the TalkSwitch system to configure TalkSwitch IP phones as external IP extensions.
6. Map port 9393 (Type: TCP) to the TalkSwitch unit acting as local proxy. Port 9393 allows remote configuration of the TalkSwitch system.
7. If available, enable Quality of Service (QoS) to give voice traffic priority over data.
8. Save the configuration to the router.

## EXTERNAL IP EXTENSIONS

**Warning:** Calls to an emergency service number (e.g. 911) using an external IP extension will not send the correct address to the emergency operator.

We strongly recommend that you apply a warning label to any external IP extension stating:

1. Calls to emergency services should not be placed from this phone.
2. If an emergency call is made from this phone, you must provide your address to the emergency operator.

An external IP extension is an IP phone located outside the office. It is configured as a local extension of a TalkSwitch system, but connects to the system over the Internet or private data network. A user can receive or place a call with their external IP extension through the TalkSwitch unit to the standard telephone network, or to a VoIP network. An external IP extension requires at least one VoIP-enabled TalkSwitch unit at the office.

For example, the following illustration shows external IP extension 151 at a home office, and 152 at a branch office. The external IP extensions connect to the TalkSwitch unit at the main office over the Internet. In this example, a user can receive or place a call with their external IP extension through the TalkSwitch unit to the standard telephone network.

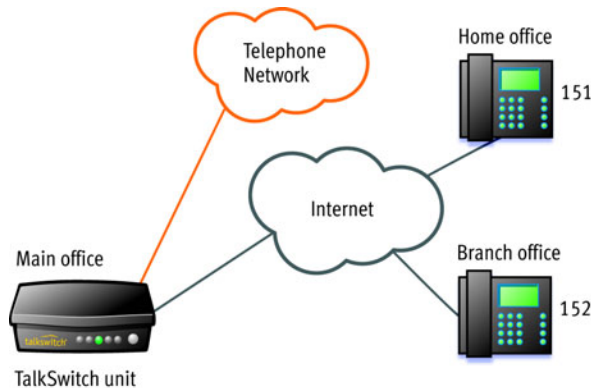

Figure 2: External IP extensions

Before proceeding, ensure you have:

- Connected the TalkSwitch system at each location to a network (see page 3).
- Configured local and public IP addresses (page 4).
- Configured the router (page 7).

EVERY CALL COUNTS

11

To set up an external IP extension, use the following steps:

1. Add the external IP extension, as described in *Adding IP Phones to TalkSwitch*. Procedures are available for adding TalkSwitch, Polycom, Grandstream, Counterpath and selected other phones (depending on the market).
2. Verify operation of the external IP extension:
  - a) Select the **Local Extension/Fax** page.
  - b) Select the external IP extension.
  - c) Confirm *Registered* is *Yes*, and the *Phone URL* appears in the *IP Extension Details* area.

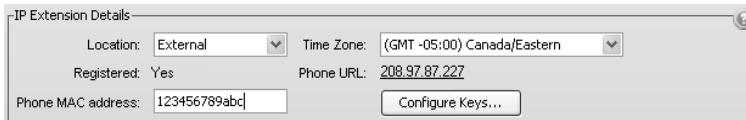

-IP Extension Details

Location: External Time Zone: (GMT -05:00) Canada/Eastern

Registered: Yes Phone URL: 208.97.87.227

Phone MAC address: 123456789abc Configure Keys...

3. Optionally, perform advanced VoIP configuration:
  - a) All VoIP lines are shared by default. You can reserve VoIP lines for the external IP extensions. See *Reserving VoIP lines* on page 26.
  - b) External IP extensions will use the preferred codec selected for the TalkSwitch profile. The default preferred codec is *G.729*. You can select the *Preferred codec* for the TalkSwitch profile. See *Setting codec options* on page 21.

## TALKSWITCH VOIP NETWORK

A TalkSwitch VoIP network has at least one SIP device at each location. A SIP device is a VoIP-enabled TalkSwitch unit, IP telephone or SIP gateway. One TalkSwitch unit in the network acts as the SIP server. The other SIP devices are SIP clients.

A user, auto attendant or call cascade can dial a three-digit VoIP number (ranging from 250 to 299) to reach an extension, auto attendant or voice mailbox at any location.

For example, the following illustration shows a TalkSwitch VoIP network with two locations. Calls between the offices are routed over the Internet, and local calls are routed over the traditional telephone network.

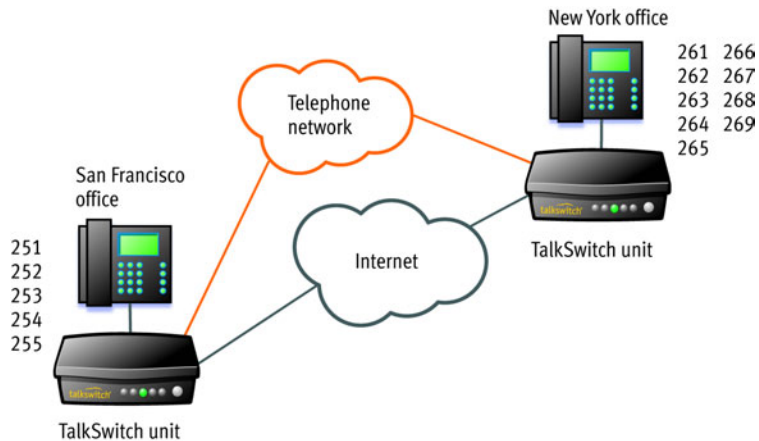

Figure 3: TalkSwitch VoIP network

Five VoIP numbers are assigned to San Francisco (251 to 255), and nine are assigned to New York (261 to 269). These VoIP numbers can be dialed directly from any extension, auto attendant or call cascade in the network.

The TalkSwitch unit in the San Francisco office has a static public IP address, so is designated as the SIP server. The TalkSwitch unit in New York is a SIP client.

Before proceeding, ensure you have:

- Connected the TalkSwitch system at each location to a network (see page 3).
- Configured local and public IP addresses (page 4).
- Configured the router (page 7).

## SETTING UP A TALKSWITCH PROFILE FOR THE SIP SERVER

The TalkSwitch profile for the SIP server shows registration details and contains authentication information.

1. Start the TalkSwitch management software, and connect to the TalkSwitch system that will act as the SIP server.
2. Select the **VoIP Configuration** page.
3. Select **Profile TS**, which is for configuring the TalkSwitch profile.

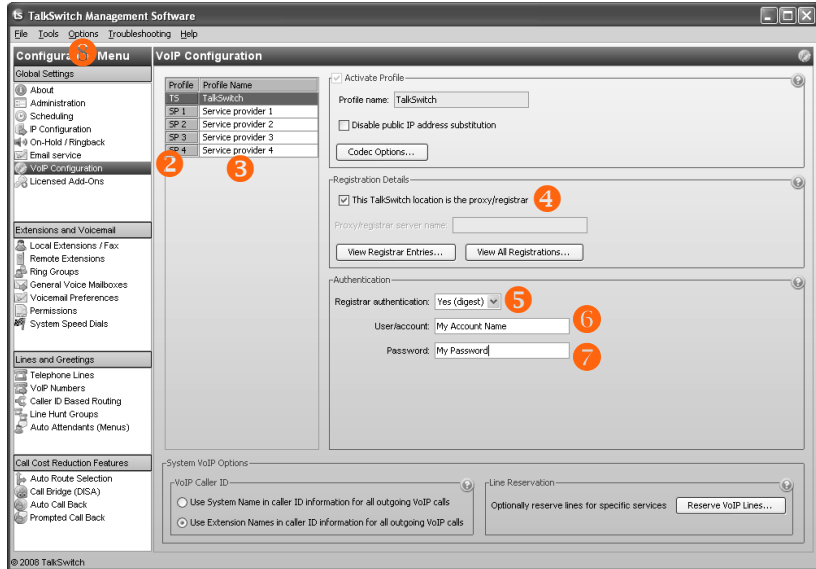

4. Select the *This TalkSwitch location is the proxy/registrar* check box.
5. Set *Registrar authentication* to *Yes (digest)*. This restricts access and allows only authorized devices to connect.
6. Enter a *User/account* name. All SIP clients must use this name.
7. Enter a *Password*. All SIP clients must use this password.
8. If you configured the router with non-default ports:
  - a) Choose **Options > VoIP Trunking**. The **VoIP Settings** window appears.
  - b) Set the *SIP Signalling Port* and/or *Starting RTP Port* as required.

## SETTING UP A TALKSWITCH PROFILE FOR A SIP CLIENT

The TalkSwitch profile for a SIP client contains registration details and authentication information.

1. Start the TalkSwitch management software, and connect to the TalkSwitch system that will act as the SIP client.
2. Select the **VoIP Configuration** page.
3. Select **Profile TS**, which is for configuring the TalkSwitch profile.

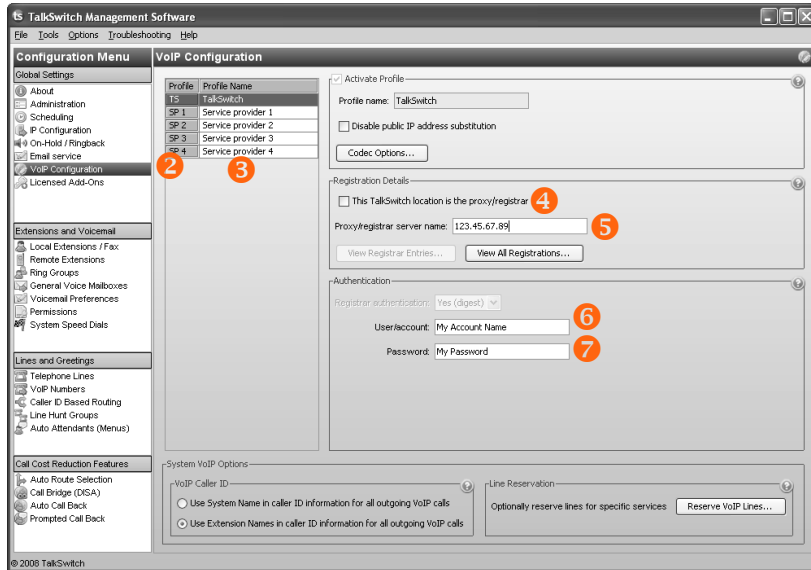

4. Leave the *This TalkSwitch location is the proxy/registrar* check box cleared.
5. Enter the *Current public IP address* or *Fully qualified domain name (FQDN)* of the SIP server into the *Proxy/registrar server name* box.

If the SIP server is using a non-default *SIP signalling port* (i.e. if the SIP server is not using 5060 as the *SIP signalling port*), specify the port number after a colon at the end of the public IP address or FQDN (e.g. 123.45.67.89:3456).

6. Enter the *User/account* name from the SIP server. All SIP clients must use this name.
7. Enter the *Password* from the SIP server. All SIP clients must use this password.



## CONFIGURING VOIP NUMBERS FOR A TALKSWITCH VOIP NETWORK

A VoIP number is like a telephone number, and is used to dial a TalkSwitch system at a particular location. Each VoIP number must be unique (i.e. only used at one location).

VoIP numbers 250 to 299 permit direct dialing from any extension, auto attendant or call cascade to any extension, auto attendant or voice mailbox in the TalkSwitch VoIP network. No line hunt group number is required. Longer VoIP numbers can also be used, but the user must first dial a line hunt group number.

To assist in assigning VoIP numbers for your network, use the *Appendix A — TalkSwitch VoIP network administration form* on page 28.

1. Select the **VoIP Numbers** page.

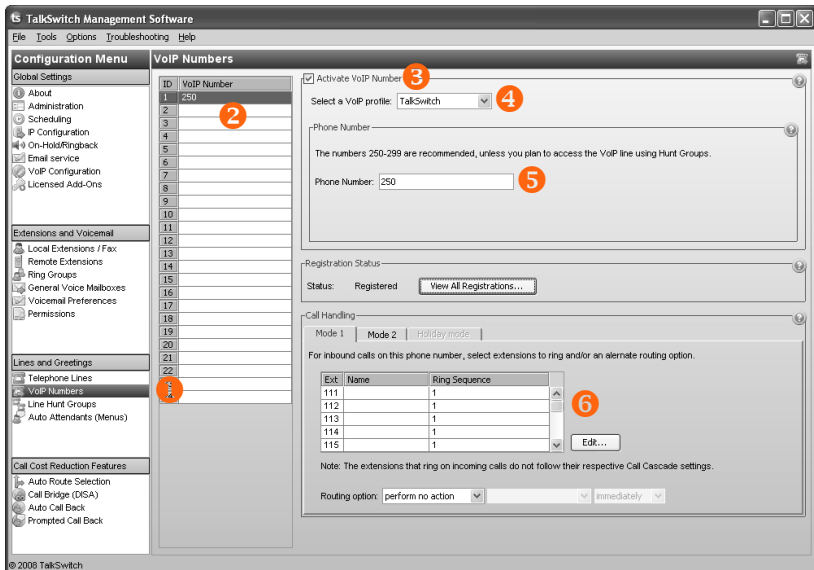

2. Select a VoIP number slot.
3. Select the *Activate VoIP Number* check box.
4. Set the VoIP profile to *TalkSwitch*.
5. Enter the VoIP number into the *Phone number* box.
6. Set up call handling for the VoIP number. For more information, click the **Help** icon ( ? ) in the *Call Handling* area.
7. Repeat steps 2 to 6 for each additional VoIP number.

## SETTING UP LINE HUNT GROUPS



**IMPORTANT:** Ensure at least one line hunt group uses telephone lines that can reach emergency services.

If a VoIP-enabled TalkSwitch unit is present, line hunt group 88 uses the TalkSwitch VoIP network by default, and the other line hunt groups use telephone lines. You can modify these default settings as described on page 24.

Note that the user does not have to dial the line hunt group number before VoIP numbers 250–299: these automatically use the TalkSwitch VoIP network.

If 50 VoIP numbers aren't enough for the network, you can set up longer VoIP numbers. To reach a longer VoIP number, the user will first dial a line hunt group number.

A local extension can be restricted to a set of line hunt groups in order to control access to VoIP networks. See *Hunt group permissions* in Chapter 2 of the *TalkSwitch User Guide*.

## ADVANCED VOIP CONFIGURATION

Optionally, perform advanced VoIP configuration.

1. The default preferred codec is *G.729*. You can select the *Preferred codec* for the TalkSwitch profile. All locations must use the same codec. See *Setting codec options* on page 21.
2. VoIP calls use extension names for caller ID by default. You can set the source for VoIP caller ID at each location. The same setting will be used by the TalkSwitch profile and all service provider profiles. See *Setting up caller ID* on page 25.
3. All VoIP lines are shared by default. You can reserve VoIP lines for the TalkSwitch profile at each location. See *Reserving VoIP lines* on page 26.

## SAVING SETTINGS TO TALKSWITCH

To transfer settings from your computer to the TalkSwitch system, choose **File > Save**. A window appears indicating the configuration is being sent.

## VERIFYING THE TALKSWITCH VOIP NETWORK

If you are configuring the TalkSwitch profile for the SIP server, the window enables the **View Registrar Entries** button. Clicking the button shows the **Registrar Entries** window with a list of VoIP numbers, their IP addresses and port numbers, and the number of seconds until their registrations with the SIP server will expire.

1. Select the **VoIP Configuration** page.
2. Select **Profile TS**, and then click **View Registrar Entries**. The **Registrar Entries** window appears.

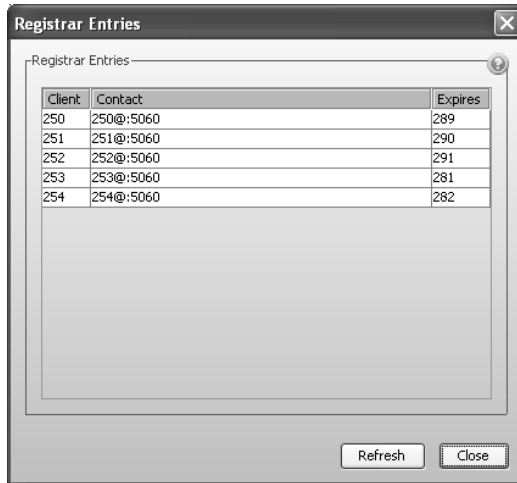

The screenshot shows a window titled "Registrar Entries" with a close button in the top right corner. Below the title bar, there is a header "Registrar Entries" and a help icon. The main content is a table with three columns: "Client", "Contact", and "Expires". The table contains five rows of data. At the bottom of the window, there are two buttons: "Refresh" and "Close".

Client	Contact	Expires
250	250@:5060	289
251	251@:5060	290
252	252@:5060	291
253	253@:5060	281
254	254@:5060	282

## SERVICE PROVIDER VOIP NETWORK

Using a service provider VoIP network requires at least one VoIP-enabled TalkSwitch unit. The service provider acts as the SIP server. The service provider assigns the VoIP numbers and VoIP configuration parameters.

For example, the following illustration shows a service provider VoIP network.

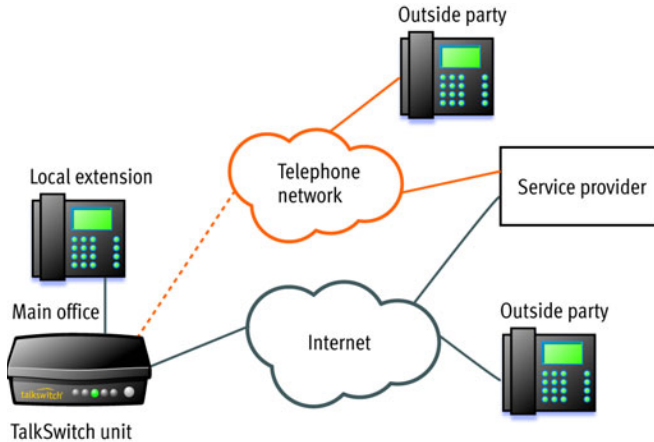

Figure 4: Service provider VoIP network

To reach an outside party, the user dials the line hunt group number associated with the service provider profile, and then dials the phone number. The TalkSwitch unit routes the call over the Internet to the service provider. If the outside party doesn't use the same service provider, they are connected over the standard telephone network. If the outside party does use the same service provider, they are connected over the Internet.

To reach a local extension, an outside party dials the VoIP number that was assigned to the TalkSwitch system by the service provider. The call is routed through the telephone network to the service provider. The service provider routes the call over the Internet to the TalkSwitch system, which directs the call to the local extension.

Before proceeding, ensure you have:

- Connected the TalkSwitch system at each location to a network (see page 3).
- Configured local IP addresses (page 4), and public IP addresses if required.
- Configured the router (page 7).

## SETTING UP A SERVICE PROVIDER PROFILE



If you are using a TalkSwitch-certified VoIP service provider, visit [www.talkswitch.com/support/ServiceConfigurationGuides.asp](http://www.talkswitch.com/support/ServiceConfigurationGuides.asp) to access the service configuration guide for your VoIP service provider. Otherwise use the procedures in this section.

A service provider profile contains the registration details for connecting to the service provider's SIP server.

1. Start the TalkSwitch management software.
2. Select the **VoIP Configuration** page.
3. Select a **Profile (SP 1 to SP 4)**, which are for configuring service provider profiles.

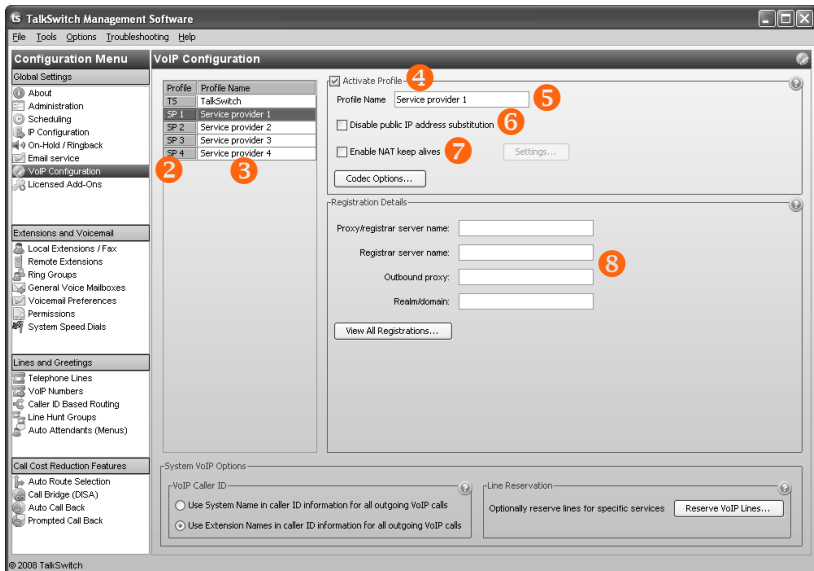

4. Select the *Activate Profile* check box.
5. Enter the *Profile name*. The default profile name is *Service provider n* (e.g. *Service provider 1*).
6. If your service provider requires you to register using your private IP address, select the *Disable public IP address substitution* check box.

7. If your service provider requires you to set up keep alive messages, and if your router does not support uPNP, set up keep alive messages.

Keep alive messages maintain the connection from the TalkSwitch unit, through your router, to the service provider's SIP server.

- a) Select the *Enable NAT keep alives* check box.
- b) Click **Settings**. The **Keep Alive Settings** window appears.



- c) Select the type of ping, as directed by your service provider. Choices are:
    - *Simple ping* — A standard ping message that works with all SIP servers.
    - *Nortel ping* — A longer but more reliable ping message that only works with specific Nortel SIP servers (e.g. Nortel MCS 5200).
  - d) If necessary, change the ping frequency, as directed by your service provider. The default setting is 45 seconds.
8. Enter the IP addresses or FQDNs, as provided by the service provider, into the following boxes. If the service provider does not specify a value, leave the box blank.
    - *Proxy server name*
    - *Registrar server name*
    - *Outbound proxy*
    - *Realm/domain*

## SETTING CODEC OPTIONS



If you are using a TalkSwitch-certified VoIP service provider, visit [www.talkswitch.com/support/ServiceConfigurationGuides.asp](http://www.talkswitch.com/support/ServiceConfigurationGuides.asp) to access the service configuration guide for your VoIP service provider. The service configuration guide lists the supported codecs.

A codec is a method of compressing and decompressing audio signals for communication across a network. TalkSwitch supports the G.729, G.726 and G.711 ( $\mu$ -law or A-law) codecs for VoIP calls. If your service provider or equipment requires specific codecs for VoIP or Fax over IP calls, you can restrict TalkSwitch to use the required codec.

The **Codec Options** window allows you to select the codecs that your system can use, specify the preferred codec, and clear the unsupported codecs. You can specify the codecs for the TalkSwitch profile, and for each service provider profile. External IP extensions will use the preferred codec specified in the TalkSwitch profile.

1. Select the **VoIP Configuration** page.
2. Click **Codec Options**. The **Codec Options** window appears.

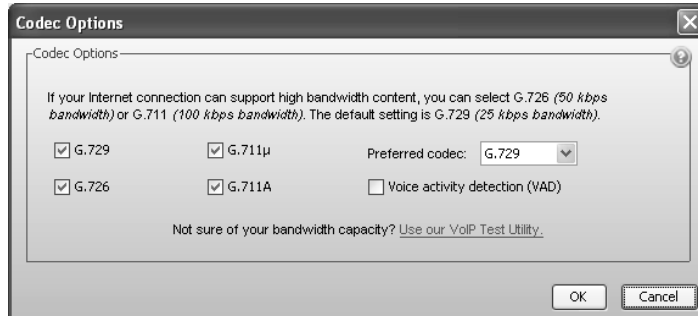

3. Select the codecs that your system can use, and clear the unsupported codecs. The following codecs are supported:
  - *G.729* — This codec provides good quality. It requires the least bandwidth and accommodates the highest number of concurrent calls.
  - *G.726* — This codec provides better quality. It requires more bandwidth and accommodates fewer concurrent calls.
  - *G.711µ* — This codec provides high quality and supports Fax over IP. It requires the most bandwidth and accommodates the fewest number of concurrent calls. *G.711µ* is used in North America and Japan.
  - *G.711A* — This codec provides high quality and supports Fax over IP. It requires the most bandwidth and accommodates the fewest number of concurrent calls. *G.711A* is used worldwide except for North America and Japan.
4. Select the *Preferred codec*. *G.729* is the default codec, which uses the least bandwidth and accommodates the highest number of concurrent calls.
5. Set *Voice activity detection (VAD)*. Enabling VAD reduces voice bandwidth when no speech is detected, and reduces transmission of background noise. We recommend disabling VAD to keep bandwidth available for speech.

## CONFIGURING VOIP NUMBERS FOR A SERVICE PROVIDER VOIP NETWORK



If you are using a TalkSwitch-certified VoIP service provider, visit [www.talkswitch.com/support/ServiceConfigurationGuides.asp](http://www.talkswitch.com/support/ServiceConfigurationGuides.asp) to access the service configuration guide for your VoIP service provider. Otherwise use the procedures in this section.

A VoIP number is like a telephone number, and is used to dial a TalkSwitch system at a particular location. Your service provider will assign VoIP numbers for each location.

### 1. Select the **VoIP Numbers** page.

The screenshot shows the TalkSwitch Management Software interface. The left-hand navigation menu is expanded to show the 'VoIP Numbers' option. The main window displays the 'VoIP Numbers' configuration page. The page includes a table of VoIP numbers (ID, VoIP Number) with a '2' next to the first row. The 'Activate VoIP Number' checkbox is checked, with a '3' next to it. The 'Select a VoIP profile' dropdown is set to 'My Service Provider', with a '4' next to it. The 'Phone Number' section has fields for 'Country Code' (1), 'City or Area Code' (234), and 'Number' (5678), with a '5' next to the 'City or Area Code' field. The 'Username and Password' section has fields for 'User/Account' (My Account) and 'Password' (My Password), with a '6' next to the 'User/Account' field. The 'Registration Status' section shows 'Status: Not Registered' and a 'View All Registrations...' button. The 'Call Handling' section has a 'Mode 2' tab selected and a table for 'Ext: Name Ring Sequence' with rows for 111, 112, 113, 114, and 115, with a '7' next to the table. A 'Help' icon is visible in the 'Call Handling' area.

2. Select a VoIP number slot.
3. Select the *Activate VoIP Number* check box.
4. Set the VoIP profile to the service provider (e.g. *My Service Provider*).
5. Enter the *Country Code* (if required), the *City or Area Code* and the *Number*.
6. Enter the *User/account* and the *Password* (if required) for this number.
7. Set up call handling for the VoIP number. For more information, click the **Help** icon ( ? ) in the *Call Handling* area.
8. Repeat steps 2 to 7 for each additional VoIP number.



## SETTING UP LINE HUNT GROUPS



**IMPORTANT:** Ensure at least one line hunt group uses telephone lines that can reach emergency services.

A line hunt group is a set of lines that are available for making an outbound call. It can use selected telephone lines, all VoIP lines associated with the TalkSwitch VoIP network, or all VoIP lines associated with a service provider VoIP network.

The configuration has nine different line hunt groups. If a VoIP-enabled TalkSwitch unit is present, line hunt group 88 uses the TalkSwitch VoIP network by default, and the other line hunt groups use telephone lines. You can modify these default settings as required. If you are using multiple service provider VoIP networks, set up a line hunt group for each service provider.

A local extension can be restricted to a set of line hunt groups in order to control access to VoIP networks. See *Hunt group permissions* in Chapter 2 of the *TalkSwitch User Guide*.

1. Select the **Line Hunt Groups** page.

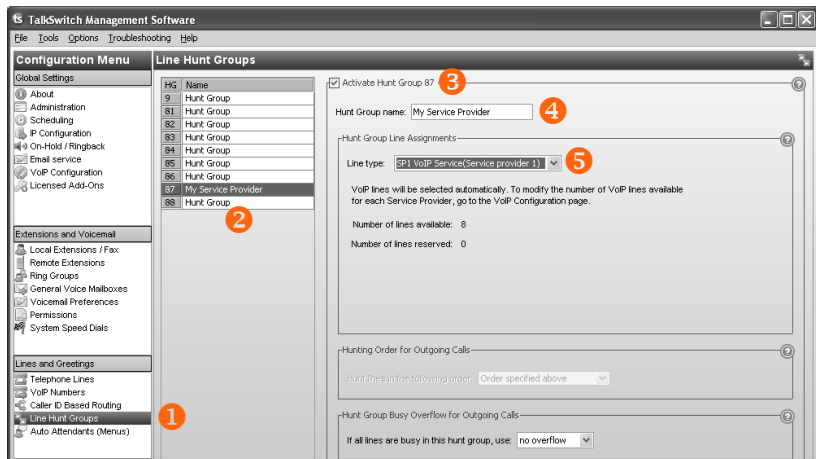

2. Select a line hunt group slot.
3. If necessary, select *Activate Hunt Group*. All line hunt groups are active by default.
4. Enter a *Hunt Group name*. The default name is *Hunt Group*.
5. Set *Line type* to *TalkSwitch VoIP* or *SPn VoIP Service*.
6. Select the overflow hunt group. Choices are *no overflow* and the other activated hunt groups. Ensure the overflow hunt group contains different lines than the original hunt group.

## ADVANCED VOIP CONFIGURATION

Optionally, perform advanced VoIP configuration.

### Setting up caller ID

The *VoIP Caller ID* area allows you to set up the source for caller ID for outbound VoIP calls. The same setting is used for the TalkSwitch profile and all service provider profiles. Extension names are used by default.

1. Select the **VoIP Configuration** page.
2. Set the caller ID for outbound VoIP calls.
  - To use the *System name* from the **Administration** page, select *Use System Name in caller ID information for all outgoing VoIP calls*.
  - To use the *First name* and *Last name* from the **Local Extension/Fax** page set up for each extension, select *Use Extension Names in caller ID information for all outgoing VoIP calls*.

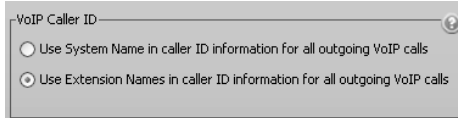

The screenshot shows a dialog box titled "VoIP Caller ID" with a close button in the top right corner. It contains two radio button options:

- Use System Name in caller ID information for all outgoing VoIP calls
- Use Extension Names in caller ID information for all outgoing VoIP calls

## Reserving VoIP lines

By default, all TalkSwitch VoIP lines are available for external IP extensions, TalkSwitch VoIP network calls, and/or service provider calls on a first-come first-served basis. You can also reserve VoIP lines for a specific use. For example, you can set aside two lines for external IP extensions.

Reserving VoIP lines guarantees resources for a specific network. Sharing VoIP lines uses them most efficiently.

1. Select the **VoIP Configuration** page.
2. Click **Reserve VoIP Lines**. The **VoIP Resource Reservation** window appears.

**VoIP Resource Reservation**

By default, the TalkSwitch shares VoIP resources. If you need to guarantee availability of VoIP lines for specific services, then reserve lines for these services.

VoIP Resource Reservation

Lines Reserved	
External IP extension calls:	Shared
TalkSwitch VoIP network calls:	Shared
Service provider 1 calls:	Shared
Service provider 2 calls:	Shared
Service provider 3 calls:	Shared
Service provider 4 calls:	Shared

Total VoIP lines available on system: 8  
Total VoIP lines shared: 8  
Total VoIP lines reserved: 0

OK Cancel

3. Select the number of VoIP lines to set aside for each service. Choices range from 1 to the number of unreserved VoIP lines at this location. *Shared* means no VoIP lines are reserved for this service. Only unreserved lines will be available.

## SAVING SETTINGS TO TALKSWITCH

To transfer settings from your computer to the TalkSwitch system, choose **File > Save**. A window appears indicating the configuration is being sent.

## VERIFYING REGISTRATION

Clicking the **View All Registrations** button shows a window with a list of VoIP numbers, their registration status, and the number of seconds until their registrations with the SIP server will expire. This confirms that the TalkSwitch system is registered with a SIP server.

1. Select the **VoIP Configuration** page.
2. Click **View All Registrations**. The **Registration status** window appears.
3. Choose *All Registered Numbers* or an active profile.

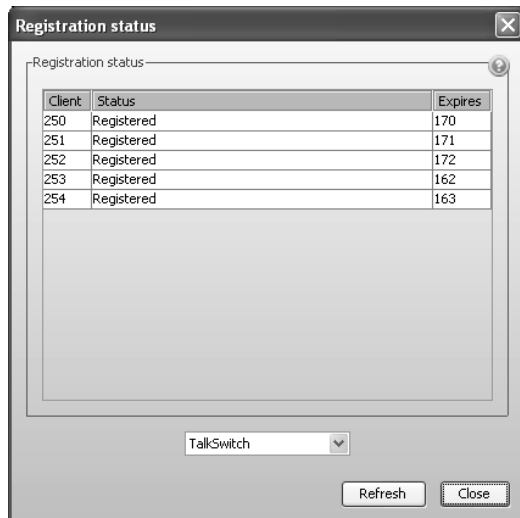

## APPENDIX A — TALKSWITCH VOIP NETWORK ADMINISTRATION FORM

Use this form to keep track of VoIP numbers assigned to locations within a TalkSwitch VoIP network.

Location of the SIP server: \_\_\_\_\_

Equipment at the SIP server location: \_\_\_\_\_

VoIP numbers assigned to the SIP server location: \_\_\_\_\_

### VoIP numbers assigned to locations

Location name	Equipment	VoIP numbers

We trust your **TalkSwitch phone system** will provide exceptional features, performance and value to your business. Should you have any further questions, please contact your authorized TalkSwitch reseller. If you purchased directly from TalkSwitch, visit [www.talkswitch.com/support](http://www.talkswitch.com/support) (United States and Canada) or <http://global.talkswitch.com>.

We welcome your feedback, comments and suggestions. Please e-mail us at [info@talkswitch.com](mailto:info@talkswitch.com) or write us at **TalkSwitch, 1545 Carling Avenue, Suite 510, Ottawa, ON Canada K1Z 8P9**.

Thank you for choosing TalkSwitch.

©TalkSwitch 2008. All Rights Reserved. CT.TS005.002606 (May 2008)

*TalkSwitch is a division of Centrepoint Technologies Inc.*

*TalkSwitch and the TalkSwitch logo are registered trademarks of Centrepoint Technologies Inc.*

## Free Manuals Download Website

<http://myh66.com>

<http://usermanuals.us>

<http://www.somanuals.com>

<http://www.4manuals.cc>

<http://www.manual-lib.com>

<http://www.404manual.com>

<http://www.luxmanual.com>

<http://aubethermostatmanual.com>

Golf course search by state

<http://golfingnear.com>

Email search by domain

<http://emailbydomain.com>

Auto manuals search

<http://auto.somanuals.com>

TV manuals search

<http://tv.somanuals.com>