

# SHARP®



IMAGE  
QUALITY

Important  
Information



Setup & Connections



Operation Buttons



Basic Operation



Multiple Function



Maintenance &  
Troubleshooting



Appendix



## OPERATION MANUAL

MODEL

# XG-P20XU

## LCD PROJECTOR

*Conference Series*



Before using the LCD projector, please read this operation manual carefully.



# Introduction

ENGLISH

## IMPORTANT

For your assistance in reporting the loss or theft of your Color LCD Projector, please record the Serial Number located on the bottom of the projector and retain this information. Before recycling the packaging, please be sure that you have checked the contents of the carton thoroughly against the list of "Supplied Accessories" on page 12.

**Model No.:** XG-P20XU

**Serial No.:**

There are two important reasons for prompt warranty registration of your new SHARP LCD Projector, using the REGISTRATION CARD packed with the projector.

### 1. WARRANTY

This is to assure that you immediately receive the full benefit of the parts, service and labor warranty applicable to your purchase.

### 2. CONSUMER PRODUCT SAFETY ACT



To ensure that you will promptly receive any safety notification of inspection, modification, or recall that SHARP may be required to give under the 1972 Consumer Product Safety Act, PLEASE READ CAREFULLY THE IMPORTANT "LIMITED WARRANTY" CLAUSE.

U.S.A. ONLY

**WARNING:** High brightness light source. Do not stare into the beam of light, or view directly. Be especially careful that children do not stare directly into the beam of light.

**WARNING:** To reduce the risk of fire or electric shock, do not expose this product to rain or moisture.

See bottom of actual set.

	<b>CAUTION</b> <b>RISK OF ELECTRIC SHOCK.</b> <b>DO NOT REMOVE SCREWS</b> <b>EXCEPT SPECIFIED USER</b> <b>SERVICE SCREW.</b>	
<b>CAUTION: TO REDUCE THE RISK OF ELECTRIC SHOCK,</b> <b>DO NOT REMOVE COVER.</b> <b>NO USER-SERVICEABLE PARTS EXCEPT LAMP UNIT.</b> <b>REFER SERVICING TO QUALIFIED SERVICE</b> <b>PERSONNEL.</b>		



The lightning flash with arrowhead symbol, within an equilateral triangle, is intended to alert the user to the presence of uninsulated "dangerous voltage" within the product's enclosure that may be of sufficient magnitude to constitute a risk or electric shock to persons.



The exclamation point within a triangle is intended to alert the user to the presence of important operating and maintenance (servicing) instructions in the literature accompanying the product.

**WARNING:** FCC Regulations state that any unauthorized changes or modifications to this equipment not expressly approved by the manufacturer could void the user's authority to operate this equipment.

U.S.A. ONLY

## INFORMATION

This equipment has been tested and found to comply with the limits for a Class A digital device, pursuant to Part 15 of the FCC Rules. These limits are designed to provide reasonable protection against harmful interference when the equipment is operated in a commercial environment. This equipment generates, uses, and can radiate radio frequency energy and, if not installed and used in accordance with the operation manual, may cause harmful interference to radio communications. Operation of this equipment in a residential area is likely to cause harmful interference, in which case the user will be required to correct the interference at his own expense.

U.S.A. ONLY

The enclosed RGB (computer) cable must be used with the device. The cable is provided to ensure that the device complies with FCC Class A verification.

U.S.A. ONLY

"Operation is subject to the following two conditions: (1) this device may not cause interference, and (2) this device must accept any interference, including interference that may cause undesired operation of the device".

CANADA ONLY

## For GyroRemote unit (RRMCG1631CESA)

This device complies with part 15 of the FCC rules. Operation is subject to the following two conditions:

- (1) This device may not cause harmful interference, and
- (2) This device must accept any interference received, including interference that may cause undesired operation.

This device operates in the frequency band of 49.82 to 49.90 MHz with RF output power of less than 30 MicroWatts EIRP (Effective Isotropic Radiated Power).

### Caution

Any changes made to this device not expressly approved by the manufacturer could void the users right to operate this device.



# IMPORTANT SAFEGUARDS



Electrical energy can perform many useful functions. This product has been engineered and manufactured to ensure your personal safety. But IMPROPER USE CAN RESULT IN POTENTIAL ELECTRICAL SHOCK OR FIRE HAZARD. In order not to defeat the safeguards incorporated into this LCD Projector, observe the following basic rules for its installation, use and servicing. For your own protection and reliable usage of your LCD Projector, please be sure to read these "IMPORTANT SAFEGUARDS" carefully before use.

## 1. Read Instructions

All the safety and operating instructions should be read before the product is operated.

## 2. Retain Instructions

The safety and operating instructions should be retained for future reference.

## 3. Heed Warnings

All warnings on the product and in the operating instructions should be adhered to.

## 4. Follow Instructions

All operating and use instructions should be followed.

## 5. Cleaning

Unplug this product from the wall outlet before cleaning. Do not use liquid cleaners or aerosol cleaners. Use a damp cloth for cleaning.

## 6. Attachments

Do not use attachments not recommended by the product manufacturer as they may cause hazards.

## 7. Water and Moisture

Do not use this product near water—for example, near a bathtub, wash bowl, kitchen sink, or laundry tub; in a wet basement; or near a swimming pool; and the like.

## 8. Accessories

Do not place this product on an unstable cart, stand, tripod, bracket, or table. The product may fall, causing serious injury to a child or adult, and serious damage to the product. Use only with a cart, stand, tripod, bracket, or table recommended by the manufacturer, or sold with the product. Any mounting of the product should follow the manufacturer's instructions, and should use a mounting accessory recommended by the manufacturer.

## 9. Transportation

A product and cart combination should be moved with care. Quick stops, excessive force, and uneven surfaces may cause the product and cart combination to overturn.



## 10. Ventilation

Slots and openings in the cabinet are provided for ventilation to ensure reliable operation of the product and to protect it from overheating. The openings should never be covered or blocked by placing the product on a bed, sofa, rug, or other similar surface. This product should not be placed in a built-in installation such as a bookcase or rack unless proper ventilation is provided or the manufacturer's instructions have been adhered to.

## 11. Power Sources

This product should be operated only from the type of power source indicated on the marking label. If you are not sure of the type of power supply to your home, consult your product dealer or local power company. For products intended to operate from battery power, or other sources, refer to the operating instructions.

## 12. Grounding or Polarization

This product is equipped with a three-wire grounding-type plug, a plug having a third (grounding) pin. This plug will only fit into a grounding-type power outlet. This is a safety feature. If you are unable to insert the plug into the outlet, contact your electrician to replace your obsolete outlet. Do not defeat the safety purpose of the grounding-type plug.

## 13. Power-Cord Protection

Power-supply cords should be routed so that they are not likely to be walked on or pinched by items placed upon or against them, paying particular attention to cords at plugs, convenience receptacles, and the point where they exit from the product.

## 14. Lightning

For added protection for this product during a lightning storm, or when it is left unattended and unused for long periods of time, unplug it from the wall outlet and disconnect the cable system. This will prevent damage to the product due to lightning and power-line surges.

## 15. Overloading

Do not overload wall outlets, extension cords, or integral convenience receptacles as this can result in a risk of fire or electric shock.

## 16. Object and Liquid Entry

Never push objects of any kind into this product through openings as they may touch dangerous voltage points or short-out parts that could result in a fire or electric shock. Never spill liquid of any kind on the product.

## 17. Servicing

Do not attempt to service this product yourself as opening or removing covers may expose you to dangerous voltage or other hazards. Refer all servicing to qualified service personnel.

## 18. Damage Requiring Service

Unplug this product from the wall outlet and refer servicing to qualified service personnel under the following conditions:

- If the power-supply cord or plug is damaged.
- If liquid has been spilled, or objects have fallen into the product.
- If the product has been exposed to rain or water.
- If the product does not operate normally by following the operating instructions. Adjust only those controls that are covered by the operating instructions, as an improper adjustment of other controls may result in damage and will often require extensive work by a qualified technician to restore the product to normal operation.
- If the product has been dropped or damaged in any way.
- If the product exhibits a distinct change in performance, this indicates a need for service.

## 19. Replacement Parts

When replacement parts are required, be sure the service technician has used replacement parts specified by the manufacturer or with the same characteristics as the original part. Unauthorized substitutions may result in fire, electric shock, or other hazards.

## 20. Safety Check

Upon completion of any service or repairs to this product, ask the service technician to perform safety checks to determine that the product is in proper operating condition.

## 21. Wall or Ceiling Mounting

This product should be mounted to a wall or ceiling only as recommended by the manufacturer.

## 22. Heat

This product should be situated away from heat sources such as radiators, heat registers, stoves, or other products (including amplifiers) that produce heat.



## IMPORTANT SAFEGUARDS

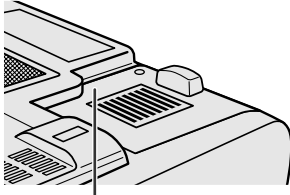

### LAMP REPLACEMENT CAUTION

BEFORE REMOVING THE SCREW, DISCONNECT POWER CORD. HOT SURFACE INSIDE. ALLOW 1 HOUR TO COOL BEFORE REPLACING THE LAMP. REPLACE WITH SAME SHARP LAMP UNIT TYPE BQC-XGP20X/1 ONLY. UV RADIATION : CAN CAUSE EYE DAMAGE. TURN OFF LAMP BEFORE SERVICING. MEDIUM PRESSURE LAMP : RISK OF EXPLOSION. POTENTIAL HAZARD OF GLASS PARTICLES IF LAMP HAS RUPTURED. HANDLE WITH CARE. SEE OPERATION MANUAL.

## Caution Concerning the Lamp Replacement

See "Replacing the Lamp" on pages [68](#) and [69](#).

### PRODUCT DISPOSAL

This product utilizes tin-lead solder, and high intensity discharge lamp (HID lamp) containing a small amount of mercury. Disposal of these materials may be regulated due to environmental considerations. For disposal or recycling information, please contact your local authorities or the Electronics Industries Alliance: [www.eiae.org](http://www.eiae.org).

## Caution Concerning the Lamp Unit

Potential hazard of glass particles if lamp ruptures. In case of lamp rupture, contact your nearest Authorized Sharp Industrial LCD Products Dealer or Service Center for a replacement.

See "Replacing the Lamp" on pages [68](#) and [69](#).

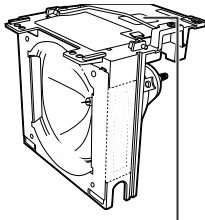

高温注意  
CAUTION  
PRECAUCIÓN  
PRÉCAUCIÓN



## Cautions Concerning the Setup of the Projector

For minimal servicing and to maintain high image quality, SHARP recommends that this projector be installed in an area free from humidity, dust and cigarette smoke. When the projector is subjected to these environments, the lens must be cleaned more often. As long as the projector is properly maintained in this manner, use in these environments will not reduce the overall operation life. Please note that all internal cleaning must be performed by an Authorized Sharp Industrial LCD Products Dealer or Service Center.

## Notes on Operation

- The exhaust vent, the lamp cage cover and adjacent areas may be extremely hot during projector operation. To prevent injury, do not touch these areas until they have sufficiently cooled.
- Allow at least 4 inches (10 cm) of space between the exhaust vent and the nearest wall or obstruction.
- If the cooling fan becomes obstructed, a protection device will automatically turn off the projector lamp. This does not indicate a malfunction. Remove the projector power cord from the wall outlet and wait at least 10 minutes. Then turn on the power by plugging the power cord back in. This will return the projector to the normal operating condition.





## IMPORTANT SAFEGUARDS



### Temperature Monitor Function

If the projector starts to overheat due to setup problems or a dirty air filter, "TEMP." and "X" will flash in the lower-left corner of the picture. If the temperature continues to rise, the lamp will turn off, the TEMPERATURE WARNING indicator on the projector will flash, and after a 90-second cooling-off period the power will shut off. Refer to "Lamp/Maintenance Indicators" on page 67, for details.

#### NOTE

- The cooling fan regulates the internal temperature, and its performance is automatically controlled. The sound of the fan may change during projector operation due to changes in the fan speed.

### Using the Carrying Handle

When transporting the projector, carry it by the carrying handle on the side.

#### CAUTION

- Always put on the lens cap to prevent damage to the lens when transporting the projector.
- Do not lift or carry the projector by the lens or the lens cap as this may damage the lens.

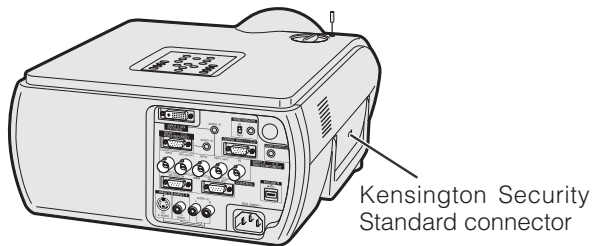
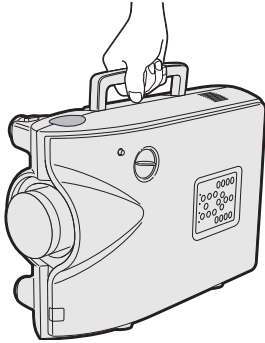

### Using the Kensington Lock

This projector has a Kensington Security Standard connector for use with a Kensington MicroSaver Security System. Refer to the information that came with the system for instructions on how to use it to secure the projector.



## Outstanding Features

### 1. High-end LCD Projector with Ultra High Brightness

- **AC 220 W Lamp**

Use AC 220 W lamp for excellent color uniformity and ultra high brightness.

### 2. Computer Compatibility

- **Compatible with resolutions including VGA-SVGA (expanded), XGA (true resolution) and SXGA-UXGA (compressed) as well as DTV formats (480i, 480P, 720P and 1080i).**

### 3. XGA Image Quality

- **OCS LCD panel enhances color uniformity.**
- **Various other circuits are also used to provide high quality video images.**

### 4. Computer & Video Integrated Composer Technology

- **New Progressive Mode**

I/P conversion with new algorithm used to achieve beautiful image quality.

- **Enhanced Up-scaling and Digital Image Enlargement**

Enables sharper image quality without jaggies even for enlarged images.

- **Superior 16:9 Image**

4:3 images can be converted to 16:9 images using Smart Stretch (sides stretched, center untouched), previously not achievable with LCD projectors.

- **Intelligent Digital Keystone Correction**

Smooths out jaggies on keystone images and compresses the image not only horizontally but vertically keeping the 4 : 3 aspect ratio, and at the same time, calculates the aspect ratio automatically adjusting to the lens shift width.

- **New Intelligent Compression**

Efficiently compresses UXGA (1,600 × 1,200) images to XGA (1,024 × 768).

- **Enhanced three-two pull down**

Converts cinema mode DVD images transformed with three-two pull down enhancement to progressive mode images for easier viewing by Film Mode.

- **Dynamic GAMMA Correction**

Optimizing GAMMA correction frame by frame in real time.

### 5. 3D Digital Uniformity and Digital Convergence

- **Three-Dimensional Digital Uniformity compensates uneven picture brightness even for pictures at any brightness level from white to dark. And, with Digital Convergence, a slight distortion of convergence can be adjusted on the service menu screen without having to touch the LCD panel.**

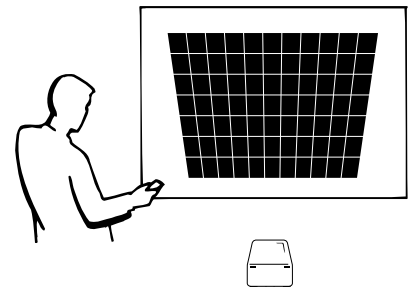



## 6. Network Capability

### • Self-Diagnosis/Projector Status

Self-diagnosis/Projector status function sends e-mail messages to a specified computer about lamp usage time and any malfunctions.

### • Multiple & Group Projector Control

Up to 250 projectors can be controlled over a network. Projector RS-232C OUT can be used for daisy chain connection.

### • Simple Stacking and Videowall Display

Comes with software for easy stacking and videowall processing even for input from a single source.

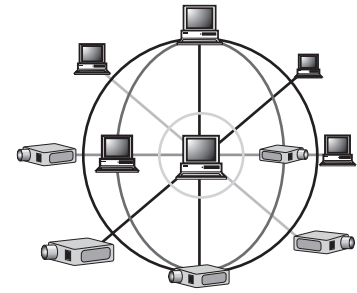

## 7. Four Optional Lenses for Maximum Flexibility

- Bayonet mount type: Wide-Zoom Lens, Tele-Zoom Lens
- Screw mount type: Fixed Wide Lens, Tele-Zoom Lens

## 8. Multiple Input and Output Terminals

- BNC Terminal for RGB/Component/Video Signal
- PC Digital Input (DVI)
- Output terminal with VAO (variable audio output) support

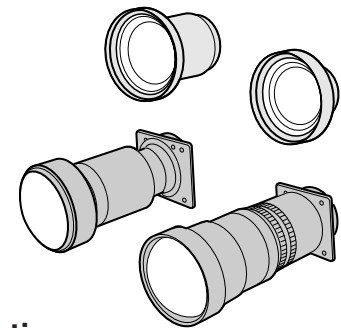

## 9. Easy Setup

- Lens Shift, Power Zoom & Focus, Digital Keystone Correction
- High Speed Auto Sync Technology

## 10. Advanced Presentation Features incorporating a unique gyro device for “in-air” remote control

- An intuitive presentation tool with an easy-to-see screen pointer.
- Raising the bar for roaming interaction with a wireless, RF (nondirectional) design that erases out-of-sight worries. Loaded with USB mouse control.

## 11. Useful Features

- Picture-in-Picture, Digital Enlargement, Freeze
- Customizable Startup Screen & Background Screen

## 12. Application Software

- “Sharp Advanced Presentation Software—Professional Edition” (Network and Remote Control)

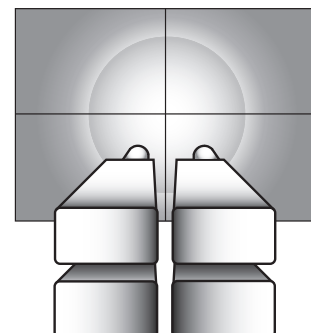
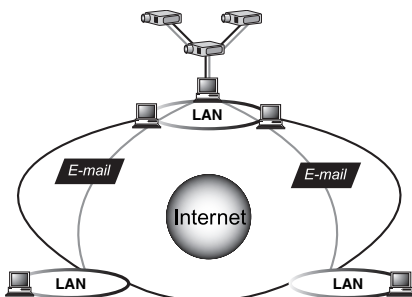



# Contents



## Important Information

<b>Introduction</b> .....	<b>1</b>
<b>IMPORTANT SAFEGUARDS</b> .....	<b>2</b>
<b>Outstanding Features</b> .....	<b>5</b>
<b>Contents</b> .....	<b>7</b>
<b>How to Access the PDF Operation Manuals</b> .....	<b>9</b>
<b>Part Names</b> .....	<b>10</b>
<b>Accessories</b> .....	<b>12</b>



## Setup & Connections

<b>Connections</b> .....	<b>13</b>
Power Supply .....	<b>13</b>
Projecting Computer Images .....	<b>14</b>
Watching Video Images .....	<b>17</b>
Watching Component Video Images .....	<b>18</b>
For Better Sound .....	<b>18</b>
Power ON/OFF .....	<b>19</b>
<b>Setting Up the Screen</b> .....	<b>20</b>
Using the Adjustment Feet .....	<b>20</b>
Using the Lens Shift .....	<b>20</b>
LENS Button .....	<b>21</b>
Adjusting the Projection Distance .....	<b>22</b>
<b>Image Projection</b> .....	<b>29</b>
Rear Projection .....	<b>29</b>
Projection Using a Mirror .....	<b>29</b>
Ceiling-mount Projection .....	<b>29</b>



## Operation Buttons

<b>Introducing GyroRemote</b> .....	<b>30</b>
GyroRemote Features .....	<b>30</b>
Using GyroRemote .....	<b>32</b>
Setting up GyroRemote .....	<b>36</b>
<b>Using the Operation Buttons</b> .....	<b>39</b>
Selecting the Input Signal Source .....	<b>39</b>
Adjusting the Volume .....	<b>39</b>
Muting the Sound .....	<b>39</b>
Superimposing a Black Screen .....	<b>40</b>
Displaying a Still Image .....	<b>40</b>
Magnifying a Specific Portion of an Image .....	<b>41</b>
Adjusting the Picture Aspect Ratio .....	<b>42</b>
Gamma Correction Function .....	<b>43</b>





# Contents



## Basic Operation

<b>Using the GUI (Graphical User Interface) Menu Screen .....</b>	<b>44</b>
Basic Operations .....	44
Menu Bars .....	45
Adjusting the Picture .....	47
Adjusting the Computer Images (RGB menu only) .....	49
Adjusting the Sound .....	52
Displaying Dual Pictures (RGB menu only) .....	53
Reducing Image Noise (VIDEO menu only) .....	53
Turning On/Off the On-screen Display ...	54
Setting the Video Signal (VIDEO menu only) .....	54
Selecting a Background Image .....	55
Selecting a Startup Image .....	55
Selecting the Economy Mode .....	56
Confirming the Lamp Usage Time .....	57
Reversing/Inverting Projected Images ...	57
Setting the Stacking Mode .....	58
Locking the Operation Buttons on the Projector .....	58
Deselecting Inputs .....	59
Selecting the Transmission Speed (RS-232C) .....	59
Controlling Multiple Projectors with ID Numbers .....	60
Protecting Important Settings with a Password .....	61
Selecting the On-screen Display Language .....	62
Displaying the Adjustment Settings .....	62



## Multiple Function

<b>Using Extended Functionality Features .....</b>	<b>63</b>
--	-----------



## Maintenance & Troubleshooting

<b>Lamp/Maintenance Indicators .....</b>	<b>67</b>
<b>Replacing the Lamp .....</b>	<b>68</b>
<b>Replacing the Air Filter .....</b>	<b>70</b>
<b>Troubleshooting .....</b>	<b>71</b>
<b>For SHARP Assistance (U.S.A. only) ..</b>	<b>71</b>



## Appendix

<b>Connecting Pin Assignments .....</b>	<b>72</b>
<b>(RS-232C) Specifications and Command Settings .....</b>	<b>73</b>
<b>Wired Remote Control Terminal Specifications .....</b>	<b>76</b>
<b>Computer Compatibility Chart .....</b>	<b>77</b>
<b>Dimensions .....</b>	<b>78</b>
<b>Specifications .....</b>	<b>79</b>
<b>Glossary .....</b>	<b>80</b>
<b>Index .....</b>	<b>81</b>





# How to Access the PDF Operation Manuals

PDF operation manuals in several languages are included in the CD-ROM. To utilize these manuals, you need to install Adobe Acrobat Reader on your PC (Windows or Macintosh). If you have not installed Acrobat Reader yet, you can download it from the Internet (<http://www.adobe.com>) or install it from the CD-ROM.

## To Install Acrobat Reader from the CD-ROM

### For Windows:

- ① Insert the CD-ROM in the CD-ROM drive.
- ② Double click on the "My Computer" icon.
- ③ Double click on the "CD-ROM" drive.
- ④ Double click on the "acrobat" folder.
- ⑤ Double click on the "windows" folder.
- ⑥ Double click on the desired installation program and follow the instructions on the screen.

### For Macintosh:

- ① Insert the CD-ROM in the CD-ROM drive.
- ② Double click on the "CD-ROM" icon.
- ③ Double click on the "acrobat" folder.
- ④ Double click on the "mac" folder.
- ⑤ Double click on the desired installation program and follow the instructions on the screen.

### For other operating systems:

Please download Acrobat Reader from the Internet (<http://www.adobe.com>).

### For other languages:

If you prefer using Acrobat Reader for languages other than those included in the CD-ROM, please download the appropriate version from the Internet.

## Accessing the PDF Manuals

### For Windows:

- ① Insert the CD-ROM in the CD-ROM drive.
- ② Double click on the "My Computer" icon.
- ③ Double click on the "CD-ROM" drive.
- ④ Double click on the "manuals" folder.
- ⑤ Double click on the "xg-p20xu" folder.
- ⑥ Double click on the language (name of the folder) that you want to view.
- ⑦ Double click on the "p20x" pdf file to access the projector manuals.  
Double click on the "saps" pdf file to access the Sharp Advanced Presentation Software manual.
- ⑧ Double click on the pdf file.

### For Macintosh:

- ① Insert the CD-ROM in the CD-ROM drive.
- ② Double click on the "CD-ROM" icon.
- ③ Double click on the "manuals" folder.
- ④ Double click on the "xg-p20xu" folder.
- ⑤ Double click on the language (name of the folder) that you want to view.
- ⑥ Double click on the "p20x" pdf file to access the projector manuals.  
Double click on the "saps" pdf file to access the Sharp Advanced Presentation Software manual.
- ⑦ Double click on the pdf file.

### NOTE

- If the desired pdf file cannot be opened by double clicking the mouse, start Acrobat Reader first, then specify the desired file using the "File", "Open" menu.
- See the "readme.txt" file on the CD-ROM for important information on the CD-ROM not included in this operation manual.



# Part Names



Numbers next to the part names refer to the main pages in this manual where the topic is explained.

## Projector

### Front View

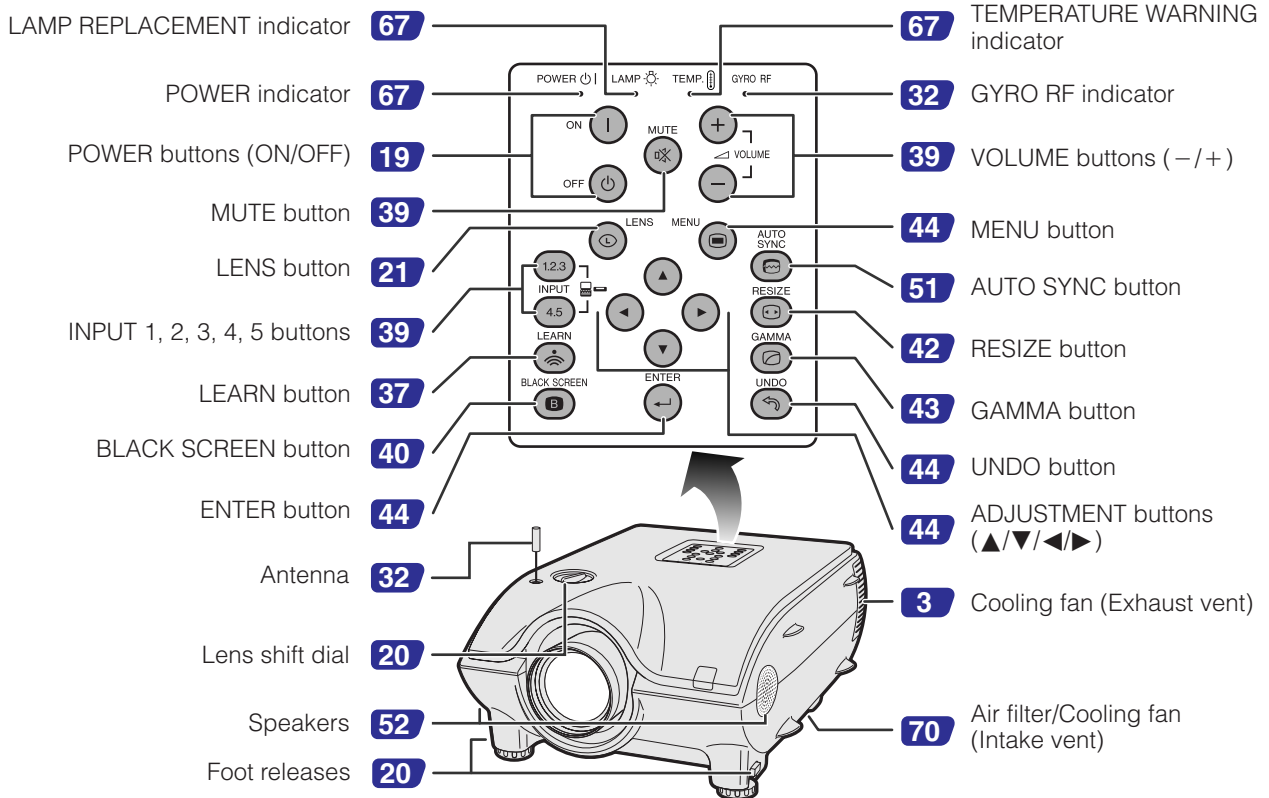

### Rear View

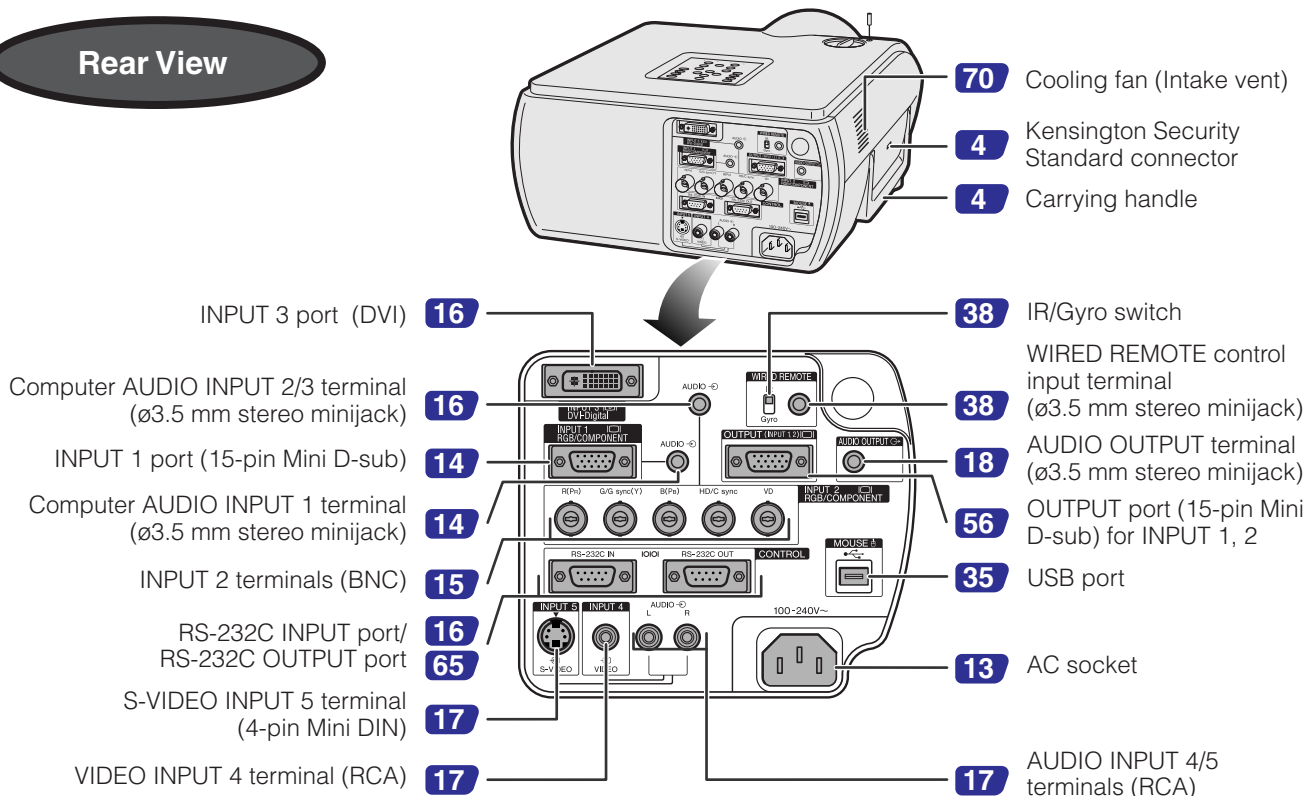



# Part Names

Numbers next to the part names refer to the main pages in this manual where the topic is explained.

## GyroRemote

Front View

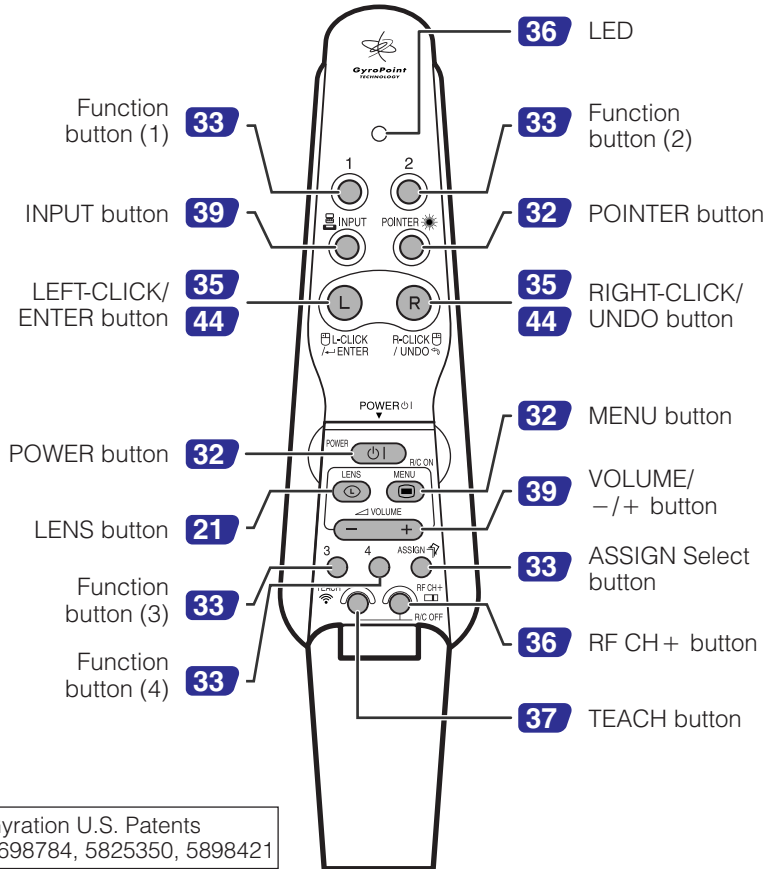

Gyration U.S. Patents  
5698784, 5825350, 5898421

Rear View

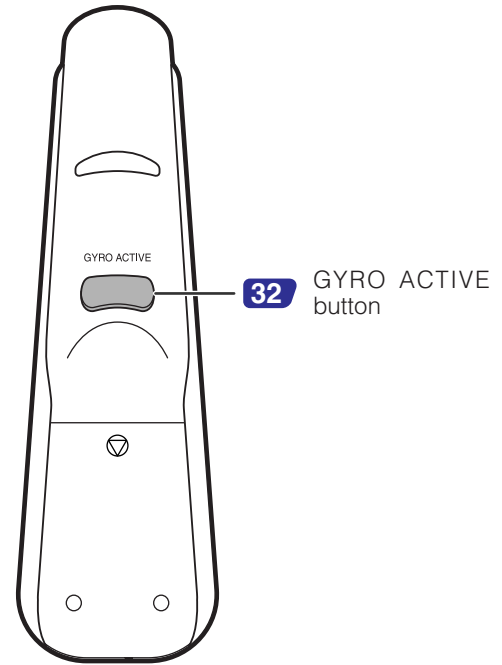

Bottom View



## Inserting and removing the batteries

Batteries are not pre-installed at the factory. When inserting batteries for the first time, follow steps 1, 3 and 4 below.

<p><b>1</b> Press in on the arrow mark and slide in the direction of the arrow to remove the battery cover.</p>	<p><b>2</b> Remove the two upper batteries and pull the tapes to pick up two other batteries at the bottom of the compartment.</p>	<p><b>3</b> Insert four AAA size batteries, making sure the polarities match the + and - marks inside the battery compartment and the batteries are placed on the tapes.</p>	<p><b>4</b> Insert the side tabs of the battery cover into the slots and press the cover in until it is properly seated.</p>
<p>Battery cover</p>	<p>Battery compartment</p>		<p>Battery cover</p>



# Accessories



## Supplied Accessories

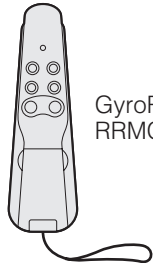

GyroRemote  
RRMCG1631CESA



Four AAA size batteries

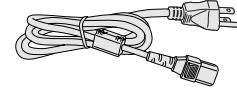

Power cord  
QACCU5013DE01

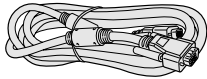

RGB cable  
QCNW-5304CEZZ

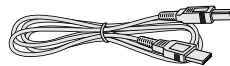

USB mouse control cable  
QCNW-5916CEZZ

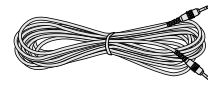

Computer audio cable  
(ø3.5 mm stereo minijack cable)  
QCNW-4870CEZZ

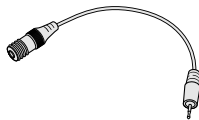

ø2.5-ø3.5 mm wired remote  
control cable  
QCNW-5943CEZZ



Three BNC-RCA adaptors  
QPLGJ0107GEZZ

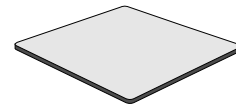

Extra air filter  
PFILD0080CEZZ



Lens cap  
PCAPH1056CESA

CD-ROM  
UDSKA0043CEN1

LCD projector operation manual  
TINS-7354CEZZ

LCD projector quick guide  
TINS-7355CEZZ

Sharp Advanced Presentation  
Software operation manual  
TINS-7356CEZZ

ID number seal  
TLABZ0781CEZZ

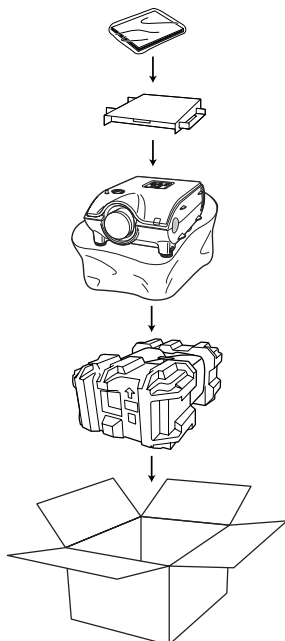

## Optional cables

DVI cable (9' 10", 3 m)  
AN-C3DV

3RCA to 15pin D-sub cable (9' 10", 3 m)  
AN-C3CP

5BNC to 15pin D-sub cable (9' 10", 3 m)  
AN-C3BN

RS-232C serial control cable (32' 10", 10 m)  
AN-C10RS



# Connections



## Power Supply

### Connecting the Power Cord

Plug the supplied power cord into the AC socket on the rear of the projector.

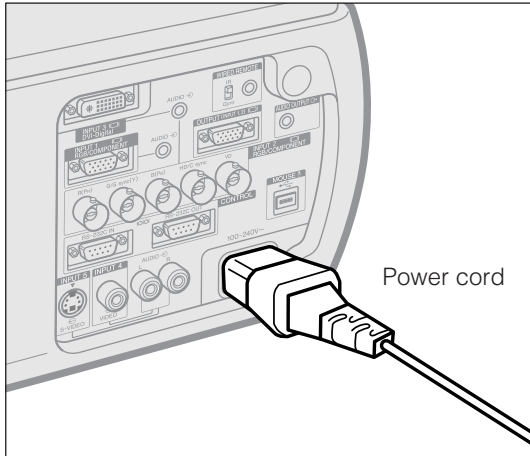

Make the necessary connections before proceeding. Connect the power cord to a wall outlet. The POWER indicator lights up red and the projector enters standby mode.

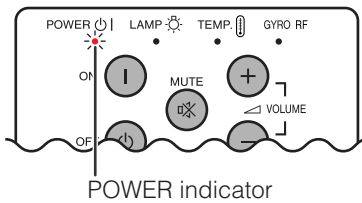

#### NOTE

- If the bottom filter cover is not securely installed, the POWER indicator flashes.





# Projecting Computer Images

## Connecting the Projector to a Computer

You can connect your projector to a computer for projection of full color computer images.

### Connecting to a computer using the standard 15-pin Input

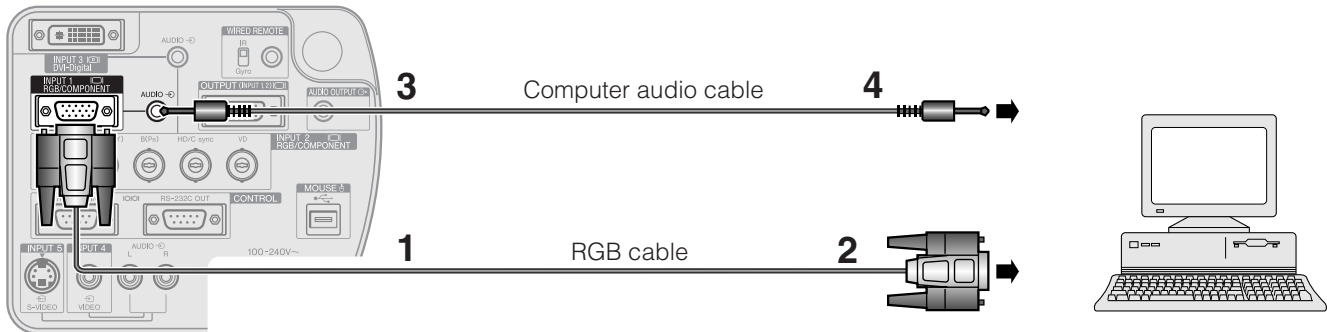

- 1 Connect one end of the supplied RGB cable to the INPUT 1 port on the projector.
- 2 Connect the other end to the monitor output port on the computer. Secure the connectors by tightening the thumb screws.
- 3 To use the built-in audio system, connect one end of the supplied computer audio cable to the AUDIO INPUT 1 terminal on the projector.
- 4 Connect the other end to the audio output terminal on the computer.

#### **CAUTION**

- Before connecting, be sure to turn both the projector and the computer off. After making all connections, turn the projector on first. The computer should always be turned on last.

#### **NOTE**

- Please read the computer's operation manual carefully before making connections.
- Refer to page [77](#) "Computer Compatibility Chart" for a list of computer signals compatible with the projector. Use with computer signals other than those listed may cause some of the functions not to work.
- A  $\varnothing 3.5$  mm stereo minijack to stereo RCA audio cable adaptor may be necessary.

When connecting this projector to a computer, select "RGB" for "Signal Type" on the GUI menu. (See page [47](#).)

#### **NOTE**

- A Macintosh adaptor may be required for use with some Macintosh computers. Contact your nearest Authorized Sharp Industrial LCD Products Dealer or Service Center.
- AUDIO INPUT 1 can be used to input audio corresponding to the INPUT 1.



## Projecting Computer Images

- This projector uses a 5 BNC computer input to prevent deterioration of image quality.
- Connect the R (P<sub>R</sub>), G/G sync (Y), B (P<sub>B</sub>), HD/C sync and VD cables (sold separately) to the correct input terminals on the projector and an RGB switcher (sold separately) connected to the computer, or connect a 5 BNC cable (sold separately) directly from the input terminals on the projector to the computer.

### Connecting to an external RGB switcher or other compatible computers using the BNC Input (Typically used in larger installations)

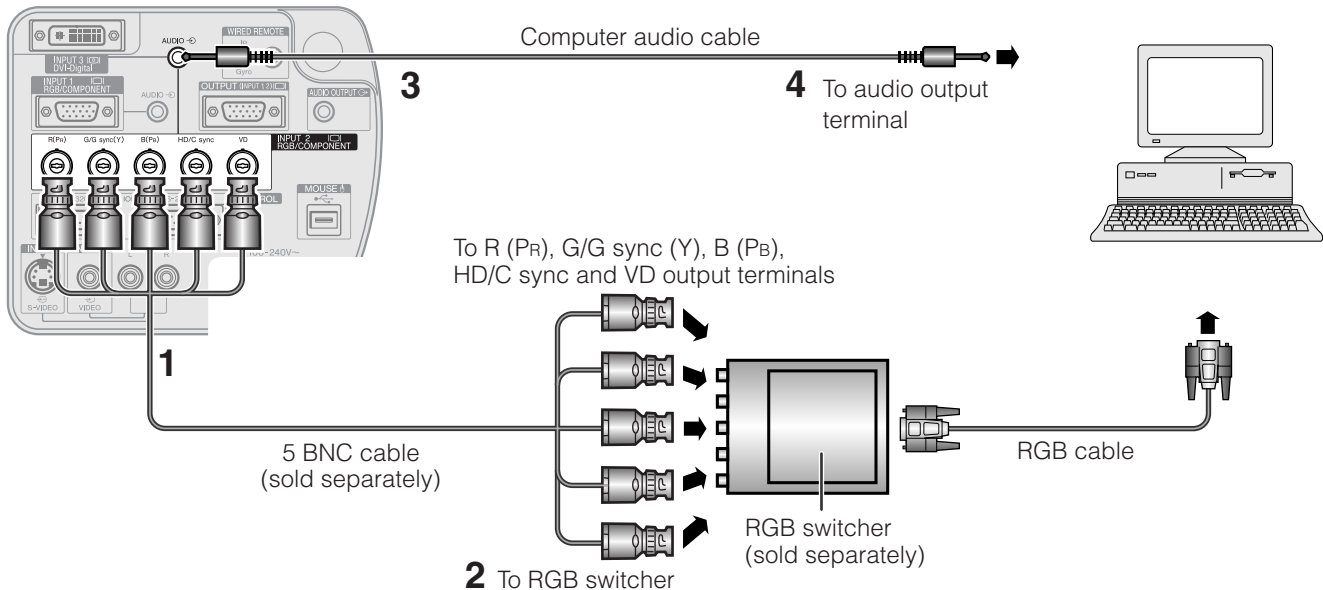

- 1 Connect each BNC connector of a 5 BNC cable to the corresponding INPUT 2 terminals on the projector.
- 2 Connect the other end of the 5 BNC cable to the corresponding BNC terminals on the external RGB switcher. Connect the RGB switcher to the computer using a RGB cable.
- 3 To use the built-in audio system, connect one end of the supplied computer audio cable to the AUDIO INPUT 2/3 terminal on the projector.
- 4 Connect the other end to the audio output terminal on the computer or external audio system.

#### NOTE

- A  $\varnothing 3.5$  mm stereo minijack to stereo RCA audio cable adaptor may be necessary.

When connecting the projector to a compatible computer other than a PC (VGA/SVGA/XGA/SXGA/UXGA) or Macintosh (i.e. Workstation), a separate cable may be needed. Please contact your dealer for more information.

When connecting this projector to a computer, select "RGB" for "Signal Type" on the GUI menu. (See page 47.)

#### NOTE

- Connecting computers other than the recommended types may result in damage to the projector, the computer, or both.
- AUDIO INPUT 2/3 can be used to input audio corresponding to the INPUT 2/3.

### "Plug and Play" function (when connecting to a 15-pin terminal)

- This projector is compatible with VESA-standard DDC 1/DDC 2B. The projector and a VESA DDC compatible computer will communicate their setting requirements, allowing for quick and easy setup.
- Before using the "Plug and Play" function, be sure to turn on the projector first and the connected computer last.

#### NOTE

- The DDC "Plug and Play" function of this projector operates only when used in conjunction with a VESA DDC compatible computer.





## Connecting to a computer using the RS-232C Port

When the RS-232C port on the projector is connected to a computer with an RS-232C cable (null modem, cross type, sold separately), the computer can be used to control the projector and check the status of the projector. See pages **73**, **74** and **75** for details.

**Connect an RS-232C cable (null modem, cross type, sold separately) to the serial port on the computer.**

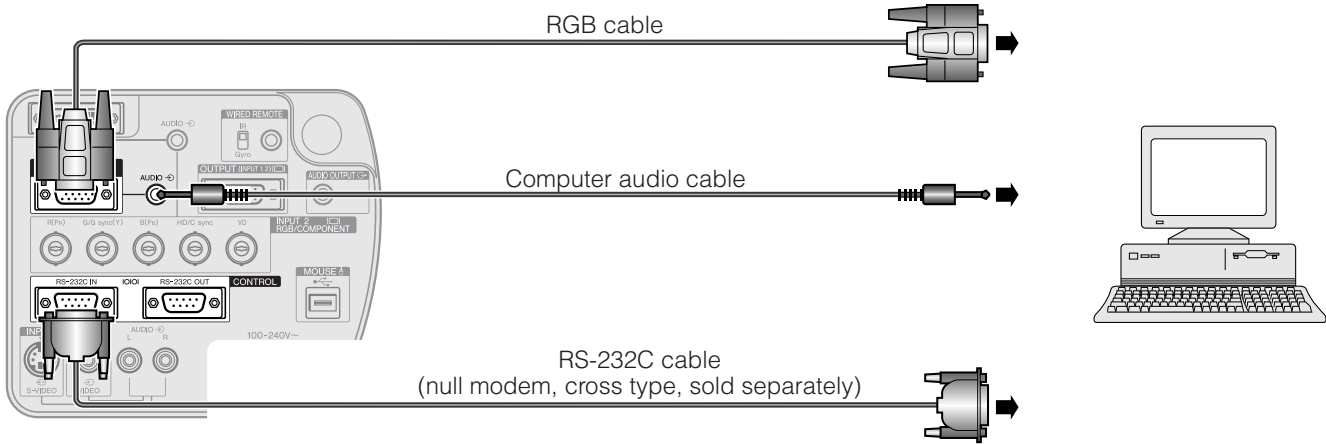

### CAUTION

- Do not connect or disconnect an RS-232C cable to or from the computer while it is on. This may damage your computer.

### NOTE

- The wireless mouse or RS-232C function may not operate if your computer port is not correctly set up. Please refer to the operation manual of the computer for details on setting up/installing the correct mouse driver.
- A Macintosh adaptor may be required for use with some Macintosh computers. Contact your nearest Authorized Sharp Industrial LCD Products Dealer or Service Center.

## Connecting to a computer using the direct digital input port

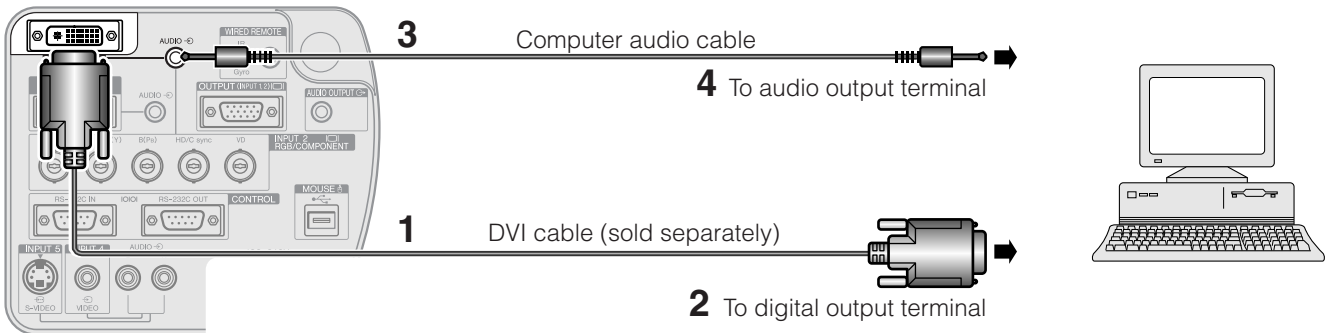

- Connect one end of the DVI cable to the INPUT 3 port on the projector.
- Connect the other end to the corresponding terminal on a computer.
- To use the built-in audio system, connect one end of the supplied computer audio cable to the AUDIO INPUT 2/3 terminal on the projector.
- Connect the other end to the audio output terminal on the computer.

### NOTE

- This DVI port is DVI version 1.0 compatible. Therefore when the signal is input from copy guard system compatible (DVI version 2.0) equipment, no signal will be received.



# Watching Video Images

## Connecting to a VCR, laser disc player and other audiovisual equipment using the standard video Input

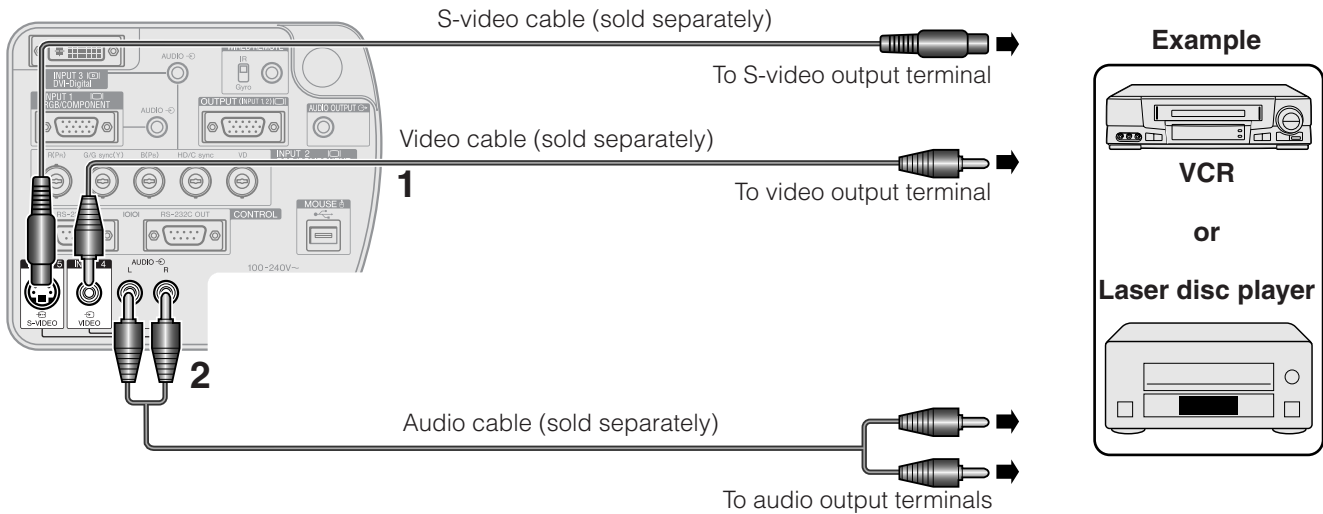

- 1 Connect the yellow RCA connectors to the corresponding yellow VIDEO INPUT 4 terminal on the projector and the Video output terminal on the video source.
- 2 To use the built-in audio system, connect the red and white RCA connectors to the corresponding red and white AUDIO INPUT 4/5 terminals on the projector and the Audio output terminals on the video source.

The S-VIDEO INPUT 5 terminal uses a video signal system in which the picture is separated into a color and a luminance signal to realize a higher-quality image.

### NOTE

- For higher quality video, you may use the S-VIDEO INPUT 5 terminal on the projector. S-video cable is sold separately.
- If your video equipment does not have an S-video output terminal, use a composite video cable.

### CAUTION

- Always turn off the projector before connecting to video equipment, in order to protect both the projector and the equipment being connected.



# Watching Component Video Images

## Connecting to a DVD video player, DTV decoder and other component video equipment using the 5 BNC Input

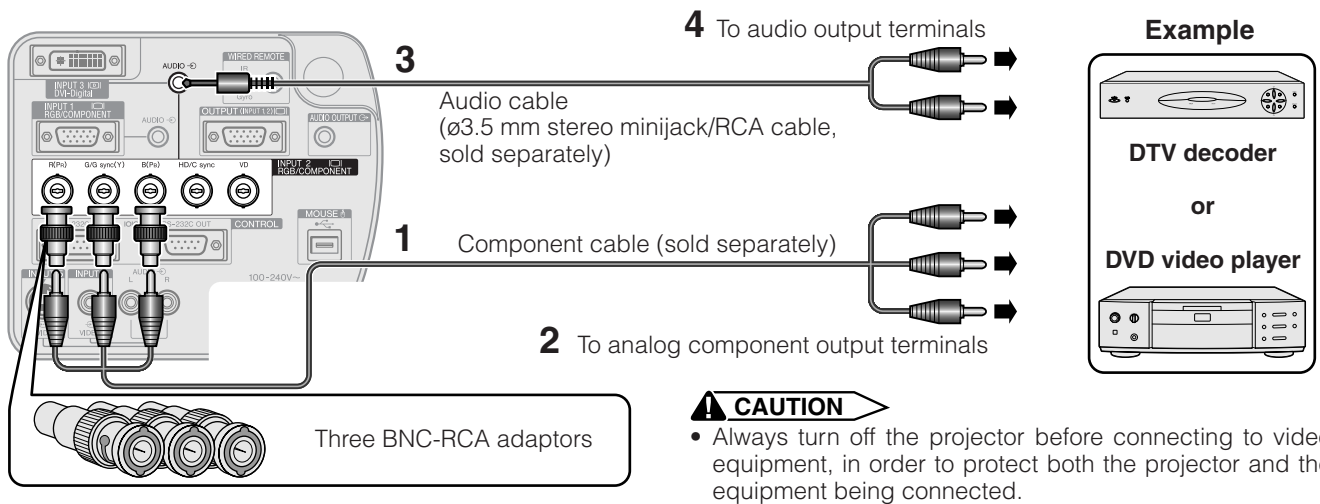

- 1 Connect each BNC connector of a component cable to the corresponding BNC INPUT 2 terminals on the projector.
- 2 Connect the other end of the cable to the corresponding terminals on a DVD video player or DTV decoder.
- 3 To use the built-in audio system, connect one end of an audio cable (sold separately) to the AUDIO INPUT 2/3 terminal on the projector.
- 4 Connect the other end to the audio output terminal on the DVD video player or DTV decoder.

### NOTE

- BNC-RCA adaptors are included for use with RCA type cables and sources.
- A ø3.5 mm stereo minijack to stereo RCA audio cable adaptor may be necessary.

When connecting this projector to a DVD video player or DTV decoder, select "Component" for "Signal Type" on the GUI menu. (See page 47.)



# For Better Sound

## Connecting to an amplifier and other audio components

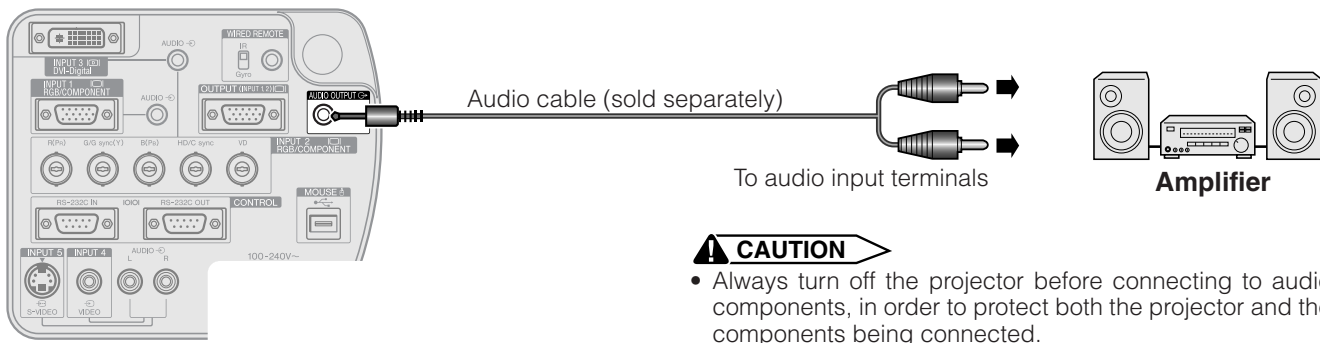

### NOTE

- By using external audio components, the volume can be amplified for better sound.
- The AUDIO OUTPUT terminal allow you to output audio to audio components from the selected AUDIO INPUT 1 to 5 terminals connected to audiovisual equipment.
- For details on Variable Audio Output (VAO) and Fixed Audio Output (FAO), see page 52.
- A ø3.5 mm stereo minijack to stereo RCA audio cable adaptor may be necessary.



# Power ON/OFF

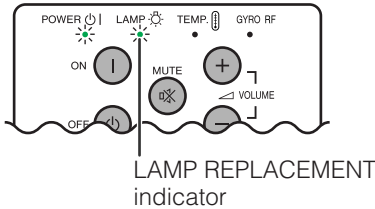
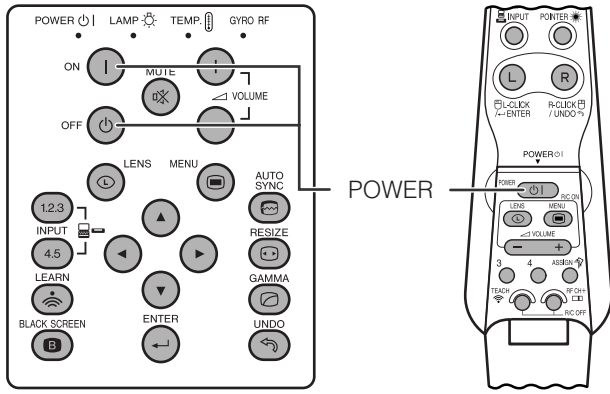

## On-screen Display

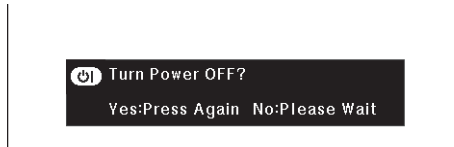

Press **POWER ON** on the projector or **POWER** on the GyroRemote.

- The flashing green LAMP REPLACEMENT indicator shows that the lamp is warming up. Wait until the indicator stops flashing before operating the projector.
- If the power is turned off and then immediately turned on again, it may take a short while before the lamp turns on.

### NOTE

- When the projector cannot recognize GyroRemote, an on-screen display appears. Follow the instructions to activate control.
- After the projector is unpacked and turned on for the first time, a slight odor may be emitted from the exhaust vent. This odor will soon disappear with use.

When the power is on, the LAMP REPLACEMENT indicator lights, indicating the status of the lamp.

- Green:** Lamp is ready.
- Flashing green:** Warming up.
- Red:** Change the lamp.

Press **POWER OFF** on the projector or **POWER** on the GyroRemote.

Press **POWER OFF/POWER** again while the message is displayed.

### NOTE

- If you accidentally pressed **POWER OFF/POWER** and do not want to turn off the power, wait until the power off screen disappears.
- When the power is turned off, the POWER indicator will light up red and the cooling fan will run for about 90 seconds. The projector will then enter standby mode.
- Wait until the cooling fan stops before disconnecting the power cord.
- The power can be turned on again by pressing **POWER ON/POWER**. When the power is turned on, the POWER indicator and the LAMP REPLACEMENT indicator light green.
- The POWER indicator flashes if the bottom filter cover is not securely installed.



# Setting Up the Screen



## Using the Adjustment Feet

1

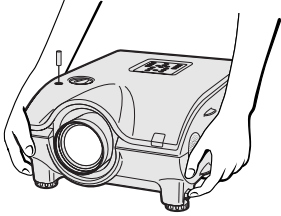

Press foot releases.

2

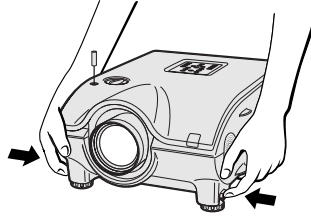

Adjust height of projector and remove hands from foot releases.

3

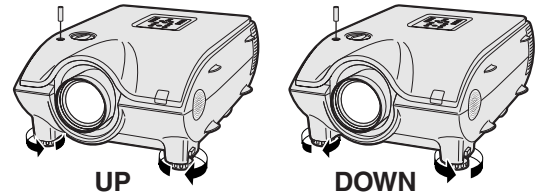

Rotate feet to make minor changes.

### NOTE

- The projector is adjustable up to approximately 10° from the standard position.
- When the height of the projector is adjusted, the image may become distorted (keystoned), depending on the relative positions of the projector and the screen.

### CAUTION

- Do not press the foot releases when the adjustment feet are extended without firmly holding the projector.
- Do not hold the lens when lifting or lowering the projector.
- When lowering the projector, be careful not to get your fingers caught in the area between the adjustment feet and the projector.



## Using the Lens Shift

The picture can be adjusted within the shift range of the lens by rotating the dial on the top of the projector.

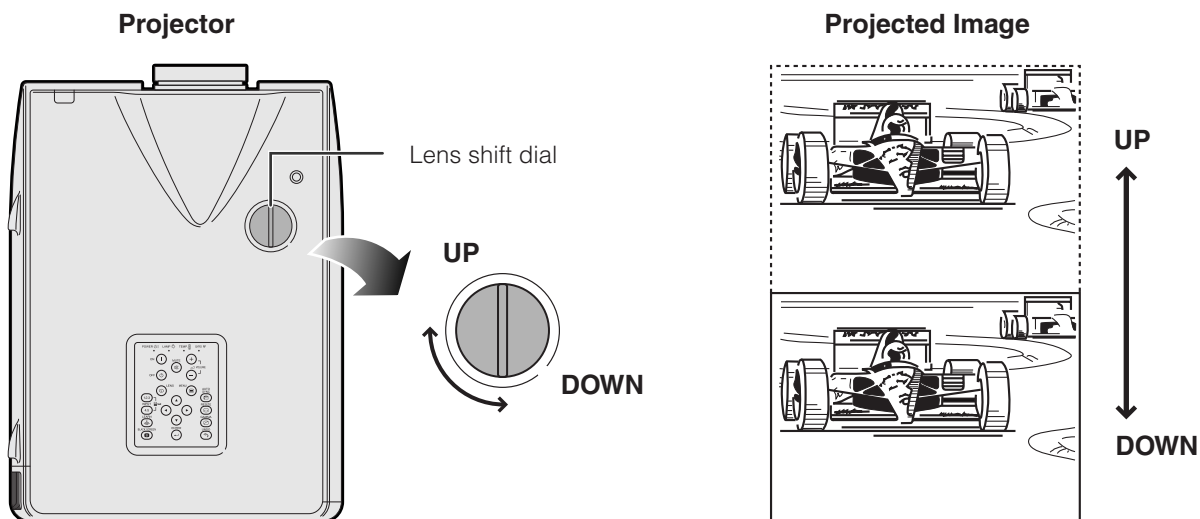

### NOTE

- The lens shift dial is set to the upper most position at the factory. Remember to adjust lower by turning the dial when operating the projector.
- The lens shift dial has two points to help orient the position. The center of the lens and bottom of the screen are the same height (10:0) and the center of the lens and center of the screen are the same height (5:5). When either position is reached by turning the dial, you will notice a slight latching feeling.
- Do not forcefully turn the lens shift dial beyond the 10:0 and 5:5 orientating positions; doing so may result in damaging the equipment.
- When the AN-P9MX of optional lens is attached, lens shift cannot be used.





# LENS Button

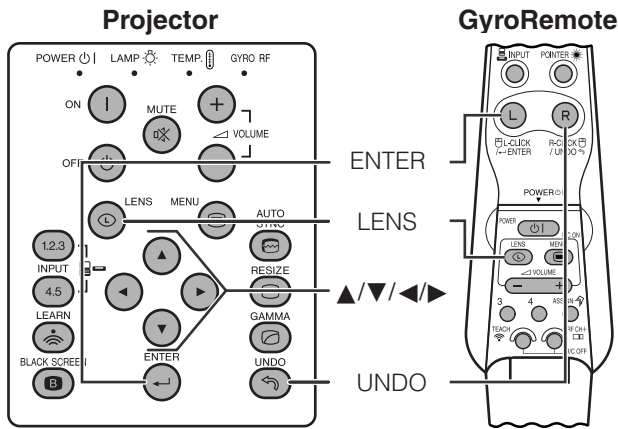

## Digital Image Adjustments

This function can be used to adjust the focus, zoom, keystone, v-size and digital shift settings.

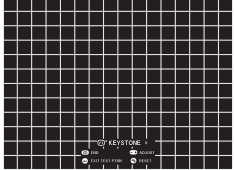
- 1 Press **LENS** to select mode. Each time **LENS** is pressed, the screen changes as shown on the left.
- 2 Press **ENTER** to display test pattern. 
- 3 Press **▲/▼/◀/▶** to make adjustments. (Press **-/+** to make adjustments on the GyroRemote.)
- 4 a. Press **LENS** until normal screen appears.  
b. To reset the "KEYSTONE", "V-SIZE" and "DIGITAL SHIFT" setting, press **UNDO**.

### NOTE

- Do not touch the lens when adjusting the focus or zoom.

### On-screen Display (Example: 4:3 NORMAL image)

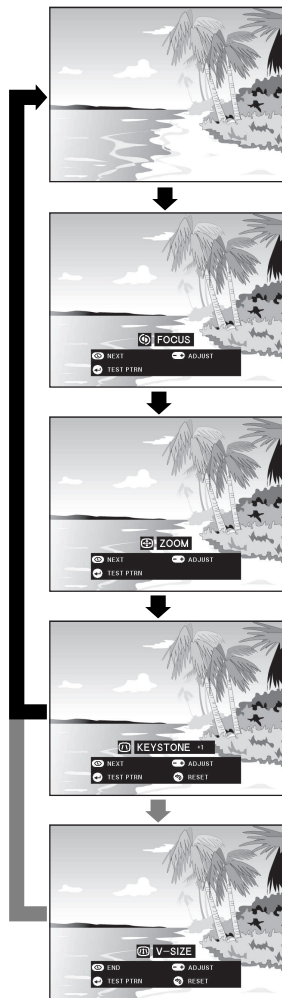

### On-screen Display (Example: 16:9 WIDE image)

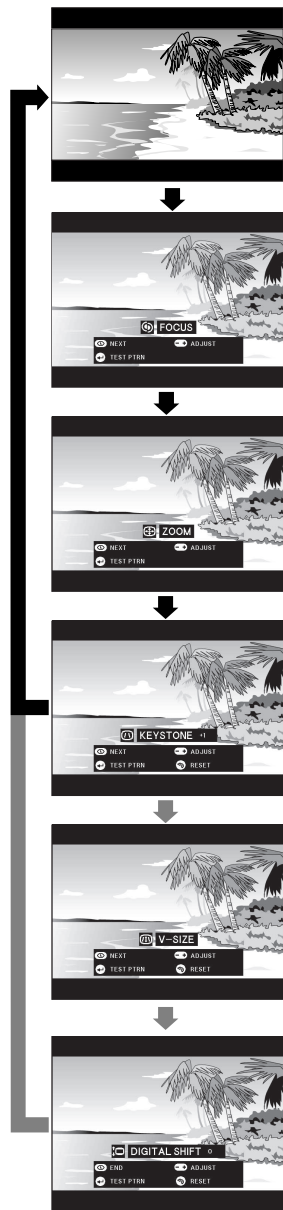

### Keystone setting

Trapezoidal distortion is caused when the projector image is positioned away from the center axis of the screen. This function allows you to correct the keystone effect for excellent picture quality.

### NOTE

- Straight lines and the edges of the displayed image may appear jagged, when adjusting the KEYSTONE setting.

### V-size setting

During keystone correction an error can occur in the aspect ratio depending on the amount of lens shift. Use the V-SIZE fine-tuning function to correct this error.

### NOTE

- V-SIZE is only displayed and can only be adjusted when performing KEYSTONE correction.

### Digital shift setting

For easier viewing, this function shifts the image projected on the screen up or down eliminating either the upper or lower black band found in 16:9 and other wide aspect ratios.

### NOTE

- Digital shift function only works with BORDER, STRETCH or SMART STRETCH of VIDEO and DTV inputs. (See page 42 for details.) The DIGITAL SHIFT screen is not displayed when projecting images other than WIDE.

### Digital Shift

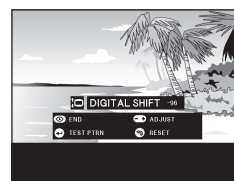

Press ▲.

or



Press ▼.



# Adjusting the Projection Distance

Position the projector perpendicular to the screen with all feet flat and level to achieve an optimal image. Move the projector forward or backward if the edges of the image are distorted.

## NOTE

- The projector lens should be centered in the middle of the screen. If the lens center is not perpendicular to the screen, the image will be distorted, making viewing difficult.
- Position the screen so that it is not in direct sunlight or room light. Light falling directly onto the screen washes out colors, making viewing difficult. Close the curtains and dim the lights when setting up the screen in a sunny or bright room.
- A polarizing screen cannot be used with this projector.

Four optional lenses from Sharp are also available for specialized application. Please see your local Sharp Industrial LCD Products Dealer to details on all the lenses. (Refer to the lens operation manual when attaching a lens.) You can install the AN-W6EZ and AN-T6EZ optional lenses yourself. However, be sure to have service personnel install the AN-P9MX and AN-P48EZ optional lenses.

## Throw Distance

The graph below is for 100 inches (254 cm) screen with 4:3 normal mode.

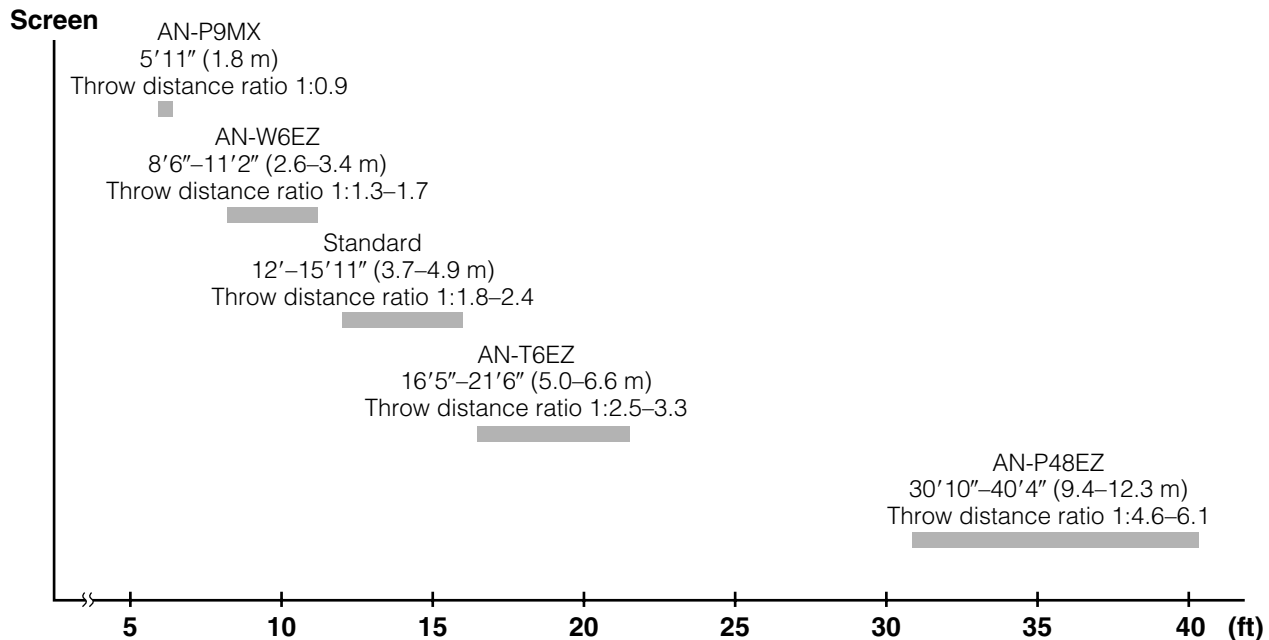

## Standard Setup (Front Projection)

Place the projector at the required distance from the screen according to the desired picture size. (See pages 24 to 28.)

## NOTE

- Four optional lenses from Sharp are available for specialized application. Please see your local Sharp Industrial LCD Products Dealer for details on all the lenses.

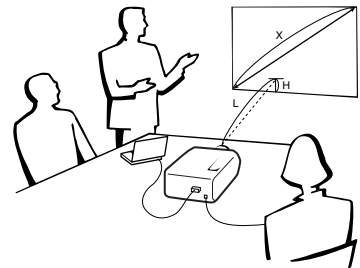

### NORMAL Mode (4:3)

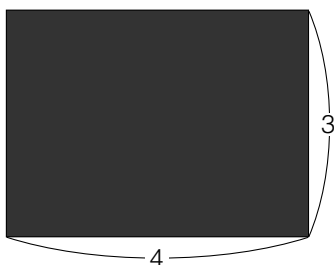

■ : Screen size and Picture size (4:3)

### WIDE Mode (16:9)

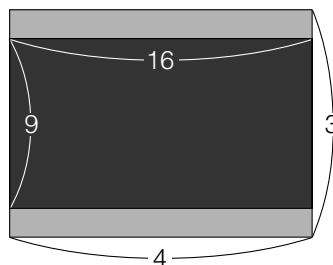

■ : Screen size and Picture size (16:9)  
■ : Signal mask area





### Upper and Lower Lens Shift Position

- This projector is equipped with a lens shift function that lets you adjust the projection height.
- Adjust to match the setup configuration.

Screen size: 100 inches (254 cm)

WIDE Mode: 16:9

Standard Lens as an example

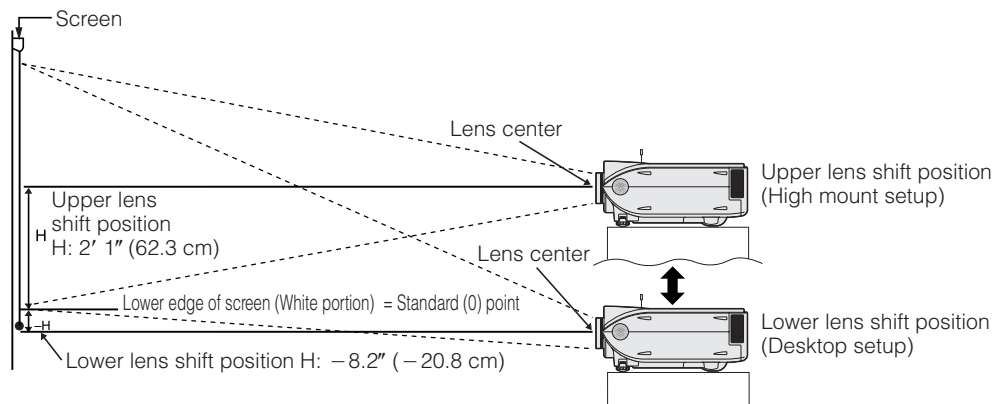

### Upper and Lower Lens Shift Position (Ceiling Mount)

When the projector is in the inverted position, use the upper edge of the screen as the base line, and exchange the lower and upper lens shift values.

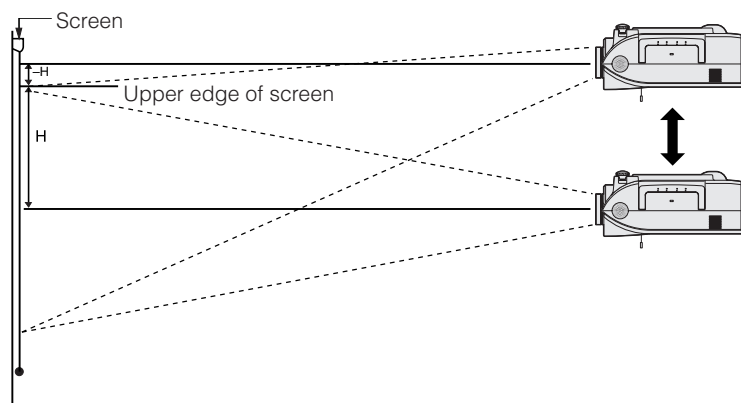

#### NOTE

- Optimal image quality is produced with the projector positioned perpendicular to the screen with all feet flat and level. Tilting or angling the projector will reduce the effectiveness of the lens shift function.







## Standard Lens Throw distance ratio 1:1.8 to 2.4

### NORMAL Mode (4:3)

Screen size (4:3) (X)			Projection distance (L)		Lens center to the lower edge of the screen (H)	
Diag.	Width	Height	Maximum (l <sub>1</sub> )	Minimum (l <sub>2</sub> )	Upper lens shift position (h <sub>1</sub> )	Lower lens shift position (h <sub>2</sub> )
300"	240"	180"	47' 0" (14.3 m)	36' 2" (11.0 m)	7' 6" (228.6 cm)	0.0" (0.0 cm)
200"	160"	120"	32' 2" (9.8 m)	24' 3" (7.4 m)	5' 0" (152.4 cm)	0.0" (0.0 cm)
150"	120"	90"	23' 6" (7.2 m)	18' 4" (5.6 m)	3' 9" (114.3 cm)	0.0" (0.0 cm)
100"	80"	60"	15' 11" (4.9 m)	12' 0" (3.7 m)	2' 6" (76.2 cm)	0.0" (0.0 cm)
84"	67"	50"	13' 2" (4.0 m)	10' 1" (3.1 m)	2' 1" (64.0 cm)	0.0" (0.0 cm)
72"	58"	43"	11' 1" (3.4 m)	8' 6" (2.6 m)	1' 10" (54.9 cm)	0.0" (0.0 cm)
60"	48"	36"	9' 6" (2.9 m)	7' 3" (2.2 m)	1' 6" (45.7 cm)	0.0" (0.0 cm)
40"	32"	24"	6' 1" (1.9 m)	4' 7" (1.4 m)	1' 0" (30.5 cm)	0.0" (0.0 cm)

The formula for screen size and projection distance

$$l_1 (\text{Max.}) = (0.0482x - 0.0226) \times 3.28$$

$$l_2 (\text{Min.}) = (0.037x - 0.041) \times 3.28$$

$$h_1 (\text{Upper}) = 0.3x$$

$$h_2 (\text{Lower}) = 0$$

x: Screen size (diag.) (X) (inches)

l: Projection distance (L) (feet)

h: Lens center to the lower edge of the screen (H) (inches)

### WIDE Mode (16:9)

Screen size (4:3) (X)			Projection distance (L)		Lens center to the lower edge of the screen (H)	
Diag.	Width	Height	Maximum (l <sub>1</sub> )	Minimum (l <sub>2</sub> )	Upper lens shift position (h <sub>1</sub> )	Lower lens shift position (h <sub>2</sub> )
300"	261"	147"	51' 3" (15.6 m)	39' 5" (12.0 m)	6' 2" (186.8 cm)	-2' 1" (-62.3 cm)
200"	174"	98"	34' 5" (10.5 m)	26' 5" (8.1 m)	4' 1" (124.5 cm)	-1' 4" (-41.5 cm)
150"	131"	74"	25' 11" (7.9 m)	19' 11" (6.1 m)	3' 1" (93.4 cm)	-1' 0" (-31.1 cm)
133"	116"	65"	23' 0" (7.0 m)	17' 7" (5.4 m)	2' 9" (82.8 cm)	-10.9" (-27.6 cm)
106"	92"	52"	18' 3" (5.6 m)	14' 0" (4.3 m)	2' 2" (66.0 cm)	-8.7" (-22.0 cm)
100"	87"	49"	17' 0" (5.2 m)	13' 1" (4.0 m)	2' 1" (62.3 cm)	-8.2" (-20.8 cm)
92"	80"	45"	15' 10" (4.8 m)	12' 1" (3.7 m)	1' 11" (57.3 cm)	-7.5" (-19.1 cm)
84"	73"	41"	14' 1" (4.3 m)	10' 10" (3.3 m)	1' 9" (52.3 cm)	-6.9" (-17.4 cm)
72"	63"	35"	12' 0" (3.7 m)	9' 3" (2.8 m)	1' 6" (44.8 cm)	-5.9" (-14.9 cm)
60"	52"	29"	10' 2" (3.1 m)	7' 10" (2.4 m)	1' 3" (37.4 cm)	-4.9" (-12.5 cm)
40"	35"	20"	6' 6" (2.0 m)	5' 0" (1.5 m)	9.8" (24.9 cm)	-3.3" (-8.3 cm)

The formula for screen size and projection distance

$$l_1 (\text{Max.}) = (0.0525x - 0.0546) \times 3.28$$

$$l_2 (\text{Min.}) = (0.0404x - 0.0397) \times 3.28$$

$$h_1 (\text{Upper}) = 0.2451x$$

$$h_2 (\text{Lower}) = -0.0817x$$

x: Screen size (diag.) (X) (inches)

l: Projection distance (L) (feet)

h: Lens center to the lower edge of the screen (H) (inches)

#### NOTE

- There is an error of  $\pm 3\%$  in the formula above.
- Values with a minus (-) sign indicate the distance of the lens center below the bottom of the screen.





## AN-W6EZ Throw distance ratio 1:1.3 to 1.7

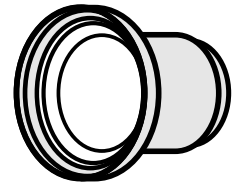

### NORMAL Mode (4:3)

Screen size (4:3) (X)			Projection distance (L)		Lens center to the lower edge of the screen (H)	
Diag.	Width	Height	Maximum (l <sub>1</sub> )	Minimum (l <sub>2</sub> )	Upper lens shift position (h <sub>1</sub> )	Lower lens shift position (h <sub>2</sub> )
300"	240"	180"	33' 11" (10.3 m)	26' 1" (7.9 m)	7' 6" (228.6 cm)	0.0" (0.0 cm)
200"	160"	120"	22' 6" (6.9 m)	17' 3" (5.3 m)	5' 0" (152.4 cm)	0.0" (0.0 cm)
150"	120"	90"	16' 10" (5.1 m)	12' 11" (3.9 m)	3' 9" (114.3 cm)	0.0" (0.0 cm)
100"	80"	60"	11' 2" (3.4 m)	8' 6" (2.6 m)	2' 6" (76.2 cm)	0.0" (0.0 cm)
84"	67"	50"	9' 4" (2.8 m)	7' 1" (2.2 m)	2' 1" (64.0 cm)	0.0" (0.0 cm)
72"	58"	43"	8' 0" (2.4 m)	6' 1" (1.9 m)	1' 10" (54.9 cm)	0.0" (0.0 cm)
60"	48"	36"	6' 7" (2.0 m)	5' 0" (1.5 m)	1' 6" (45.7 cm)	0.0" (0.0 cm)
40"	32"	24"	4' 4" (1.3 m)	3' 3" (1.0 m)	1' 0" (30.5 cm)	0.0" (0.0 cm)

The formula for screen size and projection distance

$$l_1 (\text{Max.}) = (0.0347x - 0.0709) \times 3.28$$

$$l_2 (\text{Min.}) = (0.0267x - 0.0715) \times 3.28$$

$$h_1 (\text{Upper}) = 0.3x$$

$$h_2 (\text{Lower}) = 0$$

x: Screen size (diag.) (X) (inches)

l: Projection distance (L) (feet)

h: Lens center to the lower edge of the screen (H) (inches)

### WIDE Mode (16:9)

Screen size (4:3) (X)			Projection distance (L)		Lens center to the lower edge of the screen (H)	
Diag.	Width	Height	Maximum (l <sub>1</sub> )	Minimum (l <sub>2</sub> )	Upper lens shift position (h <sub>1</sub> )	Lower lens shift position (h <sub>2</sub> )
300"	261"	147"	37' 0" (11.3 m)	28' 5" (8.7 m)	6' 2" (186.8 cm)	-2' 1" (-62.3 cm)
200"	174"	98"	24' 7" (7.5 m)	18' 10" (5.8 m)	4' 1" (124.5 cm)	-1' 4" (-41.5 cm)
150"	131"	74"	18' 4" (5.6 m)	14' 1" (4.3 m)	3' 1" (93.4 cm)	-1' 0" (-31.1 cm)
133"	116"	65"	16' 3" (5.0 m)	12' 6" (3.8 m)	2' 9" (82.8 cm)	-10.9" (-27.6 cm)
106"	92"	52"	12' 11" (3.9 m)	9' 11" (3.0 m)	2' 2" (66.0 cm)	-8.7" (-22.0 cm)
100"	87"	49"	12' 2" (3.7 m)	9' 4" (2.8 m)	2' 1" (62.3 cm)	-8.2" (-20.8 cm)
92"	80"	45"	11' 2" (3.4 m)	8' 6" (2.6 m)	1' 11" (57.3 cm)	-7.5" (-19.1 cm)
84"	73"	41"	10' 2" (3.1 m)	7' 9" (2.4 m)	1' 9" (52.3 cm)	-6.9" (-17.4 cm)
72"	63"	35"	8' 8" (2.7 m)	6' 8" (2.0 m)	1' 6" (44.8 cm)	-5.9" (-14.9 cm)
60"	52"	29"	7' 3" (2.2 m)	5' 6" (1.7 m)	1' 3" (37.4 cm)	-4.9" (-12.5 cm)
40"	35"	20"	4' 9" (1.4 m)	3' 7" (1.1 m)	9.8" (24.9 cm)	-3.3" (-8.3 cm)

The formula for screen size and projection distance

$$l_1 (\text{Max.}) = (0.0378x - 0.0726) \times 3.28$$

$$l_2 (\text{Min.}) = (0.0291x - 0.0731) \times 3.28$$

$$h_1 (\text{Upper}) = 0.2451x$$

$$h_2 (\text{Lower}) = -0.0817x$$

x: Screen size (diag.) (X) (inches)

l: Projection distance (L) (feet)

h: Lens center to the lower edge of the screen (H) (inches)

#### NOTE

- There is an error of  $\pm 3\%$  in the formula above.
- Values with a minus (-) sign indicate the distance of the lens center below the bottom of the screen.



## AN-T6EZ Throw distance ratio 1:2.5 to 3.3

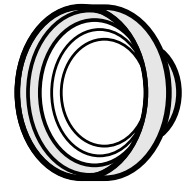

### NORMAL Mode (4:3)

Screen size (4:3) (X)			Projection distance (L)		Lens center to the lower edge of the screen (H)	
Diag.	Width	Height	Maximum (l <sub>1</sub> )	Minimum (l <sub>2</sub> )	Upper lens shift position (h <sub>1</sub> )	Lower lens shift position (h <sub>2</sub> )
300"	240"	180"	65' 9" (20.0 m)	50' 5" (15.4 m)	7' 6" (228.6 cm)	0.0" (0.0 cm)
200"	160"	120"	43' 8" (13.3 m)	33' 5" (10.2 m)	5' 0" (152.4 cm)	0.0" (0.0 cm)
150"	120"	90"	32' 7" (9.9 m)	24' 11" (7.6 m)	3' 9" (114.3 cm)	0.0" (0.0 cm)
100"	80"	60"	21' 6" (6.6 m)	16' 5" (5.0 m)	2' 6" (76.2 cm)	0.0" (0.0 cm)
84"	67"	50"	18' 0" (5.5 m)	13' 8" (4.2 m)	2' 1" (64.0 cm)	0.0" (0.0 cm)
72"	58"	43"	15' 4" (4.7 m)	11' 8" (3.6 m)	1' 10" (54.9 cm)	0.0" (0.0 cm)
60"	48"	36"	12' 8" (3.9 m)	9' 7" (2.9 m)	1' 6" (45.7 cm)	0.0" (0.0 cm)
40"	32"	24"	8' 3" (2.5 m)	6' 2" (1.9 m)	1' 0" (30.5 cm)	0.0" (0.0 cm)

The formula for screen size and projection distance

$$l_1 (\text{Max.}) = (0.0674x - 0.178) \times 3.28$$

$$l_2 (\text{Min.}) = (0.0519x - 0.1829) \times 3.28$$

$$h_1 (\text{Upper}) = 0.3x$$

$$h_2 (\text{Lower}) = 0$$

x: Screen size (diag.) (X) (inches)

l: Projection distance (L) (feet)

h: Lens center to the lower edge of the screen (H) (inches)

### WIDE Mode (16:9)

Screen size (4:3) (X)			Projection distance (L)		Lens center to the lower edge of the screen (H)	
Diag.	Width	Height	Maximum (l <sub>1</sub> )	Minimum (l <sub>2</sub> )	Upper lens shift position (h <sub>1</sub> )	Lower lens shift position (h <sub>2</sub> )
300"	261"	147"	71' 8" (21.8 m)	55' 0" (16.8 m)	6' 2" (186.8 cm)	-2' 1" (-62.3 cm)
200"	174"	98"	47' 7" (14.5 m)	36' 5" (11.1 m)	4' 1" (124.5 cm)	-1' 4" (-41.5 cm)
150"	131"	74"	35' 6" (10.8 m)	27' 2" (8.3 m)	3' 1" (93.4 cm)	-1' 0" (-31.1 cm)
133"	116"	65"	31' 5" (9.6 m)	24' 1" (7.3 m)	2' 9" (82.8 cm)	-10.9" (-27.6 cm)
106"	92"	52"	24' 11" (7.6 m)	19' 1" (5.8 m)	2' 2" (66.0 cm)	-8.7" (-22.0 cm)
100"	87"	49"	23' 6" (7.2 m)	17' 11" (5.5 m)	2' 1" (62.3 cm)	-8.2" (-20.8 cm)
92"	80"	45"	21' 7" (6.6 m)	16' 6" (5.0 m)	1' 11" (57.3 cm)	-7.5" (-19.1 cm)
84"	73"	41"	19' 8" (6.0 m)	15' 0" (4.6 m)	1' 9" (52.3 cm)	-6.9" (-17.4 cm)
72"	63"	35"	16' 9" (5.1 m)	12' 9" (3.9 m)	1' 6" (44.8 cm)	-5.9" (-14.9 cm)
60"	52"	29"	13' 11" (4.2 m)	10' 6" (3.2 m)	1' 3" (37.4 cm)	-4.9" (-12.5 cm)
40"	35"	20"	9' 1" (2.8 m)	6' 10" (2.1 m)	9.8" (24.9 cm)	-3.3" (-8.3 cm)

The formula for screen size and projection distance

$$l_1 (\text{Max.}) = (0.0734x - 0.1764) \times 3.28$$

$$l_2 (\text{Min.}) = (0.0565x - 0.1778) \times 3.28$$

$$h_1 (\text{Upper}) = 0.2451x$$

$$h_2 (\text{Lower}) = -0.0817x$$

x: Screen size (diag.) (X) (inches)

l: Projection distance (L) (feet)

h: Lens center to the lower edge of the screen (H) (inches)

#### NOTE

- There is an error of  $\pm 3\%$  in the formula above.
- Values with a minus (-) sign indicate the distance of the lens center below the bottom of the screen.





## AN-P9MX Throw distance ratio 1:0.9

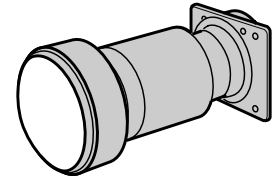

### NORMAL Mode (4:3)

Screen size (4:3) (X)			Projection distance (L)	Lens center to the lower edge of the screen (H)
Diag.	Width	Height		
300"	240"	180"	18' 1" (5.5 m)	7' 6" (228.6 cm)
200"	160"	120"	12' 0" (3.7 m)	5' 0" (152.4 cm)
150"	120"	90"	9' 0" (2.7 m)	3' 9" (114.3 cm)
100"	80"	60"	5' 11" (1.8 m)	2' 6" (76.2 cm)
84"	67"	50"	4' 11" (1.5 m)	2' 1" (64.0 cm)
72"	58"	43"	4' 2" (1.3 m)	1' 10" (54.9 cm)
60"	48"	36"	3' 6" (1.1 m)	1' 6" (45.7 cm)
40"	32"	24"	2' 3" (0.7 m)	1' 0" (30.5 cm)

The formula for screen size and projection distance

$$l = (0.0186x - 0.0563) \times 3.28$$

$$h = 0.3x$$

$x$ : Screen size (diag.) (X) (inches)

$l$ : Projection distance (L) (feet)

$h$ : Lens center to the lower edge of the screen (H) (inches)

### WIDE Mode (16:9)

Screen size (4:3) (X)			Projection distance (L)	Lens center to the lower edge of the screen (H)
Diag.	Width	Height		
300"	261"	147"	19' 9" (6.0 m)	6' 2" (186.8 cm)
200"	174"	98"	13' 2" (4.0 m)	4' 1" (124.5 cm)
150"	131"	74"	9' 10" (3.0 m)	3' 1" (93.4 cm)
133"	116"	65"	8' 8" (2.6 m)	2' 9" (82.8 cm)
106"	92"	52"	6' 10" (2.1 m)	2' 2" (66.0 cm)
100"	87"	49"	6' 6" (2.0 m)	2' 1" (62.3 cm)
92"	80"	45"	5' 11" (1.8 m)	1' 11" (57.3 cm)
84"	73"	41"	5' 4" (1.6 m)	1' 9" (52.3 cm)
72"	63"	35"	4' 8" (1.4 m)	1' 6" (44.8 cm)
60"	52"	29"	3' 9" (1.2 m)	1' 3" (37.4 cm)
40"	35"	20"	2' 6" (0.8 m)	10.0" (24.9 cm)

The formula for screen size and projection distance

$$l = (0.0203x - 0.0579) \times 3.28$$

$$h = 0.2451x$$

$x$ : Screen size (diag.) (X) (inches)

$l$ : Projection distance (L) (feet)

$h$ : Lens center to the lower edge of the screen (H) (inches)

#### NOTE

- There is an error of  $\pm 3\%$  in the formula above.
- Values with a minus (–) sign indicate the distance of the lens center below the bottom of the screen.



## AN-P48EZ Throw distance ratio 1:4.6 to 6.1

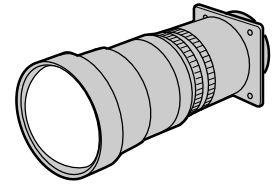

### NORMAL Mode (4:3)

Screen size (4:3) (X)			Projection distance (L)		Lens center to the lower edge of the screen (H)	
Diag.	Width	Height	Maximum (l <sub>1</sub> )	Minimum (l <sub>2</sub> )	Upper lens shift position (h <sub>1</sub> )	Lower lens shift position (h <sub>2</sub> )
300"	240"	180"	119' 9" (36.5 m)	91' 6" (27.9 m)	7' 6" (228.6 cm)	0.0" (0.0 cm)
200"	160"	120"	80' 1" (24.4 m)	61' 4" (18.7 m)	5' 0" (152.4 cm)	0.0" (0.0 cm)
150"	120"	90"	60' 0" (18.3 m)	45' 11" (14.0 m)	3' 9" (114.3 cm)	0.0" (0.0 cm)
100"	80"	60"	40' 4" (12.3 m)	30' 10" (9.4 m)	2' 6" (76.2 cm)	0.0" (0.0 cm)
84"	67"	50"	33' 10" (10.3 m)	25' 11" (7.9 m)	2' 1" (64.0 cm)	0.0" (0.0 cm)
72"	58"	43"	29' 2" (8.9 m)	22' 4" (6.8 m)	1' 10" (54.9 cm)	0.0" (0.0 cm)
60"	48"	36"	24' 3" (7.4 m)	18' 8" (5.7 m)	1' 6" (45.7 cm)	0.0" (0.0 cm)

The formula for screen size and projection distance

$$l_1 (\text{Max.}) = (0.1214x + 0.1272) \times 3.28$$

$$l_2 (\text{Min.}) = (0.0927x + 0.1233) \times 3.28$$

$$h_1 (\text{Upper}) = 0.3x$$

$$h_2 (\text{Lower}) = 0$$

x: Screen size (diag.) (X) (inches)

l: Projection distance (L) (feet)

h: Lens center to the lower edge of the screen (H) (inches)

### WIDE Mode (16:9)

Screen size (4:3) (X)			Projection distance (L)		Lens center to the lower edge of the screen (H)	
Diag.	Width	Height	Maximum (l <sub>1</sub> )	Minimum (l <sub>2</sub> )	Upper lens shift position (h <sub>1</sub> )	Lower lens shift position (h <sub>2</sub> )
300"	261"	147"	130' 7" (39.8 m)	99' 9" (30.4 m)	6' 2" (186.8 cm)	-2' 1" (-62.3 cm)
200"	174"	98"	87' 3" (26.6 m)	66' 7" (20.3 m)	4' 1" (124.5 cm)	-1' 4" (-41.5 cm)
150"	131"	74"	65' 7" (20.0 m)	50' 2" (15.3 m)	3' 1" (93.4 cm)	-1' 0" (-31.1 cm)
133"	116"	65"	58' 1" (17.7 m)	44' 7" (13.6 m)	2' 9" (82.8 cm)	-10.9" (-27.6 cm)
106"	92"	52"	46' 3" (14.1 m)	35' 5" (10.8 m)	2' 2" (66.0 cm)	-8.7" (-22.0 cm)
100"	87"	49"	44' 0" (13.4 m)	33' 6" (10.2 m)	2' 1" (62.3 cm)	-8.2" (-20.8 cm)
92"	80"	45"	40' 4" (12.3 m)	30' 10" (9.4 m)	1' 11" (57.3 cm)	-7.5" (-19.1 cm)
84"	73"	41"	36' 9" (11.2 m)	28' 3" (8.6 m)	1' 9" (52.3 cm)	-6.9" (-17.4 cm)
72"	63"	35"	31' 10" (9.7 m)	24' 3" (7.4 m)	1' 6" (44.8 cm)	-5.9" (-14.9 cm)
60"	52"	29"	26' 7" (8.1 m)	20' 4" (6.2 m)	1' 3" (37.4 cm)	-4.9" (-12.5 cm)

The formula for screen size and projection distance

$$l_1 (\text{Max.}) = (0.1323x + 0.1272) \times 3.28$$

$$l_2 (\text{Min.}) = (0.101x + 0.1233) \times 3.28$$

$$h_1 (\text{Upper}) = 0.2451x$$

$$h_2 (\text{Lower}) = -0.0817x$$

x: Screen size (diag.) (X) (inches)

l: Projection distance (L) (feet)

h: Lens center to the lower edge of the screen (H) (inches)

#### NOTE

- There is an error of  $\pm 3\%$  in the formula above.
- Values with a minus (-) sign indicate the distance of the lens center below the bottom of the screen.





## Image Projection



### Rear Projection

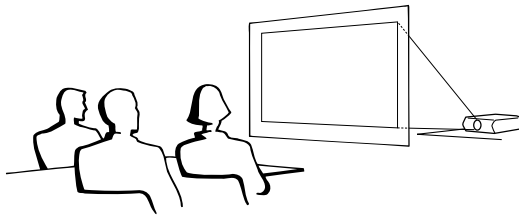

- Place a translucent screen between the projector and the audience.
- Use the projector's menu system to reverse the projected image. (See page [57](#) for use of this function.)

#### NOTE

- Optimal image quality can be achieved when the projector is positioned perpendicular to the screen with all feet flat and level.



### Projection Using a Mirror

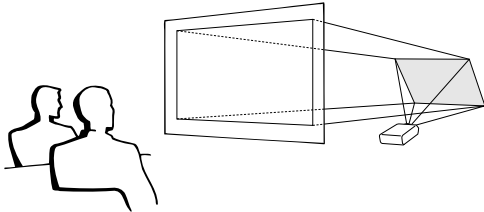

- When the distance between the projector and screen is not sufficient for normal rear projection, you can use a mirror to reflect the image onto the screen.
- Place a mirror (normal flat type) in front of the lens.
- Project the normal image onto the mirror.
- The image reflected from the mirror is projected onto the translucent screen.

#### CAUTION

- When using a mirror, be sure to carefully position both the projector and the mirror so the light does not shine into the eyes of the audience.



### Ceiling-mount Projection

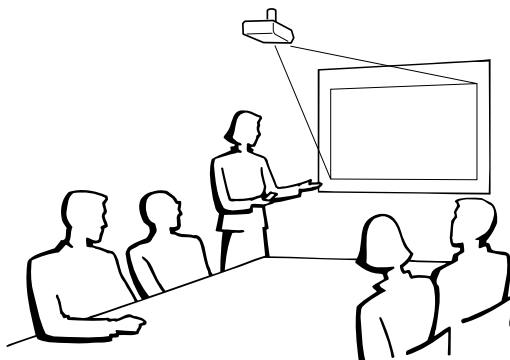

- It is recommended that you use the optional Sharp ceiling-mount bracket for this installation.
- Before mounting the projector, contact your nearest Authorized Sharp Industrial LCD Products Dealer or Service Center to obtain the recommended ceiling-mount bracket (sold separately). (AN-XGCM61 ceiling-mount bracket, AN-EP101AP extension tube for AN-XGCM61.)
- When the projector is in the inverted position, use the upper edge of the screen as the base line.
- Use the projector's menu system to select the appropriate projection mode. (See page [57](#) for use of this function.)





# Introducing GyroRemote



## GyroRemote Features

1. RF design provides nondirectional control.
2. Individual Recognition (Teach/Learn) function for multi-projector control.
3. Senses your natural hand motion for accurate control of mouse operations and projector menus.

### 1. RF Technology

Nondirectional radio design with 98' 5" (30 m) range.

**NOTE**

- The control range measured is with the antenna fully extended.
- The control range under actual operating conditions may be less than optimum depending on where the projector is placed and the radio signal environment.

#### RF: Nondirectional

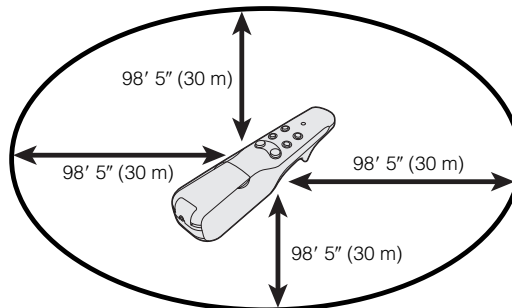

### 2. Multi-Projector Control

An individual recognition function makes it possible to control multiple projectors.

**No radio interference even if other projectors of the same type are within GyroRemote's operating range.**

Projector: 1 unit  
GyroRemote: 1 unit

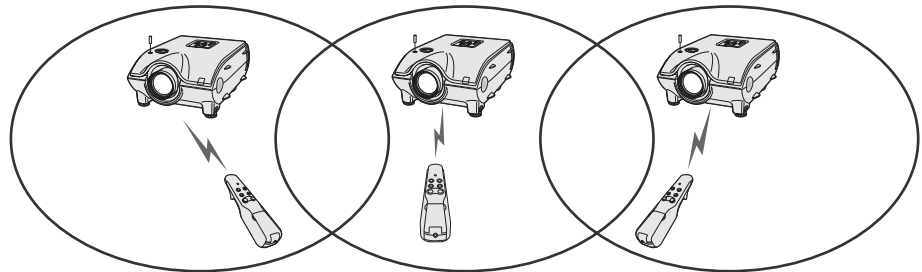

**Can operate multiple projections with one GyroRemote.**

Projector: multiple units  
GyroRemote: 1 unit

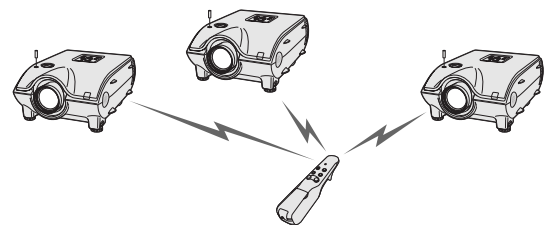

**Can operate one projector using multiple GyroRemotes.**

Projector: 1 unit  
GyroRemote: multiple units

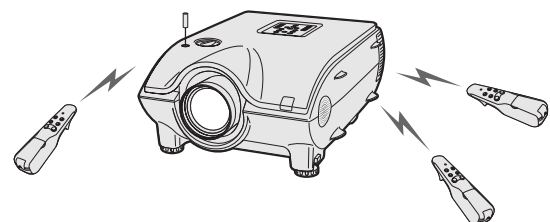



## 3. Gesture tracking

Accurately tracks your hand movements in the air for pinpoint control of projector menus and computer cursor.

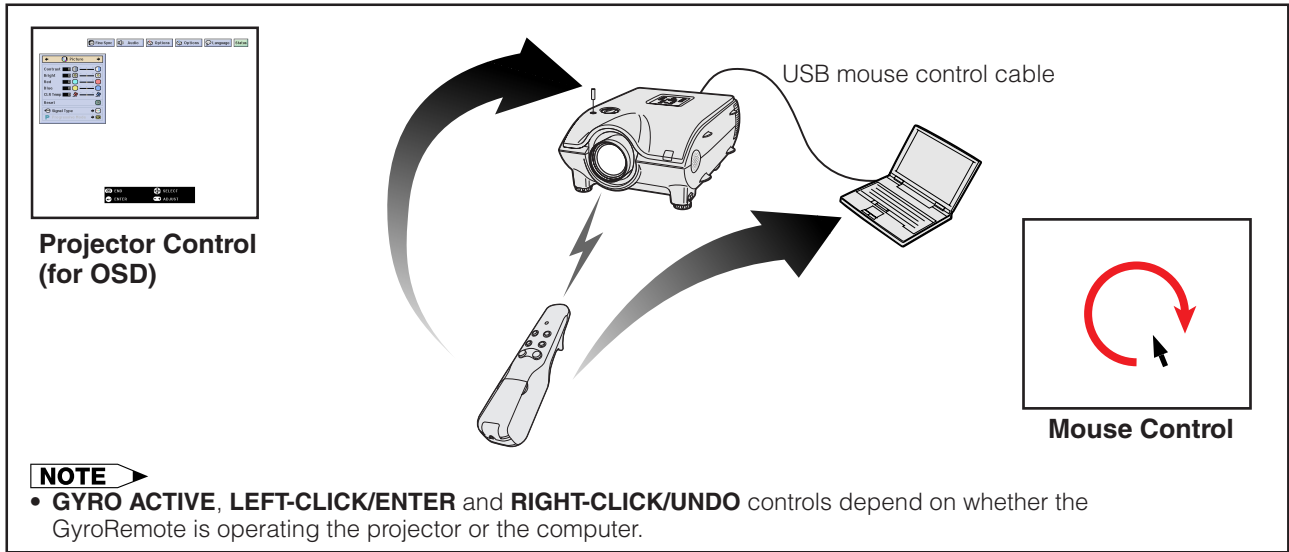

### Projector Control

#### On-screen Display

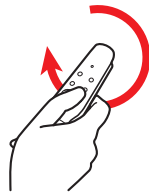
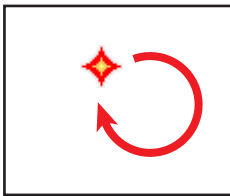

Bright and easy-to-see screen pointer. (See page 32.)

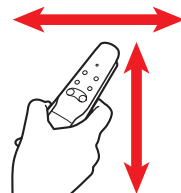
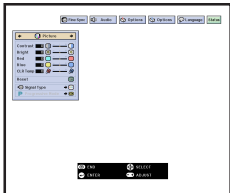

Operate the menu with a simple wave of the hand. (See page 32.)

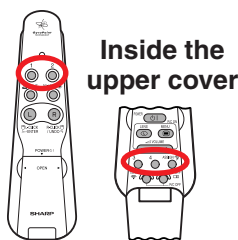
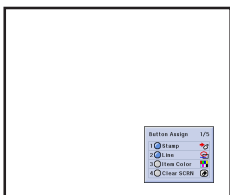

**Inside the upper cover**

Press **ASSIGN Select** to toggle and display the 5 "Button ASSIGN" lists one-by-one. Each "Button ASSIGN" list has 4 selection items. (See page 33.)

### Mouse Control

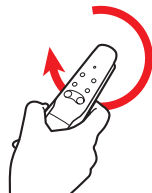
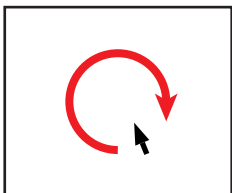

You can operate your computer with the same operating feeling as a normal mouse. (See page 35.)





# Using GyroRemote

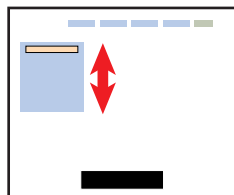
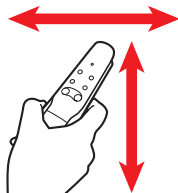
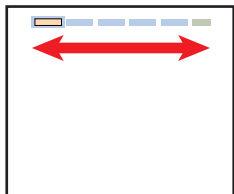
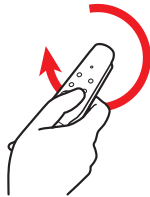
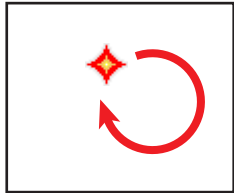
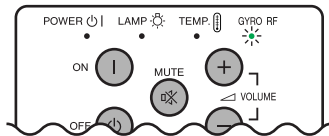
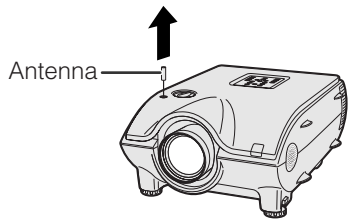

## Preparation

**1** Switch on the projector power source. The projector image will appear on the screen.

**2** Pull out the projector antenna.

### NOTE

- The control range will not be optimized if you do not pull out the antenna. Always use with the antenna fully extended.
- The control range under actual operating conditions may be less than optimum depending on where the projector is placed and the radio signal environment.

**3** Press **POWER** on the GyroRemote, located on the front, inside the upper cover.

### NOTE

- The GYRO RF indicator on the projector flashes green whenever it receives a radio signal from the GyroRemote.

## Operating the screen pointer

**1** Press **POINTER** on the GyroRemote.

As the **POINTER** is being pushed, a pointer on the screen will display. If you release your finger from the **POINTER** it will disappear from the screen.

**2** Hold the GyroRemote and move it around freely in the air. The pointer on the screen moves precisely in concert with the movement of your GyroRemote in hand.

## Menu Adjustments

**1** Open the upper cover on the front of the GyroRemote.

**2** Press **MENU**.

**3** Press **GYRO ACTIVE** on the back of the GyroRemote, and select your desired category by moving the unit left or right.

**4** Then select the desired item by moving the unit up or down.

**5** Move the unit left or right, or press **-/+** to adjust item values.

**6** Press **MENU**.

The menu display disappears.

### NOTE

- Double click on **GYRO ACTIVE**, the LED will light and you can operate GyroRemote just like pressing the button continuously. To cancel this mode, press **GYRO ACTIVE** once.
- If you release **GYRO ACTIVE** located on the back of the unit, you will not be able to control operations no matter how you wave your hand in the air.





## On-screen Display

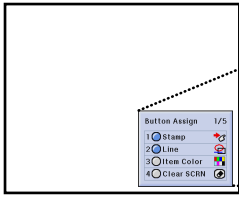

## Button Assign list

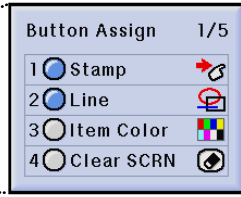

## Function ASSIGN

- 1 Open the upper cover on the front of GyroRemote.
- 2 Press **ASSIGN Select**. "Button Assign" list appears on the lower right of the display. Each time you press **ASSIGN Select**, "Button Assign" list changes as shown below.

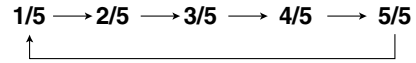

## GyroRemote

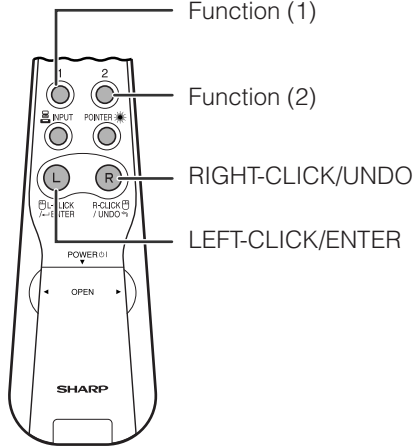

### NOTE

- Press **ASSIGN Select**. After the "Button Assign" list pops up press **LEFT-CLICK/ENTER** to view a list of all selections. Refer to the list of all Button Assign selections below.

- 3 Press **Function (1-4)** and select the desired item.
- 4 Press **UNDO**. The "Button Assign" list display disappears.

### NOTE

- The Button Assign function is not recorded on the GyroRemote itself, it is recorded on the projector side.

## Inside the upper cover

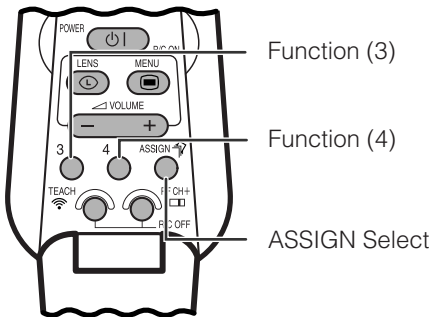

## All Button Assign selections

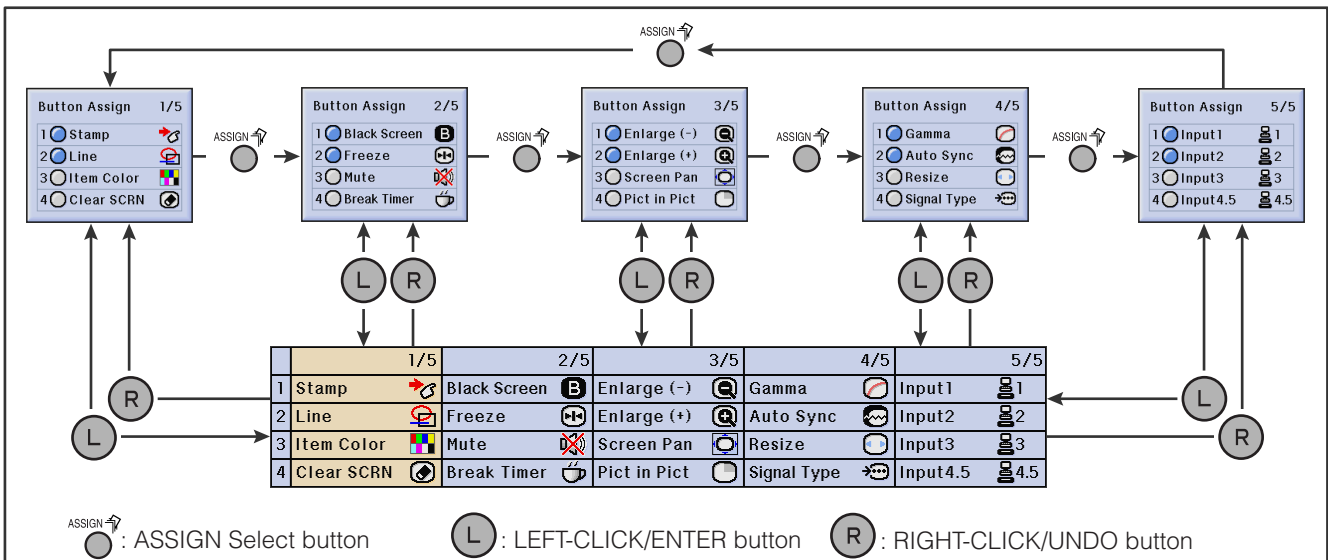



## Using the Presentation Tools

This projector is equipped with presentation tools that can be used to emphasize keypoints within your presentation.

You can use these tools by accessing the “Button Assign” list on your GyroRemote. Choose popup list “1/5”. (See page 33.)

### Button Assign list

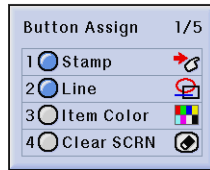

### Stamp

Each time you press **Function (1)**, stamps can be changed as shown below.



### Line

Each time you press **Function (2)**, lines can be changed as shown below (straight line, horizontal or vertical line, box, circle, free line).

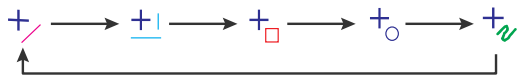

### Item Color

Each time you press **Function (3)**, colors can be changed as shown below.

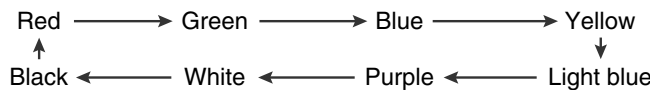

### Clear SCRN

When you press **Function (4)**, all items shown on the screen can be cleared.

#### NOTE

- The last item selected before switching off the power is saved as the default setting.
- A check mark signifies “Stamp”, a straight line is for “Line” and red is for “Item Color”.

### Using stamps

- 1 Press **Function (1)** repeatedly to select the desired stamp.
  - Types of stamps are changed as shown left.
- 2 Press and hold down **GYRO ACTIVE** to move the stamp to the desired position.
- 3 Release **GYRO ACTIVE** to set the stamp in the desired position.
- 4 Press **ENTER** to bring up another stamp, then repeat steps 1 to 3 above.

### Using lines

- 1 Press **Function (2)** repeatedly to select the desired line.
  - Types of lines are changed as shown left.
- 2 Press and hold down **GYRO ACTIVE** to move the line to the desired starting position.
- 3 Release **GYRO ACTIVE** and press **ENTER** to set the line in its starting position.
- 4 Press and hold down **GYRO ACTIVE** again and draw the line by waving the unit around in the air freely.
- 5 Release **GYRO ACTIVE** to set the ending point and complete the line drawing.
- 6 Press **ENTER** to bring up another line, then repeat steps 1 to 5 above.

#### NOTE

- In steps 2 and 4 above, while holding down **GYRO ACTIVE**, wave the unit around in the air with your hand. The stamps and starting positions of the lines move and the lines are drawn precisely in concert with your hand movements.
- To change colors, press **Function (3)** while performing any of the steps above.
- To erase the item you just placed on the screen, press **UNDO**. However, when you are drawing lines with the free line tool, pressing **UNDO** will erase all free lines drawn.

## Displaying the Break Timer

You can use this tool by accessing the “Button Assign” list on your GyroRemote. Choose popup list “2/5” and press **Function (4)**. (See page 33.)

- As soon as **Function (4)** is pressed, the timer starts to count down from 5 minutes.

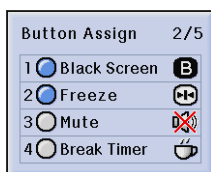

#### NOTE

- If you press **Function (4)** again, the Break Timer is canceled.
- You can set the Break Timer from 1 to 60 minutes with **▲/▼** on the projector or **-/+** on the GyroRemote. The timer starts to count down as soon as **▲/▼** or **-/+** is pressed.
- The Break Timer is displayed against the background image selected in “Selecting a Startup Image”. (See page 55.)





## Operating the mouse

Basically operates the same as a standard mouse.

## Connecting the projector to the computer

GyroRemote allows you to perform mouse operations on your computer.

- 1 Connect one end of a USB mouse control cable to your computer.
- 2 Connect the other end of the cable to the projector USB port.

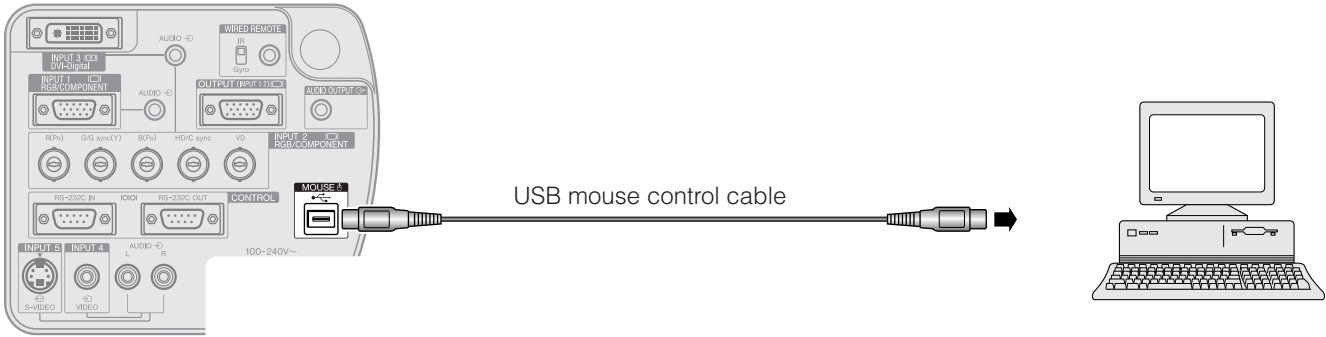

### CAUTION

- Windows 95 does not support USB mouse driver software.
- The minimum system requirements for the USB type mouse system are shown below.

#### Windows

Hardware: PC/AT compatible machine with USB port  
 OS: Windows 98/Windows 2000/Windows Me

#### Macintosh

Hardware: Macintosh series with USB port  
 OS: Mac OS 8.5 or higher

### NOTE

- If this is the first time connecting the projector to the PC, the PC may need to load standard USB drivers from the operating system. Follow the on-screen instructions. Some operating systems (Windows 98) may prompt you to insert the original operating system installation CD-ROM, if the USB driver is not already loaded on the PC.

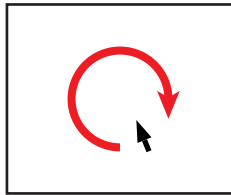

## Using the mouse

You can operate GyroRemote when there is no on-screen display.

- 1 Press **GYRO ACTIVE** on the back of GyroRemote. While pressing, wave the unit around in the air with your hand. The mouse cursor responds precisely in concert with your hand movements.
- 2 Release your finger from **GYRO ACTIVE**. The mouse cursor will stop moving around.

### NOTE

- For left/right mouse clicks, we recommend that you first move the cursor to the item you want to click on, then release your finger from **GYRO ACTIVE** before clicking your target.
- When the projector is connected to a computer by a USB mouse cable, you can still operate the mouse even if the projector is unplugged. (However, only when GyroRemote is not connected to the projector by wired remote control cable.)

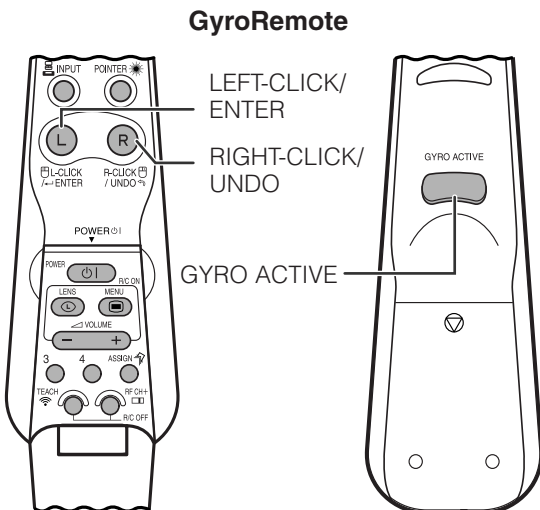



# Setting up GyroRemote

The projector uses RF channel and TEACH/LEARN settings to recognize individual projectors that may be operating in the same area, and keep them from interfering with each other. One GyroRemote can operate multiple projectors or you can even use multiple GyroRemotes to control one projector.

## Setting RF channels

GyroRemote uses radio signals, which can receive interference under certain conditions. To avoid interference, you can switch RF channels. GyroRemote has 8 channels.

GyroRemote

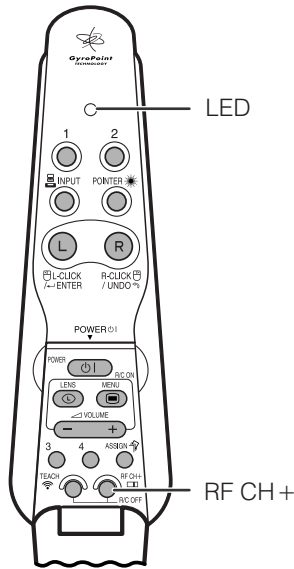

## Confirming the present RF channel

- 1 Press **RF CH +** located on the front, inside the upper cover.
- 2 The current channel in use is displayed on the lower right of the screen. You can also confirm the RF channel by the number of times the LED flashes. (Ex: RF Channel 7 if the LED flashes 7 times.)

## Switching RF channels

- 1 Press **RF CH +** for over 1 sec.
- 2 Each time you press for over 1 sec. the RF channel changes as shown below.

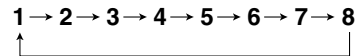

- 3 Each time you change RF channels it is displayed in the lower right of the screen.

On-screen Display



### NOTE

- An auto-search is performed on the projector side, so there is no need for manually adjusting the projector





## TEACH/LEARN

- Each GyroRemote has its own ID code, which must be recognized by the projector that is going to be used.
- The projector only recognizes the signal of the GyroRemote whose ID code has been input. Signals from other projectors or GyroRemotes that may be operating in the same area are not allowed to interrupt each other.

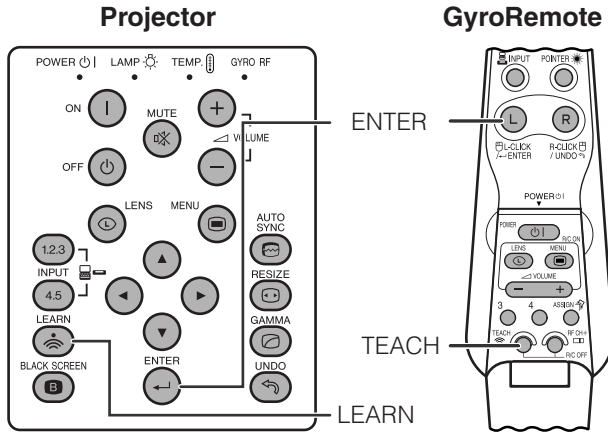

1 Press **LEARN** on the projector.

2 While “Do you want to LEARN?” is displaying, press **ENTER**. You are now in LEARN mode.

### CAUTION

- Entering LEARN mode erases all previously registered GyroRemotes data. You must re-enter each GyroRemote ID code in order for the projector to recognize them again.

3 Press **TEACH** located on the front, inside the upper cover on the remote within 5 minutes. “Register” will appear on the display and you can now start using the GyroRemote with the projector.

4 To exit from the LEARN mode, press **LEARN**.

### NOTE

- LEARN mode will exit if the **LEARN** is pressed or 5 minutes has elapsed.

## Operating multiple projectors with one GyroRemote

### CAUTION

- Be aware that you can operate multiple projectors with one GyroRemote, even if you are in another room, as long as you stay within a 98’ 5” (30 m) range of the projector.

1 Set projector to LEARN mode.

2 Press **TEACH** on the GyroRemote. You can now operate multiple projectors with one GyroRemote.

3 Perform steps 1 and 2 for each projector you plan to use.

4 To exit from LEARN mode, press **LEARN**.

### NOTE

- For setting multiple units in LEARN mode at one time, perform step 1 above for all projectors.

## Using multiple GyroRemotes to operate one projector

One projector can recognize up to 8 GyroRemote ID codes.

1 Set projector to LEARN mode.

2 Press **TEACH** on all GyroRemotes being used. Once the eighth GyroRemote is registered to operate one projector, the LEARN mode automatically finishes. You can now operate one projector using multiple GyroRemotes.

3 To exit from the LEARN mode, press **LEARN**.

### NOTE

- Contact your nearest Authorized Sharp Industrial LCD Products Dealer or Service Center if you need to use an additional GyroRemote unit.

### On-screen Display

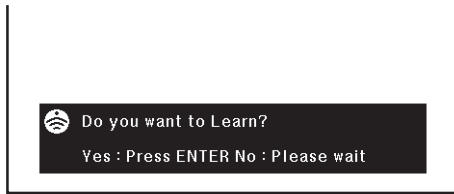



## Turning off GyroRemote

### CAUTION

- Make sure to turn off GyroRemote aboard aircraft or other places where using radio signals is prohibited.

### GyroRemote

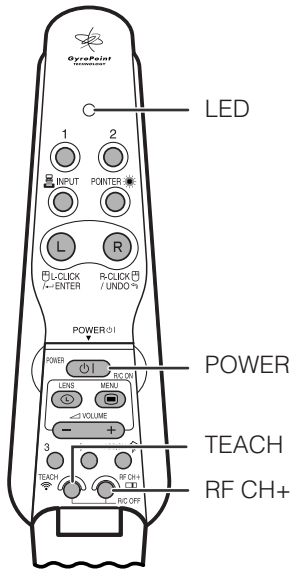

- 1 Press **TEACH** and **RF CH+** located inside the upper cover at the same time, the LED will flash 3 times and the GyroRemote will turn off.
- 2 If the LED doesn't light up after pressing any of the buttons (except **POWER**), the GyroRemote power is turned off.

### NOTE

- Press **TEACH** and **RF CH+** at the same time or **POWER** located inside the upper cover of the GyroRemote to turn the power on.
- When the power is turned off, the GyroRemote is protected from malfunctioning or battery depletion if control buttons are inadvertently pressed.



## Using as a Wired Remote Control

When the GyroRemote cannot be used due to the range or positioning of the projector (rear projection, etc.), connect a  $\varnothing 3.5$  mm stereo minijack cable (sold separately) from the wired remote control input on the bottom of the remote control to the WIRED REMOTE control input terminal on the rear of the projector.

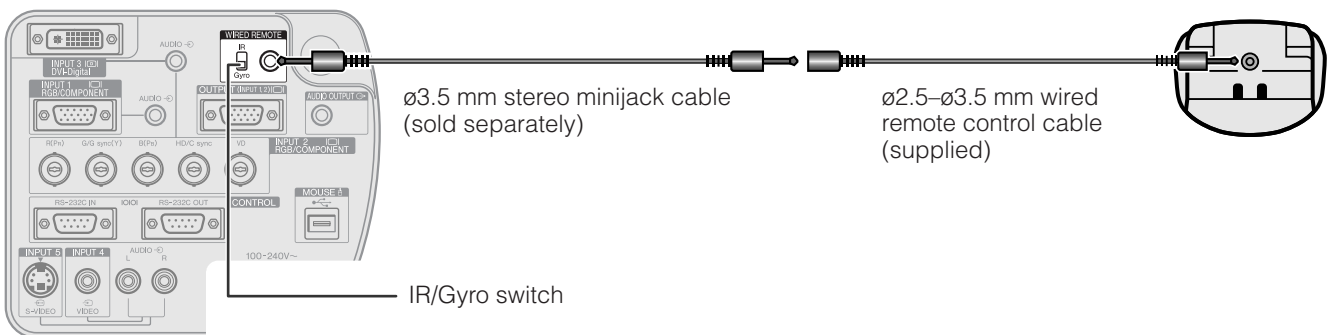

## Using the GyroRemote with a wired remote control cable

Slide the IR/Gyro switch to the **Gyro** position.

### NOTE

- To prevent unwanted transmission of radio signals, GyroRemote turns itself off if detached from the  $\varnothing 2.5$ – $\varnothing 3.5$  mm wired remote control cable.
- When the cable is inserted into the projector, the projector will not receive radio signals.

## Using the IR remote control as a wired remote

You can use the IR remote control by connecting a  $\varnothing 3.5$  mm stereo minijack cable (sold separately) from the wired remote control input on the bottom of the remote control to the WIRED REMOTE control input terminal, a SHARP product.

Slide the IR/Gyro switch to the **IR** position.

### NOTE

- Depending on the IR remote type connected, you may not be able to use certain functions.



# Using the Operation Buttons



## Selecting the Input Signal Source

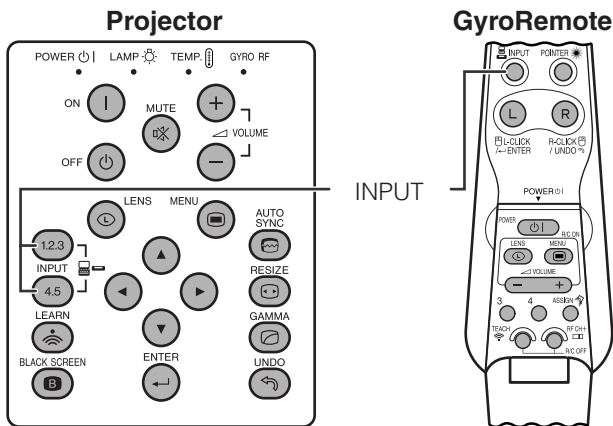

Press **INPUT** again to change the mode.

You can use these tools by accessing the “Button Assign” list on your GyroRemote. Choose popup list “5/5”. (See page 33.)

### NOTE

- When no signal is received, “NO SIGNAL” will be displayed. When a signal that the projector is not preset to receive is received, “NOT REG.” will be displayed.

### On-screen Display

#### INPUT 1 Mode



#### INPUT 2 Mode



#### INPUT 3 Mode



#### INPUT 4 Mode



#### INPUT 5 Mode



## Adjusting the Volume

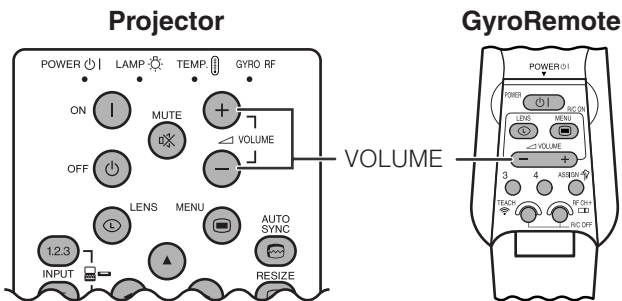

Press **VOLUME** -/+ to adjust the volume.

### On-screen Display

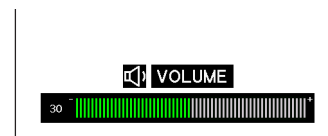

## Muting the Sound

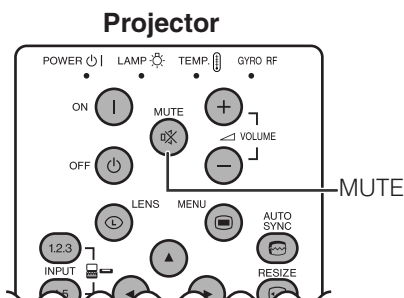

Press **MUTE** to temporarily turn off the sound. Press **MUTE** again to turn the sound back on.

You can use this tool by accessing the “Button Assign” list on your GyroRemote. Choose popup list “2/5” and press **Function (3)**. (See page 33.)

### On-screen Display







# Superimposing a Black Screen

## Projector

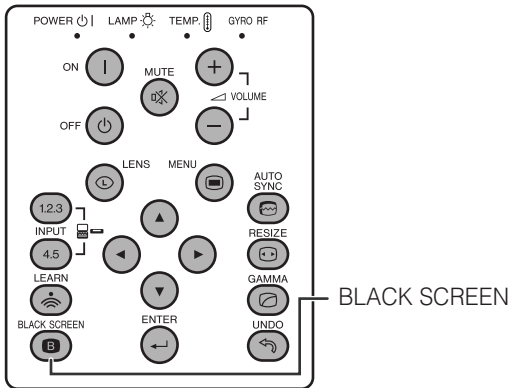

This function can be used to superimpose a black screen over the projected image.

### Blacking out the Projected Image

Press **BLACK SCREEN**. The screen turns black and “BLACK SCREEN” is displayed on the screen. To return to the original projected image, press **BLACK SCREEN** again.

You can use this tool by accessing the “Button Assign” list on your GyroRemote. Choose popup list “2/5” and press **Function (1)**. (See page 33.)

## Projected Image

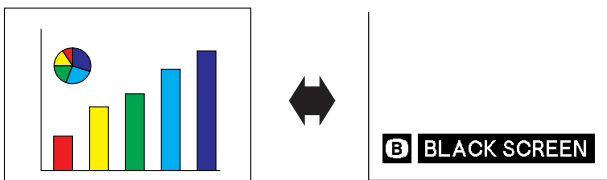

# Displaying a Still Image

## GyroRemote

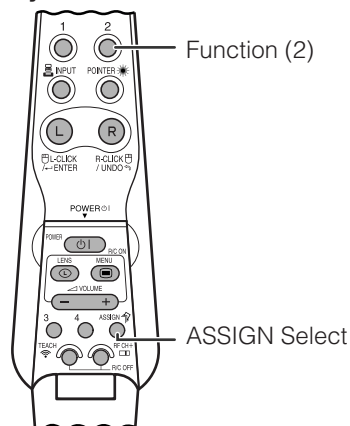

This function allows you to instantly freeze a moving image. This is useful when you want to display a still image from a computer or video, giving you more time to explain the image to the audience.

You can also use this function to display a still image from a computer while you make preparations for the next computer images to be presented.

You can only use this tool by accessing the “Button Assign” list on your GyroRemote. Choose popup list “2/5” and press **Function (2)**. (See page 33.)

## Button Assign list

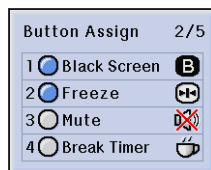

**1** Press **Function (2)** to freeze the image.

**2** Press **Function (2)** again to return to the moving image.

## On-screen Display





# Magnifying a Specific Portion of an Image

## GyroRemote

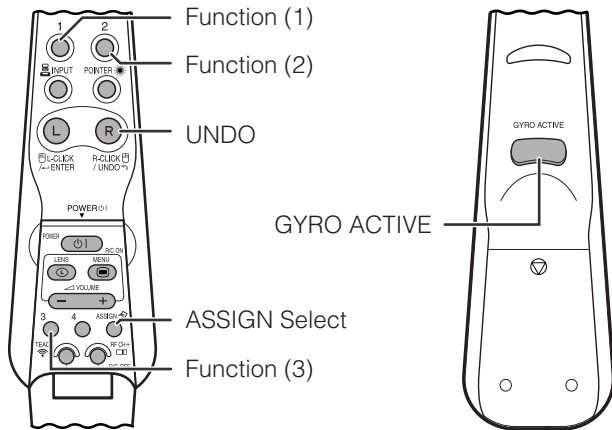

## Button Assign list

Button Assign	3/5
1 Enlarge (-)	
2 Enlarge (+)	
3 Screen Pan	
4 Pict in Pict	

## On-screen Display

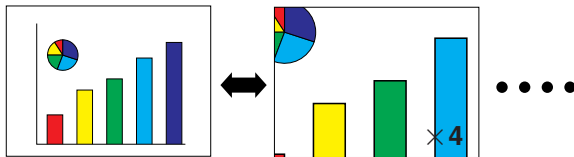

Press **Function (2)** to zoom in.

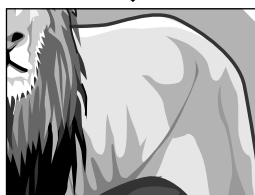

Press **Function (3)**.

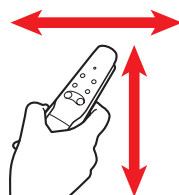
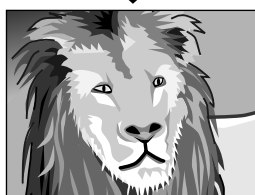

This function allows you to magnify a specific portion of an image. This is useful when you want to display a detailed portion of the image.

You can only use these tools by accessing the “Button Assign” list on your GyroRemote. Choose popup list “3/5” and press **Function (1)** or **(2)**. (See page 33.)

**1** Press **Function (2)** to zoom in. (Press **Function (1)** to zoom out.)

$\times 1 \leftrightarrow \times 4 \leftrightarrow \times 9 \leftrightarrow \times 16 \leftrightarrow \times 36 \leftrightarrow \times 64$

**2** To return to  $\times 1$ , press **UNDO**.

### NOTE

- If you press **Function (1)** when the zoom is set to  $\times 1$ , no change will occur. And if you press **Function (2)** when the zoom is set to  $\times 64$ , no change will occur.
- If the input signal is changed during digital image magnification, the image will return to  $\times 1$ . The input signal is changed
  - (a) when **INPUT** is pressed,
  - (b) when the input signal is interrupted, or
  - (c) when the input resolution and refresh rate changes.

## Pan Around the Screen

Enlarging the screen image and move it around.

You can use this tool by accessing the “Button Assign” list on your GyroRemote. Choose popup list “3/5” and press **Function (3)**. (See page 33.)

**1** When the image is magnified, press and hold down **GYRO ACTIVE**, and then move the unit in the direction of the image which you want to see.

**2** To exit from the Screen Pan mode, press **Function (3)**.

### NOTE

- The Screen Pan icon remains on the screen for a few seconds after the enlargement setting icon disappears. (The same as when the menu is displayed.)
- Select “Screen Pan” when you want to remove the Screen Pan icon (exiting this mode).
- You can also pan and scan around the image by using  $\blacktriangle/\blacktriangledown/\blacktriangleleft/\blacktriangleright$  on the projector.



# Adjusting the Picture Aspect Ratio

## Projector

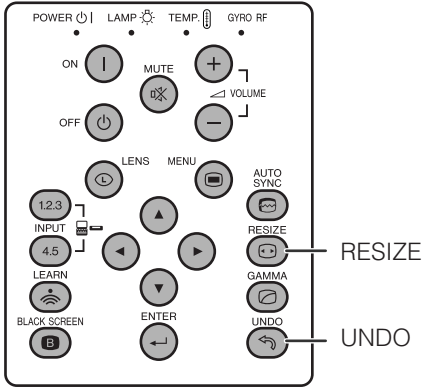

This function allows you to modify or customize the picture display mode to enhance the input image. Depending on the input signal, you can choose NORMAL, FULL, DOT BY DOT, BORDER, STRETCH or SMART STRETCH image.

- 1 Press **RESIZE**. Each time **RESIZE** is pressed, the picture mode changes as shown below.
- 2 To return to the standard image, press **UNDO** while “RESIZE” is displayed on the screen.

You can use this tool by accessing the “Button Assign” list on your GyroRemote. Choose popup list “4/5” and press **Function (3)**. (See page 33.)

## COMPUTER

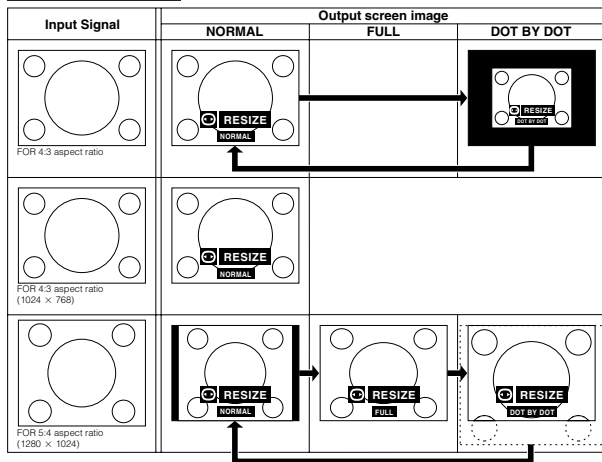

## EXAMPLE

		NORMAL	FULL	DOT BY DOT
For 4:3 aspect ratio	SVGA (800 x 600)	1024 x 768	–	800 x 600
	XGA (1024 x 768)	1024 x 768	–	–
	SXGA (1280 x 960)	1024 x 768	–	1024 x 768
	UXGA (1600 x 1200)	1024 x 768	–	1024 x 768
For without 4:3 aspect ratio	SXGA (1280 x 1024)	960 x 768	1024 x 768	1024 x 768



## VIDEO/DTV

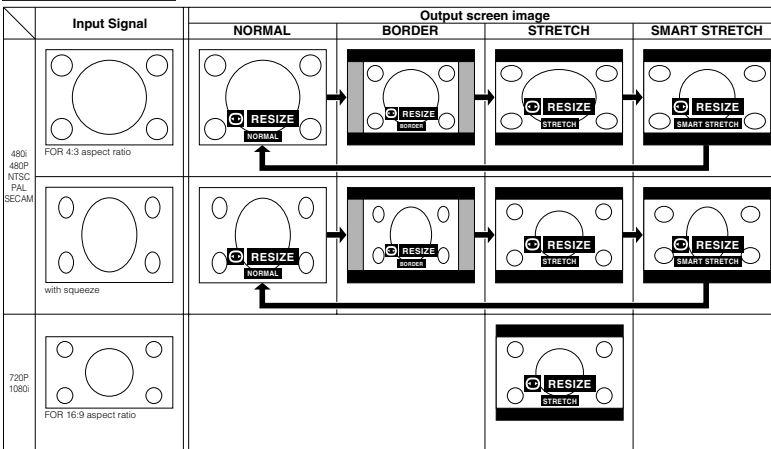

## EXAMPLE

		NORMAL	BORDER	STRETCH	SMART STRETCH
For 4:3 aspect ratio	NTSC, SECAM, 480i	1024 x 768	768 x 576	1024 x 576*	1024 x 576*
	PAL, 580i	1024 x 768	768 x 576	1024 x 576*	1024 x 576*
For 16:9 aspect ratio	480P	1024 x 768	768 x 576	1024 x 576*	1024 x 576*
	720P	–	–	1024 x 576*	–
	1080i	–	–	1024 x 576*	–

\* The digital image shift function can be used with these picture display modes.



# Gamma Correction Function

## Projector

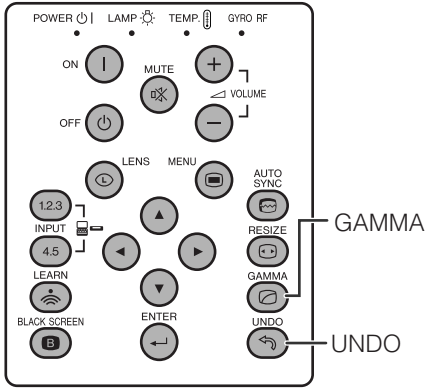

### On-screen Display (Example: RGB mode)

STANDARD

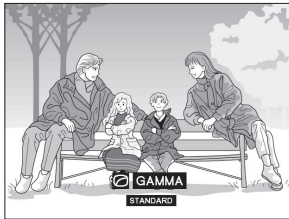

PRESENTATION

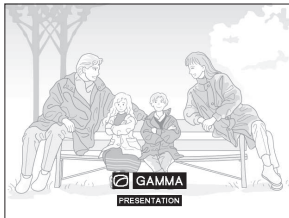

CINEMA

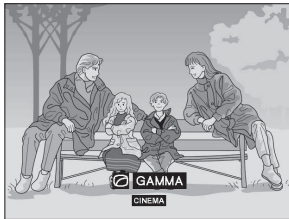

CUSTOM

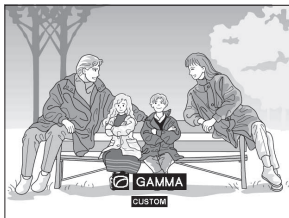

- Gamma is an image quality enhancement function that offers a richer image by brightening the darker portions of the image without altering the brightness of the brighter portions.
- Four gamma settings are available to allow for differences in the images displayed and in the brightness of the room.
- When you are displaying images with frequent, dark scenes, such as a film or concert, or when you are displaying images in a bright room, this feature makes the dark scenes easier to see and gives the impression of greater depth in the image.

## Gamma Modes

Selected Mode	Gamma mode
STANDARD	Standard picture without gamma correction.
PRESENTATION	Brightens darker portions of image for more enhanced presentations.
CINEMA	Gives greater depth to darker portions of image for a more exciting theater experience.
CUSTOM	Allows you to adjust gamma value using Sharp Advanced Presentation Software.

- 1 Press **GAMMA**. Each time **GAMMA** is pressed, the gamma level toggles as shown on the left.
- 2 To return to the standard image, press **UNDO** while "GAMMA" is displayed on the screen.

You can use this tool by accessing the "Button Assign" list on your GyroRemote. Choose popup list "4/5" and press **Function (1)**. (See page **33**).

### NOTE

- The CUSTOM setting of VIDEO mode optimizes the video source to reproduce the image more beautifully. It darkens bright portions of the image and gives greater depth to darker portions of the image. Select CUSTOM as your default setting if you prefer a smooth textured image to a sharply contrasted one.
- STANDARD and CINEMA settings of VIDEO mode (except COMPONENT 480P/720P/1080i) incorporate a DYNAMIC GAMMA function for optimizing GAMMA correction frame by frame in real time, thus providing a more beautiful image.
- PRESENTATION settings are the same for both RGB and VIDEO modes.



# Using the GUI (Graphical User Interface) Menu Screen



## Basic Operations

This projector has two sets of menu screens that allow you to adjust the image and various projector settings. These menu screens which appear on pages 47 to 62 can be operated from the projector or the GyroRemote with the following procedure.

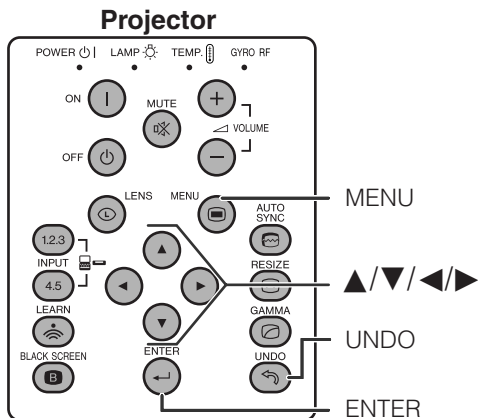

For operating the GyroRemote, see page 32.

### (GUI) On-screen Display

#### INPUT 1, 2 (RGB) or 3 (DIGITAL) mode

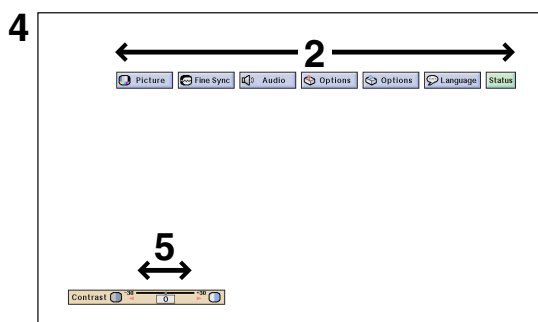
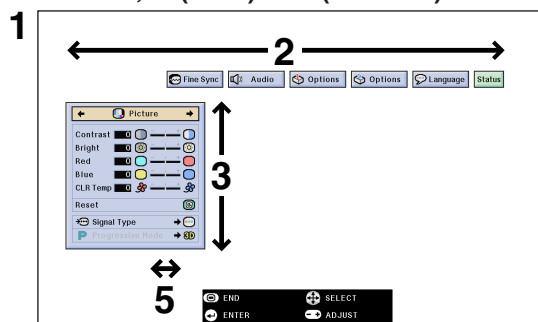

#### INPUT 4, 5 (VIDEO) mode

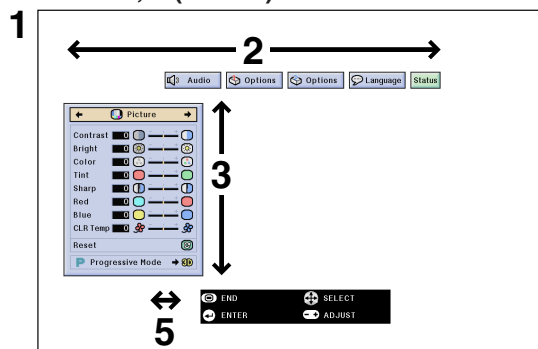

- 1 Press **MENU** to display the INPUT 1, 2, 3, 4 or 5 mode menu bar.
- 2 Press ◀/▶ to select an adjustment menu on the menu bar.
- 3 Press ▲/▼ to select a specific adjustment item.
- 4 To display a single adjustment item, press **ENTER** after selecting the item. Only the menu bar and the selected adjustment item will appear.
- 5 Press ◀/▶ to adjust the item.
- 6 Press **UNDO** to return to the previous screen.
- 7 To exit from the GUI, press **MENU**.

#### NOTE

- For details on items on the menu screen, see the tree charts on pages 45 and 46.





# Menu Bars

## Items on the INPUT 1, 2 or 3 Mode Menu Bar

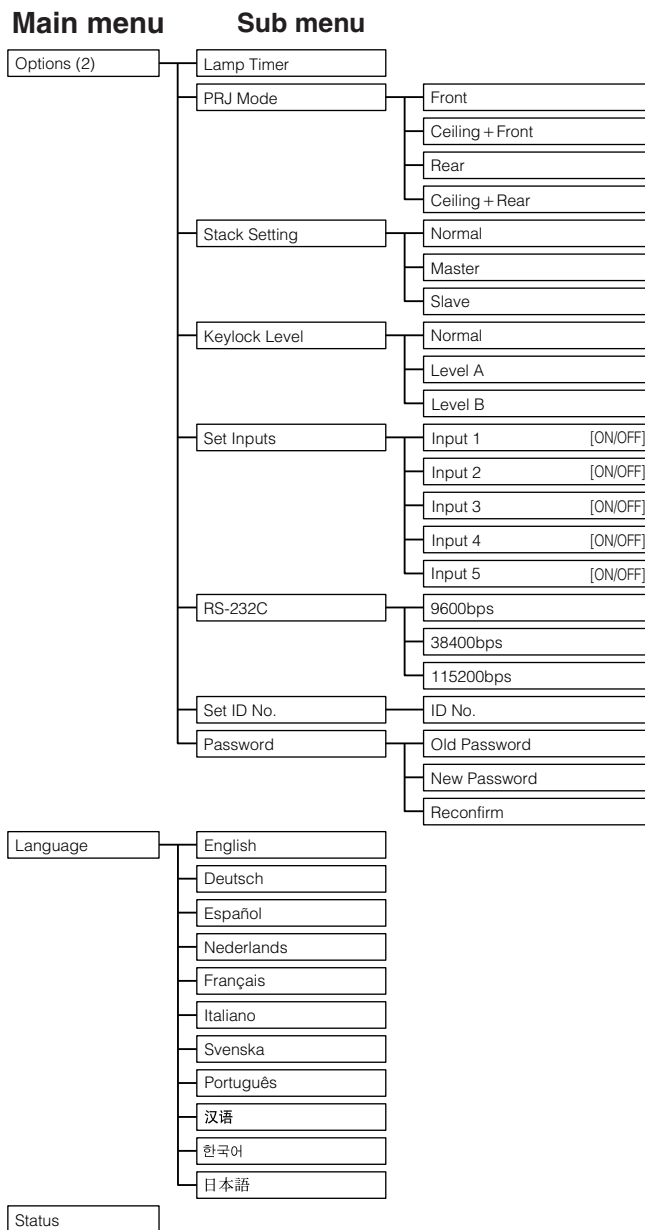
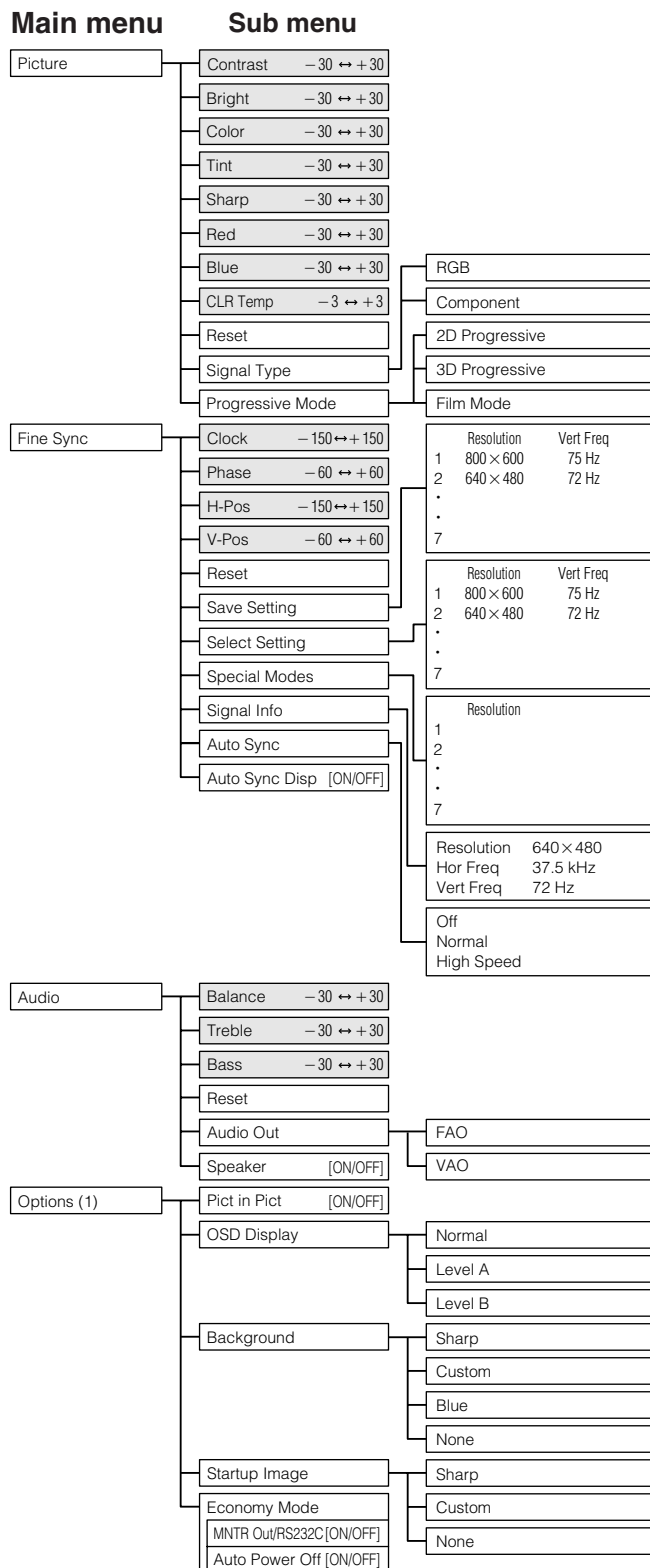

### NOTE

- The resolution, vertical frequency and horizontal frequency figures displayed above are for example purposes only.
- “Color”, “Tint”, and “Sharp” appear only when Component input is selected in INPUT 1 or 2 mode. For INPUT 3 (DVI), in “Picture” menu, only “CLR Temp” is active and the other menus are displayed in gray. In “Fine Sync” menu, only “Signal Info” is active and the other menus are displayed in gray.
- Only the items highlighted in the tree charts above can be adjusted.
- To adjust the items under the sub menu, press ► after selecting the sub menu.



## Items on the INPUT 4 or 5 Mode Menu Bar

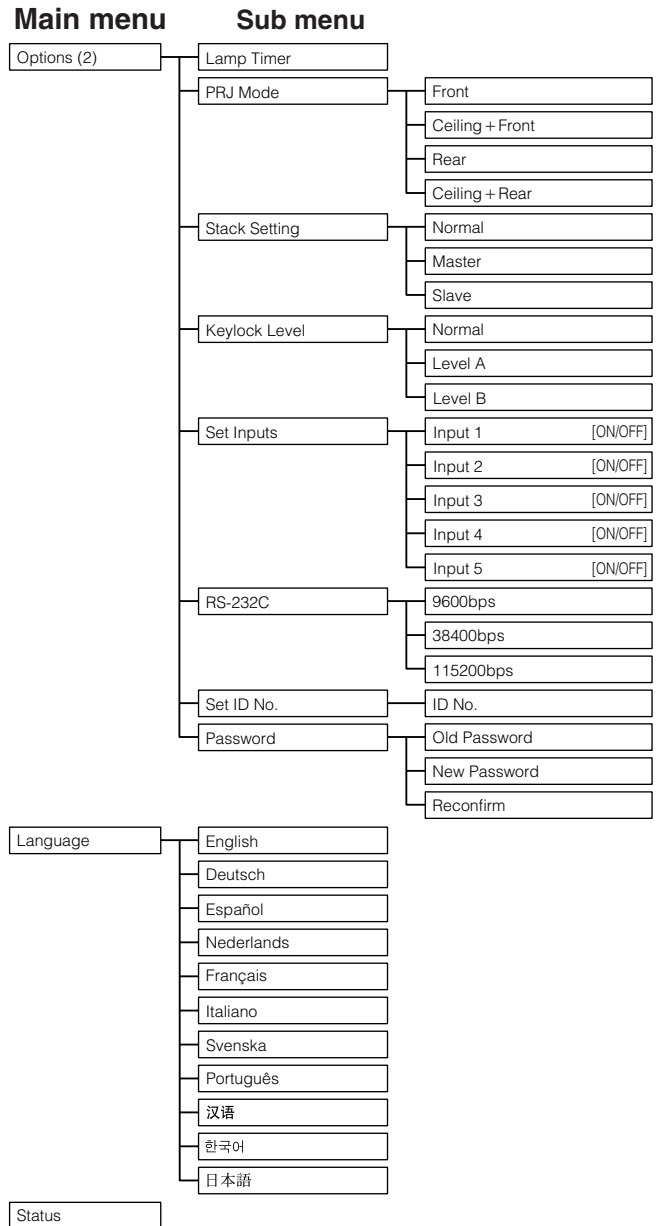
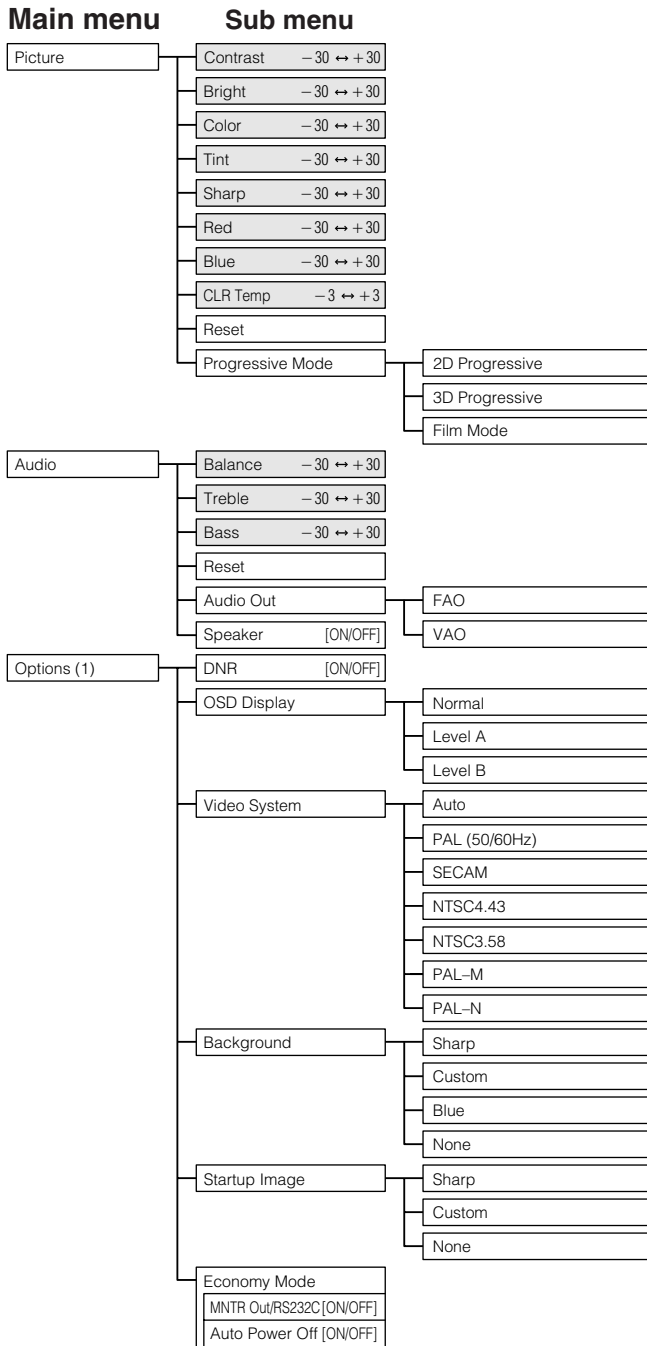

### NOTE

- Only the items highlighted in the tree charts above can be adjusted.
- To adjust the items under the sub menu, press ► after selecting the sub menu.





# Adjusting the Picture



You can adjust the projector's picture to your preferences with the following picture settings. See page **44** for the procedure details.

## e. g. RGB input in INPUT 1 or 2 mode

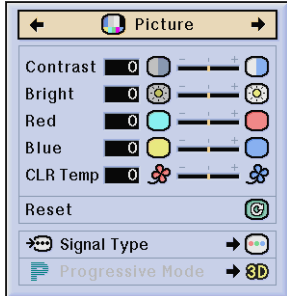

Selected item	◀ button	▶ button
<b>Contrast</b>	For less contrast	For more contrast
<b>Bright</b>	For less brightness	For more brightness
<b>Color</b>	For less color intensity	For more color intensity
<b>Tint</b>	Skin tones become purplish	Skin tones become greenish
<b>Sharp</b>	For less sharpness	For more sharpness
<b>Red</b>	For weaker red	For stronger red
<b>Blue</b>	For weaker blue	For stronger blue
<b>Reset</b>	All image adjustment items are returned to the factory preset settings.	

### NOTE

- “Color”, “Tint” and “Sharp” do not appear for RGB input in INPUT 1 or 2 mode.
- To reset all adjustment items, select “Reset” on the “Picture” menu screen and press **ENTER**.
- The adjustments can be stored separately in the INPUT 1 to 5 modes.
- Depending on the type of signal received, “Sharp” may not be adjustable for COMPONENT input in INPUT 1 or 2 mode.

## Adjusting the Color Temperature

This function can be used to adjust the color temperature to suit the type of image input to the projector (video, computer image, TV broadcast, etc.). Decrease the color temperature to create warmer, reddish images for natural flesh tones, or increase to create cooler, bluish images for a brighter picture.

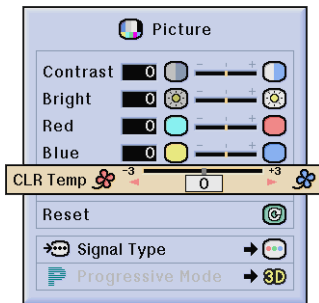

◀ button (Red)	▶ button (Blue)
Decreases color temperature for warmer, reddish, incandescent-like images. (Low color temperature)	Increases color temperature for cooler, bluish, fluorescent-like images. (High color temperature)

## Selecting the Signal Type (RGB menu only)

This function allows you to select the input signal type RGB or COMPONENT for INPUT 1 or 2 port.

You can use this tool by accessing the “Button Assign” list on your GyroRemote. Choose popup list “4/5” and press **Function (4)**. (See page **33**.)

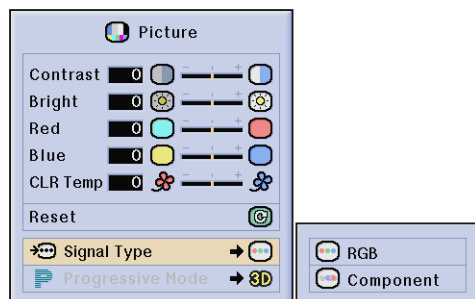



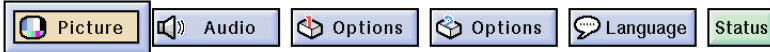

## Progressive Mode

This function allows you to select the progressive display of a video signal. The progressive display projects a smoother video image. See page 44 for the procedure details.

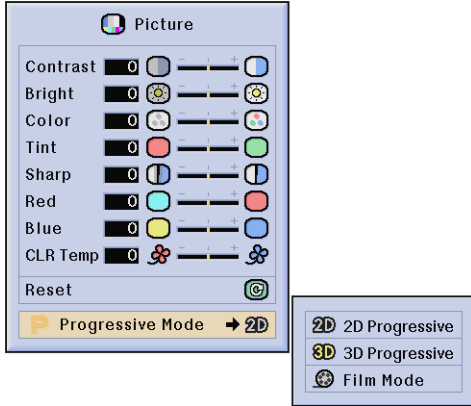

### Selects the progressive conversion mode.

#### 2D Progressive

This function is useful to display fast-moving images such as sports and action films. Mode that optimizes the image in a displayed frame.

#### 3D Progressive

This function is useful to display relatively slow-moving images such as drama and documentary more clearly. Mode that optimizes the image by estimating the movement of a number of preceding and succeeding frames.

#### Film Mode

Reproduces the image of film software clearly. Displays the optimized image of film transformed with three-two pull down enhancement to progressive mode images.

### NOTE

- Film Mode cannot work with PAL 50 Hz.



# Adjusting the Computer Images (RGB menu only)



When displaying computer patterns which are very detailed (tiling, vertical stripes, etc.), interference may occur between the LCD pixels, causing flickering, vertical stripes, or contrast irregularities in portions of the screen. Should this occur, adjust "Clock", "Phase", "H-Pos" and "V-Pos" for the optimum computer image. See page 44 for the procedure details.

Select the desired computer input mode with **INPUT 1** or **2**.

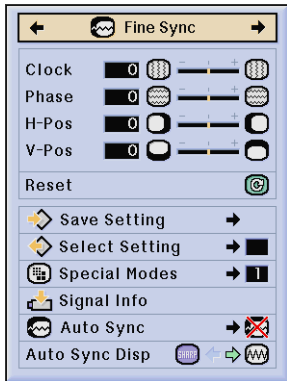

## Clock

Adjusts vertical noise.

## Phase

Adjusts horizontal noise (similar to tracking on your VCR).

## H-Pos

Centers the on-screen image by moving it to the left or right.

## V-Pos

Centers the on-screen image by moving it up or down.

### NOTE

- Computer image adjustments can be made easily by pressing **AUTO SYNC** (Ⓜ). See page 51 for details.
- To reset all adjustment items, select "Reset" on the "Fine Sync" menu screen and press **ENTER**.

## Saving and Selecting Adjustment Settings

This projector allows you to store up to seven adjustment settings for use with various computers. Once these settings are stored, they can be easily selected each time you connect a computer to the projector.

### Saving the adjustment setting

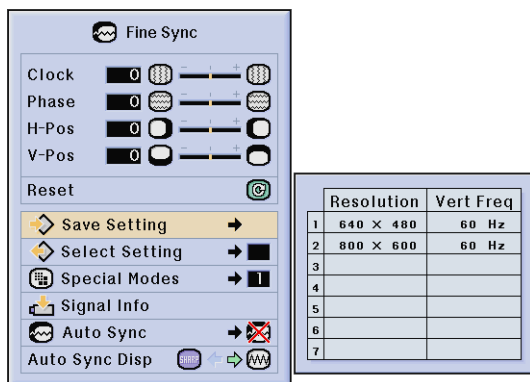

	Resolution	Vert Freq
1	640 × 480	60 Hz
2	800 × 600	60 Hz
3		
4		
5		
6		
7		

### Selecting a saved setting

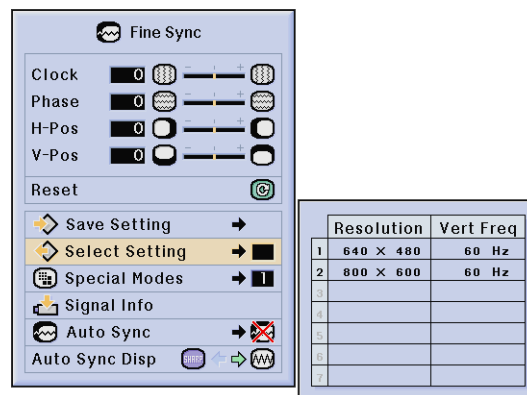

	Resolution	Vert Freq
1	640 × 480	60 Hz
2	800 × 600	60 Hz
3		
4		
5		
6		
7		

### NOTE

- If a memory position has not been set, a resolution and frequency setting will not be displayed.
- When selecting the stored adjustment setting with "Select Setting", the computer system should match the stored setting.



## Adjusting the Computer Images (RGB menu only)



### Special Mode Adjustment

Ordinarily, the type of input signal is detected and the correct resolution mode is automatically selected. However, for some signals, the optimal resolution mode in "Special Modes" on the "Fine Sync" menu screen may need to be selected to match the computer display mode. See page 44 for the procedure details.

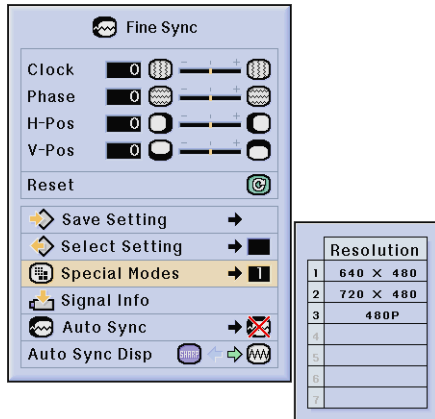

#### NOTE

- Avoid displaying computer patterns which repeat every other line (horizontal stripes). (Flickering may occur, making the image hard to see.)
- When inputting DTV 480P or 1080i signals, select the corresponding type of signal.

### Checking the Input Signal

This function allows you to check the current input signal information.

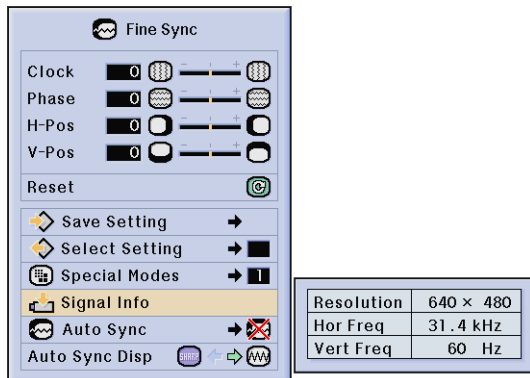



## Adjusting the Computer Images (RGB menu only)



### Auto Sync Adjustment

- Used to automatically adjust a computer image.
- Auto Sync adjustment can be made manually by pressing **AUTO SYNC**, or automatically by setting “Auto Sync” to “Normal” or “High Speed” in the projector’s GUI menu. See page 44 for the procedure details.

You can use this tool by accessing the “Button Assign” list on your GyroRemote. Choose popup list “4/5” and press **Function (2)**. (See page 33.)

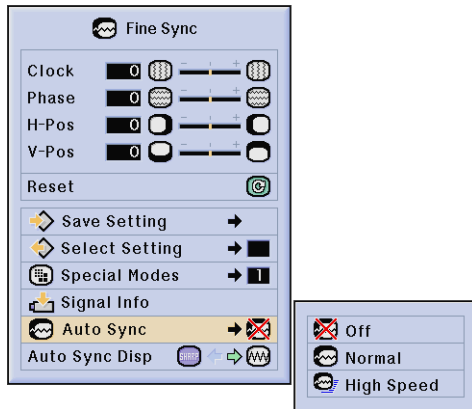

#### Off

- Synchronized adjustment is not automatically performed.
- Press **AUTO SYNC** to perform manual adjustment.

#### Normal

- Synchronized adjustment is automatically performed the same as the “High Speed” setting.
- Adjustment using the “Normal” setting takes longer to perform than using the “High Speed” setting, but it is more accurate.

#### High Speed

- The sync adjustment is automatically made each time the projector is turned on while connected to a computer or the input selection is changed.
- The Auto Sync adjustment setting previously made is cleared when the projector’s setting is changed.

#### NOTE

- Automatic adjustments can be made by pressing **AUTO SYNC**.
- When performing AUTO SYNC in Off or High Speed mode, if you press **AUTO SYNC** once, then press it again within one minute, AUTO SYNC will be executed in Normal mode.
- Auto Sync adjustment may take some time to complete, depending on the image of the computer connected to the projector.
- When the optimum image cannot be achieved with Auto Sync adjustment, use manual adjustments. (See page 49.)

### Auto Sync Display Function

Normally, an image is not superimposed during Auto Sync adjustment. You can, however, choose to superimpose a background image during Auto Sync adjustment.

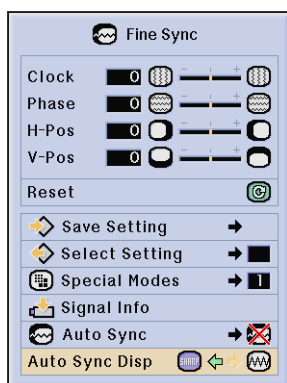



# Adjusting the Sound



This projector's audio is factory preset to standard settings. However, you can adjust it to suit your own preferences by adjusting the following audio settings. See page 44 for the procedure details.

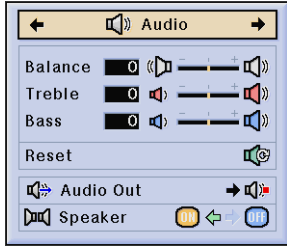

Selected item	◀ button	▶ button
<b>Balance</b>	Increased audio from the left speaker	Increased audio from the right speaker
<b>Treble</b>	For weaker treble	For stronger treble
<b>Bass</b>	For weaker bass	For stronger bass
<b>Reset</b>	All audio adjustment items are returned to the factory preset settings.	

### NOTE

- To reset all adjustment items, select "Reset" on the "Audio" menu screen and press ENTER.

### Audio Out

FAO (Fixed audio output): Audio output that does not vary in strength with the volume level of the source projector.

VAO (Variable audio output): Audio output that varies in strength with the volume level of the source projector.

### Speaker

Switching the built-in speakers on the projector ON/OFF.





## Displaying Dual Pictures (RGB menu only)

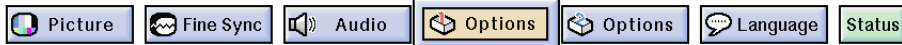

Picture in Picture function allows you to display two pictures on the same screen. You can display the image input from INPUT 4 or 5 as an inset picture overlapping the main picture input from INPUT 1, 2 or 3. See page 44 for the procedure details.

You can use this tool by accessing the “Button Assign” list on your GyroRemote. Choose popup list “3/5” and press **Function (4)**. (See page 33)

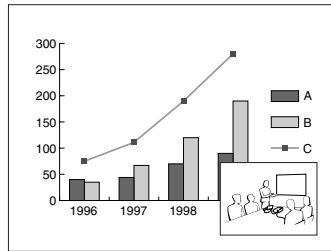
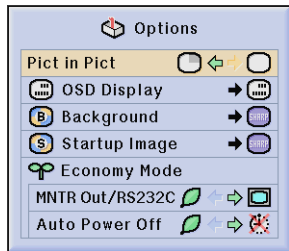

- 1 Press ◀ to select “○” to display an inset picture (Factory preset to INPUT 4).
- 2 Press ◀/▶/▲/▼ to move the inset picture to one of four preset positions.

### NOTE

- The image from INPUT 1, 2 or 3 is displayed as the main picture and the image from INPUT 4 or 5 is displayed as the inset picture.
- The last displayed image from INPUT 4 or 5 is displayed as the inset picture.  
For example, when you want to display the image from INPUT 4 as the inset picture, select INPUT 4, then select the main picture, and then select “Pict in Pict”.
- Inset picture can only be displayed in video signal of NTSC/PAL/SECAM.
- When selecting the image for the inset picture, only the images being input will be displayed.
- The audio of the inset picture will come out of the projector’s speakers.
- Picture in Picture does not work in case of the following RGB signals.  
UXGA signal image/Interlaced signal/DTV (480P/720P/1080i)
- You can only use the following functions while in Picture in Picture mode.  
FREEZE: Works for the inset picture only.



## Reducing Image Noise (VIDEO menu only)



Digital Noise Reduction (DNR) provides high quality images with minimal dot crawl and cross color noise. See page 44 for the procedure details.

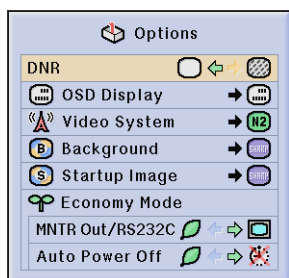

### NOTE

- If the image is clear, select “■” to prevent any blurring.



# Turning On/Off the On-screen Display

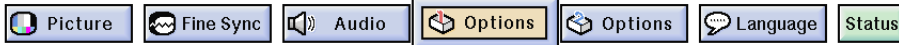

This function allows you to turn on or off the on-screen messages that appear during input select. See page 44 for the procedure details.

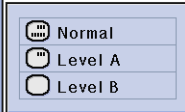
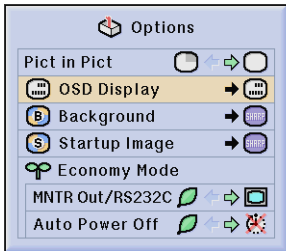

Selected item	Description
<b>Normal</b>	All On-screen Display are displayed.
<b>Level A</b>	Input/Custom/Freeze/Enlarge/Auto sync/Volume/Mute/Black screen functions are not displayed.
<b>Level B</b>	All On-screen Display are not displayed (except Menu/ Button assign list/Lens functions and warning display (Power off/Temp./Lamp function etc.)).



# Setting the Video Signal (VIDEO menu only)



The video input system mode is preset to "Auto"; however, it can be changed to a specific system mode if the selected system mode is not compatible with the connected audiovisual equipment. See page 44 for the procedure details.

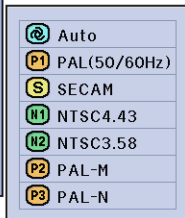
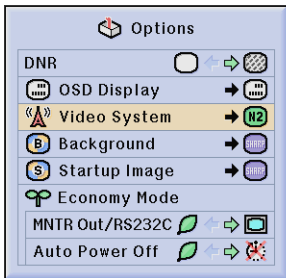

## NOTE

- When the system mode is set to "Auto", you may not receive a clear picture due to signal differences. Should this occur, switch to the video system of the source signal.
- AUTO cannot be set for PAL-M and PAL-N input signals. Select "PAL-M" or "PAL-N" in "Video System" menu for PAL-M and PAL-N input signals.





# Selecting a Background Image

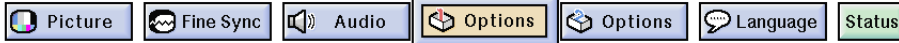

This function allows you to select the image displayed when no signal is being sent to the projector. See page 44 for the procedure details.

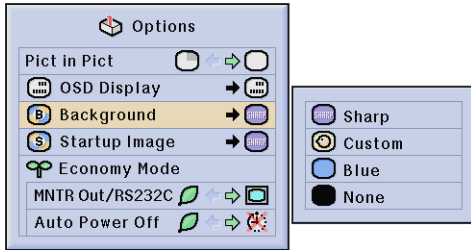

Selected item	Description
Sharp	SHARP default image
Custom	User customized image (i.e. company logo)
Blue	Blue screen
None	Black screen

## NOTE

- By selecting "Custom", the projector can display a custom image (i.e. your company logo) as the background image. The custom image must be a 256-color BMP file with a picture size no larger than 1,024 × 768 pixels. Please see the Sharp Advanced Presentation Software operation manual for how to save (or change) a custom image.



# Selecting a Startup Image



This function allows you to specify the image to be displayed upon the projector's startup. A custom image (i.e. your company logo) can be uploaded to the projector via an RS-232C cable. See page 16 in this operation manual, and also the supplied Sharp Advanced Presentation Software operation manual for detailed instructions. See page 44 for the procedure details.

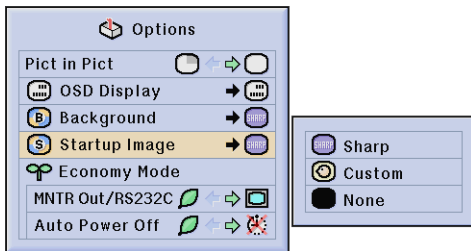

Selected item	Description
Sharp	SHARP default image
Custom	User customized image (i.e. company logo)
None	Black screen

## NOTE

- By selecting "Custom", the projector can display a custom image (i.e. your company logo) as the startup image. The custom image must be a 256-color BMP file with a picture size no larger than 1,024 × 768 pixels. Please see the Sharp Advanced Presentation Software operation manual for how to save (or change) a custom image.





# Selecting the Economy Mode

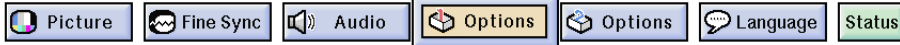

These functions allow you to reduce the power consumption when the projector is in standby mode. See page 44 for the procedure details.

## Monitor Out/RS-232C Off Function

This projector consumes power when using a monitor connected to the OUTPUT port for INPUT 1, 2 and a computer connected to the RS-232C port. When not using these ports, "MNTR Out/RS232C" can be set to "🌿" to reduce standby power consumption.

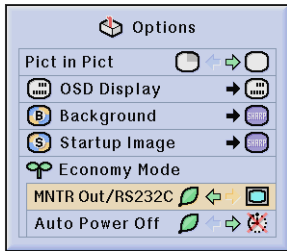

	Standby power for Monitor Out/RS-232C connection turned off.
	Monitor Out/RS-232C on

### CAUTION

- Set "MNTR Out/RS232C" to "🖥️" when using the Sharp Advanced Presentation Software (supplied).

## Automatic Power Shutoff Function

When no input signal is detected for more than 15 minutes, the projector will automatically shut off. The on-screen message, "Power OFF in 5 min." will appear five minutes before the power is automatically turned off.

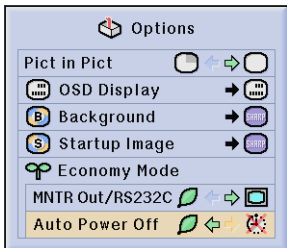

	Power automatically shuts off after 15 minutes of no signal input.
	Automatic Power Shutoff disabled.

### NOTE

- "MNTR Out/RS232C" is factory preset to "🖥️", and "Auto Power Off" is factory preset to "🌿".



## Confirming the Lamp Usage Time



This function allows you to check the accumulated lamp usage time. See page 44 for the procedure details.

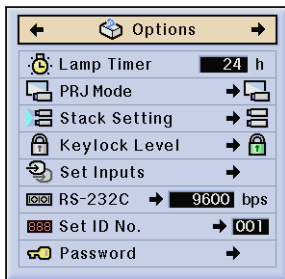

### NOTE

- It is recommended that the lamp be replaced after approximately 1,000 cumulative hours of use. See pages 68 and 69 for lamp replacement.



## Reversing/Inverting Projected Images



This projector is equipped with a reverse/invert image function which allows you to reverse or invert the projected image for various applications. See page 44 for the procedure details.

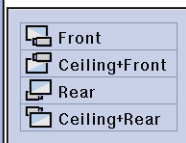
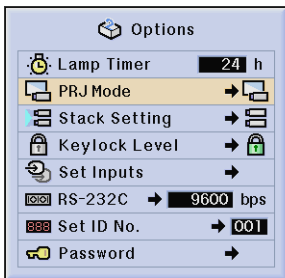

Selected item	Description
Front	Normal image
Ceiling + Front	Inverted image
Rear	Reversed image
Ceiling + Rear	Reversed and inverted image

### NOTE

- This function is used for the reversed image and ceiling-mount setups. See page 29 for these setups.



# Setting the Stacking Mode



You can double the brightness of an image by stacking two projectors and projecting same picture simultaneously. To control two projectors, assign one as the master and one as the slave. The slave projector will duplicate any operational settings made to the master projector. See page 44 for the procedure details.

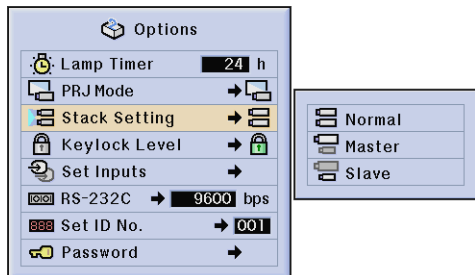

### NOTE

- When the projector is set to “Master”, button operation signals will be transmitted through RS-232C.
- When the projector is set to “Slave”, operations follow the button operations sent from the “Master”.
- When set to slave, all buttons on the projector along with **ENTER, UNDO, POWER, LENS** and **MENU** on the GyroRemote can be used. The slave cannot operate the other buttons on GyroRemote.
- For details on intended purpose, see pages 65 and 66.



# Locking the Operation Buttons on the Projector



This function can be used to lock the use of certain operation buttons on the projector. The user can still operate the projector fully with the GyroRemote. See page 44 for the procedure details.

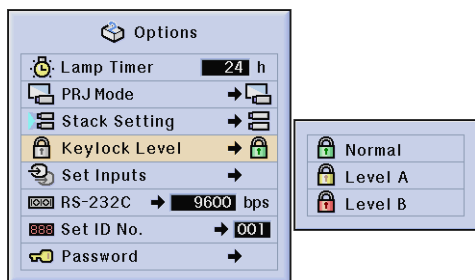

Selected item	Description
Normal	All operation buttons are functional.
Level A	Only Input/Volume/Mute functions on the projector are available.
Level B	All operation buttons on the projector are unavailable.

### NOTE

- To cancel the Keylock Level, perform the above procedure using the GyroRemote.
- See page 61 for details using the password function.



# Deselecting Inputs



This function allows you to deselect unwanted signal input. See page 44 for the procedure details.

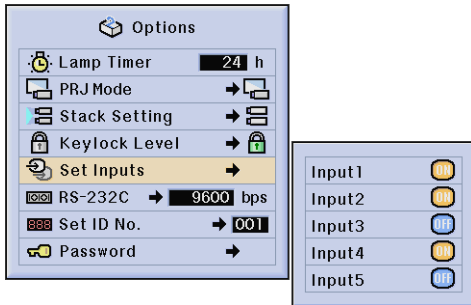

### NOTE

- When stack projecting, multi-screen projecting and so on, this function can be used to cancel the RS-232C control.
- Up to two input signals can be blocked for both Input 1, 2, 3 or Input 4, 5.
- For details on intended purpose, see pages 65 and 66.



# Selecting the Transmission Speed (RS-232C)



This menu allows you to adjust the transmission speed of the RS-232C connection by selecting the baud rate. See page 44 for the procedure details.

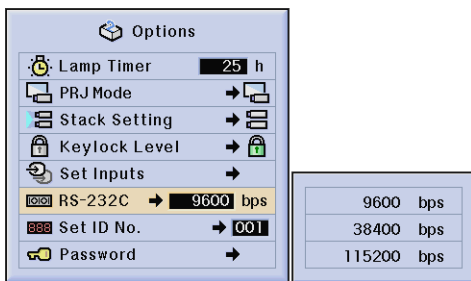

### NOTE

- Make sure that both the projector and computer are set for the same baud rate. Refer to the computer's operation manual for instructions for setting the baud rate.



# Controlling Multiple Projectors with ID Numbers



This projector can form a network of up to 250 projectors. To identify separately and control specified projector, you need to set ID No.. The ID No. is factory preset to "001". See page [44](#) for the procedure details.

## Setting the ID No.

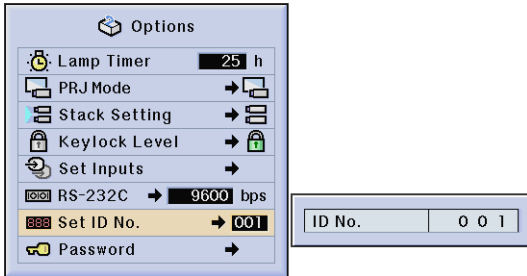

Press **▶** to select the first digit and **▲/▼** to select the desired number. Continue this procedure for the remaining two digits.

### NOTE

- Be sure to set the ID No. in the Option menu and attach a corresponding number seal to the projector.
- The ID No. can be set from 001 to 250.
- For details on intended purpose, see pages [63](#) to [66](#).





# Protecting Important Settings with a Password



A password can be set by the user and used with the keylock level to prevent adjustments to certain settings on the GUI. See page [44](#) for the procedure details.

## NOTE

- When password is set, you need to enter the password to use “PRJ Mode”, “Stack Setting”, “Keylock Level”, “Set Inputs”, “RS-232C” and “Set ID No.” menus.

## Setting the Password

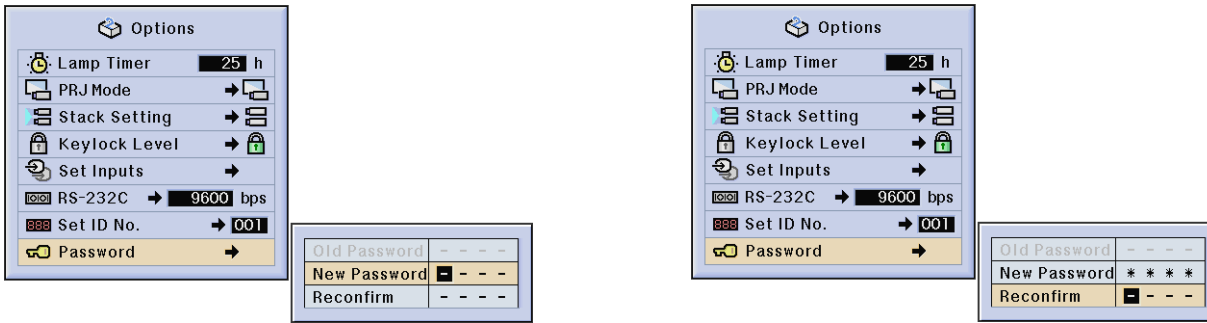

- 1 Enter the new password using ▲/▼ to select the desired number, and then press ► to select the next digit. Continue this procedure for the remaining three digits, and then press **ENTER**.
- 2 Enter the password again (“Reconfirm”) using ▲/▼/◀/▶, and then press **ENTER**.

## NOTE

- After setting the password, be sure to write it down in a secure location in case you can not remember it.

## Changing the Password

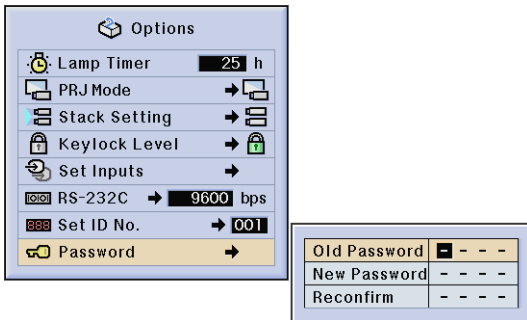

- 1 Enter the old password using ▲/▼/◀/▶, and then press **ENTER**.
- 2 Enter the new password using ▲/▼/◀/▶, and then press **ENTER**.
- 3 Enter the password again (“Reconfirm”) using ▲/▼/◀/▶, and then press **ENTER**.



# Selecting the On-screen Display Language



English is the preset language for the On-screen Display; however, this can be changed to German, Spanish, Dutch, French, Italian, Swedish, Portuguese, Chinese, Korean or Japanese. See page 44 for the procedure details.



# Displaying the Adjustment Settings



This function can be used to display all the adjusted settings on the screen simultaneously. See page 44 for the procedure details.

## INPUT 1, 2 (RGB) or 3 (DIGITAL) mode

Picture	Fine Sync	Audio	Options	Options	Language
Contrast 0	Clock 0	Balance 0	Pict in Pict	Lamp Timer 8h	English
Bright 0	Phase 0	Treble 0	OSD Display	PRJ Mode	
Red 0	H-Pos 0	Bass 0	Background	Stack Setting	
Blue 0	V-Pos 0	Audio Out	Startup Image	Keylock Level	Standard
CLR Temp	Select Setting	Speaker	MNTR Out/RS232C	Set Inputs 1, 2, , 4	Normal
Signal Type	Special Modes		Auto Power Off	RS-232C 9600bps	
Progressive Mode	Auto Sync			Set ID No. 001	
	Auto Sync Disp			Password	

## INPUT 4, 5 (VIDEO) mode

Picture	Audio	Options	Options	Language
Contrast 0	Balance 0	DNR	Lamp Timer 25h	English
Bright 0	Treble 0	OSD Display	PRJ Mode	
Color 0	Bass 0	Video System	Stack Setting	
Tint 0	Audio Out	Background	Keylock Level	Standard
Sharp 0	Speaker	Startup Image	Set Inputs 1, 2, , 4	Normal
Red 0			RS-232C 9600bps	
Blue 0			MNTR Out/RS232C	
CLR Temp			Auto Power Off	
Progressive Mode			Set ID No. 001	
			Password	





## Using Extended Functionality Features

This projector has outstanding network capability.

- Internet access for self-diagnosis
- Multiple and group projector control
- Simultaneous multiple projector control

### Internet access for self-diagnosis, status information and preventive maintenance

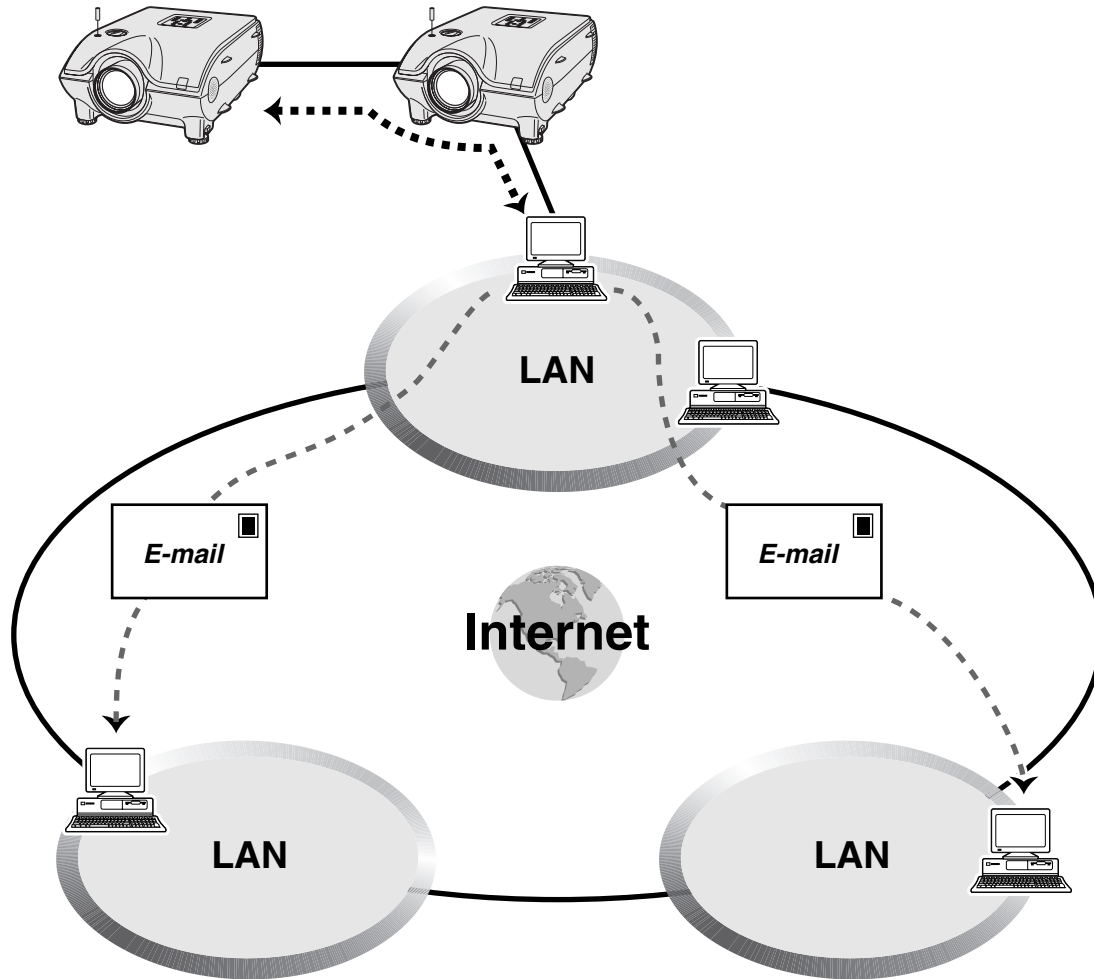

This projector can be used in a network of up to 250 projectors managed from a single PC with the accompanied Sharp Advanced Presentation Software—Professional Edition. This projector can be connected to a PC using an RS-232C connection. Output terminals are provided (RS-232C on the projector) enabling a daisy chain configuration and eliminating the need for a distributor.

This projector is also equipped with a function to send status information (lamp usage time, etc.) to a Sharp Service Center or outside contractor for quick and efficient customer service.

#### NOTE

- For more information on these features, see the operation manuals accompanying the Sharp Advanced Presentation Software—Professional Edition and optional boards.





## Using Extended Functionality Features

### Multiple and group projector control via computer

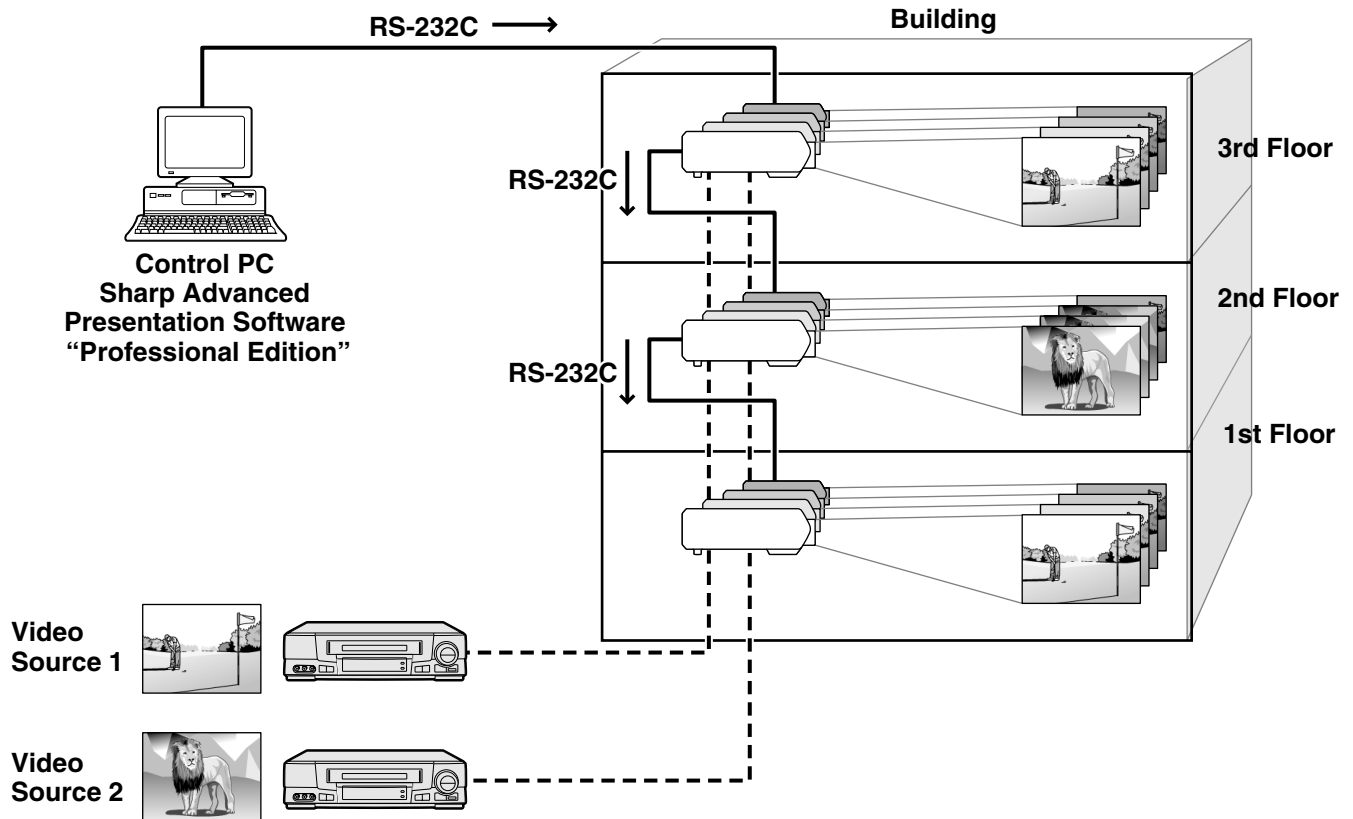

This projector can be used in a network of projectors managed from a single PC with the accompanied Sharp Advanced Presentation Software—Professional Edition. Projectors in conference rooms on the first and third floors of a building, for example, can be used for video presentations, while projectors on the second floor can be used for PC-assisted presentations. Projectors can even be powered down at different times (e.g., projectors on the first and second floors are powered down in one hour, while those on the third floor are powered down in two hours).

#### NOTE

- For more information on these features, see the operation manuals accompanying the Sharp Advanced Presentation Software—Professional Edition.
- Transmission performance of the RS-232C cable can vary depending on the surrounding conditions. Use the transmission repeater if performance is not up to par.
- We recommend you use an RS-232C cable not longer than 49' 3" (15 m).





## Using Extended Functionality Features

### Simultaneous multiple projector control for stacking and videowall projection

#### Stack Projection

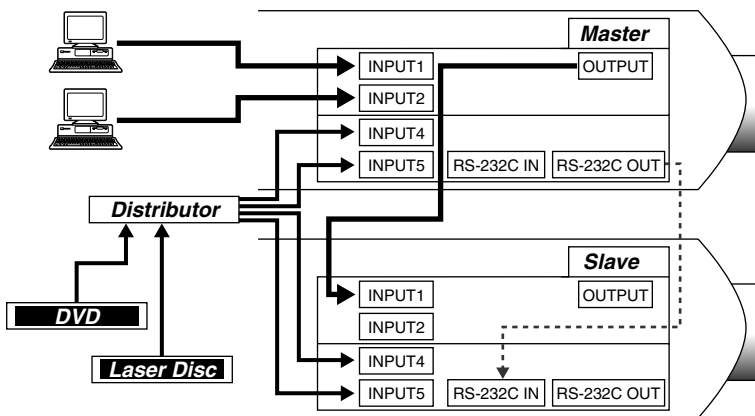
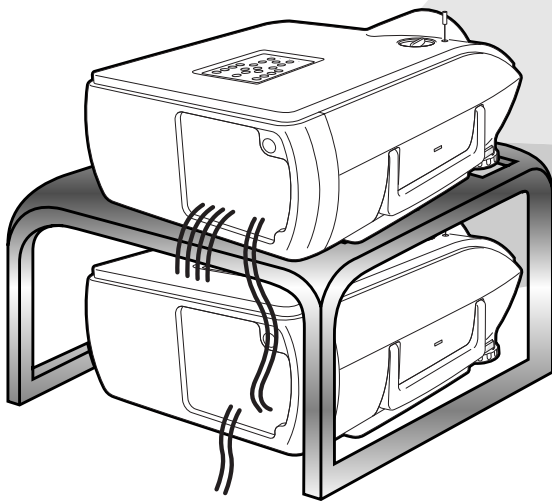

Stack Setting	
<b>Master</b>	

Set Inputs	
INPUT1	Yes
INPUT2	Yes
INPUT3	No
INPUT4	Yes
INPUT5	Yes

Stack Setting	
<b>Slave</b>	

Set Inputs	
INPUT1	Yes
INPUT2	No
INPUT3	No
INPUT4	Yes
INPUT5	Yes

For brighter images, two projectors can be stacked using the Stack Setting function, with one projector set as the Master and the other as the Slave. The operations of the Slave projector are controlled by the Master projector during projection through an RS-232C connection. The RS-232C cable (null modem, cross type, sold separately) is connected from the RS-232C output on the Master projector to the RS-232C input on the Slave projector.

Projectors can be stacked using an RS-232C cable (null modem, cross type, sold separately).

#### NOTE

- See page 58, "Setting the Stacking Mode", and page 59, "Deselecting Inputs".



# Using Extended Functionality Features

## Videowall

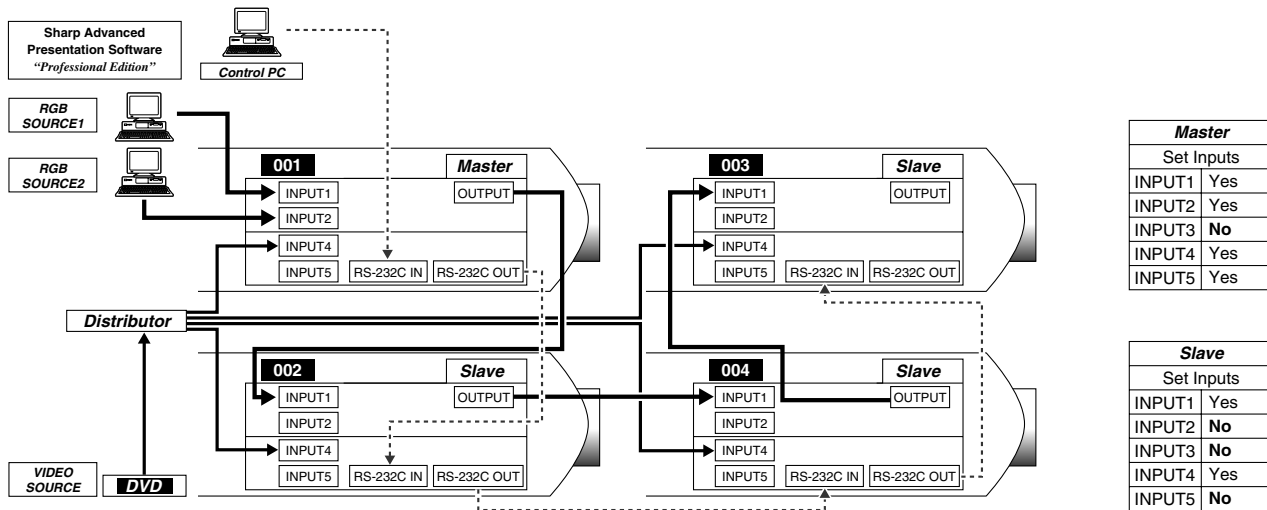
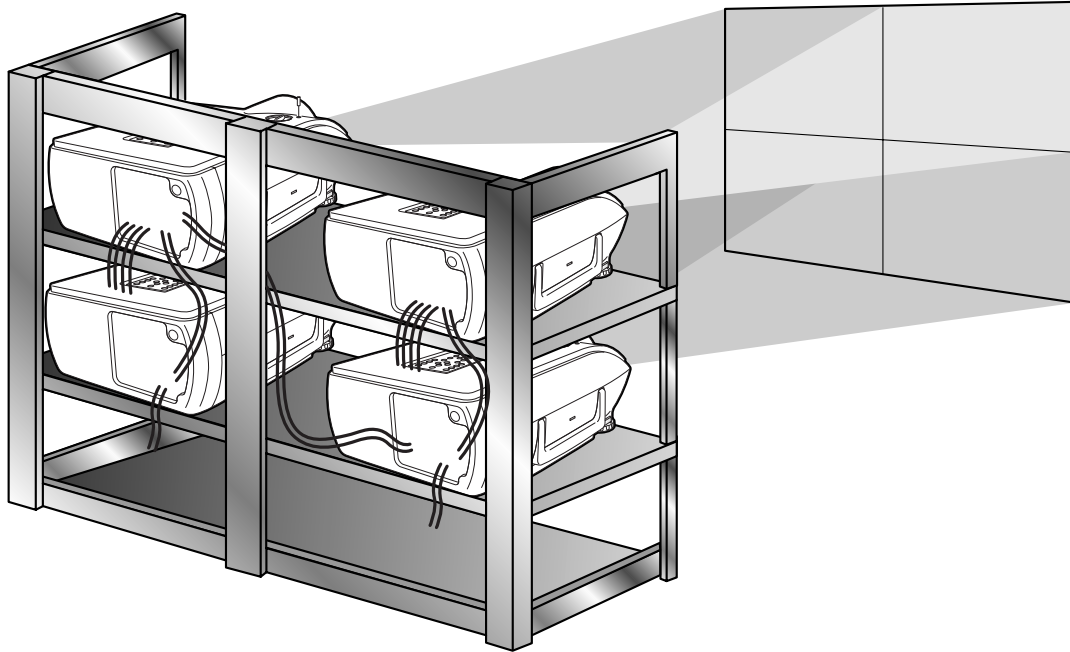

This projector can be used together with other projectors managed using the accompanied Sharp Advanced Presentation Software—Professional Edition to create a videowall projection. Whereas conventional videowall technology required the use of an image distributor, this projector videowall feature enables easy image settings from a PC when inputting a single video source. This function greatly simplifies videowall setup.

RS-232C OUTPUTS also realize the simple daisy chain connection. The master projector directly connected to the computer can make the daisy chain connection with multiple slave projectors. For details on setting master or slave, see page 58.

- Use a videowall projector stand, sold separately, when using this function.
- Image quality may deteriorate when picture signals are input through multiple projectors in a daisy chain connection.

### NOTE

- For more information on this feature, see the operation manuals accompanying the Sharp Advanced Presentation Software—Professional Edition.
- When UXGA signal is displayed, the videowall can not be set by Sharp Advanced Presentation Software—Professional Edition.





# Lamp/Maintenance Indicators

## Maintenance Indicators

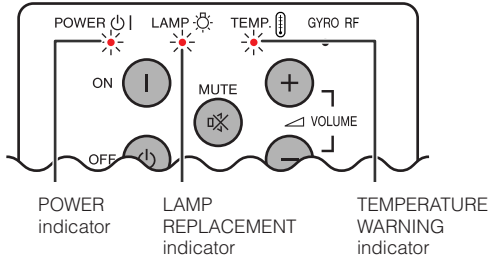

- The warning lights on the projector indicate problems inside the projector.
- There are two warning lights: a TEMPERATURE WARNING indicator which warns that the projector is too hot, and a LAMP REPLACEMENT indicator which lets you know when to change the lamp.
- If a problem occurs, either the TEMPERATURE WARNING indicator or the LAMP REPLACEMENT indicator will light up red. After turning off the power, follow the procedures given below.

Maintenance Indicator	Condition	Problem	Possible Solution
TEMPERATURE WARNING indicator	The internal temperature is abnormally high.	• Blocked air intake.	• Relocate the projector to an area with proper ventilation.
		• Clogged air filter.	• Replace the filter. (See page 70.)
		• Cooling fan breakdown. • Internal circuit failure.	• Take the projector to your nearest Authorized Sharp Industrial LCD Products Dealer or Service Center for repair.
LAMP REPLACEMENT indicator	The lamp does not light up.	• Burnt-out lamp. • Lamp circuit failure.	• Carefully replace the lamp. (See pages 68 and 69.) • Take the projector to your nearest Authorized Sharp Industrial LCD Products Dealer or Service Center for repair.
POWER indicator	The POWER indicator flashes in red when the projector is on.	• The filter cover is open.	• Securely install the filter cover.

### NOTE

- If the TEMPERATURE WARNING indicator lights up, follow the above possible solutions and then wait until the projector has cooled down completely before turning the power back on. (At least 5 minutes.)
- If the power is turned off and then turned on again, as during a brief rest, the LAMP REPLACEMENT indicator may be triggered, preventing the power from going on. Should this occur, take the power cord out of the wall outlet and put it back in again.

## Lamp

It is recommended that the lamp be replaced after approximately 1,000 cumulative hours of use or when you notice a significant deterioration of the picture and color quality. The lamp usage time can be checked with the On-screen Display. (As the usage environment can vary significantly, the projector lamp may not operate for 1,000 hours.)

### CAUTION

- Intense light hazard. Do not attempt to look into the aperture and lens while the projector is operating.





# Replacing the Lamp

## CAUTION

- Potential hazard of glass particles if lamp ruptures. In case of lamp rupture, contact your nearest Authorized Sharp Industrial LCD Products Dealer or Service Center for a replacement.
- Do not remove the lamp cage directly after operation of the projector. The lamp may be extremely hot. Wait at least one hour after the power cord is disconnected to allow the surface of the lamp cage to fully cool before removing the lamp cage.

It is recommended that the lamp be replaced after approximately 1,000 cumulative hours of use or when you notice a significant deterioration of the picture and color quality. Carefully change the lamp by following the steps below.

If the new lamp does not light after replacement, take your projector to the nearest Authorized Sharp Industrial LCD Products Dealer or Service Center for repair. Purchase a replacement lamp unit (lamp/cage module) of the current type BQC-XGP20X//1 from your nearest Authorized Sharp Industrial LCD Products Dealer or Service Center. Then carefully change the lamp by following the instructions below. If you wish, you may have the lamp replaced at your nearest Authorized Sharp Industrial LCD Products Dealer or Service Center.

### IMPORTANT NOTE TO U.S. CUSTOMERS:

The lamp included with this projector is backed by a 90-day parts and labor limited warranty. All service of this projector under warranty, including lamp replacement, must be obtained through an Authorized Sharp Industrial LCD Products Dealer or Service Center. For the name of the nearest Authorized Sharp Industrial LCD Products Dealer or Service Center, please call toll-free: 1-888-GO-SHARP (1-888-467-4277).

U.S.A. ONLY

## Removing and installing the lamp unit

### CAUTION

- Be sure to remove the lamp cage by the handle. Be sure not to touch the glass surface of the lamp cage or the inside of the projector.
- To avoid injury to yourself and damage to the lamp, be sure to carefully follow the steps below.
- Be sure to change the air filter during lamp replacement. The air filter comes packaged with the lamp unit.

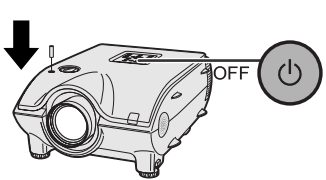
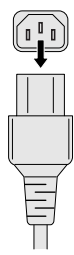
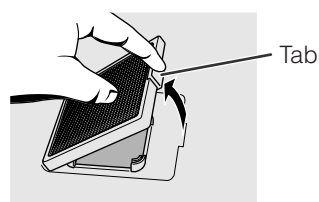
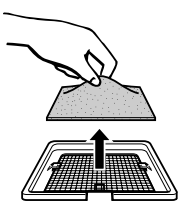
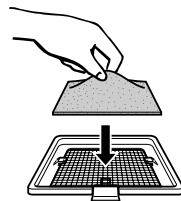
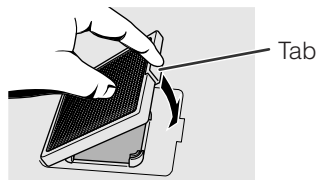
<p><b>1 Turn off the power.</b></p> <p>Press <b>POWER OFF</b>. Wait until the cooling fan stops. Push the antenna completely down to its resting position.</p> 	<p><b>2 Disconnect the power cord.</b></p> <p>Unplug the power cord from the AC socket.</p> 	<p><b>3 Remove the bottom filter cover.</b></p> <p>Turn over the projector. Press the tab and lift open the filter cover in the direction of the arrow.</p> 
<p><b>4 Remove the air filter.</b></p> <p>Grasp the air filter between your fingers and lift it out of the filter cover.</p> 	<p><b>5 Replace the air filter.</b></p> <p>Place the air filter underneath the tabs on the filter frame.</p> 	<p><b>6 Replace the filter cover.</b></p> <p>Insert the tab on the end of the filter cover into the filter cover opening and press the filter cover into position.</p> 





## Replacing the Lamp

### 7 Remove the lamp cage cover.

Turn over the projector and loosen the user service screw that secures the lamp cage cover. Then slide the cover in the direction of the arrow.

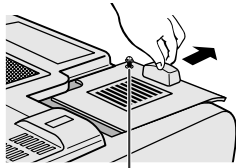

User service screw

### 8 Remove the lamp cage.

Remove the securing screws from the lamp cage. Hold the lamp cage by the handle and pull it towards you.

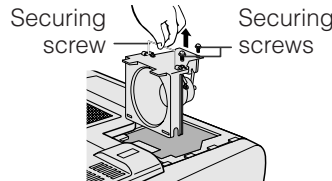

### 9 Insert the new lamp cage.

Press the lamp cage firmly into the lamp cage compartment. Fasten the securing screws.

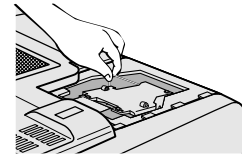

### 10 Attach the lamp cage cover.

Slide the lamp cage cover in the direction of the arrow. Then tighten the user service screw.

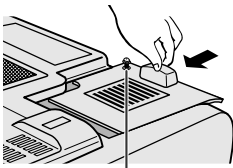

User service screw

## Resetting the lamp timer

### 1 Connect the power cord.

Plug the power cord into the AC socket of the projector.

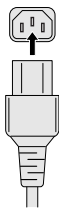

### 2 Reset the lamp timer.

While pressing **▼**, **▶** and **ENTER** on the projector, press **POWER ON** on the projector.

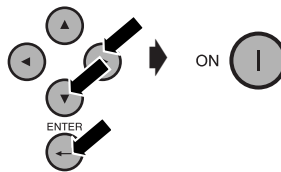

"LAMP 0000H" is displayed, indicating that the lamp timer is reset.

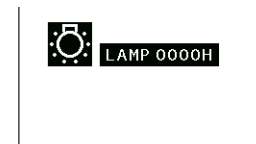

#### NOTE

- Reset the lamp timer only after replacing the lamp.





# Replacing the Air Filter

- This projector is equipped with two air filters to ensure the optimal operating condition of the projector.
- The air filters should be cleaned every 100 hours of use. Clean the filters more often when the projector is used in a dusty or smoky location.
- Have your nearest Authorized Sharp Industrial LCD Products Dealer or Service Center exchange the filter (PFILD0080CEZZ) when it is no longer possible to clean it.

## Bottom View

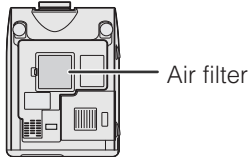

## Side and Rear View

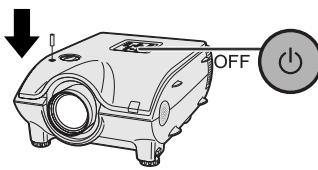
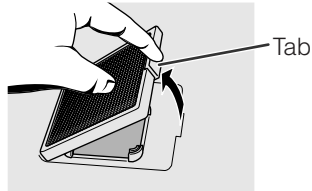
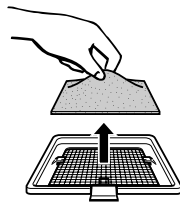
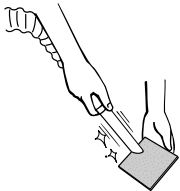
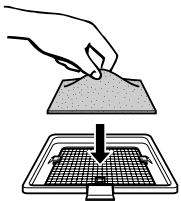
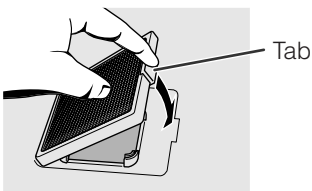

## Cleaning and replacing the bottom air filter

<p><b>1 Turn off the power and disconnect the power cord.</b></p> <p>Press <b>POWER OFF</b>. Wait until the cooling fan stops. Push the antenna completely down to its resting position.</p> 	<p><b>2 Remove the bottom filter cover.</b></p> <p>Turn over the projector. Press the tab and lift open the filter cover in the direction of the arrow.</p> 	<p><b>3 Remove the air filter.</b></p> <p>Grasp the air filter between your fingers and lift it out of the filter cover.</p> 
<p><b>4 Clean the air filter.</b></p> <p>Clean the dust off the air filter and cover with a vacuum cleaner extension hose.</p> 	<p><b>5 Replace the air filter.</b></p> <p>Place the air filter underneath the tabs on the filter frame.</p> 	<p><b>6 Replace the filter cover.</b></p> <p>Insert the tab on the end of the filter cover into the filter cover opening and press the filter cover into position.</p> 

### NOTE

- Be sure the filter cover is securely installed. The power will not turn on unless it is correctly installed.

## Cleaning the side air filter (not removable)

If dust or dirt has collected inside the air filter, clean the filter with a vacuum cleaner extension hose.

### NOTE

- The side air filter cannot be removed.





# Troubleshooting

Problem	Check
Power cannot be turned on or off using the POWER buttons (ON/OFF) on the projector.	<ul style="list-style-type: none"> <li>• Keylock level is set to “Level A” or “Level B”, preventing operation of some or all buttons. (See page <a href="#">58</a>.)</li> </ul>
Cannot be operated by GyroRemote.	<ul style="list-style-type: none"> <li>• Register GyroRemote once again the projector. (See page <a href="#">37</a>.)</li> <li>• When the GyroRemote is connected to the projector with wired remote control cable, confirm the position of the IR/Gyro switch. (See page <a href="#">38</a>.)</li> <li>• When the projector is set to slave, use the buttons on the master projector or change the setting by RS-232C commands from the computer. (See page <a href="#">58</a>.)</li> </ul>
Cannot be operated by all buttons of the projector and GyroRemote.	<ul style="list-style-type: none"> <li>• When using slave setting in combination with Keylock Level B, all the buttons on the projector and the GyroRemote are disabled. Use the SAPS or RS-232C commands to release slave and Keylock setting and enable buttons to operate. Without a computer, you can release slave and Keylock setting by entering the buttons on the projector as follows. <i>ON → ENTER → ON → ENTER → ON → ENTER → MENU</i> However, this operation also releases the password set.</li> </ul>
No picture and no sound.	<ul style="list-style-type: none"> <li>• Projector power cord is not plugged into the wall outlet.</li> <li>• The bottom filter cover is not securely installed.</li> <li>• Selected input is wrong. (See page <a href="#">39</a>.)</li> <li>• Cables incorrectly connected to rear panel of the projector. (See pages <a href="#">13</a>–<a href="#">18</a>.)</li> <li>• GyroRemote batteries have run down. (See page <a href="#">11</a>.)</li> </ul>
Sound is heard but no picture appears.	<ul style="list-style-type: none"> <li>• Cables incorrectly connected to rear panel of the projector. (See pages <a href="#">13</a>–<a href="#">18</a>.)</li> <li>• “Contrast” and “Bright” adjustments are set to minimum position. (See page <a href="#">47</a>.)</li> <li>• On-screen Display (“BLACK SCREEN”) is turned off and Black Screen function is turned on, creating a black image. (See page <a href="#">40</a>.)</li> </ul>
Color is faded or poor.	<ul style="list-style-type: none"> <li>• “Color” and “Tint” adjustments are not correct. (See page <a href="#">47</a>.)</li> </ul>
Picture is blurred.	<ul style="list-style-type: none"> <li>• Adjust the focus. (See page <a href="#">21</a>.)</li> <li>• Projection distance is too long or too short to allow for proper focus. (See pages <a href="#">22</a>–<a href="#">28</a>.)</li> </ul>
Picture appears but no sound is heard.	<ul style="list-style-type: none"> <li>• Cables incorrectly connected to rear panel of the projector. (See pages <a href="#">13</a>–<a href="#">18</a>.)</li> <li>• Volume is set to minimum. (See page <a href="#">39</a>.)</li> </ul>
No OSD appears.	<ul style="list-style-type: none"> <li>• OSD Display is set to “Level A” or “Level B”, preventing to display some or all On-screen Displays. (See page <a href="#">54</a>.)</li> </ul>
An unusual sound is occasionally heard from the cabinet.	<ul style="list-style-type: none"> <li>• If the picture is normal, the sound is due to cabinet shrinkage caused by temperature changes. This will not affect operation or performance.</li> </ul>
Maintenance indicator lights up.	<ul style="list-style-type: none"> <li>• Refer to “Lamp/Maintenance Indicators” on page <a href="#">67</a>.</li> </ul>
Picture noise appears.	<ul style="list-style-type: none"> <li>• Adjust the “Phase” setting. (See page <a href="#">49</a>.)</li> <li>• Noise may appear when used with certain computers. Set the NOISE FILTER to ON using the RS-232C command. (See pages <a href="#">73</a>–<a href="#">75</a>.)</li> </ul>
480P images do not appear.	<ul style="list-style-type: none"> <li>• Set the resolution mode to 480P. (See page <a href="#">50</a>.)</li> </ul>
Image is green on INPUT 1 or 2 COMPONENT. Image is pink (no green) on INPUT 1, 2 RGB.	<ul style="list-style-type: none"> <li>• Change the input signal type. (See page <a href="#">47</a>.)</li> </ul>
Lens comes off.	<ul style="list-style-type: none"> <li>• Align the mark on the lens with the corresponding mark on the projector, push the lens firmly in place, and rotate to the right.</li> </ul>



## For SHARP Assistance (U.S.A. only)

If you encounter any problems during setup or operation of this projector, first refer to the “Troubleshooting” section on this page. If this operation manual does not answer your question, please call toll free 1-888-GO-SHARP (1-888-467-4277) for further assistance. Or, send us an e-mail at [lcdsupport@sharplcd.com](mailto:lcdsupport@sharplcd.com). Our World Wide Web address is <http://www.sharplcd.com>.





# Connecting Pin Assignments

**INPUT 1 RGB and OUTPUT (INPUT 1, 2) Signal Ports:** 15-pin Mini D-sub female connector

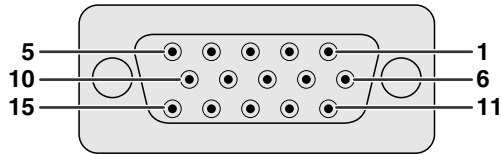

## RGB Input

Analog

- |                                      |                            |
|--------------------------------------|----------------------------|
| 1. Video input (red)                 | 8. Earth (blue)            |
| 2. Video input (green/sync on green) | 9. Not connected           |
| 3. Video input (blue)                | 10. GND                    |
| 4. Reserve input 1                   | 11. GND                    |
| 5. Composite sync                    | 12. Bi-directional data    |
| 6. Earth (red)                       | 13. Horizontal sync signal |
| 7. Earth (green/sync on green)       | 14. Vertical sync signal   |
|                                      | 15. Data clock             |

## Component Input

Analog

- |                  |                   |
|------------------|-------------------|
| 1. PR (CR)       | 9. Not connected  |
| 2. Y             | 10. Not connected |
| 3. PB (CB)       | 11. Not connected |
| 4. Not connected | 12. Not connected |
| 5. Not connected | 13. Not connected |
| 6. Earth (PR)    | 14. Not connected |
| 7. Earth (Y)     | 15. Not connected |
| 8. Earth (PB)    |                   |

**RS-232C Port:** 9-pin D-sub male connector of the DIN-D-sub RS-232C cable

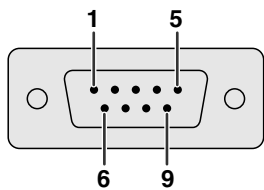

Pin No.	Signal	Name	I/O	Reference
1	CD			Not connected
2	RD	Receive Data	Input	Connected to internal circuit
3	SD	Send Data	Output	Connected to internal circuit
4	ER			Not connected
5	SG	Signal Ground		Connected to internal circuit
6	DR	Data Set Ready	Output	Not connected
7	RS	Request to Send	Output	Connected to internal circuit
8	CS	Clear to Send	Input	Connected to internal circuit
9	CI			Not connected

**INPUT 3 DVI Port:** 29-pin

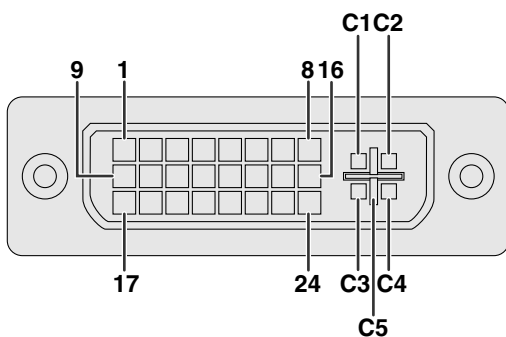

Pin No.	Name
1	T.M.D.S. Data 2 -
2	T.M.D.S. Data 2 +
3	T.M.D.S. Data 2/4 Shield
4	T.M.D.S. Data 4 - * <sup>3</sup>
5	T.M.D.S. Data 4 + * <sup>3</sup>
6	DDC Clock
7	DDC Data
8	Analog Vertical Sync
9	T.M.D.S. Data 1 -
10	T.M.D.S. Data 1 +
11	T.M.D.S. Data 1/3 Shield
12	T.M.D.S. Data 3 - * <sup>3</sup>
13	T.M.D.S. Data 3 + * <sup>3</sup>
14	+5 V Power
15	Ground* <sup>1</sup>
16	Hot Plug Detect
17	T.M.D.S. Data 0 -
18	T.M.D.S. Data 0 +
19	T.M.D.S. Data 0/5 Shield
20	T.M.D.S. Data 5 - * <sup>3</sup>
21	T.M.D.S. Data 5 + * <sup>3</sup>
22	T.M.D.S. Clock Shield
23	T.M.D.S. Clock +
24	T.M.D.S. Clock -
C1	Analog Red
C2	Analog Green
C3	Analog Blue
C4	Analog Horizontal sync
C5	Analog Ground* <sup>2</sup>

### NOTE

- \*<sup>1</sup> Return for +5 V, Hsync. and Vsync.
- \*<sup>2</sup> Analog R, G and B return
- \*<sup>3</sup> These pins are not used on this equipment.





# (RS-232C) Specifications and Command Settings

## PC control

A computer can be used to control the projector by connecting an RS-232C cable (null modem, cross type, sold separately) to the projector. (See page 16 for connection.)

## Communication conditions

Set the serial port settings of the computer to match that of the table.

Signal format: Conforms to RS-232C standard.

Baud rate: 9,600 bps

Data length: 8 bits

Parity bit: None

Stop bit: 1 bit

Flow control: None

## Basic format

Commands from the computer are sent in the following order: command, parameter, and return code. After the projector processes the command from the computer, it sends a response code to the computer.

Command format

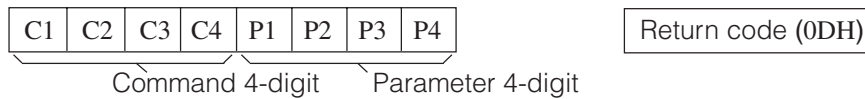

Response code format

Normal response



Problem response (communication error or incorrect command)



When more than one code is being sent, send each command only after the OK response code for the previous command from the projector is verified.

### NOTE

- When using the computer control function of the projector, the projector operating status cannot be read to the computer. Therefore, confirm the status by transmitting the display commands for each adjustment menu and checking the status with the On-screen Display. If the projector receives a command other than a menu display command, it will execute the command without displaying the On-screen Display.

## Commands

### EXAMPLE

- When "BRIGHT" of INPUT 1 (RGB 1) image adjustment is set to -10.

Computer

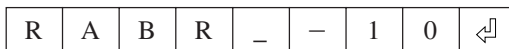

Projector

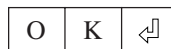

	CONTROL CONTENTS	COMMAND	PARAMETER	RETURN
BUTTONS & REMOTE CONTROL KEY	POWER ON	P O W R	- - - 1	OK OR ERR
	POWER OFF	P O W R	- - - 0	OK OR ERR
	VOLUME (0 - 60)	V O L A	- * *	OK OR ERR
	MUTE ON	M U T E	- - - 1	OK OR ERR
	MUTE OFF	M U T E	- - - 0	OK OR ERR
	LENS FOCUS (-30 - +30)	L N F O	- * *	OK OR ERR
	LENS ZOOM (-30 - +30)	L N Z O	- * *	OK OR ERR
	KEystone (-127 - +127)	K E Y S	- * *	OK OR ERR
	V-SIZE (-30 - +30)	V S I Z	- * *	OK OR ERR
	DIGITAL SHIFT (-96 - +96)	L N D S	- * *	OK OR ERR

	CONTROL CONTENTS	COMMAND	PARAMETER	RETURN
BUTTONS & REMOTE CONTROL KEY	BLACK SCREEN ON	I M B K	- - - 1	OK OR ERR
	BLACK SCREEN OFF	I M B K	- - - 0	OK OR ERR
	INPUT 1 (RGB 1)	I R G B	- - - 1	OK OR ERR
	INPUT 2 (RGB 2)	I R G B	- - - 2	OK OR ERR
	INPUT 3 (RGB 3)	I R G B	- - - 3	OK OR ERR
	INPUT 4 (VIDEO 1)	I V E D	- - - 1	OK OR ERR
	INPUT 5 (VIDEO 2)	I V E D	- - - 2	OK OR ERR
	INPUT CHECK	I C H K	- - - 0	OK OR ERR
	FREEZE ON	F R E Z	- - - 1	OK OR ERR
	FREEZE OFF	F R E Z	- - - 0	OK OR ERR
AUTO SYNC START	A D J S	- - - 1	OK OR ERR	



# (RS-232C) Specifications and Command Settings

	CONTROL CONTENTS	COMMAND	PARAMETER	RETURN	
<b>BUTTONS &amp; REMOTE CONTROL KEY</b>	INPUT 1 (RGB 1) RESIZE : NORMAL	R A S R	-- --	1 OK OR ERR	
	INPUT 1 (RGB 1) RESIZE : FULL	R A S R	-- --	5 OK OR ERR	
	INPUT 1 (RGB 1) RESIZE : DOT BY DOT	R A S R	-- --	3 OK OR ERR	
	INPUT 2 (RGB 2) RESIZE : NORMAL	R B S R	-- --	1 OK OR ERR	
	INPUT 2 (RGB 2) RESIZE : FULL	R B S R	-- --	5 OK OR ERR	
	INPUT 2 (RGB 2) RESIZE : DOT BY DOT	R B S R	-- --	3 OK OR ERR	
	INPUT 3 (RGB 3) RESIZE : NORMAL	R C S R	-- --	1 OK OR ERR	
	INPUT 3 (RGB 3) RESIZE : FULL	R C S R	-- --	5 OK OR ERR	
	INPUT 3 (RGB 3) RESIZE : DOT BY DOT	R C S R	-- --	3 OK OR ERR	
	INPUT 4 (VIDEO 1) RESIZE : NORMAL	R A S V	-- --	1 OK OR ERR	
	INPUT 4 (VIDEO 1) RESIZE : FULL	R A S V	-- --	5 OK OR ERR	
	INPUT 4 (VIDEO 1) RESIZE : BORDER	R A S V	-- --	3 OK OR ERR	
	INPUT 4 (VIDEO 1) RESIZE : STRETCH	R A S V	-- --	2 OK OR ERR	
	INPUT 4 (VIDEO 1) RESIZE : SMART STRETCH	R A S V	-- --	4 OK OR ERR	
	INPUT 5 (VIDEO 2) RESIZE : NORMAL	R B S V	-- --	1 OK OR ERR	
	INPUT 5 (VIDEO 2) RESIZE : FULL	R B S V	-- --	5 OK OR ERR	
	INPUT 5 (VIDEO 2) RESIZE : BORDER	R B S V	-- --	3 OK OR ERR	
	INPUT 5 (VIDEO 2) RESIZE : STRETCH	R B S V	-- --	2 OK OR ERR	
	INPUT 5 (VIDEO 2) RESIZE : SMART STRETCH	R B S V	-- --	4 OK OR ERR	
	RGB GAMMA : STANDARD	G A M R	-- --	1 OK OR ERR	
	RGB GAMMA : PRESENTATION	G A M R	-- --	2 OK OR ERR	
	RGB GAMMA : CINEMA	G A M R	-- --	3 OK OR ERR	
	RGB GAMMA : CUSTOM	G A M R	-- --	4 OK OR ERR	
	VIDEO GAMMA : STANDARD	G A M V	-- --	1 OK OR ERR	
	VIDEO GAMMA : PRESENTATION	G A M V	-- --	2 OK OR ERR	
	VIDEO GAMMA : CINEMA	G A M V	-- --	3 OK OR ERR	
	VIDEO GAMMA : CUSTOM	G A M V	-- --	4 OK OR ERR	
	<b>PICTURE</b>	INPUT 1 (RGB 1) CONTRAST (-30 - +30)	R A P I	** *	OK OR ERR
		INPUT 1 (RGB 1) BRIGHT (-30 - +30)	R A B R	** *	OK OR ERR
		INPUT 1 (RGB 1) RED (-30 - +30)	R A R D	** *	OK OR ERR
		INPUT 1 (RGB 1) BLUE (-30 - +30)	R A B E	** *	OK OR ERR
		INPUT 1 (RGB 1) COLOR (-30 - +30)	R A C O	** *	OK OR ERR
		INPUT 1 (RGB 1) TINT (-30 - +30)	R A T I	** *	OK OR ERR
		INPUT 1 (RGB 1) SHARP (-30 - +30)	R A S H	** *	OK OR ERR
		INPUT 1 (RGB 1) CLR TEMP (-3 - +3)	R A C T	** *	OK OR ERR
		INPUT 1 (RGB 1) DISPLAY	R A R E	0	OK OR ERR
INPUT 1 (RGB 1) ADJUSTMENT RESET		R A R E	1	OK OR ERR	
INPUT 2 (RGB 2) CONTRAST (-30 - +30)		R B P I	** *	OK OR ERR	
INPUT 2 (RGB 2) BRIGHT (-30 - +30)		R B B R	** *	OK OR ERR	
INPUT 2 (RGB 2) RED (-30 - +30)		R B R D	** *	OK OR ERR	
INPUT 2 (RGB 2) BLUE (-30 - +30)		R B B E	** *	OK OR ERR	
INPUT 2 (RGB 2) COLOR (-30 - +30)		R B C O	** *	OK OR ERR	
INPUT 2 (RGB 2) TINT (-30 - +30)		R B T I	** *	OK OR ERR	
INPUT 2 (RGB 2) SHARP (-30 - +30)		R B S H	** *	OK OR ERR	
INPUT 2 (RGB 2) CLR TEMP (-3 - +3)		R B C T	** *	OK OR ERR	
INPUT 2 (RGB 2) DISPLAY		R B R E	0	OK OR ERR	
INPUT 2 (RGB 2) ADJUSTMENT RESET		R B R E	1	OK OR ERR	
INPUT 3 (RGB 3) CONTRAST (-30 - +30)		R C P I	** *	OK OR ERR	
INPUT 3 (RGB 3) BRIGHT (-30 - +30)		R C B R	** *	OK OR ERR	
INPUT 3 (RGB 3) RED (-30 - +30)		R C R D	** *	OK OR ERR	
INPUT 3 (RGB 3) BLUE (-30 - +30)		R C B E	** *	OK OR ERR	
INPUT 3 (RGB 3) COLOR (-30 - +30)		R C C O	** *	OK OR ERR	
INPUT 3 (RGB 3) TINT (-30 - +30)		R C T I	** *	OK OR ERR	
INPUT 3 (RGB 3) SHARP (-30 - +30)		R C S H	** *	OK OR ERR	
INPUT 3 (RGB 3) CLR TEMP (-3 - +3)		R C C T	** *	OK OR ERR	
INPUT 3 (RGB 3) DISPLAY		R C R E	0	OK OR ERR	
INPUT 3 (RGB 3) ADJUSTMENT RESET		R C R E	1	OK OR ERR	

	CONTROL CONTENTS	COMMAND	PARAMETER	RETURN	
<b>PICTURE</b>	INPUT 1 (RGB 1) SIGNAL TYPE : RGB	I A S I	-- --	0 OK OR ERR	
	INPUT 1 (RGB 1) SIGNAL TYPE : COMPONENT	I A S I	-- --	1 OK OR ERR	
	INPUT 2 (RGB 2) SIGNAL TYPE : RGB	I B S I	-- --	0 OK OR ERR	
	INPUT 2 (RGB 2) SIGNAL TYPE : COMPONENT	I B S I	-- --	1 OK OR ERR	
	INPUT 1 (RGB 1) 2D PROGRESSIVE	R A I P	-- --	0 OK OR ERR	
	INPUT 1 (RGB 1) 3D PROGRESSIVE	R A I P	-- --	1 OK OR ERR	
	INPUT 1 (RGB 1) Film MODE	R A I P	-- --	2 OK OR ERR	
	INPUT 2 (RGB 2) 2D PROGRESSIVE	R B I P	-- --	0 OK OR ERR	
	INPUT 2 (RGB 2) 3D PROGRESSIVE	R B I P	-- --	1 OK OR ERR	
	INPUT 2 (RGB 2) Film MODE	R B I P	-- --	2 OK OR ERR	
	INPUT 3 (RGB 3) 2D PROGRESSIVE	R C I P	-- --	0 OK OR ERR	
	INPUT 3 (RGB 3) 3D PROGRESSIVE	R C I P	-- --	1 OK OR ERR	
	INPUT 3 (RGB 3) Film MODE	R C I P	-- --	2 OK OR ERR	
	INPUT 4 (VIDEO 1) CONTRAST (-30 - +30)	V A P I	** *	OK OR ERR	
	INPUT 4 (VIDEO 1) BRIGHT (-30 - +30)	V A B R	** *	OK OR ERR	
	INPUT 4 (VIDEO 1) RED (-30 - +30)	V A R D	** *	OK OR ERR	
	INPUT 4 (VIDEO 1) BLUE (-30 - +30)	V A B E	** *	OK OR ERR	
	INPUT 4 (VIDEO 1) COLOR (-30 - +30)	V A C O	** *	OK OR ERR	
	INPUT 4 (VIDEO 1) TINT (-30 - +30)	V A T I	** *	OK OR ERR	
	INPUT 4 (VIDEO 1) SHARP (-30 - +30)	V A S H	** *	OK OR ERR	
	INPUT 4 (VIDEO 1) CLR TEMP (-3 - +3)	V A C T	** *	OK OR ERR	
	INPUT 4 (VIDEO 1) DISPLAY	V A R E	0	OK OR ERR	
	INPUT 4 (VIDEO 1) ADJUSTMENT RESET	V A R E	1	OK OR ERR	
	INPUT 5 (VIDEO 2) CONTRAST (-30 - +30)	V B P I	** *	OK OR ERR	
	INPUT 5 (VIDEO 2) BRIGHT (-30 - +30)	V B B R	** *	OK OR ERR	
	INPUT 5 (VIDEO 2) RED (-30 - +30)	V B R D	** *	OK OR ERR	
	INPUT 5 (VIDEO 2) BLUE (-30 - +30)	V B B E	** *	OK OR ERR	
	INPUT 5 (VIDEO 2) COLOR (-30 - +30)	V B C O	** *	OK OR ERR	
	INPUT 5 (VIDEO 2) TINT (-30 - +30)	V B T I	** *	OK OR ERR	
	INPUT 5 (VIDEO 2) SHARP (-30 - +30)	V B S H	** *	OK OR ERR	
	INPUT 5 (VIDEO 2) CLR TEMP (-3 - +3)	V B C T	** *	OK OR ERR	
	INPUT 5 (VIDEO 2) DISPLAY	V B R E	0	OK OR ERR	
	INPUT 5 (VIDEO 2) ADJUSTMENT RESET	V B R E	1	OK OR ERR	
	INPUT 4 (VIDEO 1) 2D PROGRESSIVE	V A I P	-- --	0 OK OR ERR	
	INPUT 4 (VIDEO 1) 3D PROGRESSIVE	V A I P	-- --	1 OK OR ERR	
	INPUT 4 (VIDEO 1) Film MODE	V A I P	-- --	2 OK OR ERR	
	INPUT 5 (VIDEO 2) 2D PROGRESSIVE	V B I P	-- --	0 OK OR ERR	
	INPUT 5 (VIDEO 2) 3D PROGRESSIVE	V B I P	-- --	1 OK OR ERR	
	INPUT 5 (VIDEO 2) Film MODE	V B I P	-- --	2 OK OR ERR	
	(INPUT 1-5) 2D PROGRESSIVE	I M I P	-- --	0 OK OR ERR	
	(INPUT 1-5) 3D PROGRESSIVE	I M I P	-- --	1 OK OR ERR	
	(INPUT 1-5) Film MODE	I M I P	-- --	2 OK OR ERR	
	<b>FINE SYNC *</b>	CLOCK (-150 - +150)	I N C L	** *	OK OR ERR
		PHASE (-60 - +60)	I N P H	** *	OK OR ERR
		H-POSITION (-150 - +150)	I A H P	** *	OK OR ERR
		V-POSITION (-60 - +60)	I A V P	** *	OK OR ERR
		RGB INPUT DISPLAY	I A R E	0	OK OR ERR
		RGB ADJUSTMENT RESET	I A R E	1	OK OR ERR
SAVE SETTING (1 - 7)		M E M S	-- --	* OK OR ERR	
SELECT SETTING (1 - 7)		M E M L	-- --	* OK OR ERR	
RGB HORIZONTAL FREQUENCY CHECK		T F R Q	-- --	1 kHz (** * * OR _)	
RGB VERTICAL FREQUENCY CHECK		T F R Q	-- --	2 Hz (** * * OR _)	
AUTO SYNC OFF		A A D J	-- --	0 OK OR ERR	
NORMAL AUTO SYNC		A A D J	-- --	1 OK OR ERR	
HIGH SPEED AUTO SYNC	A A D J	-- --	2 OK OR ERR		
AUTO SYNC DISPLAY ON	I M A S	-- --	1 OK OR ERR		
AUTO SYNC DISPLAY OFF	I M A S	-- --	0 OK OR ERR		





# (RS-232C) Specifications and Command Settings

	CONTROL CONTENTS	COMMAND	PARAMETER	RETURN
AUDIO	BALANCE (-30 - +30)	A A B L	* * *	OK OR ERR
	TREBLE (-30 - +30)	A A T E	* * *	OK OR ERR
	BASS (-30 - +30)	A A B A	* * *	OK OR ERR
	AUDIO DISPLAY	A A R E	0	OK OR ERR
	AUDIO ADJUSTMENT RESET	A A R E	1	OK OR ERR
	FAO	A O U T	1	OK OR ERR
	VAO	A O U T	2	OK OR ERR
	SPEAKER ON	A S P K	1	OK OR ERR
SPEAKER OFF	A S P K	0	OK OR ERR	
OPTIONS (1)	PICT IN PICT : BOTTOM RIGHT	P I N P	1 1	OK OR ERR
	PICT IN PICT : BOTTOM LEFT	P I N P	1 2	OK OR ERR
	PICT IN PICT : UPPER RIGHT	P I N P	1 3	OK OR ERR
	PICT IN PICT : UPPER LEFT	P I N P	1 4	OK OR ERR
	PICT IN PICT RESET	P I N P	0	OK OR ERR
	VIDEO DNR OFF	3 D N R	0	OK OR ERR
	VIDEO DNR ON	3 D N R	1	OK OR ERR
	OSD DISPLAY ON	I M D I	1	OK OR ERR
	OSD DISPLAY OFF (LEVEL A)	I M D I	2	OK OR ERR
	OSD DISPLAY OFF (LEVEL B)	I M D I	0	OK OR ERR
	BLACK SCREEN DISPLAY ON	I M B O	1	OK OR ERR
	BLACK SCREEN DISPLAY OFF	I M B O	0	OK OR ERR
	VIDEO SYSTEM SELECTION : AUTO	M E S Y	1	OK OR ERR
	VIDEO SYSTEM SELECTION : PAL	M E S Y	2	OK OR ERR
	VIDEO SYSTEM SELECTION : SECAM	M E S Y	3	OK OR ERR
	VIDEO SYSTEM SELECTION : NTSC4.43	M E S Y	4	OK OR ERR
	VIDEO SYSTEM SELECTION : NTSC3.58	M E S Y	5	OK OR ERR
	VIDEO SYSTEM SELECTION : PAL_M	M E S Y	6	OK OR ERR
	VIDEO SYSTEM SELECTION : PAL_N	M E S Y	7	OK OR ERR
	BACKGROUND SELECTION : SHARP	I M B G	1	OK OR ERR
	BACKGROUND SELECTION : CUSTOM	I M B G	2	OK OR ERR
	BACKGROUND SELECTION : BLUE	I M B G	3	OK OR ERR
	BACKGROUND SELECTION : NONE	I M B G	4	OK OR ERR
	STARTUP IMAGE SELECTION : SHARP	I M S I	1	OK OR ERR
	STARTUP IMAGE SELECTION : CUSTOM	I M S I	2	OK OR ERR
	STARTUP IMAGE SELECTION : NONE	I M S I	3	OK OR ERR
	MONITOR OUT OFF	M O U T	0	OK OR ERR
	MONITOR OUT ON	M O U T	1	OK OR ERR
	AUTO POWER OFF : NO USE	A P O W	0	OK OR ERR
	AUTO POWER OFF : USE	A P O W	1	OK OR ERR

	CONTROL CONTENTS	COMMAND	PARAMETER	RETURN
OPTIONS (2)	LAMP USAGE TIME	T L T T	1	0-9999 (INTEGER)
	LAMP STATUS	T L P S	1	0:OFF, 1:ON, 2:RETRY, 3:WAITING, 4:LAMP ERROR
	PRJ MODE : REVERSE OFF	I M R E	0	OK OR ERR
	PRJ MODE : REVERSE ON	I M R E	1	OK OR ERR
	PRJ MODE : INVERT OFF	I M I N	0	OK OR ERR
	PRJ MODE : INVERT ON	I M I N	1	OK OR ERR
	STACK SETTING : NORMAL	S T A K	0	OK OR ERR
	STACK SETTING : MASTER	S T A K	1	OK OR ERR
	STACK SETTING : SLAVE	S T A K	2	OK OR ERR
	KEYLOCK LEVEL : NORMAL	K E Y L	0	OK OR ERR
	KEYLOCK LEVEL : LEVEL A	K E Y L	1	OK OR ERR
	KEYLOCK LEVEL : LEVEL B	K E Y L	2	OK OR ERR
	SET INPUTS : INPUT 1 NO USE	R A S I	0	OK OR ERR
	SET INPUTS : INPUT 1 USE	R A S I	1	OK OR ERR
	SET INPUTS : INPUT 2 NO USE	R B S I	0	OK OR ERR
	SET INPUTS : INPUT 2 USE	R B S I	1	OK OR ERR
	SET INPUTS : INPUT 3 NO USE	R C S I	0	OK OR ERR
	SET INPUTS : INPUT 3 USE	R C S I	1	OK OR ERR
	SET INPUTS : INPUT 4 NO USE	V A S I	0	OK OR ERR
	SET INPUTS : INPUT 4 USE	V A S I	1	OK OR ERR
SET INPUTS : INPUT 5 NO USE	V B S I	0	OK OR ERR	
SET INPUTS : INPUT 5 USE	V B S I	1	OK OR ERR	
ID NO. CHECK	R D I D	1	001-250	
LANGUAGE	LANGUAGE SELECTION : ENGLISH	M E L A	0	OK OR ERR
	LANGUAGE SELECTION : DEUTSCH	M E L A	1	OK OR ERR
	LANGUAGE SELECTION : ESPAÑOL	M E L A	2	OK OR ERR
	LANGUAGE SELECTION : NEDERLANDS	M E L A	3	OK OR ERR
	LANGUAGE SELECTION : FRANÇAIS	M E L A	4	OK OR ERR
	LANGUAGE SELECTION : ITALIANO	M E L A	5	OK OR ERR
	LANGUAGE SELECTION : SVENSKA	M E L A	6	OK OR ERR
	LANGUAGE SELECTION : 日本語	M E L A	7	OK OR ERR
	LANGUAGE SELECTION : PORTUGUÊS	M E L A	8	OK OR ERR
	LANGUAGE SELECTION : 汉语	M E L A	9	OK OR ERR
	LANGUAGE SELECTION : 한국어	M E L A	10	OK OR ERR
	MODEL NAME CHECK	M N R D	1	MODEL NAME
NOISE FILTER OFF	N F I L	0	OK OR ERR	
NOISE FILTER ON <sup>2</sup>	N F I L	1	OK OR ERR	
SERIAL NO. CHECK <sup>3</sup>	S N R D	1	SERIAL NO.	
PROJECTOR NAME SETTING <sup>4</sup>	P J N A	1	OK OR ERR	
PROJECTOR NAME CHECK	P J N A	2	PROJECTOR NAME	

## NOTE

- If an underbar ( \_ ) appears in the parameter column, enter a space. If an asterisk ( \* ) appears, enter a value in the range indicated in brackets under CONTROL CONTENTS.
- <sup>1</sup> FINE SYNC can only be set in the displayed RGB mode.
- <sup>2</sup> Noise may appear when used with certain computers. Set the NOISE FILTER to ON using the RS-232C command.
- <sup>3</sup> SERIAL NO. CHECK command is used to read out the 12 digits of serial No..
- <sup>4</sup> After OK is returned, enter PROJECTOR NAME, up to 12-character memory. The PROJECTOR NAME in memory can then be output (confirmed).



# Wired Remote Control Terminal Specifications

## Specifications of wired remote control input

- ø3.5 mm minijack
- External: +5 V (1 A)
- Internal: GND

## Function and transmission codes

CONTROL ITEM	SYSTEM CODE					DATA CODE						EXTERNAL CODE			
	C1	C2	C3	C4	C5	C6	C7	C8	C9	C10	C11	C12	C13	C14	C15
ON	1	0	1	1	0	0	1	1	0	1	0	1	0	1	0
OFF	1	0	1	1	0	0	1	1	0	1	0	0	1	1	0
VOLUME +	1	0	1	1	0	0	0	1	0	1	0	0	0	1	0
VOLUME -	1	0	1	1	0	1	0	1	0	1	0	0	0	1	0
MUTE	1	0	1	1	0	1	1	1	0	1	0	0	0	1	0
MENU	1	0	1	1	0	0	0	1	0	0	0	1	1	1	0
LENS	1	0	1	1	0	1	1	0	1	0	0	0	1	1	0
BLACK SCREEN	1	0	1	1	0	1	0	0	1	0	1	1	0	1	0
ENTER	1	0	1	1	0	1	1	1	0	1	0	1	0	1	0
RESIZE	1	0	1	1	0	0	1	1	1	1	0	1	0	1	0
UNDO	1	0	1	1	0	1	0	0	1	1	0	1	0	1	0

CONTROL ITEM	SYSTEM CODE					DATA CODE						EXTERNAL CODE			
	C1	C2	C3	C4	C5	C6	C7	C8	C9	C10	C11	C12	C13	C14	C15
Freeze	1	0	1	1	0	1	0	1	1	0	0	0	1	1	0
Enlarge	1	0	1	1	0	1	0	1	1	0	1	1	0	1	0
AUTO SYNC	1	0	1	1	0	0	1	0	1	1	1	1	1	1	0
▲	1	0	1	1	0	0	0	1	1	1	1	0	0	1	1
▼	1	0	1	1	0	1	0	1	1	1	1	0	0	1	1
◀	1	0	1	1	0	0	0	0	0	1	0	1	1	0	1
▶	1	0	1	1	0	1	1	1	1	1	0	0	1	0	1
GAMMA	1	0	1	1	0	0	0	0	0	0	0	0	1	0	1
INPUT 1.2.3	1	0	1	1	0	0	0	1	1	0	1	1	1	1	0
INPUT 4.5	1	0	1	1	0	0	1	1	0	1	1	0	1	1	1

### NOTE

- To operate the mouse, left-click and right-click functions through the wired remote control input, connect the cable from the WIRED REMOTE control input terminal on the projector to the remote control. The codes for these functions are complex and are, therefore, not listed here.

### Wired remote control function code

LSB										MSB				
C1	C2	C3	C4	C5	C6	C7	C8	C9	C10	C11	C12	C13	C14	C15
1	0	1	1	0	*	*	*	*	*	*	*	*	1	0

- System codes C1 to C5 are fixed at "10110".
- Codes C14 and C15 are reverse confirmation bits, with "10" indicating "Front" and "01" indicating "Rear".

## Sharp remote control signal format

### Transmission format: 15-bit format

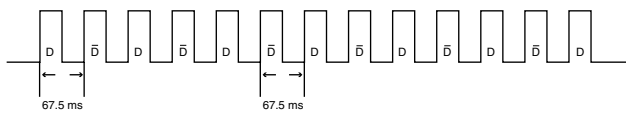

### Wave form of output signal: Output using Pulse Position Modulation

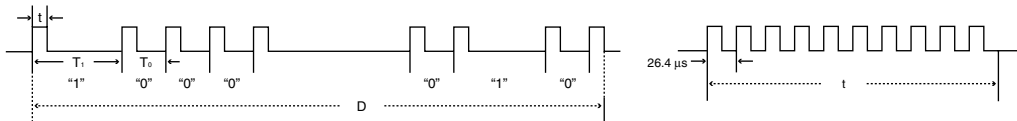

- $t = 264 \mu\text{s}$
- $T_0 = 1.05 \text{ ms}$
- $T_1 = 2.10 \text{ ms}$
- Pulse carrier frequency = 455/12 kHz
- Duty ratio = 1:1

### Transmission control code

#### 15 bit

C1	C2	C3	C4	C5	C6	C7	C8	C9	C10	C11	C12	C13	C14	C15
System Address					Function Key Data Bit						Data Expansion	Mask	Data Determination	
D to $\bar{D}$ Common Data Bit					Reverse in $\bar{D}$									

#### Example of Reverse D to $\bar{D}$

D	C1	C2	C3	C4	C5	C6	C7	C8	C9	C10	C11	C12	C13	C14	C15
D	1	0	1	1	0	1	0	0	0	0	0	0	0	1	0
$\bar{D}$	1	0	1	1	0	0	1	1	1	1	1	1	1	0	1





# Computer Compatibility Chart

Horizontal Frequency: 15–126 kHz

Vertical Frequency: 43–200 Hz

Pixel Clock: 12–230 MHz

Compatible with sync on green and composite sync signals

UXGA and SXGA compatible in advanced intelligent compression or intelligent compression

AICS (Advanced Intelligent Compression and Expansion System) resizing technology

PC/MAC/WS	Resolution	Horizontal Frequency (kHz)	Vertical Frequency (Hz)	VESA Standard	Display					
PC	VGA	640 × 350	27.0	60	×	Upscale				
			31.5	70						
			37.9	85						
		720 × 350	27.0	60	×					
			31.5	70						
			37.9	85						
	640 × 400	640 × 400	27.0	60	×					
			31.5	70						
			37.9	85						
	720 × 400	720 × 400	27.0	60	×					
			31.5	70						
			37.9	85						
	640 × 480	640 × 480	26.2	50	×					
			31.5	60						
			34.7	70						
			37.9	72						
			37.5	75						
			43.3	85						
			47.9	90						
			53.0	100						
			61.8	120						
			78.5	150						
			80.9	160						
			100.4	200						
	SVGA	800 × 600	31.4	50	×					
			35.1	56						
			37.9	60						
			44.5	70						
			48.1	72						
			46.9	75						
53.7			85							
56.8			90							
64.0			100							
77.2			120							
98.3			150							
102.1			160							
125.6	200									
XGA	1,024 × 768	35.5	43	×						
		40.3	50							
		56.5	70							
		58.1	72							
		68.7	85							
		73.5	90							
		77.2	96							
		80.6	100							
		98.8	120							
		113.2	140							
		125.6	150							
		PC	SXGA		1,152 × 864	54.3	60	×	Advanced Intelligent Compression	
64.0	70									
64.1	72									
67.5	75									
75.7	80									
77.3	85									
90.2	100									
111.1	120									
54.8	60			×						
65.9	72									
67.4	74									
64.0	60									
74.6	70									
78.1	74									
75.7	75									
91.1	85									
108.4	100									
UXGA	1,600 × 1,200		74.7		52	×	Intelligent Compression			
			75.0		60					
			81.3		65					
			87.5	70						
			90.1	72						
			93.8	75						
			106.3	85						
		PC/MAC 13"	VGA	640 × 480	34.9			67		Upscale
		PC/MAC 19"	XGA	1,024 × 768	48.4			60	×	True
					60.0			75		
		PC/MAC 21"	SXGA	1,280 × 1,024	80.0			75	×	Advanced Intelligent Compression
		MAC 16"	SVGA	832 × 624	46.8			75		Upscale
49.6	75									
MAC 21"	SXGA	1,152 × 870	68.5	75	×	Advanced Intelligent Compression				
HP (WS)	SXGA	1,280 × 1,024	78.1	72						
PC (WS)		1,280 × 960	60.0	60						
WS	1,280 × 960	85.9	85							
SGI (WS)	SXGA	1,280 × 1,024	53.5	50						
			76.8	72						
SUN (WS)	SXGA	1,152 × 900	60.9	66						
71.9			76							

**NOTE**

- This projector may not be able to display images from notebook computers in simultaneous (CRT/LCD) mode. Should this occur, turn off the LCD display on the notebook computer and output the display data in "CRT only" mode. Details on how to change display modes can be found in your notebook computer's operation manual.
- This projector can receive 640 × 350 VESA format VGA signals, however, "640 × 400" will appear on the screen.
- When receiving 1,600 × 1,200 VESA format UXGA signals, sampling occurs and the image is displayed with 1,024 lines, causing part of the image to be blocked.



# Dimensions

Rear View

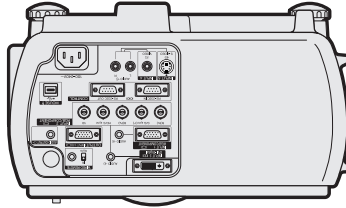

Side View

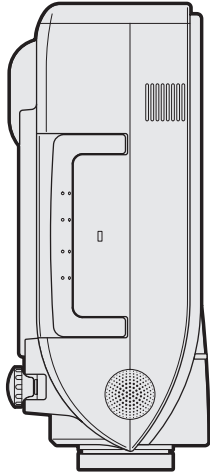

Top View

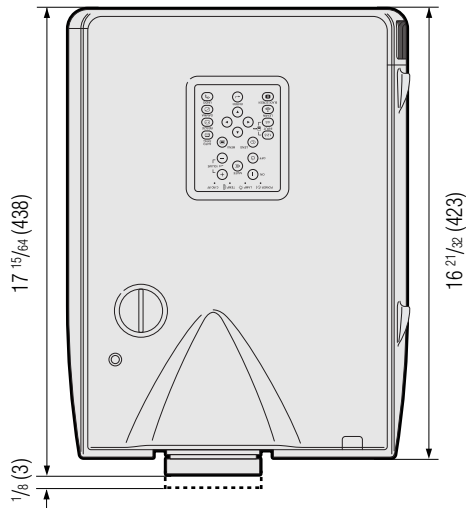

Side View

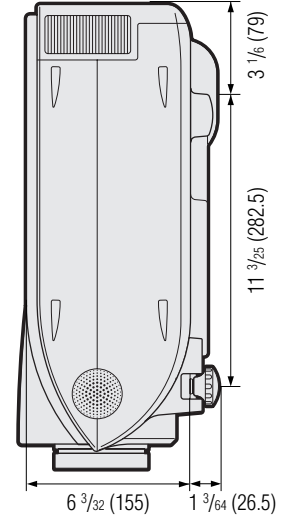

Front View

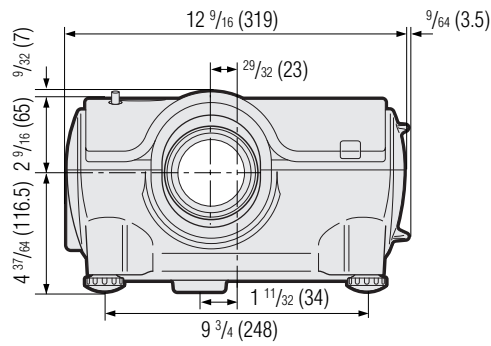

Bottom View

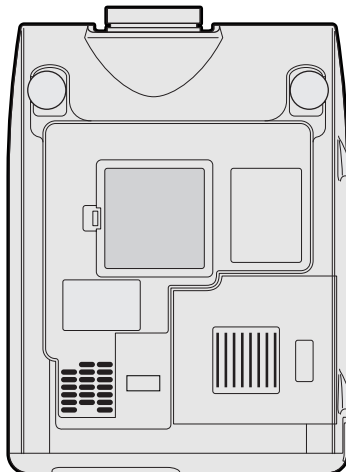

Units: inches (mm)





# Specifications

Product type	LCD Projector
Model	XG-P20XU
Video system	PAL/PAL 60/PAL-M/PAL-N/SECAM/NTSC 3.58/NTSC 4.43 DTV 480P/720P/1080i
Display method	LCD panel × 3, RGB optical shutter method
LCD panel	Panel size: 1.3" (20.0 [H] × 26.6 [W] mm) Display method: Translucent TN liquid crystal panel Drive method: TFT (Thin Film Transistor) Active Matrix panel No. of dots: 786,432 dots (1,024 [H] × 768 [V])
Standard Lens	1–1.3 × zoom lens, F1.7–2.3, f = 49.1–63.8 mm
Projection lamp	AC 220 W lamp
Contrast ratio	600:1
Video input signal	RCA Connector: VIDEO, composite video, 1.0 Vp-p, sync negative, 75 Ω terminated RCA Connector: AUDIO, 0.5 Vrms more than 22 kΩ (stereo)
S-video input signal	4-pin Mini DIN connector Y (luminance signal): 1.0 Vp-p, sync negative, 75 Ω terminated C (chrominance signal): Burst 0.286 Vp-p, 75 Ω terminated
Component input signal	BNC Connector (INPUT 2) Y: 1.0 Vp-p, sync negative, 75 Ω terminated Pb: 0.7 Vp-p, 75 Ω terminated Pr: 0.7 Vp-p, 75 Ω terminated
Horizontal resolution	520 TV lines (S-video input), 750 TV lines (DTV 720P input, STRETCH mode)
RGB input signal	15-PIN MINI D-SUB CONNECTOR (INPUT 1), 5 BNC CONNECTOR (INPUT 2): RGB separate/composite sync/sync on green type analog input: 0–0.7 Vp-p, positive, 75 Ω terminated DVI CONNECTOR (29-PIN) (INPUT 3), RGB (DIGITAL), 250–1,000 mV, 50 Ω HORIZONTAL SYNC. SIGNAL: TTL level (positive/negative) or composite sync (Apple only) VERTICAL SYNC. SIGNAL: Same as above STEREO MINIJACK: AUDIO, 0.5 Vrms, more than 22 kΩ (stereo)
Pixel clock	12–230 MHz
Vertical frequency	43–200 Hz
Horizontal frequency	15–126 kHz
Computer control signal	9-pin D-sub connector (RS-232C Input Port/Output Port)
Speaker system	1 <sup>49</sup> / <sub>64</sub> " (4.5 cm) round × 2 2 W + 2 W (stereo)
Rated voltage	AC 100–240 V
Input current	3.95 A
Rated frequency	50/60 Hz
Power consumption	330 W
Power dissipation	< 1,250 BTU/hour
Operating temperature	41°F to 104°F (+ 5°C to + 40°C)
Storage temperature	– 4°F to 140°F (– 20°C to + 60°C)
Cabinet	Plastic
GyroRemote	Radio Frequency Range: 49.825–49.895 MHz
Dimensions (approx.)	12 <sup>9</sup> / <sub>16</sub> " (W) × 6 <sup>3</sup> / <sub>32</sub> " (H) × 16 <sup>2</sup> / <sub>32</sub> " (D) (319.0 × 155.0 × 423.0 mm) (main body only) 12 <sup>1</sup> / <sub>32</sub> " (W) × 7 <sup>27</sup> / <sub>64</sub> " (H) × 17 <sup>15</sup> / <sub>64</sub> " (D) (322.5 × 188.5 × 438.0 mm) (including standard lens, adjustment feet and projecting parts)
Weight (approx.)	21.0 lbs. (9.5 kg)
Supplied accessories	GyroRemote, Four AAA size batteries, Power cord (11' 10", 3.6 m), RGB cable (9' 10", 3 m), USB mouse control cable (3' 3", 1 m), Computer audio cable (9' 10", 3 m), ø2.5–ø3.5 mm wired remote control cable (6 <sup>45</sup> / <sub>64</sub> ", 15 cm), Three BNC-RCA adaptors, Extra air filter, Lens cap, CD-ROM, LCD projector operation manual, LCD projector quick guide, Sharp Advanced Presentation Software operation manual, ID number seal
Replacement parts	Standard lens unit (CLNS-0236CE01), Lamp unit (Lamp/cage module) (BQC-XGP20X//1), GyroRemote (RRMCG1631CESA), AAA size batteries, Power cord (QACCU5013DE01), RGB cable (QCNW-5304CEZZ), USB mouse control cable (QCNW-5916CEZZ), Computer audio cable (QCNW-4870CEZZ), ø2.5–ø3.5 mm wired remote control cable (QCNW-5943CEZZ), BNC-RCA adaptors (QPLGJ0107GEZZ), Air filter (PFILD0080CEZZ), Lens cap (PCAPH1056CESA), CD-ROM (UDSKA0043CEN1), LCD projector operation manual (TINS-7354CEZZ), LCD projector quick guide (TINS-7355CEZZ), Sharp Advanced Presentation Software operation manual (TINS-7356CEZZ), ID number seal (TLABZ0781CEZZ)

This SHARP projector uses LCD (Liquid Crystal Display) panels. These very sophisticated panels contain 786,432 pixels (× RGB) TFTs (Thin Film Transistors). As with any high technology electronic equipment such as large screen TVs, video systems and video cameras, there are certain acceptable tolerances that the equipment must conform to.

This unit has some inactive TFTs within acceptable tolerances which may result in illuminated or inactive dots on the picture screen. This will not affect the picture quality or the life expectancy of the unit. If you have any questions about this matter, please call toll free 1-888-GO-SHARP (1-888-467-4277). U.S.A. ONLY

*Specifications are subject to change without notice.*





# Glossary

**Aspect ratio**

Width and height ratio of an image. The normal aspect ratio of a computer and video image is 4:3. There are also wide images with an aspect ratio of 16:9 and 21:9.

**Auto Sync**

Optimizes projected computer images by automatically adjusting certain characteristics.

**Background**

Initial setting image projected when no signal is being input.

**Border**

Displays the 4:3 image as the biggest size (768×576) that can be displayed on the WIDE mode screen (1024×576).

**Clock**

Clock adjustment is used to adjust vertical noise when clock level is incorrect.

**CLR Temp (Color temperature)**

Function that can be used to adjust the color temperature to suit the type of image input to the projector. Decrease the color temperature to create warmer, reddish images for natural flesh tones, or increase to create cooler, bluish images for a brighter picture.

**Composite sync**

Signal combining horizontal and vertical sync pulses.

**Digital shift**

Shifts image up or down easily by ▲/▼ buttons when RESIZE mode of input image is BORDER, STRETCH or SMART STRETCH of COMPUTER (except for SXGA and UXGA), VIDEO and DTV inputs.

**DNR (Digital Noise Reduction)**

Provides high quality images with minimal dot crawl and cross color noise.

**Dot by dot**

Mode that projects images in their native resolution.

**DVI**

Digital Visual Interface that supports both digital and analog displays.

**GAMMA**

Image quality enhancement function that offers a richer image by brightening the darker portions of the image without altering the brightness of the brighter portions. You can select four different modes : STANDARD, PRESENTATION, CINEMA and CUSTOM.

**GyroRemote**

Remote control device with a built-in sensor that can operate projectors and computers. GyroRemote communicates with a projector via radio signals and therefore does not encounter the line-of-sight problems found in infrared devices.

**Intelligent compression and expansion**

High quality resizing of lower and higher resolution images to fit the projector's native resolution.

**Intelligent digital keystone correction**

Function to digitally correct a distorted image when the projector is set up at an angle, smooths out jaggies on keystone images and compresses the image not only horizontally but vertically keeping the 4:3 aspect ratio, and at the same time, calculates the aspect ratio automatically adjusting to the lens shift width.

**Keylock level**

Mode that can lock the operation of projector buttons to prevent mischief.

**Lens shift**

The lens can be easily raised and lowered to minimize or eliminate "Keystone" type effect.

**Magnification (Enlarge)**

Digitally zooms in on a portion of an image.

**Phase**

Phase shift is a timing shift between isomorphic signals with the same resolution. When phase level is incorrect, the projected image typically displays horizontal flicker.

**Picture in Picture**

Allows you to add video images onto a data screen image, providing you with even more effective presentations.

**Presentation tools**

Helpful tools used to emphasize keypoints throughout a presentation.

**Progressive Mode**

The progressive display projects a smoother video image. You can select three different modes : 2D Progressive, 3D Progressive and Film Mode.

**RESIZE**

Allows you to modify or customize the picture display mode to enhance the input image. You can select six different modes: NORMAL, FULL, DOT BY DOT, BORDER, STRETCH and SMART STRETCH.

**RS-232C**

Function to control the projector from the computer by using the RS-232C ports on the projector and computer.

**Set Inputs**

Function to limit inputs. For example, when setting Input 2 to "OFF", the input is switchable only between Input 1 and Input 3, skipping Input 2.

**Smart Stretch**

Mode that stretches the right and left sides of the 4:3 image horizontally while maintaining the aspect ratio around the center of the image to display it on the WIDE screen.

**Stack Setting**

Prevents trouble with adjustment and operation when stack projecting. When setting two projectors, one to master and the other to slave, the slave follows the master's operation.

**Status function**

Displays the settings of each adjustment item.

**Stretch**

Mode that stretches the 4:3 image horizontally to display it on the WIDE screen.

**Sync on green**

Video signal mode of a computer which overlaps horizontal and vertical sync signal to green color signal pin.





# Index

## A

AC socket.....	13
Adjusting the Picture .....	47
Adjustment Feet .....	20
Air filter .....	70
Aspect ratio .....	42
ASSIGN Select button .....	33
Audio .....	52
Audio cable .....	18
AUDIO INPUT terminal .....	14
AUDIO OUTPUT terminal .....	18
Auto sync adjustment .....	51
AUTO SYNC button.....	51

## B

Background .....	55
BLACK SCREEN button .....	40
BNC-RCA adaptors .....	18
BORDER .....	42

## C

Carrying handle .....	4
Ceiling-mount .....	29
Ceiling+Rear .....	57
Clock .....	49
CLR Temp (Color Temperature) .....	47

## D

Digital shift .....	21
DNR (Digital Noise Reduction) .....	53
DOT BY DOT .....	42
DVI INPUT port (INPUT 3) .....	16

## E

Economy Mode .....	56
ENTER button.....	44
Exhaust vent.....	3
Extra air filter .....	12

## F

FAO .....	52
Function button .....	33

## G

GAMMA button .....	43
GUI (Graphical User Interface) .....	44
GyroRemote .....	30

## I

INPUT button.....	39
INPUT port .....	14
Intelligent digital keystone correction .....	21

## K

Keylock Levels .....	58
----------------------	----

## L

LAMP REPLACEMENT indicator .....	67
LEARN button .....	37
LEFT-CLICK button .....	35
LENS button .....	21
Lens shift .....	20

## M

MENU button.....	44
Monitor Out/RS-232C Off Function .....	56
MUTE button .....	39

## N

Network Function .....	63
------------------------	----

## O

On-screen display .....	54
On-screen display Language .....	62
OUTPUT port .....	56

## P

Password .....	61
PDF .....	9
Phase .....	49
Picture in Picture .....	53
POINTER button .....	32
POWER buttons .....	19
Power cord .....	13
POWER indicator .....	13
Presentation tools .....	34
Progressive Mode .....	48

## R

Rear projection .....	29
RESIZE button .....	42
RF CH+ button .....	36
RGB cable .....	14
RIGHT-CLICK button .....	35
RS-232C port .....	16

## S

Save Setting .....	49
Select Setting .....	49
Set ID No. ....	60
Set Inputs .....	59
Speaker .....	52
Stack Setting .....	58
Startup image .....	55
Status function .....	62
S-VIDEO INPUT terminal .....	17
Sync .....	51
Sync on green .....	72

## T

TEACH button .....	37
TEMPERATURE WARNING indicator .....	67
Transmission Speed (RS-232C) .....	59

## U

UNDO button .....	44
USB mouse control cable .....	35

## V

VAO .....	52
VIDEO INPUT terminal .....	17
Video System .....	54
Videowall .....	66
VOLUME buttons .....	39

## W

Wired remote control input .....	38
WIRED REMOTE control input terminal .....	38

## No.

1.2.3 button .....	39
4.5 button .....	39

# SHARP CORPORATION

## Free Manuals Download Website

<http://myh66.com>

<http://usermanuals.us>

<http://www.somanuals.com>

<http://www.4manuals.cc>

<http://www.manual-lib.com>

<http://www.404manual.com>

<http://www.luxmanual.com>

<http://aubethermostatmanual.com>

Golf course search by state

<http://golfingnear.com>

Email search by domain

<http://emailbydomain.com>

Auto manuals search

<http://auto.somanuals.com>

TV manuals search

<http://tv.somanuals.com>