

SHARP®

LC-22AA1M

LCD COLOUR TELEVISION

液晶彩色電視機

液晶彩色电视机

OPERATION MANUAL

使用說明書

使用说明书

AQUOS

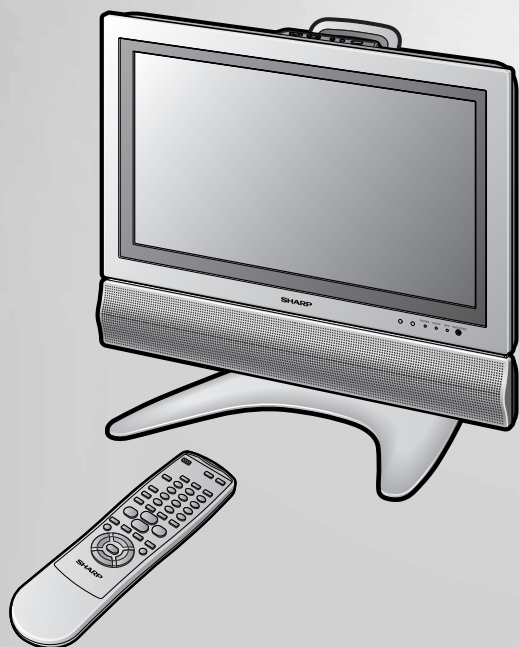

Printed in Japan
日本印刷
日本印刷
TINS-B066WJZZ
04P01-JKG

Printed on 100% post-consumer recycled paper.

本說明用紙使用的是100%的再生紙。

本說明用紙使用的是100%的再生紙。

Download from Www.Somanuals.com. All Manuals Search And Download.

ENGLISH

中文

中文

LC-22AA1M

LCD COLOUR TELEVISION ENGLISH

OPERATION MANUAL

Contents

Dear SHARP customer	2
Important Safety Precautions	2
Supplied accessories	4
Trademarks	4
Preparation	5
Inserting the batteries	5
Using remote control	5
Power connection	6
Antenna connection	6
Part names – Main unit	7
Removing the terminal covers	8
How to fix the cables	8
Part names – Remote control unit	9
Basic operation	10
First installation	10
Turning the main power on and off	11
ON/OFF Standby	11
Switching the TV/VIDEO (TV/AV1/AV2/AV3/COMPONENT) mode	11
Listening with headphones	11
Sound volume	12
Changing channels	12
Useful features	13
Selecting menu items	13
Booster	15
Sleep timer	15
Picture	16
Audio	17
Hi-fi sound	17
Dolby Virtual	18
Features	19
Quick shoot	20
V.Position	20
Selecting speakers	21
Connecting external speakers	21
On-screen display	22
Wide mode	23
AV connections	24
Preset	25
Using FREEZE setting	28
NICAM broadcast selection	29
A2 stereo broadcasts	30
Teletext	31
Teletext function	31
Connecting external devices	34
Examples of external devices that can be connected	34
Connecting a VCR, DVD player or a camcorder (AV-IN1/2/3/COMPONENT) ..	35
Outputting video and audio (video output)	36
Troubleshooting	37
Specifications	39
Dimensional drawings	40

Dear SHARP customer

Thank you for your purchase of the SHARP LCD colour TV product. To ensure safety and many years of trouble-free operation of your product, please read the Important Safety Precautions carefully before using this product.

Important Safety Precautions

Electricity is used to perform many useful functions, but it can also cause personal injuries and property damage if improperly handled. This product has been engineered and manufactured with the highest priority on safety. However, improper use can result in electric shock and/or fire. In order to prevent potential danger, please observe the following instructions when installing, operating and cleaning the product. To ensure your safety and prolong the service life of your LCD colour TV product, please read the following precautions carefully before using the product.

1. Read instructions—All operating instructions must be read and understood before the product is operated.
2. Keep this manual in a safe place—These safety and operating instructions must be kept in a safe place for future reference.
3. Observe warnings—All warnings on the product and in the instructions must be observed closely.
4. Follow instructions—All operating instructions must be followed.
5. Attachments—Do not use attachments not recommended by the manufacturer. Use of inadequate attachments can result in accidents.
6. Power source—This product must operate on a power source specified on the specification label. If you are not sure of the type of power supply used in your home, consult your dealer or local power company.
7. AC cord protection—The AC cords must be routed properly to prevent people from stepping on them or objects from resting on them. Check the cords at the plugs and product.
8. Overloading—Do not overload AC outlets or extension cords. Overloading can cause fire or electric shock.
9. Entering of objects and liquids—Never insert an object into the product through vents or openings. High voltage flows in the product, and inserting an object can cause electric shock and/or short internal parts. For the same reason, do not spill water or liquid on the product.
10. Servicing—Do not attempt to service the product yourself. Removing covers can expose you to high voltage and other dangerous conditions. Request a qualified service person to perform servicing.
11. Repair—If any of the following conditions occur, unplug the AC cord from the AC outlet, and request a qualified service person to perform repairs.
 - a. When the AC cord or plug is damaged.
 - b. When a liquid was spilled on the product or when objects have fallen into the product.
 - c. When the product has been exposed to rain or water.
 - d. When the product does not operate properly as described in the operating instructions.
Do not touch the controls other than those described in the operating instructions. Improper adjustment of controls not described in the instructions can cause damage, which often requires extensive adjustment work by a qualified technician.
 - e. When the product has been dropped or damaged.
 - f. When the product displays an abnormal condition. Any noticeable abnormality in the product indicates that the product needs servicing.
12. Replacement parts—In case the product needs replacement parts, make sure that the service person uses replacement parts specified by the manufacturer, or those with the same characteristics and performance as the original parts. Use of unauthorized parts can result in fire, electric shock and/or other danger.
13. Safety checks—Upon completion of service or repair work, request the service technician to perform safety checks to ensure that the product is in proper operating condition.
14. Wall or ceiling mounting—When mounting the product on a wall or ceiling, be sure to install the product according to the method recommended by the manufacturer.

Important Safety Precautions

- **Cleaning**—Unplug the AC cord from the AC outlet before cleaning the product. Use a damp cloth to clean the product. Do not use liquid cleaners or aerosol cleaners.



- **Water and moisture**—Do not use the product near water, such as bathtub, washbasin, kitchen sink, laundry tub, swimming pool and in a wet basement.



- **Stand**—Do not place the product on an unstable cart, stand, tripod or table. Doing so can cause the product to fall, resulting in serious personal injuries as well as damage to the product. Use only a cart, stand, tripod, bracket or table recommended by the manufacturer or sold with the product. When mounting the product on a wall, be sure to follow the manufacturer's instructions. Use only the mounting hardware recommended by the manufacturer.



- When relocating the product placed on a cart, it must be moved with utmost care. Sudden stops, excessive force and uneven floor surface can cause the product to fall from the cart.



- **Ventilation**—The vents and other openings in the cabinet are designed for ventilation. Do not cover or block these vents and openings since insufficient ventilation can cause overheating and/or shorten the life of the product. Do not place the product on a bed, sofa, rug or other similar surface, since they can block ventilation openings. This product is not designed for built-in installation; do not place the product in an enclosed place such as a bookcase or rack, unless proper ventilation is provided or the manufacturer's instructions are followed.

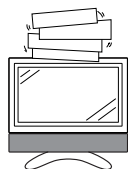

- The LCD panel used in this product is made of glass. Therefore, it can break when the product is dropped or impact applied. If the LCD panel is broken be careful not to be injured by broken glass.

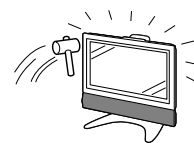

- **Heat sources**—Keep the product away from heat sources such as radiators, heaters, stoves and other heat-generating products (including amplifiers).



- Do not place vases or any other water-filled containers on this product. The water may spill onto the product causing fire or electric shock.



- To prevent fire, never place any type of candle or naked flames on the top or near the TV set.

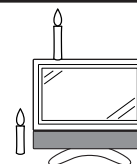

- To prevent fire or shock hazard, do not place the AC power cord under the TV set or other heavy items.

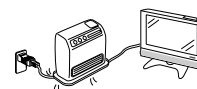

The LCD panel is a very high technology product with 1,229,760 thin film transistors, giving you fine picture details. Due to the very large number of pixels, occasionally a few non-active pixels may appear on the screen as a fixed point of blue, green or red. This is within product specifications and does not constitute a fault.

Supplied accessories

Make sure the following accessories are provided with the product.

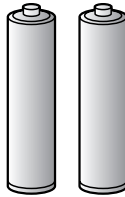
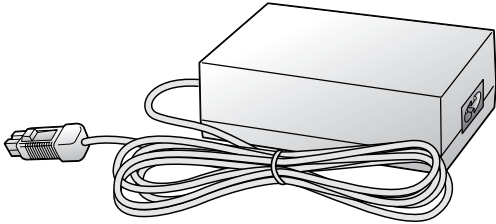
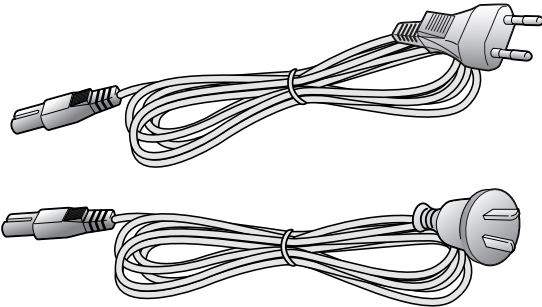
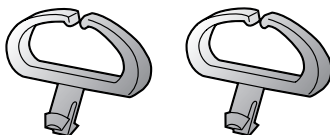
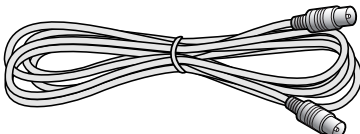
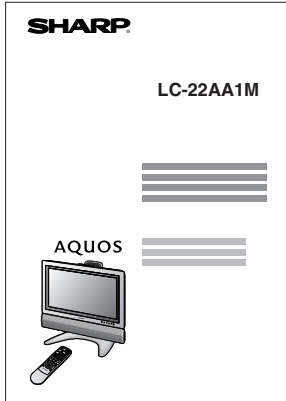
Remote control unit	“AA” size battery (x2)	
 <p data-bbox="363 732 542 760">Pages 5 and 10</p>	 <p data-bbox="1069 732 1150 760">Page 5</p>	
AC adapter	AC cord	
 <p data-bbox="413 1269 495 1298">Page 6</p>	 <p data-bbox="915 1196 1320 1225">*Product shape varies in some countries.</p> <p data-bbox="1069 1269 1150 1298">Page 6</p>	
Cable clamp (x2)	Antenna cable	Operation manual
 <p data-bbox="301 1800 382 1829">Page 8</p>	 <p data-bbox="740 1800 821 1829">Page 6</p>	

Trademarks

Manufactured under license from Dolby Laboratories. “Dolby”, “Pro Logic” and the double-D symbol are trademarks of Dolby Laboratories.

Manufactured under license from BBE Sound, Inc.
Licensed by BBE Sound, Inc. under USP4638258, 5510752 and 5736897. BBE and BBE symbol are registered trademarks of BBE Sound, Inc.

Preparation

Inserting the batteries

Before using the System for the first time, insert two "AA" size batteries (supplied) into the remote control. When the batteries become depleted and the remote control fails to operate, replace the batteries with new "AA" size batteries.

1 Open the battery cover.

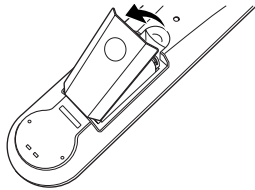

2 Insert two supplied "AA" size batteries.

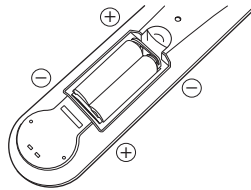

3 Close the battery cover.

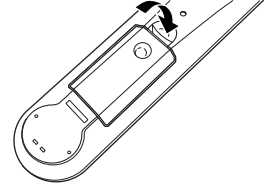

- Place batteries with their terminals corresponding to the (+) and (-) indications in the battery compartment.

CAUTION

Improper use of batteries can result in chemical leakage or explosion. Be sure to follow the instructions below.

- Place the batteries with their terminals corresponding to the (+) and (-) indications.
- Do not mix batteries of different types. Different types of batteries have different characteristics.
- Do not mix old and new batteries. Mixing old and new batteries can shorten the life of new batteries or cause chemical leakage in old batteries.
- Remove batteries as soon as they have worn out. Chemicals that leak from batteries can cause a rash. If you find any chemical leakage, wipe thoroughly with a cloth.
- The batteries supplied with this product may have a shorter life expectancy due to storage conditions.
- If you will not be using the remote control unit for an extended period of time, remove the batteries from it.

Using remote control

- Use the remote control by pointing it towards the remote sensor window of the main unit. Objects between the remote control and sensor window may prevent proper operation.

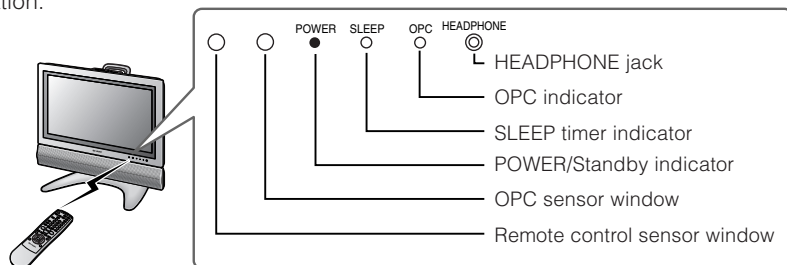

Cautions regarding use of remote control

- Do not expose the remote control to shock. In addition, do not expose the remote control to liquids, and do not place it in an area with high humidity.
- Do not install or place the remote control under direct sunlight. The heat may cause deformation of the unit.
- The remote control may not work properly if the remote sensor window is under direct sunlight or strong lighting. In such a case, change the angle of the lighting or main unit, or operate the remote control closer to the remote sensor window.

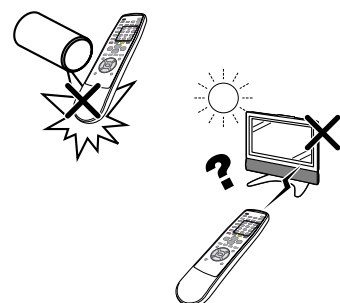

Preparation

Power connection

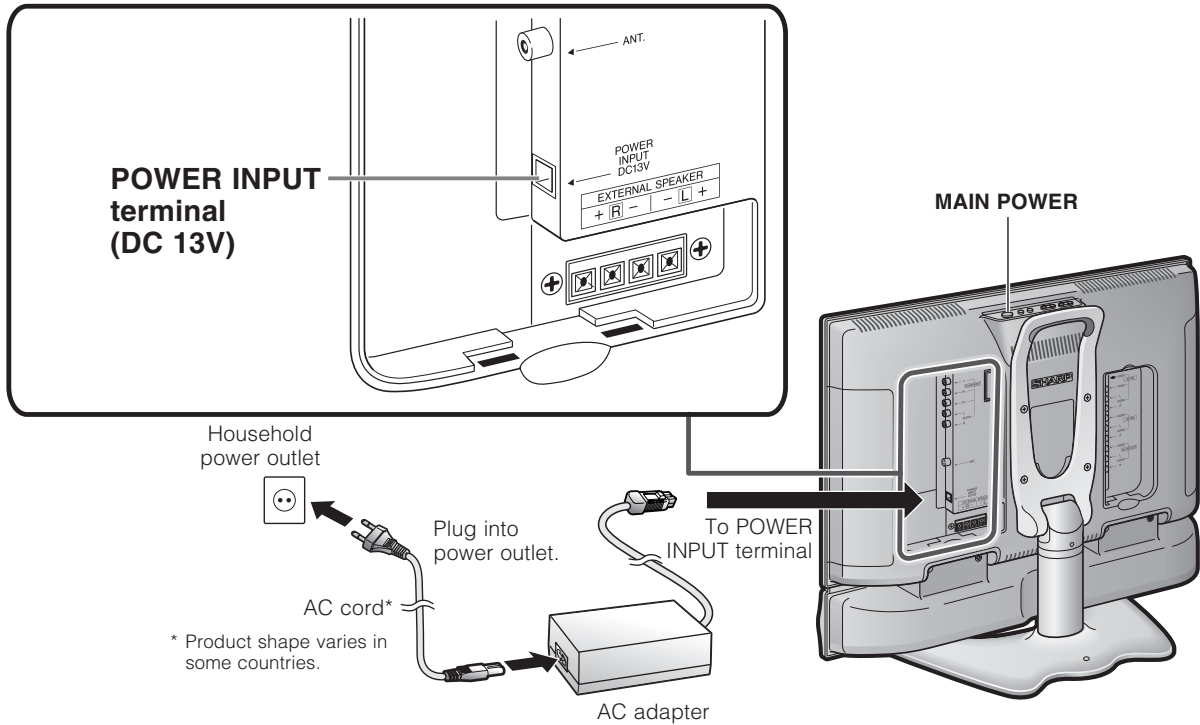

NOTE

- Use a commercially available AC plug adapter, if necessary, depending on the design of the wall outlet.
- Always turn the **MAIN POWER** switch of the LCD TV set to off when connecting the AC adapter.
- Unplug the AC adapter from the LCD TV set and power outlet when the LCD TV set is not to be used for a long period of time.

Antenna connection

- Using the supplied antenna cable, connect the room antenna terminal to the antenna terminal on the TV set. (Refer to the figure below.)

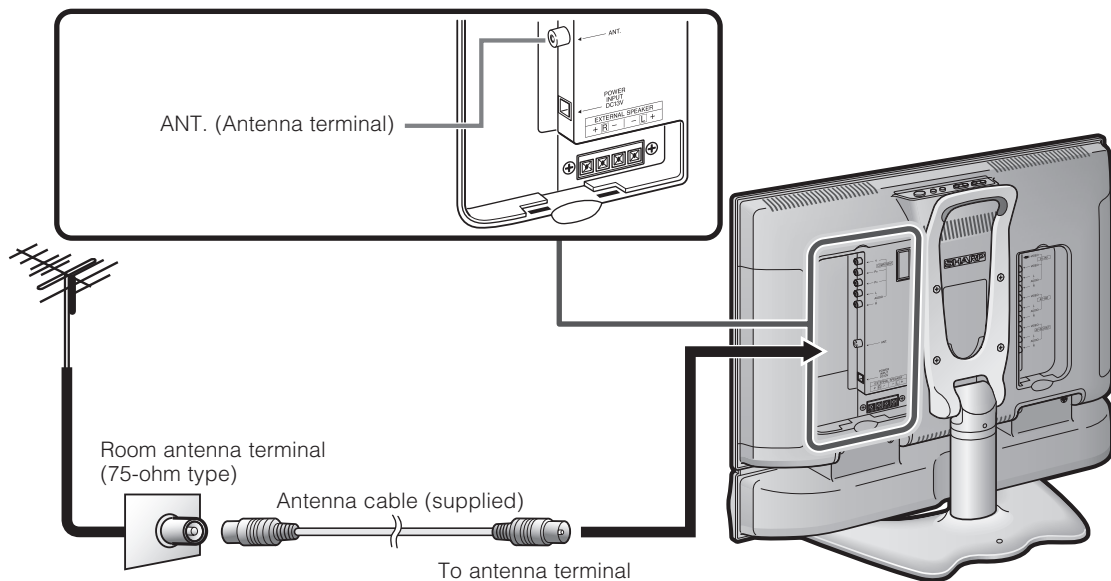

Part names – Main unit

Controls

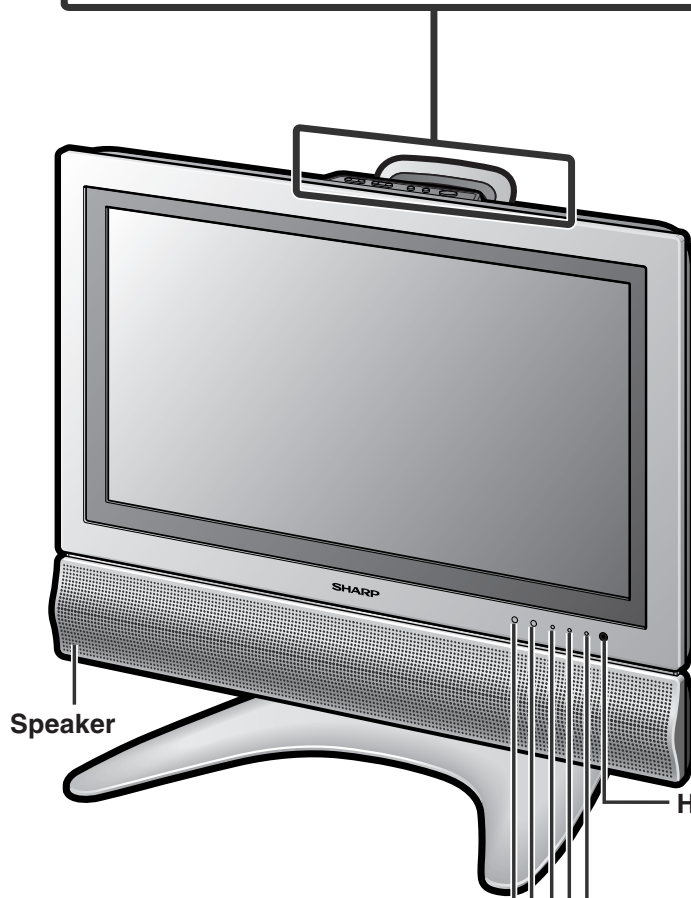
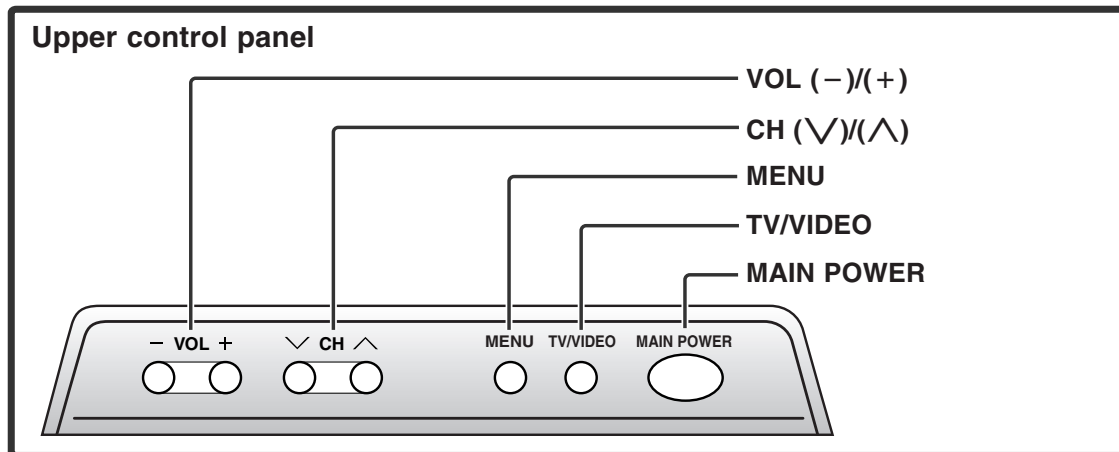

To change the vertical angle of the LCD TV set, tilt the screen up to 5 degrees forward or 10 degrees backward. The TV set can also be rotated 25 degrees to right and left. Please adjust the angle so that the TV set can be watched most comfortably.

How to adjust the angle



Hold the carrying handle and tilt the screen while steadying the stand with your other hand.

Headphone jack

OPC indicator

The Optical Picture Control indicator lights up green when the "Brightness" is set to "auto".

SLEEP timer indicator

The SLEEP timer indicator lights up red when the SLEEP TIMER is set.

POWER/Standby indicator

A green indicator lights when the power is on and a red indicator lights when in the standby mode (the indicator will not light when the main power is off).

NOTE

- TV/VIDEO, CH(∇)/(∧), VOL (-)/(+) and MENU on the main unit have the same functions as the same buttons on the remote control. Basically, this operation manual provides a description based on operation using the remote control.

Terminals

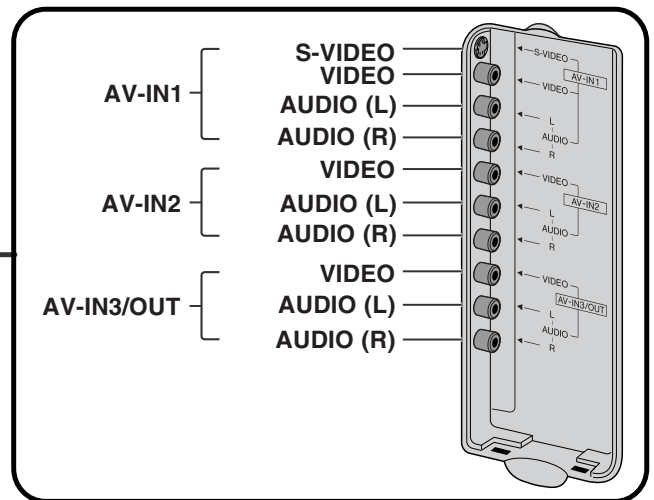
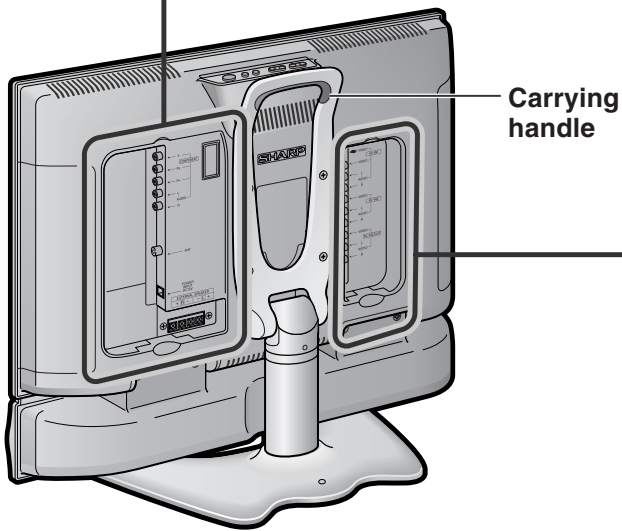
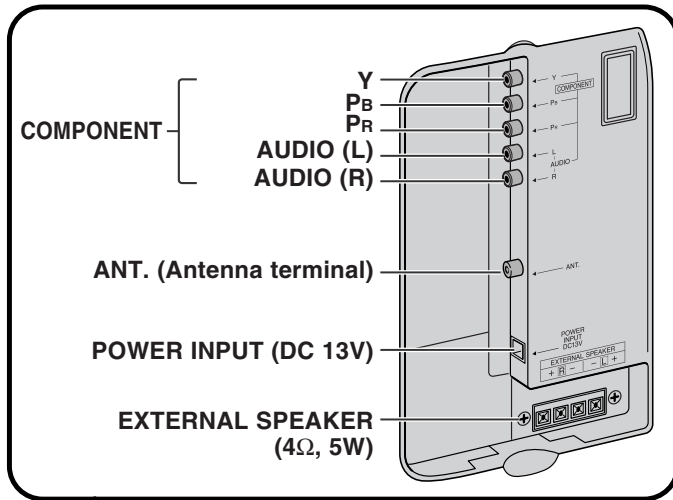

Removing the terminal covers

- Before connecting cables and cords into the rear terminals, remove the terminal covers. Push in the tabs and pull out the covers carefully.
- To mount the terminal cover, insert the 2 hooks on the bottom of the cover into the cabinet and press on the upper part of the cover until the tab locks in place with a click.

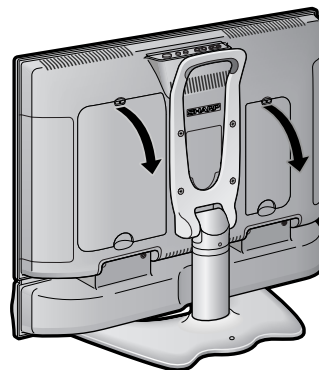

How to fix the cables

- Secure cables and cords with the supplied cable clamps so that they do not get caught when mounting the cover.

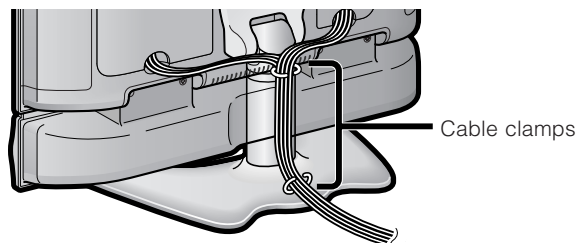

Part names – Remote control unit

Remote control unit

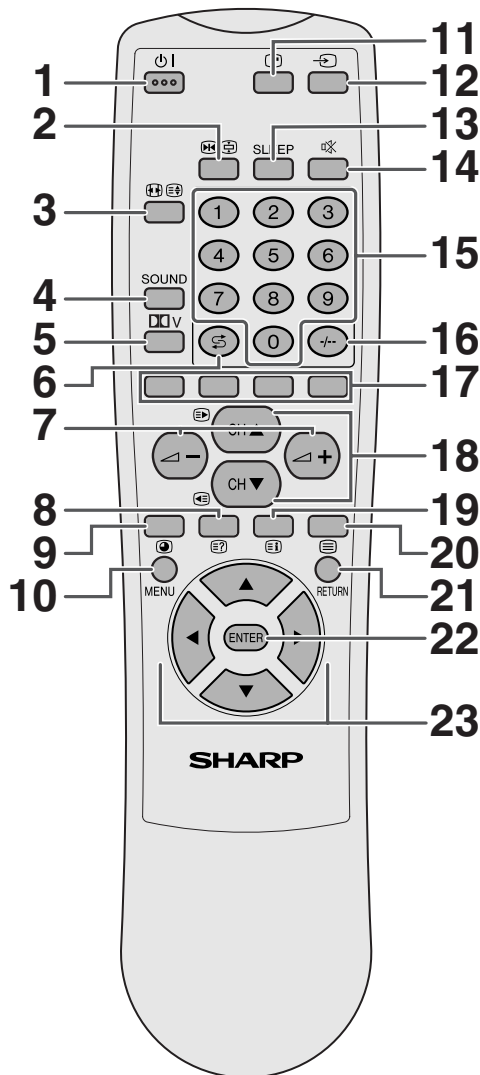

- 1 **⏻ | (STANDBY/ON)**
To switch the power on and off. (See page 11.)
- 2 **⏸ (FREEZE/HOLD for TELETEXT)**
TV/External input mode: Change the still image mode.
TELETEXT mode: Freeze a multi-page on screen while other pages are automatically updated. Press **⏸** again to return to the normal image. (See page 28.)
- 3 **⏪ (WIDE MODE/ T/B/F)**
TV/External input mode: Change the wide image mode. (See page 23.)
TELETEXT mode: Set the area of magnification. (full/upper half/lower half) (See page 31.)
- 4 **SOUND**
Select the sound multiplex mode. (See pages 29 and 30.)
- 5 **DOLBY V**
Select Dolby Virtual Surround settings. (See page 18.)
- 6 **↶ (Flashback)**
Press to return to the previous channel in normal viewing mode.
Press to return to the previous page in TELETEXT mode.
- 7 **▲/▼ (VOL)**
Set the volume. (See page 12.)
- 8 **⏮ (Reveal hidden for TELETEXT)**
TELETEXT mode: Display hidden characters. (See page 31.)
- 9 **⏭ (SUBPAGE for TELETEXT)**
TELETEXT mode: Change the picture mode for sub-page selecting. (See page 32.)
- 10 **MENU**
Display the MENU screen.
- 11 **⏪ (CHANNEL INFORMATION)**
Display the channel information.
- 12 **⏮ (INPUT SOURCE)**
Select an input source. (TV, AV1, AV2, AV3, COMPONENT) (See page 11.)
- 13 **SLEEP**
Set the Sleep timer. (See page 15.)
- 14 **⏸ (MUTE)**
Mute the sound. (See page 12.)
- 15 **0 - 9**
TV/External input mode: Set the channel.
TELETEXT mode: Set the page.
- 16 **-/-- (Digit for channel select)**
Change the digits of the selected TV channel. (See page 12.)
- 17 **Colour (RED/GREEN/YELLOW/BLUE)**
TELETEXT mode: Select a page. (See page 31.)
- 18 **CH▲/CH▼ (⏪/⏩)**
TV/External input mode: Select the channel.
TELETEXT mode: Set the page. (See page 31.)
- 19 **⏮ (TOP Overview for TELETEXT)**
TELETEXT mode: Display an index page for CEEFAX/FLOF information. TOP Overview for TOP programme. (See page 32.)
- 20 **⏮ (TELETEXT)**
Select the TELETEXT mode. (all TV image, all TEXT image, TV/TEXT image) (See pages 31 and 32.)
- 21 **RETURN**
MENU mode: Return to the previous menu screen.
- 22 **ENTER**
Execute a command.
Return to the initial image position after moving with **▲/▼/◀/▶**.
- 23 **▲/▼/◀/▶ (Cursor)**
Select a desired item on the setting screen.
Move the picture on the screen.

NOTE

- When using the remote control unit, point it at the Display.

Basic operation

First installation

When you turn on the LCD TV set for the first time, the First installation routine, which makes installation easier, is activated. Using this routine, you can select the on-screen display language, and automatically search for and store all the receivable channels.

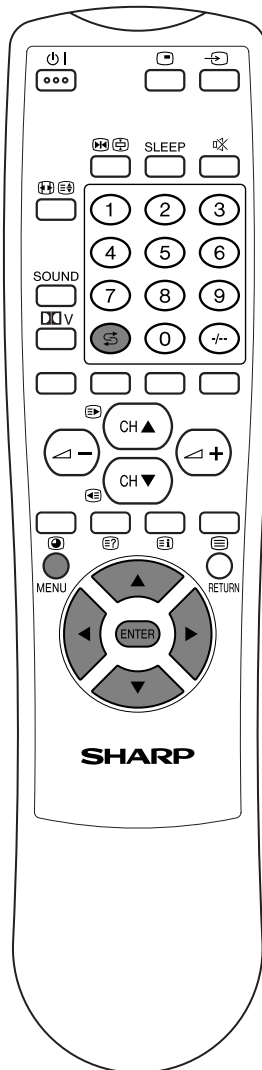
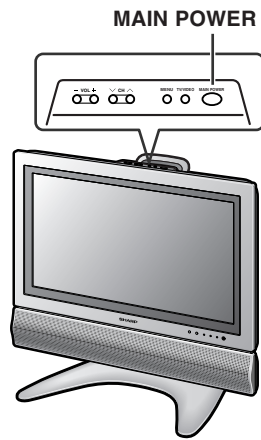

1 Press the **MAIN POWER** switch. The "First installation (Language)" screen with a list of the languages for the on-screen display appears.

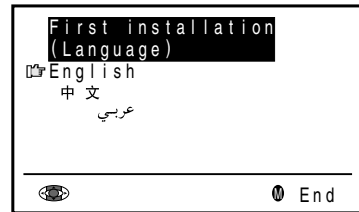

2 Press **▲/▼** to select the desired language, and then press **ENTER**. The "First installation (Message)" screen appears.

NOTE

- You can change the on-screen display language after the First installation routine by selecting "Language" on the TV menu (see pages 13 and 14).

3 If you have already connected the antenna, press **▲/▼** to select "Yes", and then press **ENTER**. If not, press **▲/▼** to select "No", and then press **MENU** to exit. (You can try First installation again after connecting antenna. See page 6 for antenna connection.)



4 Press **▲/▼** to select the desired adjustment item, and then press **ENTER**. Then press **◀/▶** to select the desired item.

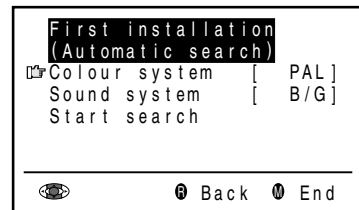

5 Press **▲/▼** to select "Start search".

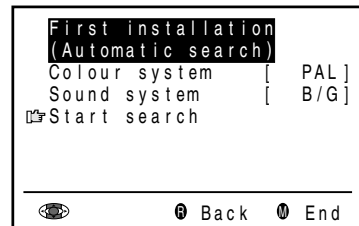

6 Press **ENTER** to begin the automatic programme search. The screen shows whatever is on channel 1 when the search is finished.

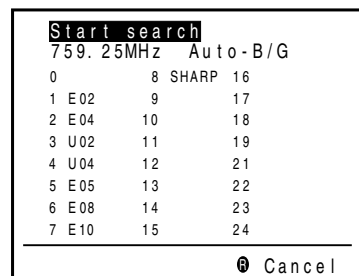

7 Press **MENU** to exit.

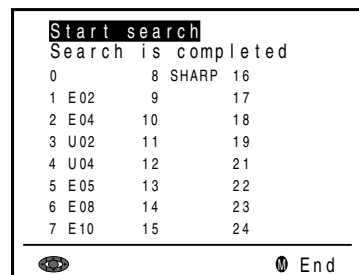

NOTE

- The input mode is automatically switched to AV1 when "First installation" is selected.
- While performing the steps in the first installation, you can skip back to the screen before the first installation is selected by pressing **Flashback** (⏮).

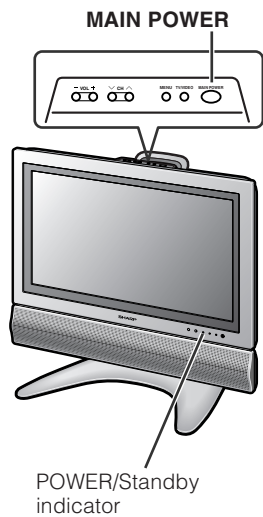

Turning the main power on and off

- Press the **MAIN POWER** switch. The POWER/Standby indicator instantaneously changes from red to green and the main unit is turned on.

NOTE

- The On-screen indicator disappears after a few seconds.
- To turn off the main power, press the **MAIN POWER** switch.

On-screen display

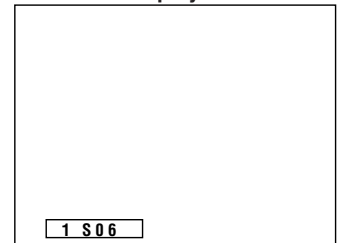

ON/OFF Standby

To turn off the LCD TV

Press . The POWER/Standby indicator will turn red.

To turn the LCD TV back on

Press again. The POWER/Standby indicator will turn green.

Switching the TV/VIDEO (TV/AV1/AV2/AV3/COMPONENT) mode

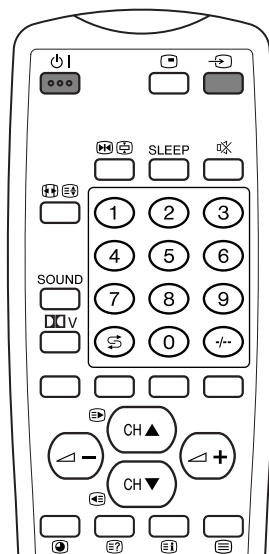

- 1 Turn on the power of the connected video equipment.
- 2 Press to select the applicable input source. The screen displays AV1, AV2, AV3, COMPONENT or TV mode each time is pressed.

NOTE

- The AV input mode indication remains for 6 seconds.
- AV1: Video equipment connected to the AV-IN1 input terminals.
An S-video input terminal is additionally provided for the AV-IN1 input. If both the S-video terminal and normal video terminals are connected with cables, the S-video input terminal takes priority.
- AV2: Video equipment connected to the AV-IN2 input terminals.
- AV3: AV3 mode is used to adjust the preset settings and IN3 or OUT can be selected. AV3 indication is not displayed when OUT is selected. (See page 19.)
- COMPONENT: Video equipment connected to the COMPONENT input terminals.

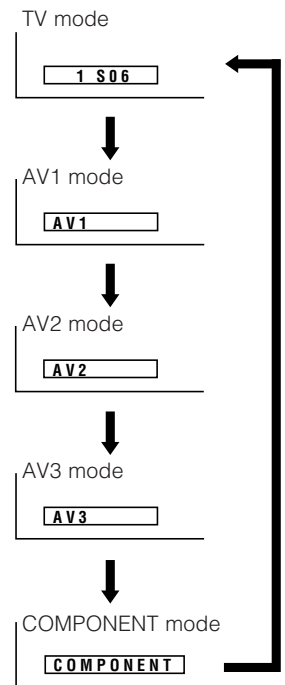

Listening with headphones

- Plug the headphone mini-plug into the HEADPHONE jack located on the front of the TV set.

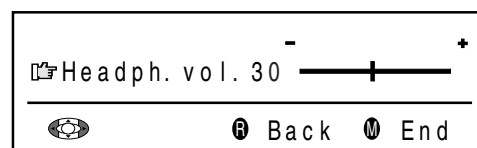
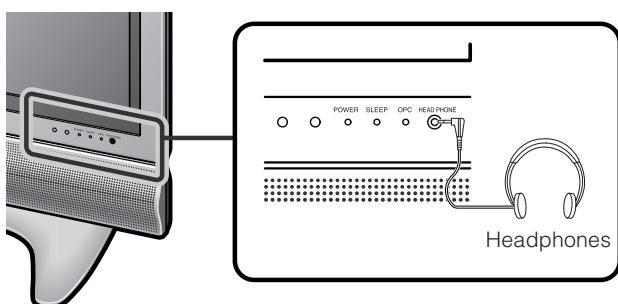

Please refer to page 17 to adjust the sound volume.

NOTE

- Headphones are not included in the supplied accessories.
- No sound is heard from the main unit speakers when a headphone mini-plug is connected into the HEADPHONE jack.

Control panel of the main unit

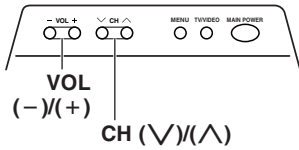

Sound volume

To adjust the volume

- Press + to increase the sound volume. The bar indicator shifts right.
- Press - to decrease the sound volume. The bar indicator shifts left.

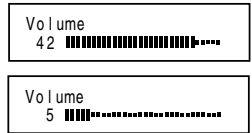

To mute the sound

- Press (Mute) to temporarily turn off the sound. "Sound off" is displayed.
- Press (Mute) to turn off the Mute function. "Sound on" is displayed.

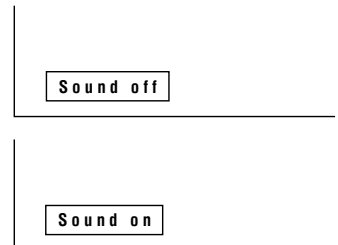

NOTE

- When (+/-) is pressed in the Mute mode, the sound turns on and the volume indicator is displayed.
- The Mute function is cancelled when is pressed.

Changing channels

You can select channels using **0 – 9** or **CH ▲/▼**.

- To handle the increasing number of channels available, this LCD TV set allows you to select up to 100 channels (0 to 99).

Using 0 – 9 on the remote control unit

Select the channels directly by pressing buttons **0 – 9**.

EXAMPLE

To select a 1-digit channel (e.g. channel 2):

- Press **2**. If "2" is indicated and the picture does not change, press to switch over to the 1-digit select mode and press **2** again.

To select a 2-digit channel (e.g. channel 12):

- Press to set the 2-digit select mode. Press **1**, followed by **2**.

Using CH ▲/▼

Press **CH ▲** and the channels change in the order shown below:

1 → 2 → 3 → ... → 98 → 99 → 0 → 1 → 2 → 3 → ...

Press **CH ▼** and the channels change in the order shown below:

3 → 2 → 1 → 0 → 99 → 98 → ... → 3 → 2 → 1 → ...

NOTE

- Channel "0" is reserved for RF output of VCR.
- Complete this procedure within 3 seconds, otherwise the selection will not be made on the 2-digit channel mode.

When viewing Teletext information

View a page directly which is 3-digit page number from 100 to 899 by pressing buttons **0 – 9**. With Teletext, you do not use . (See page 31).

Using Flashback () on the remote control unit

Press to switch the currently tuned channel to the previously tuned channel. Press again to switch back to the currently tuned channel.

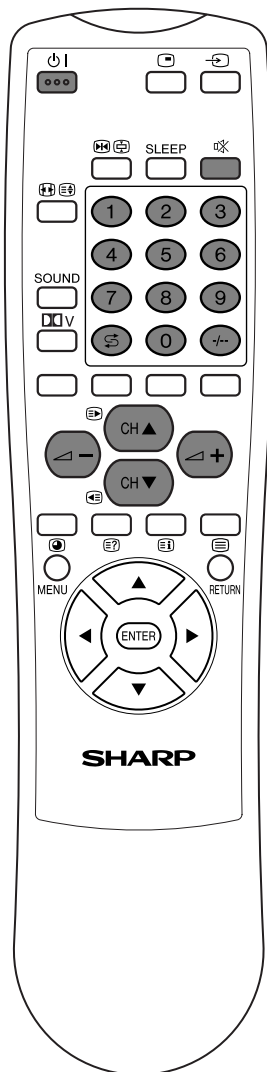

Useful features

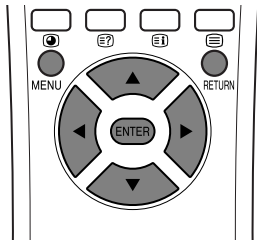

Selecting menu items

- The menus can be used to adjust the various settings of your LCD TV set. Select the desired menu item by following the steps below.

■ Using TV Menus

1

Press **MENU** on the remote control to display the TV menu.

2

Press **▲/▼** to select the desired menu item.

- The cursor moves up or down.
- The cursor indicates the selected menu item.

3

Press **ENTER** to display the setting screen for the selected menu item.

- Press **ENTER** again to adjust the selected item.
- See the next page for a table of the setting screens.

4

Press **◀▶** to adjust the selected item.

5

Press **RETURN** to return to the previous screen or **MENU** to return to the normal screen.

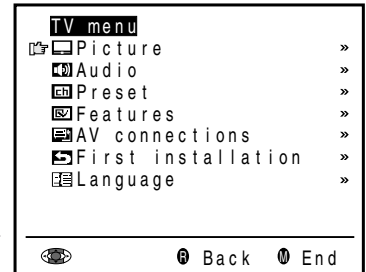

■ Using Direct Control Menu

1

Press **MENU** on the main unit to display the TV menu.

2

Press **CH (∇)/(∧)** to select the desired menu item.

- The cursor moves up or down.
- The cursor indicates the selected menu item.

3

Press **TV/VIDEO** to display the setting screen for the selected menu item.

- Press **TV/VIDEO** again to adjust the selected item.

4

Press **VOL (-)/(+)** to make the adjustment.

5

Press **MENU** to return to the previous screen.

- Each time **MENU** is pressed, you will return to the previous screen.

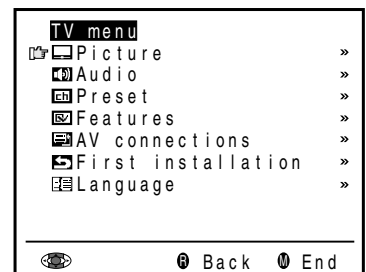

Control panel of the main unit

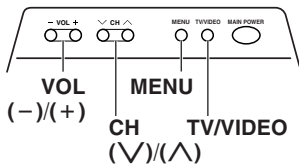

NOTE

- The items displayed differ depending on the setting conditions.
- The item selected is displayed in yellow.
- Settings most recently adjusted will be saved in memory.

Selecting menu items (Continued)

TV Menu Setting Screens

For details on using each setting screen, refer to the page number indicated.

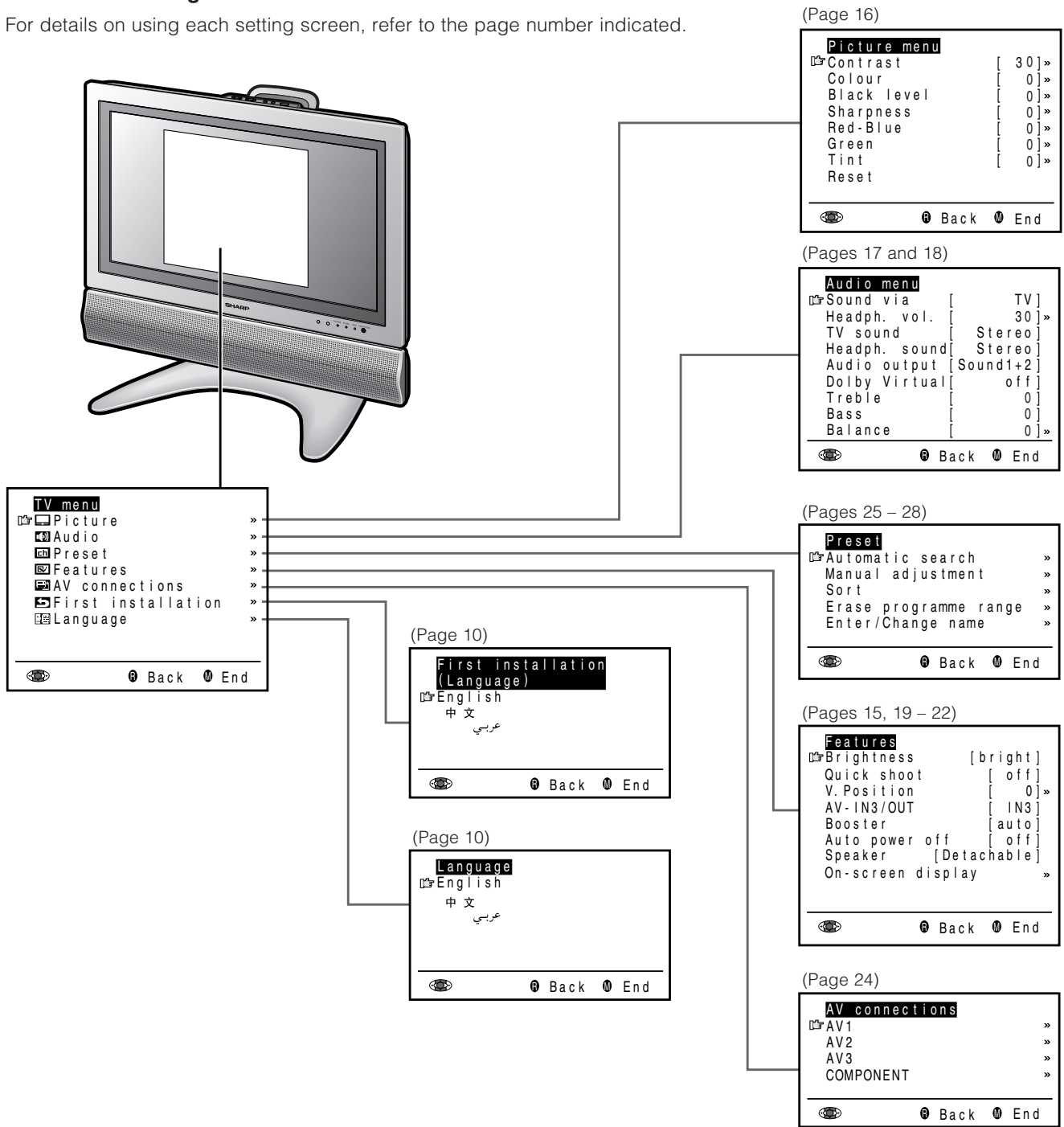

NOTE

- The illustrations and on-screen displays in this manual are for explanation purposes and may vary slightly from the actual operations.

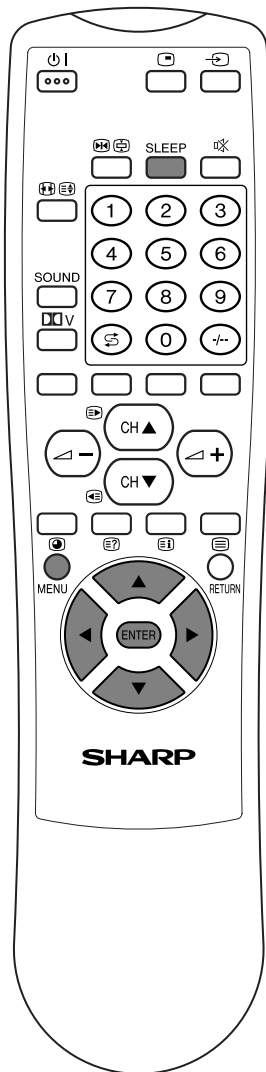

Booster

When set to “auto”, picture noise is reduced for TV broadcast signal strength from moderate regions. Automatically sets to “off” for a strong electrolytic signal that has a constant level.

- 1 Press **MENU** to display the TV menu.
- 2 Press **▲/▼** to select “Features”, and then press **ENTER**.
- 3 Press **▲/▼** to select “Booster”, and then press **ENTER**.
- 4 Press **◀▶** to select “auto” or “off”, and then press **ENTER**.
- 5 Press **MENU** to exit.

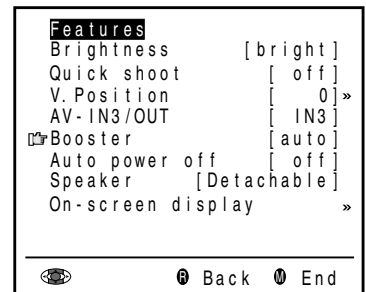
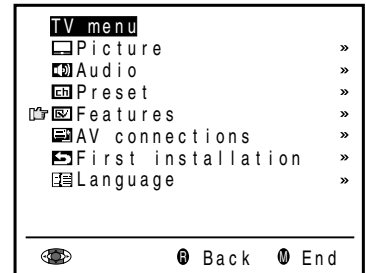

NOTE

- In regions with pronounced changes in TV signal strength or very strong signal strength, the effect is negligible and may produce instability. In such case, turn the setting “off”. The built-in TV booster cannot handle regions with extremely weak signal strength. After consulting with the store of purchase, please attach an external booster antenna.

Sleep timer

Allows you to set a time when the TV automatically switches to standby.

- 1 Press **SLEEP**.
 - Remaining time displays when sleep timer has been set.

Sleep Timer 30

- 2 Each time you press **SLEEP**, the remaining time switches as shown below.
 - When the time has been set, countdown automatically starts.
 - Five minutes before the preset of time expires, the remaining time displays each minute.

▶ off → 30 → 60 → 90 → 120
(minutes)

NOTE

- Select “off” by pressing **SLEEP** to cancel the sleep timer.
- When the sleep timer is working, its indicator on the Display lights red.

Useful features

Picture

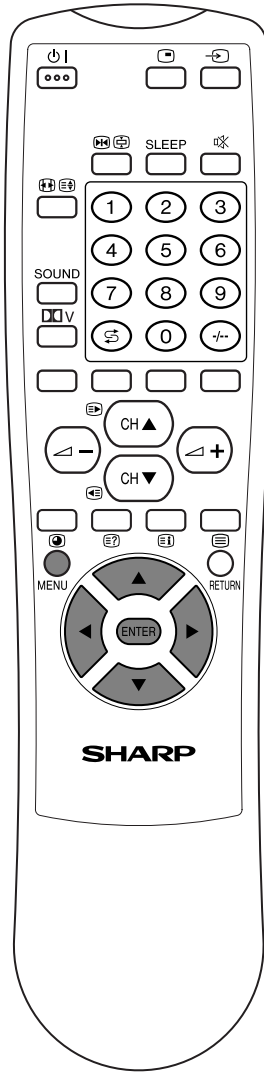

1

Press **MENU** to display the TV menu.

2

Press **▲/▼** to select "Picture", and then press **ENTER**.

3

Press **▲/▼** to select the desired adjustment item, and then press **ENTER**.

- The next menu appears.

4

Press **◀/▶** to make the adjustment.

5

Press **MENU** to exit.

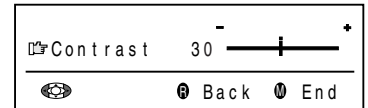
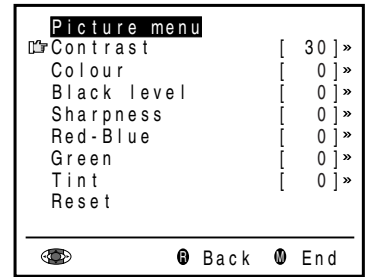

Adjustment item	Press Left (◀)	Choice/Value range	Press Right (▶)
Contrast	Decrease contrast	0.....30.....60	Increase contrast
Colour	Lower colour intensity	-30.....0.....+30	Higher colour intensity
Black level	Less brightness	-30.....0.....+30	More brightness
Sharpness	Soft picture	-30.....0.....+30	Sharp picture
Red-Blue	More red	-30.....0.....+30	More blue
Green	Less green	-30.....0.....+30	More green
Tint *	Towards purple	-30.....0.....+30	Towards green
Reset	Reset value (Press ENTER .)		

* "Tint" is only visible when "N358" or "N443" signal has been input into the unit.

Useful features

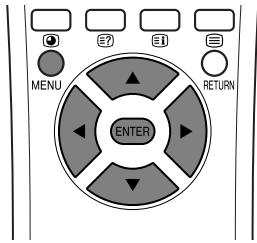

Audio

- 1** Press **MENU** to display the TV menu.
- 2** Press **▲/▼** to select "Audio", and then press **ENTER**.
- 3** Press **▲/▼** to select the desired adjustment item, and then press **ENTER**.
 - Each item can now be selected or the next menu appears.
- 4** Press **◀▶** to make the adjustment.
- 5** Press **MENU** to exit.

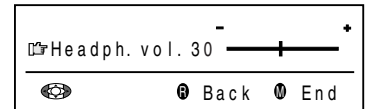
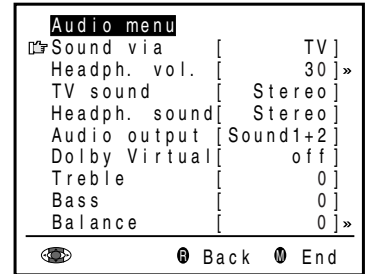

Adjustment item	Press Left (◀)	Choice/Value range	Press Right (▶)
Sound via	—	TV↔Hi-fi	—
Headph. vol. (*1)	Decrease headphones volume	0.....30.....60	Increase headphones volume
TV sound	—	Stereo↔Mono/Sound1↔ Sound2↔Sound1+2↔Mono Nicam↔Mono/Mono	—
Headph. sound (*1)	—	(* The choices differ depending on whether or not a NICAM or A2 stereo signal is received.) See pages 29 and 30.	—
Audio output	—	Sound1↔Sound2↔Sound1+2	—
Dolby Virtual (*1)	—	off↔on	—
Treble (*1)	For weaker treble	-30.....0.....+30	For stronger treble
Bass (*1)	For weaker bass	-30.....0.....+30	For stronger bass
Balance (*1), (*2)	Increase the volume of the left speaker	-30.....0.....+30	Increase the volume of the right speaker

(*1) These items are not displayed when the "Sound via" item is set to "Hi-fi".

(*2) "Balance" is not selectable when "Dolby Virtual" is set to "on".

NOTE

- In the "Audio output" item, mono-video recorders should select "Sound1" or "Sound2". Stereo-video recorders should select "Sound1+2" so that the desired sound can be selected when playing back the video.

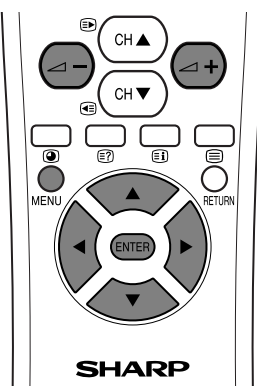

Hi-fi sound

This function allows you to enjoy higher sound quality when connecting AV-IN3/OUT terminals to an external amplifier.

- 1** To use this function, set "AV-IN3/OUT" setting to "OUT" in the Features menu (see page 19).
- 2** Select "Hi-fi" for "Sound via" item in the Audio menu.
 - The sound from the built-in speakers will be turned off.
- 3** Press **▲/▼** to select the desired adjustment item, and then press **ENTER**.
- 4** Press **◀▶** to select the Audio mode.
- 5** Press **MENU** to exit.

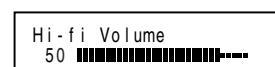
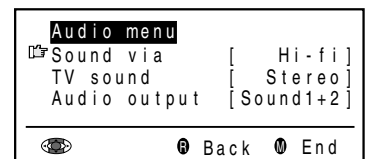

NOTE

- Pressing **◀ (+/-)** will display the volume indicator shown above. You can adjust the volume by pressing **◀ (+)** or **▶ (-)** on the same button.

Dolby Virtual

You can enjoy the Surround 2ch stereo with Dolby Pro Logic II technology.

Virtual Dolby Surround is a technology certified by Dolby Laboratories that creates a virtualised surround sound experience from two speakers using Dolby Pro Logic or Dolby Pro Logic II.

Virtual Dolby Surround retains all the original multichannel audio information and provides the listener with the sensation of being surrounded by additional speakers.

Directly setting the Virtual Dolby Surround

- 1 Press **DOLBY V** to display the Dolby Virtual screen.
- 2 Press **DOLBY V** to select "on".
 - Pressing **DOLBY V** will turn on and off the Dolby Virtual function.

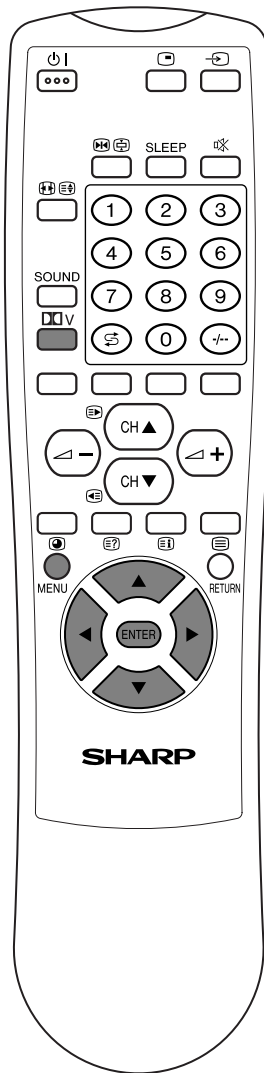
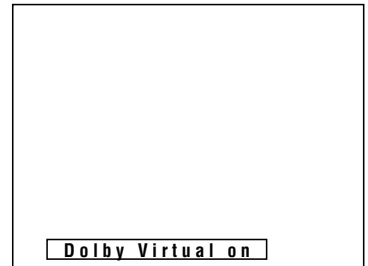

Setting the Virtual Dolby Surround on the menu screen

- 1 Press **MENU** to display the TV menu.
- 2 Press **▲/▼** to select "Audio", and then press **ENTER**.
- 3 Press **▲/▼** to select "Dolby Virtual", and then press **ENTER**.
- 4 Press **◀/▶** to select "on".
- 5 Press **MENU** to exit.

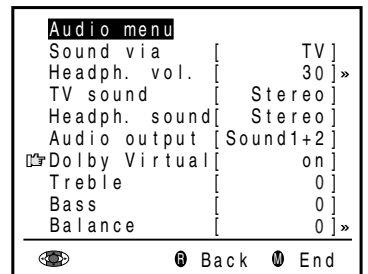
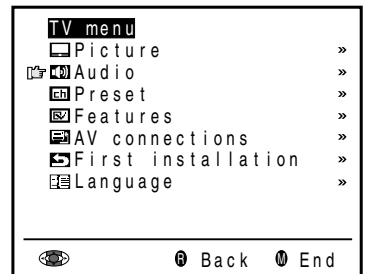

NOTE

- Virtual Dolby Surround does not work when sound is output from the headphones.
- When "on" is selected in the Dolby Virtual setting, you cannot adjust "Balance".
- For some discs, setup may be required on your DVD. In this case, please refer to the operation manual of your DVD player.

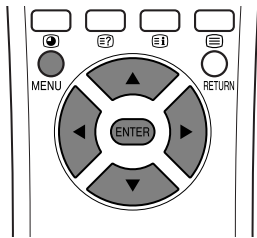

Features

The Features items can be set by the user.

- 1 Press **MENU** to display the TV menu.
- 2 Press **▲/▼** to select "Features", and then press **ENTER**.
- 3 Press **▲/▼** to select the desired adjustment item, and then press **ENTER**.
- 4 Press **◀▶** to make the adjustment. (Except "On-screen display" menu item)
- 5 Press **MENU** to exit.

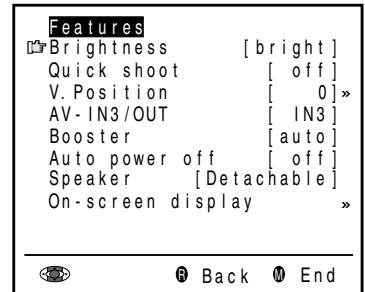
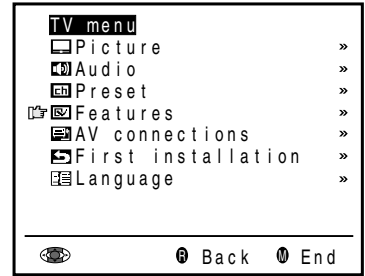

Selected item	Factory setting	Adjustable item/range
Brightness	[bright] Maximum brightness	[normal] Brightness 60% → Suitable for viewing in well-lit areas. Saves energy. [dark] Brightness 20% → Sufficiently bright when viewing in dim areas. [auto] Screen brightness adjusts according to the ambient light of the room to conserve power consumption. When setting to "auto", make sure no object obstructs the OPC sensor, which could affect its ability to sense surrounding light.
Quick shoot	[off] This feature is inactive.	[on] Improves LCD response when viewing fast-moving images. The effect is greater at low room temperatures (at or below 15°C/59°F).
V.Position	[0] Normal image	When screen size is Zoom 14:9, Panorama or Cinema 16:9: Image shifts down. -30 ← → 30 Image shifts up. When screen size is Normal or Full: Image shifts down. -15 ← → 15 Image shifts up.
AV-IN3/OUT	[IN3] AV-IN3 terminals are selected as input terminals.	[OUT] Line Output is selected. AV-OUT is available.
Booster	[auto] Picture noise is reduced for TV broadcast signal strength from moderate regions.	[off] This feature is inactive.
Auto power off (only TV mode)	[off] This feature is inactive.	[on] The power of the LCD TV set is turned off when there is no signal for 5 minutes.
Speaker	[Detachable] Select this when using internal speaker.	[External] Select this when using external speaker.

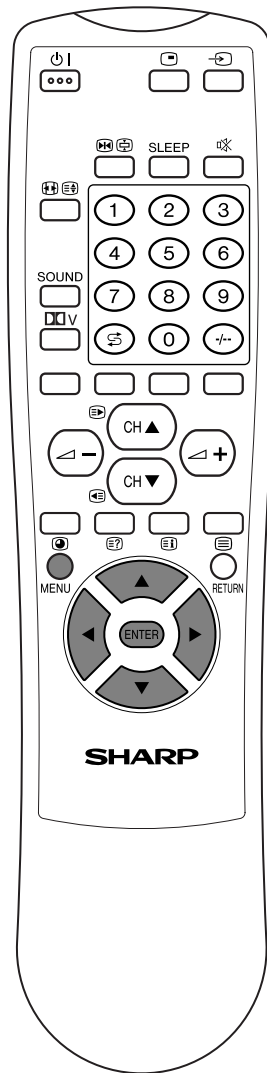

Quick shoot

Improves the response of LCD when viewing fast-moving image.
The effect is greater at low room temperatures (at or below 15°C/59°F).

1 Press **MENU** to display the TV menu.

2 Press **▲/▼** to select "Features", and then press **ENTER**.

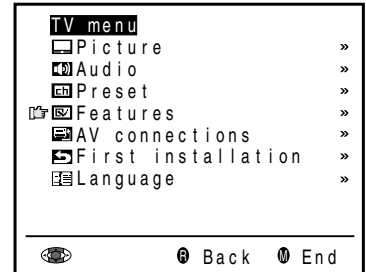

3 Press **▲/▼** to select "Quick shoot", and then press **ENTER**.

4 Press **◀▶** to select "on", and press **ENTER**.

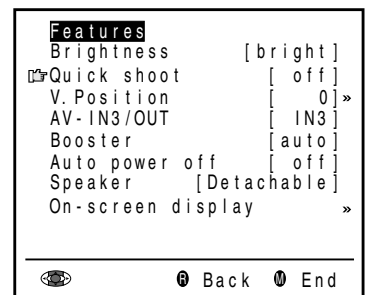

5 Press **MENU** to exit.

NOTE

- Quick shoot may cause image noise. If this occurs turn the function "off".

V.Position

Allows you to shift the image up and down.

1 Press **MENU** to display the TV menu.

2 Press **▲/▼** to select "Features" and then press **ENTER**.

3 Press **▲/▼** to select "V.Position" and then press **ENTER**.

4 Press **◀▶** to make the adjustment.

5 Press **MENU** to exit.

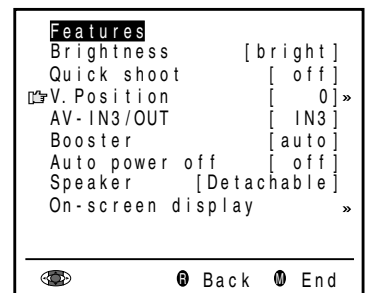
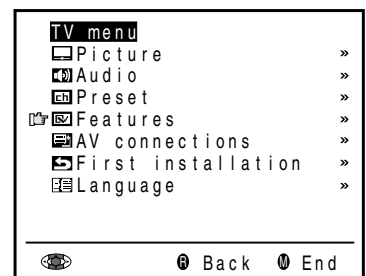

NOTE

- When the screen size is Normal or Full, the value between -15 and +15 is adjustable.

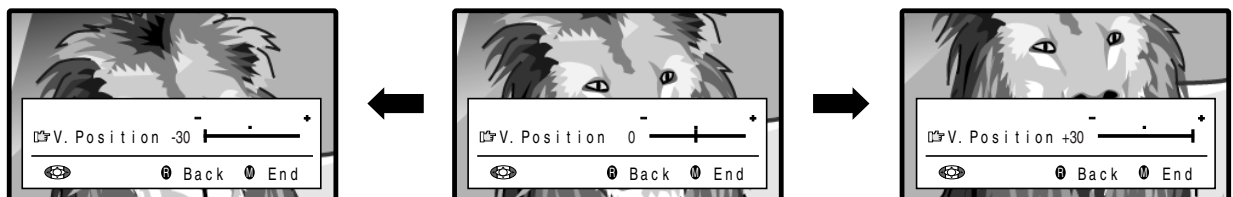

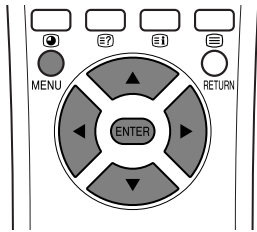

Selecting speakers

You can output audio using the supplied speakers (detachable) or other external speakers.

- 1** Press **MENU** to display the TV menu.
- 2** Press **▲/▼** to select "Features", and then press **ENTER**.
- 3** Press **▲/▼** to select "Speaker", and then press **ENTER**.
- 4** Press **◀/▶** to select "Detachable" or "External", and then press **ENTER**.
- 5** Press **MENU** to exit.

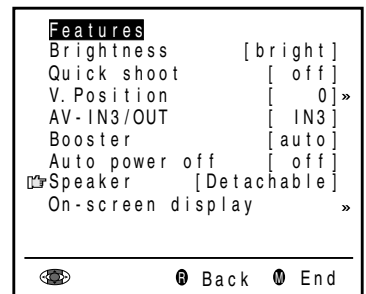
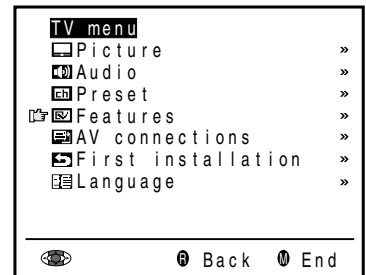

Connecting external speakers

Rear view

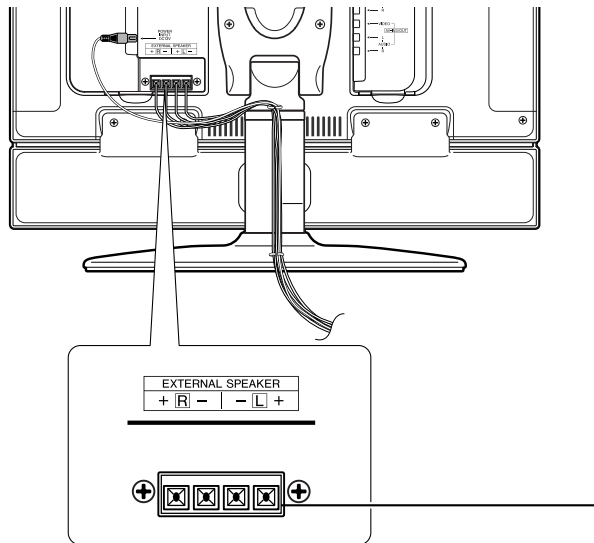

How to connect the speaker cable

- 1** Pull up the lid.
- 2** Insert the edge of the cable.
- 3** Put the lid back down.

- Bundle the cables of the external speakers with clamps as shown above.

CAUTION

- Make sure external speakers have 4 ohm and 5 watt specifications.
- Connect the plus/minus jacks with the correct cables. Incorrect connection may cause a short.

Make sure to connect the speaker jack and cable polarity (+, -) properly

- The speaker jacks have plus (+) and minus (-) polarity.
- Plus is red and minus is black.
- The cables are also divided into plus and minus.
- When connecting the left/right speakers, be sure to connect the plus/minus jacks with the correct cables.

NOTE

- See page 8 for bundling the cables of the external speakers.
- Unplug the AC cord from the AC outlet before installing the speakers.
- When using the TV with the supplied stand attached, do not remove the speaker. Doing so may disturb the balance leading to product damage or personal injury.

On-screen display

You can adjust various settings for on-screen displays.

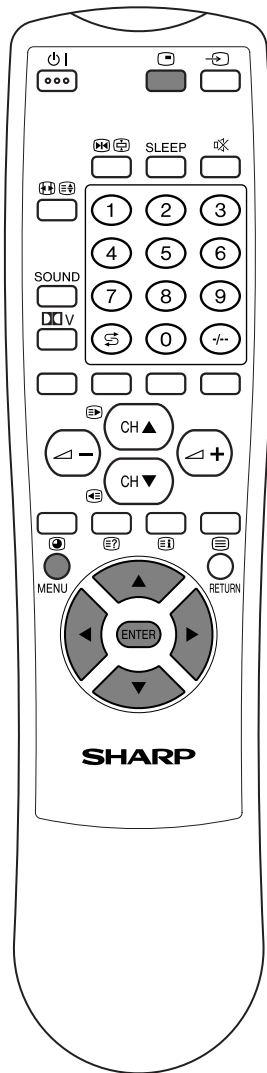

1 Press **MENU** to display the TV menu.

2 Press **▲/▼** to select "Features", and then press **ENTER**.

3 Press **▲/▼** to select "On-screen display", and then press **ENTER**.

4 Press **▲/▼** to select the desired adjustment item. (See the table below.)

5 Press **◀▶** to make the adjustment.

6 Press **MENU** to exit.

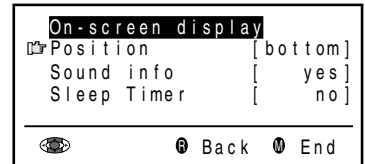
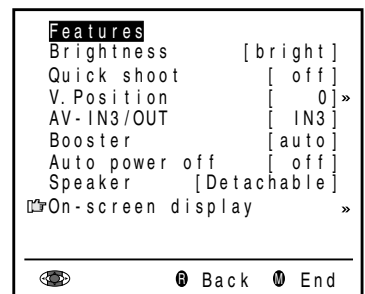
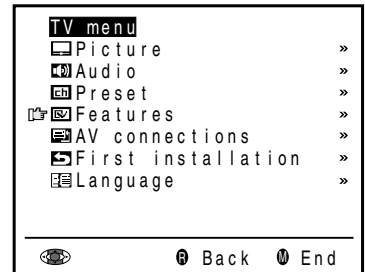

Adjustment item	Choice/Value range	Description
Position	bottom ↔ top	To select the position of the On-screen display.
Sound info	yes ↔ no	To select whether or not sound information is to be displayed, when a channel has been selected.
Sleep Timer	no ↔ yes	To select information to be displayed in the On-screen display. To activate the On-screen display, use the  button.

Wide mode

You can change the screen size using **WIDE** on the remote control.

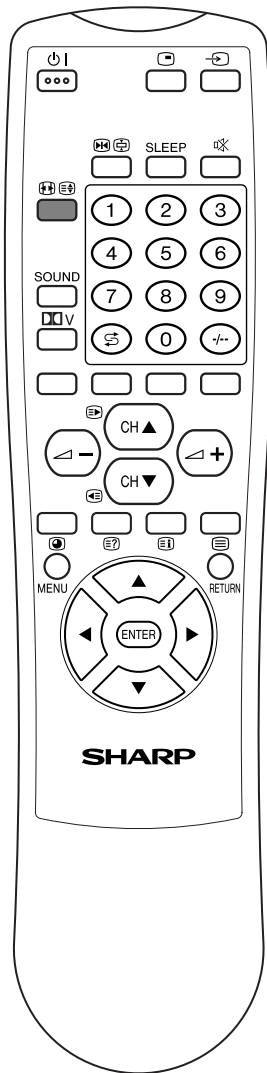

- 1** Press **WIDE** to select the Wide mode.
- 2** Each time you press **WIDE**, the mode changes as follows. You can select the desired mode.

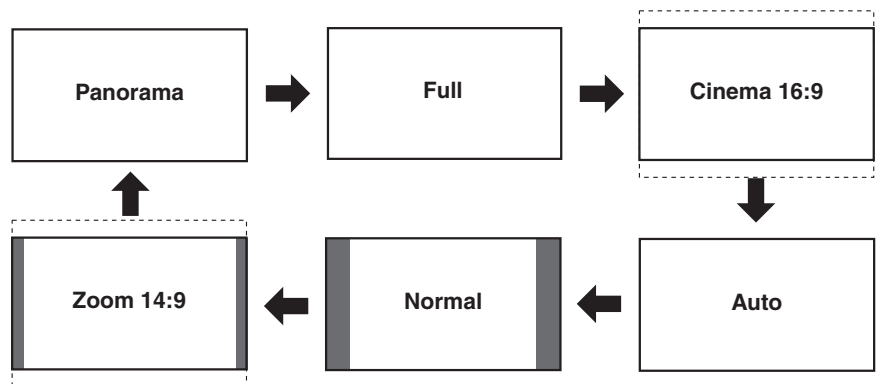
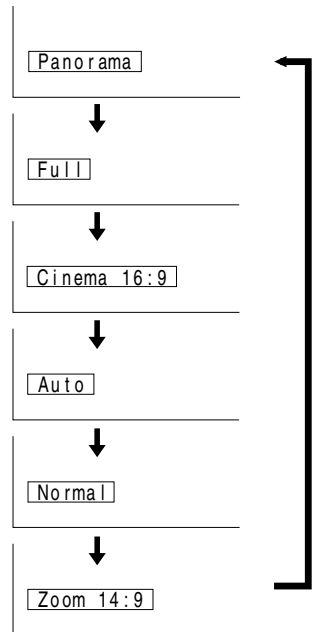

Selected item	Description
Panorama	In this mode the picture is progressively stretched toward each side of the screen.
Full	For 16:9 squeeze pictures.
Cinema 16:9	For 16:9 letterbox pictures. Bars may appear on the top and bottom with some programmes.
Auto	The Wide mode is switched automatically based on WSS (Wide Screen Signalling) information
Normal	For 4:3 "standard" pictures. A side bar appears on each side.
Zoom 14:9	For 14:9 letterbox pictures. A thin side bar appears on each side, and you may also see bars on the top and bottom with some programmes.

NOTE

- WSS (Wide Screen Signalling) information refers to the original wide mode information sent from the broadcasting station.
- When Auto is selected, the Panorama mode is selected automatically in the case WSS information indicates the 4:3 mode.
- Try to set Wide mode if an image does not switch to the correct screen format. When the broadcast signal contains no WSS information, the function will not work even if enabled.
- The Wide mode screen will disappear automatically after 4 seconds.

AV connections

It is possible to manually adjust various settings for connections with external devices on the "AV connections" screen.

[1] AV1/AV2/AV3/COMPONENT

Select the appropriate signal type and colour standard for the signals from the video equipment connected to the AV1, AV2, AV3 or COMPONENT terminal.

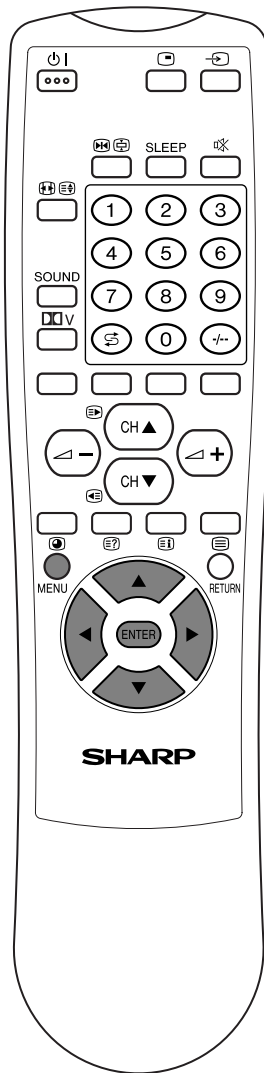

1

Press **MENU** to display the TV menu.

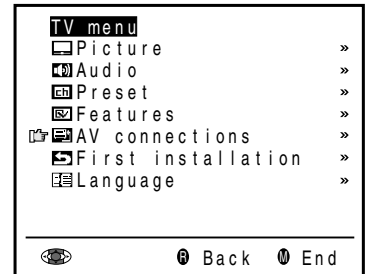

2

Press **▲/▼** to select "AV connections", and then press **ENTER**.

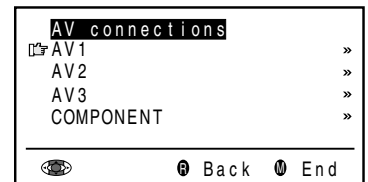

3

Press **▲/▼** to select "AV1", "AV2", "AV3", or "COMPONENT", and then press **ENTER**.

Example when AV1 is selected:

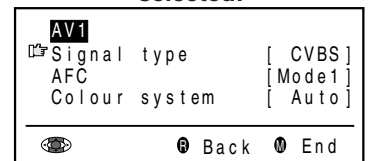

4

Press **▲/▼** to select the desired item, and then press **ENTER**.

Example when AV2 is selected:

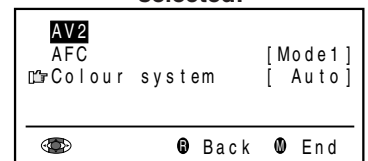

5

Press **◀/▶** to select the desired "Signal type", "AFC" and "Colour system", and then press **ENTER**.

6

Press **MENU** to exit.

Adjustment item	Choice/Input value	Description
Signal type(*1)	Auto, CVBS, Y/C	To select the signal type of external equipment.
AFC	Mode1, Mode2	To select frequency control modes. Mode1 is suitable for DVD players or decoders, and Mode2 is suitable for VCRs or Camcorders.
Colour system(*2)	Auto, PAL, SECAM, N358 (NTSC 3.58), N443 (NTSC 4.43), PAL60	Colour norm

(*1) "Signal type" is only visible when the AV1 is selected.

(*2) You can only select "Auto", "PAL", "N358", "N443" in "Colour system" when COMPONENT is selected.

NOTE

- If no (colour) image displays, try to change to a different signal type.
- Depending on the compatibility with the various types of equipment, the picture may become skewed. In this case, select the "AFC" (Automatic Frequency Control) mode that will improve the picture.
- Switching between AV input signals may be slow, depending on the settings in "Colour system". If you want to speed up signal switching, switch "Auto" in "Colour System" to the current reception colour system.

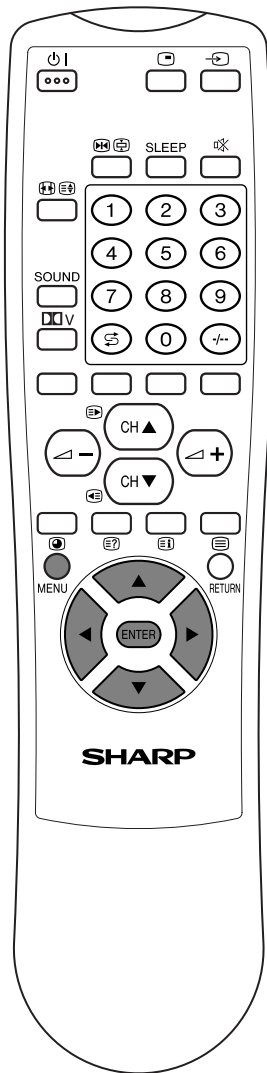

Preset

[1] Automatic search

Perform the procedure below to search for and store new programmes after the First installation routine.

1

Press **MENU** to display the TV menu.

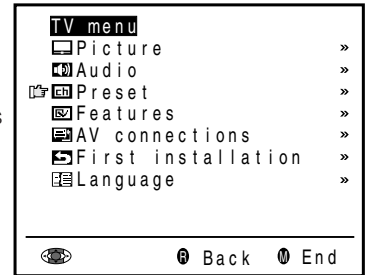

2

Press **▲/▼** to select "Preset", and then press **ENTER**.

3

Press **▲/▼** to select "Automatic search", and then press **ENTER**.

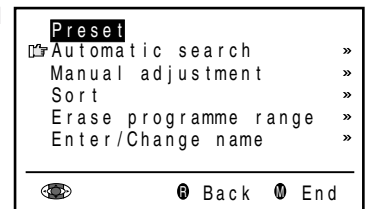

4

Press **▲/▼** to select the desired item, and then press **ENTER**.
Press **◀/▶** to select the desired item.

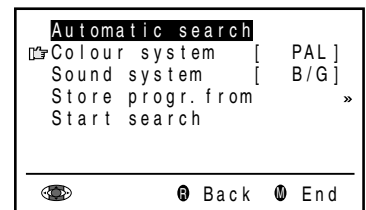

5

Press **▲/▼** to select "Store progr. from", and then press **ENTER**.

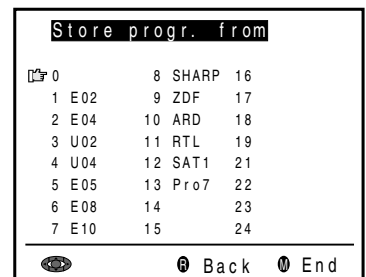

6

Press **▲/▼/◀/▶** to select the programme position from which the programmes are to be stored, and then press **ENTER**.

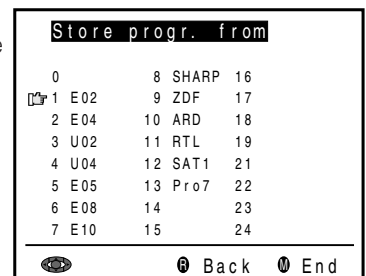

7

Press **▲/▼** to select "Start search", and then press **ENTER** to begin the automatic programme search.

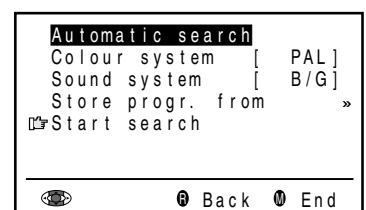

NOTE

- When the search is completed, the new programmes found are displayed in yellow on the programme list.

8

After the search is completed, press **MENU** to exit.

Preset (Continued)

[2] Manual adjustment

Individual settings of programmes can be adjusted.

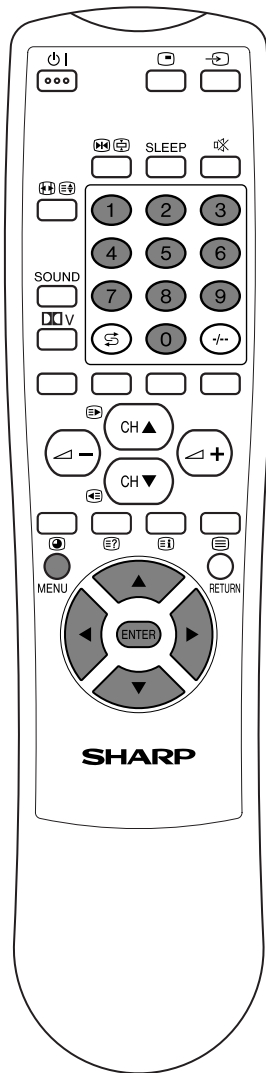

1 Perform steps **1** and **2** in **[1] Automatic search** to display the "Preset" screen.

2 Press ▲/▼ to select "Manual adjustment", and then press **ENTER**.

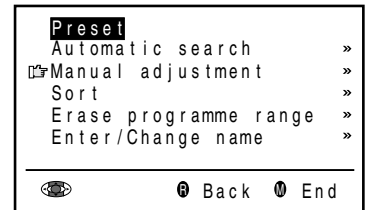

3 Press ▲/▼ to select the item, and then press ◀/▶ to make the adjustment. (See the table below for details.)

- You can also use **0 – 9** to adjust the "Frequency" items.
- To adjust "Name", first press **ENTER** to activate the text input mode. Press ◀/▶ to select the input position and press ▲/▼ to select the desired character. When you finish inputting, press **ENTER** to set the name.

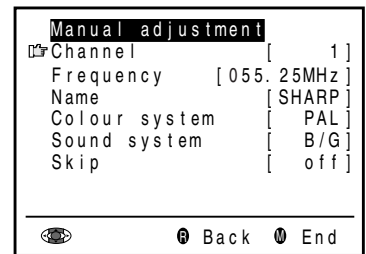

4 Press **MENU** to exit.

Adjustment item	Choice/Value range	Description
Channel	0–99	The channel changes to the higher or lower channel.
Frequency	044 – 859 (MHz) 041.10 – 871.10	Receivable frequencies depending on TV norm, installation site, and range.
Name	A – Z, 0 – 9, +, -, ., /, !, _	Programme name (up to five characters).
Colour system	Auto, PAL, SECAM N358, N443, PAL60	Colour norm
Sound system	B/G, I, D/K, M, Auto*	TV norm
Skip	off↔on	Channel numbers with a "(•) (RED)" mark on the left are set to Skip.

* You can select "Auto" in sound system only during first installation and automatic search.

NOTE

- Depending on the settings in the colour system of the channels, switching between channels may be slow. If you want to speed up channel switching, switch "Auto" in "Colour system" to the current reception system (PAL, SECAM, N358, N443 or PAL60).

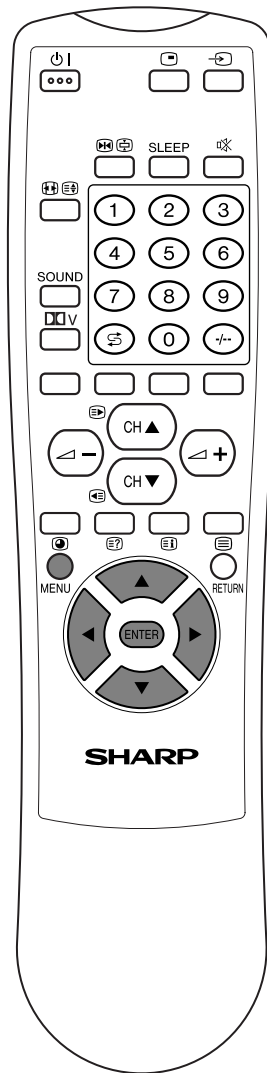

Preset (Continued)

[3] Sort

The programme positions for individual programmes can be freely changed.

1

Perform steps **1** and **2** in **[1] Automatic search** to display the "Preset" screen.

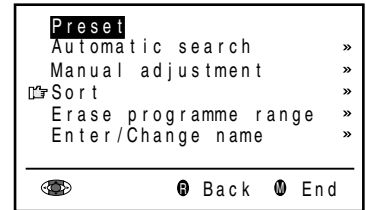

2

Press ▲/▼ to select "Sort," and then press **ENTER**.

3

Press ▲/▼/◀/▶ to select the desired programme, and then press **ENTER** to sort.

- When **ENTER** is pressed, the Move mode is activated. Press ▲/▼ to move the currently marked programme to the desired programme position. When the channel has moved to the desired position, all the preceding/subsequent channel positions will move up/down. Press **ENTER** to leave the Move mode.

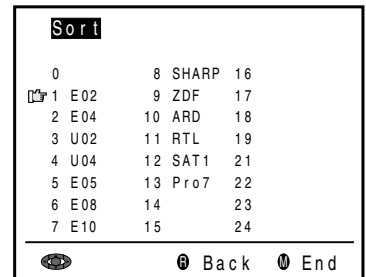

4

Press **MENU** to exit.

[4] Erase programme range

The individual programme or programmes in a connected range can be erased.

1

Perform steps **1** and **2** in **[1] Automatic search** to display the "Preset" screen.

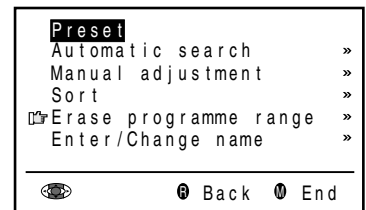

2

Press ▲/▼ to select "Erase programme range", and then press **ENTER**.

3

Press ▲/▼/◀/▶ to select the programme to be erased, and then press **ENTER**. The selected programme is shown in yellow.

- If you want to erase programmes in a connected range, select the programme at the beginning of the desired range.

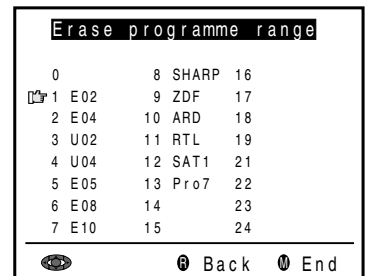

4

If you are erasing programmes in a connected range, press ▲/▼/◀/▶ to select the programme at the end of the range. The selected programmes are shown in yellow.

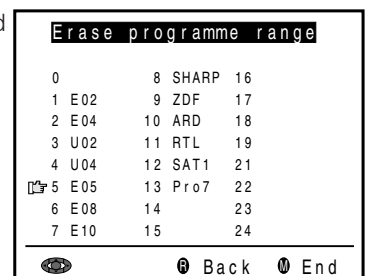

5

Press **ENTER** to erase the selected programme(s). All the subsequent programmes move up.

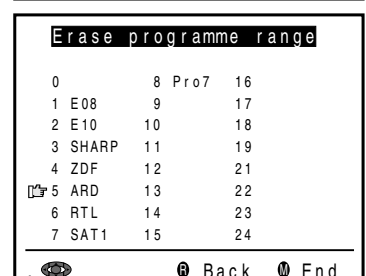

6

Press **MENU** to exit.

Preset (Continued)

[5] Enter/Change name

The name of an individual programme can be entered or changed.

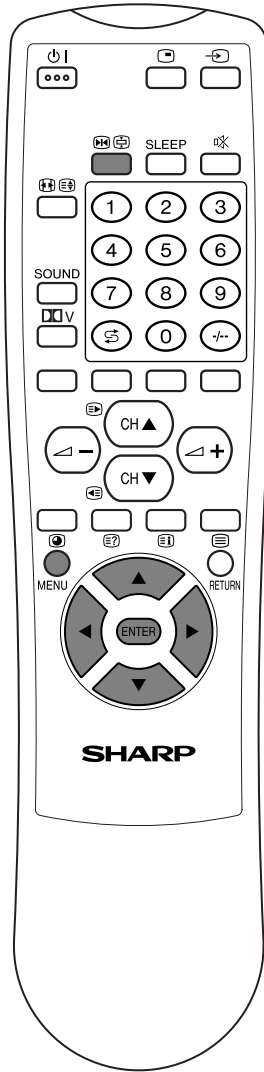

1 Perform steps **1** and **2** in **[1] Automatic search** to display the "Preset" screen.

2 Press **▲/▼** to select "Enter/Change name", and then press **ENTER**.

3 Press **▲/▼/◀/▶** to select the desired programme, and then press **ENTER**. The character at the input position blinks.

4 Press **◀/▶** to select the input position, and then press **▲/▼** to select the desired character.

5 Press **ENTER** to accept the name entered, and then press **MENU** to exit.

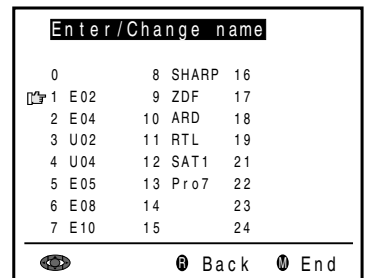
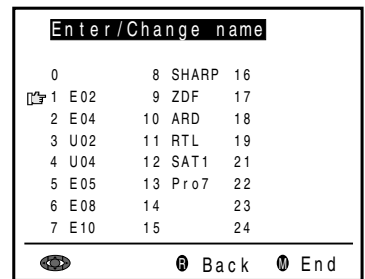
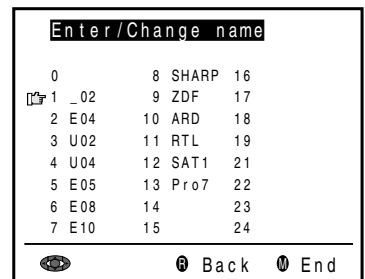
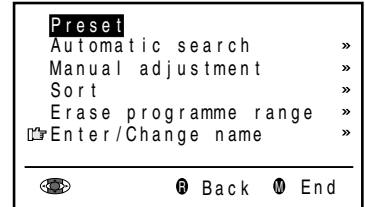

Using FREEZE Setting

You can freeze the image. Freezing image is convenient if you want to take a memo or check something on the display.

- To freeze an image on screen, press **⏸** **⏺**.
- To return to normal view, press **⏸** **⏺**.

NOTE

- You cannot change the screen size when a frozen image displays.
- Do not let the Freeze screen unattended for a long time.

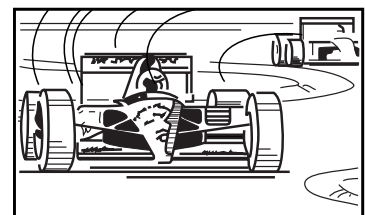

Normal to still image **↓** **↑** Still to normal image

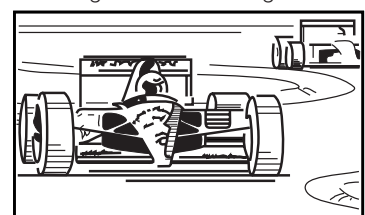

NICAM broadcast selection

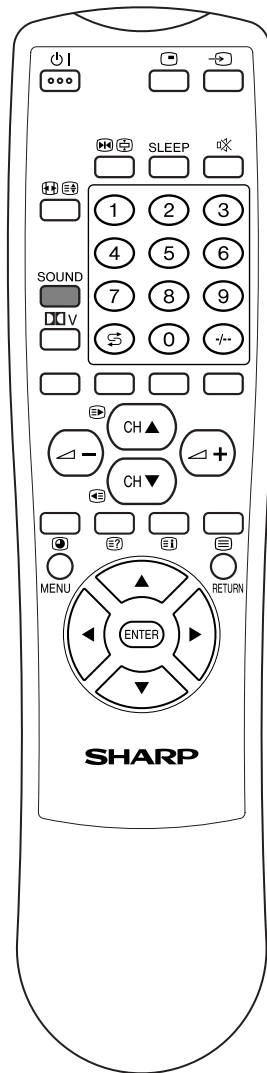

This enables the selection of the reception mode when receiving a NICAM-I or NICAM-B/G signal. To let you enjoy NICAM broadcasting, this LCD TV set receives NICAM system stereo, bilingual, and monaural broadcasts.

Stereo

The LCD TV set is receiving a stereo broadcast.

- Each time you press **SOUND**, the mode changes between "Stereo" and "Mono".
- When "Mono" is selected, the TV sound is output monaurally.

→ Stereo → Mono

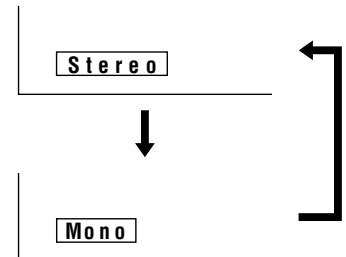

Bilingual

When the LCD TV set is receiving a bilingual programme, the "Sound 1" mode is automatically selected.

- Each time you press **SOUND**, the mode changes as follows:

→ Sound 1 → Sound 2 → Sound 1+2 → Mono

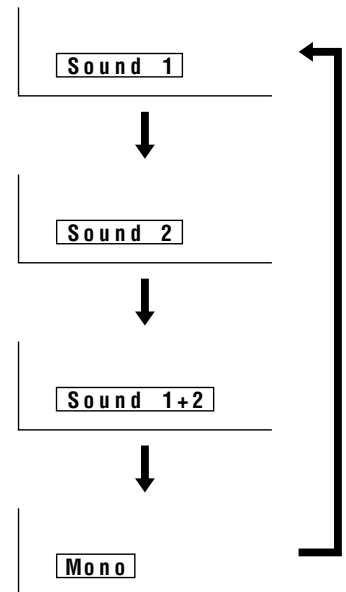

Monaural

The LCD TV set is receiving a monaural broadcast.

- Each time you press **SOUND**, the mode changes between "Nicam" and "Mono".

→ Nicam → Mono

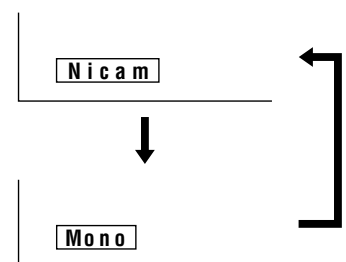

NOTE

- If approximately 3 seconds pass without a button being pressed, the mode setting is automatically terminated and the LCD TV set returns to the normal mode.
- The setting can be individually selected for each channel number.
- You can also turn off the NICAM mode by setting the "TV sound" item to "Mono" in the Audio screen (see page 17).

A2 stereo broadcasts

This enables the selection of the reception mode when receiving an A2 stereo signal. To let you enjoy A2 stereo broadcasting, this LCD TV set receives A2 stereo system stereo and bilingual broadcasts.

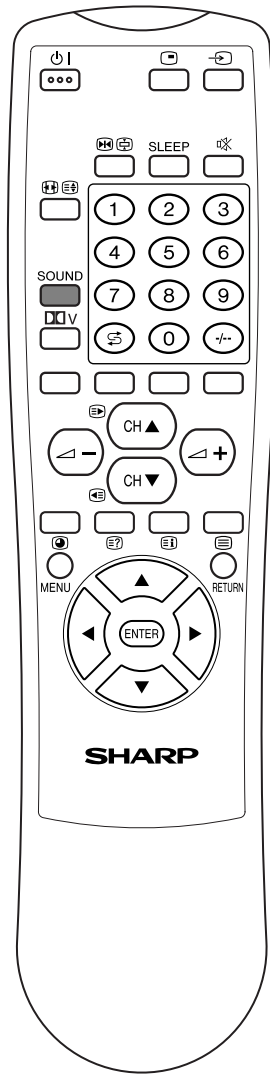

Stereo

The LCD TV set is receiving a stereo broadcast.

- Each time you press **SOUND**, the mode changes between "Stereo" and "Mono".
- When "Mono" is selected, the TV sound is output monaurally.

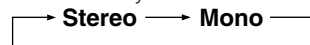

Bilingual

When the LCD TV set is receiving a bilingual programme, the "Sound 1" mode is automatically selected.

- Each time you press **SOUND**, the mode changes as follows:

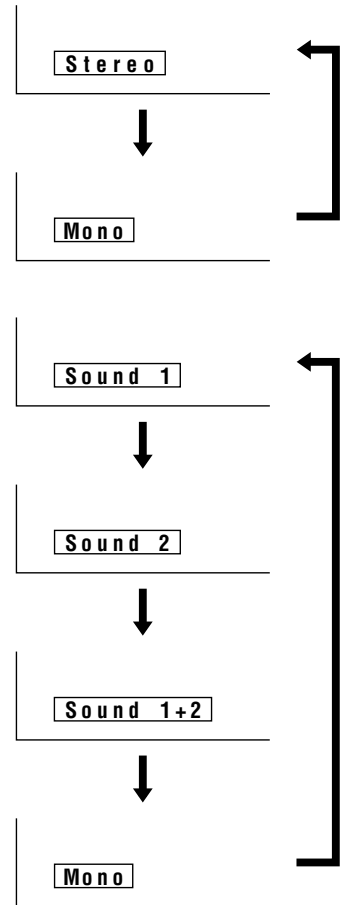
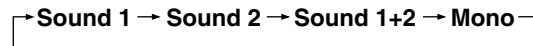

NOTE

- If approximately 3 seconds pass without a button being pressed, the mode setting is automatically terminated and the LCD TV set returns to normal mode setting.
- The setting can be selected individually for each channel number.
- You can also turn off the A2 stereo mode by setting the "TV sound" item to "Mono" in the Audio screen (see page 17).

Teletext

Teletext function

What is Teletext?

Teletext broadcasts pages of information and entertainment to specially equipped television sets. Your System receives Teletext signals broadcast by a TV network, and decodes them into graphical format for viewing. News, weather and sports information, stock exchange prices and programme previews are among the many services available.

NOTE



- Teletext is broadcast in Europe and Asia, excluding regions that use Arabic characters.

Teletext mode

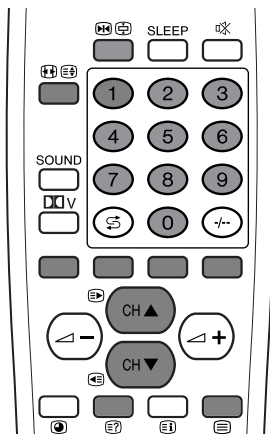
Teletext is turned on/off with  on the remote control unit. You can operate your System in Teletext mode directly by inputting commands with the remote control unit.



Turning on and off Teletext

- 1 Select a TV channel or external input source providing the Teletext programme.
- 2 Press  to display the Teletext.
- 3 Press  to return to normal screen.
 - Each time you press , the screen switches as shown upper right.
 - If you select a programme with no Teletext signal, "No Teletext available." displays.

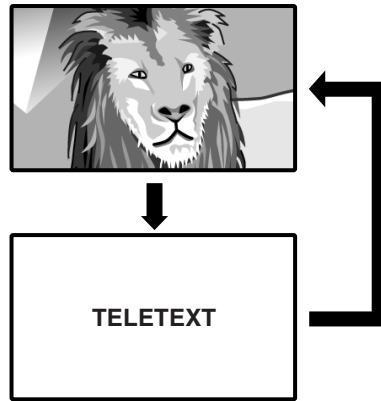

When viewing the Teletext information

- Press **CH ▲** () to increase the page number.
- Press **CH ▼** () to decrease the page number.

Button functions

Colour (RED/GREEN/YELLOW/BLUE):

You can select a group or block of pages displayed in the coloured brackets at the bottom of the screen by pressing the corresponding **Colour (RED/GREEN/YELLOW/BLUE)** on the remote control unit.

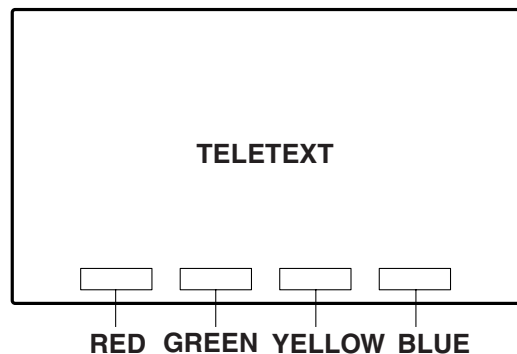

0 – 9:



Directly select any page from 100 to 899 by using **0 – 9**.

:

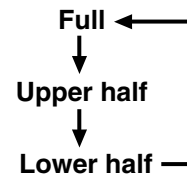
Each time you press , the TELETEXT image switches as shown below.



:

To reveal hidden information such as an answer to a quiz, press .
 • Press  again to hide the information.

:

To stop updating Teletext pages automatically, press .
 • Press  again to release the hold mode.

Teletext

■ Displaying Subpages

You can display several subpages as they are transmitted.

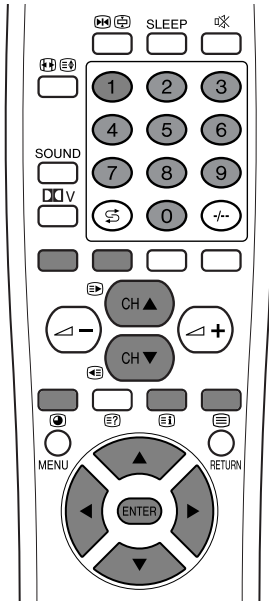

1

Press to display Teletext.

2

Press to display the subpage as shown below.

Subpage screen

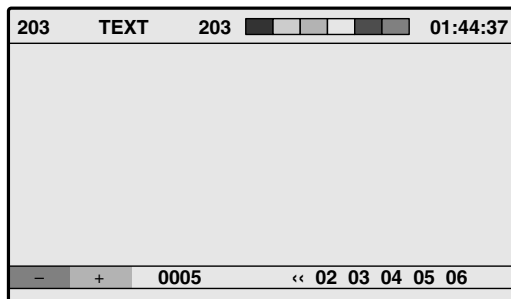

3

Select the desired subpage by using / / **RED/GREEN**.

- 0 – 9 directly selects the desired subpage.

4

Press to exit the subpage screen.

- If you press / (**CH▲/CH▼**), the present page will change to the next/previous page and simultaneously exit the subpage screen.

■ Displaying TOP Overview

When receiving TOP Teletext, you can read a TOP text overview.

1

Press to display Teletext.

2

Press to display the TOP Overview as shown below.

TOP Overview screen

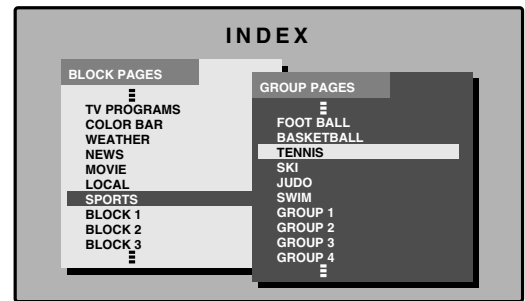

3

Select the desired block or group by using / / / .

4

Press **ENTER** to display the selected block or group pages.

5

Press to exit the TOP Overview screen.

■ Teletext language setting

If Teletext information does not display correctly, perform the setting procedure below. Select from among 4 kinds of language tables: West Europe, East Europe, Turkish/Greek, Cyrillic. Each table is compatible with the Teletext languages listed below.

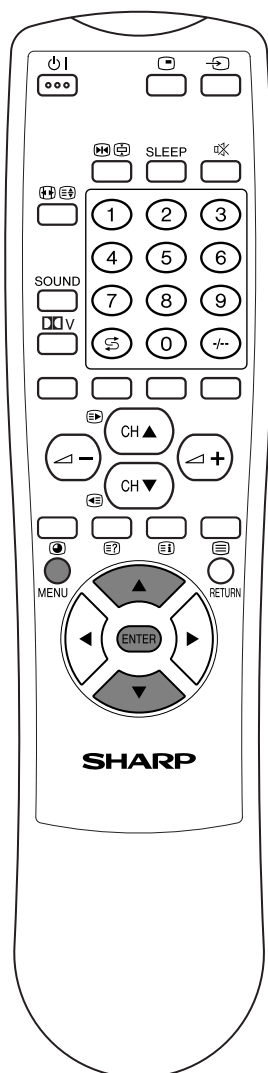

1

Press **MENU** to display the “Character set” screen.

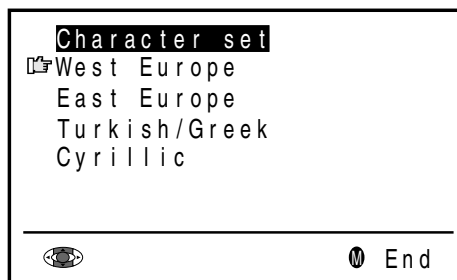

2

Press **▲/▼** to select the desired character set.

- The colour of the letters will turn to yellow. When selecting the character set, pressing **ENTER** will change the letters to magenta for an instant and then return them back to yellow.
- West Europe - English, French, Scandinavian, Czech, German, Spanish, Italian
- East Europe - Polish, French, Scandinavian, Czech, German, Slovenian/Croatian, Italian, Rumanian
- Turkish/Greek - English, French, Scandinavian, Turkish, German, Spanish, Italian, Greek
- Cyrillic - English, Russian, Estonian, Czech, German, Spanish, Ukrainian, Lettish

NOTE

- Teletext can display only when it is sent by a network. Not used to convert between languages.

3

Press **MENU** to exit.

Connecting external devices

You can enjoy picture and sound by connecting a VCR or a home video game system to the terminals located on the rear of the TV set.

When connecting an external device, turn off the power of the main unit first to prevent any possible damage.

Examples of external devices that can be connected

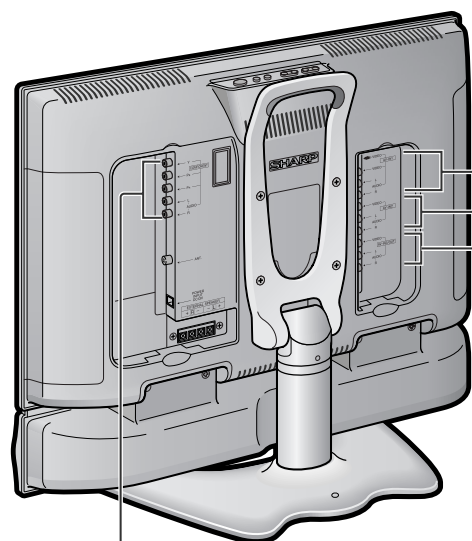

To AV-IN1 terminal

<Example>

- Camcorder
- Home video game system

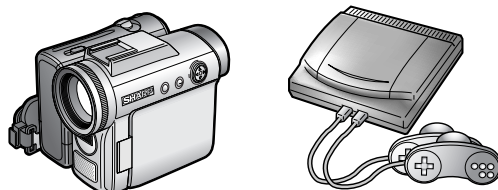

* If your external device has an S-video terminal, S-VIDEO connection is recommended.

To COMPONENT terminal

<Example>

- DVD Player, etc.



* If your external device has a component terminal, COMPONENT connection is recommended (you can view high-quality pictures).

To AV-IN2/3 terminal

<Example>

- VCR



NOTE

- PC connection is not possible.
- For the cable, use a commercially available audio/video cable.
- Only connect audio/video signals to AV-IN1, 2 and 3 terminals. Connecting other signals may result in a malfunction.
- AV-IN1 has 2 video input terminals: VIDEO and S-VIDEO. When you connect external devices to both terminals (and if you select AV-IN1), you can only view pictures from the S-VIDEO terminal. To view the picture from the VIDEO terminal, do not connect any external device to the S-VIDEO terminal.
- For more information about external device connections, see the manuals of your external devices.

Connecting external devices

Connecting a VCR, DVD player or a camcorder (AV-IN1/2/3/COMPONENT)

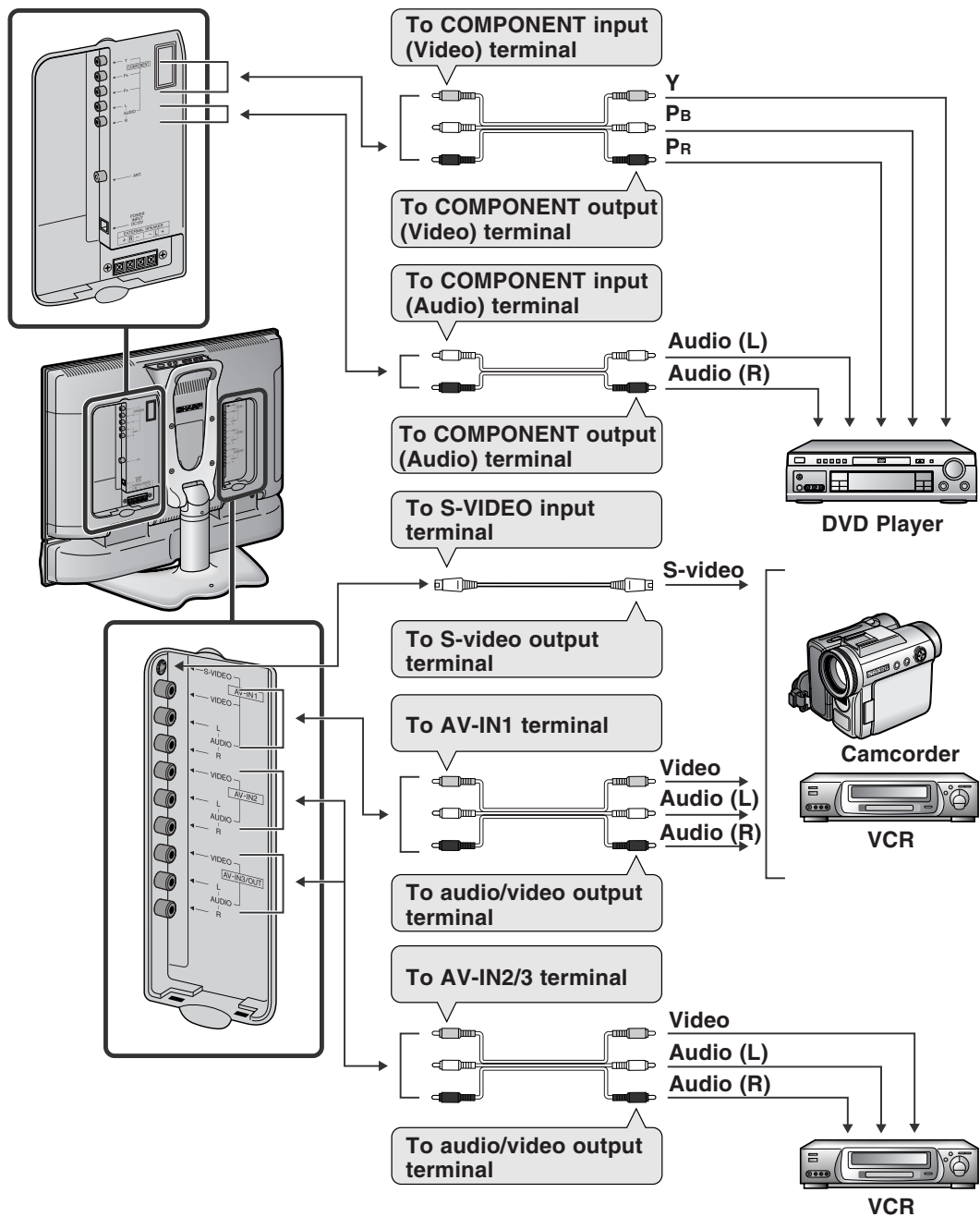

NOTE

- If your VCR (or other external devices) has an S-video terminal, S-VIDEO connection is recommended. (Use an S-video cable.)
- When you connect external devices to both S-VIDEO and VIDEO terminals (and if you select AV-IN1), you can only view pictures from the S-VIDEO terminal.
- You cannot view multiple or synthesized pictures by connecting two or more external devices. When connecting an external device, use care to connect the video and audio cables to the corresponding terminals.

Connecting external devices

Outputting video and audio (video output)

You can output video and audio signals from the TV set through the AV output terminals (AV-IN3/OUT).

- When using AV3 as an output terminal, select "Features" in the menu and set "AV-IN3/OUT" to "OUT". (See page 19.)
- The factory setting for "AV-IN3/OUT" is "IN3".

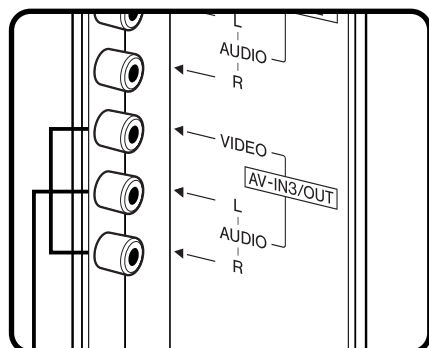

Connect to a VCR,
audio amplifier, etc.

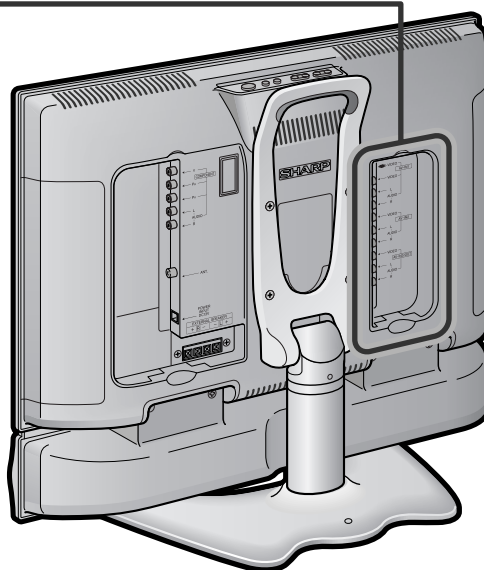







NOTE

- When using the Y, P_B and P_R input for COMPONENT, no video output will be made to the AV output terminal, but audio will be made for connection to external audio systems.

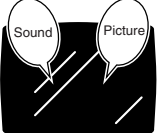
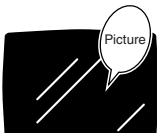
Troubleshooting

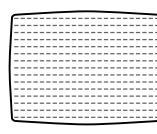



■ Before calling for repair service, check the following items for possible remedies to the encountered symptoms.

TV set

Problem	Check item	Reference Pages
 <p>There is no picture or sound.</p>	<ul style="list-style-type: none"> • Make sure the AC adapter is properly inserted in the power outlet. • Reception other than those of broadcasting stations can be considered. • Make sure the input mode is set to TV. • Make sure the MAIN POWER switch of the main unit is on. 	<p>6</p> <p>–</p> <p>11</p> <p>11</p>
 <p>There is no picture. There is no picture from AV-IN 1/2.</p>	<ul style="list-style-type: none"> • Make sure the “Black level” is properly adjusted. • Fluorescent lamp may have reached the end of service life. • Make sure the S-Video terminal is free of connections. 	<p>16</p> <p>39</p> <p>35</p>
 <p>There is no sound.</p>	<ul style="list-style-type: none"> • Make sure the volume is not set to minimum. • Make sure the sound is not set to mute. 	<p>12</p> <p>12</p>
 <p>There is no picture or sound, just noise.</p>	<ul style="list-style-type: none"> • Make sure the antenna cable is properly connected. • Bad reception can be considered. 	<p>6</p> <p>–</p>
 <p>Picture is not clear.</p>	<ul style="list-style-type: none"> • Make sure the antenna cable is properly connected. • Bad reception can be considered. 	<p>6</p> <p>–</p>
 <p>Picture is light or improperly tinted.</p>	<ul style="list-style-type: none"> • Check colour adjustment. (NTSC mode) 	<p>16</p>
 <p>The picture is too dark.</p>	<ul style="list-style-type: none"> • Check if “Brightness” is set to “Dark”. • Check “Contrast” and “Black level” adjustment. • Fluorescent lamp may have reached the end of service life. 	<p>19</p> <p>16</p> <p>39</p>
Remote control does not work.	<ul style="list-style-type: none"> • Check if batteries in the remote control have sufficient power. • Make sure the remote sensor window is not under strong fluorescent lighting. 	<p>5</p> <p>5</p>
Unit cannot be operated.	<ul style="list-style-type: none"> • External influences such as lightning, static electricity, etc., may cause improper operation. In this case, operate the unit after first turning the power off the LCD TV unit, or unplugging the AC cord and re-plugging it in after 1 or 2 minutes. 	<p>–</p>

Troubleshooting

Antenna

Problem	Check item
 <p>The picture is not sharp.</p>  <p>The picture moves.</p>	<ul style="list-style-type: none"> • The reception may be weak. • The state of the broadcast may also be bad. • Make sure the antenna is facing the right direction. • Make sure the outside antenna is not disconnected.
 <p>The picture is doubled or tripled.</p>	<ul style="list-style-type: none"> • Make sure the antenna is facing the right direction. • There may be reflected electric waves from mountains or buildings.
 <p>The picture is spotted.</p>	<ul style="list-style-type: none"> • There may be interference from automobiles, trains, high voltage lines, neon lights, etc. • There may be interference between the antenna cable and power cable. Try positioning them further apart.
 <p>There are stripes on the screen or colours fade.</p>	<ul style="list-style-type: none"> • Is the unit receiving interference from other devices? Transmission antennas of radio broadcasting stations or amateur radios, and cellular phones may also cause interference. • Use the unit as far apart as possible from devices that may cause possible interference.

■ Cautions regarding use in high and low temperature environments

- When the unit is used in a low temperature space (e.g. room, office), the picture may leave trails or appear slightly delayed. This is not a malfunction, and the unit will recover when the temperature returns to normal.
- Do not leave the unit in a hot or cold location. Also, do not leave the unit in a location exposed to direct sunlight or near a heater, as this may cause the cabinet to deform and the LCD panel to malfunction.
(Storage temperature: -20°C to +60°C)

Specifications

Item		22" LCD COLOUR TV, Model: LC-22AA1M	
LCD panel		22" Advanced Super View & BLACK TFT LCD	
Number of dots		1,229,760 dots (854 × 480 × 3 dots)	
Video colour system		PAL/SECAM/NTSC 3.58/NTSC 4.43/PAL 60	
TV Function	TV-Standard		CCIR (PAL: B/G, D/K, I SECAM: B/G, D/K NTSC: M)
	Received Freq. range	UHF	431.25 MHz - 863.25MHz
		VHF	45.25 MHz - 140.25MHz, 147.25MHz - 423.25MHz
	TV-Tuning System		Auto Preset 99 ch, Auto Label, Auto Sort
STEREO/BILINGUAL		NICAM/A2 stereo	
Brightness		430 cd/m ²	
Lamp life		60,000 hours	
Viewing angles		H: 170° V: 170°	
Audio amplifier		5.0 W × 2	
Speakers		ø 6 cm 2 pcs, ø 2.5 cm 2 pcs	
Terminals	Rear	ANTENNA IN	UHF/VHF 75 Ω Din type
		AV-IN 1	Composite video, S-video, Audio
		AV-IN 2	Composite video, Audio
		AV-IN 3/OUT	Composite video, Audio IN/Composite Video, Audio OUT
		COMPONENT	Y, Pb, Pr/Audio
		SP OUTPUT	External speaker (L and R)
	Front	Headphones	ø 3.5 mm jack (Front)
OSD language		English/Chinese/Arabic	
Power requirement		DC 13 V, AC 110 V – 240 V, (50/60 Hz)	
Power Consumption		59 W (1.4 W at Standby) : AC 110 – 240 V (with AC Adapter)	
		47 W : DC 13 V	
Weight		10.0 kg w/o accessories	
Accessories		Operation manual, Remote control, Battery (× 2), AC adapter, AC cord, Cable clamps (× 2), Antenna cable	

■ As a part of policy of continuous improvement, SHARP reserves the right to make design and specification changes for product improvement without prior notice. The performance specification figures indicated are nominal values of production units. There may be some deviations from these values in individual units.

Dimensional drawings

Unit: mm

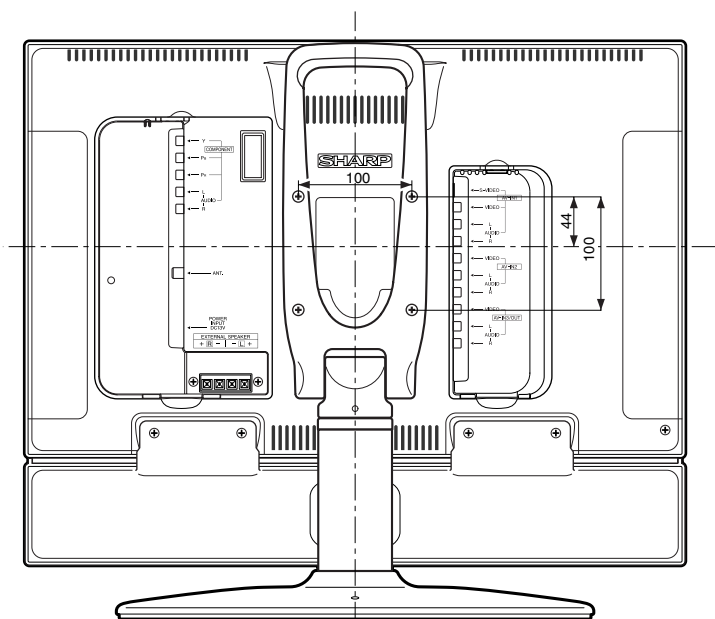
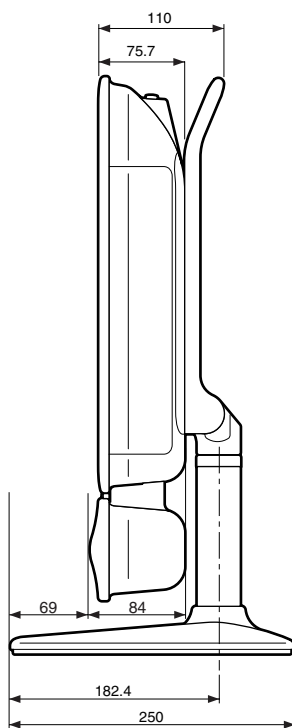
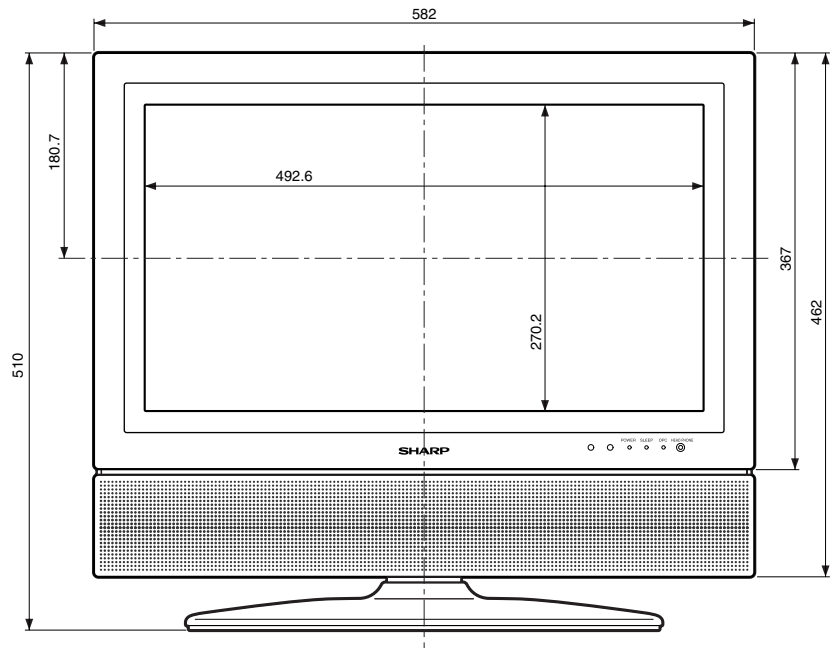
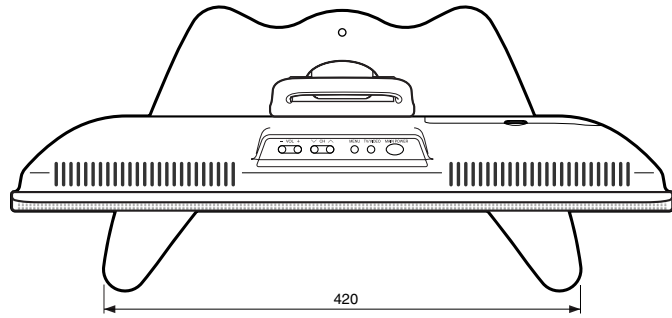

Free Manuals Download Website

<http://myh66.com>

<http://usermanuals.us>

<http://www.somanuals.com>

<http://www.4manuals.cc>

<http://www.manual-lib.com>

<http://www.404manual.com>

<http://www.luxmanual.com>

<http://aubethermostatmanual.com>

Golf course search by state

<http://golfingnear.com>

Email search by domain

<http://emailbydomain.com>

Auto manuals search

<http://auto.somanuals.com>

TV manuals search

<http://tv.somanuals.com>