

# SHARP



VC-MH715HM Shown

**VC-MH715HM**  
**VC-MH705HM**  
**VC-MH705LM**

## **VIDEO CASSETTE RECORDER OPERATION MANUAL**

- **AUTO TUNING**
- **SHARP SUPER PICTURE**
- **NICAM Hi-Fi STEREO**
- **6 HEAD EXTENDED PLAY**
- **CHILD LOCK**
- **NTSC SIMPLE PLAYBACK**

**VHS** **VIDEO Plus+**<sup>®</sup>  
PAL

## Dear SHARP Customer

Thank you for buying this SHARP VCR. Given proper care it will provide years of entertainment for the whole family. Please read this operation manual carefully before attempting to operate the VCR.

## Copyright

- Audio-visual material may consist of copyrighted works which must not be recorded without the authority of the owner of the copyright. Please refer to the relevant laws in your country.
- No part of this publication may be reproduced, stored or transmitted in any form without prior permission from SHARP Electronics (UK) Ltd.
- VIDEO Plus+ and PlusCode are registered trademarks of Gemstar Development Corporation.
- The VIDEO Plus+ system is manufactured under license from Gemstar Development Corporation.

**This manual covers a range of models, not all of the features included will be relevant to your VCR.**

**If you require any advice or assistance regarding your Sharp product, please visit our web-site [www.sharp.co.uk/support](http://www.sharp.co.uk/support). Customers without Internet access may telephone 08705 274277 during office hours (or (01)676 0648 if telephoning from Ireland).**



### SAFETY WARNINGS

Observe all warnings for your safety and to ensure trouble free use of your VCR.

### INFORMATION

Additional information complements instructions.

# VCR REMOTE CONTROL

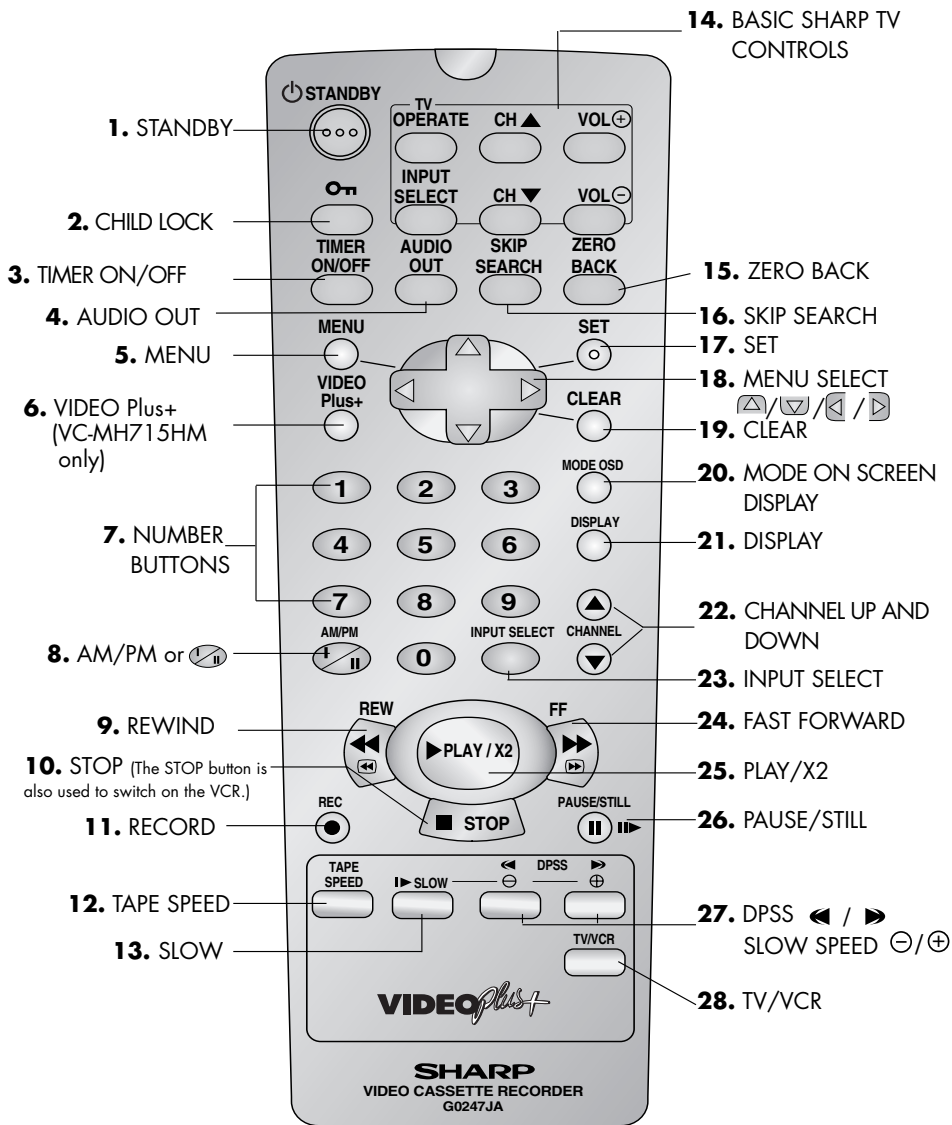

## VCR FRONT PANEL/REMOTE CONTROL EQUIVALENT FUNCTIONS.

If you prefer, or if remote control batteries fail, you will need to use the VCR front panel controls. The only differences in function are shown below:

FUNCTION OSD On-Screen Display	OPERATION WITH REMOTE CONTROL	OPERATION WITH VCR FRONT PANEL
Moving UP/DOWN menu	Menu Select buttons	<b>CHANNEL</b> buttons. Press the <b>FF</b> or <b>REW</b> buttons on the front of the VCR.
Moving LEFT/RIGHT menu	Menu Select buttons	

## CALLING FOR SERVICE

- If you are unable to resolve a problem using the TROUBLESHOOTING guide, do not remove the cabinet or attempt to service this VCR yourself.
- For service please contact your dealer. If this is not possible, please call our Customer Information Centre for details of your nearest Sharp Service Centre.
- In the unlikely event of this equipment requiring repair during the guarantee period, you will need to provide proof of the date of purchase to the repairing company. Please keep your invoice or receipt which is supplied at the time of purchase.
- Certain replacement parts and accessories may be obtained from our main parts distributor who can be contacted at: Willow Vale Electronics Limited  
Tel. 0121 766 5414. Most credit/debit cards accepted.

**SHARP Customer Helpline: Tel: 08705 274277 during office hours  
(or (01) 676 0648 if telephoning from Ireland)**

**Alternatively, please visit our web-site:  
[www.sharp.co.uk/support](http://www.sharp.co.uk/support)**

This equipment complies with the requirements of Directives 89/336/EEC and 73/23/EEC as amended by 93/68/EEC.

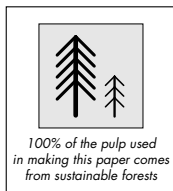

- Specifications are subject to change without notice as part of our policy of continuous improvement.
- No liability is accepted for any inaccuracies or omissions in this publication, although every possible care has been taken to make it complete and as accurate as possible.

## SHARP ELECTRONICS (U.K.) Ltd.

# CONTENTS

## BEFORE USING YOUR VCR

Important notes on your VCR .....	2
Unpacking the accessories.....	3

## INSTALLING YOUR VCR

Connecting the cables .....	4
Auto Tuning .....	5

## BASIC OPERATION

Scart lead connection (Not supplied).....	9
Important notes on your VCR and video tapes .....	9
How to playback a video tape.....	9
Sharp Super Picture .....	10
Pausing and slow motion.....	10
Fast forwarding/rewinding a video tape.....	11
Immediate recording.....	11
Tape speed selection .....	12
How to use the VIDEO Plus+ <sup>®</sup> system to make a recording (VC-MH715HM only).....	13
How to set a delayed recording .....	15

## ADVANCED OPERATION

Audio and your VCR .....	18
Playback of a video tape .....	20
Checking the amount of tape remaining.....	20
Playing back a video tape repeatedly .....	20
Playing back an NTSC tape .....	21
LCD Display .....	22
Tape counter and zero back.....	22
Blue mute .....	23
Colour .....	23
Searching the video tape .....	24
Skip searching the video tape.....	24
Digital programme search system (DPSS) .....	24
Recording from other equipment .....	25

## OTHER FEATURES ON YOUR VCR

Child lock .....	26
Decoder switching operation.....	27

## CUSTOMISED INSTALLATION

Manually tuning a channel.....	28
Manually sorting channels .....	29
Sorting the channels into your preferred order.....	29
Deleting channels .....	30
Manually setting the clock.....	31

## MORE INFORMATION ABOUT YOUR VCR

VCR display .....	32
Selecting the output from the VCR.....	32
On-screen display .....	33
Specifications.....	34
Troubleshooting .....	35
VCR reset.....	37
RF channel tuning .....	37
Guarantee .....	38
Connecting to the mains .....	39
Calling for Service .....	Back Cover

## BEFORE USING YOUR VCR

# IMPORTANT NOTES ON YOUR VCR

### IDEAL VCR LOCATION

#### PLACE THE VCR..

- ... on a flat level surface away from radiators or other heat sources and out of direct sunlight.
- ... and video tapes away from magnetic sources such as speakers or microwave ovens.
- ... at least 8" (20cm) away from the TV.
- ... away from curtains, carpets or other materials and allow ventilation space around the VCR.

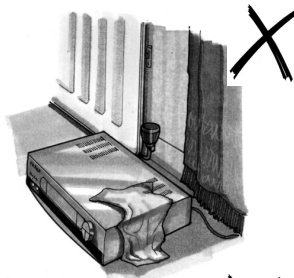

#### DO NOT...

- ... block the air-vent openings.
- ... expose the VCR to excessive dust, mechanical vibration or shock.
- ... place any heavy object or liquid on top of the VCR. If liquid drops inside the VCR unplug immediately and contact your SHARP dealer. Do not use the VCR.
- ... insert or drop anything into the tape compartment or through the air-vents, as this could result in serious damage, fire or an electric shock.

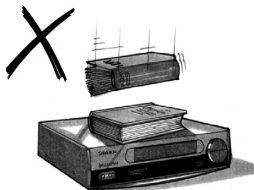

#### POWER SOCKETS

- To avoid overheating or even fire, insert the plug correctly into the socket.

#### DO NOT...

- ... overload power sockets, this may cause a fire or electric shock.
- ... pull the power cord to disconnect the plug from the mains.
- ... bind the power cords together.
- This VCR is not equipped with a mains power switch. Accordingly, nominal current to drive the clock is drawn at all times when the AC power cord is plugged into a wall socket. If the VCR is not to be used for an extended period be sure to unplug the cord.

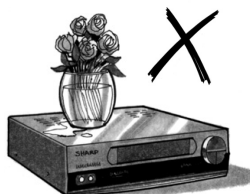
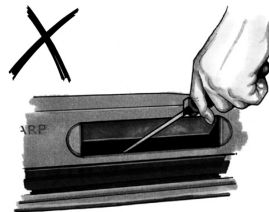

## BEFORE USING YOUR VCR

# UNPACKING THE ACCESSORIES

CHECK ALL THESE ACCESSORIES ARE SUPPLIED WITH YOUR VCR. CONTACT YOUR DEALER IF ANY ARE MISSING.

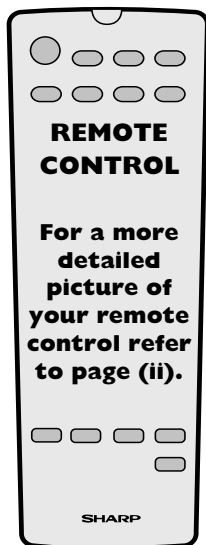

**(TYPE AA/R6/UM3)  
BATTERIES (X2)**  
for the remote control unit.



**RF CONNECTION CABLE**  
connects the VCR to the TV.

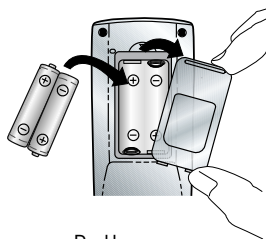

Battery cover

### To fit the batteries into the remote control

Remove the battery cover on the back of the remote control. Fit the batteries:  $\ominus$  to  $\ominus$  and  $\oplus$  to  $\oplus$  terminals. Place the battery cover back into position.



### Remote Control

- Remote Control must be pointed towards the VCR to operate.
- Do not expose to liquid or shock.
- May not function if the VCR is in direct sunlight or any other strong light.
- Replace both alkaline batteries (type AA/R6/UM3) if the remote control fails.
- Remove the batteries and keep in a safe place if you do not plan to use the VCR for several months.
- Remove and dispose of flat batteries safely and promptly.
- Incorrect use of batteries may cause them to leak or burst.

[www.sharp.co.uk/support](http://www.sharp.co.uk/support)

## INSTALLING YOUR VCR

### CONNECTING THE CABLES

- 1 Connect your existing aerial cable to the **AERIAL IN** socket on your VCR.

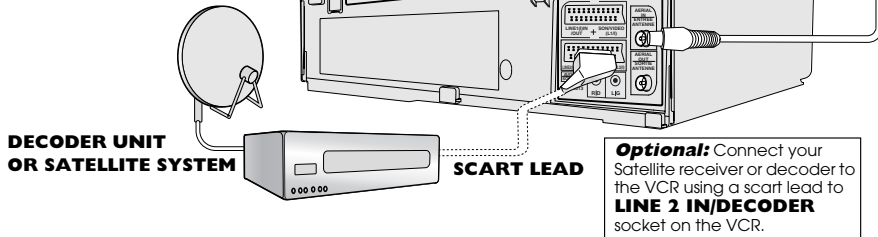

- 2 Connect your TV to the VCR using the supplied RF connection cable, i.e. connect the VCR **AERIAL OUT** socket to the TV **AERIAL IN** socket.

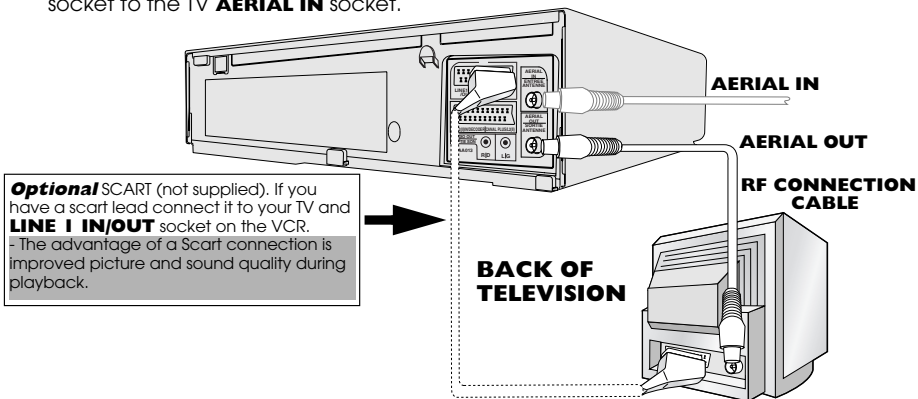

- 3 Connect the VCR to the mains.

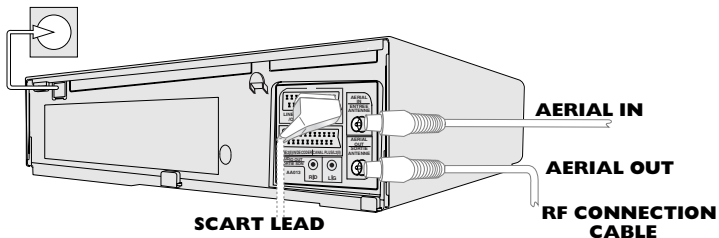

✓ *The VCR is correctly connected.*



## INSTALLING YOUR VCR

### AUTO TUNING

#### PROCEDURE

This model automatically tunes the TV channels for your area. If the VCR has not previously been tuned-in, instructions will be given on screen to guide you through this procedure.

1. Ensure your VCR is still in the STANDBY mode.



2. Switch on the **TV**.

3. Select the next available or unused channel on your TV, this will become the dedicated video channel.

Example of  
TV channels

1 = BBC1	4 = Channel 4
2 = BBC2	5 = Channel 5
3 = ITV	? = VCR

4. Press the **STOP**  button. The VCR will search and display an ideal RF channel. Wait for the flashing channel number to appear on the VCR display, this number will be between 21 and 69.



- *If you are connected via a scart lead, go to step 6.*

#### CAUTION:

If the clear button is pressed at this point it will not allow the TV to be tuned to the VCR. Refer to RF through ON/OFF on page 37.

5. Tune the selected channel on your TV. (Refer to your TV manual for instructions on how to tune in your TV).

Store this as your VCR channel.

#### TV SCREEN

AUTO INSTALLATION

PRESS SET KEY TO START.

SET : ENTER MENU : EXIT

Blue  
background  
with  
White Text

#### NOTE:

If the AUTO INSTALLATION screen doesn't appear when you switch on your VCR or you wish to reset your VCR and start the installation again, refer to **VCR RESET** at the back of the book.

See next page to continue 

[www.sharp.co.uk/support](http://www.sharp.co.uk/support)

## INSTALLING YOUR VCR

### AUTO TUNING CONTINUED

6. Press the **SET**  button to store the RF channel setting and continue with the installation.

7. Ensure your Aerial/Scart cables are connected to your VCR and then press the **SET**  button to confirm.

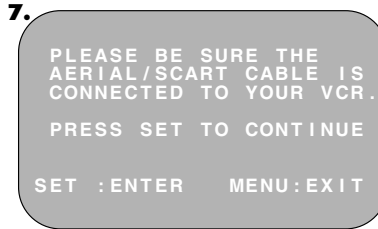

Auto install will now search for and tune in all available channels.

(This may take a few minutes.)

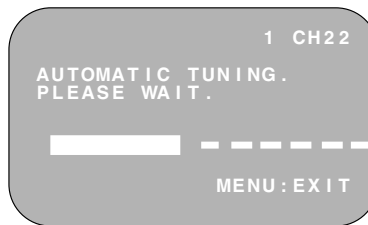

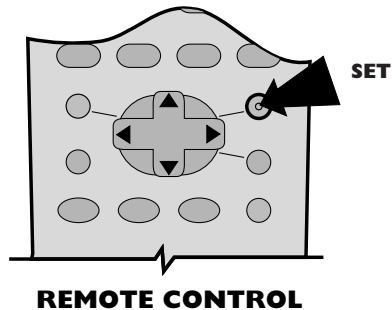

Button positions for your reference.



See next page to continue 

## INSTALLING YOUR VCR

On completion the **MOVE MENU** will appear showing all the channels the VCR was able to tune in. By pressing **MODE OSD** button, the VCR will change to a blue background. This may help you see which channel your VCR has tuned in. Using the (▲/▼/◀/▶) menu select buttons scroll through the channels to find BBC1. Some channels may be duplicated but with more interference than others. Search for the best quality picture and using the procedure below, move this channel to Preset 1. Repeat this procedure for BBC2 - Preset 2, ITV - Preset 3, etc.

1. Press (▲/▼/◀/▶) to highlight the channel to be moved.
2. Press the **SET**  button to confirm.
3. Press (▲/▼/◀/▶) to highlight the new position for the channel.
4. Press the **SET**  button to confirm.
5. If any more channels are to be moved, repeat procedure from step 3.
6. Press the **MENU**  button to exit if you are happy with the channel order.

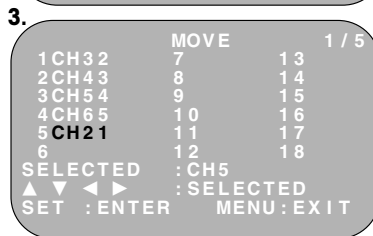
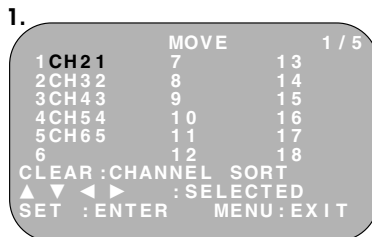

### All the programmes should now be correctly tuned!

If you wish to, delete or change the channel order at a later date please refer to **MANUALLY SORTING CHANNELS** towards the back of this book.

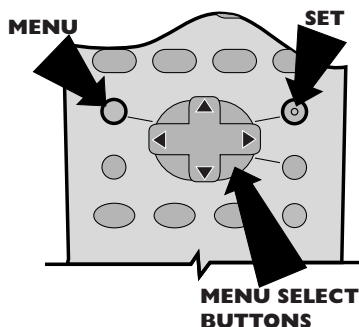

See next page to continue 

## INSTALLING YOUR VCR

The clock setting screen will now appear.  
To set the time and date follow the steps below:

1. Press the (▲/▼) menu select buttons to select either 12 or 24 hour clock operation.
2. Press (◀/▶) to select TIME. Enter the time using the **NUMBER BUTTONS** or the (▲/▼) buttons. If the minutes or hours are less than 10, enter the leading 0. If using the 12 hour clock enter AM or PM by pressing the  **AM/PM** button on the remote control.
3. Press (◀/▶) to select DATE. Enter the date using the **NUMBER BUTTONS** or the (▲/▼) buttons. For example, for 1st April enter **01 04**.
4. Press (◀/▶) to select YEAR. Enter the last two digits of the year using the **NUMBER BUTTONS** or the (▲/▼) buttons. For example, for 2002 enter **02**. For the year 2003 enter **03**.
5. Press the **SET** button to store the time and date.

### NOTE:

- You will need to update the clock for Winter/Summer daylight saving.

✓ *All the programmes should now be correctly tuned in and the clock set.*

### 24 hour example:



### 12 hour example:

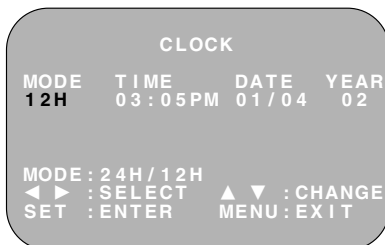

## BASIC OPERATION

### SCART LEAD CONNECTION (NOT SUPPLIED)

A scart lead can be connected at any time. It is recommended to connect your TV and VCR in this way as it will provide improved picture and sound quality. Please refer to the connection diagram on page 4.

## IMPORTANT NOTES ON YOUR VCR AND VIDEO TAPES

### VIDEO TAPES

- If you use only good quality video tapes, generally it will not be necessary to clean the video heads.
- If poor quality tapes are used, or if a tape is loaded after changing VCR location, oxide from the tape may "clog" the video heads. This will cause the playback picture to be "snowy", or even disappear.
- To remove minor contamination run a video tape in visual search mode. If this fails, you will need to have the heads cleaned by a SHARP Service Facility. Please note, if cleaning is necessary it is not covered by the guarantee.
- Use video tapes which carry the  mark.

## HOW TO PLAYBACK A VIDEO TAPE



### BEFORE YOU PLAYBACK A VIDEO TAPE

Condensation forms in the VCR when it is moved out of or into a warm place. If you try to playback or record, the video tape and VCR may be damaged. Turn the VCR on and wait for about two hours until the VCR reaches room temperature before operating.

### PLAYBACK

1. Switch on your TV and select the video channel.
2. Carefully push a pre-recorded video tape into the tape compartment. This will switch the VCR on.

- If the record-protection tab has been removed, the VCR will start playback as soon as the video tape has been loaded.

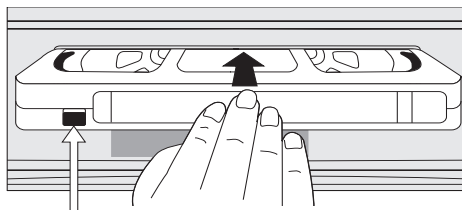





3. Press the **PLAY/X2**  button to start playback.



See next page to continue 

## BASIC OPERATION

# HOW TO PLAYBACK A VIDEO TAPE

- For double speed playback (without sound), press the **PLAY/X2**  button again.
- To revert to normal playback, press the **PLAY/X2**  button again.
- To stop the video tape, press **STOP** .
- To eject the tape press  **EJECT** on the VCR.





## SHARP SUPER PICTURE

**SHARP SUPER PICTURE** should enhance the picture quality during playback. It is normally set to ON. To turn **SHARP SUPER PICTURE** on or off press **SUPER P.**  on the VCR front panel. 











## PICTURE DISTURBANCE DURING PLAYBACK

This VCR has an automatic tracking system which reduces picture disturbance when you start to playback a video tape. When auto-tracking is in operation  flashes on the on-screen display. If the picture still has disturbance you may need to manually track the video tape:

During PLAYBACK of a video tape.

- Press **CHANNEL**  or  to position picture interference off the TV screen. (Manual Tracking)
- Press **CHANNEL**  and  buttons together to start Auto Tracking.

## PAUSING AND SLOW MOTION

1. Press the **PLAY/X2**  button to start the video tape playing.
2. To pause the video tape, press **PAUSE/STILL** .
  - To minimise jitter whilst in pause mode press **CHANNEL**  or .
  - Press the **PLAY/X2**  button to resume playback.
3. To playback in slow motion (without sound) press the **SLOW**  button on the remote control. Slow motion speed can be adjusted using the  or  buttons next to the slow button. Picture disturbance can be improved by using the **CHANNEL**  or .
- Press the **PLAY/X2**  button to resume playback.

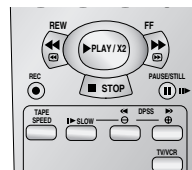

**REMOTE CONTROL**

## NOTES:

- When using SLOW MOTION function some mechanical noise may be heard.
- There will be picture interference and possibly a change to black and white picture using Pause and Slow functions.
- PAUSE mode will disengage after about 5 minutes.







## BASIC OPERATION

# HOW TO PLAYBACK A VIDEO TAPE

## FAST FORWARDING/REWINDING A VIDEO TAPE

1. Press **STOP**  to stop the video tape.
2. Press the **FAST FORWARD**  / **REWIND**  buttons on the remote control **or** on the VCR front panel.
3. To stop fast forward/rewind, press **STOP** .

## FORWARD/REVERSE VISUAL SEARCH

1. During playback to select search mode, press the **FAST FORWARD**  **or** **REWIND**  buttons on the remote control, **or** on the VCR front panel.
2. Press the **PLAY/X2**  button to resume playback.  
OR
3. To decrease the speed, during visual search mode press **FAST FORWARD**  **or** **REWIND**  again.
4. Press the **PLAY/X2**  button.



### NOTE:

- There will be picture interference and possibly a change to black and white picture using Visual Fast Forward/Rewind functions.

## IMMEDIATE RECORDING

### SELECTION OF A CHANNEL

Select the channel you wish to record by using the **NUMBER BUTTONS** on the VCR remote control, or select the next/previous channel by pressing the **CHANNEL**  buttons on the remote control or on the VCR front panel.

To change between single digit and 2-digit channel numbers, press the **AM/PM**  button.

For example, for channel 24, press the **AM/PM**  button then press **2 4**.

## BASIC OPERATION

# IMMEDIATE RECORDING CONTINUED

### TAPE SPEED SELECTION

Your VCR has three tape speeds: SP (Standard Play) , LP (Long Play) and EP (Extended Play).

Press the **TAPE SPEED**  button on the remote control to select the desired setting.

Cassette Length E-240	Recording Time In Minutes
SP	240
LP	480
EP	720

It is recommended that EP recordings are only played back on the VCR on which they were originally recorded.

You can record the channel you are watching or a different channel.

1. Insert a video tape into your VCR.
2. Select the channel you wish to record on the VCR as above.

3. To start recording, press **REC** .

4. To pause during recording, press **PAUSE/STILL** .

5. To continue recording, press **REC** .

6. To stop recording, press **STOP**  once.



REMOTE CONTROL

### SIMPLE TIMED RECORDING:

1. Press **REC** .

2. To specify a stop time, each additional press of **REC**  will delay the stop time by 10 minutes.

3. To stop recording at any time, press **STOP**  once.

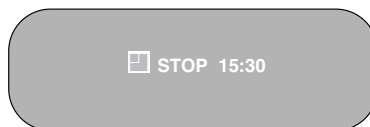

### NOTES:



- If the tape ends before the recording is complete the VCR will stop recording, rewind, eject the tape and place the VCR into STANDBY mode, or just eject the tape and place the VCR in STANDBY timer mode if the VCR is in timer record mode.
- If the VCR ejects the video tape when you press **REC**  the tape is record protected. i.e. record protection tab has been removed.



## BASIC OPERATION

# HOW TO USE THE VIDEO Plus+® SYSTEM TO MAKE A RECORDING (VC-MH715HM ONLY)

### Before you start!

- If the Timer Standby symbol  appears on the VCR display, press the **TIMER ON/OFF**  button to remove the  symbol.
- Check that the VCR clock is displaying the correct time.









The VIDEO Plus+ system allows you to program the VCR to record up to eight programmes using the PlusCode numbers published in TV listings (refer to your daily newspaper or TV magazine).

1. Press the **VIDEO Plus+**  button on the remote control.
2. Enter the PlusCode number from the TV listing using the **NUMBER BUTTONS**.



### NOTE:

- An ERROR message will appear if you have entered a number that is not a current PlusCode number. If this happens press **CLEAR**  to delete the numbers as required and enter the correct PlusCode number.

3. Press the (/ ) menu select buttons to select ONCE, WEEKLY, DAILY.
  - If you want to make additional recordings at the same time each day or week, then use (/ ) to select the WEEKLY, or DAILY option as appropriate.
4. Press the **SET**  button to confirm.

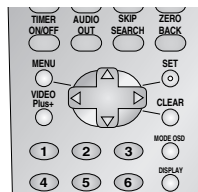

**MENU SELECT BUTTONS**

**REMOTE CONTROL**

### NOTE:

- Check that the menu list agrees with the times shown in the TV listing. If it does not press **CLEAR**  to return to the VIDEO Plus+ system menu, and re-enter the correct PlusCode number.

The first time that you use the VIDEO Plus+ system to make a recording on each channel Preset, (PR) may be highlighted on the On-Screen Display.

5. Enter the channel number you wish to record using the **NUMBER BUTTONS**, for example if you wish to record channel 2 press **0 2**. The VCR will remember this for the future.

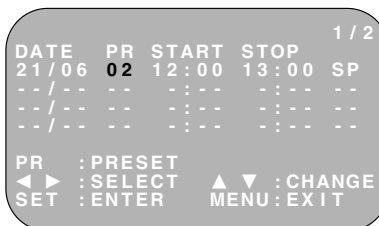

**See next page to continue** 

[www.sharp.co.uk/support](http://www.sharp.co.uk/support)



## BASIC OPERATION

# HOW TO USE THE VIDEO Plus+<sup>®</sup> SYSTEM TO MAKE A RECORDING (VC-MH715HM ONLY)

6. If you wish to change the **RECORDING SPEED**, use the (◀/▶) to highlight SP. Press (▲/▼) to select either standard play (SP), long play (LP) or extended play (EP) as required.

7. Press the **SET**  button to confirm the programme. The VIDEO Plus+ system menu will reappear. If you wish to enter further VIDEO Plus+ system recordings repeat this procedure.

8. When you have completed entering the timer settings, press the **MENU**  button to remove the menu from the TV screen.

9. Ensure that the tape on which you wish to record is inserted into the VCR, then press the **TIMER ON/OFF**  button once to place the VCR in TIMER STANDBY mode.  will be shown on the display.

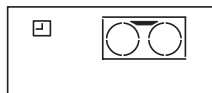
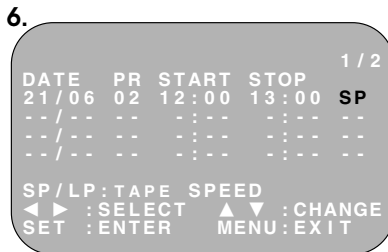



## NOTES:

- You may also access the VIDEO Plus+ system menu by the following procedure:

i. Press the **MENU**  button.

ii. The VIDEO Plus+ system option will be highlighted. Press the **SET**  button to confirm.

Continue from step 2 of this procedure.

- If the  symbol flashes a video tape has not been inserted into the VCR.
- If the video tape is ejected when the VCR tries to record the record protection tab has been removed.
- During recording, press **STOP**  to cancel the recording. If there are further recordings to be made, the VCR will return to Timer Standby.

## BASIC OPERATION

# HOW TO SET A DELAYED RECORDING



You can make a maximum of eight delayed recordings up to a year in advance.

The example shown is for 24-hour clock operation. To change to 12-hour clock operation refer to the **MANUALLY SETTING THE CLOCK** section of this manual.

12-hour clock am/pm can be selected using the **AM/PM**  button on the remote control.

### Before you start!





- If the Timer Standby symbol  appears on the VCR display, press the **TIMER ON/OFF**  button to remove the  symbol.
- Check that the VCR clock is displaying the correct time.

### SETTING A RECORDING



For example: Recording a programme on channel 3 from 21:05 to 22:30 on July 9th.



1. Press **STOP**  to ensure that the VCR is switched on.

2. Press the **MENU**  button.

3. Press the () menu select buttons to select **TIMER**. Press the **SET**  button to confirm.

4. Press the **SET**  button again, the on-screen display will now show today's date.

If you wish to change the date use the () or **NUMBER BUTTONS**. If you use the number buttons, enter two digits for the day, then two for the month. For example for July 9th, press **0 9** (9th), then **0 7** (July). When the correct date for your recording is shown, press the  menu select button to move to the next setting.

5. If you want to make additional recordings at the same time each day or week, use the () buttons to select D (daily) or W (weekly). Then press  to move to the next setting.

6. Enter the channel number using the () or the **NUMBER BUTTONS**. For example to record a programme on channel 3, press 0 3. Then press  to move to the next setting.

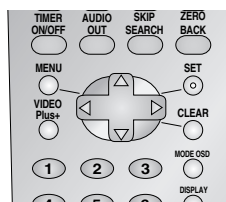

**MENU  
SELECT  
BUTTONS**

**REMOTE CONTROL**

### 3. MENU SCREEN

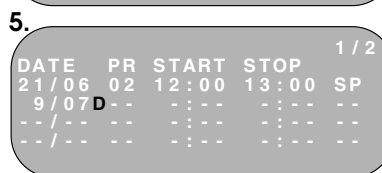
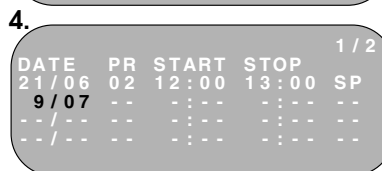

**See next page to continue** 

[www.sharp.co.uk/support](http://www.sharp.co.uk/support)

## BASIC OPERATION

# HOW TO SET A DELAYED RECORDING

- Enter the start time using the (/ ) or **NUMBER BUTTONS**, hours first then minutes (when entering less than 10 hours or minutes add a '0' before the number), for example for 21:05 start, press **2 1 0 5**. Then press to move to the next setting.
- Enter the stop time, for example for 22:30 stop, press **2 2 3 0**.
- If you wish to change the **RECORDING SPEED**, use the (/ ) to highlight SP. Press (/ ) to select either standard play (SP), long play (LP) or extended play (EP) as required.
- Press the **SET** button to confirm.
  - The MENU now shows all the timer settings you have entered. If you wish to make additional timer recordings, repeat this procedure.
- When you have completed entering timer settings, press the **MENU** button to remove the menu from the TV screen.
- Ensure that the tape on which you wish to record is inserted into the VCR, then press the **TIMER ON/OFF** button once to place the VCR in TIMER STANDBY mode. will be shown on the display.

7.

DATE	PR	START	STOP	1 / 2
21 / 06	02	12 : 00	13 : 00	SP
9 / 07	D03	21 : 05	- : -	SP
- / -	-	- : -	- : -	-
- / -	-	- : -	- : -	-

9.

DATE	PR	START	STOP	1 / 2
21 / 06	02	12 : 00	13 : 00	SP
9 / 07	D03	21 : 05	22 : 30	LP
- / -	-	- : -	- : -	-
- / -	-	- : -	- : -	-





## NOTES:

- If the symbol flashes a video tape has not been inserted into the VCR.
- If the video tape is ejected when the VCR tries to record the record protection tab has been removed.
- During recording, press **STOP** to cancel the recording. If there are further recordings to be made, the VCR will return to Timer Standby.

## BASIC OPERATION





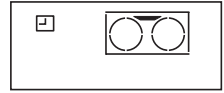

# HOW TO CHECK, CHANGE AND CANCEL A DELAYED RECORDING

### Before you start!

- If the Timer Standby symbol  appears on the VCR display, press the **TIMER ON/OFF**  button to remove the  symbol.











### CHECKING A RECORDING

1. Press **STOP**  to switch on the VCR.
2. Press the **MENU**  button.
3. Press /) to select **TIMER**. Press the **SET**  button to confirm.
  - All the delayed recordings in the VCR's memory will be shown.
4. If the settings are correct press the **MENU**  button to exit.
  - If you wish to change or cancel any settings, follow the procedures below.

### MENU SCREEN



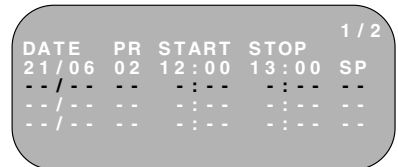

### CHANGING A RECORDING

1. Follow steps 1 to 3 of **CHECKING A RECORDING** above.
2. To change a delayed recording, press /) to highlight the recording, then press the **SET**  button to select.
3. Press /) to highlight the setting to be changed and correct it by using the /) or the **NUMBER BUTTONS**.
4. When all corrections are complete press the **SET**  button to confirm, then press the **MENU**  button to exit.



### CANCELLING A RECORDING

1. Follow steps 1 to 3 of **CHECKING A RECORDING** above.
2. To cancel a delayed recording, press /) to highlight the recording to be cancelled, then press **CLEAR**.
3. Press the **MENU**  button to exit.

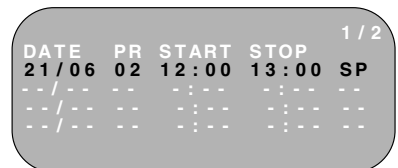



### NOTE:





- If there are some programmes to be recorded, do not forget to press **TIMER ON/OFF**  button to return the VCR to Timer Standby mode.

## ADVANCED OPERATION

# AUDIO AND YOUR VCR









### HI-FI STEREO SOUND

Stereo sound is possible from this VCR if you have a **stereo TV connected to the VCR with a scart lead**, or audio equipment connected with audio phono leads. The VCR is normally set so that stereo sound is possible. The sound output from the VCR is controlled by the **AUDIO OUT**  button on the remote control. If you wish to change the sound output you can use the **AUDIO OUT**  button as follows:

- Press the **AUDIO OUT**  button once. The LEFT audio channel will be sent to BOTH speakers. **L** will appear on the VCR display.
- Press the **AUDIO OUT**  button again. The RIGHT audio channel will be sent to BOTH speakers. **R** will appear on the VCR display.
- Press the **AUDIO OUT**  button a third time and the MONO track will be sent to BOTH speakers. **L** and **R** will not appear on the VCR display.
- Pressing the **AUDIO OUT**  button a fourth time, normal Hi-Fi stereo sound will be heard. **L** and **R** will appear on the VCR display.



### NICAM Hi-Fi STEREO SOUND

Your VCR can receive and record NICAM sound. The VCR is normally set so that NICAM sound is possible if it is present on the receiving signal, otherwise the VCR will automatically switch to receive the mono signal. NICAM sound can be turned off. If you wish to do this follow the procedure below:

1. Press the **MENU**  button to display the main menu on the screen.
2. Press the (/) menu select buttons to select MODE then press the **SET**  button to confirm.
- The MODE menu will be displayed with NICAM selected.
3. Press (/) to select OFF.
4. Press the **SET**  button to confirm and return to the main menu screen.
5. Press the **MENU**  button to exit to normal screen.



### NOTES:

- If the tape being played back does not carry sound recorded on Hi-Fi tracks, L and R will not appear on the display.
- If the sound contains 'crackling' or 'popping' noises the sound quality may be improved by adjusting the tracking using the **VCR CHANNEL**  /  buttons.
- If the poor quality is for a long period the VCR will automatically select the mono track and the sound will be in mono.
- NICAM sound may not be stereo.

## ADVANCED OPERATION

# AUDIO AND YOUR VCR

## CONNECTING TO AUDIO EQUIPMENT

The diagram below shows how to connect your VCR to audio equipment. When connected in this way stereo sound is possible from the speakers.

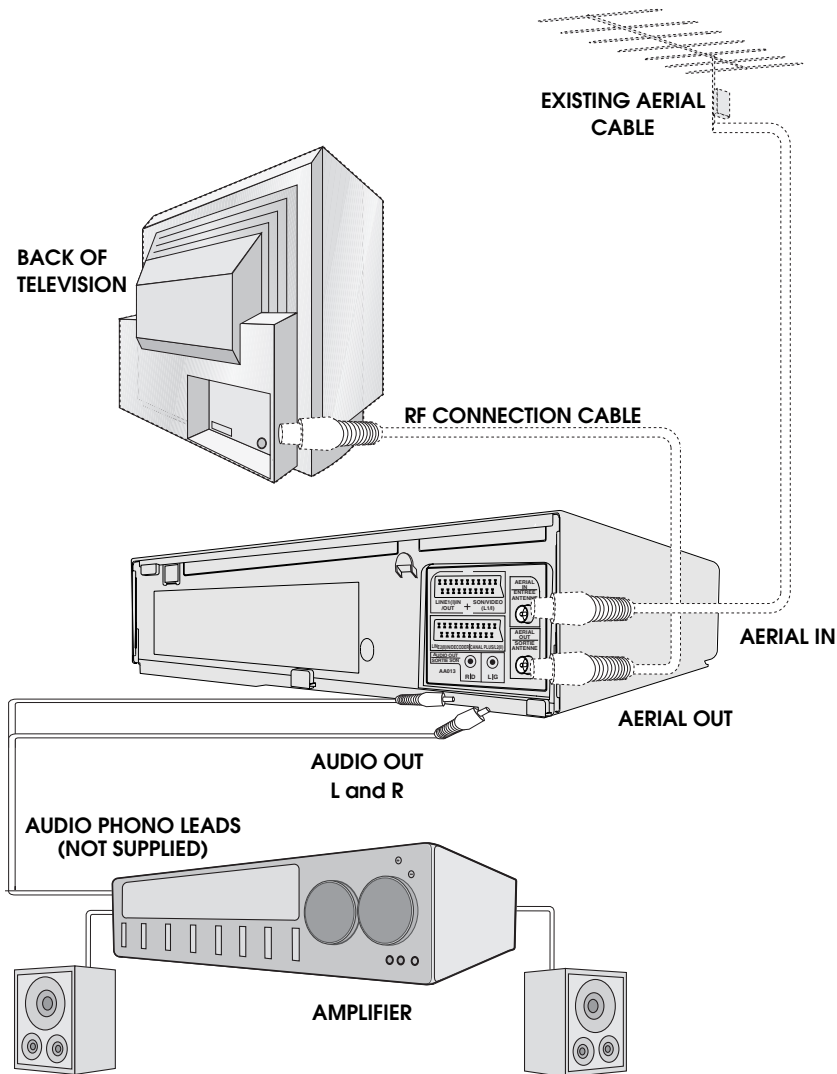

## ADVANCED OPERATION

# PLAYBACK OF A VIDEO TAPE

## CHECKING THE AMOUNT OF TAPE REMAINING

When you load a video tape into the VCR it can calculate approximately the amount of video tape remaining in hours and minutes. This is useful in determining whether or not there is sufficient tape left to make a recording.

When a video tape is playing, the amount of tape remaining is calculated for you automatically.

To display the amount of video tape remaining:

1. Load the video tape into the VCR
2. Press **DISPLAY** on the remote control as many times as necessary until "R" appears on the VCR display. The tape will wind forward and then return to its original position. The tape remaining will be shown on the VCR display in hours and minutes.

By pressing the **TAPE SPEED** button on the remote control the remaining time will change between extended play, long play and standard play.

For example,  
in standard play 1 hour 23 minutes is left on the tape:



in long play 2 hours 46 minutes is left on the tape:



in extended play 4 hours 9 minutes is left on the tape:













### NOTES:

- If tape remaining function is interrupted, the remaining time will not be displayed.
- If less than 5 minutes of tape remains the display will flash.

## PLAYING BACK A VIDEO TAPE REPEATEDLY

You can set your VCR to automatically rewind at the end of playing a video tape and replay the entire tape again. REPEAT will appear on the on-screen display when selected.

To use this feature:

1. Press **MENU**  to display the main menu on the screen.
2. Press the ( / ) menu select buttons to select MODE.
3. Press **SET** .
4. Press ( / ) to select REPEAT.
5. Press ( / ) to select ON.
6. Press **SET** .
7. Press **MENU**  to return to normal screen.

### MODE MENU SCREEN

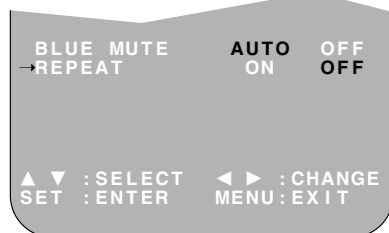



# **PLAYBACK OF A VIDEO TAPE**

## **PLAYING BACK AN NTSC TAPE**

NTSC (National Television Standards Committee) is a different TV standard to PAL and is used in some Non-European Countries. Your VCR can playback pre-recorded NTSC tapes onto a PAL system TV, but cannot record an NTSC signal onto a video tape.

### **Note that..**

- You cannot record NTSC signals or dub NTSC tapes onto other VCR's from this VCR.
- You cannot use Slow speed, Still frame, Double Speed, Frame Advance or Tape Remaining with a pre-recorded NTSC tape.
- On some televisions, the picture may appear in black and white or there may be no picture. This does not indicate a fault with your VCR.
- On some televisions, the picture may shrink vertically causing black bands to appear at the top and bottom of your screen.
- On some televisions, the played-back picture may roll vertically, this does not indicate a fault with your VCR.

## ADVANCED OPERATION

### LCD DISPLAY

#### TIME OF DAY

Shows current time of day, if the clock is set.

Press the **DISPLAY** <sup>DISPLAY</sup> button until the time of day appears. For example, 21:20 appears:



#### CHANNEL STATUS

Shows the current VCR channel preset. Press the **DISPLAY** <sup>DISPLAY</sup> button until the channel number appears, for example PRESET 1:



### TAPE COUNTER AND ZERO BACK

Tape counter measures the current position of the video tape in real time. ZERO BACK uses the tape counter to determine a specific point on a tape you may wish to return to.

1. Press the **DISPLAY** <sup>DISPLAY</sup> button until tape counter appears, for example:
2. To identify the current position on a video tape press the **CLEAR** <sup>CLEAR</sup> button and the tape counter will appear:



When you wish to return to this position on the video tape, press **ZERO BACK** <sup>ZERO BACK</sup> button. The tape will rewind/advance to this point.

#### NOTE:

- The tape counter will only operate on recorded sections of tape.

#### TAPE REMAINING

Shows the amount of video tape remaining, as previously explained in **CHECKING THE AMOUNT OF TAPE REMAINING**.











#### DISPLAY BRIGHTNESS

The LCD display brightness can be changed to suit the ambient lighting in the room. Switch on the VCR (ensure the menu screen is not on) then press and hold the **DISPLAY** <sup>DISPLAY</sup> button for approximately 2 seconds. This will reduce the brightness of the VCR display. Repeat the process to change the display back to the previous setting.

## ADVANCED OPERATION

### BLUE MUTE

The TV screen will be blue if a TV channel with no signal is selected, an unrecorded section of tape is played or the quality of the recording on the tape is poor. Select OFF in the mode menu to disable this feature.

1. Press the **MENU**  button to display the main menu on the screen.
2. Press the (/) menu select buttons to select MODE.
3. Press the **SET**  button.
4. Press the (/) menu select buttons to select BLUE MUTE.
5. Press (/) menu select buttons to select AUTO or OFF.
6. Press **SET**  to confirm and then **MENU**  to return to the normal screen



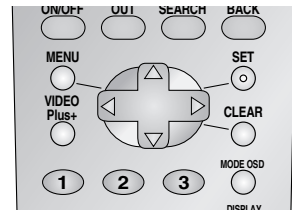
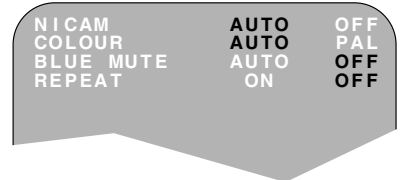



### MODE MENU SCREEN



### REMOTE CONTROL

### COLOUR

If the VCR is playing poor quality recording, the picture may turn black and white. Selecting PAL may improve this (depending on the recording), although coloured speckles may appear on black and white recordings.



1. Follow steps 1 to 3 from BLUE MUTE above.
2. Press the (/) menu select buttons to select COLOUR.
3. Press (/) menu select buttons to select AUTO or PAL.
4. Press **SET**  to confirm and then **MENU**  to return to the normal screen.

## ADVANCED OPERATION

# SEARCHING THE VIDEO TAPE

### SKIP SEARCHING THE VIDEO TAPE

You can search the tape in 30 second time intervals. To do this follow the procedure below:

1. Press **PLAY/X2**  to start the video tape playing.  
1 press = 30 seconds.  
2 presses = 1 minute.  
3 presses = 1 minute 30 seconds.  
4 presses = 2 minutes.
2. Press the **SKIP SEARCH**  button on the remote control.

The number of times you press **SKIP SEARCH**  determines the forward search time.



- After searching, normal playback will resume automatically

### DIGITAL PROGRAMME SEARCH SYSTEM (DPSS)

Your VCR records a marker signal on the tape at the start of each recording. These signals can be used later to locate the starting point of a recording.

Press **DPSS**  /  to locate a previous programme or the next programme.

For example,

1. Load the video tape into the VCR.
2. Press **DPSS**  three times. **DPSS 3** will appear on the on-screen display, and the VCR will fast forward to locate the third recording after the current one.
3. Press **DPSS**  once. **DPSS -1** will appear on the on-screen display and the VCR will rewind to locate the beginning of the current recording.

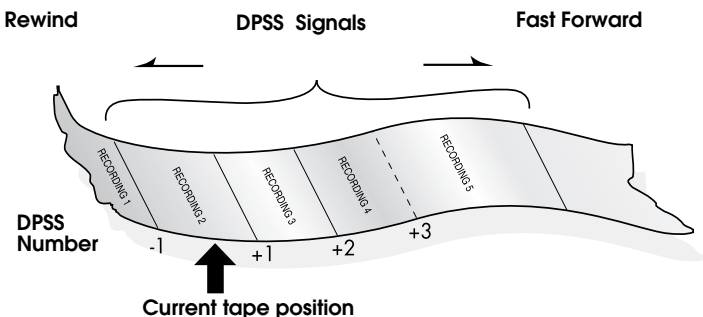

4. To cancel the search before it has finished, press **STOP**  or **PLAY/X2** .

### NOTES:

- Recordings must be longer than 3 minutes.
- The starting point of playback may vary.
- This feature will only work with video tapes recorded on a VCR with the DPSS feature.

## ADVANCED OPERATION

# RECORDING FROM OTHER EQUIPMENT

You can record video and audio signals from various external sources, such as a camcorder, onto a video tape using your VCR.

For example, recording from a camcorder connected to LINE 2 IN/DECODER on your VCR:

### Optional Scart connection (not supplied)

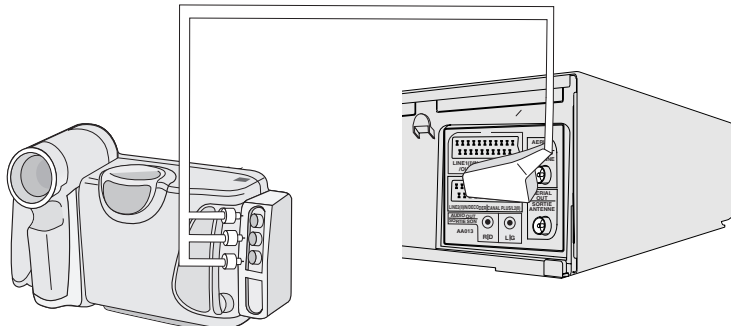

#### Mono/Stereo Camcorder

1. Connect your signal source (eg. Camcorder, Digital Camera etc) to the desired scart socket on the back of the VCR using the manufacturers recommended cable (not supplied).

2. Ensure that the tape on which you wish to record is inserted into the VCR.

3. Press **INPUT SELECT**  on the remote control until the VCR display shows **L2**.

4. Press **REC**  to start recording.

#### Input Select



#### OTHER CONNECTIONS POSSIBLE!

- If you wish to record from a source connected to LINE 1 IN/OUT, select **L1**.

Press **REC**  to start recording.

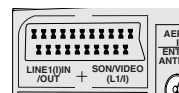

- If you wish to record from a source connected with audio phono leads to the sockets on the front of the VCR (if fitted), select **L3**.

Press **REC**  to start recording.

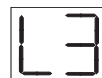

#### NOTE:

- There are many different ways of connecting external equipment to your VCR. Please refer to your equipment operation manuals for further information.



## **OTHER FEATURES ON YOUR VCR**

---

### **CHILD LOCK**

You can lock your VCR with this feature. It will work even when the VCR is in STANDBY, preventing children from operating the VCR.

#### **TO ENGAGE CHILD LOCK**

Press and hold the **CHILD LOCK**  button on the remote control for about 2 seconds.  flashes and then  remains lit on the VCR display confirming that CHILD LOCK has been activated.

Regardless of what other operating buttons are touched, the VCR will continue to operate in its present mode. If CHILD LOCK is activated during playback, once the tape reaches its end, the VCR will automatically rewind the tape, eject it, and turn the power off.

#### **TO DISENGAGE CHILD LOCK**

Press and hold the **CHILD LOCK**  button for about 2 seconds.  starts flashing and then disappears. CHILD LOCK is disengaged.

#### **NOTES:**

- If you attempt to change modes by pressing another button while CHILD LOCK is on, the  indicator will flash on the VCR display.
- If power is interrupted for more than 60 seconds (due to power failure etc), CHILD LOCK may disengage.

## **OTHER FEATURES ON YOUR VCR**



---

### **DECODER SWITCHING OPERATION**

If you have a separate decoder connected to the VCR's L2 input as previously shown in the "Connecting the Cables" section, you will need to set the decoder function to **ON** in order to record the descrambled signal and/or watch it on your TV. Now, when the VCR receives a scrambled signal it is output via LINE 2 terminal to the decoder. The decoder then outputs the descrambled signal back to LINE 2 terminal and the signal can be recorded. The VCR outputs the descrambled signal to your TV through the LINE1 terminal and you can watch the descrambled picture.

When making recordings using a separate decoder connected as shown remember to leave the decoder function ON.

If you connect a decoder unit to the VCR, the decoder unit provides a switching signal which will automatically allow your TV to display the descrambled signal routed through the VCR. To use this feature make sure that the VCR is connected to both TV and decoder unit by SCART leads. Then:







- Press **STANDBY**  to place the VCR in STAND-BY mode. OR
- Press **TV/VCR**  on the remote control to place the VCR in 'VCR mode'. 'VCR' will appear on the display.

## CUSTOMISED INSTALLATION

# MANUALLY TUNING A CHANNEL

- It should not be necessary to tune in a broadcast channel manually except in unusual circumstances such as poor signal.

To manually tune in a channel follow the procedure below.









- Press **MENU** .
- Press the ( / ) menu select buttons to select SET UP. Press **SET**  to confirm.
- CHANNEL PRESET** will be highlighted. Press **SET** .
- Press ( / ) to select **CHANNEL**.

CHANNEL PRESET  
CHANNEL SORT  
CLOCK













- VC-MH705LM only**  
**IMPORTANT NOTE:**

Press  to select CH or CC. This will determine whether off air (CH) or cable (CC) is tuned first. Note that both off air and cable will be tuned regardless of the setting.

→ PRESET CHANNEL FINE TUNING DECODER SKIP  
1 CH 2 1  
ON OFF  
ON OFF

- Press ( / ) to start tuning in either direction. Tuning will stop when a channel is received. If it is not the desired channel, press ( / ) to continue tuning.
- Press ( / ) to select **FINE TUNING**. Press and hold ( / ) until the sharpest colour picture is obtained.

### IMPORTANT NOTE

- If you connect an independent decoder, you must press ( / ) to select DECODER, then select ( / ) to turn the decoder function ON.
- Press ( / ) to select **SKIP**.  
The SKIP function determines whether the channel can be selected when using the **CHANNEL**  /  instead of the **NUMBER BUTTONS**. Press ( / ) to select ON or OFF for this option.
- Press **SET**  to confirm.
- Press **MENU**  to leave this function.

### CABLE RECEPTION VC-MH705LM only





















Station Signals <b>VHF</b>	Real Channel Numbers
A	01
B	02
C	03
D	04
E	05
F	06
G	07
H	08
J	09



## CUSTOMISED INSTALLATION

# MANUALLY SORTING CHANNELS

### SORTING THE CHANNELS INTO YOUR PREFERRED ORDER

1. Press the **MENU**  button.
2. Press the (/) menu select buttons to select SET UP. Press the **SET**  button to confirm.
3. Press (/) to select CHANNEL SORT. Press the **SET**  button to confirm.
4. The MOVE position will be highlighted. Press the **SET**  button to confirm.
5. Press (///) to highlight the channel to be moved. Press the **SET**  button to confirm.
6. Press (///) to highlight the new position for the channel. Press the **SET**  button to confirm.
7. If any more channels are to be moved, repeat procedure from step 5.
8. When all the channels are in your preferred order, either press the **CLEAR**  button to return to the CHANNEL SORT menu or press the **MENU**  button to leave the MENU function.

### NOTES:

If when moving channels the picture becomes unclear and the on-screen display is unreadable, the **MODE OSD** button can be used to toggle between a blue background and the normal picture.

The blue background will be shown until either another channel is selected or the **MODE OSD** button is pressed again.

### 2. MENU SCREEN



VIDEOPLUS  
TIMER  
MODE  
SET UP

### 5.



	MOVE	1 / 5
1 CH43	7	13
2 CH54	8	14
3 CH65	9	15
4 CH21	10	16
5 CH50	11	17
6 CH32	12	18

### 6.





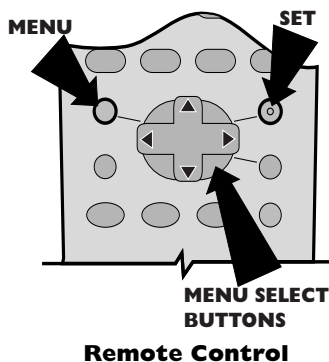













	MOVE	1 / 5
1 CH32	7	13
2 CH43	8	14
3 CH54	9	15
4 CH65	10	16
5 CH21	11	17
6 CH50	12	18



## MANUALLY SORTING CHANNELS

### DELETING CHANNELS

If there is a channel you wish to delete from the VCR memory, you can follow the procedure below.

1. Press the **MENU**  button.
2. Press the (/) menu select buttons to select SET UP. Press the **SET**  button to confirm.
3. Press (/) to select CHANNEL SORT. Press the **SET**  button to confirm.
4. Press (/) to select CANCEL. Press the **SET**  button to confirm.
5. Press (///) to highlight the channel to be cancelled.
6. Press the **SET**  button twice to cancel the channel.
7. When all the channels you wish have been cancelled, either press the **CLEAR**  button to return to the CHANNEL SORT menu or press the **MENU**  button to leave the MENU function.

### NOTES:

If when deleting channels the picture becomes unclear and the on-screen display is unreadable, the **MODE OSD** button can be used to toggle between a blue background and the normal picture.

The blue background will be shown until either another channel is selected or the **MODE OSD** button is pressed again.

### 2. MENU SCREEN



VIDEOPUS  
TIMER  
MODE  
SET UP

### 5.



	CANCEL	1 / 5
1 CH50	7	13
2 CH32	8	14
3 CH43	9	15
4 CH54	10	16
5 CH65	11	17
6 CH21	12	18

### 6.



	CANCEL	1 / 5
1 CH32	7	13
2 CH43	8	14
3 CH54	9	15
4 CH65	10	16
5 CH21	11	17
6	12	18

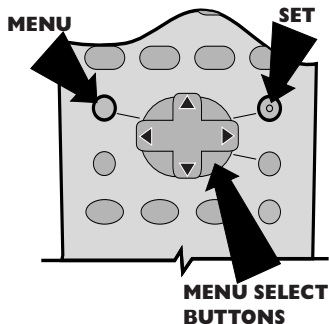























### Remote Control

# CUSTOMISED INSTALLATION

## MANUALLY SETTING THE CLOCK

This procedure will allow you to set the clock manually.

1. Press the **MENU**  button.
2. Press the (/) menu select buttons to select SET UP. Press the **SET**  button to confirm.
3. Press (/) to select CLOCK. Press the **SET**  button to confirm.
4. Press (/) to select either 12 or 24 hour clock.
5. Press (/) to select TIME. Enter the time using the **NUMBER BUTTONS** or the (/) buttons. If the minutes or hours are less than 10, enter the leading 0. If using the 12 hour clock enter AM or PM by pressing the **AM/PM**  button on the remote control.
6. Press (/) to select DATE. Enter the date using the **NUMBER BUTTONS** or the (/) buttons. For example, for 1st April enter **01 04**.
7. Press (/) to select YEAR. Enter the last two digits of the year using the **NUMBER BUTTONS** or (/). For example, for 2002 enter **02**. For the year 2003 enter **03**.
8. Press the **SET**  button to confirm.

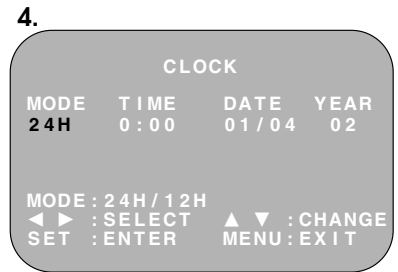
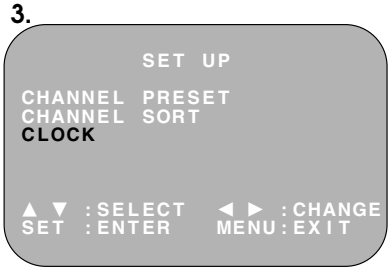

### Remote Control

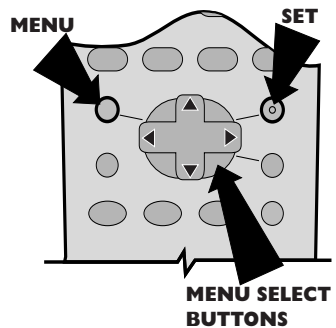

### NOTE:

- You will need to update the clock for Summer/Winter daylight saving.

## MORE INFORMATION ABOUT YOUR VCR

### VCR DISPLAY

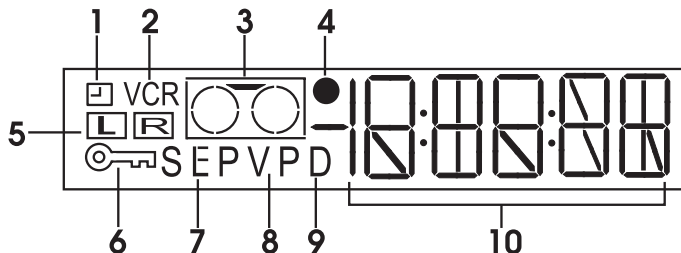

1. **TIMER RECORD** indicator.
2. **VCR MODE** indicator.
3. **TAPE MOTION STATUS** indicator
4. **RECORDING** indicator.
5. **AUDIO OUTPUT** indicator.
6. **CHILD LOCK** indicator.
7. **TAPE SPEED** indicator.
8. **VIDEO PROGRAMMING SYSTEM/PROGRAMME DELIVERY CONTROL** indicator.
9. **DECODER** indicator.
10. **CLOCK, TAPE COUNTER, TAPE STATUS AND CHANNEL PRESET STATUS**.

#### NOTE:

- Some models do not have all the features shown, therefore, they will not appear on the display.

### SELECTING THE OUTPUT FROM THE VCR

If your VCR is connected to your TV with a scart lead, when you start to play a video tape the VCR will automatically switch its output so that playback picture is shown on the TV.

In this case 'VCR' will appear on the VCR display.

You can manually override this by pressing **TV/VCR**  on the remote control. Now the TV broadcast channel will be seen on the TV screen and 'VCR' will disappear from the VCR display.

- Pressing **TV/VCR**  again will return the TV picture to the playback picture.

## MORE INFORMATION ABOUT YOUR VCR

### ON-SCREEN DISPLAY

All the information you need on the VCR status will be summarised on the on-screen display. If you are recording, playing back a tape or watching a broadcast on the video channel you can call up three standard on-screen displays. The display can be selected by pressing the **MODE OSD**  button on the remote control, 1,2,3 or 4 times.

1. **AUTO**, the current mode and channel number will be displayed for 3 seconds when an operation or number button is pressed.
2. **FULL**, all the active features will also be shown on screen.



2.

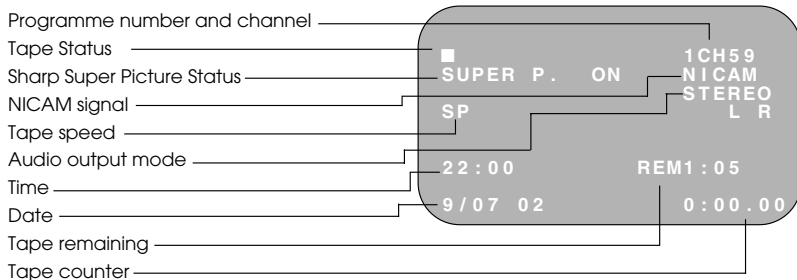

3. **COUNTER**, this display will show the tape counter and amount of tape remaining.
4. **DISPLAY OFF**, this will remove the display from the screen.

3.

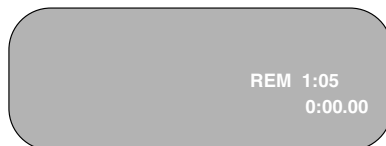

#### NOTES:

- The default time and date will not be displayed if the clock has not been set.
- The VCR will return to display 1. each time it is switched on.
- If you are recording from this VCR to another, make sure you remove the display from the screen otherwise it will be recorded.

## **MORE INFORMATION ABOUT YOUR VCR**

---

### **SPECIFICATIONS**

Format:	VHS PAL standard
Number of heads:	Six
Video signal system:	PAL colour or monochrome signal: 625 lines
Maximum playing time:	240 min. with E-240 video cassette in Standard Play (SP) mode 480 min. with E-240 video cassette in Long Play (LP) mode 720 min. with E-240 video cassette in Extended Play (EP) mode
Tape width:	12.7 mm
Tape speed:	23.39 mm/s Standard Play (SP) 11.70 mm/s Long Play (LP) 7.8mm/s Extended Play (EP)
Antenna:	75 $\Omega$ unbalanced
Reception channels:	UHF channel 21-69 (VHF Channels A-J VC-MH705LM only)
RF output signal:	UHF channel 21-69
Power requirement:	AC 230-240V, 50 Hz
Power consumption:	17 W approx. (Standby power consumption 2.5W)
Operating temperature:	5 °C to 40 °C
Storage temperature:	-20 °C to 55 °C
Video input:	1.0 Vp-p, 75 $\Omega$
Video output:	1.0 Vp-p, 75 $\Omega$
Audio input:	Line1&2: -3.8 dBs, 10 k $\Omega$ , Line3: -3.8 dBs, 47 k $\Omega$
Audio output:	Line1&2: -3.8 dBs, 1 k $\Omega$ , Audio out: -3.8 dBs, 1 k $\Omega$
Hi-Fi audio:	Dynamic range: ~90dBs typ. (SP); Frequency response: 20 Hz - 20 kHz; Wow and Flutter: <0.005% Wrm (JIS A)
Dimensions:	360(W) x 220(D) x 93(H) mm
Weight:	2.6 kg (approx.)
Supplied accessories:	75 $\Omega$ RF Connection cable, operation manual, remote control, AA/R6/UM3 battery (x2)

- Specifications are subject to change without notice as part of our policy of continuous improvement.
- No liability is accepted for any inaccuracies or omissions in this publication, although every possible care has been taken to make it complete and as accurate as possible.







## MORE INFORMATION ABOUT YOUR VCR

### TROUBLESHOOTING

#### BEFORE REQUESTING SERVICE!



The following conditions do not always denote trouble. Therefore, perform the checks described below before calling for service. If the problem cannot be corrected by the use of this guide, remove the mains plugs from the wall socket and contact the dealer or supplier from whom the unit was purchased in order to obtain service. Where this is not possible, please contact the telephone number listed below, you will then be given details of how to obtain service.

**Tel. 08705 274277 (office hours) or (01) 676 0648 if telephoning from Ireland - Please note: All calls will be charged at local rate.**

AREA	PROBLEM	POSSIBLE CAUSE/CURE
<b><u>INSTALLATION</u></b>	TV will not tune in to the VCR.	<ul style="list-style-type: none"> <li>Check all the cables are correctly connected.</li> <li>Check your TV manual for correct tuning of your TV.</li> </ul>
	Auto Installation screen does not appear when the VCR is switched on OR Auto Installation is not complete.	<ul style="list-style-type: none"> <li>Reset the VCR and complete AUTO INSTALLATION again. (Refer to VCR Reset at the back of the book.)</li> </ul>
<b><u>POWER</u></b>	Display is not working.	<ul style="list-style-type: none"> <li>Make sure the power cord is plugged in.</li> <li>Make sure the wall socket has power (check by plugging another appliance in).</li> </ul>
	VCR will not operate -  appears in VCR display.	<ul style="list-style-type: none"> <li>Press the <b>TIMER ON/OFF</b>  button to disengage timer.</li> </ul>
	VCR will not respond to any commands.	<ul style="list-style-type: none"> <li>Check the CHILD LOCK is not engaged.</li> <li>Safety device operating: unplug VCR for 2 hours.</li> </ul>
<b><u>PLAYBACK</u></b>	No picture appears.	<ul style="list-style-type: none"> <li>Make sure the TV is set to the video channel.</li> <li>Check all connecting cables.</li> </ul>
	Playback picture is snowy.	<ul style="list-style-type: none"> <li>Adjust the tracking using the <b>VCR CHANNEL</b>  /  buttons.</li> <li>Try another tape.</li> <li>The video heads may have been contaminated - refer to a SHARP Service Facility.</li> </ul>
<b><u>RECORDING</u></b>	Tape is automatically ejected when pressing the <b>REC</b>  or <b>TIMER ON/OFF</b>  buttons.	<ul style="list-style-type: none"> <li>The record-protection tab has been removed from the cassette.</li> </ul>

## MORE INFORMATION ABOUT YOUR VCR



### TROUBLESHOOTING

AREA	PROBLEM	POSSIBLE CAUSE/CURE
<b><u>RECORDING</u></b>	The VIDEO Plus+ system does not record desired programme. <b>(VC-MH715HM only)</b>	<ul style="list-style-type: none"> <li>Ensure date and time are correctly set on the VCR.</li> </ul>
<b><u>TAPE TRANSPORT/MECHANISM</u></b>	Tape can not be loaded.	<ul style="list-style-type: none"> <li>Make sure there is no other tape in the VCR.</li> <li>Make sure you are loading the tape correctly.</li> </ul>
	Rewind is not possible.	<ul style="list-style-type: none"> <li>Make sure the tape is not at the start.</li> </ul>
<b><u>REMOTE CONTROL</u></b>	The VCR can not be operated by remote control.	<ul style="list-style-type: none"> <li>Remote control is too far away from the main unit.</li> <li>Point the remote control at the VCR.</li> <li>Batteries are flat - replace both.</li> <li>Batteries have not been inserted correctly.</li> <li>VCR is positioned in strong light.</li> </ul>
<b><u>OTHER PROBLEMS</u></b>	Picture does not change even though the <b>VCR CHANNEL</b>  /  buttons are pressed.	<ul style="list-style-type: none"> <li>Make sure the VCR is not in Timer or Menu mode.</li> </ul>
	Desired channel position can not be selected.	<ul style="list-style-type: none"> <li>The channel position has been set to be skipped. Cancel the SKIP mode for that channel.</li> </ul>
	No colour or poor TV picture on normal viewing.	<ul style="list-style-type: none"> <li>Make sure all the cables are connected properly.</li> <li>Make sure the VCR power cord is properly plugged in.</li> </ul>
	Not possible to view picture or playback through AERIAL OUT.	<ul style="list-style-type: none"> <li>Make sure the RF OUTPUT has not been switched off. (Refer to page 37, RF CHANNEL TUNING and RF THROUGH ON/OFF)</li> </ul>
	Desired channel has interference.	<ul style="list-style-type: none"> <li>Possible weak signal strength, the same channel with a better signal strength may have been tuned in on another VCR preset channel. Example; VCR preset 1 = BBC1 and VCR preset 14 = BBC1 (Refer to Manually Sorting Channels section to move the channel to your desired position.)</li> <li>TV aerial may need adjusting.</li> </ul>
No picture appears.	<ul style="list-style-type: none"> <li>Make sure the TV is on the video channel.</li> <li>Check all connecting cables.</li> </ul>	



## MORE INFORMATION ABOUT YOUR VCR

### VCR RESET





1. Press the **STOP**  button on the front of the VCR.
2. Press and hold **MENU**  and **CHANNEL UP**  buttons together on the front of the VCR for 10 seconds.

✓ **VCR RESET IS NOW COMPLETE**

**Please continue with your previous procedure.**

### RF CHANNEL TUNING



If you have a preferred RF output channel this can be set manually between channels 21 and 69 by following the procedure below.

1. Press the **STANDBY**  button.
2. Press and hold the **MENU**  button for 3 seconds.
3. Wait for a flashing channel number to appear on the VCR display.
4. The channel number can now be changed by using the **MENU SELECT**  /  buttons.
5. Your TV will now require tuning to the new channel. (The screen opposite should be displayed on the TV)
6. Press the **SET**  button to store.

(Whitetext  
blue background)



### RF THROUGH ON/OFF:

If you wish to connect your VCR to the TV with only a scart lead, the RF Output on your VCR can be turned OFF and ON. To do this press the **CLEAR**  then **SET**  buttons on the remote control at point 3 from **RF CHANNEL TUNING** above. **or** at point 4 of **AUTO TUNING** on page 5. This will help minimise interference.

## **MORE INFORMATION ABOUT YOUR VCR**

---

### **GUARANTEE**

SHARP Electronics (UK) Ltd. (hereafter called Sharp) guarantee to provide for the repair, or at its option the replacement, of this product subject to the conditions listed below:

1. This guarantee shall only apply to faults which are due to inferior workmanship or materials. It does not cover faults or damage by accident, misuse, fair wear and tear, neglect, tampering with the product, or repair other than by a Service Facility appointed by SHARP.
2. As this product is intended for private domestic use only, the guarantee will not apply if the product is used in the course of a business, trade or profession.
3. To benefit from this guarantee, any fault which occurs must be notified to SHARP, or its appointed Service Facility within one year from the date this product was purchased. Proof of purchase must be provided.
4. The guarantee does not cover carriage costs, batteries or video tapes.
5. In the unlikely event of this product requiring repair, please contact the supplier from whom it was purchased. Where this is not possible, please contact the SHARP Helpline on the telephone number given below.
6. This guarantee is offered as an additional benefit to your statutory rights and does not affect these rights in any way.
7. No person has any authority to vary the terms or conditions of this guarantee.

If you have any difficulty operating this product, or would like information on other SHARP products, please telephone the SHARP Helpline on the number given below.

**SHARP Helpline: Tel: 08705-274277 (office hours)  
or (01) 676 0648 if telephoning from Ireland**

Please note that all calls are charged at local rate.

In the unlikely event of this equipment requiring repair during the guarantee period, you will need to provide proof of the date of purchase to the repairing company. Please keep your invoice or receipt which is supplied at the time of purchase.



## MORE INFORMATION ABOUT YOUR VCR

### CONNECTING TO THE MAINS



This VCR is suitable only for connection to UK mains. The unit is fitted with a moulded 3-pin mains plug with a 3-amp fuse. The VCR does not have a mains power switch. When connected to the mains, the unit will draw current at all times to power the clock. Be sure to unplug the VCR when it is not to be used for several months.

#### TO REPLACE THE FUSE:

You must use a 3-amp fuse, marked  (ASTA) or  (BSI) to BS-1362. Remove the fuse cover as shown. Replace the fuse and re-fit the fuse cover securely into the plug.

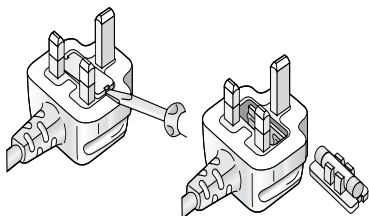

**Never connect the plug to the mains without the fuse cover fitted.**

#### TO REPLACE THE MAINS PLUG:

If the plug fitted is unsuitable for the mains socket in your home, cut off the plug, remove the fuse and dispose of the cut-off plug safely.



**Severe electric shock may occur if you connect the cut-off plug to a mains socket. If a new plug is fitted, observe the wiring code supplied by the plug manufacturer (and given below.) If you have any doubt, consult a qualified electrician.**

The wires in the mains cable are colour coded as follows: blue = neutral, brown = live. As the colours of the wires may not correspond with the terminals in your plug, connect the wires following plug manufacturer's guide:

- blue wire to the terminal marked N or coloured black or blue.
- brown wire to the terminal marked L or coloured red or brown.



- **Ensure neither the brown nor the blue wire is connected to the earth terminal in your plug.**
- **Do not allow water to come into contact with the power supply cord or plug.**
- **A damaged power supply cord or loose plug may cause electric shock.**
- **Contact your SHARP dealer or a qualified electrician. Do not use the VCR.**

[www.sharp.co.uk/support](http://www.sharp.co.uk/support)

## Free Manuals Download Website

<http://myh66.com>

<http://usermanuals.us>

<http://www.somanuals.com>

<http://www.4manuals.cc>

<http://www.manual-lib.com>

<http://www.404manual.com>

<http://www.luxmanual.com>

<http://aubethermostatmanual.com>

Golf course search by state

<http://golfingnear.com>

Email search by domain

<http://emailbydomain.com>

Auto manuals search

<http://auto.somanuals.com>

TV manuals search

<http://tv.somanuals.com>