



VA 300

Vocal Master

OPERATING AND SERVICE MANUAL

Manufactured by
SHURE BROTHERS INC.
222 Hartrey Avenue
Evanston, Illinois 60204 U. S. A.

Copyright 1978, Shure Brothers Inc.
AL404 (RE) 27A819

Printed in U. S. A.

VA300 SPECIFICATIONS

VA300-C Console

Amplifier Type	All silicon transistor mixer/power amplifier
Power Output	100 watts continuous (RMS); (to 8 ohm load, see Figure 3, Page 7)
Voltage Gain	60 db "Mic." Input Level (8 ohm load) 49 db "Inst." Input Level (8 ohm load)
Frequency Response	± 2 db 40 Hz. to 20,000 Hz. (typical)
Input Impedance60,000 ohms "Mic." Input Level 120,000 ohms "Inst." Input Level
Distortion	5% maximum at rated output at 1 KHz.
Hum and Noise	60 db below rated output
Speaker Load Impedance	Nominal 8 ohms; operational 5.3 ohms minimum (See Figure 3, Page 7)
Input Clipping Level	Greater than 300 Mv. ("Mic." Input Level) Greater than 1 V. ("Inst." Input Level)
Bass Control Action	± 13 db at 100 Hz. with respect to "flat" setting
Treble Control Action	± 10 db at 10,000 Hz. with respect to "flat" setting
"To Tape Recorder" Jack	Impedance 5,000 ohms; Output 19 db below speaker output; nominal - 2 V at 50 watts to speakers, Clipping Level 4 V.
Echo-"To Input" Jack (Output To External Echo Unit)	Impedance 10,000 ohms; Output 20 db above microphone inputs with individual volumes at "10"; Clipping level 3 V.
Echo-"To Output" Jack (Input From External Echo Unit)	Impedance 40,000 ohms; Sensitivity 200 Mv. for rated amplifier output with "Echo Gain" Control and "Master Volume" Control at maximum settings; Clipping level 2 V. with maximum setting of "Echo Gain" control. Clipping level increases with reduced setting of "Echo Gain" control.
"Reverb Switch" Jack	D.C. switching (no audio), parallels the Master Reverb In-Out Switch. Any cable with a resistance of less than 5,000 ohms may be used.
Center Notch Frequencies of "Anti-Feedback" Filters.	5,000 Hz. 2,200 Hz. 1,000 Hz. 155 Hz.

VA300-C Console (cont'd)

Power Supply	120 volts, 60 Hz.
Power Consumption	80 watts maximum with no signal in. 180 watts with 1 KHz. signal and 100 watts output 400 watts maximum operating
Ambient Temperature Range	-7°C to 43°C (20°F to 110°F) without derating
Dimensions	213 mm height x 635 mm width x 375 mm depth (8-3/8 in. x 25 in. x 14-3/4 in.)
Weight	17.25 kg (38 lbs.)

VA300-S Speaker Column

Power Rating	100 watts
Impedance	16 ohms
Frequency Response	50 Hz. to 10,000 Hz.
Horizontal Distribution	140°
Vertical Distribution	65°
Dimensions	1594 mm height x 400 mm width x 222 mm depth (62-3/4 in. x 15-3/4 in. x 8-3/4 in.)
Weight	31.78 kg (70 lbs.) including cable

DESCRIPTION

The Shure Model VA300 Vocal Master Sound System consists of one Control Console (VA300-C) and two Speaker Columns (VA300-S).

Designed specifically for the performing vocalist, the VA300 Vocal Master Sound System provides the required portability, flexibility, and dependability demanded by professional entertainers.

The VA300-C mixer/power amplifier Console permits the user to mix up to six microphones with individual control over volume, tone and reverberation. A solid-state 100 watt R.M.S. power amplifier is incorporated in the Console. Unique circuitry design protects the solid-state components against damage as a possible result of open-circuit or short-circuit conditions of the amplifier outputs. The output transistors are also protected against overheating by the use of automatic thermal sensors. All components of the VA300 Vocal Master Sound

System are conservatively rated and are operated well within their respective tolerances to assure long life and trouble-free performance.

The VA300-C is Underwriters Laboratories, Inc. listed, and is listed by the CSA Testing laboratories as certified.

The VA300-S Speaker Columns are highly directional, wide range, line-radiators. A rear-ported enclosure is utilized which contributes to the directional characteristics of the Speaker Column and is crucial in reduction of feedback.

The VA300-S employs four special 8-inch loudspeakers and two special 10-inch loudspeakers providing a total cone area of 2,310 cm² (358 in²).

Each Speaker Column is furnished with a 15m (50 ft) #18 gauge, 2-conductor rubber jacketed cable with locking phone plugs attached.

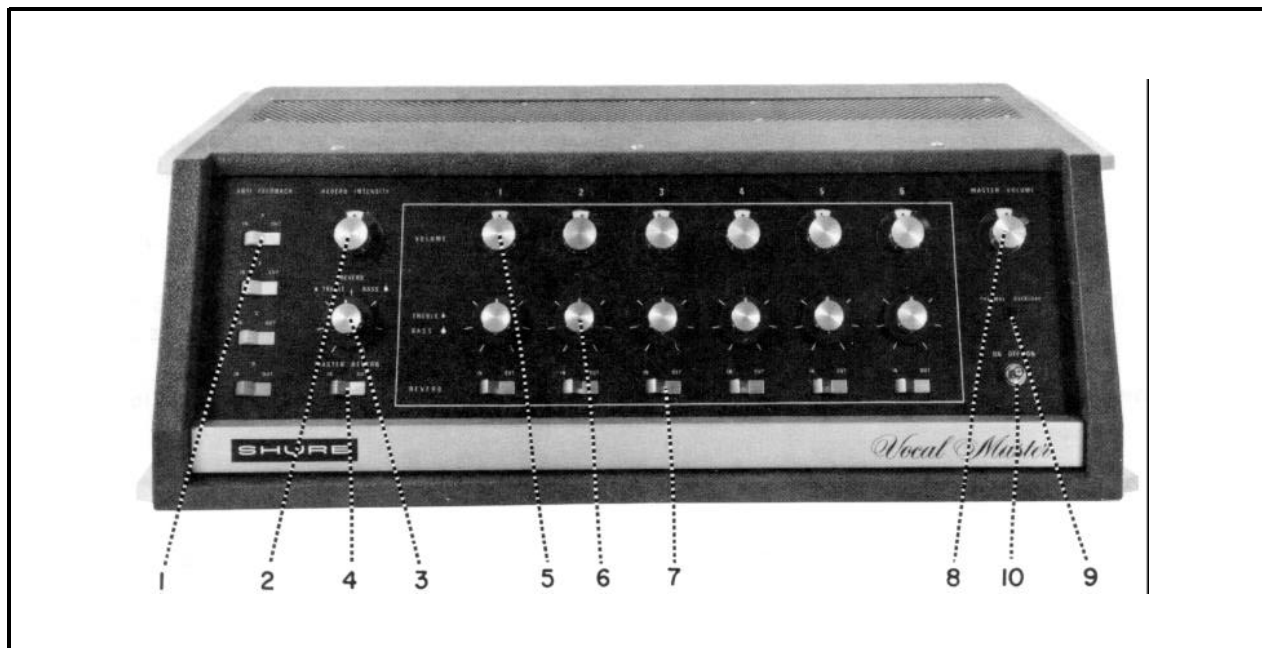

Figure 1

Front Panel Controls (Refer to Figure 1)

- | | |
|--|---|
| <ol style="list-style-type: none"> 1. "Anti-Feedback" Switches (Four). 2. "Reverb Intensity" Control. 3. "Reverb Treble & Bass" Controls (Dual Concentric). 4. "Master Reverb" Switch. 5. Individual Channel "Volume" Controls (Six). | <ol style="list-style-type: none"> 6. Individual Channel "Treble & Bass" Controls (Six, Dual Concentric). 7. Individual Channel "Reverb" Switches (Six). 8. "Master Volume" Control. 9. "Thermal Overload" Indicator Lamp. 10. "On-Off-On" Power Switch. |
|--|---|

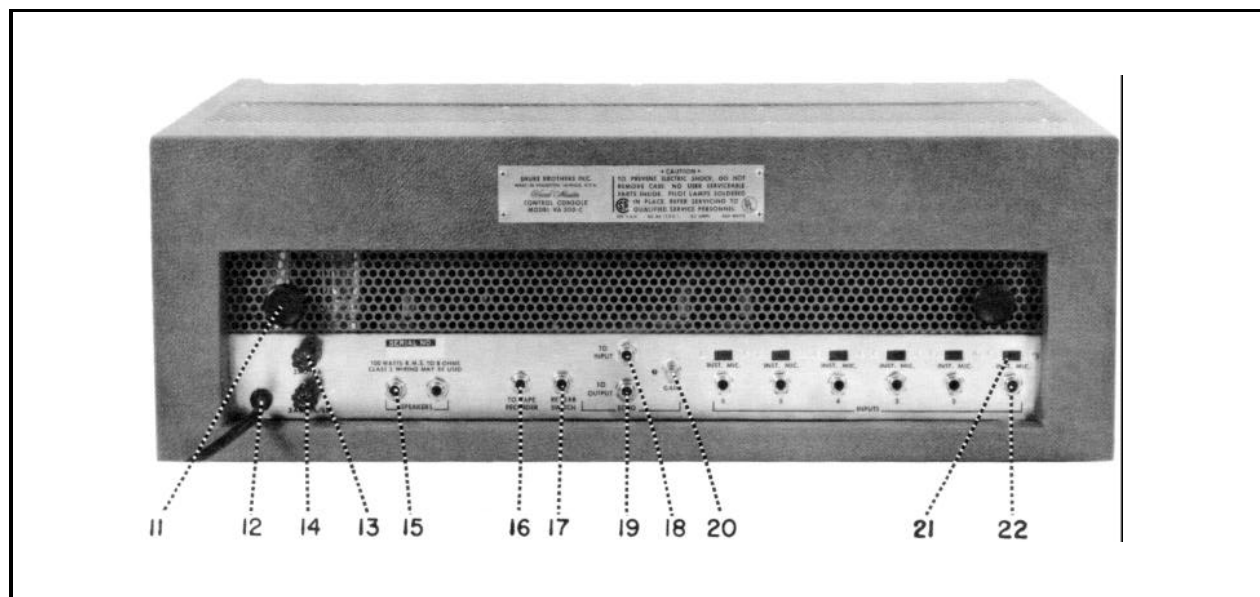

Figure 2

Rear Panel Controls and Connections (Refer to Figure 2)

- | | |
|---|---|
| <ol style="list-style-type: none"> 11. Line Cord Storage Spindles. 12. A. C. Line Cord. 13. D. C. Fuse (3AG/5A). 14. A. C. Fuse (3AG/3ASB). 15. "Speaker" Output Jacks (Two, Phone Type). 16. "To Tape Recorder" Jack (Phone Type). | <ol style="list-style-type: none"> 17. "Reverb Switch" Remote Control Jack (Phone Type). 18. Echo-"To Input" Jack (Switching Phone Type). 19. Echo-"To Output" Jack (Switching Phone Type). 20. Echo "Gain" Control. 21. "Mic./Inst." Input Attenuator Switches (Six). 22. "Input" Jacks (Six, Phone Type). |
|---|---|

VA300 Vocal Master

OPERATING INSTRUCTIONS

General Operating Instructions:

1. Set all front panel controls in the following manner: All switches (1), (4), (7), set to "Out" position; "Reverb Intensity" Control (2), and all "Volume" Controls (5) and (8), set at "0"; all "Treble" and "Bass" Controls (3) and (6), set in the "flat response" position (indicator ribs at 12:00 o'clock); "On-Off-On" Switch (10) set in the "Off" position.
2. Unwrap the A.C. Line cord (12) from the storage spindles (11); plug line cord into a 110 to 130 volt, 60 Hz. outlet. The line cord is a 2.75m (9 ft), 3-conductor cord with a 3-pin grounding plug. If extension cords are required, use a high quality, rubber-jacketed cable with #18 gauge wire or larger.
3. Remove the speaker cables from the storage compartments in the VA300-S Speaker Columns. Insert and lock the right angle phone plug on the cable into either of the two parallel-wired phone jacks; one on each Speaker Column. Connect the other end of each cable to the jacks on the rear panel of the Console marked "Speakers" (15). These plugs are provided with locking rings to lock the plug to the jack. Each speaker cable is 15m (50 ft) in length and is made from heavy duty 2-conductor, #18 gauge unshielded cable. Since each Speaker Column has a pair of parallel-wired input jacks, an alternate speaker hook-up would be to connect a speaker cable from the Console to one Speaker Column and then connect a second cable from this Speaker Column to the second Speaker Column. Either hook-up will provide an 8 ohm load. If longer speaker cables are required, see page 6.
4. Connect one or more high impedance microphones to the Console at the connectors marked "Inputs" (22). The VA300 is designed to operate with any high quality dynamic or ribbon-type high impedance microphone. For low impedance microphones see page 10.
5. Set all six Input Attenuator Switches (21) on the rear panel of the Console to "Mic." These switches should generally be set in the "Mic." position when using high impedance dynamic or ribbon microphones. See page 6 for a description of the switch function.
6. Turn on the Power Switch (10) located on the front panel of the Console. Set the "Master Volume" Control (8) to "5." While talking or singing into one of the microphones connected to the console, turn up the individual volume control for that microphone to a normal level. If at this point a slight hum is heard in the speakers, switch the Power Switch (10) to whichever "On" position results in the least amount of hum coming from the speakers.
7. Now turn up the other Individual Channel Volume Controls (5) which are being used. By use of the Individual Channel Volume Controls (5), the microphones may be balanced for level so that the sound coming from the speakers is in proper balance for each microphone. Increasing or decreasing the Volume on one channel will have no effect on the other channels of the Console.
8. Note the action of the Individual Treble and Bass Controls (6); these controls are of the dual concentric type, the large knob being the Bass control and the smaller knob being the Treble control. Each of these knobs incorporates an indicating rib. Under average conditions, the controls should be set with indicating ribs facing straight up (12:00 o'clock position) to provide a normal "flat" frequency response. All Treble and Bass Controls on the Console operate in the same manner; turning the controls clockwise respectively increases Bass or Treble, counterclockwise decreases Bass or Treble. Note that changing the Bass or Treble Controls on one channel has no effect on the other channels of the unit.
9. Turn the Reverb Intensity control (2) to a setting of "4" Set the Master Reverb switch (4) to the "In" position. Reverberation may now be selectively added to any of the six channels by setting the Individual Channel Reverb switches (7) to the "In" position. Note that different settings of the Reverb Intensity Control (2) will not effect the overall system gain. Generally a setting of "1" to "4" of the Reverb Intensity Control (2) is adequate for vocals. The Reverb Treble and Bass Controls (3) operate in the same manner as those of the individual channel Treble and Bass Controls but provide independent tonal balance of the reverberant signal only. These controls do not affect the tone of the individual channels. For example, increasing Treble and decreasing Bass will approximate the reverb sound of a tape-type reverberation unit while decreasing Treble and increasing Bass will approximate the sound of a plate-type reverberation device.
10. Set all four Antifeedback switches (1) to the "Out" position. These switches can help eliminate feedback. Each switch cuts out part of the critical feedback-generating frequencies. See page 8 for a detailed description on how to effectively use them,
11. The Master Volume Control (8) will raise or lower the volume of all channels simultaneously without affecting the "balance," or "mix." NOTE: With the Console driven at or near full power, pilot lamps will dim or vary in brightness; this is a normal condition.

Input Connections:

Six individual input connectors are provided on the rear panel of the Console. These connectors are standard 1/4 inch phone jacks (22). The Console is designed to operate with any high quality dynamic or ribbon-type high impedance microphone. High impedance microphone cables should be limited to a maximum length of 6m (20 ft) to avoid high frequency signal loss and to reduce the possibility of hum and noise pickup in the cables. Standard 1/4 inch phone plugs should be attached to the "Console end" of the microphone cables; the center conductor of the cable should be attached to the "tip" terminal of the phone plug and the shield of the cable should be connected to the "sleeve" terminal. For low impedance microphones, see page 10.

For additional microphone inputs, see page 10. For connections from electrified musical instruments, see page 10. For connections to play back a tape, see page 9. For connections to a phonograph, see page 10.

Six individual input level adjustment switches (21) are located above the six input jacks. These screwdriver-slot slide switches allow the microphone input signal to be attenuated (reduced) before entering the preamplifier.

With the switch in the "Mic." position, the signal from the microphone is switched directly to the preamplifier of the channel. With the switch in the "Inst." position, the signal from the microphone is attenuated by 11 db before entering the preamplifier.

This feature may be useful when working the microphones very close to the performer's lips as with "hard rock" vocalists, who may produce signals in excess of the clipping level of the preamplifiers; in such an instance, the attenuator will generally eliminate the distortion which would otherwise occur.

Output Connections:

Two parallel-wired "Speaker" output connectors are provided on the rear panel of the VA300. These connectors are standard phone jacks (15).

Full rated output of the amplifier is obtained when the speaker load is 8 ohms (two VA300-S Speakers). Speaker loads of less than 5.3 ohms (more than three VA300-S Speakers) should not be used with this amplifier. No damage to the speakers or amplifier will occur, but thermal shutoff of the amplifier may result.

It should be noted that various speaker loads will affect the output power of the amplifier. See Figure 3, Page 7 to determine amplifier output power for the given speaker load.

WARNING: Do not interconnect the speaker output jacks or the speaker cables between two VA300 Amplifiers or the VA300 and any other amplifier. This may result in damage to one or both amplifiers, and is not covered by the Guarantee.

The VA300 does not use speaker output matching transformers and thus avoids the distortion, power loss and added weight inherent in such transformers. The speaker output voltage is 28.3 volts, to an 8-ohm load, for 100 watts. This allows long speaker lines with wiring practices consistent with those used for 25-volt speaker lines.

Up to 30m (100 ft) of #18 gauge two-conductor cable (such as Belden #8452, 8478, 8460, or 8461) may be used to

connect from the VA300-C to each 16-ohm (VA300-S) speaker. Greater cable lengths require heavier gauge wire to avoid appreciable power loss in the speaker cable. For 30 to 51m (100 to 170 ft), use #16 gauge; 51 to 81m (170 to 270 ft), use #14 gauge; and 81 to 128m (270 to 425 ft), use #12 gauge wire. To maximize the power to each speaker, a separate cable should be used to connect each speaker to the VA300.

Speakers:

Selection of speakers for use in a vocal music system is most critical. The factors which most significantly contribute to an outstanding vocal speaker system are correct frequency range, distortion-free reproduction, and enough sound power to fully penetrate the audience area.

The Shure VA300-S Speaker Column has been designed to provide all of these features. It is recommended that VA300-S Speaker Columns be used in pairs, each column having a nominal impedance of 16 ohms, which provides an impedance of 8 ohms when two are used. Each column utilizes two special 10-inch speakers and four special 8-inch speakers, and has a total speaker cone area of 2,310cm² (358 in²) per column. The VA300-S Speaker Column delivers virtually uniform penetrating power over a 140° angle in the horizontal plane and a 65° angle in the vertical plane. The rear-ported enclosure of the VA300-S contributes to its highly directional pattern, which is critical in achieving maximum audience penetration and reduction of feedback.

The Shure VA301-S Speaker Column is intended primarily for use as an "on-stage monitor." While this speaker meets all of the criteria for an excellent vocal system speaker, its area of coverage is more localized than that of the VA300-S. The nominal impedance of the VA301-S is 32 ohms, so that when used in conjunction with two VA300-S Speaker Columns, the total system impedance becomes 6.4 ohms. An integral volume control on the VA301-S permits its use on-stage as a monitor at the highest possible sound level without feedback.

The following list shows various speaker combinations and the resultant impedance loads which are suitable for use with the VA300 Vocal Master:

<u>QUANTITY and SPEAKER MODEL</u>	<u>IMPEDANCE OHMS (NOMINAL)</u>
1 VA300-S	16
2 VA300-S	8
3 VA300-S	5.3
1 VA301-S	32
2 VA301-S	16
3 VA301-S	10.6
4 VA301-S	8
5 VA301-S	6.4
6 VA301-S	5.3
1 VA300-S and 1 VA301-S	10.6
1 VA300-S and 2 VA301-S	8
1 VA300-S and 3 VA301-S	6.4
1 VA300-S and 4 VA301-S	5.3
2 VA300-S and 1 VA301-S	6.4
2 VA300-S and 2 VA301-S	5.3

If additional speakers (more than in the table above) are required, use a Shure PM300 Power Master Amplifier to drive the extra speakers. See page 11 for instructions.

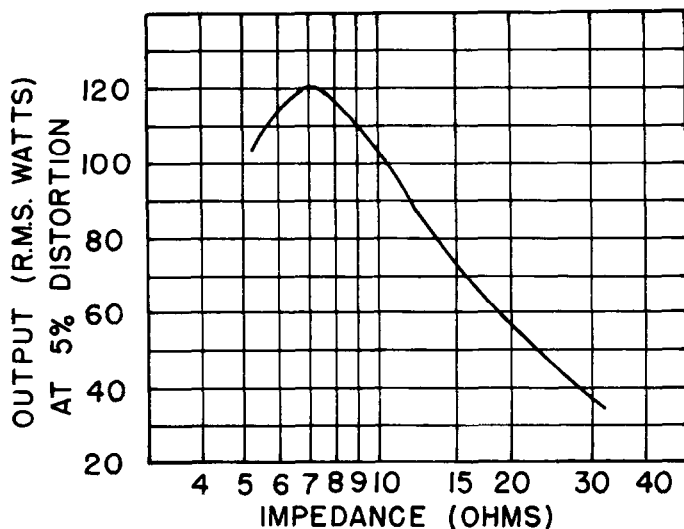

Figure 3. Typical output power vs. speaker load impedance for the VA300 Vocal Master

Column Speaker Placement:

It must always be kept in mind that every room or space is acoustically unique and there are no set "rules" for speaker placement. A number of generalizations however may be made which will at least provide a good starting point under various conditions.

Always consider speaker placement in relation to microphone placement. It is desirable for the loudspeakers and microphones to be in close proximity in order to provide the illusion of source-oriented sound. Source-oriented sound, ideally should provide the listener with the illusion that all of the sound is coming directly from the sound source, the stage or performance area. It is also desirable to keep loudspeakers and microphones separated in order to achieve a high threshold of acoustic feedback. While these statements are contradictory, a good solution to both can generally be accomplished.

When the VA300-S Speaker Columns are used on stage, as they most often are with a portable system, the speakers should be placed at the sides of the stage and as far forward as possible. With this setup, the entire stage area will be relatively free from acoustic feedback; also the illusion of sound coming from the center of the stage will be quite good except for the first few forward rows of seats.

The Shure VA300-S Speaker Column has been designed with rear ports to give the column a bidirectional horizontal polar pattern below 200 Hz. This design feature was decided upon in order to reduce low frequency acoustic feedback and provide a relatively "dead" area at the sides of the column with the result that microphones may be placed there with minimal feedback problems at low frequencies.

Try to keep the speaker columns above the heads of the audience. The easiest way to do this is put the speaker columns on the stage. If the stage is only a foot or two high, raise the speaker columns up by placing them on a solid platform or box.

Keeping in mind that the speaker columns have a narrow coverage angle in the vertical plane and a broad coverage angle in the horizontal plane, here are a few generalizations on speaker requirements for various room shapes.

A deep, narrow auditorium would generally require only two speakers if the seating is all on one level. If balconies were added to this same room, additional speaker columns would be required to aim sound up into them.

A shallow, broad room might require four speakers to be utilized in order to cover the extreme horizontal expanse. Again if balconies were added, four more speakers might be required to expand the vertical coverage.

The "Theatre-in-the-Round" will almost always necessitate the use of at least four columns. More speakers might be required to provide adequate horizontal coverage if the theatre is very deep.

To "aim" speakers up for effective coverage of a balcony, use the Shure Model A3S-S Speaker Stand. This stand will provide added stability and approximately 150 of tilt. In an emergency, a spare microphone stand can be used to hold up a tilted speaker column. Adjust the height of the microphone stand to one or two inches less than the height of the top edge of the upper rear port on the back of the speaker. Tilt the speaker back until the top edge of the upper rear port rests on the top of the microphone stand. Changing the height of the microphone stand adjusts the amount of tilt on the speaker.

The VA300-S Speaker Column may be used on its side, though this reduces the horizontal coverage and the penetrating power. In a low ceiling, small intimate room such as a night club, horizontal mounting, at or near the ceiling level may be very successful. An alternate solution for this type of small room is to use VA301-S Monitor Speakers. It is not recommended that the VA300-S Speaker Column be used on its side in larger rooms.

It is not possible to adequately cover all phases of speaker placement in all types of rooms in this manual. Just remember that every room is acoustically different from any other and therefore speaker placement will vary from room to room.

Good speaker placement will provide the audience with even distribution of sound intensity, sound which is free from excessive reverberation and ethos, and the illusion of sound emanating from the real source.

Power Connections:

Connect the line cord (12) to an outlet which supplies 120 volts AC, 60 Hz. power. The three-position toggle switch on the front panel of the VA300 controls power to the Console. This three-position switch (10) is used to reverse line polarity, for minimum hum.

If extension cords are required to supply power to the VA300, a high quality #18 gauge or larger cord should be used.

Do not connect more than one VA300, or other amplifier to one extension cord. Use separate extension cords for each amplifier. Use a maximum of two VA300's or other amplifier per 120 volt house circuit. Failure to adhere to the above will result in loss of available output power and the risk of blowing house fuses, but will in no way damage the VA300 amplifier.

Thermal Overload/Ventilation:

The VA300 is equipped with thermal sensing switches on the heat-sinks of the output transistors. The thermal switches are set to shut off AC power to the amplifier when a temperature of 90°C (194°F) is attained on the heat-sinks; the switches will automatically recycle and return AC power when the heat-sink temperature reduces to 73°C (164°F). A thermal overload light (9), located on the front panel of the VA300, will indicate if thermal cycling has occurred. Thermal cycling may occur if air is not allowed to circulate through the grilles of the amplifier, if there is a prolonged short-circuit on the speaker output, or if the ambient temperature exceeds 43°C (110°F) while the console is operating at or near full power. Thermal cycling may also occur if the speaker load impedance is less than 5.3 ohms. See page 6, *Output Connections*, for instructions on speaker connections.

Anti-Feedback Switches:

Acoustic feedback (a howl or squeal in the speakers) may occur, depending on room acoustics and the physical placement of microphones in relation to the speakers, when volume is increased or when Bass or Treble controls are boosted. To minimize feedback, four Anti-Feedback switches (1) are incorporated in the VA300-C Console. These switches operate four "notch filters" which modify the frequency response of the unit. Each switch controls part of the audio spectrum. The top switch (A-yellow colored) filters the highest feedback pitch (squeal), while the bottom switch (D-deep orange colored) filters the lowest feedback pitch (howl). The middle switches (B and C) filter the middle feedback pitches. The action of each filter, with the exception of the (D) filter, has very little effect on the tonal quality of the voice. When using the (D) filter, a decrease in bass tones may be noticed. To compensate for this, simply increase all the Individual Channel Bass controls slightly for the desired sound. This feedback switch (D) may be used in a very "boomy" environment to eliminate some of the low frequency room reverberation.

If feedback occurs, locate the one Anti-Feedback switch (1) which eliminates the feedback. Gain may then be increased or tone control increased until another feedback pitch is apparent. One of the other filters may then be introduced which will eliminate that feedback. **IMPORTANT:** no more than two filters should be used simultaneously; the effect of more than two filters is one of reducing overall gain and the overall tonal quality of the system may be significantly affected.

Mixing:

Each of the six channels employ an individual Volume control, Bass control, Treble control, and reverberation selector switch.

Individual Volume controls permit proper mixing of the various inputs.

The Bass control allows 13 db of boost or attenuation at 100 Hz. It permits enhancement of a thin voice and is often useful as a low frequency attenuator in "boomy" rooms.

The Treble control permits 10 db of boost or attenuation at 10 kHz., and is useful to "brighten" an otherwise flat-sounding voice. It is often used to great advantage to reduce high frequency acoustic reverberation in reflective rooms.

The Master Volume control (8) adjusts the output level of the total mixed output, allowing simultaneous increase or decrease of all channels without affecting the mix of the inputs.

Reverb:

The VA300 Console includes a built-in electromechanical spring-type reverberation device utilizing a total of four coil springs in two transmission paths. Reverberation is accomplished by driving the input ends of the springs in a torsional mode and transferring the torsional movement at the other end of the springs back into an electrical signal which exhibits time delay and long decay time. Since the reverberation device is an electromechanical device, it is sensitive to mechanical shock. It is recommended that if the console is moved while operating, the Master Reverb In-Out switch (4) be set to the "Out" position. This will avoid the possibility of jarring the springs and producing unwanted sounds.

Unique to the Vocal Master is the fact that no matter how much reverberation is used, there is always a backbone of "dry" signal on the total output. Of great importance to the user, and also unique to the Vocal Master, is the system which permits the reverb intensity to be increased without increasing overall gain. In most units which employ artificial reverberation, as the intensity of the reverberant signal is increased, the total gain also increases; this usually leads to acoustic feedback. The reverb mixing system used in the Vocal Master reduces the "dry" signal as the reverberant signal is increased; this accounts for an almost constant gain and reduces the possibility of feedback as reverb is added.

Three controls are pertinent to the VA300-C reverb operation. The amount of reverb is selected by the Reverb Intensity control (2). Generally, this control is not used above a setting of "5" for vocalists, though higher settings may be required for instruments. Separate Reverb Bass and Treble controls (3) are provided for the reverb signal only and are independent of the other tone controls on the unit. These controls modify the reverberant signals in essentially the same way the individual channel tone controls modify the non-reverb, or "dry" tones. The reverb tone controls allow the user to change the reverberant sound to compensate for the reverberation of each room in which the system is used. In a "boomy" sounding room, decrease the Reverb Bass control or increase the Reverb Treble control, or do both to equalize the reverb signals for the desired sound.

The individual channel Reverb In-Out switches (7) are basically intended to allow the user the option of having reverb on one or more channels while retaining a "dry" (non-reverb) signal on the other channels. These switches can also be used to perform a variety of other functions which are described under *Special Operating Instructions*.

The master Reverb In-Out switch allows instantaneous reverb turn-on or shut-off, no matter how the individual channel reverb selector switches are set. This feature allows the user to "pre-program" the console for reverberation.

A phone jack marked "Reverb Switch" (17) is located on the rear panel of the console. This jack parallels the Master Reverb In-Out switch (4) and allows the reverb to be remotely turned on and off when the Master Reverb switch is in the "In" position. The Master Reverb switch will always override the remote switch and turn off the reverb, so care should be taken to insure that the Master Reverb switch is in the "In" position if an external remote switch is desired to control the reverb switching.

Since the remote switching is D.C., and no audio appears on this jack, any length of unshielded cable can be used between the Console and the remote switch without hum or noise. The remote switch can be any single pole, single throw switch.

VA300 Vocal Master SPECIAL OPERATING INSTRUCTIONS

Echo:

Echo may be introduced into the VA300-C by using an accessory echo device (such as an Echolette or Dynacord).

To use an external echo device in conjunction with the VA300, interconnect the two units as follows: attach low capacitance, single conductor, shielded cable to the Console jack marked Echo "To Input." Connect the opposite end of this cable to the echo device jack marked "Input" (Aux. High Level). Connect a similar cable to the echo device jack marked "Output" (Aux. High Level) and connect the opposite end of this cable to the Console jack marked Echo "To Output."

Using the "Echo Gain" Control in conjunction with the level controls on the echo unit, the echo signal may be balanced with the gain of the VA300 so there is no change in level when the individual Reverb In-Out switches are operated.

When connected in the manner described, the individual channel Reverb In-Out switches will offer selective echo in addition to selective internal reverb. With the Master Reverb In-Out switch in the "Out" position, the individual channel Reverb switches will select "dry" (no echo) in the "In" position and "Echo" in the "Out" position.

Changing the Master Reverb In-Out switch to the "In" position will permit selection of echo (individual channel Reverb switch "Out") or reverb (individual channel Reverb switch "In").

The output signal of the VA300-C at the jack marked Echo "To Output" is considered high level and is suitable for use with loads of 10 kilohms or greater. The jack marked Echo "To Input" presents a 40 Kohm load to the source and will accept high level signals. Some echo units employ inputs suitable only for very low level; in such cases, a resistance pad (attenuator) will be required in the line from the VA300-C to the echo device input. If the echo device input is suitable for only high impedance microphones a resistive pad consisting of a 100 kilohm and a 3.3 kilohm resistor is required. (See figure 4). Almost all makes of echo units use different output levels; these may generally be compensated for by use of the gain

To Tape Recorder:

A phone jack on the rear panel marked "To Tape Recorder" is provided for connections to tape recorders for making recordings, or to additional power amplifiers, such as the PM300. For specific instructions for such connections see the section marked *Special Operating Instructions*.

The signal at this jack is the same signal that drives the Console power amplifier and is considered to be an auxiliary, high impedance output for driving high-level, high impedance inputs. Note that all the Console controls, Master Volume, Antifeedback, Reverb, etc., affect this signal.

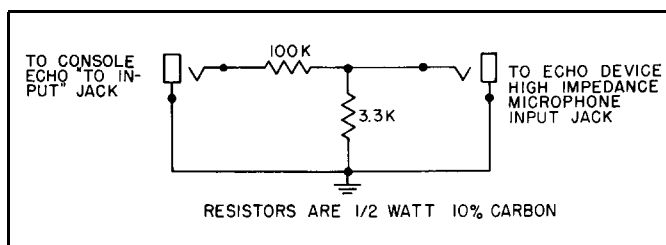

Figure 4

controls on the echo unit and the "Echo Gain" control on the Console.

Tape Recording:

To tape record the VA300 output, connect a low capacitance, single conductor, shielded cable (such as Belden #8401, #8410, #8411) from the jack marked "To Tape Recorder" to the Auxiliary High Level Input of the tape recorder.

Limit the cable length to 15m (50 ft) to avoid loss of high frequency signal and to reduce the possibility of hum pickup. Use the tape recorder controls to set recording levels. Note that the VA300 Master Volume control affects the signal level at the "To Tape Recorder" jack. To make stereo tape recordings see the section on stereo operation, on page 12.

Playing Tapes:

To play back tape recorded material through the VA300, connect a cable from the tape recorder's High Level Output to one of the six Input jacks on the Console. Set that channel's Input Attenuator Switch to "Inst." Individual channel Treble and Bass controls should be set to 12:00 o'clock.

The individual channel Volume Control may be used, in conjunction with the tape recorder playback level control, to adjust volume.

Phonographs:

To connect a phonograph having a magnetic cartridge, and no preamplifier, to the VA300, attach a cable from the phonograph output to one of the six Input jacks on the Console. Set that channel's Input Attenuator Switch to the "Mic." position. Set the Treble control for that channel at 9:00 o'clock and the Bass control at 3:00 o'clock to provide approximate R.I.A.A. phono equalization. Use the individual channel Volume Control to adjust the volume from the phonograph.

To connect a phonograph having a magnetic cartridge, and a phono preamplifier, to the VA300, connect a cable from the phono-preamplifier output to one of the six individual channel input jacks on the Console. Set that channel's Input Attenuator Switch to "Inst." Set the Treble and Bass controls for that channel to 12:00 o'clock. Use the individual channel Volume Control in conjunction with the phonograph's level control, to adjust the volume.

For stereo phonographs see the section on *Stereo Operation*.

Musical Instruments:

Most electrified musical instruments may be amplified through the VA300 with great effectiveness. Generally the output of electrified instruments is greater than the output of a dynamic microphone and therefore the individual channel Input Attenuator Switches should be set to "Inst." to avoid exceeding the preamplifier input clipping level. See the section on *Input Connections* for further information.

Electrified instruments may then be connected directly to the individual Input jack. If low volume occurs, return the Input Attenuator Switch to the "Mic." position.

Low Impedance Microphones:

Low impedance microphones may be used with the VA300 when accessory matching transformers (Shure Model A95UF) are added to the Input jacks (22).

The Shure Model A95UF Line Matching Transformer is terminated at the high impedance end with a locking-type phone plug for direct connection to the input jack; the low impedance end is terminated with a Cannon-type, 3-pin female connector.

The main advantage of low impedance microphones is that virtually unlimited cable lengths may be used, whereas high impedance microphones require that cable length not exceed 6m (20 ft).

Low impedance microphones should be wired using low capacitance, two-conductor, shielded cable (such as Belden #8413, #8422). When wiring Cannon-type connectors, the cable shield should be connected to Pin No. 1 and one of the two conductors to Pin No. 2, the other conductor to Pin No. 3. When using several microphones, consistency of cable wiring should be followed to insure that all microphones are "in phase."

To test two microphones and their cables for proper phasing, connect them to the VA300. Talk or sing into the two microphones while holding them 8 to 10 cm (3 to 4 in.) apart. The amplified sound from the Speaker Column will be

the same when talking directly into either microphone or directly between them if they are in phase with each other. If the sound drops drastically, or a dead spot is found when talking between the two microphones, one of them, or their cables, is out of phase.

To change the phase of the one microphone, or cable, interchange the conductors that are wired to Pins No. 2 and No. 3 of the Cannon connector. Test all the microphones and cables this way to insure that they are all "in phase" with each other.

Additional Inputs Using a Mixer:

If additional microphone inputs are required, a microphone mixer (such as a Shure M68 type) or a second Vocal Master Console may be used.

When using a microphone mixer for the additional inputs, connect the mixer High Impedance Mic. Output to one of the Input jacks on the VA300 Console. The individual input control on the channel, bass, treble, volume, and reverb, provide master control over the mixer inputs. See Figure 5.

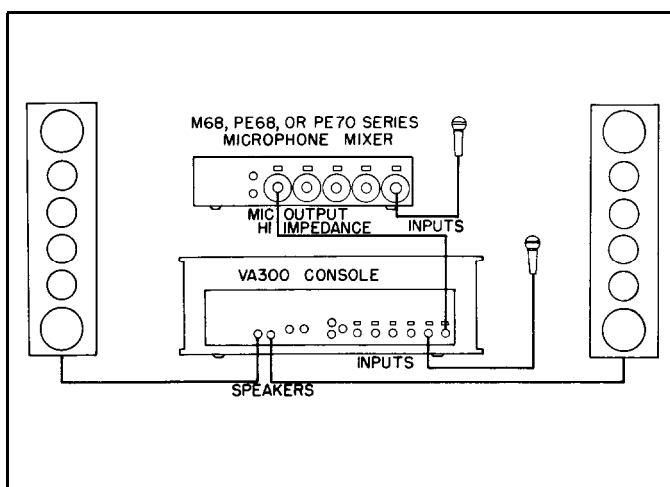

Figure 5

When reverb and external echo are not required, the mixer may be connected to the Echo "To Output" jack. With this arrangement the mixer Aux. High Level Output is connected to the Console Echo "To Output" jack. See Figure 6.

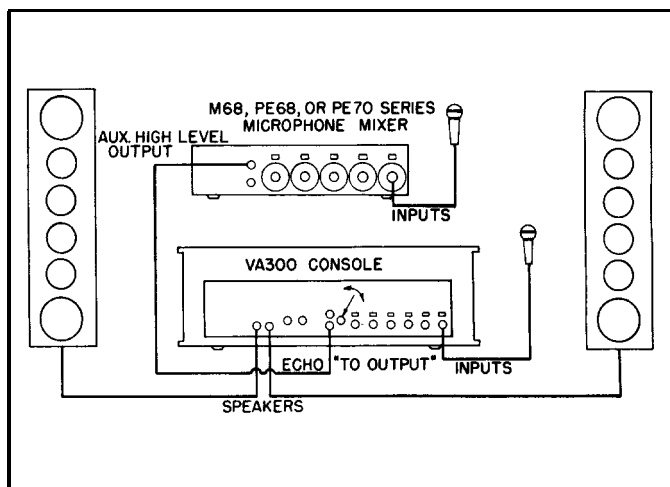

Figure 6

Adjust the Echo Gain control and the mixer volume controls to match the gain of the VA300 inputs. With the mixer connected in this configuration the individual Reverb In-Out switches on the Console should be set to the "In" position. When these switches are set to the "Out" position, that individual channel will be muted, or "cued." See the description on "cuing." Still more inputs may be added by stacking additional mixers onto the first mixer. See the Mixer Operation Instructions.

Additional Inputs Using a Second VA300-C:

A second VA300 Console may be used as a mixer to provide additional inputs. Connect the Echo "To Input" jack on the second Console to an Input jack on the original Console and set the Input Attenuator switch on that input to the "Inst." position. See Figure 7.

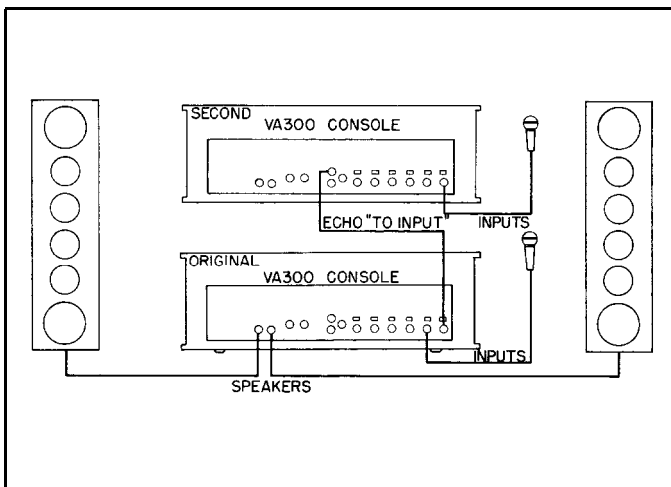

Figure 7

At this point it should be noted that the microphones on the original Console are out of phase with those on the second Console. If the microphone pickups for the two Consoles are different sources, for instance the original Console is a vocal pickup and the second an instrumental pickup, this is not a problem.

For further information on Phasing see the section on *Low Impedance Microphones* on page 10.

With this arrangement, the power amplifier section on the second Console is not being used. If additional power and coverage are required, this power amplifier section may also be used. See the section on additional power using a second Console.

If it is necessary to use two consoles on a permanent basis a factory authorized COMMON MIX. BUS MODIFICATION is available. Contact your Shure Dealer or the Shure Factory for further information on this.

Additional Power or Area Coverage:

In those applications which require more power than one VA300 Vocal Master system is able to deliver, such as very large auditoriums and stadiums, and in those installations where the audience is so widespread, such as Theatre-in-the-Round and for coverage in adjoining rooms or when more than three speaker columns are required, it is advisable to use a

PM300 Power Master amplifier and additional Speaker Columns. Generally two Speaker Columns should be connected to each amplifier. See Figure 8.

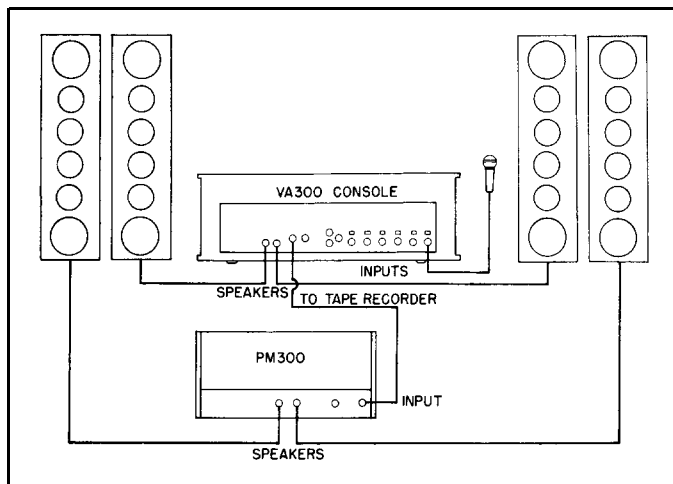

Figure 8

To use the PM300 Power Master Amplifier, connect a cable from the VA300 Console jack marked "To Tape Recorder" to an input on the PM300 Amplifier. The cable used should be limited to 15m (50 ft) of low capacitance, single conductor, shielded type (such as Belden #8401, #8410, #8411).

Set the Volume Control on the PM300 to "7" to obtain the same amplification level from both the VA300 and the PM300 when identical speaker loads are employed on each amplifier. The output of the PM300 will "follow" all control settings of the VA300 Console. Additional PM300 Amplifiers may be added to the system by connecting a cable from the unused input jack on the last PM300 to one of the input jacks on the next PM300. See Figure 8. NOTE: The unused input jack on the last PM300 in the "chain" can then be used for tape recording. See the Special Operating Instructions on *Tape Recording*.

To use a second VA300 Console in place of a PM300 to obtain additional power, connect a cable from the original VA300 Console jack marked "To Tape Recorder" to the jack marked Echo "To Output" on the second VA300 Console. See Figure 9.

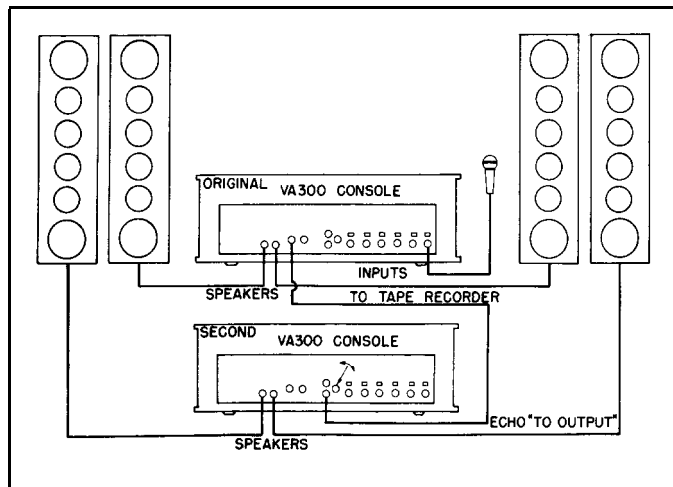

Figure 9

Set the controls on the second VA300 Console as follows: Antifeedback Switches to "Out," Master Reverb Switch "Out," Individual Volume Controls to "0," and the Master Volume to "5." Adjust the Echo "Gain" Control to approximately 1/3 rotation from the c.c.w. off position, and use this control as a volume control to obtain the same amplification level from both of the VA300 Consoles. Once the Echo "Gain" Control is preset, the output of the second VA300 Console will "follow" all control settings of the original VA300 Console. Small changes in amplification level on the second VA300 Console can be made by adjusting its Master Volume Control.

An additional VA300 Console, PM300 or tape recorder can be connected to the "To Tape Recorder" jack on the second VA300 Console.

Microphone Cuing:

Microphone "cuing" may be preset by using the individual Reverb "In-Out" switches to reduce the volume of, or turn off an unused individual microphone channel. This is useful when it is desired to preset the individual volume controls but only have one or two microphones "live" at a time. This allows tighter control of feedback, or additional control to avoid pickup from off-stage microphones.

Insert an unwired phone plug into the Echo "To Output" Jack. With the individual Reverb switch in the "In" position, the channel will operate normally. In the "Out" position, the channel level is reduced or turned off. The level of the "Out" or "Cued" channel is controlled by the "Echo Gain" control; turning this control fully counterclockwise turns off the "Cued" channel. Returning the individual Reverb "In-Out" switches to "In" restores the channel to the normal level.

For remote "Cuing" on and off, plug a foot switch into the Echo "To Output" Jack on the VA300 Console. Turn the "Echo Gain" control fully clockwise. With the foot switch in the "On" position, the channels will operate normally. With the foot switch "Off" those channels switched to individual Reverb "Out" are turned completely off. This is useful for remotely turning on and off preselected channels (Microphones). The cable used with the foot switch should be limited to 15m (50 ft) of low capacitance, single conductor, shielded type (such as Belden #8401, #8410, #8411) to avoid high frequency signal loss and to reduce the possibility of hum pickup in the cables.

Stereo Operation:*

Stereo operation may obviously be obtained by using two VA300 systems without any interconnections. If it is desired to have one of the microphones connected to both systems, simply use a "Y" connector on that microphone and feed its signal to one Input on each Console. For making stereo tapes, the "To Tape Recorder" jacks, one on each console, may now be connected to the left and right Auxiliary Inputs, respectively, on a stereo tape recorder.

Alternatively, stereo may be accomplished by using one VA300 system and one PM300 with additional speakers. A connection is made from the VA300 jack marked Echo "To Input" to an input of the PM300. Those input channels of the Console which are to be reproduced through the VA300

* As a general rule stereo sound reinforcement of this type is quite annoying to listen to and is recommended only for special effects.

Console speakers will require that the individual channel Reverb "In-Out" switches be in the "In" position. The channels on which the switches are in the "Out" position will be heard at the speakers connected to the PM300. This may be used for a special echo effect, like "throwing" a voice from the rear of the room.

Stereo recordings may also be made using one VA300 Console and one PM300. One channel of the stereo tape recorder would be fed from the Console jack marked "To Tape Recorder;" the other channel would be fed from the open input jack of the PM300. NOTE: Reverberation can be added to only those channels that are being reproduced by the speakers connected to the VA300 Console.

A very convenient way of recording with a stereo tape recorder is to record the vocals on one tape channel and the instruments on the other tape channel. Connect the VA300 "To Tape Recorder" jack to the right channel auxiliary input of the tape recorder. A separate microphone is connected to the left channel microphone input of the tape recorder; an omnidirectional microphone suspended from the ceiling is recommended.

A stereo phonograph may be connected for stereo operation with either of the two above systems. Connect the left phono output to one Input, and the right phono output to a second Input. Refer to the section on *Phonographs* on page 10, for Input arrangements. Set the individual Reverb In-Out switches on these two channels to direct the sound to the left and right speakers.

Connecting a VU Meter:

An external VU meter may be connected in parallel across the speaker wires of the VA300 with a resistor attenuator, as shown below. Use a true VU meter (such as Simpson Model No. 1349) and three resistors connected as shown. The resistors should be 1/2-watt carbon 5%, or 1% if available.

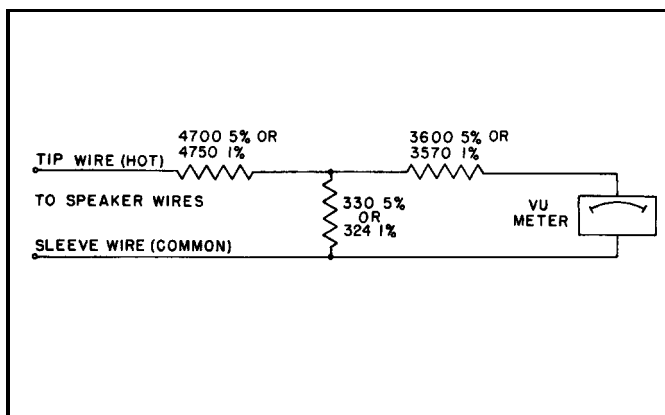

Figure 10

With an 8-ohm speaker load (two VA300-S) zero VU is 50 watts. Output power for other VU readings is shown in the table below.

VU	Power to 8-ohm load
+3	100 watts
0	50 watts
-3	25 watts
-7	10 watts
-10	5 watts

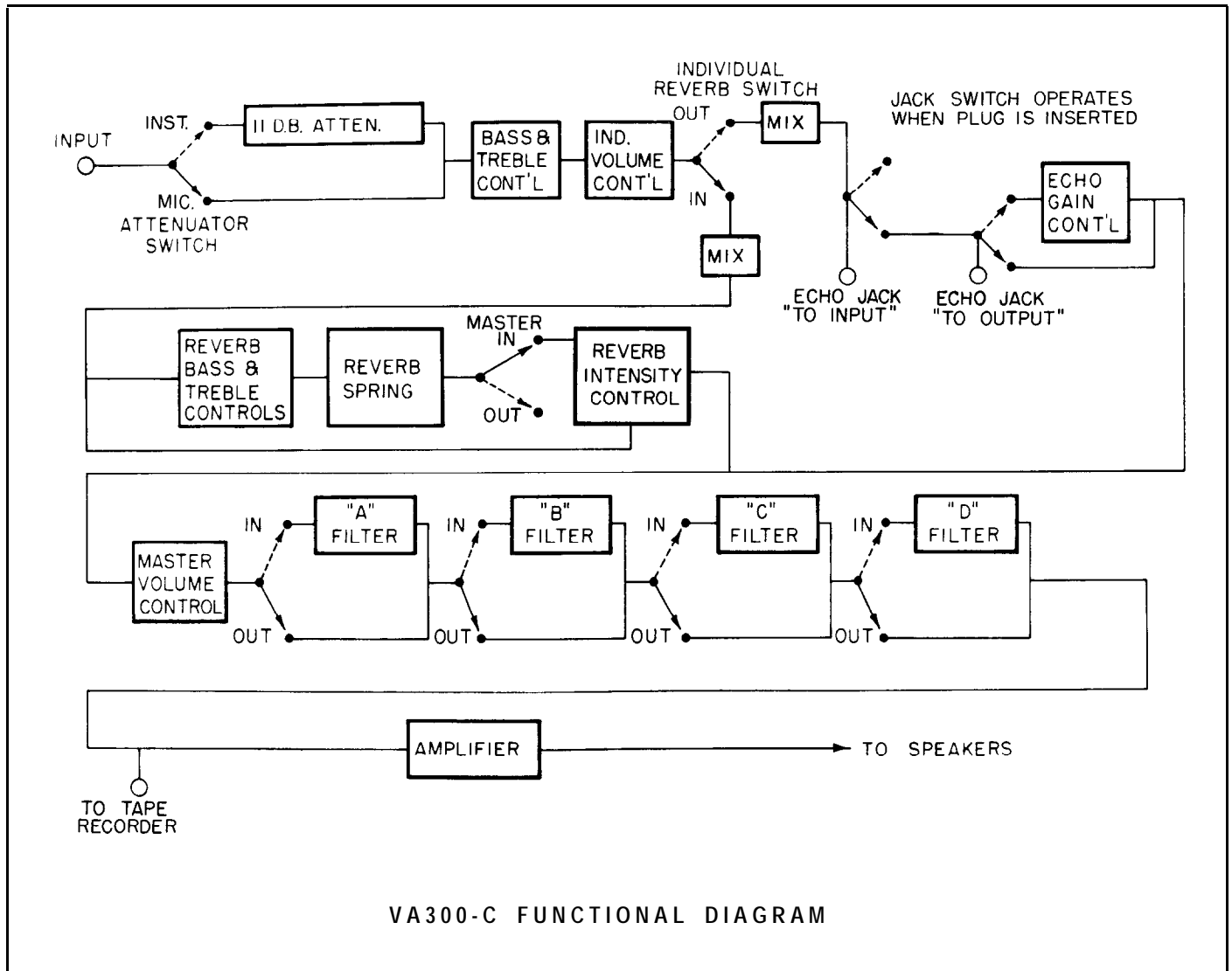

Figure 11

VA300 Vocal Master SERVICE INSTRUCTIONS

Amplifier Service (See Guarantee):

The VA300 Vocal Master Console uses components of the highest quality, operating well within their respective ratings to assure long life. **CAUTION:** There are no user serviceable parts inside. Refer servicing to qualified service personnel.

Amplifier Removal:

To remove the amplifier from its carrying case, remove the three screws located at the top front edge of the case and the six screws, four within the plastic feet, on the bottom of the case. Push the amplifier slightly forward from the back to permit

access to the front panel. (Note: Uncoil the cable before pushing the chassis. Push against amplifier chassis not against the grille on the back.) The entire amplifier may be pulled forward at this point and separated from the case.

Front Panel Removal:

To ease servicing of components on the front panel, remove the four screws on the bottom rim of the front panel. (Note: Stand amplifier on end with transformer side down). Figure 12, Page 14, shows the amplifier with the front panel removed and tilted to a convenient servicing position.

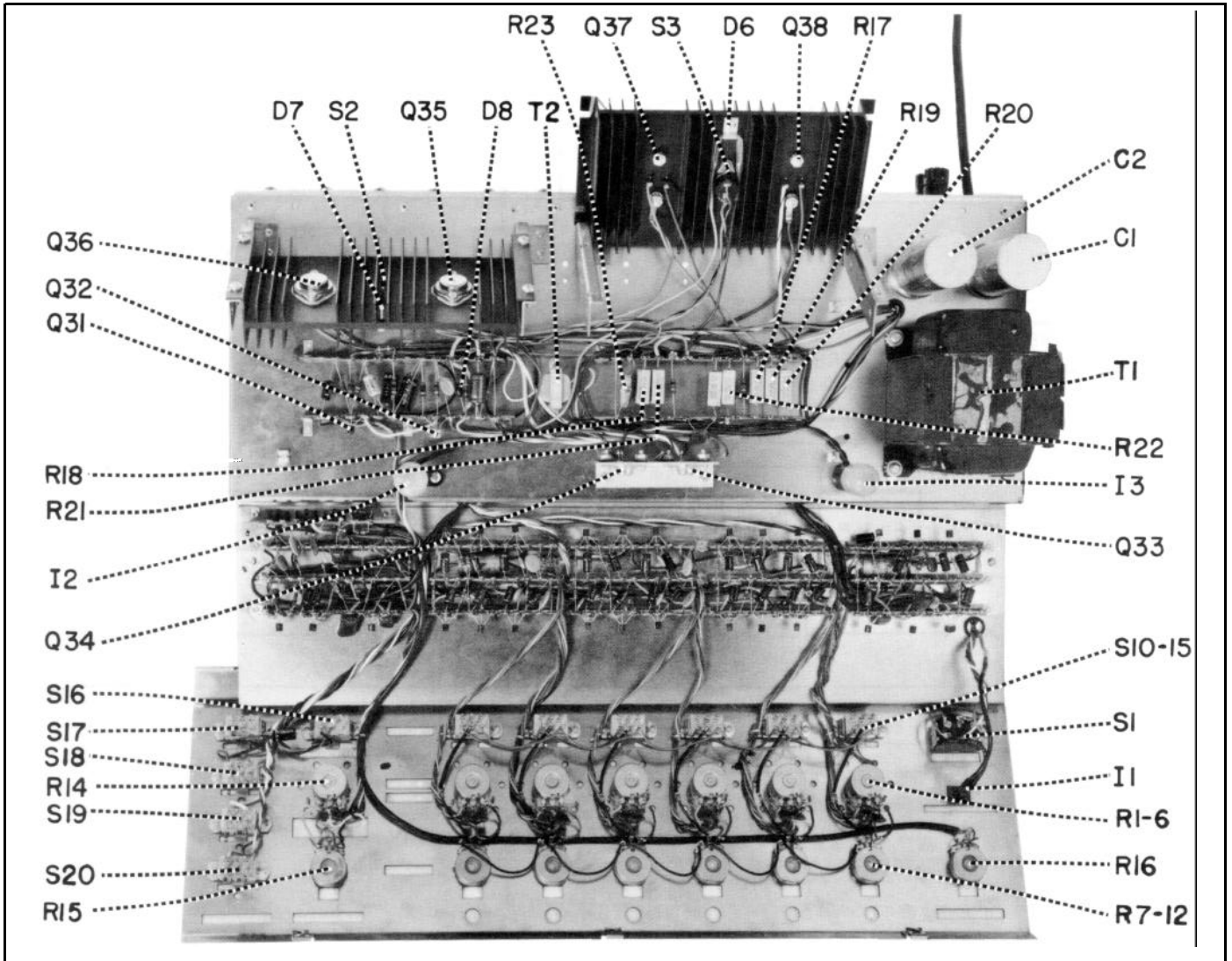

Figure 12

Driver Transistors:

The driver transistors Q33 and Q34, Figure 12, Page 14 are located on the amplifier chassis. Before removing these transistors, write down the lead color and location at each transistor solder junction. If replacing transistors, apply type 120 Wakefield thermal joint compound to each side of the insulation wafer to provide good thermal transfer from transistor to chassis. After replacement and before connecting transistor leads, check transistors with an ohmmeter between case and chassis; there should be no continuity. Be sure that these transistors are not inverted in the circuit; they are not identical devices. Q33 is an NPN transistor, while Q34 is PNP transistor. Refer to the lower right corner of the circuit diagram, Figure 18, Page 21, for terminal code. NOTE: When replacing driver transistors, perform the following modification (if not already performed): place insulated tubing over the leads of a 3.3k, 1/2W resistor and solder it across the terminals to which the white and black leads of transformer T2 are connected. Add a second ground wire from the terminal nearest the front of the unit to which resistor R21 is connected, through the chassis grommet, to the ground on the Speaker Output jacks (same path as existing wire).

Output Transistors:

The output transistors Q35 through Q38, Figure 12, Page 14 are located on the black finned heat sinks. Replacement procedure is the same for the driver transistors, Q33 and Q34.

NOTE: The output transistors, Q35 through Q38, must be matched for *current gain* and part number. When replacing output transistors be sure to replace with devices which have the same gain code as the original transistors. Shure transistors are coded either by the last letter in the part number or a color-dot on the top of the transistor.

Blue Dot = A
 Red Dot = B
 Orange Dot = C
 Yellow Dot = D
 Green Dot = E
 Brown Dot = F
 Pink Dot = G
 Violet Dot = H
 Black Dot = J
 White Dot = K

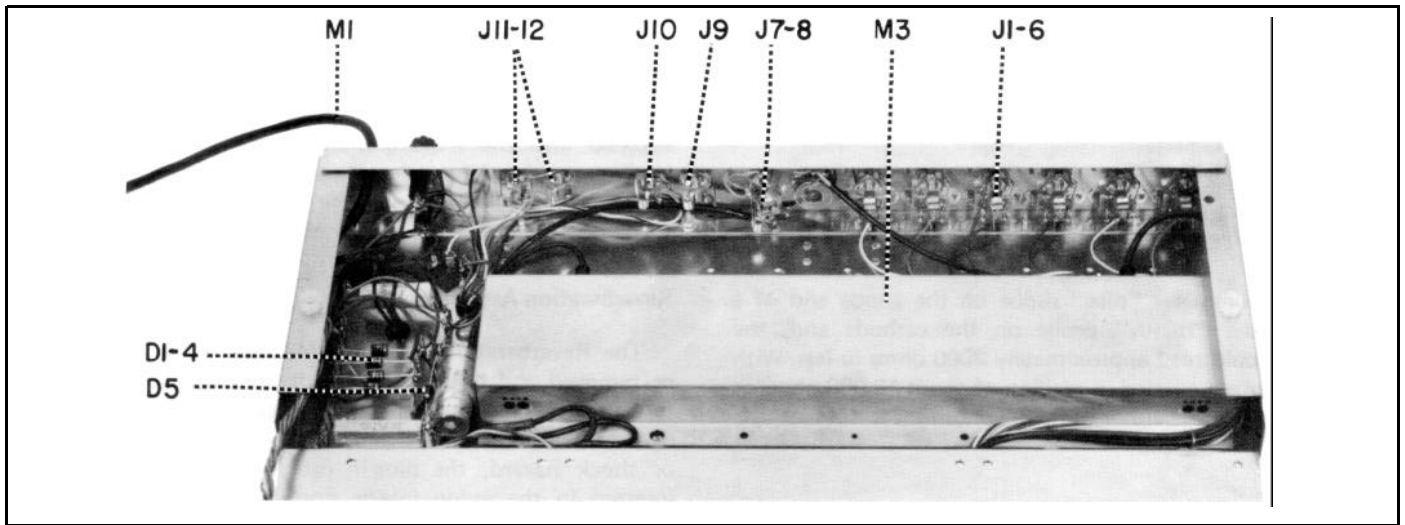

Figure 13

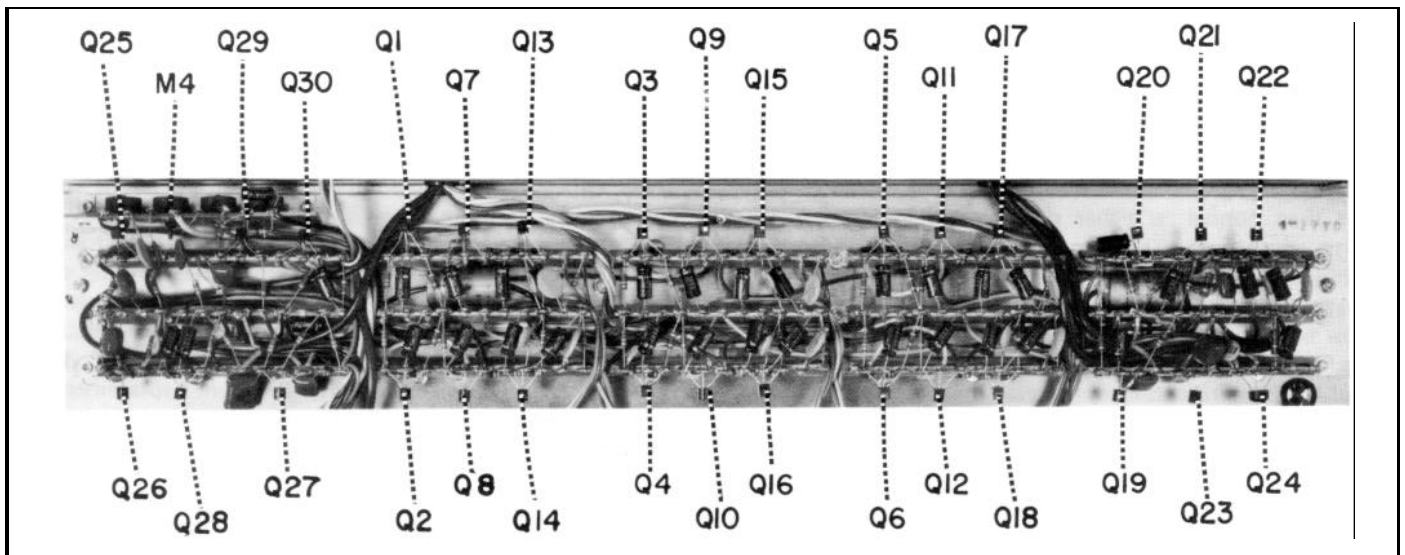

Figure 14

Small Signal and Predriver Transistors:

Transistors Q1 through Q30, Figure 14, Page 15 and Q31 and Q32, Figure 12, Page 14 are mechanically supported by their leads. When replacing these transistors, it is imperative that proper lead configuration be followed. A minimum of soldering heat should be used to avoid damage to the transistor. Refer to the lower right corner of the circuit diagram, Figure 18, Page 21, for lead code.

Diodes:

Diodes D6 and D7, see Figure 12, Page 14 are located on the black finned heat sink with the output transistors. Special care is required to insulate these diodes from the heat sink while providing good thermal transfer from sink to diode. Heat shrinkable tubing or "spaghetti" should be placed over the diode and connecting leads; the diode should be securely clamped to the heat sink with the clamp provided.

Check Transistors and Diodes:

Defective transistors and diodes may be located by use of an ohmmeter. Polarity of the ohmmeter must be verified before these checks are made.

With a known diode orientation, measure the diode resistance in the forward and reverse directions. The lowest meter reading will establish the probe at the cathode end (schematic symbol arrow points to cathode) as the "minus" probe while the other probe will be "plus". Some ohmmeters are not polarized in this manner with relation to "volts plus probe" and "volts minus probe."

To check transistors, the ohmmeter should be set to the 100 ohm or 1,000 ohm scale. Small signal transistors (Q1 through Q32) must be removed from the circuit before testing. Transistors mounted with screws (Q33 through Q38) may be tested in place; however, the leads to these transistors must be removed.

If all conditions in the following table are met, the transistor may be considered free of any gross defect; if any of the following conditions are not met, the transistor should be replaced. See lower right corner of circuit diagram, Figure 18, Page 21, for transistor terminal code.

OHMMETER CONNECTIONSOHMMETER READING

<u>"Plus" Lead</u>	<u>"Minus" Lead</u>	<u>N.P.N. Transistor</u>	<u>P.N.P. Transistor</u>
Collector	Emitter	High	High
Emitter	Collector	High	High
Collector	Base	High	Low
Emitter	Base	High	Low
Base	Collector	Low	High
Base	Emitter	Low	High

With the ohmmeter "plus" probe on the anode end of a diode, and the "minus" probe on the cathode end, the ohmmeter should read approximately 2000 ohms or less. With the meter probes reversed, a reading of about 10,000 ohms or more should occur. If either of these conditions is not met, the diode should be replaced.

Power Drain Resistor (R_{SEL}):

The following condition may occur after replacement of driver transistors Q33 and Q34, output transistors Q35 through Q38, or diodes D6 and D7. If the unit appears to operate at an excessively high temperature or thermally recycles after about 10 minutes with no signal input, the "cold" standby power drain may be excessive (up to 20 watts higher than normal; a higher power drain indicates further circuitry problems). The nominal power drain under these conditions should be 60 watts; if the measured figure exceeds 75 watts, insert a resistor (R_{SEL}) in parallel with the 56-ohm resistor between the base of transistor Q33 and the junction of diodes D6 and D8 (figure 17, page 21). R_{SEL} ($\frac{1}{2}W$, 10%) should be either 180 ohms to decrease the power consumption by 20 watts, or 82 ohms to decrease the power consumption by 30 watts.

Lamp Replacement:

The two lamps I2 and I3, Figure 12, Page 14 which provide illumination of the front panel controls are 115 to 125 volt, 15 watt incandescent bulbs. These bulbs are soldered and epoxied into the molded plastic sockets in order to meet Underwriters' Laboratories requirements. The assembly may be removed by unsoldering the lamp leads at the terminal strips and removing the screw that holds the socket to the chassis.

Reverberation Assembly:

The Reverberation Assembly M3, Figure 13, Page 15 may be removed and returned to the factory Service Department for repair if a malfunction should occur. The amplifier can be operated without this assembly. To eliminate possible damage, or shock hazard, the plug-in cables should be temporarily inserted in the nylon inserts normally used to mount this sub-assembly. If extensive damage has occurred, a replacement Reverberation Assembly may be ordered through the dealer or from the factory Service Department.

Replacement Parts:

Parts that are readily available through local electronic parts distributors are not shown on the accompanying Parts List. Their values are shown on the circuit diagram. The special custom made parts are shown on the Parts List.

The commercial alternates shown on the Parts List are not necessarily equivalents, but may be used in the event that direct factory replacements are not immediately available. To maintain the highest possible performance and reliability, Shure factory replacement parts should be used. When ordering replacement parts, specify the Shure Replacement Kit Number, description, product model number and serial number.

**EQUIPMENT DESIGNED FOR USE
WITH THE VA300 VOCAL MASTER**

VA300-S	Vocal Master Speaker Column
VA301-S	Vocal Master Monitor Speaker
PM300	Power Master Booster Amplifier
A3PC	Soft Cover Set
A3PC-C	Console Soft Cover
A3PC-S	Speaker Column Soft Cover
A31PC-S	Monitor Speaker Soft Cover
A3S-C	Fold-Up Console Stand
ASS-S	Speaker Stand
A50XC	15m (50 ft) Speaker Extension Cable
A3S-T	Speaker Stand
A95 Series	Low Impedance Transformers

GUARANTEE: This Shure product is guaranteed in normal use to be free from electrical and mechanical defects for a period of one year from the date of purchase. Please retain proof of purchase date. This guarantee includes all parts and labor.

SHIPPING INSTRUCTIONS: Carefully repack the unit and return it prepaid to the factory. If outside the United States, return the unit to your authorized Shure Service Center for repair. The unit will be returned to you prepaid.

SERVICE: If information or service should be required, contact your local Shure Vocal Master dealer explaining your difficulty in detail. In addition, the Shure factory service department will be ready to assist you immediately upon request.

VA300-S Speaker Servicing:

1. Unplug cables from speaker jacks.
2. Remove back of cabinet.
3. Disconnect one end of the lead connected between the two 10 inch loudspeakers.
4. Apply 60 Hz, 1 to 10 volts, to each of the six speakers individually. Any buzzes or rattles indicate possible failure. The speakers should all sound generally alike with a slight difference between the 8 inch and 10 inch loudspeakers.
5. Using an ohmmeter, measure resistance of the voice-coil of each loudspeaker individually. Each 10 inch speaker should measure between 12 and 16 ohms. Each 8 inch speaker should measure between 5 and 8 ohms. Readings outside of these limits indicate possible failure.
6. Reconnect lead disconnected in Step 3. Install back of cabinet tightly.

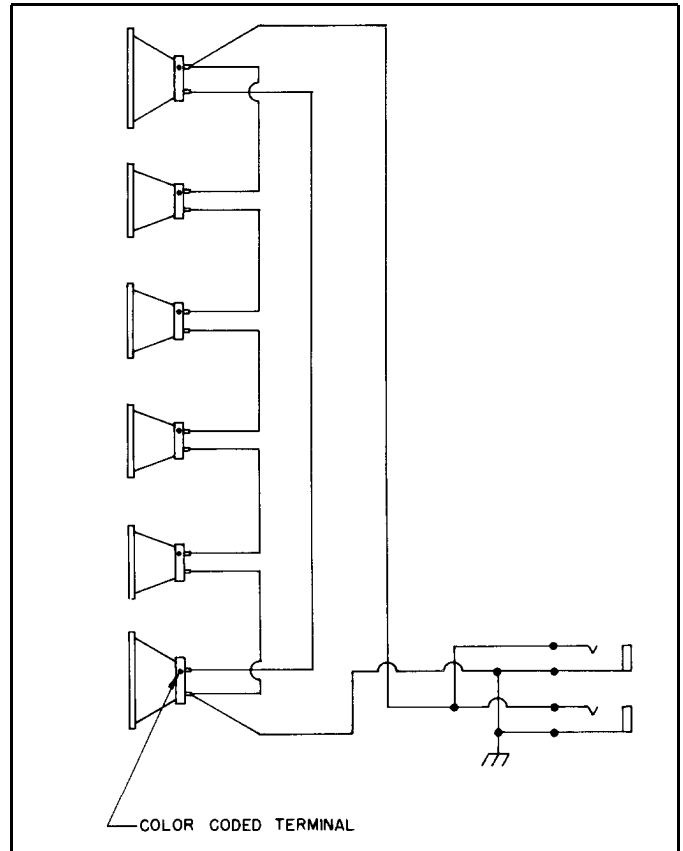

Figure 15

REPLACEMENT PARTS LIST FOR VA300-S SPEAKER COLUMN

ITEM	REP. KIT NO.	REPLACEMENT KIT CONSISTS OF		
		QTY.	PART NO.	DESCRIPTION
M10	RKC29	1	80A207	8 Inch Loudspeaker
M11	RKC56	1	80A208	10 Inch Loudspeaker
M12	RKC31	1	90A1375	Rear Panel Assembly
M13	RKC25	1	94B462	Column Cabinet
M14	RKC4	1	90A1373	Cable and Plug Assembly*
M15	RKC32	1	95A436	Handle Assembly
M16	RKC39	4	65A1001A	Bumper (Plastic Foot)
M17	-	-	39A279	Name Plate
M18	-	-	48A20	Side Rail

*Recommended replacement cable connectors (not available from factory; Switchcraft part numbers given): Straight Locking Plug: #282; Right Angle Locking Plug: #228; Locking Extension Jack (for Extension Cable Assembly): #123.

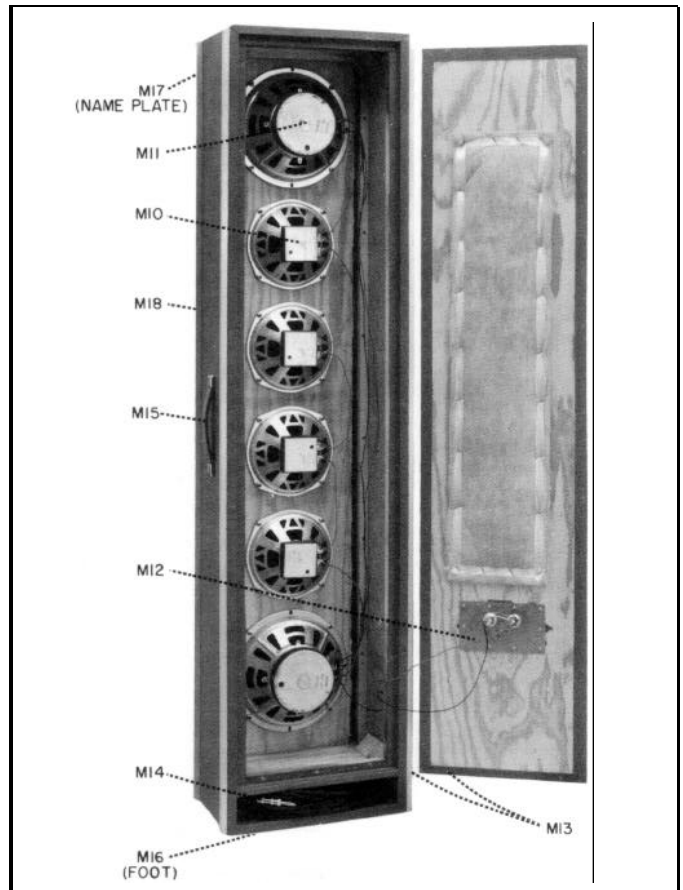

Figure 16

REPLACEMENT PARTS LIST FOR VA300-C CONSOLE

ITEM	** REPL. KIT NO.	REPLACEMENT KIT CONSISTS OF:			COMMERCIAL ALTERNATE
		QTY.	PART NO.	DESCRIPTION	
C1	RKC26	1	86A631	Capacitor, 2500 x 100	NONE
C2	RKC27	1	86B631	Capacitor, 4000 x 60	NONE
D1-D4	RKC46	4	86A406	Silicon Rectifier, 3A., 200V.	Motorola No. 1N4721
D5	RKC22	1	86A408	Zener Diode, 22V., 1 W., 5%	Motorola No. 1N4748A
D6, 7	RKC50	2	86A410	Silicon Rectifier, 100 V. 1/2A	Motorola No. 1N4002
D8, D9	RKC23	1	86A409	Zener Diode, 3.6 V., 1 W., 5%	Motorola No. 1N4729A
F1	} RKC62 {	5	80A159	A.C. Fuse	Littelfuse 3AG/3A/SB (Slo-Blo)
F2		5	80A160	D.C. Fuse	Littelfuse 3AG/5A
F3		-	80A269	Wired-in A.C. Fuse	Bussman MDV/5A/5B (Slo-Blo) Pigtail
I1	RKC45	1	80A79	Pilot Lamp, Thermal Overload	Leecraft No. 36N1311-6
I2, I3	RKC34	2	90A1463	Lamp Assembly, Front Panel	NONE
J1-J7	RKC87	1	95C446	Phone Jack	Switchcraft No. 12-A
J8	RKC86	1	95A446	Phone Jack	Switchcraft No. 14-B
J9-J12	RKC68	1	95B446	Phone Jack	Switchcraft No. 11
M1	RKC82	1	95A510	3-Wire A.C. Line Cord and Grounding Plug	NONE
M2	RKC39	4	65A685	Bumper (Plastic Foot)	
M3	RKC30	1	95A430	Reverberation Assembly	Gibbs No. 4L (Insulated Output)
M4	RKC36	1	95A444	Antifeedback Inductor Assembly	NONE
M5	RKC32	1	90BD2600	Handle Assembly	NONE
M6	RKC24	1	90A1370	Console Cabinet	NONE
M7	RKC49	3	9082285	Volume Control Knob Assembly	NONE
M8	} RKC48 {	3	90B1391	Treble Control Knob Assembly	NONE
M9		3	65A686A	Bass Control Knob	NONE
M10, M11		- - -	-	95A429	Fuse Holder
M12	RKC70	1	32A627	Knob and Screw (Line Cord Storage Spindle)	NONE
M13	- - -	-	48A21	Cabinet Upper Side Rail	NONE
M14	- - -	-	48A22	Cabinet Lower Side Rail	NONE
Q1-Q23, Q25-Q31	RKC9	4	86A349	Transistor (Replaces 86A327)	Motorola No. MPS-6521 Texas Inst. No. 2N3711
Q24	RKC52	3	86A324	Transistor	Motorola No. MPS-3392
Q32	RKC53	1	86A333	Transistor 110 V. BVCEO Min	RCA No. 40349
Q33	RKC55	1	86A338	Transistor 110 V. BVCEO Min.	RCA No. 2N3441
Q34	RKC54	1	86A339	Transistor 105 V. BVCEO Min.	Motorola No. 2N3741 Selected
Q35-Q38	- - -	-	86B339	(Mutually Interchangeable)	
			86A332*	Transistor 110 V. BVCEO Min.,	RCA No. 2N3773
R1-R6, R14	RKC58	1	46A017	Potentiometer, Dual 50K/50K	NONE
R7-R12, R16	RKC59	1	46A016	Potentiometer, 50K.	NONE
R13	RKC57	1	46A018	Potentiometer, 50K.	NONE
R15	RKC60	1	46A020	Potentiometer, 2.5K.	NONE
R17, R18, R19, R21	- - -	-	45EC439B	Resistor, .43 ohms, 5 W.	NONE
R20	- - -	-	45EC209B	Resistor, .20 ohms, 5 W.	NONE
R22	- - -	-	45EC129B	Resistor, .12 ohms, 5 W.	NONE
R23	RKC47	1	45A38	Resistor	Workman No. FRT-2
S1	RKC61	1	55A72	Toggle Switch	Cutler-Hammer No. 7563K5
S2, S3	RKC37	1	95A551	Thermostat	NONE
S4-S9	RKC10	4	55A54	Slide Switch (Screw Slot)	Continental-Wirt No. G-326
S10-S16	RKC44†	1	55A73A†	Rocker Switch, Chrome	NONE
S17	RKC43	1	55A73E	Rocker Switch, Red/Orange	NONE
S18	RKC42	1	55A73D	Rocker Switch, Orange	NONE
S19	RCK41	1	55A73C	Rocker Switch, Orange/Yellow	NONE
S20	RKC40	1	55A73B	Rocker Switch, Yellow	NONE
T1	RKC35	1	51A215	Power Transformer	NONE
T2	RKC28	1	51A217	Feedback Transformer	NONE

NOTE: The Commercial Alternates shown above are not necessarily equivalents, but may be used in the event that direct factory replacements are not immediately available. To maintain the highest possible performance and reliability, Shure Factory Replacement Parts should be used.

*When ordering 86A332 or 86B332, specify current gain code. See Page 14.

**Parts listed as RKC Kits should be ordered by that kit number. Any orders received for piece parts where RKC Kit number is shown will be shipped in RKC quantities.

†For gray switch, order Part No. 55A73F.

ALTERNATE POWER SUPPLY INCORPORATED IN EARLY PRODUCTION UNITS

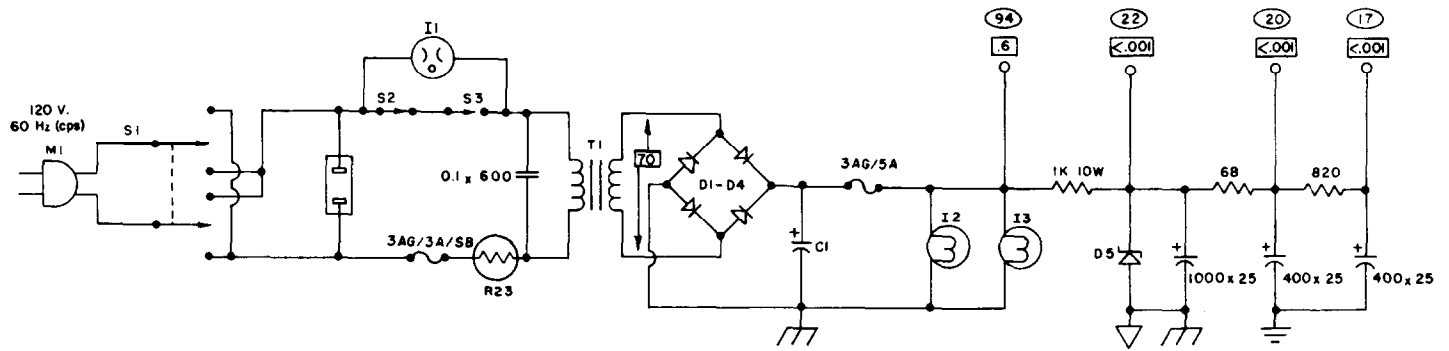



Figure 17

Notes to Circuit Diagram

D.C. Voltage Measurements:

Check the DC voltages first, because any deviation from the nominal voltages will affect the AC voltage. In the power amplifier section, Q31 to Q38, the key DC voltages are +94 (collector of Q33, Q35, and Q37). +22 (collector of Q31), and the split voltage at the junction of R17, R19, R20, and R22. If these three key DC voltages are correct, then proceed with the AC voltage measurements.

The numbers within the symbols  on the circuit diagram denote the D.C. voltage at that point with the following test conditions:

1. Voltages measured at points indicated with respect to chassis, unless otherwise indicated.
2. Line voltage 120v. 60 Hz (cps).
3. No input signal applied.
4. D.C. voltage measurements may vary $\pm 20\%$ from the values shown.
5. Measured with a VTVM of 11-megohms input impedance.
6. Q27 transistor voltages on the circuit diagram are with the master reverb switch in the "IN" position. With the master reverb switch in the "OUT" position, Q27 voltages are: emitter 4.0, base 0.0, and collector 22.0

A.C. Voltage Measurements:

The numbers within the symbols  on the circuit diagram denote the A.C. voltage at that point with the following test conditions:

1. Voltages measured at points indicated with respect to chassis, unless otherwise specified.
2. Line voltage 120v. 60 Hz (cps).
3. 1,000 Hz signal applied to input, in "MIC" position, at 10 millivolts.
4. Measured with an A.C. VTVM of 1.0 megohms or greater input impedance.
5. Noninductive load of 8 ohms, 200 watts connected to speaker output jack for Q31 through Q38.
6. Echo input and output jacks to be open; echo gain control set to maximum.
7. All antifeedback switches set to "OUT" position.
8. Reverb intensity set to minimum.
9. All tone controls set to 12 o'clock position.
10. All volume controls set to maximum.
11. Master reverb switch set to "OUT" position except as noted.
12. Individual channel reverb switches set to "OUT" position except where noted.

13. Transistor voltage measurements for Q20 through Q27 must be made with master reverb switch and individual channel reverb switches in the "IN" position.
14. A.C. voltage measurements may vary $\pm 50\%$ from the values shown.
15. For A.C. measurements on Q25, Q26, and Q27, the frequency may be varied ± 100 Hz. to obtain the A.C. measurements shown.

Ohmmeter Measurements:

With the A.C. line cord unplugged and the power switch in the "OFF" position, the following ohmmeter measurements may be made.

1. Reverberation Assembly M3 input and output coils approximately 180 ohms.
2. Antifeedback Inductors M4 approximately 300 ohms.
3. B+ to ground approximately 50 ohms.
4. Ohmmeter plus probe to the junction of R17, R19, R20, and R22, ohmmeter minus probe to ground: greater than 100 ohms.
5. Ohmmeter plus probe to B+, ohmmeter minus probe to the junction of R17, R19, R20, and R22: greater than 100 ohms.
6. To test transistors and diodes, see page 15.

Shure part numbers are not shown in the parts list accompanying the circuit diagram if parts are readily available through local electronic parts supply distributors. In these instances, the circuit diagram will show the values of the standard parts.

All capacitor values are shown in microfarads. All nonelectrolytic capacitors are to be 100 volts or more unless otherwise specified in the circuit diagram. Electrolytic capacitors are shown in microfarads and volts.

All resistor values are shown in ohms. Resistors are all to be 10% tolerance unless specifically noted on the circuit diagram.

Resistors shown in the upper two lines of circuitry on the diagram are $\frac{1}{4}$ watt unless otherwise specified. Resistors shown in the lower line of circuitry are $\frac{1}{2}$ watt unless otherwise specified.

The following ground symbols denote:

Chassis Ground 

Preamplifier Ground 

Reverb Driver Ground 

VA300-C CIRCUIT DIAGRAM

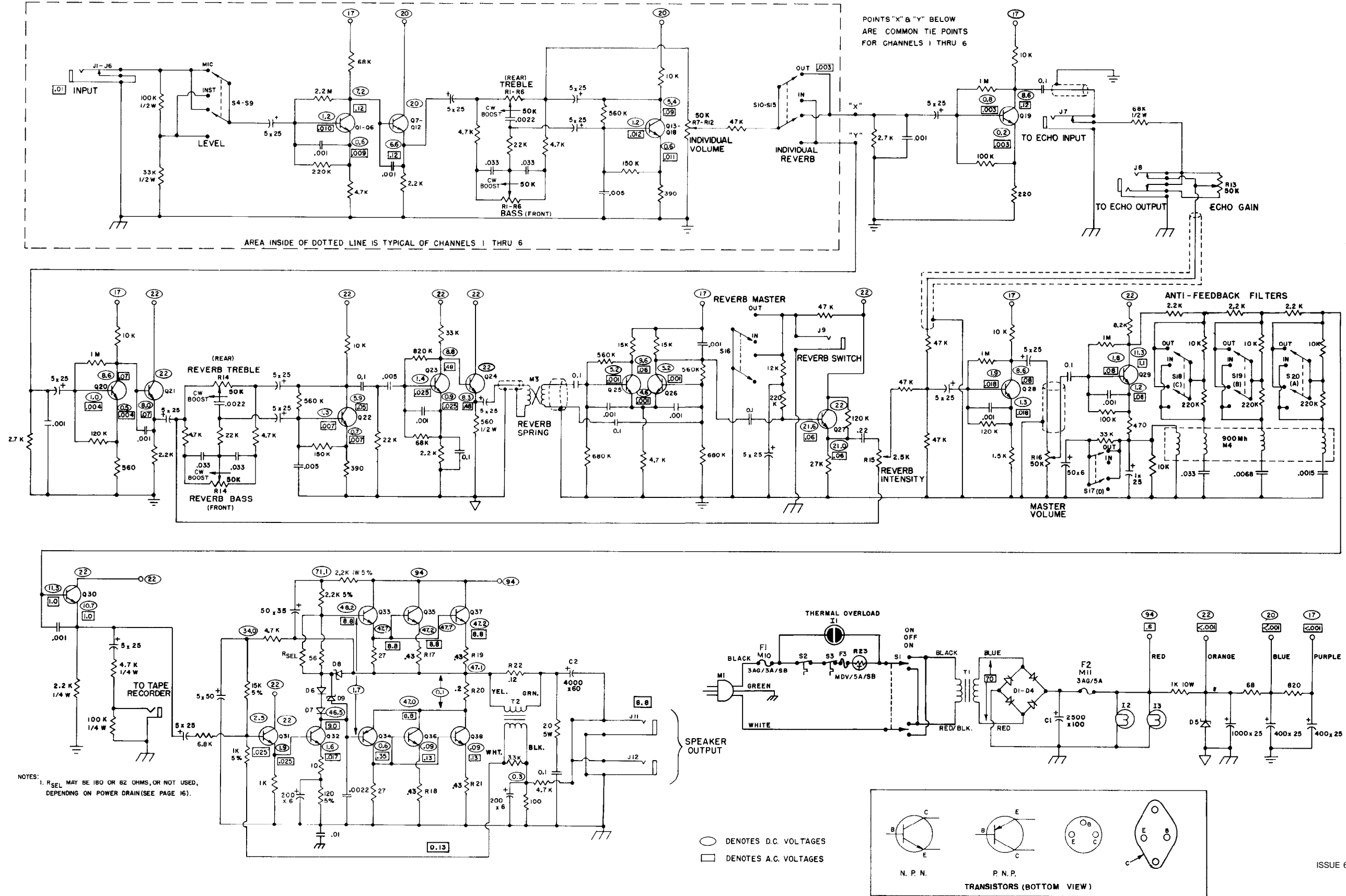

Figure 18

Free Manuals Download Website

<http://myh66.com>

<http://usermanuals.us>

<http://www.somanuals.com>

<http://www.4manuals.cc>

<http://www.manual-lib.com>

<http://www.404manual.com>

<http://www.luxmanual.com>

<http://aubethermostatmanual.com>

Golf course search by state

<http://golfingnear.com>

Email search by domain

<http://emailbydomain.com>

Auto manuals search

<http://auto.somanuals.com>

TV manuals search

<http://tv.somanuals.com>