

INSTRUCTIONS FOR ORDERING

In ordering from this list, use ONLY the PART number in the FIRST column.

The number stamped on a Sewing Machine part is in every case the number of the single part only.

Every combination of parts sent out as such has its specific number, which, although not stamped on the parts, must be used when ordering the combination.

Each number always indicates the SAME PART in whatever list it appears, or for whatever machine.

The letters after some of the numbers indicate the style of finish only, as follows:

- A. Hardened, Polished and Plated.
- B. Polished and Plated.
- C. Hardened only.
- D. Polished only.
- E. Soft, not Polished.
- F. Hardened and Polished.
- G.
- H. Blued.
- J. Plated only.
- K. Hardened and Plated.
- L. Brass or Gilt.
- M. Oxidized.
- P. Japanned.
- R. Parkerized.
- T. Copper-plated.

These letters MUST BE USED when they appear in the list, and AFTER the number as in the list.

In this series:

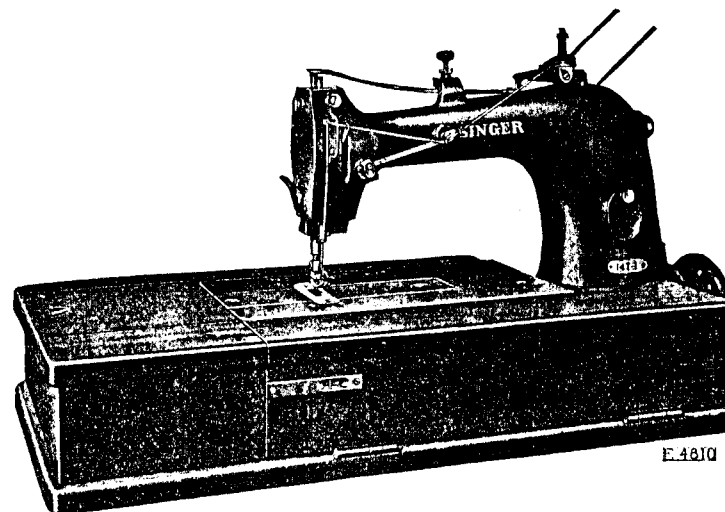
- 1 to 1500 and 50001 to 51500 are Screw Numbers.
- 1501 to 1800 are Nut Numbers.
- 1801 to 2000 are Roller Numbers.
- 2001 to 50000 and 52001 and upward are numbers of Machine Parts.

The figures in the second column refer only to the plates, illustrating the parts, and are NOT TO BE USED in ordering.

Parts marked with an asterisk (*) are furnished only when repairs are made at factory.

LIST OF PARTS COMPLETE

FOR



MACHINE No. 147-1

FOR GENERAL WORK IN FABRICS; ALSO FOR CLOSING LININGS AND STITCHING THE TOP FACING ON SHOES. ONE NEEDLE, ONE LOOPER, FOR TWO-THREAD CHAIN STITCH, FOOT LIFTER.

NO.	PLATE	NAME
*54001	---	Arm, upper and lower (solid) with 948d and 54034.....
42366	8901	Arm Oil Pad (braided cotton) for oiling Arm Rock Shaft Front Bearing.....
56006	8901	Arm Oil Pad (braided cotton) for oiling Arm Rock Shaft Intermediate Bearing
11119	8901	Arm Oil Tube with 29599, for oiling 64321
29599	8901	" " " Packing (felt).....
54002	8902	" Rock Shaft.....
64386	8901	" " " Bushing (back).....
446c	8901	" " " " " Set Screw
64388	8901	" " " " (intermediate).
423c	8901	" " " " " Set Screw.....

NO.	PLATE	NAME
52045	8901	Arm Rock Shaft Bushing Oil Pad (braided cotton).....
54004	8901	Arm Rock Shaft Collar with two 453c....
453c	8901	“ “ “ “ Set Screw.....
54005	8901	“ “ “ Crank (back) with two 50083c.....
50083c	8901	Arm Rock Shaft Crank (back) Set Screw
64255	8911	“ “ “ “ (front) with 453c
2117	8901	“ “ “ “ Pin.....
453c	8901	“ “ “ “ “ Set Screw
54105	8901	“ “ “ Flanged Bushing (front)
52045	8901	“ “ “ “ “ “ Oil Pad (braided cotton).....
453c	8901	Arm Rock Shaft Flanged Bushing (front) Set Screw.....
54006	8903	Arm Rotary Shaft.....
54081	8901	“ “ “ Bushing (front).....
52045	8901	“ “ “ “ “ Oil Pad (braided cotton).....
761E	8901	Arm Rotary Shaft Bushing (front) Set Screw.....
54007	8902	Arm Rotary Shaft Bushing (intermediate)
54089	—	“ “ “ “ “ “ 54007 with 42367 and 64508.....
64508	8902	Arm Rotary Shaft Bushing (intermediate) Oil Pad, long (braided cotton).....
42367	8901	Arm Rotary Shaft Bushing (intermediate) Oil Pad, short (braided cotton).....
422c	8901	Arm Rotary Shaft Bushing (intermediate) Set Screw (long).....
50084c	8901	Arm Rotary Shaft Bushing (intermediate) Set Screw (short).....
54008	8901	Arm Rotary Shaft Collar with two 1258c
1258c	8901	“ “ “ “ Set Screw.....
54009	8902	“ “ “ Flanged Bushing.....
54090	—	“ “ “ “ “ 54009 with 42367 and 58039.....
58039	8902	Arm Rotary Shaft Flanged Bushing Oil Pad, long (braided cotton).....
42367	8901	Arm Rotary Shaft Flanged Bushing Oil Pad, short (braided cotton).....
159F	8901	Arm Rotary Shaft Flanged Bushing Screw
49013	8904	“ “ “ Front Bearing Oil Pad (braided cotton).....
144D	8901	Arm Rotary Shaft Screw.....
15196	8902	“ Side Cover (back).....
286D	8904	“ “ “ “ Thumb Screw....

NO.	PLATE	NAME
54010	8904	Arm Side Cover (front).....
286D	8904	“ “ “ “ Thumb Screw....
64259	8913	Balance Wheel with two 430c.....
430c	8904	“ “ Set Screw.....
54011	8903	Cloth Plate.....
1011F	8904	“ “ Screw (left).....
50473F	8904	“ “ “ (right).....
54012	8902	“ “ Slide (left).....
54013	—	Cloth Plate Slide (left) complete, Nos. 38419, 54012 and two 725J.....
38419	8904	Cloth Plate Slide (left) Spring.....
725J	8904	“ “ “ “ “ Screw....
54014	8913	“ “ “ (right).....
54015	—	Cloth Plate Slide (right) complete, Nos. 38419, 54014 and two 725J.....
38419	8904	Cloth Plate Slide (right) Spring.....
725J	8904	“ “ “ “ “ Screw....
54016	—	Cloth Plate complete, Nos. 54011, 54013 and 54015.....
54104	8913	Cloth Plate Thread Guard.....
1235D	8904	“ “ “ “ Screw.....
54017	8902	Crank Connecting Rod with 6575, 54018, 54218, 54897, 57222 and two each 896E and 1057E.....
50069c	8904	Crank Connecting Rod Ball Screw Stud
1516E	8904	“ “ “ “ “ “ Nut.....
64268	8904	Crank Connecting Rod Ball Screw Stud Washer.....
*57222	—	Crank Connecting Rod Cap (lower)....
896E	8904	“ “ “ “ “ Screw
*54018	—	“ “ “ “ (upper)....
1057E	8904	“ “ “ “ “ Screw
54897	8904	“ “ “ Oil Cup.....
54218	8904	“ “ “ “ Pad (braided cotton).....
6575	8904	Crank Connecting Rod Oil Pad Stop Pin
64269	8913	Face Plate.....
46111	8911	“ “ Pin.....
286D	8904	“ “ Thumb Screw.....
54019	8902	Feed Bar with 50429c and two 453c....
54020	8902	“ “ Connection.....
57225	8904	“ “ Hinge Pin.....
453c	8901	“ “ “ “ Set Screw.....
54111	8902	“ Connecting Rod with 1057E, 54112 and two 896E.....

NO.	PLATE	NAME
*54112	—	Feed Connecting Rod Cap.....
896E	8904	“ “ “ “ Screw.....
1057E	8904	“ “ “ Clamping Screw...
54023	8911	“ “ “ Hinge Pin.....
21506	8904	“ “ “ “ Collar with 457c.....
457c	8904	Feed Connecting Rod Hinge Pin Collar Set Screw.....
54177	8914	Feed Dog, 15 teeth (16 teeth to the inch)
46055	8915	“ “ for shoe linings.....
46180	8915	“ “ to guide the material $\frac{1}{8}$ in. from the needle.....
54179	8914	Feed Dog, 12 teeth (12 teeth to the inch)
54125	8917	“ “ (10 teeth to the inch) for heavy work.....
54126	8917	Feed Dog, for seaming trousers.....
157J	8904	“ “ Screw.....
50429c	8904	“ “ Stop Screw.....
*54024	—	“ Eccentric.....
*23729	—	“ “ Body.....
443c	8904	“ “ “ Set Screw.....
7071	8904	“ “ Clamping Washer.....
217D	8904	“ “ “ “ Screw.
61171	8904	“ “ Pressure Spring.....
21332	8904	“ “ “ “ Cap.....
934J	8904	“ “ “ “ “ Screw
54025	8906	Feed Eccentric (adjustable) complete, Nos. 217D, 934J, 1103c, 7071, 21332, 23729, 54024, 61171 and two 443c....
1103c	8904	Feed Regulating Screw.....
54026	8905	“ Rocking Frame with two 453c....
57234	8911	“ “ “ Hinge Pin.....
57235	8906	“ “ “ “ “ Bushing
453c	8901	“ “ “ “ “ “ Set Screw.....
453c	8901	Feed Rocking Frame Hinge Pin Set Screw.....
53202	8912	Looper.....
53203	—	“ 53202 with 229D and 52661.....
54027	8906	“ Carrier with two 171F.....
171F	8906	“ “ Adjusting Screw.....
54028	8906	“ “ Connection.....
50607J	8906	“ “ “ Oil Plug Screw
54029	8906	“ “ “ Shaft.....
54030	8906	“ “ “ “ Bushing
50608J	8906	“ “ “ “ “ Cap Screw.....

NO.	PLATE	NAME
446c	8901	Looper Carrier Connection Shaft Bushing Set Screw.....
49013	8904	Looper Carrier Connection Shaft Oil Pad (braided cotton).....
54031	8906	Looper Carrier Driver with 54032 and four 391D.....
*54032	—	Looper Carrier Driver Cap.....
391D	8906	“ “ “ “ Screw.....
54033	8907	“ Driving Shaft and Feed Lifting Eccentric with 227D and two 64315...
*54034	8905	Looper Driving Shaft and Feed Lifting Eccentric Bracket with 761E.....
54080	8906	Looper Driving Shaft and Feed Lifting Eccentric Bracket Bushing.....
761E	8901	Looper Driving Shaft and Feed Lifting Eccentric Bracket Bushing Set Screw.
948D	8906	Looper Driving Shaft and Feed Lifting Eccentric Bracket Screw.....
64315	8907	Looper Driving Shaft and Feed Lifting Eccentric Oil Hole Plug.....
227D	8907	Looper Driving Shaft and Feed Lifting Eccentric Oil Hole Screw.....
40326	8907	Looper Driving Shaft and Feed Lifting Eccentric Oil Pad (braided cotton)....
640D	8907	Looper Driving Shaft and Feed Lifting Eccentric Screw.....
54035	8907	Looper Holder with 1120c.....
704J	8907	“ “ Screw.....
52661	8912	“ Needle Guard with 46105.....
46105	8912	“ “ “ Pin.....
229D	8912	“ “ “ Screw.....
1120c	8907	“ Set Screw.....
54036	8912	Needle Bar with 857H.....
38456	8907	“ “ Bushing (lower).....
1133E	8907	“ “ “ “ Set Screw...
64320	8907	“ “ “ (upper).....
1133E	8907	“ “ “ “ Set Screw...
64321	8907	“ “ Connecting Link.....
52992	8907	“ “ “ “ Hinge Stud
1520E	8907	“ “ “ “ “ “ Nut.....
64323	8907	Needle Bar Connecting Stud with 219F and two 399E.....
399E	8907	Needle Bar Connecting Stud Clamping Screw.....
54037	8907	Needle Guard.....
54038	8907	“ “ Holder.....

NO.	PLATE	NAME
176D	8907	Needle Guard Holder Screw
219F	8907	" " Screw.....
857H	8912	" Set Screw.....
44222	—	Oil Cup.....
54122	—	" " 44222 with 54123.....
54123	—	" " Extension.....
44006	8912	" " Packing (felt).....
44224	8912	" " Thread Retainer.....
54124	8912	Oil Cup complete, Nos. 44006, 44224 and 54122.....
54108	—	Oil Tube.....
54109	—	" " Bracket.....
49092	8908	" " Packing (felt).....
54110	8908	Oil Tube complete, for oiling Crank Connecting Rod (upper bearing) Nos. 49092, 54108 and 54109.....
64330	8918	Presser Bar with 25303.....
25303	8907	" " Ball, size ¼ in.....
64331	8911	" " Bushing (lower).....
1133E	8907	" " " " Set Screw...
38456	8907	" " " (upper).....
1133E	8907	" " " " Set Screw...
54039	8908	" " Guide Bracket with 453c, 640j and 1963.....
640j	8907	Presser Bar Guide Bracket Adjusting Screw.....
11173	8908	Presser Bar Guide Bracket Guide.....
447c	8908	" " " " " Set Screw
1963	8908	" " " " Roller and Stud.....
453c	8901	Presser Bar Guide Bracket Set Screw....
57257	8911	" " Lifter.....
57258	8911	" " " Hinge Pin.....
447c	8908	" " " " " Set Screw..
1872	8908	" " " Roller and Stud.....
1250c	8911	" " " Stop Screw.....
61047	8911	" " Lifting Bracket with 460c and 1872.....
64362	8918	Presser Bar Lifting Lever.....
61075	8911	" " " " Connecting Stud.....
460c	8910	Presser Bar Lifting Lever Connecting Stud Set Screw.....
54103	8905	Presser Bar Lifting Lever Extension.....
161D	8908	" " " " " Screw (left).....

NO.	PLATE	NAME
176D	8907	Presser Bar Lifting Lever Extension Screw (right).....
802D	8908	Presser Bar Lifting Lever Hinge Screw..
54040	8905	" " Spring (flat).....
38468	8908	" " Stud.....
7298	8919	" Foot Hinge Pin.....
38469	—	" " Plate.....
38470	—	" " Shank.....
38471	8919	Presser Foot (hinged) complete, Nos. 7298, 38469 and 38470.....
26276	8911	Presser Foot Hinge Pin.....
46056	—	" " Plate.....
46057	—	" " Shank.....
46058	8919	Presser Foot (hinged) complete, Nos. 26276, 46056 and 46057.....
26276	8911	Presser Foot Hinge Pin.....
46076	—	" " Plate.....
46057	—	" " Shank.....
46077	8919	Presser Foot (hinged) complete, for glove work, Nos. 26276, 46057 and 46076...
26276	8911	Presser Foot Hinge Pin.....
46098	—	" " Plate.....
46099	—	" " Shank.....
46100	8915	Presser Foot (hinged) complete for 46055, for drawer finishing, Nos. 26276, 46098 and 46099.....
18055	8919	Presser Foot Hinge Pin.....
46340	—	" " Plate.....
46341	—	" " Shank.....
46342	8919	Presser Foot (hinged) complete, grooved on bottom, for ready folded top facings in long lengths, Nos. 18055, 46340 and 46341.....
18055	8919	Presser Foot Hinge Pin.....
46368	—	" " Plate.....
46341	—	" " Shank.....
46369	8919	Presser Foot (hinged) complete, for plain top facings in long lengths, Nos. 18055, 46341 and 46368.....
26276	8911	Presser Foot Hinge Pin.....
46181	—	" " Plate.....
46182	—	" " Shank.....
46183	8915	Presser Foot (hinged) complete for 46180, Nos. 26276, 46181 and 46182.....
59259	8919	Presser Foot Hinge Pin.....
665D	8916	" " " " Set Screw.....
54174	—	" " Plate.....

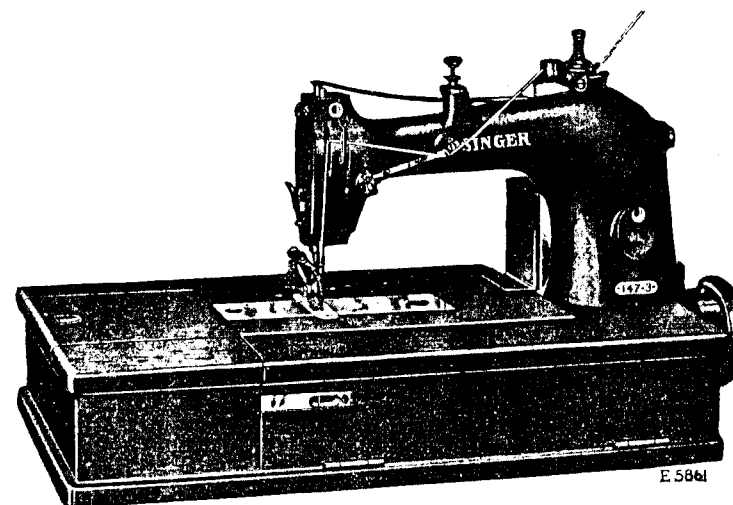
NO.	PLATE	NAME
54175	—	Presser Foot Shank with 665D.....
59262	8919	" " Thread Cutter.....
239D	8919	" " " " Screw.....
54176	8919	Presser Foot (hinged) complete with thread cutter on heel, for glove work, Nos. 239D, 54174, 54175, 59259 and 59262.....
26276	8911	Presser Foot Hinge Pin.....
54127	—	" " Plate.....
46099	—	" " Shank.....
54128	8919	Presser Foot (hinged) complete for 54126, Nos. 26276, 46099 and 54127.....
52555	8919	Presser Foot (solid).....
190D	8908	" " Screw.....
574J	8908	Pressure Regulating Thumb Screw.....
1539J	8908	" " " " Lock Nut.....
64336	8908	Slack Thread Controller.....
46035	8908	" " " " Clamp.....
190D	8908	" " " " Screw...
54041	8921	" " Regulator.....
54042	8908	" " " " Holder with 175E and 50150c.....
175E	8908	Slack Thread Regulator Holder Clamping Screw.....
54043	8908	Slack Thread Regulator Holder Shaft
24292	8908	" " " " " "
		Collar with 1019c.....
1019c	8908	Slack Thread Regulator Holder Shaft Collar Set Screw.....
54044	8908	Slack Thread Regulator Holder Shaft Crank (forked) with 1253c.....
1253c	8908	Slack Thread Regulator Holder Shaft Crank Set Screw.....
50150c	8908	Slack Thread Regulator Set Screw.....
2102	8909	Tension (under thread) Disc.....
1560c	8909	" " " " Regulating Thumb Nut.....
50148c	8909	Tension (under thread) Screw Stud.....
124687	—	" " " " " " 50148c with 1560c.....
42337	8909	Tension (under thread) Spring.....
13915	8909	" " " " Bushing..
17547	8909	" " " " Thread Guide...
54045	8921	" (upper thread) Bracket.....
376D	8909	" " " " Screw...
2102	8909	" " " " Disc.....

NO.	PLATE	NAME
1560c	8909	Tension (upper thread) Regulating Thumb Nut.....
32572	8909	Tension (upper thread) Releasing Disc...
54988	8909	" " " " Pin...
54046	8921	" " " " Shaft
54047	8909	" " " " "
		Crank with 624c.....
54048	8909	Tension (upper thread) Releasing Shaft Crank Link.....
624c	8909	Tension (upper thread) Releasing Shaft Crank Set Screw.....
54990	8909	Tension (upper thread) Releasing Shaft Spring.....
316F	8909	Tension (upper thread) Releasing Shaft Stop Screw.....
1547J	8909	Tension (upper thread) Releasing Shaft Stop Screw Nut.....
50133c	8909	Tension (upper thread) Screw Stud.....
52975	8909	" " " " Spring.....
13915	8909	" " " " Bushing..
17547	8909	" " " " Thread Guide...
38225	8909	Thread (under) Eyelet (back).....
190D	8908	" " " " Screw.....
38284	8909	" " " " (front).....
64351	8909	" " Nipper Cam with 465c...
465c	8909	" " " " Set Screw...
38210	8909	" " " " Spring (lower)...
38211	8909	" " " " (upper)...
46247	8909	" " " " " " Stop
176D	8907	" " " " Screw....
38475	8910	" " " " Take-up with 465c.....
465c	8909	" " " " Set Screw.....
38478	8910	" " " " Staple with two each 590D and 38481.....
54049	8905	Thread (under) Take-up Staple Bracket with 460c.....
965D	8910	Thread (under) Take-up Staple Bracket Screw.....
46041	8909	Thread (under) Take-up Staple Spring
190D	8908	" " " " " "
		Screw.....
38481	8910	Thread (under) Take-up Staple Thread Guard.....
590D	8907	Thread (under) Take-up Staple Thread Guard Screw.....
38482	8910	Thread (under) Take-up Stripper.....
207D	8910	" " " " " " Screw..

NO.	PLATE	NAME
64355	8910	Thread (under) Take-up Thread Guard (brass).....
64356	8910	Thread (under) Take-up Thread Guard Steady Pin.....
460c	8910	Thread (under) Take-up Thread Guard Steady Pin Set Screw.....
54050	8921	Thread (upper) Controller.....
207D	8910	" " " Screw.....
38484	8921	" " Eyelet.....
190D	8908	" " " Screw.....
54051	8921	" " Take-up.....
219F	8907	" " " Set Screw.....
38486	8914	Throat Plate for 54177 and 54179.....
46059	8915	" " " 46055.....
46184	8915	" " " 46180.....
38347	8917	" " " 54125.....
54129	8917	" " " 54126.....
742F	8910	" " " Screw.....

LIST OF PARTS COMPLETE

FOR



MACHINE No. 147-3

FOR CLOSING SHOES. ONE NEEDLE, ONE LOOPER,
ROLLER PRESSER

NO.	PLATE	NAME
*54001	---	Arm, upper and lower (solid) with 948D and 54034.....
42366	8901	Arm Oil Pad (braided cotton) for oiling Arm Rock Shaft Front Bearing.....
56006	8901	Arm Oil Pad (braided cotton) for oiling Arm Rock Shaft Intermediate Bearing
11119	8901	Arm Oil Tube with 29599, for oiling 64321
29599	8901	" " " Packing (felt).....
54002	8902	" Rock Shaft.....
64386	8901	" " " Bushing (back).....
446c	8901	" " " " " Set Screw
64388	8901	" " " " (intermediate) .
423c	8901	" " " " " Set Screw.....
52045	8901	Arm Rock Shaft Bushing Oil Pad (braided cotton).....

NO.	PLATE	NAME
54004	8901	Arm Rock Shaft Collar with two 453c...
453c	8901	" " " " Set Screw.....
54005	8901	" " " Crank (back) with two 50083c.....
50083c	8901	Arm Rock Shaft Crank (back) Set Screw
64255	8911	" " " " (front) with 453c
2117	8901	" " " " " Pin.....
453c	8901	" " " " " Set Screw
54105	8901	" " " Flanged Bushing (front)
52045	8901	" " " " " "
		Oil Pad (braided cotton).....
453c	8901	Arm Rock Shaft Flanged Bushing (front) Set Screw.....
54006	8903	Arm Rotary Shaft.....
54081	8901	" " " Bushing (front).....
52045	8901	" " " " " Oil Pad (braided cotton).....
761E	8901	Arm Rotary Shaft Bushing (front) Set Screw.....
54007	8902	Arm Rotary Shaft Bushing (intermediate)
54089	---	" " " " "
		54007 with 42367 and 64508.....
64508	8902	Arm Rotary Shaft Bushing (intermediate) Oil Pad, long (braided cotton).....
42367	8901	Arm Rotary Shaft Bushing (intermediate) Oil Pad, short (braided cotton).....
422c	8901	Arm Rotary Shaft Bushing (intermediate) Set Screw (long).....
50084c	8901	Arm Rotary Shaft Bushing (intermediate) Set Screw (short).....
54008	8901	Arm Rotary Shaft Collar with two 1258c
1258c	8901	" " " " Set Screw.....
54009	8902	" " " Flanged Bushing.....
54090	---	" " " " " 54009 with 42367 and 58039.....
58039	8902	Arm Rotary Shaft Flanged Bushing Oil Pad, long (braided cotton).....
42367	8901	Arm Rotary Shaft Flanged Bushing Oil Pad, short (braided cotton).....
159F	8901	Arm Rotary Shaft Flanged Bushing Screw
49013	8904	" " " Front Bearing Oil Pad (braided cotton).....
144D	8901	Arm Rotary Shaft Screw.....
15196	8902	" Side Cover (back).....
286D	8904	" " " Thumb Screw....
54010	8904	" " " (front).....
286D	8904	" " " Thumb Screw..

NO.	PLATE	NAME
64259	8913	Balance Wheel with two 430c.....
430c	8904	" " Set Screw.....
54011	8903	Cloth Plate.....
1011F	8904	" " Screw (left).....
50473F	8904	" " " (right).....
54012	8902	" " Slide (left).....
54013	---	Cloth Plate Slide (left) complete, Nos. 38419, 54012 and two 725J.....
38419	8904	Cloth Plate Slide (left) Spring.....
725J	8904	" " " " " Screw.....
54014	8913	" " " (right).....
54015	---	Cloth Plate Slide (right) complete, Nos. 38419, 54014 and two 725J.....
38419	8904	Cloth Plate Slide (right) Spring.....
725J	8904	" " " " " Screw...
54016	---	Cloth Plate complete, Nos. 54011, 54013 and 54015.....
54104	8913	Cloth Plate Thread Guard.....
1235D	8904	" " " " " Screw.....
54017	8902	Crank Connecting Rod with 6575, 54018, 54218, 54897, 57222 and two each 896E and 1057E.....
50069c	8904	Crank Connecting Rod Ball Screw Stud
1516E	8904	" " " " " "
		Nut.....
64268	8904	Crank Connecting Rod Ball Screw Stud Washer.....
*57222	---	Crank Connecting Rod Cap (lower)....
896E	8904	" " " " " Screw
*54018	---	" " " " (upper)....
1057E	8904	" " " " " Screw
54897	8904	" " " Oil Cup.....
54218	8904	" " " Pad (braided cotton).....
6575	8904	Crank Connecting Rod Oil Pad Stop Pin
64269	8913	Face Plate.....
46111	8911	" " Pin.....
286D	8904	" " Thumb Screw.....
54019	8902	Feed Bar with 50429c and two 453c.....
54020	8902	" " Connection.....
57225	8904	" " Hinge Pin.....
453c	8901	" " " " Set Screw.....
54111	8902	" Connecting Rod with 1057E, 54112 and two 896E.....
*54112	---	Feed Connecting Rod Cap.....
896E	8904	" " " " Screw.....
1057E	8904	" " " Clamping Screw...

NO.	PLATE	NAME
54023	8911	Feed Connecting Rod Hinge Pin.....
21506	8904	“ “ “ “ “ Collar with 457c.....
457c	8904	Feed Connecting Rod Hinge Pin Collar Set Screw.....
54178	8916	Feed Dog.....
54177	8914	“ “ 15 teeth (16 teeth to the inch)
54179	8914	“ “ 12 teeth (12 teeth to the inch)
46257	8916	“ “ for closing and facing shoe linings.....
157J	8904	Feed Dog Screw.....
50429c	8904	“ “ Stop Screw.....
*54024	—	“ Eccentric.....
*23729	—	“ “ Body.....
443E	8904	“ “ Set Screw.....
7071	8904	“ “ Clamping Washer.....
217D	8904	“ “ “ “ Screw..
61171	8904	“ “ Pressure Spring.....
21332	8904	“ “ “ “ Cap.....
934J	8904	“ “ “ “ “ Screw....
54025	8906	Feed Eccentric (adjustable) complete, Nos. 217D, 934J, 1103c, 7071, 21332, 23729, 54024, 61171 and two 443c....
1103c	8904	Feed Regulating Screw.....
54026	8905	“ Rocking Frame with two 453c.....
57234	8911	“ “ “ “ Hinge Pin.....
57235	8906	“ “ “ “ “ Bushing
453c	8901	“ “ “ “ “ “ Set Screw.....
453c	8901	Feed Rocking Frame Hinge Pin Set Screw
25876	8912	Guide.....
286D	8904	“ Thumb Screw.....
46066	8911	Looper with 590D and 38393.....
54027	8906	“ Carrier with two 171F.....
171F	8906	“ “ Adjusting Screw.....
54028	8906	“ “ Connection.....
50607J	8906	“ “ “ Oil Plug Screw
54029	8906	“ “ “ Shaft.....
54030	8906	“ “ “ “ “ Bushing
50608J	8906	“ “ “ “ “ “ Cap Screw.....
446c	8901	Looper Carrier Connection Shaft Bushing Set Screw.....
49013	8904	Looper Carrier Connection Shaft Oil Pad (braided cotton).....
54031	8906	Looper Carrier Driver with 54032 and four 391D.....

NO.	PLATE	NAME
*54032	—	Looper Carrier Driver Cap.....
391D	8906	“ “ “ “ Screw.....
54033	8907	“ Driving Shaft and Feed Lifting Eccentric with 227D and two 64315...
*54034	8905	Looper Driving Shaft and Feed Lifting Eccentric Bracket with 761E.....
54080	8906	Looper Driving Shaft and Feed Lifting Eccentric Bracket Bushing.....
761E	8901	Looper Driving Shaft and Feed Lifting Eccentric Bracket Bushing Set Screw..
948D	8906	Looper Driving Shaft and Feed Lifting Eccentric Bracket Screw.....
64315	8907	Looper Driving Shaft and Feed Lifting Eccentric Oil Hole Plug.....
227D	8907	Looper Driving Shaft and Feed Lifting Eccentric Oil Hole Screw.....
40326	8907	Looper Driving Shaft and Feed Lifting Eccentric Oil Pad (braided cotton) ...
640D	8907	Looper Driving Shaft and Feed Lifting Eccentric Screw.....
54035	8907	Looper Holder with 1120c.....
704J	8907	“ “ Screw.....
1120c	8907	“ Set Screw.....
38393	8907	“ Thread Guard.....
590D	8907	“ “ “ Screw.....
54036	8912	Needle Bar with 857H.....
38456	8907	“ “ Bushing (lower).....
1133E	8907	“ “ “ “ Set Screw...
64320	8907	“ “ “ (upper).....
1133E	8907	“ “ “ “ Set Screw...
64321	8907	“ “ Connecting Link.....
52992	8907	“ “ “ “ “ Hinge Stud
1520E	8907	“ “ “ “ “ “ Nut.....
64323	8907	Needle Bar Connecting Stud with 219F and two 399E.....
399E	8907	Needle Bar Connecting Stud Clamping Screw.....
54037	8907	Needle Guard.....
54038	8907	“ “ Holder.....
176D	8907	“ “ “ Screw.....
219F	8907	“ “ Screw.....
857H	8912	“ Set Screw.....
44222	—	Oil Cup.....
54122	—	“ “ 44222 with 54123.....
54123	—	“ “ Extension.....
44006	8912	“ “ Packing (felt).....

NO.	PLATE	NAME
44224	8912	Oil Cup Thread Retainer.....
54124	8912	Oil Cup complete, Nos. 44006, 44224 and 54122.....
54108	—	Oil Tube.....
54109	—	“ “ Bracket.....
49092	8908	“ “ Packing (felt).....
54110	8908	Oil Tube complete, for oiling Crank Connecting Rod (upper bearing) Nos. 49092, 54108 and 54109.....
57255	8908	Presser Bar with 25303.....
25303	8907	“ “ Ball, size ¼ in.....
61046	8908	“ “ Bushing (lower).....
1133E	8907	“ “ “ “ Set Screw....
38456	8907	“ “ “ (upper).....
1133E	8907	“ “ “ “ Set Screw....
54039	8908	“ “ Guide Bracket with 453c, 640j and 1963.....
640j	8907	Presser Bar Guide Bracket Adjusting Screw.....
11173	8908	Presser Bar Guide Bracket Guide.....
447c	8908	“ “ “ “ “ Set Screw
1963	8908	“ “ “ “ Roller and Stud.....
453c	8901	Presser Bar Guide Bracket Set Screw....
57257	8911	“ “ Lifter.....
57258	8911	“ “ “ Hinge Pin.....
447c	8908	“ “ “ “ “ Set Screw....
1872	8908	“ “ “ Roller and Stud.....
1250c	8911	“ “ “ Stop Screw.....
61047	8911	“ “ Lifting Bracket with 460c and 1872.....
64362	8918	Presser Bar Lifting Lever.....
61075	8911	“ “ “ “ Connecting Stud
460c	8910	“ “ “ “ “ “ “ Set Screw.....
54103	8905	Presser Bar Lifting Lever Extension.....
161D	8908	“ “ “ “ “ Screw (left).....
176D	8907	Presser Bar Lifting Lever Extension Screw (right).....
802D	8908	Presser Bar Lifting Lever Hinge Screw....
54040	8905	“ “ Spring (flat).....
38468	8908	“ “ “ Stud.....
7298	8919	“ Foot Hinge Pin.....
38047	—	“ “ Plate.....
38010	—	“ “ Shank.....

NO.	PLATE	NAME
38048	8914	Presser Foot (hinged) complete for 54177 and 54179, Nos. 7298, 38010 and 38047
190D	8908	Presser Foot Screw.....
574J	8908	Pressure Regulating Thumb Screw.....
1539J	8908	“ “ “ “ Lock Nut.....
1923	8920	Roller, 1¼ in. diam., coarse, with 652D and 1528J, for 38012.....
1985	8920	Roller, ⅞ in. diam., coarse, with 652D and 1528J, for 54181.....
53224	8920	Roller Arm for 38012.....
54180	8920	“ “ “ 54181.....
440F	8920	“ “ Adjusting Screw.....
1547J	8909	“ “ “ “ Nut.....
46037	8920	“ “ Bracket for 38012.....
2206	8920	“ “ “ “ 54181.....
316F	8909	“ “ “ Screw Centre.....
1547J	8909	“ “ “ “ Nut....
2205	8920	“ “ Lock Spring.....
176D	8907	“ “ “ “ Screw.....
1549J	8920	“ “ “ “ “ Nut.....
652D	8920	“ Screw.....
1528J	8920	“ “ Nut.....
38012	8920	Roller Presser complete, 1¼ in. coarse roller, for 54178, Nos. 176D, 440F, 1549J, 1923, 2205, 46037, 53224, two 316F and three 1547J.....
54181	8920	Roller Presser complete, ⅞ in. coarse roller, Nos. 176D, 440F, 1549J, 1985, 2205, 2206, 54180, two 316F and three 1547J.....
190D	8908	Roller Presser Screw.....
64336	8908	Slack Thread Controller.....
46035	8908	“ “ “ Clamp.....
190D	8908	“ “ “ “ Screw....
54041	8921	“ “ Regulator.....
54042	8908	“ “ “ “ Holder with 175E and 50150c.....
175E	8908	Slack Thread Regulator Holder Clamping Screw.....
54043	8908	Slack Thread Regulator Holder Shaft
24292	8908	“ “ “ “ “ “ “ Collar with 1019c.....
1019c	8908	Slack Thread Regulator Holder Shaft Collar Set Screw.....
54044	8908	Slack Thread Regulator Holder Shaft Crank (forked) with 1253c.....

NO.	PLATE	NAME
1253c	8908	Slack Thread Regulator Holder Shaft Crank Set Screw.....
50150c	8908	Slack Thread Regulator Set Screw.....
2102	8909	Tension (under thread) Disc.....
1560c	8909	" " " Regulating Thumb Nut.....
50148c	8909	Tension (under thread) Screw Stud.....
124687	—	" " " " " 50148c with 1560c.....
42337	8909	Tension (under thread) Spring.....
13915	8909	" " " " Bushing..
17547	8909	" " " " Thread Guide....
51045	8921	" (upper thread) Bracket.....
376d	8909	" " " " Screw...
2102	8909	" " " " Disc.....
1560c	8909	" " " " Regulating Thumb Nut.....
32572	8909	Tension (upper thread) Releasing Disc...
54988	8909	" " " " Pin....
51046	8921	" " " " S h a f t
54047	8909	" " " " " "
		Crank with 624c.....
54048	8909	Tension (upper thread) Releasing Shaft Crank Link.....
624c	8909	Tension (upper thread) Releasing Shaft Crank Set Screw.....
54990	8909	Tension (upper thread) Releasing Shaft Spring.....
316r	8909	Tension (upper thread) Releasing Shaft Stop Screw.....
1547j	8909	Tension (upper thread) Releasing Shaft Stop Screw Nut.....
50133c	8909	Tension (upper thread) Screw Stud.....
42336	8921	" " " " Spring.....
13915	8909	" " " " Bushing..
17547	8909	" " " " Thread Guide....
38225	8909	Thread (under) Eyelet (back).....
190b	8908	" " " " Screw.....
38284	8909	" " " " (front).....
64351	8909	" " " " Nipper Cam with 465c...
465c	8909	" " " " Set Screw...
38210	8909	" " " " Spring (lower)...
38211	8909	" " " " (upper)...
46247	8909	" " " " " Stop
176d	8907	" " " " Screw.....
38475	8910	" " " " Take-up with 465c.....
465c	8909	" " " " Set Screw.....

NO.	PLATE	NAME
38478	8910	Thread (under) Take-up Staple with two each 590d and 38481.....
54049	8905	Thread (under) Take-up Staple Bracket with 460c.....
965d	8910	Thread (under) Take-up Staple Bracket Screw.....
46041	8909	Thread (under) Take-up Staple Spring
190d	8908	" " " " " "
		Screw.....
38481	8910	Thread (under) Take-up Staple Thread Guard.....
590d	8907	Thread (under) Take-up Staple Thread Guard Screw.....
38482	8910	Thread (under) Take-up Stripper.....
207d	8910	" " " " Screw..
64355	8910	" " " " Thread Guard (brass).....
64356	8910	Thread (under) Take-up Thread Guard Steady Pin.....
460c	8910	Thread (under) Take-up Thread Guard Steady Pin Set Screw.....
54050	8921	Thread (upper) Controller.....
207d	8910	" " " " Screw.....
38484	8921	" " " " Eyelet.....
190d	8908	" " " " Screw.....
54051	8921	" " " " Take-up.....
219f	8907	" " " " Set Screw.....
46094	8916	Throat Plate with 665d and 46075, for 54178.....
46095	8914	Throat Plate with 665d and 46075, for 54177 and 54179.....
46258	8916	Throat Plate with 665d and 46075, for 46257.....
742f	8910	Throat Plate Screw.....
46075	8916	" " " " Thread Retainer.....
665d	8916	" " " " " " Screw....

IRON BASE

NO.	PLATE	NAME
54091	8939	Machine Base with three each 599E, 6055 and four each 948E and 57285.....
599E	8940	Machine Bolt with 1524E.....
1524E	8040	" " Nut.....
6055	8940	" " " Washer.....
57285	8940	" Cushion (felt).....
948E	8940	" Screw, to fasten machine to base

ACCESSORIES

NO.	PLATE	NAME
120341	8941	Oiler (copper plated) with 120345.....
120345	8941	" Spout, 5 in. long.....
26026	8941	Screw Driver (large).....
26485	8941	" " (small).....
38487	8941	Threading Wire.....
120341	8941	Tweezers (curved).....
8908	8941	Wrench for 1520.....
19221	8941	" " 1516.....
4822	8941	" " 1547.....

BELT GUARD

NO.	PLATE	NAME
54052	8939	Belt Guard with 453c.....
54053	8940	" " Bracket.....
27347	8940	" " Hinge Pin.....
57440	8940	" " " " Collar with 457c..
457c	8904	" " " " " Set Screw..
453c	8901	" " Set Screw.....
430c	8904	" " Stop Screw.....
1520E	8907	" " " " Nut.....
54054	---	Belt Guard complete, Nos. 430c, 1520e, 27347, 54052, 54053, 57440 and wood screw 1/4 in. No. 10.....

BINDER ON SHANK

FOR 147-1 MACHINE

NO.	PLATE	NAME
36198	8943	Binder on Shank.....
36006	8944	" Friction Washer.....
36192	8943	" Hinge Plate.....
1423D	8912	" " " Screw.....
1425D	8944	" " Screw.....
36199	8943	Binder on Shank (hinged) complete, for mattress work, Nos. 1425D, 36006, 36192 and 36198.....
36194	8944	Feed Dog.....
36200	---	Presser Foot Body.....

BINDER ON SHANK

NO.	PLATE	NAME
36201	8944	Presser Foot Tension Plate with 36202...
36202	8944	" " " " Guide Pin....
93H	8944	" " " " Screw.....
2656	8944	" " " " Spring.....
36203	8944	Presser Foot (tension plate) complete, Nos. 93H, 2656, 36200 and 36201.....
36197	8944	Throat Plate for 36194.....
54084	8945	Cloth Plate.....
1011F	8904	" " Screw (left).....
50473F	8904	" " " (right).....
54012	8902	" " Slide (left).....
54013	---	Cloth Plate Slide (left) complete, Nos. 38419, 54012 and two 725J.....
38419	8904	Cloth Plate Slide (left) Spring.....
725J	8904	" " " " " Screw....
54085	8945	" " " (right) with 1602E....
1602E	8910	" " " " Bushing.....
54086	---	Cloth Plate Slide (right) complete, Nos. 54085, two 38419 and four 725J.....
38419	8904	Cloth Plate Slide (right) Spring.....
725J	8904	" " " " " Screw...
54087	---	Cloth Plate complete for 36199, Nos. 54013, 54084 and 54086.....

HEMMER ON SHANK

FOR 147-1 MACHINE

NO.	PLATE	NAME
36194	8944	Feed Dog.....
36191	4858	Hemmer on Shank.....
36006	8944	" Friction Washer.....
36192	4858	" Hinge Plate.....
1423D	8912	" " " Screw.....
1425D	8944	" " Screw.....
36193	4858	Hemmer on Shank (hinged) complete, for towels, Nos. 1425D, 36006, 36191 and 36192.....
26276	8911	Presser Foot Hinge Pin.....
36195	---	" " Plate.....
46057	---	" " Shank.....
36196	8944	Presser Foot (hinged) complete, Nos. 26276, 36195 and 46057.....
36197	8944	Throat Plate for 36194.....
54084	8945	Cloth Plate.....
1011F	8904	" " Screw (left).....
50473F	8904	" " " (right).....
54012	8902	" " Slide (left).....

NO.	PLATE	NAME
54013	—	Cloth Plate Slide (left) complete, Nos. 38419, 54012 and two 725J.....
38419	8904	Cloth Plate Slide (left) Spring.....
725J	8904	" " " " " Screw.....
54085	8915	" " " (right) with 1602E.....
1602E	8910	" " " " Bushing.....
54086	—	Cloth Plate Slide (right) complete, Nos. 54085, two 38419 and four 725J.....
38419	8904	Cloth Plate Slide (right) Spring.....
725J	8904	" " " " " Screw...
54087	—	Cloth Plate complete for 36193, Nos. 54013, 54084 and 54086.....

FOOT LIFTER PARTS

NO.	PLATE	NAME
6439	—	Chain, 36 in. to 45 in., with 56864 and 56865.....

NOTE. When ordering No. 6439 give length required.

4879	8941	Chain Connecting Link.....
56864	8941	" Hook (large).....
56865	8910	" " (small).....
126249	8939	Treadle.....
4882	8941	" Shaft.....
126250	8941	" Spring.....
126251	8939	" Stand.....
126252	8939	Treadle complete, Nos. 4882, 126249 to 126251 and two wood screws 1 in. No. 16.....

KNEE LIFTER PARTS

NO.	PLATE	NAME
37563	—	Chain, length 15 in., with 56864 and 56865.....
56864	8941	Chain Hook (large).....
56865	8910	" " (small).....
2763	8903	Rock Shaft.....
12242	8903	" " Hanger with two wood screws 1 in. No. 10.....
6335	8903	Rock Shaft Knee Arm.....
6336	—	Rock Shaft Knee Arm complete, Nos. 2766, 2767 and 6335.....

NO.	PLATE	NAME
2766	8903	Rock Shaft Knee Arm Hub with 356c...
356c	8910	" " " " " Set Screw....
2767	8903	" " " " " Plate with 356c.....
356c	8910	" " " " " Set Screw.....
6337	8903	" " Lifting Bracket with two 356c
7125	8903	" " " " " Hook.....
356c	8910	" " " " " Set Screw
356c	8910	" " " " " Set Screw....
2770	8903	" " Stop Dog with 356c.....
356c	8910	" " " " " Set Screw.....
23767	8903	Rock Shaft complete, Nos. 2763, 2770, 6336, 6337, 7125 and two 12242.....

BENCH STAND

NO.	PLATE	NAME
79611	—	Bench Stand with 5604, 9370, two 41538, three wood screws 1¼ in. No. 14, four 60656 and sixteen wood screws ½ in. No. 7.....
41538	—	Flush Bolt with Plate complete, Nos. 126247, 126248 and four brass wood screws 5/8 in. No. 4.....
126247	8952	Flush Bolt.....
126248	8952	" " Plate.....
60656	8952	Hinge.....
9370	8952	Slide Spring.....
5604	8952	" " Pin.....

THREAD UNWINDER

FOR TWO SPOOLS

NO.	PLATE	NAME
225395	7233	Spool Rest with 201018c.....
225388	7233	" " Rod.....
200383c	8910	" " " Set Screw.....
201018c	8910	" " " Set Screw.....
202490	7233	" " Stand with 200383c.....
225391	7233	Thread Guide.....
201696J	8910	" " Lock Nut.....
225392	7233	" " Rod with 208E and 225393
208E	8910	" " " Screw.....
225393	8910	" " " Washer.....

THREAD UNWINDER

NO.	PLATE	NAME
225396	7233	Thread Unwinder complete, Nos. 201696j, 202490, 225388, 225392, 225395, two 225391 and three wood screws $\frac{3}{8}$ in. No. 13.....
27739	7234	Thread Cone (wood) for large cones.....
225390	7234	“ “ Holder, for inverted cones..

NOTE. Nos. 27739 and 225390 are used with,
but not included in, 225396.

PLATE 4858—ONE-HALF SIZE

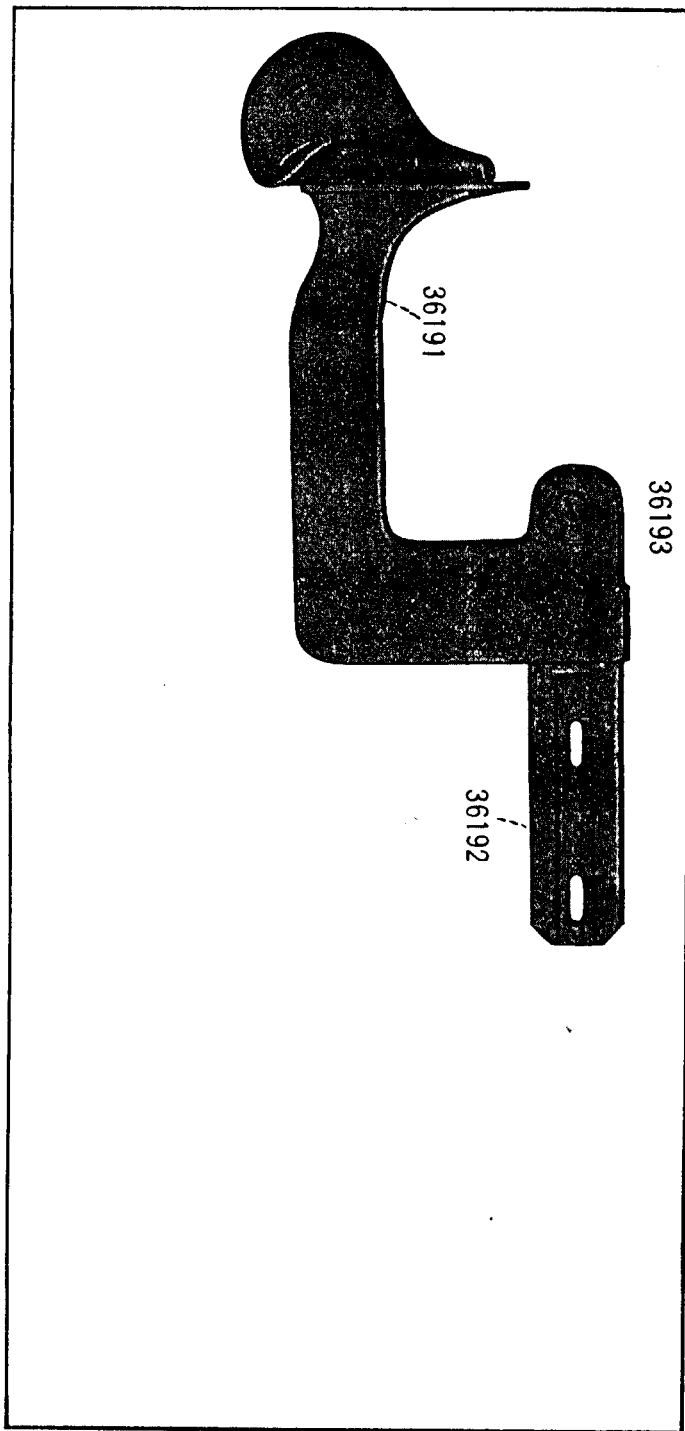


PLATE 7233—ONE-SIXTH SIZE

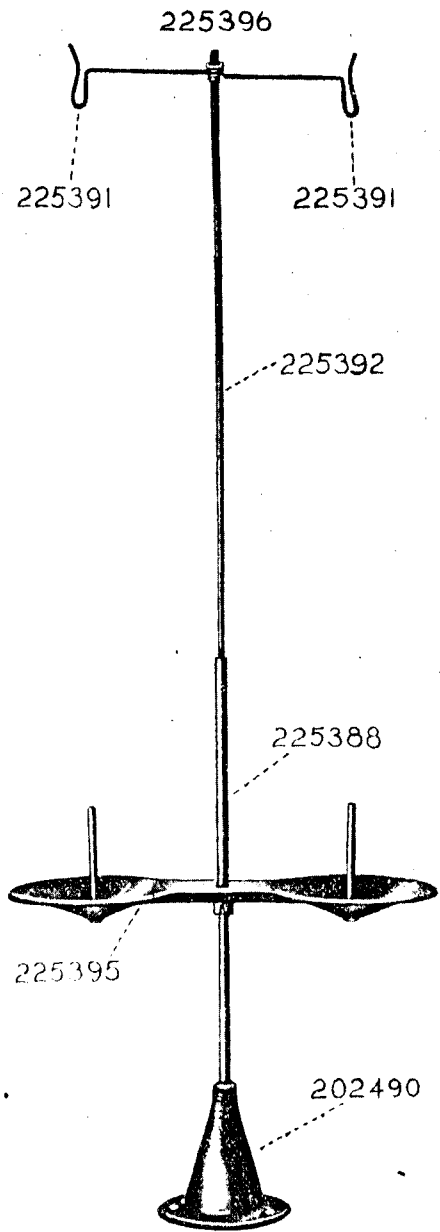


PLATE 7234—ONE-HALF SIZE

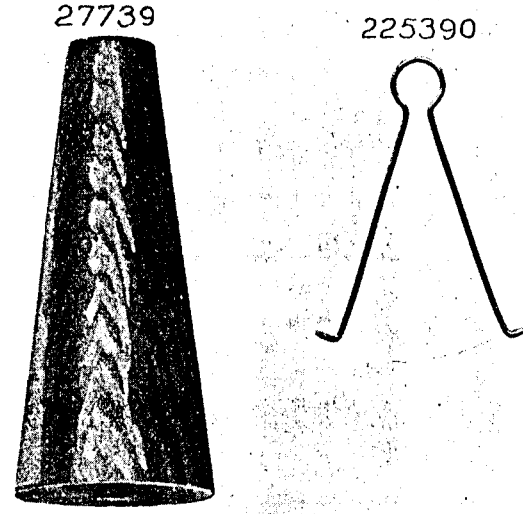


PLATE 8901—FULL SIZE

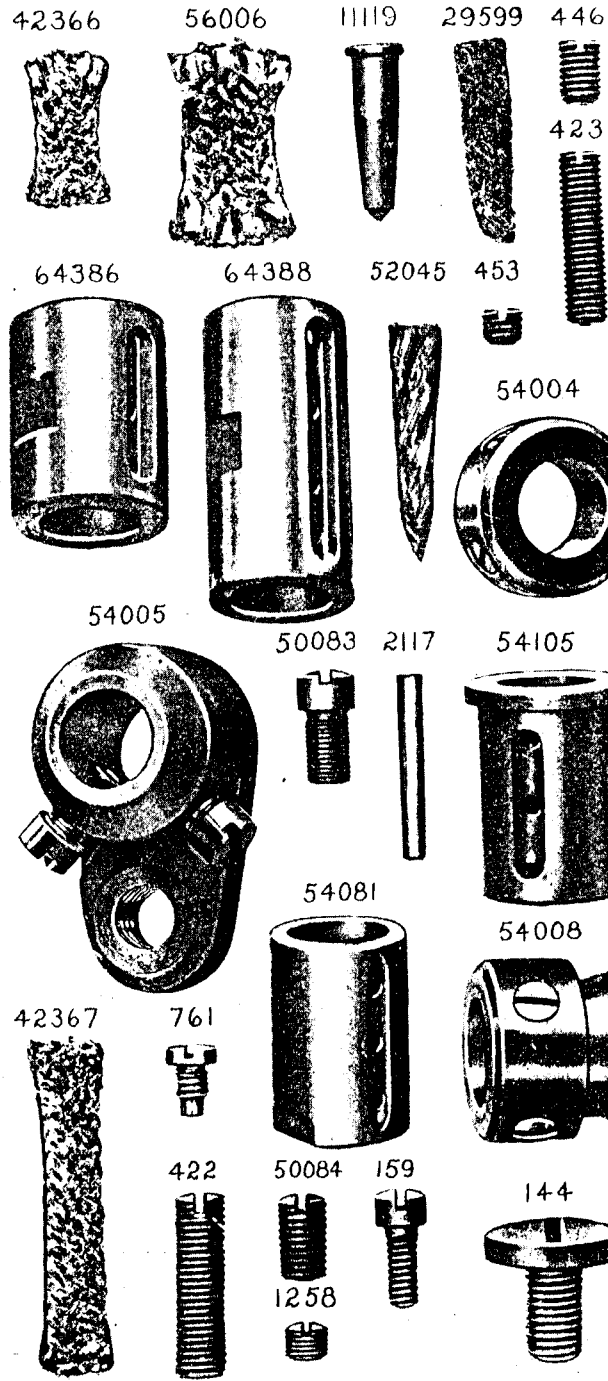


PLATE 8902—ONE-HALF SIZE

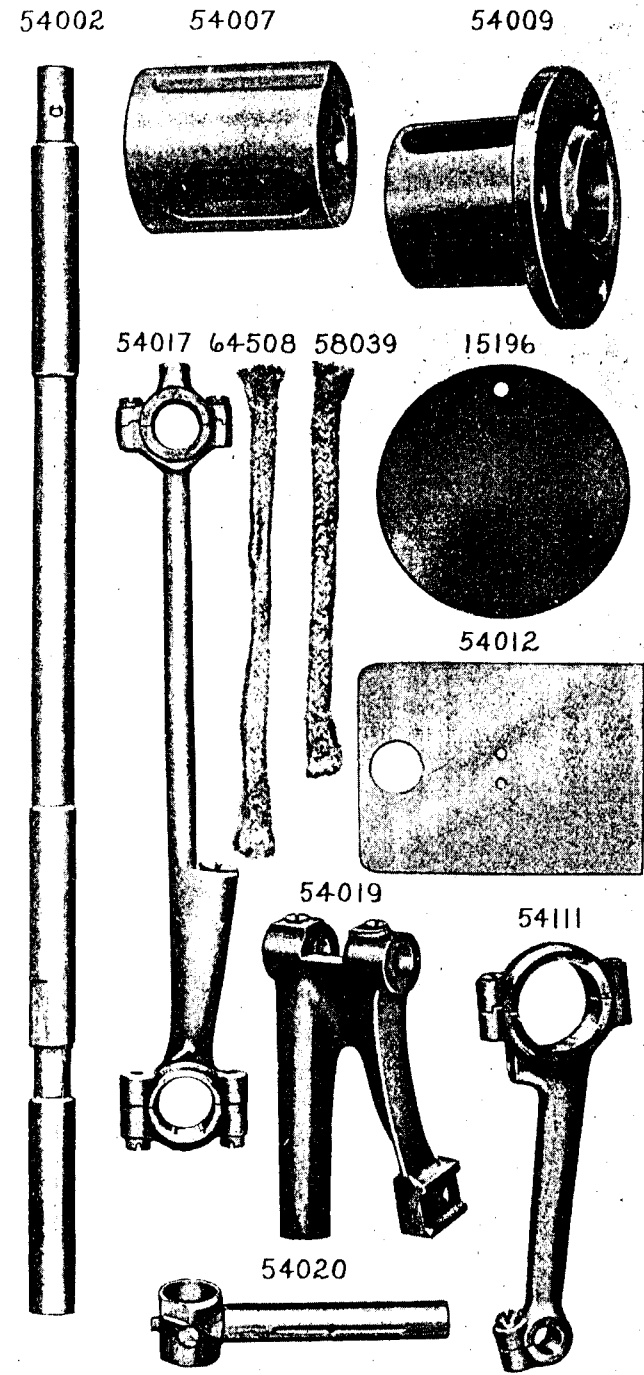
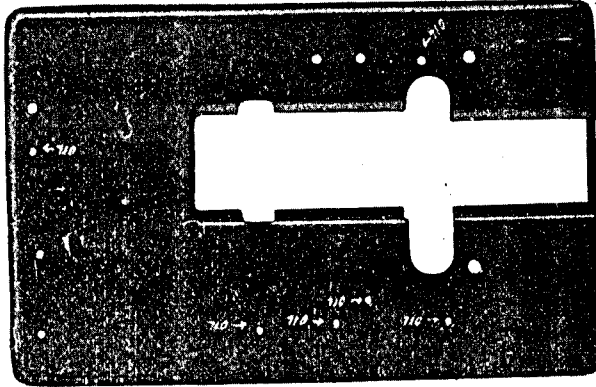


PLATE 8903—ONE-FOURTH SIZE

54011



54006

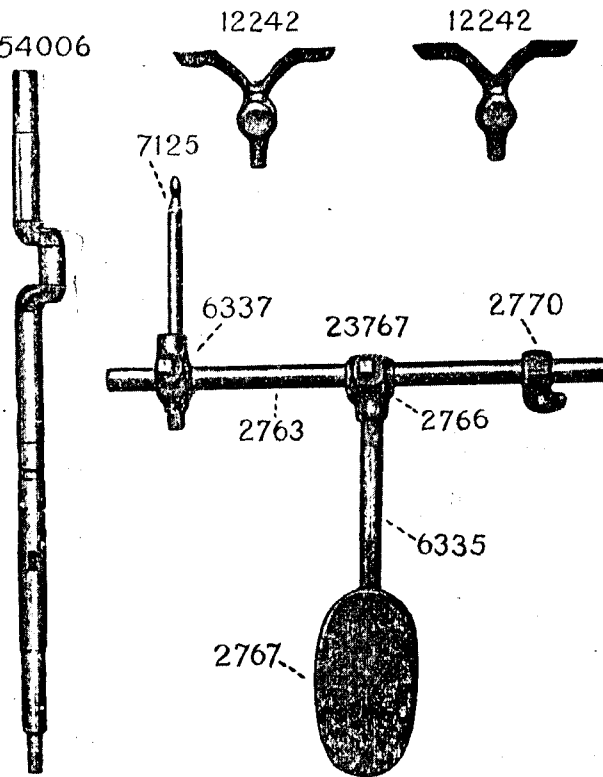


PLATE 8904—FULL SIZE

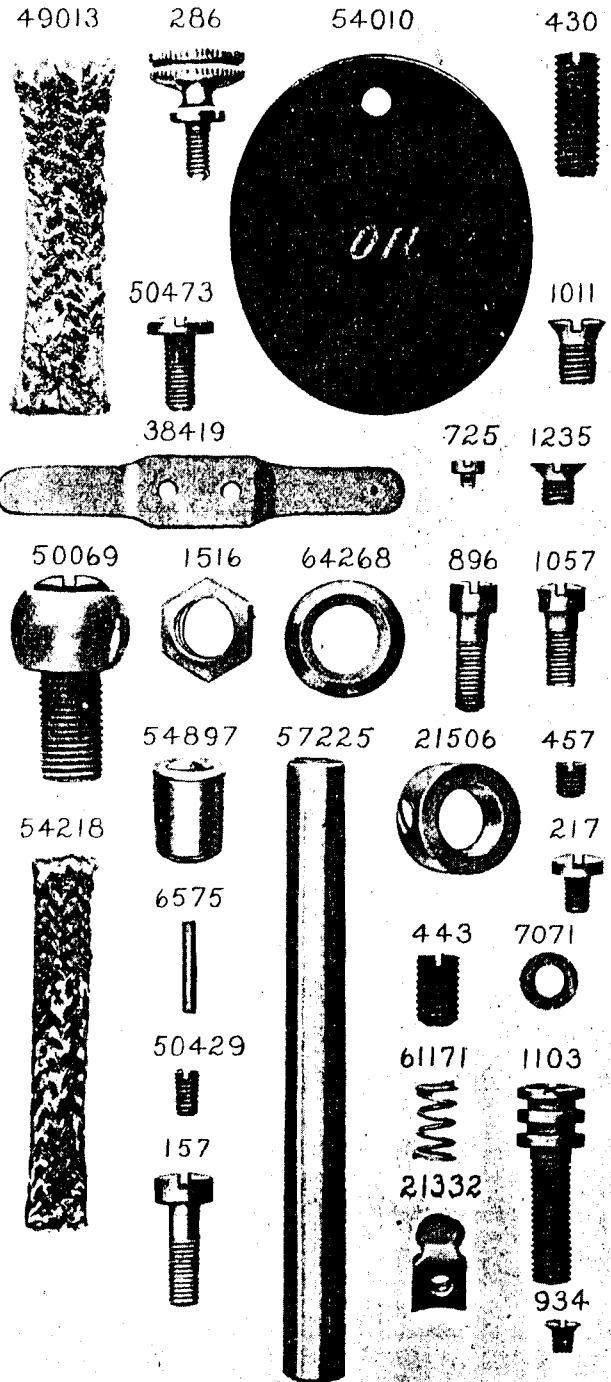


PLATE 8905—ONE-HALF SIZE

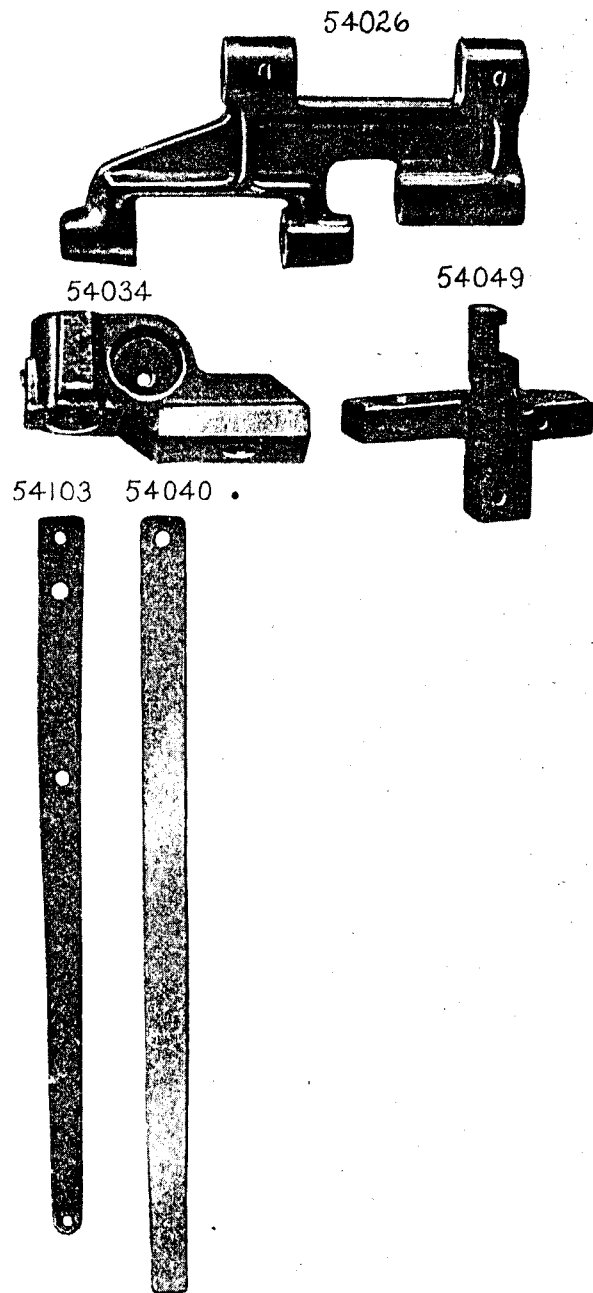


PLATE 8906—FULL SIZE

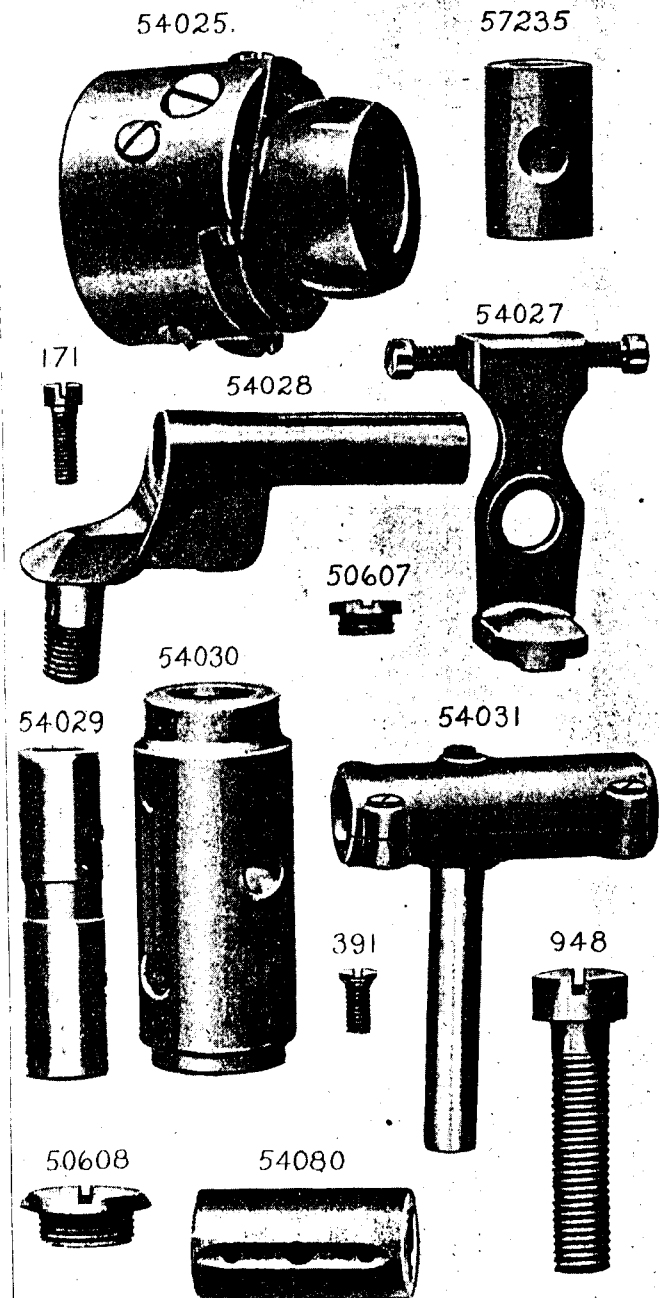


PLATE 8907—FULL SIZE

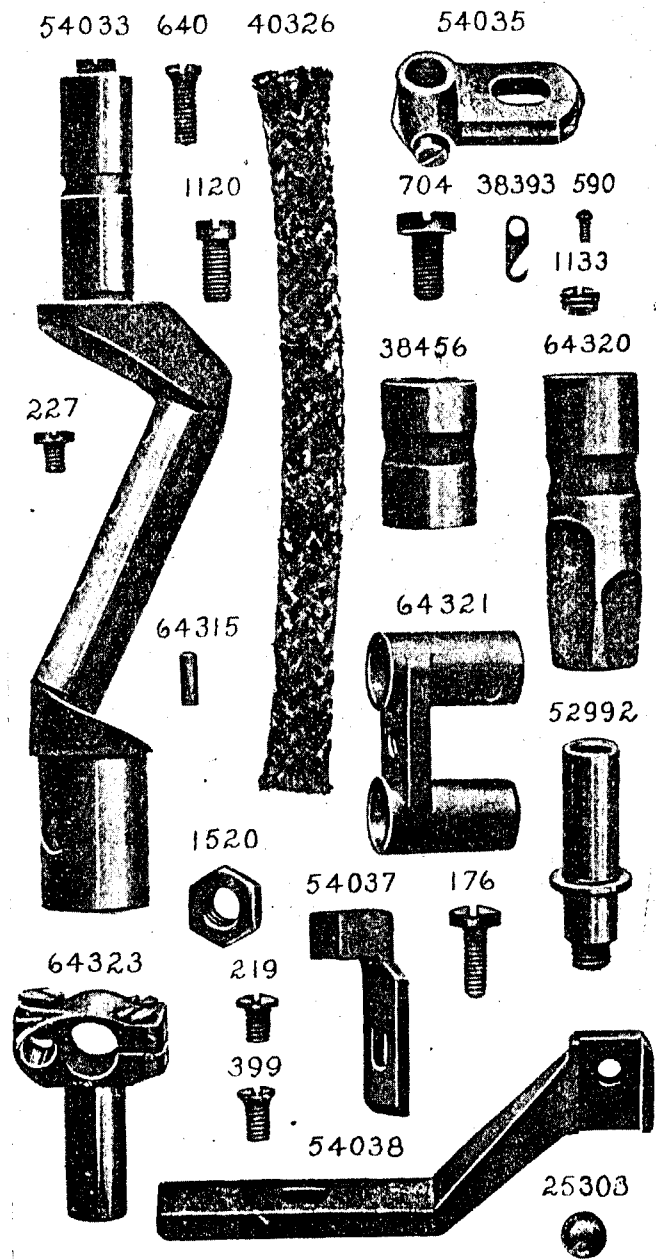


PLATE 8908—FULL SIZE

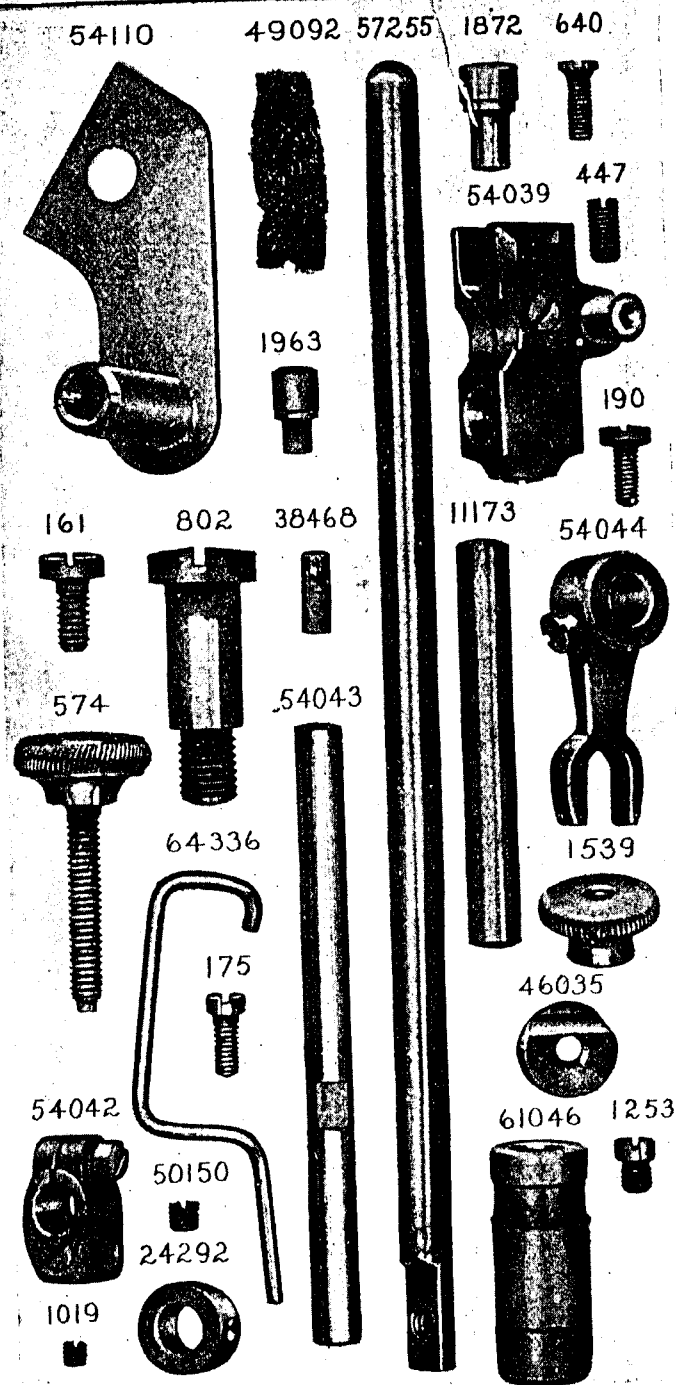


PLATE 8909—FULL SIZE

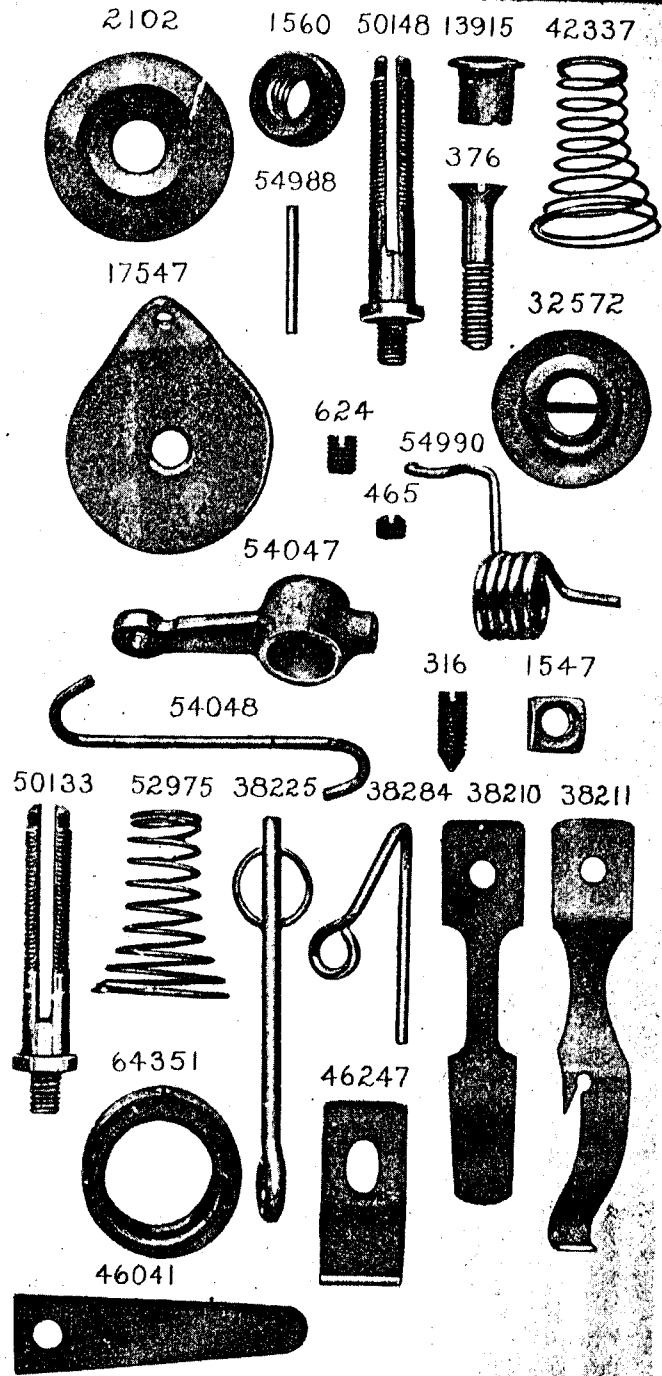


PLATE 8910—FULL SIZE

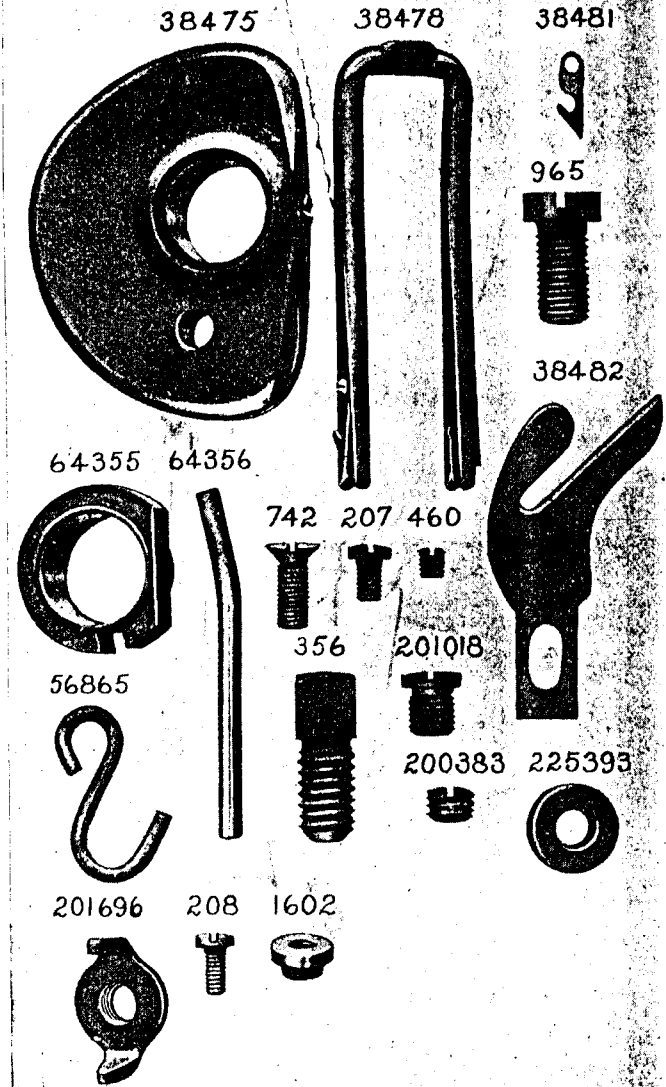


PLATE 8911-FULL SIZE

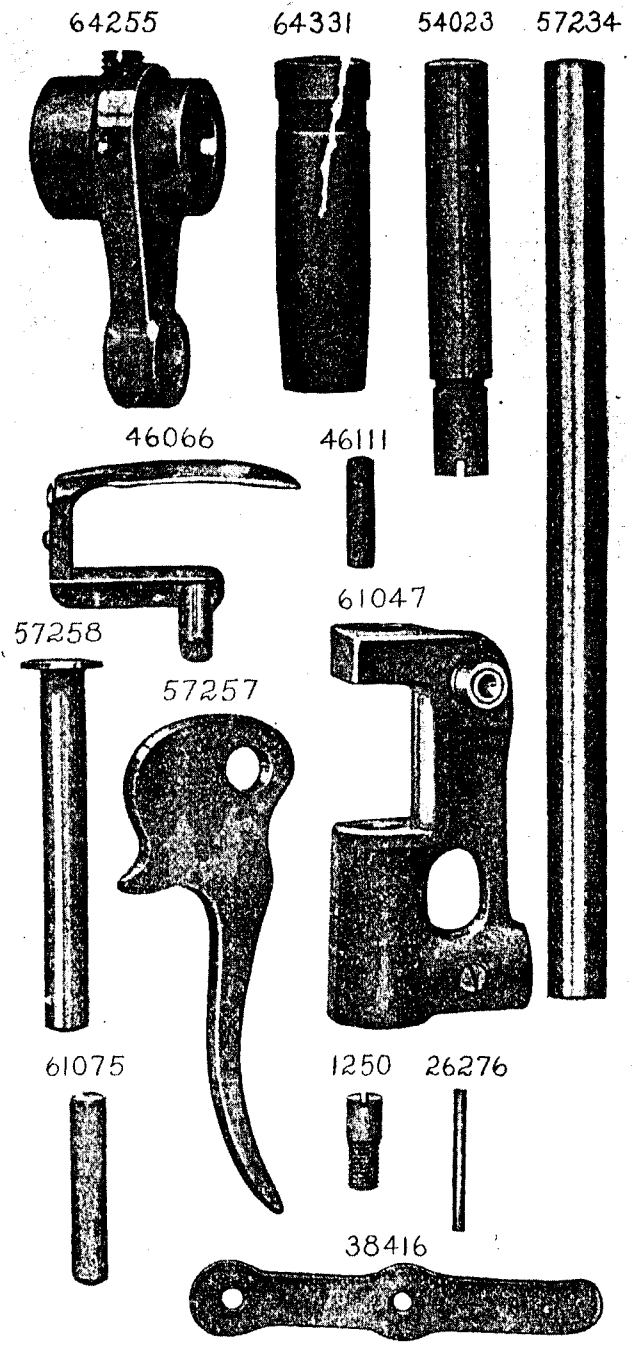


PLATE 8912-FULL SIZE

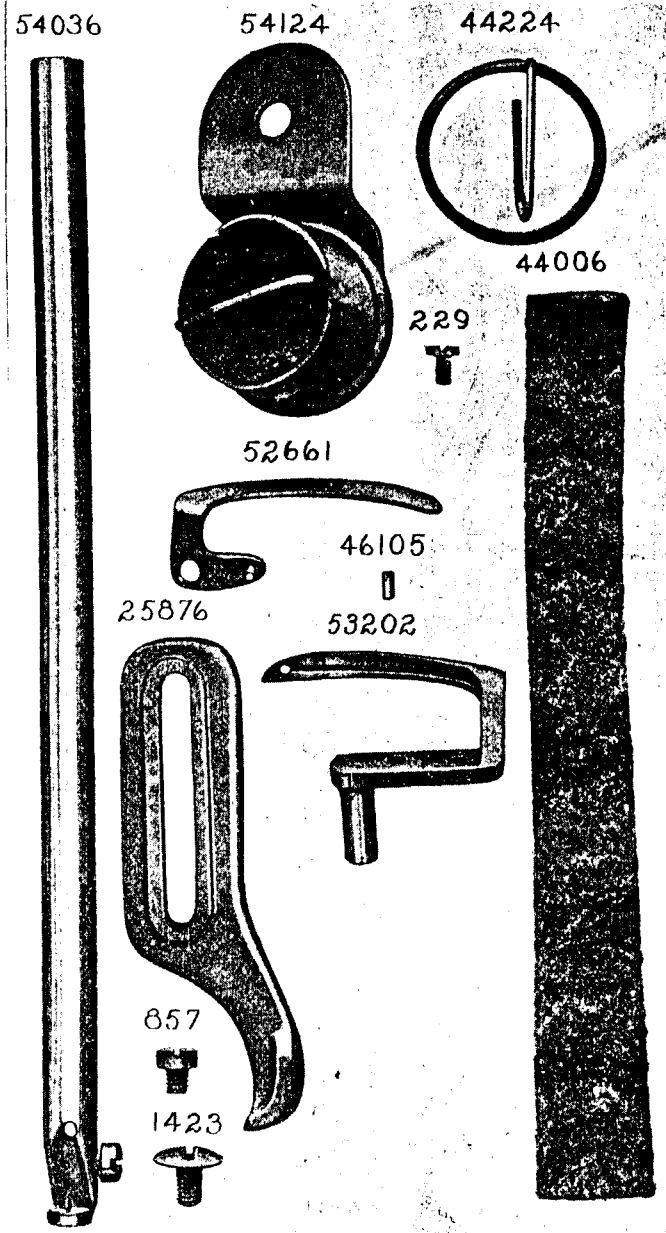
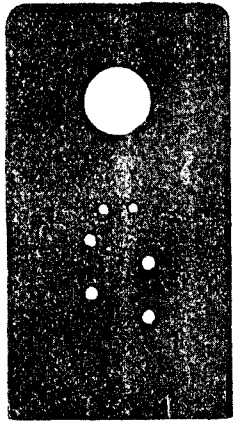
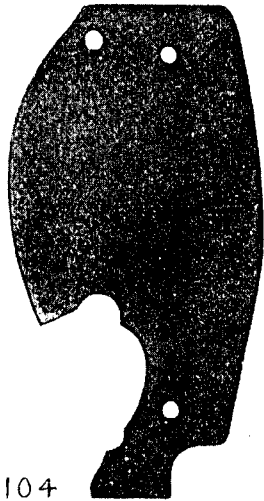


PLATE 8913—ONE-HALF SIZE

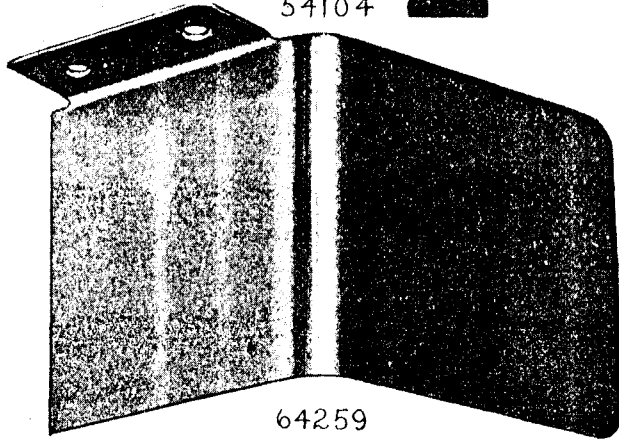
54014



64269



54104



64259

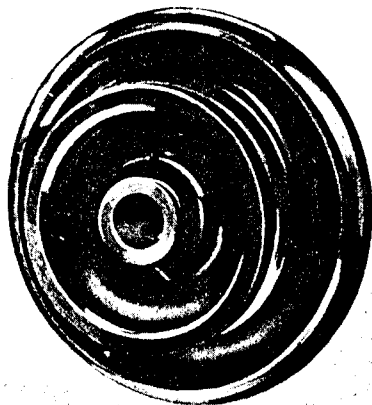


PLATE 8914—FULL SIZE

38486



54179



54177



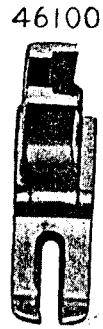
46095



38048



PLATE 8915—FULL SIZE



46184

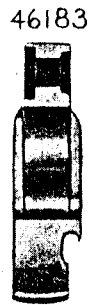
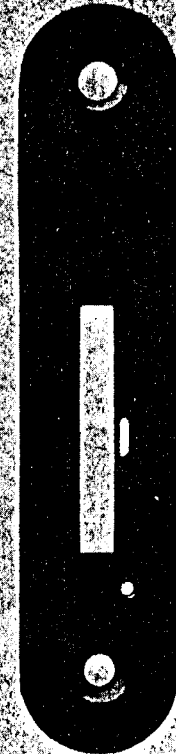


PLATE 8916—FULL SIZE

46258



46094



46075



665



54178

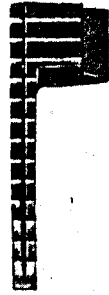


PLATE 8917—FULL SIZE

38347



54125



54129



54126

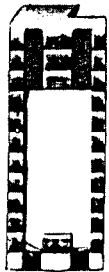


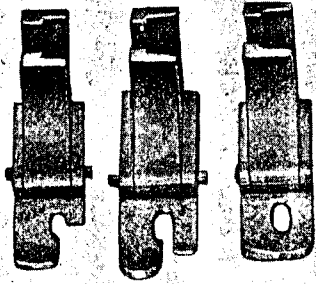
PLATE 8918—ONE-HALF SIZE

64330 64362

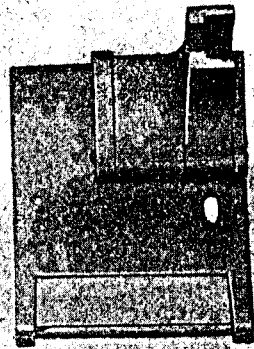


PLATE 8919—FULL SIZE

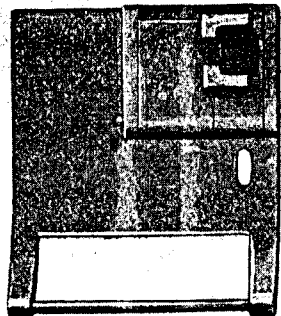
38471 46058 46077



46342



46369



54176



54128



52555



59262



239



59259



7298

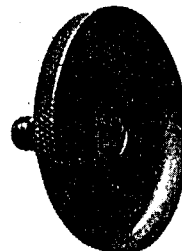


18055



PLATE 8920—FULL SIZE

1923



1985



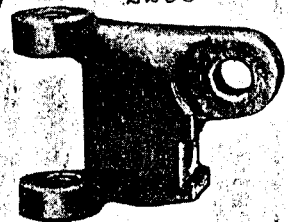
652



1528



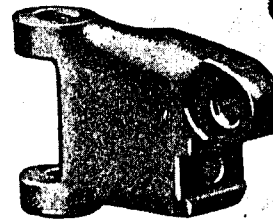
2206



440



46037

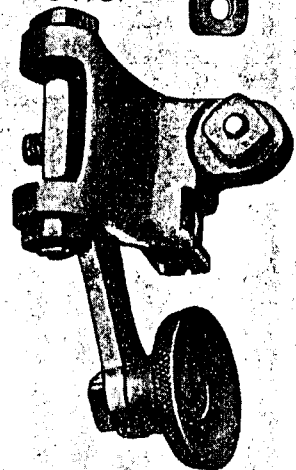
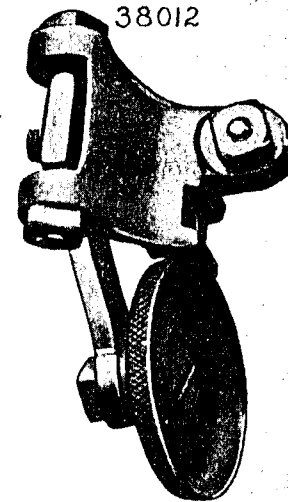


1549

54181



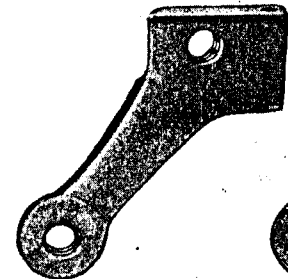
38012



2205



53224



54180

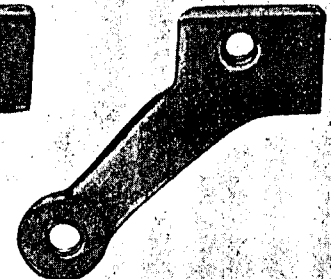
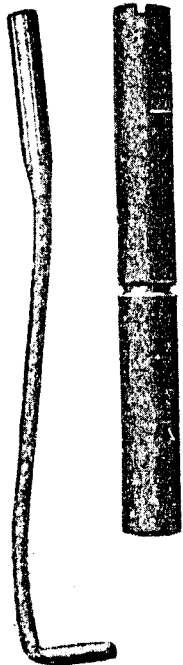
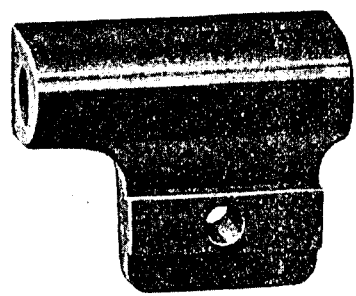


PLATE 8921—FULL SIZE

54041 54046



54045



42336



54050



38484



54051

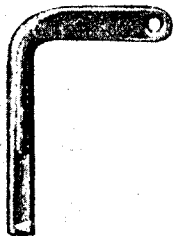
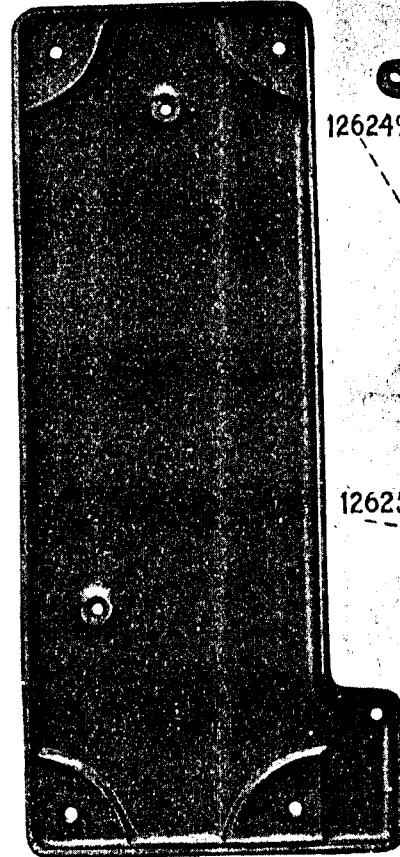


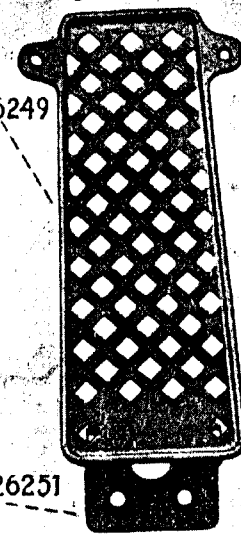
PLATE 8939—ONE-FOURTH SIZE

54091



126252

126249



126251

54052

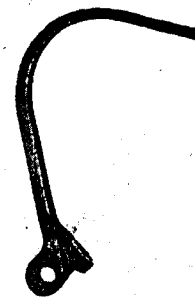


PLATE 8940—FULL SIZE

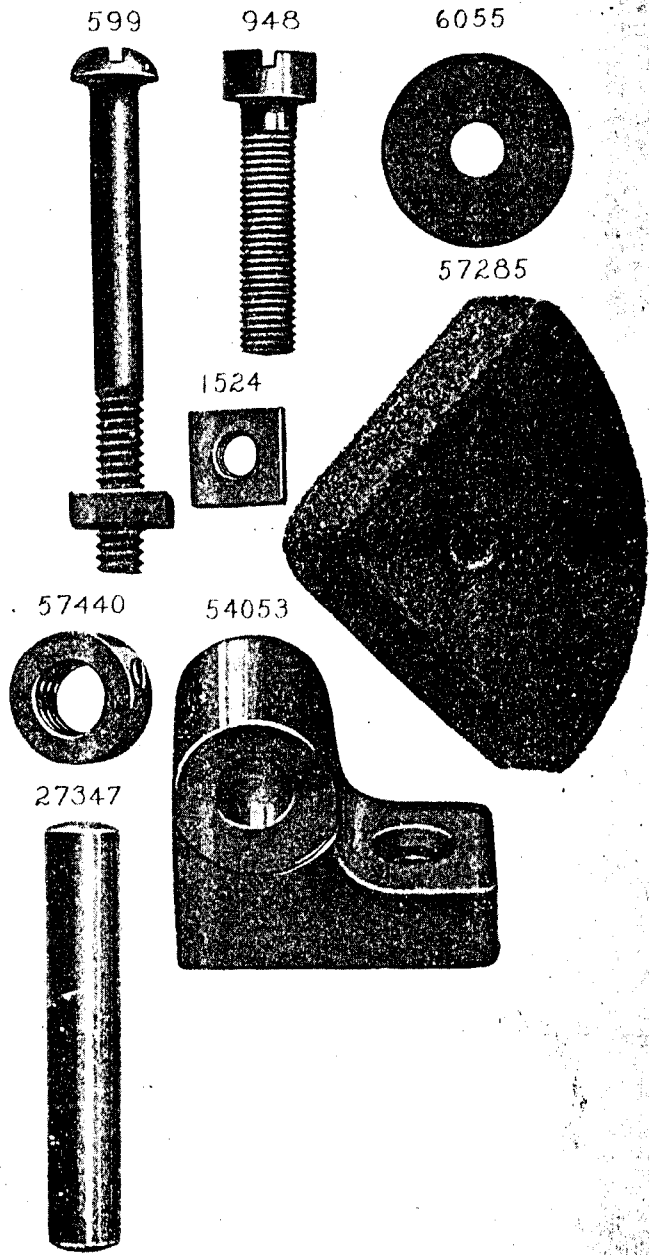


PLATE 8941—ONE-HALF SIZE

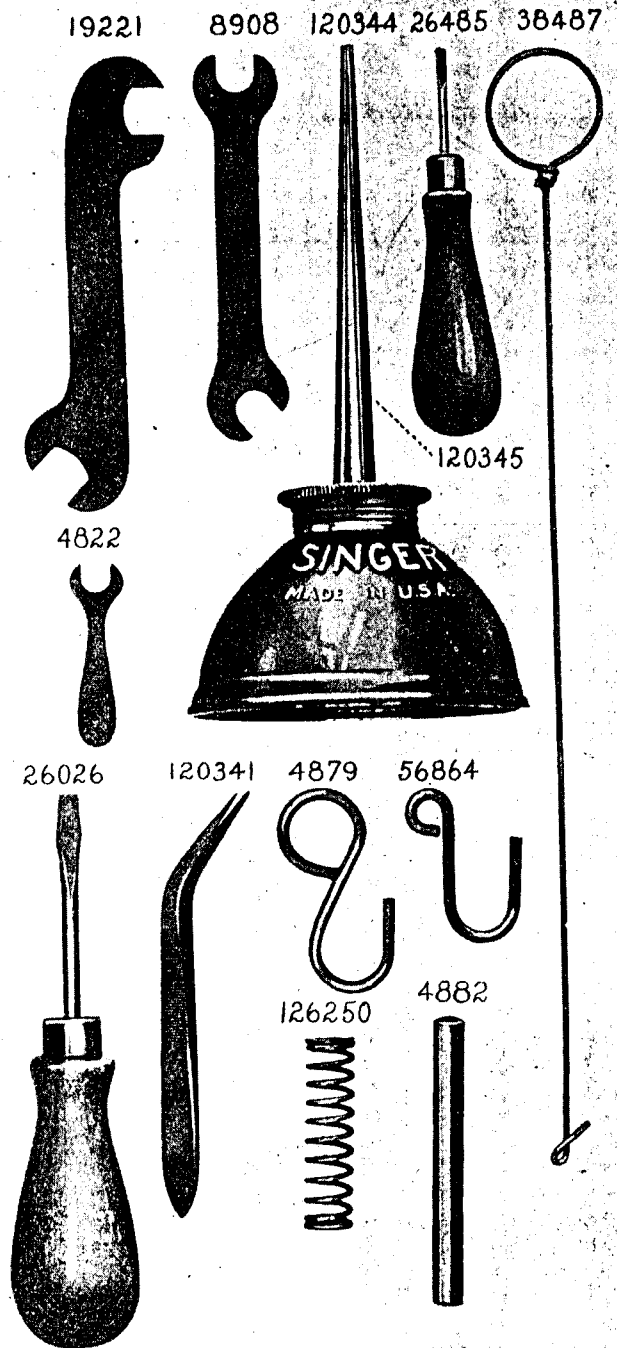


PLATE 8943—ONE-HALF SIZE

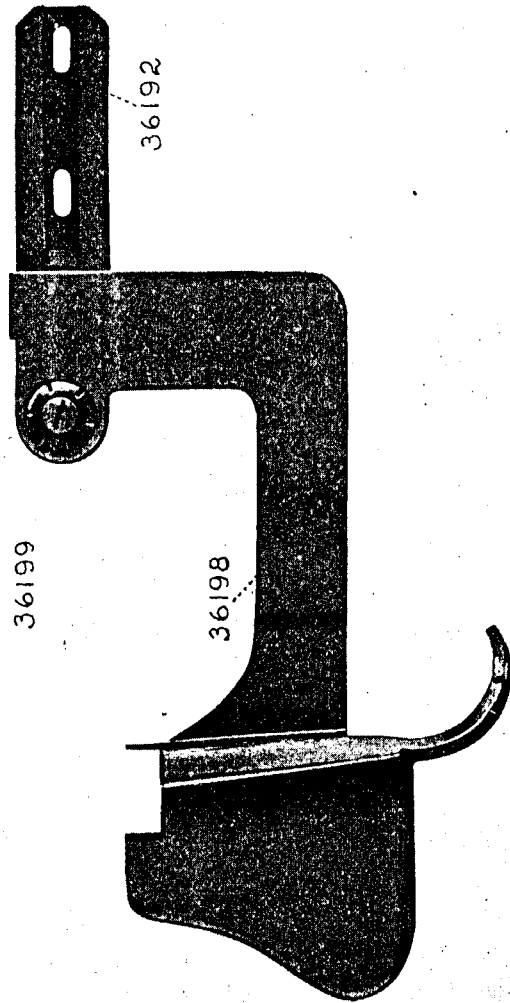


PLATE 8944—FULL SIZE

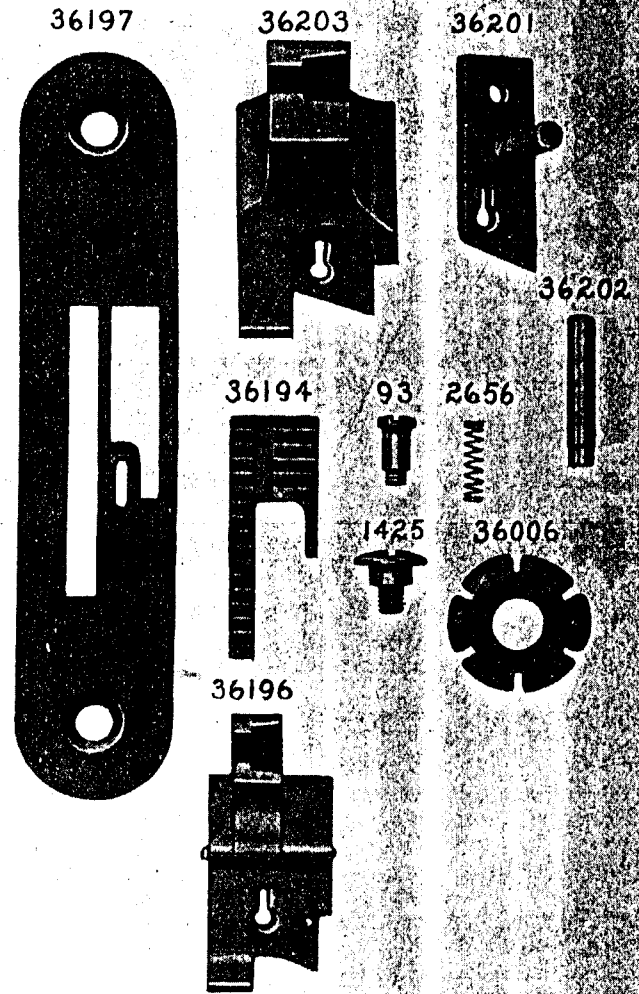
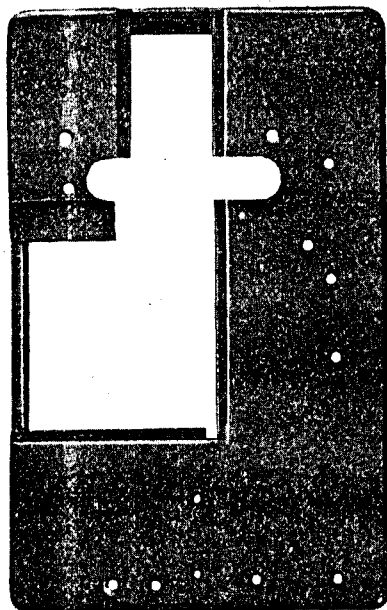


PLATE 8945—ONE-FOURTH SIZE

54084



54085

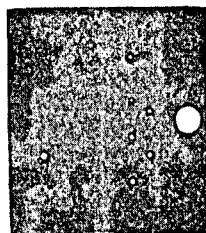
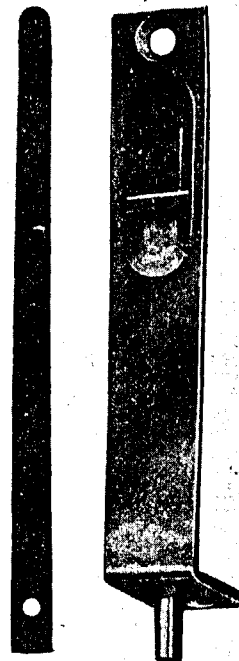
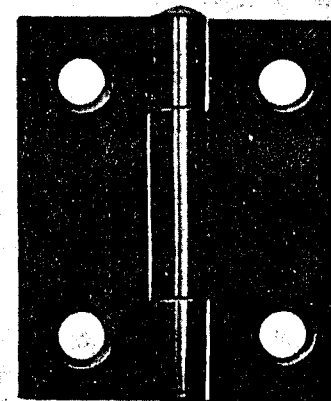


PLATE 8952—FULL SIZE

9370 126247

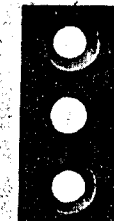


60656



126248

5604



Free Manuals Download Website

<http://myh66.com>

<http://usermanuals.us>

<http://www.somanuals.com>

<http://www.4manuals.cc>

<http://www.manual-lib.com>

<http://www.404manual.com>

<http://www.luxmanual.com>

<http://aubethermostatmanual.com>

Golf course search by state

<http://golfingnear.com>

Email search by domain

<http://emailbydomain.com>

Auto manuals search

<http://auto.somanuals.com>

TV manuals search

<http://tv.somanuals.com>