

Form 19088
(837)
Printed in U. S. A.

LIST OF PARTS



MACHINES

Nos. 147-102 and 147-103

** A TRADE MARK OF
THE SINGER MANUFACTURING COMPANY

INSTRUCTIONS FOR OILING

These machines are equipped with an oiling system which automatically delivers the proper amount of oil to the principal bearings of the machine.

Oil in a reservoir in the arm is picked up by a scoop in the connecting rod and lubricates the various bearings inside the arm by splash. A cup within the arm catches some of this oil, and connecting pipes and wicks distribute it to the principal bearings outside the arm.

IN ORDER THAT THIS SYSTEM MAY OPERATE, IT IS ABSOLUTELY NECESSARY THAT THE OILING INSTRUCTIONS GIVEN IN FORM 18930, Instruction Book for these Machines, be followed to the letter.

Use either Singer "OIL FOR HIGH SPEED SEWING MACHINES (Cloth and Leather)" for general use, or "STAINLESS OIL FOR HIGH SPEED SEWING MACHINES" where a stainless oil is desired.

INDEX

	Page
Accessories.....	22
Belt Guard.....	22
Bench Stand.....	22
Fittings for Machine 147-102.....	20
Fittings for Machine 147-103.....	21
Foot Lifter Parts.....	23
Knee Lifter Parts.....	23
Lap Seam Feller.....	22
Machine Base.....	24
Machine Base Oil Drain Jar.....	24
Machine No. 147-102.....	5
Machine No. 147-103.....	18
Numerical List of Parts.....	27
Thread Unwinder.....	25

Copyright, U. S. A., 1932, 1933 and 1937

by The Singer Manufacturing Co.

All Rights Reserved for all Countries

INSTRUCTIONS FOR ORDERING

In ordering from this list, use ONLY the part NUMBER in the FIRST column.

The number stamped on a Sewing Machine Part is in every case the number of the single part only.

Every combination of parts sent out as such has its specific number, which, although not stamped on the parts, must be used when ordering the combination.

Each number always indicates the SAME PART in whatever list it appears, or for whatever machine.

The letters after some of the numbers indicate the style of finish only, as follows:

- A-Hardened, Polished, Nickel Plated and Buffed
- B-Polished, Nickel Plated and Buffed
- C-Hardened Only
- D-Polished Only
- E-Soft, Not Polished
- F-Hardened and Polished
- F.J-Hardened, Polished and Nickel Plated
- G-Bright Rumbled and Nickel Plated
- H-Blued
- J-Nickel Plated Only
- K-Hardened and Nickel Plated
- L-Brass Plated
- M-Oxidized
- N-Japanned, Dull
- P-Japanned, Bright
- R-Merlized
- S-Cadmium Plating
- T-Copper Plated
- T.A-Hardened, Polished, Copper and Nickel Plated and Buffed
- T.B-Copper and Nickel Plated and Polished
- T.J-Copper and Nickel Plated Only
- T.K-Hardened, Copper and Nickel Plated
- T.L-Copper and Brass Plated
- T.M-Copper Plated and Oxidized
- U-Zinc Plated
- V-Silver Plated
- W-Polished and Nickel Plated
- X-Black Oxide, for Iron and Steel
- X.C-Hardened and Black Oxide, for Iron or Steel
- Y-Black Nickel Plated Only
- Z-Chromium Plated
- Z.A-Hardened, Polished, Nickel Plated, Buffed and Chromium Plated
- Z.B-Polished, Nickel Plated, Buffed and Chromium Plated
- Z.C-Hardened and Chromium Plated
- Z.J-Nickel and Chromium Plated

These letters MUST BE USED when they appear in the list; and AFTER the number as in the list.

In this series:

1 to 1500, 50001 to 51500 and 140001 to 142000 are Screw Numbers
 1501 to 1800 and 51501 to 51800 are Nut Numbers
 1801 to 2000 and 51801 to 52000 are Roller Numbers
 2001 to 50000 and 52001 to 140000 and 142001 to 190000 are Sewing Machine Parts, 190001 and upward are numbers of Electrical Parts.

The figures in the second column refer only to the plates, illustrating the parts, and are NOT TO BE USED in ordering.

Parts marked with an asterisk (*) are furnished only when repairs are made at factory.

When ordering parts which differ as to Gauge (the distance between seams) the Gauge, as well as the Number must be given on order.

LIST OF PARTS COMPLETE

FOR

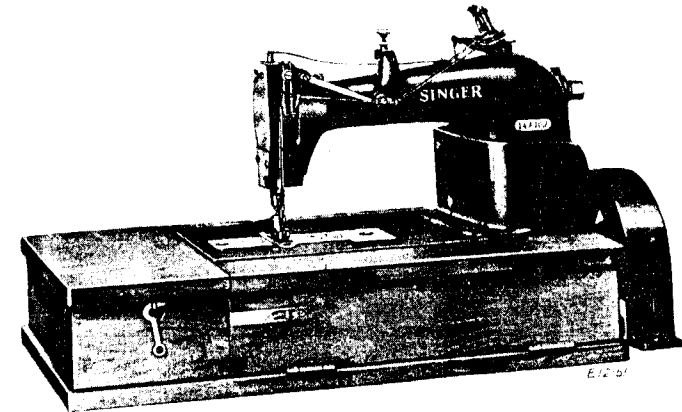

MACHINE No. 147-102

For Lap Seam Felling Medium and Medium Heavy Work Shirts, Jumpers, Overalls and Work of a Similar Nature. Two needles, two loopers. Gauges 3/32 inch to 1/2 inch. Ball bearing. Needle bar stroke 1 5/16 inches. The loopers are arranged so that they may be thrown out of position for convenience in threading. An improved oiling system automatically oils all of the principal bearings of the machine. Speed up to 4000 R. P. M., according to the material being stitched.

No.	Plate	Name
*131446	-----	Arm, upper and lower (solid) with 948J, 15404, 68483, two 15405 and four 131022.....
68428	20529	Arm Bottom Cover.....
68429	20529	" " " Gasket (cork).....
1057C	20530	" " " Screw.....
50608R	20530	" Hole Plug Screw for access to Crank Connecting Rod (upper bearing).....
139017	20530	Arm Hole Plug Screw Washer.....
68350	20530	" Oil Cup, for oiling Arm Rock Shaft Front Bearing.....

No.	Plate	Name
131378	20568	Cloth Plate Slide (right) 1/8 in. Throat Plate clearance cut, for 131385.....
131379	20568	Cloth Plate Slide (right) 9/64 in. Throat Plate clearance cut, for 131386.....
131380	20568	Cloth Plate Slide (right) 3/16 in. Throat Plate clearance cut, for 131387.....
131381	20532	Cloth Plate Slide (right) Spring.....
725J	20533	" " " " " Screw..
131382	-----	Cloth Plate Slide (right) complete (No Throat Plate clearance cut) for 131388, Nos. 131375, 131381 and two 725J.....
131383	-----	Cloth Plate Slide (right) complete (1/16 in. Throat Plate clearance cut) for 131389, Nos. 131376, 131381 and two 725J.....
131384	-----	Cloth Plate Slide (right) complete (7/64 in. Throat Plate clearance cut) for 131390, Nos. 131377, 131381 and two 725J.....
131385	-----	Cloth Plate Slide (right) complete (1/8 in. Throat Plate clearance cut) for 131391, Nos. 131378, 131381 and two 725J.....
131386	-----	Cloth Plate Slide (right) complete (9/64 in. Throat Plate clearance cut) for 131392, Nos. 131379, 131381 and two 725J.....
131387	-----	Cloth Plate Slide (right) complete (3/16 in. Throat Plate clearance cut) for 131393, Nos. 131380, 131381 and two 725J.....
131388	-----	Cloth Plate complete, for Throat Plates with no offset, Nos. 131051, 131374 and 131382.....
131389	-----	Cloth Plate complete, for Throat Plates with 1/16 in. offset, Nos. 131051, 131374 and 131383.....
131390	-----	Cloth Plate complete, for Throat Plates with 7/64 in. offset, Nos. 131051, 131374 and 131384.....
131391	-----	Cloth Plate complete, for Throat Plates with 1/8 in. offset, Nos. 131051, 131374 and 131385.....
131392	-----	Cloth Plate complete, for Throat Plates with 9/64 in. offset, Nos. 131051, 131374 and 131386.....
131393	-----	Cloth Plate complete, for Throat Plates with 3/16 in. offset, Nos. 131051, 131374 and 131387.....

No.	Plate	Name
1011F	20533	Cloth Plate Screw (left).....
50396F	20533	" " " (right).....
131394	20592	" " Thread Guard.....
389F	20533	" " " " Screw (lower)..
50473F	20533	" " " " " (upper)..
*131471	20584	Crank Connecting Rod with two each 896C and 1057C.....
131489	-----	Crank Connecting Rod 131471 with 131486.
896C	20533	" " " Cap (lower) Screw..
1057C	20530	" " " " (upper) Screw..
68460	20532	Face Plate (lower half).....
68461	20532	" " " " Gasket (cork)...
330D	20533	" " " " Screw.....
131395	20532	" " (upper half).....
29234	20533	" " " " Position Plate..
1053E	20533	" " " " " " Screw.....
51224W	20530	Face Plate (upper half) Thumb Screw.....
131396	20583	Feed Bar.....
131397	20583	Feed Bar complete, Nos. 50429C, 68467, 131396 and two 207E.....
131197	20583	Feed Bar Hinge Pin (eccentric).....
59343	20533	" " " " Collar with 735C.....
735C	20533	" " " " Set Screw.....
134258	20533	" " Slide Block.....
134259	20533	" " " " 134258 with 68495 and 134260.....
68495	20533	Feed Bar Slide Block Oil Pad (wick)....
134260	20533	" " " " " Retainer...
68467	20583	" " Wearing Plate.....
207E	20533	" " " " Screw.....
131500	20583	" Connecting Rod with 1057C, 68497, 134260 and two 896C.....
131502	-----	Feed Connecting Rod 131500 with 54025...
896C	20533	" " " Cap Screw.....
1057C	20530	" " " Clamping Screw.....
68497	20533	" " " Oil Pad (wick).....
134260	20533	" " " " Retainer....
131032	20585	" Dog, 17 teeth (16 teeth to the inch) for 3/32 in. to 1/4 in. gauges, for 131209 and 131210.....
131321	20587	Feed Dog, 16 teeth (16 teeth to the inch) with row of teeth between the needles, for 5/32 in. to 11/32 in. gauges, for 131211 and 131212.....
131093	20586	Feed Dog, 18 teeth (16 teeth to the inch) for 3/8 in. and 13/32 in. gauges, for 131213 and 131214.....
131241	20589	Feed Dog, 12 teeth (10 teeth to the inch) for 3/16 in. to 3/8 in. gauges, for 131115.....

No.	Plate	Name
131118	20588	Feed Dog, 16 teeth (14 teeth to the inch) for 3/8 in. to 1/2 in. gauges, for 131124 and 131215.....
157J	20533	Feed Dog Screw, when stationary Needle Guard is used.....
50073J	20533	Feed Dog Screw, when movable Needle Guard is used.....
50429C	20533	Feed Dog Stop Screw.....
*54024	-----	" Eccentric with 138306.....
*23729	-----	" " Body.....
51061C	20533	" " " Set Screw.....
7071	20533	" " " Clamping Washer.....
217J	20533	" " " " Screw....
138306	20533	" " Lubricating Pad (wood)...
54025	20583	Feed Eccentric (adjustable) complete, Nos. 1103C, 23729, 54024 and two each 217J, 7071 and 51061C.....
1103C	20533	Feed Regulating Screw.....
131240	20583	" Rocking Frame with two 453C.....
131398	-----	" " " 131240 with 59343, 131197 and 131397.....
57234	20583	Feed Rocking Frame Hinge Pin.....
57235	20533	" " " " " Bushing....
453C	20562	" " " " " " Set Screw.....
453C	20562	Feed Rocking Frame Hinge Pin Set Screw..
131458	20562	Looper (back) closed eye, for lap seam felling.....
131131	20562	Looper (back) closed eye, for general work.....
Note: When ordering No. 131131 or No. 131458, state gauge of machine for which required.		
452C	20562	Looper (back) Set Screw.....
131459	20562	" (front) closed eye, for lap seam felling.....
131132	20562	Looper (front) closed eye, for general work.....
Note: When ordering No. 131132 or No. 131459, state gauge of machine for which required.		
1120C	20562	Looper (front) Set Screw.....
54027	20562	" Carrier with two 175E.....
175E	20562	" " Adjusting Screw.....
54227	20562	" " Connection.....
54228	20562	" " " Shaft.....
128419	20546	" " " " Oil Pad (braided cotton).....
68478	20583	Looper Carrier Connection Shaft Sleeve (eccentric).....
51263D	20546	Looper Carrier Connection Shaft Sleeve Cap Screw.....

No.	Plate	Name
68479	20562	Looper Carrier Driver with four 175E....
175E	20562	" " " Cap Screw.....
*131110	20583	" Driving Shaft and Feed Lifting Eccentric with two 64315.....
Note: When No. 131110 is required for repairs, the Arm Rotary Shaft must be returned to the factory to be adjusted to the new part.		
*131111	-----	Looper Driving Shaft and Feed Lifting Eccentric 131110 with 54227, 54227, 54228 and 68479.....
*68483	-----	Looper Driving Shaft and Feed Lifting Eccentric Bracket with 761E.....
948J	20546	Looper Driving Shaft and Feed Lifting Eccentric Bracket Screw.....
68484	20583	Looper Driving Shaft and Feed Lifting Eccentric Bushing.....
131028	20546	Looper Driving Shaft and Feed Lifting Eccentric Bushing Oil Plug.....
761E	20530	Looper Driving Shaft and Feed Lifting Eccentric Bushing Position Screw....
68497	20533	Looper Driving Shaft and Feed Lifting Eccentric Front Bearing Oil Pad (wick).....
64315	20546	Looper Driving Shaft and Feed Lifting Eccentric Oil Hole Plug.....
640E	20546	Looper Driving Shaft and Feed Lifting Eccentric Screw.....
131052	20562	Looper Holder with 452C and 1120C.....
51119J	20546	" " Screw.....
68485	20583	" Throw-out Handle with two 443C...
68486	20546	" " " Plunger.....
43503	20546	" " " " Spring..
443C	20546	" " " " Set Screw.....
64319	20565	Needle Bar (hollow).....
131045	-----	Needle Bar complete, for 3/32 in. to 1/2 in. gauges, Nos. 64319 and 131044...
131291	20581	Needle Bar Bushing (lower).....
1133E	20582	" " " " Set Screw....
64320	20581	" " " " (upper).....
1133E	20582	" " " " Set Screw....
68488	20581	" " Connecting Link and Thread (upper) Controller.....
131399	-----	Needle Bar Connecting Link and Thread (upper) Controller 68488 with 68489 and 131400.....
68489	20581	Needle Bar Connecting Link Hinge Stud (hollow).....
1520J	20566	Needle Bar Connecting Link Hinge Stud Nut.....

No.	Plate	Name
131270	20581	Needle Bar Connecting Link Hinge Stud Oil Pad (wick).....
861C	20582	Needle Bar Connecting Link Hinge Stud Oil Plug Screw.....
853C	20582	Needle Bar Connecting Link Hinge Stud Set Screw.....
131400	20566	Needle Bar Connecting Stud with 211F and 1492E.....
1492E	20566	Needle Bar Connecting Stud Clamping Screw.....
131044	20581	Needle Clamp with two 1498F, for 3/32 in. to 1/2 in. gauges.....
131174	20582	Needle Guard (movable) for 3/16 in. to 3/8 in. gauges.....
131121	20582	Needle Guard (movable) for 13/32 in. to 1/2 in. gauges.....
68123	20582	Needle Guard (movable) Clamp.....
54067	20582	" " (stationary) for 3/32 in. to 5/32 in. gauges.....
54068	20582	Needle Guard (stationary) for 3/16 in. to 9/32 in. gauges.....
54069	20582	Needle Guard (stationary) for 5/16 in. to 3/8 in. gauges.....
131175	20582	Needle Guard (stationary) for 13/32 in. to 1/2 in. gauges.....
54038	20582	Needle Guard (stationary) Holder.....
176J	20566	" " " " Screw..
217C	20533	" " " " Screw.....
1498F	20582	" Set Screw.....
68492	20538	Oil Pipe (back of arm) with 49191 and 68497, for oiling Feed Rocking Hinge Pin Front Bearing.....
68493	20538	Oil Pipe (back of arm) Clamp.....
176E	20566	" " " " " " Screw.....
68494	20538	" " " " " " Connection with 49189, 68495 and two 198E, for oil- ing Feed Rocking Frame Hinge Pin Back Bearing.....
*49189	-----	Oil Pipe (back of arm) Connection Cap...
198E	20546	" " " " " " " " "
		Screw.....
68495	20533	Oil Pipe (back of arm) Connection Oil Pad (wick).....
68496	20538	Oil Pipe (back of arm) Coupling.....
1733	20546	" " " " " " Nut (brass)
68497	20533	" " " " " " Oil Pad (wick)...
*49191	-----	" " " " " " Sleeve.....
68498	20538	" " (front of arm) with 131089 and two each 1733 and 49191, for oiling Looper Driving Shaft and Feed Lift- ing Front Bearing.....

No.	Plate	Name
131112	20538	Oil Pipe (front of arm) with 68497 and 131003, for oiling Feed Bar Slide Block.....
68500	20538	Oil Pipe (front of arm) with 1733, 49191 131084 and 131089, for oiling Arm Rotary Shaft Front Bearing.....
131113	20538	Oil Pipe (front of arm) with 68497 and 131003, for oiling Feed Connecting Rod.....
131258	-----	Oil Pipe (front of arm) complete, Nos. 68498, 68500, 131112 and 131113.....
131002	20538	Oil Pipe (front of arm) Connection with 131049 and two 198E, for oiling Looper Throw-out Device.....
131003	20538	Oil Pipe (front of arm) Connection with 49189 and two 198E, for 131112 and 131113.....
131084	20538	Oil Pipe (front of arm) Connection with 131085 and two 198E, for 68500.....
*49189	-----	Oil Pipe (front of arm) Connection Cap for 131003.....
*131049	-----	Oil Pipe (front of arm) Connection Cap for 131002.....
*131085	-----	Oil Pipe (front of arm) Connection Cap for 131084.....
198E	20546	Oil Pipe (front of arm) Connection Cap Screw.....
131004	20538	Oil Pipe (front of arm) Coupling(center)
131004	20538	" " " " " " (left)..
*131086	-----	" " " " " " (right).
131087	20538	" " " " " " " "
		131086 with 131088.....
*131088	-----	Oil Pipe (front of arm) Coupling (right) Oil Lead.....
1733	20546	Oil Pipe (front of arm) Coupling Nut (brass).....
131089	20546	Oil Pipe (front of arm) Oil Pad (wick) for 68498 and 68500.....
68497	20533	Oil Pipe (front of arm) Oil Pad (wick) for 131112 and 131113.....
*49191	-----	Oil Pipe (front of arm) Sleeve.....
64330	20542	Presser Bar with 25303.....
25303	20546	" " Ball, size 1/4 in.....
131006	20565	" " Bushing (lower).....
1133E	20582	" " " " " Set Screw...
38456	20565	" " " " (upper).....
1133E	20582	" " " " " Set Screw...
131401	20565	" " Lifting Bracket with 453C...
11173	20565	" " " " " Guide.....
453C	20562	" " " " " " Set Screw.....

No.	Plate	Name
453C	20562	Presser Bar Lifting Bracket Set Screw...
131402	20542	" " " Lever.....
68184	20542	" " " " Extension.....
161J	20546	" " " " " Screw.
802D	20546	" " " " Hinge Screw...
38467	20542	" " Spring (flat).....
38468	20565	" " Stud.....
26276	20565	" Foot Hinge Pin.....
131158	-----	" " Plate.....
54120	-----	" " Shank.....
131159	20585	Presser Foot (hinged) complete, for 3/32 in. to 3/8 in. gauges, for lap seam felling, Nos. 26276, 54120 and 131158
Note: Presser Foot No. 131159 is regularly furnished with this machine unless another Presser Foot is specified on order.		
26276	20565	Presser Foot Hinge Pin.....
131233	-----	" " Shank.....
131242	-----	" " Plate.....
131243	20589	Presser Foot (hinged) complete, for 3/16 in. to 1/2 in. gauges, for lap seam felling work shirts and overalls, Nos. 26276, 131233 and 131242.....
26276	20565	Presser Foot Hinge Pin.....
131591	-----	" " Plate.....
46087	-----	" " Shank.....
131592	20585	Presser Foot (hinged) complete, for 3/32 in. to 13/32 in. gauges, for plain stitching, Nos. 26276, 46087 and 131591.....
26276	20565	Presser Foot Hinge Pin.....
131593	-----	" " Plate.....
36030	-----	" " Shank.....
131594	20588	Presser Foot (hinged) complete, for 3/8 in. to 1/2 in. gauges, for plain stitching, Nos. 26276, 36030 and 131593.....
26276	20565	Presser Foot Hinge Pin.....
131595	-----	" " Plate.....
131596	-----	" " Shank.....
131597	20588	Presser Foot (hinged) complete, for 3/8 in. to 1/2 in. gauges, for lap seam felling, Nos. 26276, 131595 and 131596.....
190J	20530	Presser Foot Screw.....
574W	20581	Pressure Regulating Thumb Screw.....
1539W	20581	" " " " Lock Nut.
131025	20566	Slack Thread Controller.....
54242	20582	" " " Clamp.....

No.	Plate	Name
190J	20530	Slack Thread Controller Clamp Screw.....
131403	20565	" " Regulator.....
131404	20565	" " " Holder.....
131405	20565	" " " " Crank with 171E.....
1423J	20566	Slack Thread Regulator Holder Crank Cap Screw.....
171E	20565	Slack Thread Regulator Holder Crank Clamping Screw.....
131406	20565	Slack Thread Regulator Holder Crank Connecting Link.....
217J	20533	Slack Thread Regulator Screw.....
131012	20542	Tension (under thread) Bracket.....
691F	20566	" " " " Screw.....
2102	20565	" " " Disc.....
51570C	20565	" " " Regulating Thumb Nut.....
50326C	20565	Tension (under thread) Screw Stud.....
59539	-----	" " " " " 50326C with 51570C.....
59534	20565	Tension (under thread) Spring.....
59537	20565	" " " " Bushing (large).....
59538	20565	Tension (under thread) Spring Bushing (small).....
57075	20565	Tension (under thread) Thread Guide.....
54070	20566	" (upper thread) Bracket.....
376J	20565	" " " " Screw....
2102	20565	" " " Disc.....
51570C	20565	" " " Regulating Thumb Nut.....
32572	20582	Tension (upper thread) Releasing Disc...
54988	20565	" " " " Pin....
54071	20581	" " " " Shaft..
54047	20539	" " " " " Crank with 624C.....
54048	20539	Tension (upper thread) Releasing Shaft Crank Link.....
624C	20539	Tension (upper thread) Releasing Shaft Crank Set Screw.....
68261	20539	Tension (upper thread) Releasing Shaft Spring.....
131011	20539	Tension (upper thread) Releasing Shaft Spring Position Plate.....
316C	20539	Tension (upper thread) Releasing Shaft Stop Screw.....
1547J	20539	Tension (upper thread) Releasing Shaft Stop Screw Nut.....
50326C	20565	Tension (upper thread) Screw Stud.....

No.	Plate	Name
59539	-----	Tension (upper thread) Screw Stud 50328C with 51570C.....
59535	20581	Tension (upper thread) Spring.....
59537	20565	" " " " Bushing (large).....
59538	20565	Tension (upper thread) Spring Bushing (small).....
57076	20565	Tension (upper thread) Thread Guide (double).....
53225	20539	Thread (under) Eyelet (back).....
190J	20530	" " " " Screw.....
131407	20539	" " Take-up with 1258C.....
131408	20562	" " " Oil Guard.....
50438J	20566	" " " " Screw..
1258C	20566	" " " Set Screw.....
131409	20582	" " " Stripper.....
54242	20582	" " " " Clamp...
190J	20530	" " " " " Screw
131410	20542	" " " " " Plate...
131411	20542	" " " " " " Bracket.....
131412	-----	Thread (under) Take-up Stripper Plate Bracket 131411 with 32062, 50438J, 54242, 131408 to 131410, 131413 to 131415, two each 207J, 7071, 50470J and four 190J.....
96JD	20582	Thread (under) Take-up Stripper Plate Bracket Screw.....
190J	20530	Thread (under) Take-up Stripper Plate Screw.....
32062	20581	Thread (under) Take-up Stripper Washer..
131413	20582	" " " " Thread Guard (fibre).....
50470J	20582	Thread (under) Take-up Thread Guard Screw.....
131414	20582	Thread (under) Take-up Thread Guide (left).....
207J	20533	Thread (under) Take-up Thread Guide (left) Screw.....
7071	20533	Thread (under) Take-up Thread Guide (left) Screw Washer.....
131415	20582	Thread (under) Take-up Thread Guide (right).....
207J	20533	Thread (under) Take-up Thread Guide (right) Screw.....
7071	20533	Thread (under) Take-up Thread Guide (right) Screw Washer.....
46009	20566	Thread (upper) Eyelet.....
190J	20530	" " " " Screw.....
131334	20566	" " Take-up.....

No.	Plate	Name
54095	20566	Thread (upper) Take-up Plate.....
68164	20565	" " " " Spring.....
1449J	20566	" " " " " Screw
131335	-----	Thread (upper) Take-up complete, Nos. 1449J, 54095, 68164 and 131334.....
211F	20566	Thread (upper) Take-up Set Screw.....
131209	20585	Throat Plate, for 3/32 in. to 1/4 in. gauges, for 131032, for lap seam felling.....
131211	20587	Throat Plate, for 5/32 in. to 11/32 in. gauges, for 131321, for lap seam felling.....
131115	20589	Throat Plate, for 1/4 in. to 3/8 in. gauges, for 131241, for lap seam felling, for making longer stitch than regular.....
131213	20586	Throat Plate, for 3/8 in. and 13/32 in. gauges, for 131093, for lap seam felling.....
131124	20588	Throat Plate, for 3/8 in. to 1/2 in. gauges, for 131118, for lap seam felling.....
131210	20585	Throat Plate, for 3/32 in. to 1/4 in. gauges, for 131032, for plain stitching.....
131212	20587	Throat Plate, for 5/32 in. to 11/32 in. gauges, for 131321, for plain stitching.....
131214	20586	Throat Plate, for 3/8 in. and 13/32 in. gauges, for 131093, for plain stitching.....
131215	20588	Throat Plate, for 3/8 in. to 1/2 in. gauges, for 131118, for plain stitching.....
742F	20562	Throat Plate Screw.....
*15404	-----	Trade Mark.....
15405	-----	" Rivet.....

MACHINE No. 147-103

For Lap Seam Felling Side Seams on Medium and Medium Heavy Pants, Overalls and Automobile Seat Covers. Two needles, two loopers. Gauges 3/32 inch to 1/2 inch. Ball bearing. Needle bar stroke 1 3/8 inches. The loopers are arranged so that they may be thrown out of position for convenience in threading. An improved oiling system automatically oils all of the principal bearings of the machine. Speed 3800 R. P. M.

NOTE: THIS MACHINE IS THE SAME AS THE 147-102 MACHINE WITH THE FOLLOWING EXCEPTIONS:

No.	Plate	Name
131072	20566	Arm Rock Shaft Crank (back) ball bearing solid, with two 50083C, in place of 131486.....
131510	-----	Arm Rotary Shaft 131487 with 640E, 68459 131111 and 131502, in place of 131488
68459	-----	Crank Connecting Rod 131471 with 131072, in place of 131489.....
131529	20590	Feed Dog, 14 teeth (10 teeth to the inch) for 1/4 in. to 3/8 in. gauges, for 131536.....
*131579	-----	Looper Holder Body.....
131580	20581	" " " 131579 with 452C and 1120C, in place of 131052.....
131292	20581	Presser Bar Bushing (lower) in place of 131006.....
*131231	-----	Presser Bar Spring (auxiliary).....
*131232	-----	" " " " Guide.....
4604	20581	" " " " Rivet.
131196	20581	Presser Bar Spring (auxiliary) complete, Nos. 4604, 131231 and 131232.....
131546	-----	Presser Foot Plate.....
128390	-----	" " " Hinge Stud.....
665J	20581	" " " " Position Screw.....
131547	-----	Presser Foot Shank.....
131548	-----	" " Yielding Heel.....
131549	-----	" " " " Connection...
26276	20565	" " " " Hinge Pin.....
131534	-----	Presser Foot Yielding Heel Connection Spring.....

No.	Plate	Name
26276	20565	Presser Foot Yielding Heel Hinge Pin...
131550	20590	Presser Foot (triple hinged) complete, for 3/16 in. to 3/8 in. gauges, Nos. 131534, 131546 to 131549 and two each 665J, 26276 and 128390.....
131536	20590	Throat Plate, for 1/4 in. to 3/8 in. gauges, for 131529.....

SINGER Needles should be used in **SINGER** Machines. These Needles and their Containers are marked with the Company's Trade Mark "SIMANCO."***₁

Needles in Containers marked "FOR SINGER MACHINES" are NOT **SINGER** made needles. ₂

FITTINGS FOR 147-102 MACHINE
FOR LAP SEAM FELLING - LAP SEAM FELLER 12/1438

	3/32	1/8	5/32	3/16	7/32	1/4	9/32	5/16	11/32	3/8	13/32	7/16	15/32	1/2
Feed Dog	131002	131002	131002	131002	131002	131002	131002	131002	131002	131002	131002	131002	131002	131002
Feed Dog	131002	131002	131002	131002	131002	131002	131002	131002	131002	131002	131002	131002	131002	131002
Looper (back)	131458	131458	131458	131458	131458	131458	131458	131458	131458	131458	131458	131458	131458	131458
Looper (front)	131459	131459	131459	131459	131459	131459	131459	131459	131459	131459	131459	131459	131459	131459
Needle Guard (stationary)	54067	54067	54067	54067	54067	54067	54067	54067	54067	54067	54067	54067	54067	54067
Needle Guard (movable)	131159	131159	131159	131159	131159	131159	131159	131159	131159	131159	131159	131159	131159	131159
Presser Foot	131159	131159	131159	131159	131159	131159	131159	131159	131159	131159	131159	131159	131159	131159
Presser Foot	131159	131159	131159	131159	131159	131159	131159	131159	131159	131159	131159	131159	131159	131159
Throat Plate	131159	131159	131159	131159	131159	131159	131159	131159	131159	131159	131159	131159	131159	131159
Throat Plate	131159	131159	131159	131159	131159	131159	131159	131159	131159	131159	131159	131159	131159	131159

FOR PLAIN STITCHING

Feed Dog	131002	131002	131002	131002	131002	131002	131002	131002	131002	131002	131002	131002	131002	131002
Feed Dog	131002	131002	131002	131002	131002	131002	131002	131002	131002	131002	131002	131002	131002	131002
Looper (back)	131131	131131	131131	131131	131131	131131	131131	131131	131131	131131	131131	131131	131131	131131
Looper (front)	131132	131132	131132	131132	131132	131132	131132	131132	131132	131132	131132	131132	131132	131132
Needle Guard (stationary)	54067	54067	54067	54067	54067	54067	54067	54067	54067	54067	54067	54067	54067	54067
Needle Guard (movable)	131159	131159	131159	131159	131159	131159	131159	131159	131159	131159	131159	131159	131159	131159
Presser Foot	131159	131159	131159	131159	131159	131159	131159	131159	131159	131159	131159	131159	131159	131159
Presser Foot	131159	131159	131159	131159	131159	131159	131159	131159	131159	131159	131159	131159	131159	131159
Throat Plate	131210	131210	131210	131210	131210	131210	131210	131210	131210	131210	131210	131210	131210	131210
Throat Plate	131210	131210	131210	131210	131210	131210	131210	131210	131210	131210	131210	131210	131210	131210

Note: Where gauges overlap regular fittings are designated by an asterisk (*)

Note: When movable needle guard is used Needle Guard Clamp 68103 and Feed Dog Screw 500731 are also required.

FITTINGS
FOR MACHINE 147-103
FOR SEAMING MEDIUM AND MEDIUM HEAVY PANTS

No.	Plate	Name
131466	20592	Cloth Plate.....
131467	-----	Cloth Plate complete, for Throat Plate with 9/64 in. offset, Nos. 131051, 131386 and 131466.....
131537	20591	Feed Dog, 19 teeth (10 teeth to the inch) for 3/16 in. to 1/4 in. gauges, for 131543.....
131538	-----	Presser Foot Plate.....
128390	-----	" " " Hinge Stud.....
665J	20581	" " " " " Position Screw.....
131539	-----	Presser Foot Shank.....
131540	-----	" " " Yielding Heel.....
131541	-----	" " " " " Connection...
13085	-----	" " " " " Hinge Pin.....
27114	-----	Presser Foot Yielding Heel Connection Spring.....
18055	-----	Presser Foot Yielding Heel Hinge Pin....
131542	20591	Presser Foot (triple hinged) complete, for 3/16 in. to 1/4 in. gauges, Nos. 27114, 131538 to 131541 and two each 665J, 18055 and 128390.....
131543	20591	Throat Plate, for 3/16 in. to 1/4 in. gauges, for 131537.....

ACCESSORIES

No.	Plate	Name
120344	20545	Oiler (copper plated) with 120345.....
120345	20545	" Spout, 4-1/2 in. long.....
120440	20545	Screw Driver (large).....
121108	20545	" " (small).....
120341	20545	Tweezers (curved).....
4822	20545	Wrench for 1547.....
8908	20545	" " 1520.....

BELT GUARD

No.	Plate	Name
68222	20549	Belt Guard with two wood screws 1 in. No. 12.....

BENCH STAND

No.	Plate	Name
79772	-----	Bench Stand with 27998, two each 41538, 126849, three wood screws 1-1/4 in. No. 12, four each 60656, wood screws 1-1/4 in. No. 10 and sixteen wood screws 5/8 in. No. 7.....
126849	9520	Flap Hinge with four wood screws 3/4 in. No. 7.....
27998	9520	Flap Hook and Eye (brass) with wood screw 1/2 in. No. 5.....
126247	9520	Flush Bolt.....
126248	9520	" " Plate.....
41538	-----	Flush Bolt with Plate complete, Nos. 126247, 126248 and four brass wood screws 5/8 in. No. 4.....
60656	9520	Hinge.....

LAP SEAM FELLER

No.	Plate	Name
121438	20593	Lap Seam Feller (adjustable) on Shank, for sleeving, for medium heavy and heavy-weight material, for 147-102

No.	Plate	Name
121440	20593	Lap Seam Feller (adjustable) on Shank, for medium heavy and heavy-weight material, for 147-103 Machine.....
1499J	20593	Lap Seam Feller Screw.....

FOOT LIFTER PARTS

No.	Plate	Name
6439	-----	Chain, 36 in. to 45 in., with 56864 and 56865.....
Note: When ordering No. 6439, state length required.		
4879	20545	Chain Connecting Link.....
56864	20545	" Hook (large).....
56865	20545	" " (small).....
126249	20549	Treadle.....
4882	20547	" Shaft.....
126250	20547	" Spring.....
150451	20549	" Stand.....
150452	20549	Treadle complete, Nos. 4879, 4882, 126249 126250, 150451 and two wood screws 1 in. No. 16.....

KNEE LIFTER PARTS

No.	Plate	Name
37563	-----	Chain, length 15 in., with 56864 and 56865.....
56864	20545	" Hook (large).....
56865	20545	" " (small).....
2763	20592	Rock Shaft.....
12242	20592	" " Hanger with two wood screws 1 in. No. 10.....
6335	20592	Rock Shaft Knee Arm.....
6336	-----	Rock Shaft Knee Arm complete, Nos. 2766, 2767 and 6335.....
2766	20592	Rock Shaft Knee Arm Hub with 356C.....
356C	20546	" " " " Set Screw.....
2767	20592	" " " " Plate with 356C.....
356C	20546	" " " " Set Screw.....
6337	20592	" " Lifting Bracket with two 356C
7125	20592	" " " " Hook.....
356C	20546	" " " " Set Screw
356C	20546	" " " " Set Screw....
2770	20592	" " Stop Dog with 356C.....

No.	Plate	Name
356C	20546	Rock Shaft Stop Dog Set Screw.....
23767	20592	Rock Shaft complete, Nos. 2763, 2770, 6336, 6337, 7125 and two 12242.....

MACHINE BASE

No.	Plate	Name
131263	20549	Machine Base.....
54477	20547	" " Screw Stud, to fasten base to table.....
131205	20547	Machine Base Screw Stud, to position ma- chine on base.....
51576E	20547	Machine Base Screw Stud Nut.....
9842	20547	" " " " " Washer.....
131022	20547	" " " " Bushing (rubber)
131279	20547	" Cushion (felt).....
131264	-----	Machine Base complete, Nos. 131263, three each 9842, 51576E, 54477 and four each 131205 and 131279.....
131328	-----	Machine Base and Oil Drain Jar (swinging type) complete, Nos. 131264 and 131268.....

MACHINE BASE OIL DRAIN JAR

(SWINGING TYPE)

No.	Plate	Name
131185	20526	Jar (glass).....
131191	20526	" Cap.....
131188	20526	" Clamp.....
131217	-----	" " 131188 with 131189.....
131189	20526	" " Lever.....
1247C	20546	" " " Hinge Screw.....
131265	20526	Nipple (long).....
131266	20526	" (short).....
131267	20526	" Elbow.....
131268	-----	Machine Base Oil Drain Jar (swinging type) complete, Nos. 131185, 131191, 131217, 131266 and two each 1247C, 131265 and 131267.....

THREAD UNWINDER

(FOR FOUR SPOOLS)

No.	Plate	Name
225257	9505	Spool Rest (for two spools) with 201018C
150203	9505	" " Cushion (felt).....
225388	9505	" " Rod.....
200383C	20546	" " " Set Screw.....
201018C	20546	" " Set Screw.....
202490	9505	" Stand with 200383C.....
225391	9505	Thread Guide.....
201696J	20546	" " Lock Nut.....
225326	20546	" " Position Cup.....
225324	9505	" " Rod with 208E and 225322...
208E	20546	" " " Screw.....
225322	20546	" " " Washer.....
*150057	-----	" Separator.....
150058	9505	" " 150057 with 150059.....
*150059	-----	" " Bracket.....
150060	9505	" " " Arm with 164J and 9525.....
164J	20546	Thread Separator Bracket Arm Clamping Screw.....
9525	20546	Thread Separator Bracket Arm Clamping Screw Washer.....
164J	20546	Thread Separator Bracket Arm Screw.....
9525	20546	" " " " " Washer
150061	-----	Thread Separator complete, Nos. 164J, 9525, 150058 and 150060.....
150062	9505	Thread Unwinder complete, Nos. 150061, 201696J, 202490, 225324, 225326, 225388, two 225257, three wood screws 7/8 in. No. 12 and four each 150203 and 225391.....
27739	20580	Thread Cone (wood) for large cones.....
225390	20580	" " Holder, for inverted cones..

Note: Nos. 27739 and 225390 are used with, but not included in 150062.

NUMERICAL LIST OF PARTS

No.	Plate	Name
144D	20530	Arm Rotary Shaft Screw.....
157J	20533	Feed Dog Screw, when stationary Needle Guard is used.....
161J	20546	Presser Bar Lifting Lever Extension Screw.....
164J	20546	Thread Unwinder Thread Separator Bracket Arm Clamping Screw, for 150060.....
164J	20546	Thread Unwinder Thread Separator Bracket Arm Screw, for 150061.....
171E	20565	Slack Thread Regulator Holder Crank Clamping Screw, for 131405.....
175E	20562	Looper Carrier Adjusting Screw, for 54027
175E	20562	" " Driver Cap Screw, for 68479
176J	20566	Needle Guard (stationary) Holder Screw..
176E	20566	Oil Pipe (back of arm) Clamp Screw.....
190J	20530	Presser Foot Screw.....
190J	20530	Slack Thread Controller Clamp Screw.....
190J	20530	Thread (under) Eyelet (back) Screw.....
190J	20530	" " Take-up Stripper Clamp Screw, for 131412.....
190J	20530	Thread (under) Take-up Stripper Plate Screw, for 131412.....
190J	20530	Thread (upper) Eyelet Screw.....
198E	20546	Oil Pipe (back of arm) Connection Cap Screw, for 68494.....
198F	20546	Oil Pipe (front of arm) Connection Cap Screw, for 131002, 131003 and 131084
205C	20530	Arm Rotary Shaft Bell Bearing (back) Case Cap Screw, for 131479.....
207E	20533	Feed Bar Wearing Plate Screw, for 131397
207J	20533	Thread (under) Take-up Thread Guide (left) Screw, for 131412.....
207J	20533	Thread (under) Take-up Thread Guide (right) Screw, for 131412.....
208E	20546	Thread Unwinder Thread Guide Rod Screw, for 225324.....
211F	20566	Thread (upper) Take-up Set Screw, for 131400.....
217C	20533	Feed Eccentric Clamping Washer Screw, for 54025.....
217J	20533	Needle Guard (stationary) Screw.....
217J	20533	Slack Thread Regulator Screw.....
316C	20539	Tension (upper thread) Releasing Shaft Stop Screw.....
330D	20533	Face Plate (lower half) Screw.....
356C	20546	Rock Shaft Knee Arm Hub Set Screw, for 2760.....

SINGER Needles should be used
in **SINGER** Machines
These Needles and their Containers
are marked with the
Company's Trade Mark "SIMANCO.**" 1

Needles in Containers marked
"FOR SINGER MACHINES"
are NOT **SINGER** made needles. 2

No.	Plate	Name
356C	20546	Rock Shaft Knee Plate Set Screw, for 2767
356C	20546	" " Lifting Bracket Hook Set Screw, for 6337.....
356C	20546	Rock Shaft Lifting Bracket Set Screw, for 6337.....
356C	20546	Rock Shaft Stop Dog Set Screw, for 2770.
376J	20565	Tension (upper thread) Bracket Screw....
389F	20533	Cloth Plate Thread Guard Screw (lower)..
423C	20530	Arm Rock Shaft Bushing (intermediate) Set Screw.....
429C	20530	Arm Rotary Shaft Ball Bearing (back) Case Set Screw.....
443C	20546	Looper Throw-out Handle Set Screw, for 68485.....
446C	20530	Arm Rock Shaft Bushing (back) Set Screw.
452C	20562	Looper (back) Set Screw, for 131052 and 131580.....
453C	20562	Arm Rock Shaft Flanged Bushing (front) Set Screw.....
453C	20562	Feed Rocking Frame Hinge Pin Bushing Set Screw.....
453C	20562	Feed Rocking Frame Hinge Pin Set Screw, for 131240.....
453C	20562	Presser Bar Lifting Bracket Guide Set Screw.....
453C	20562	Presser Bar Lifting Bracket Set Screw, for 131401.....
457C	20539	Arm Rotary Shaft Ball Bearing (intermediate) Collar Set Screw, for 131482..
563C	20530	Arm Oil Cup Drip Pan Position Screw, for 131305.....
574W	20581	Pressure Regulating Thumb Screw.....
624C	20539	Tension (upper thread) Releasing Shaft Crank Set Screw, for 54047.....
640E	20546	Looper Driving Shaft and Feed Lifting Eccentric Screw, for 131488 and 131510.....
665J	20581	Presser Foot Plate Hinge Stud Position Screw, for 131542 and 131550.....
691F	20566	Tension (under thread) Bracket Screw....
725J	20533	Cloth Plate Slide (left) Spring Screw, for 131051.....
725J	20533	Cloth Plate Slide (right) Spring Screw, for 131382 to 131387.....
735C	20533	Feed Bar Hinge Pin Collar Set Screw, for 59343.....
742F	20562	Throat Plate Screw.....
761E	20530	Arm Rotary Shaft Bushing (front) Set Screw.....

No.	Plate	Name
761E	20530	Looper Driving Shaft and Feed Lifting Eccentric Bushing Position Screw, for 68483.....
802D	20546	Presser Bar Lifting Lever Hinge Screw...
853C	20582	Needle Bar Connecting Link Hinge Stud Set Screw, for 131475.....
861C	20582	Needle Bar Connecting Link Hinge Stud Oil Plug Screw.....
896C	20533	Crank Connecting Rod Cap (lower) Screw, for 131471.....
896C	20533	Feed Connecting Rod Cap Screw, for 131500
948J	20546	Looper Driving Shaft and Feed Lifting Eccentric Bracket Screw, for 131446..
965D	20582	Thread (under) Take-up Stripper Plate Bracket Screw.....
1011F	20533	Cloth Plate Screw (left).....
1053E	20533	Face Plate (upper half) Position Plate Screw.....
1057C	20530	Arm Bottom Cover Screw.....
1057K	20530	" Side Cover Screw.....
1057C	20530	Crank Connecting Rod Cap (upper) Screw, for 131471.....
1057C	20530	Feed Connecting Rod Clamping Screw, for 131500.....
1103C	20533	Feed Regulating Screw, for 54025.....
1120C	20562	Looper (front) Set Screw, for 131052 and 131580.....
1133E	20582	Needle Bar Bushing (lower) Set Screw....
1133E	20582	" " " (upper) Set Screw....
1133E	20582	Presser Bar Bushing (lower) Set Screw...
1133E	20582	" " " (upper) Set Screw...
1235F	20530	Arm Rock Shaft Oil Plug Screw, for 131474
1247C	20546	Machine Base Oil Drain Jar Clamp Lever Hinge Screw, for 131268.....
1258C	20566	Thread (under) Take-up Set Screw, for 131407.....
1304C	20530	Arm Rotary Shaft Ball Bearing (intermediate) Case Set Screw.....
1309C	20530	Arm Rock Shaft Adjusting Screw.....
1423J	20566	Slack Thread Regulator Holder Crank Cap Screw.....
1449J	20566	Thread (upper) Take-up Plate Spring Screw, for 131335.....
1492E	20566	Needle Bar Connecting Stud Clamping Screw, for 131400.....
1498F	20582	Needle Set Screw, for 131044.....
1499J	20593	Lap Seam Feller Screw.....
1520J	20566	" Bar Connecting Link Hinge Stud Nut..
1539W	20581	Pressure Regulating Thumb Screw Lock Nut

NUMERICAL LIST OF PARTS

No.	Plate	Name
1547J	20539	Tension upper thread) Releasing Shaft Stop Screw Nut.....
1733	20546	011 Pipe (back of arm) Coupling Nut (brass).....
1733	20546	011 Pipe (front of arm) Coupling Nut (brass) for 68498 and 68500.....
2102	20565	Tension (under thread) Disc.....
2102	20565	" (upper thread) Disc.....
2763	20592	Rock Shaft, for 23767.....
2766	20592	" " Knee Arm Hub with 356C, for 6336.....
2767	20592	Rock Shaft Knee Plate with 356C, for 6336
2770	20592	" " Stop Dog with 356C, for 23767
4604	20581	Presser Bar Spring (auxiliary) Guide Rivet, for 131198.....
4822	20545	Wrench for 1547 (Accessories).....
4879	20545	Chain Connecting Link, for 150452.....
4882	20547	Treadle Shaft, for 150452.....
6335	20592	Rock Shaft Knee Arm, for 6336.....
6336	-----	Rock Shaft Knee Arm complete for 23767, Nos. 2766, 2767 and 6335.....
6337	20592	Rock Shaft Lifting Bracket with two 356C for 23767.....
6439	-----	Chain, 36 in. to 45 in. with 56864 and 56865.....
7071	20533	Feed Eccentric Clamping Washer, for 54025
7071	20533	Thread (under) Take-up Thread Guide (left) Screw Washer, for 131412.....
7071	20533	Thread (under) Take-up Thread Guide (right) Screw Washer, for 131412....
7125	20592	Rock Shaft Lifting Bracket Hook, for 23767.....
8908	20545	Wrench for 1520 (Accessories).....
9525	20546	Thread Unwinder Thread Separator Bracket Arm Clamping Screw Washer, for 150060
9525	20546	Thread Unwinder Thread Separator Bracket Arm Screw Washer, for 150061.....
9842	20547	Machine Base Screw Stud Nut Washer, for 131264.....
11173	20565	Presser Bar Lifting Bracket Guide.....
12242	20592	Rock Shaft Hanger with two wood screws 1 in. No. 10, for 23767.....
*15404	-----	Trade Mark, for 131446.....
15405	-----	" " Rivet, for 131446.....
18055	-----	Presser Foot Yielding Heel Connection Hinge Pin, for 131542.....
18055	-----	Presser Foot Yielding Heel Hinge Pin, for 131542.....
*23729	-----	Feed Eccentric Body, for 54025.....

No.	Plate	Name
23767	20592	Rock Shaft complete, Nos. 2763, 2770, 6336, 6337, 7125 and two 12242.....
25303	20545	Presser Bar Ball, size 1/4 in. for 64330
26276	20565	Presser Foot Hinge Pin, for 131159, 131243 131592, 131594 and 131597.....
26276	20565	Presser Foot Yielding Heel Connection Hinge Pin, for 131550.....
26276	20565	Presser Foot Yielding Heel Hinge Pin, for 131550.....
27114	-----	Presser Foot Yielding Heel Connection Spring, for 131542.....
27739	20580	Thread Unwinder Thread Cone (wood) for large cones, for 150062.....
27998	9520	Bench Stand Flap Hook and Eye (brass) with wood screw 1/2 in. No. 5, for 79772.....
29234	20533	Face Plate (upper half) Position Plate..
32062	20581	Thread (under) Take-up Stripper Washer, for 131412.....
32572	20582	Tension (upper thread) Releasing Disc...
36030	-----	Presser Foot Shank, for 131594.....
37563	-----	Chain, length 15 in. with 56864 and 56865
38456	20565	Presser Bar Bushing (upper).....
38467	20542	" " Spring (flat).....
38468	20565	" " " Stud.....
41538	-----	Bench Stand Flush Bolt with Plate complete for 79772, Nos. 126247, 126248 and four brass wood screws 5/8 in. No. 4.....
42365	20530	Arm Rock Shaft Oil Pad (braided cotton) for oiling Back Bearing.....
42367	20530	Arm Rotary Shaft (front) Bearing Oil Pad (lower) braided cotton.....
43503	20546	Looper Throw-out Handle Plunger Spring..
46009	20566	Thread (upper) Eyelet.....
46087	-----	Presser Foot Shank, for 131592.....
*49189	-----	Oil Pipe (back of arm) Connection Cap, for 68494.....
*49189	-----	Oil Pipe (front of arm) Connection Cap, for 131003.....
*49191	-----	Oil Pipe (back of arm) Sleeve, for 68492
*49191	-----	" " (front of arm) Sleeve, for 68498 and 68500.....
50073J	20533	Feed Dog Screw, when movable Needle Guard is used.....
50083C	20530	Arm Rock Shaft Crank (back) Set Screw, for 131072 and 131486.....
50326C	20565	Tension (under thread) Screw Stud, for 59539.....

No.	Plate	Name
50326C	20565	Tension (upper thread) Screw Stud, for 59539.....
50396F	20533	Cloth Plate Screw (right).....
50429C	20533	Feed Dog Stop Screw, for 131397.....
50438J	20566	Thread (under) Take-up Oil Guard Screw for 131412.....
50470J	20582	Thread (under) Take-up Thread Guard Screw, for 131412.....
50473F	20533	Cloth Plate Thread Guard Screw (upper)
50608R	20530	Arm Hole Plug Screw, for access to Crank Connecting Rod (upper bearing).....
51061C	20533	Feed Eccentric Body Set Screw, for 54025.....
51119J	20546	Looper Holder Screw.....
51224W	20530	Arm Side Cover Cap Thumb Screw, for 131278.....
51224W	20530	Face Plate (upper half) Thumb Screw..
51263D	20546	Looper Carrier Connection Shaft Sleeve Cap Screw.....
51283C	20533	Balance Wheel Set Screw, for 131483...
51570C	20565	Tension (under thread) Regulating Thumb Nut, for 59539.....
51570C	20565	Tension (upper thread) Regulating Thumb Nut, for 59539.....
51576E	20547	Machine Base Screw Stud Nut, for 131264
53225	20539	Thread (under) Eyelet (back).....
*54024	-----	Feed Eccentric with 138306, for 54025.
54025	20583	Feed Eccentric (adjustable) complete for 131502, Nos. 1103C, 23729, 54024 and two each 217J, 7071 and 51061C
54027	20562	Looper Carrier with two 175E, for 131111.....
54038	20582	Needle Guard (stationary) Holder.....
54047	20539	Tension (upper thread) Releasing Shaft Crank with 624C.....
54048	20539	Tension (upper thread) Releasing Shaft Crank Link.....
54067	20582	Needle Guard (stationary) for 3/32 in. to 5/32 in. gauges.....
54068	20582	Needle Guard (stationary) for 3/16 in. to 9/32 in. gauges.....
54069	20582	Needle Guard (stationary) for 5/16 in. to 3/8 in. gauges.....
54070	20566	Tension (upper thread) Bracket.....
54071	20581	" " " Releasing Shaft
54095	20566	Thread (upper) Take-up Plate, for 131335.....
54120	-----	Presser Foot Shank, for 131159.....
54218	20530	Arm Rotary Shaft (front) Bearing Oil Pad (upper) braided cotton.....

No.	Plate	Name
54227	20562	Looper Carrier Connection, for 131111...
54228	20562	" " " Shaft, for 131111
54242	20582	Slack Thread Controller Clamp.....
54242	20582	Thread (under) Take-up Stripper Clamp, for 131412.....
54477	20547	Machine Base Screw Stud, to fasten base to table, for 131264.....
54969	20530	Arm Rock Shaft Oil Pad (braided cotton) for oiling Intermediate Bearing.....
54988	20565	Tension (upper thread) Releasing Pin....
56864	20545	Chain Hook (large) for 6439 and 37563...
56865	20545	" " (small) for 6439 and 37563...
57076	20565	Tension (under thread) Thread Guide.....
57076	20565	" (upper thread) Thread Guide (double).....
57234	20583	Feed Rocking Frame Hinge Pin.....
57235	20533	" " " " " Bushing....
59343	20533	" Bar Hinge Pin Collar with 735C, for 131398.....
59534	20565	Tension (under thread) Spring.....
59535	20581	" (upper thread) Spring.....
59537	20565	" (under thread) Spring Bushing (large).....
59537	20565	Tension (upper thread) Spring Bushing (large).....
59538	20565	Tension (under thread) Spring Bushing (small).....
59538	20565	Tension (upper thread) Spring Bushing (small).....
59539	-----	Tension (under thread) Screw Stud 50326C with 51570C.....
59539	-----	Tension (upper thread) Screw Stud 50326C with 51570C.....
60656	9520	Bench Stand Hinge, for 79772.....
64315	20546	Looper Driving Shaft and Feed Lifting Eccentric Oil Hole Plug, for 131110.
64319	20566	Needle Bar (hollow) for 131045.....
64320	20581	" " Bushing (upper).....
64330	20542	Presser Bar with 25303.....
68123	20582	Needle Guard (movable) Clamp.....
68164	20565	Thread (upper) Take-up Plate Spring, for 131335.....
68184	20542	Presser Bar Lifting Lever Extension.....
68222	20549	Belt Guard with two wood screws 1 in. No. 12.....
68261	20539	Tension (upper thread) Releasing Shaft Spring.....
68350	20530	Arm Oil Cup, for oiling Arm Rock Shaft Front Bearing.....
68368	20532	Cloth Plate Slide (left) for 131051.....

NUMERICAL LIST OF PARTS

No.	Plate	Name
68426	20529	Arm Bottom Cover.....
68429	20529	" " " Gasket (cork).....
*68430	-----	" Oil Cup, for 131309.....
68433	20584	" Rock Shaft Bushing (back).....
68435	20584	" " " " " Cap.....
68436	20584	" " " " (intermediate)...
68448	20529	" Side Cover Gasket (cork).....
68459	-----	Crank Connecting Rod 131471 with 131072, for 131510.....
68460	20532	Face Plate (lower half).....
68461	20532	" " " " Gasket (cork)...
68467	20583	Feed Bar Wearing Plate, for 131397.....
68478	20583	Looper Carrier Connection Shaft Sleeve Eccentric.....
68479	20562	Looper Carrier Driver with four 1755, for 131111.....
*68483	-----	Looper Driving Shaft and Feed Lifting Eccentric Bracket with 761E, for 131446.....
68464	20583	Looper Driving Shaft and Feed Lifting Eccentric Bushing.....
68485	20583	Looper Throw-out Handle with two 443C...
68486	20546	" " " Plunger.....
68488	20581	Needle Bar Connecting Link and Thread (upper) Controller, for 131399.....
68489	20581	Needle Bar Connecting Link Hinge Stud (hollow) for 131399.....
68492	20538	Oil Pipe (back of arm) with 49191 and 68497, for oiling Feed Rocking Frame Hinge Pin Front Bearing.....
68493	20538	Oil Pipe (back of arm) Clamp.....
68494	20538	" " " " " Connection with 49189, 68495 and two 198E, for oil- ing Feed Rocking Frame hinge Pin (back) Bearing.....
68495	20533	Feed Bar Slide Block Oil Pad (wick) for 134259.....
68495	20533	Oil Pipe (back of arm) Connection Oil Pad (wick) for 68494.....
68496	20538	Oil Pipe (back of arm) Coupling.....
68497	20533	Feed Connecting Rod Oil Pad (wick) for 131500.....
68497	20533	Looper Driving Shaft and Feed Lifting Eccentric Front Bearing Oil Pad (wick).....
68497	20533	Oil Pipe (back of arm) Oil Pad (wick) for 68492.....
68497	20533	Oil Pipe (front of arm) Oil Pad (wick) for 131112 and 131113.....

No.	Plate	Name
68498	20538	Oil Pipe (front of arm) with 131089 and two each 1733 and 49191, for oiling Looper Driving Shaft and Feed Lift- ing Eccentric Front Bearing, for 131258.....
68500	20538	Oil Pipe (front of arm) with 1733, 49191 131084 and 131089, for oiling Arm Rotary Shaft Front Bearing, for 131258.....
79772	-----	Bench Stand with 27998, two each 41538, 126849, three wood screws 1-1/4 in. No. 12, four each 60656, wood screws 1-1/4 in. No. 10 and sixteen wood screws 5/8 in. No. 7.....
120341	20545	Tweezer (curved) Accessories.....
120344	20545	Oiler (copper plated) with 120345 (Ac- cessories).....
120345	20545	Oiler Spout, 4-1/2 in. long, for 120344 (Accessories).....
120440	20545	Screw Driver (large) Accessories.....
121108	20545	" " (small) Accessories.....
121438	20593	Lap Seam Feller (adjustable) on Shank, for sleeving, for medium heavy and heavy-weight material, for 147-102 Machine.....
121440	20593	Lap Seam Feller (adjustable) on Shank, for medium heavy and heavy-weight material, for 147-103 Machine.....
126247	9520	Bench Stand Flush Bolt, for 41538.....
126248	9520	" " " " " Plate, for 41538.....
126249	20549	Treadle, for 150452.....
126250	20547	" Spring, for 150452.....
126849	9520	Bench Stand Flap Hinge with four wood screws 3/4 in. No. 7, for 79772.....
127838	20530	Arm Rock Shaft Crank (front) Pin, for 131474.....
128390	-----	Presser Foot Plate Hinge Stud, for 131542 and 131550.....
128419	20546	Looper Carrier Connection Shaft Oil Pad (braided cotton).....
128510	20532	Balance Wheel Cover.....
131002	20538	Oil Pipe (front of arm) Connection with 131049 and two 198E, for oiling Looper Throw-out Device.....
131003	20538	Oil Pipe (front of arm) Connection with 49189 and two 198E, for 131112 and 131113.....
131004	20538	Oil Pipe (front of arm) Coupling (center)

No.	Plate	Name
131004	20538	Oil Pipe (front of arm) Coupling (left).
131006	20565	Presser Bar Bushing (lower) for 147-102 Machine.....
131011	20539	Tension (upper thread) Releasing Shaft Spring Position Plate.....
131012	20542	Tension (under thread) Bracket.....
131022	20547	Machine Base Screw Stud Bushing (rubber) for 131446.....
131025	20566	Slack Thread Controller.....
131028	20546	Looper Driving Shaft and Feed Lifting Eccentric Bushing Oil Plug.....
131032	20585	Feed Dog, 17 teeth (16 teeth to the inch) for 3/32 in. to 1/4 in. gauges, for 131209 and 131210, for 147-102 Machine.....
131044	20581	Needle Clamp with two 1498F, for 3/32 in. to 1/2 in. gauges, for 131045...
131045	-----	Needle Bar complete, for 3/32 in. to 1/2 in. gauges, for 147-102 Machine, Nos. 64319 and 131044.....
*131049	-----	Oil Pipe (front of arm) Connection Cap, for 131002.....
131050	20532	Cloth Plate Slide (left) Spring, for 131051.....
131051	-----	Cloth Plate Slide (left) complete, Nos. 68368, 131050 and two 725J, for 131388 to 131393 and 131467.....
131052	20562	Looper Holder with 452C and 1120C, for 147-102 Machine.....
131056	20530	Arm Rock Shaft Adjusting Screw Washer...
131072	20566	" " " Crank (back) ball bearing solid, with two 50083C, for 68459...
131084	20538	Oil Pipe (front of arm) Connection with 131085 and two 198E, for 68500.....
*131085	-----	Oil Pipe (front of arm) Connection Cap, for 131084.....
*131086	-----	Oil Pipe (front of arm) Coupling (right) for 131087.....
131087	20538	Oil Pipe (front of arm) Coupling (right) 131086 with 131088.....
*131088	-----	Oil Pipe (front of arm) Coupling (right) Oil Lead, for 131087.....
131089	20546	Oil Pipe (front of arm) Oil Pad (wick) for 68498 and 68500.....
131093	20586	Feed Dog, 16 teeth (16 teeth to the inch) for 3/8 in. and 13/32 in. gauges, for 131213 and 131214, for 147-102 Machine.....
131095	20584	Arm Rock Shaft Bushing (back) Cap Washer (fibre).....

No.	Plate	Name
*131110	20583	Looper Driving Shaft and Feed Lifting Eccentric with two 64315, for 131111
*131111	-----	Looper Driving Shaft and Feed Lifting Eccentric 131110 with 54027, 54227, 54228 and 68479, for 131488 and 131510.....
131112	20538	Oil Pipe (front of arm) with 68497 and 131003, for oiling Feed Bar Slide Block, for 131258.....
131113	20538	Oil Pipe (front of arm) with 68497 and 131003, for oiling Feed Connecting Rod, for 131258.....
131115	20589	Throat Plate, for 1/4 in. to 3/8 in. gauges, for 131241, for lap seam felling, for making longer stitch than regular, for 147-102 Machine...
131118	20588	Feed Dog, 16 teeth (14 teeth to the inch) for 3/8 in. to 1/2 in. gauges, for 131124 and 131215, for 147-102 Machine.....
131121	20582	Needle Guard (movable) for 13/32 in. to 1/2 in. gauges.....
131124	20588	Throat Plate, for 3/8 in. to 1/2 in. gauges, for 131118, for lap seam felling, for 147-102 Machine.....
131131	20562	Looper (back) closed eye, for general work.....
131132	20562	Looper (front) closed eye, for general work.....
131158	-----	Presser Foot Plate, for 131159.....
131159	20585	Presser Foot (hinged) complete, for 3/32 in. to 3/8 in. gauges, for lap seam felling, for 147-102 Machine, Nos. 26276, 54120 and 131158.....
131174	20582	Needle Guard (movable) for 3/16 in. to 3/8 in. gauges.....
131175	20582	Needle Guard (stationary) for 13/32 in. to 1/2 in. gauges.....
131185	20526	Machine Base Oil Drain Jar (glass) for 131268.....
131188	20526	Machine Base Oil Drain Jar Clamp, for 131217.....
131189	20526	Machine Base Oil Drain Jar Clamp Lever, for 131217.....
131191	20526	Machine Base Oil Drain Jar Cap, for 131268.....
131197	20583	Feed Bar Hinge Pin Eccentric, for 131398
131198	20581	Presser Bar Spring (auxiliary) complete, for 147-103 Machine, Nos. 4604, 131231 and 131232.....

No.	Plate	Name
131205	20547	Machine Base Screw Stud, to position machine on base, for 131264.....
131209	20585	Throat Plate, for 3/32 in. to 1/4 in. gauges, for 131032, for lap seam felling, for 147-102 Machine.....
131210	20585	Throat Plate, for 3/32 in. to 1/4 in. gauges, for 131032, for plain stitching, for 147-102 Machine.....
131211	20587	Throat Plate, for 5/32 in. to 11/32 in. gauges, for 131321, for lap seam felling, for 147-102 Machine.....
131212	20587	Throat Plate, for 5/32 in. to 11/32 in. gauges, for 131321, for plain stitching, for 147-102 Machine.....
131213	20586	Throat Plate, for 3/8 in. and 13/32 in. gauges, for 131093, for lap seam felling, for 147-102 Machine.....
131214	20586	Throat Plate, for 3/8 in. and 13/32 in. gauges, for 131093, for plain stitching, for 147-102 Machine.....
131215	20588	Throat Plate, for 3/8 in. to 1/2 in. gauges, for 131118, for plain stitching, for 147-102 Machine.....
131217	-----	Machine Base Oil Drain Jar Clamp 131188 with 131189, for 131268.....
*131231	-----	Presser Bar Spring (auxiliary) for 131198.....
*131232	-----	Presser Bar Spring (auxiliary) Guide, for 131198.....
131233	-----	Presser Foot Shank, for 131243.....
131240	20583	Feed Rocking Frame with two 453C, for 131398.....
131241	20589	Feed Dog, 12 teeth (10 teeth to the inch) for 3/16 in. to 3/8 in. gauges, for 131115, for 147-102 Machine.....
131242	-----	Presser Foot Plate, for 131243.....
131243	20589	Presser Foot (hinged) complete, for 3/16 in. to 1/2 in. gauges, for lap seam felling work shirts and overalls, for 147-102 Machine, Nos. 26276, 131233 and 131242.....
131258	-----	Oil Pipe (front of arm) complete, Nos. 68498, 68500, 131112 and 131113.....
131263	20549	Machine Base, for 131264.....
131264	-----	Machine Base complete, Nos. 131263, three each 9842, 51576E, 54477 and four each 131205 and 131279, for 131328..
131265	20526	Machine Base Oil Drain Jar Nipple (long) for 131268.....

No.	Plate	Name
131266	20526	Machine Base Oil Drain Jar Nipple (short) for 131268.....
131267	20526	Machine Base Oil Drain Jar Nipple Elbow, for 131268.....
131268	-----	Machine Base Oil Drain Jar (swinging type) complete, Nos. 131185, 131191, 131217, 131266 and two each 1247C, 131265 and 131267, for 131328.....
131270	20581	Needle Bar Connecting Link Hinge Stud Oil Pad (wick).....
131276	20526	Arm Side Cover (oil vent) for 131278....
131277	20526	" " " Cap, for 131278.....
131278	-----	Arm Side Cover (oil vent) complete, Nos. 51224W, 131276, 131277 and 131280...
131279	20547	Machine Cushion (felt) for 131264.....
131280	20530	Arm Side Cover Cap Position Pin, for 131278.....
131291	20581	Needle Bar Bushing (lower).....
131292	20581	Presser Bar Bushing (lower) for 147-103 Machine.....
131293	20584	Arm Rock Shaft, for 131474.....
131305	20529	" Oil Cup Drip Pan with two 563C.....
131309	20529	" " " 68430 with 131310, for filling Oil Reservoir.....
131310	20529	Arm Oil Cup Oil Tube, for 131309.....
131319	20530	" " " Pad (braided cotton) for 68350.....
131321	20587	Feed Dog, 16 teeth (16 teeth to the inch) with row of teeth between the needle for 5/32 in. to 11/32 in. gauges, for 131211 and 131212, for 147-102 Machine.....
131328	-----	Machine Base and Oil Drain Jar (swinging type) complete, Nos. 131264 and 131268
131334	20566	Thread (upper) Take-up, for 131335.....
131335	-----	Thread (upper) Take-up complete, Nos. 1449J, 54095, 68164 and 131334.....
131366	20584	Arm Rotary Shaft Ball Bearing (back) for 131526.....
131366	20584	Arm Rotary Shaft Ball Bearing (intermediate).....
131369	20529	Arm Rotary Shaft Ball Bearing (back) Case Cap, for 131479.....
131370	20530	Arm Rotary Shaft Ball Bearing (back) Case Position Stud.....
131374	20592	Cloth Plate, for 131388 to 131393.....
131375	20567	" " Slide (right) No Throat Plate clearance cut, for 131382.....
131376	20567	Cloth Plate Slide (right) 1/16 in. Throat Plate clearance cut, for 131383.....

No.	Plate	Name
131377	20567	Cloth Plate Slide (right) 7/64 in. Throat Plate clearance cut, for 131384.....
131378	20568	Cloth Plate Slide (right) 1/8 in. Throat Plate clearance cut, for 131385.....
131379	20568	Cloth Plate Slide (right) 9/64 in. Throat Plate clearance cut, for 131386.....
131380	20568	Cloth Plate Slide (right) 3/16 in. Throat Plate clearance cut, for 131387.....
131381	20532	Cloth Plate Slide (right) Spring, for 131382 to 131387.....
131382	-----	Cloth Plate Slide (right) complete (No Throat Plate clearance cut) for 131388, Nos. 131375, 131381 and two 725J.....
131383	-----	Cloth Plate Slide (right) complete (1/16 in. Throat Plate clearance cut) for 131389, Nos. 131376, 131381 and two 725J.....
131384	-----	Cloth Plate Slide (right) complete (7/64 in. Throat Plate clearance cut) for 131390, Nos. 131377, 131381 and two 725J.....
131385	-----	Cloth Plate Slide (right) complete (1/8 in. Throat Plate clearance cut, for 131391, Nos. 131378, 131381 and two 725J.....
131386	-----	Cloth Plate Slide (right) complete (9/64 in. Throat Plate clearance cut) for 131392 and 131467, Nos. 131379 131381 and two 725J.....
131387	-----	Cloth Plate Slide (right) complete (3/16 in. Throat Plate clearance cut) for 131393, Nos. 131380, 131381 and two 725J.....
131388	-----	Cloth Plate complete, for Throat Plates with no offset, Nos. 131051, 131374 and 131382.....
131389	-----	Cloth Plate complete, for Throat Plates with 1/16 in. offset, Nos. 131051, 131374 and 131383.....
131390	-----	Cloth Plate complete, for Throat Plates with 7/64 in. offset, Nos. 131051, 131374 and 131384.....
131391	-----	Cloth Plate complete, for Throat Plates with 1/8 in. offset, Nos. 131051, 131374 and 131385.....
131392	-----	Cloth Plate complete, for Throat Plates with 9/64 in. offset, Nos. 131051, 131374 and 131386.....

No.	Plate	Name
131393	-----	Cloth Plate complete, for Throat Plates with 3/16 in. offset, Nos. 131051, 131374 and 131387.....
131394	20592	Cloth Plate Thread Guard.....
131395	20532	Face Plate (upper half).....
131396	20583	Feed Bar, for 131397.....
131397	20583	Feed Bar complete for 131398, Nos. 50429C 68467, 131396 and two 207E.....
131398	-----	Feed Rocking Frame 131240 with 59343, 131197 and 131397.....
131399	-----	Needle Bar Connecting Link and Thread (upper) Controller 68488 with 68489 and 131400.....
131400	20566	Needle Bar Connecting Stud with 211F and 1492E, for 131399.....
131401	20565	Presser Bar Lifting Bracket with 453C...
131402	20542	" " " Lever.....
131403	20565	Slack Thread Regulator.....
131404	20565	" " " Holder.....
131405	20565	" " " Crank with 171E.....
131406	20565	Slack Thread Regulator Holder Crank Connecting Link.....
131407	20539	Thread (under) Take-up with 1258C.....
131408	20582	" " " Oil Guard, for 131412.....
131409	20582	Thread (under) Take-up Stripper, for 131412.....
131410	20542	Thread (under) Take-up Stripper Plate, for 131412.....
131411	20542	Thread (under) Take-up Stripper Plate Bracket, for 131412.....
131412	-----	Thread (under) Take-up Stripper Plate Bracket 131411 with 32062, 50438J, 54242, 131408 to 131410, 131413 to 131415, two each 207J, 7071, 50470J and four 190J.....
131413	20582	Thread (under) Take-up Thread Guard (fibre) for 131412.....
131414	20582	Thread (under) Take-up Thread Guide (left) for 131412.....
131415	20582	Thread (under) Take-up Thread Guide (right) for 131412.....
*131446	-----	Arm, upper and lower (solid) with 948J, 15404, 68483, two 15405 and four 131022.....
131456	20584	Arm Rock Shaft Flanged Bushing (front)..
131457	20539	" Rotary Shaft Bushing (front).....
131458	20562	Looper (back) closed eye, for lap seam felling.....

NUMERICAL LIST OF PARTS

No.	Plate	Name
131459	20562	Looper (front) closed eye, for lap seam felling.....
131466	20592	Cloth Plate, for 131467.....
131467	-----	Cloth Plate complete, for Throat Plate with 9/64 in. offset, for 147-103 Machine, Nos. 131051, 131386 and 131466.....
*131471	20584	Crank Connecting Rod with two each 896C and 1057C, for 68459 and 131489.....
131474	-----	Arm Rock Shaft 131293 with 1235F, 127838 and 131475.....
131475	20584	Arm Rock Shaft Crank (front) with 853C, for 131474.....
131478	20529	Arm Rotary Shaft Ball Bearing (back) Case, for 131479.....
131479	-----	Arm Rotary Shaft Ball Bearing (back) Case 131478 with 131369 and three 205C, for 131526.....
131480	20539	Arm Rotary Shaft Ball Bearing (back) spacing Collar, for 131526.....
131481	20584	Arm Rotary Shaft Ball Bearing (intermediate) Case.....
131482	20539	Arm Rotary Shaft Ball Bearing (intermediate) Collar with two 457C.....
131483	20532	Balance Wheel, 2 in. pulley, with two 51283C.....
131486	20584	Arm Rock Shaft Crank (back) ball bearing solid, with two 50083C, for 131489..
131487	20592	Arm Rotary Shaft, for 131488 and 131510.
131488	-----	" " " 131487 with 640E, 131111 131489 and 131502, for 147-102 Machine.....
131489	-----	Crank Connecting Rod 131471 with 131486, for 131488.....
131500	20583	Feed Connecting Rod 1057C, 68497, 134260 and two 896C, for 131502.....
131502	-----	Feed Connecting Rod 131500 with 54025, for 131488 and 131510.....
131510	-----	Arm Rotary Shaft 131487 with 640E, 68459 131111 and 131502, for 147-103 Machine.....
131526	-----	Arm Rotary Shaft Ball Bearing (back) Case with Ball Bearings complete, Nos. 131479, 131480 and two 131366..
131529	20590	Feed Dog, 14 teeth (10 teeth to the inch) for 1/4 in. to 3/8 in. gauges, for 131536, for 147-103 Machine.....
131534	-----	Presser Foot Yielding Heel Connection Spring, for 131550.....

No.	Plate	Name
131536	20590	Throat Plate, for 1/4 in. to 3/8 in. gauges, for 131529, for 147-103 Machine.....
131537	20591	Feed Dog, 19 teeth (10 teeth to the inch) for 3/16 in. to 1/4 in. gauges, for 131543, for 147-103 Machine.....
131538	-----	Presser Foot Plate, for 131542.....
131539	-----	" " Shank, for 131542.....
131540	-----	" " Yielding Heel, for 131542..
131541	-----	" " " " Connection, for 131542.....
131542	20591	Presser Foot (triple hinged) complete, for 3/16 in. to 1/4 in. gauges, for 147-103 Machine, Nos. 27114, 131538 to 131541 and two each 665J, 18055 and 128390.....
131543	20591	Throat Plate, for 3/16 in. to 1/4 in. gauges, for 131537, for 147-103 Machine.....
131546	-----	Presser Foot Plate, for 131550.....
131547	-----	" " Shank, for 131550.....
131548	-----	" " Yielding Heel, for 131550..
131549	-----	" " " " Connection, for 131550.....
131550	20590	Presser Foot (triple hinged) complete, for 3/16 in. to 3/8 in. gauges, for 147-103 Machine, Nos. 131534, 131546 to 131549 and two each 665J, 26276 and 128390.....
*131579	-----	Looper Holder Body, for 131580.....
131580	20581	" " " 131579 with 452C and 1120C, for 147-103 Machine.....
131591	-----	Presser Foot Plate, for 131592.....
131592	20585	Presser Foot (hinged) complete, for 3/32 in. to 13/32 in. gauges, for plain stitching, for 147-102 Machine, Nos. 26276, 46087 and 131591.....
131593	-----	Presser Foot Plate, for 131594.....
131594	20588	Presser Foot (hinged) complete, for 3/8 in. to 1/2 in. gauges, for plain stitching, for 147-102 Machine, Nos. 26276, 36030 and 131593.....
131595	-----	Presser Foot Plate, for 131597.....
131596	-----	" " Shank, for 131597.....
131597	20588	Presser Foot (hinged) complete, for 3/8 in. to 1/2 in. gauge, for lap seam felling, for 147-102 Machine, Nos. 26276, 131595 and 131596.....
134258	20533	Feed Bar Slide Block, for 134259.....

No.	Plate	Name
134259	20533	Feed Bar Slide Block 134258 with 68495 and 134260.....
134260	20533	Feed Bar Slide Block Oil Pad Retainer, for 134259.....
134260	20533	Feed Connecting Rod Oil Pad Retainer, for 131500.....
138306	20533	Feed Eccentric Lubricating Pad (wood) for 54024.....
139017	20530	Arm Hole Plug Screw Washer.....
*150057	-----	Thread Unwinder Thread Separator, for 150058.....
150058	9505	Thread Unwinder Thread Separator 150057 with 150059, for 150061.....
*150059	-----	Thread Unwinder Thread Separator Bracket for 150058.....
150060	9505	Thread Unwinder Thread Separator Bracket Arm with 164J and 9525, for 150061..
150061	-----	Thread Unwinder Thread Separator complete for 150062, Nos. 164J, 9525, 150058 and 150060.....
150062	9505	Thread Unwinder complete, Nos. 150061, 201696J, 202490, 225324, 225326, 225388, two 225257, three wood screws 7/8 in. No. 12 and four each 150203 and 225391.....
150203	9505	Thread Unwinder Spool Rest Cushion (felt) for 150062.....
150451	20549	Treadle Stand, for 150452.....
150452	20549	Treadle complete, Nos. 4879, 4882, 126249 126250, 150451 and two wood screws 1 in. No. 16.....
200383C	20546	Thread Unwinder Spool Rest Rod Set Screw for 202490.....
201018C	20546	Thread Unwinder Spool Rest Set Screw, for 225257.....
201696J	20546	Thread Unwinder Thread Guide Lock Nut, for 150062.....
202490	9505	Thread Unwinder Spool Stand with 200383C for 150062.....
225257	9505	Thread Unwinder Spool Rest (for two spools) with 201018C, for 150062....
225322	20546	Thread Unwinder Thread Guide Rod Washer, for 225324.....
225324	9505	Thread Unwinder Thread Guide Rod with 208E and 225322, for 150062.....
225326	20546	Thread Unwinder Thread Guide Position Cup, for 150062.....
225388	9505	Thread Unwinder Spool Rest Pod, for 150062.....
225390	20580	Thread Unwinder Thread Cone Holder, for inverted cones, for 150062.....
225391	9505	Thread Unwinder Thread Guide, for 150062.

PLATE 9505—ONE-SIXTH SIZE

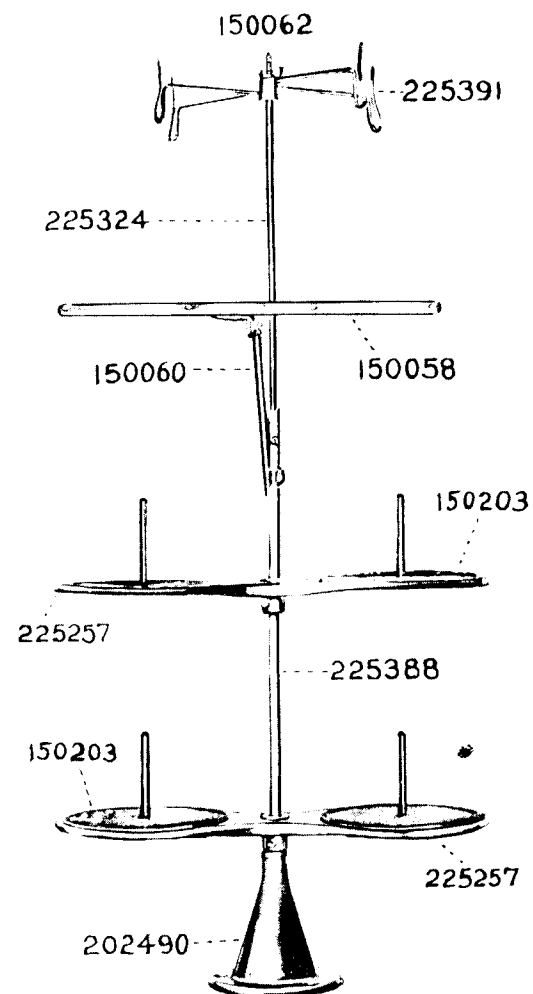
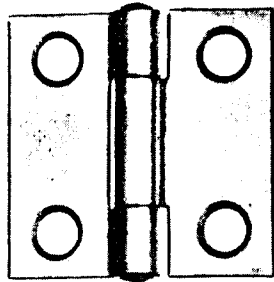

PLATE 9520 - FULL SIZE

126247



126849



126248



27998

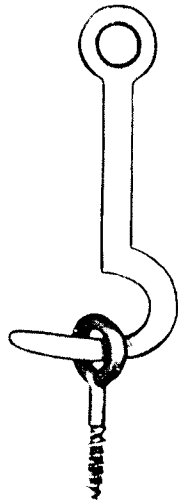

60656

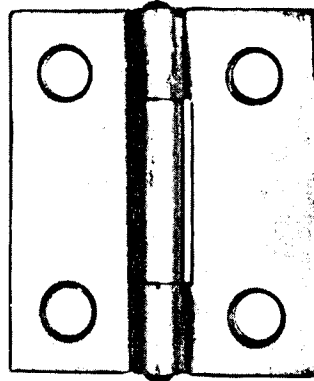
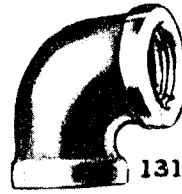

PLATE 20526—ONE-HALF SIZE

131267



131266



131185

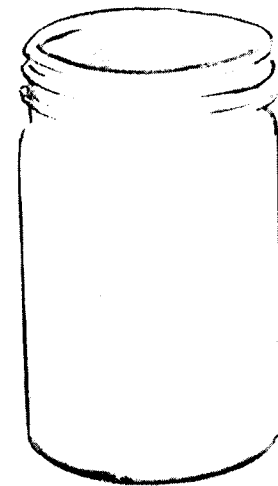

131189

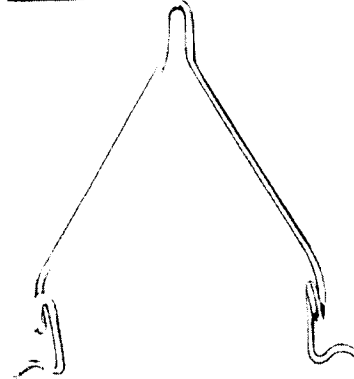

131277

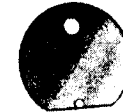

131191

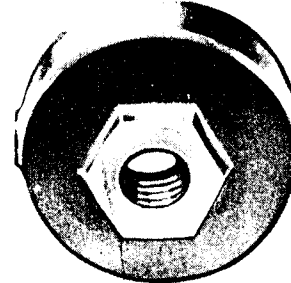

131276

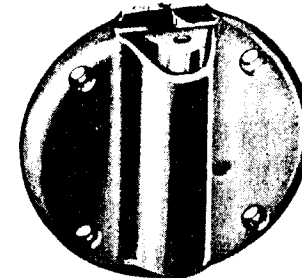

131188

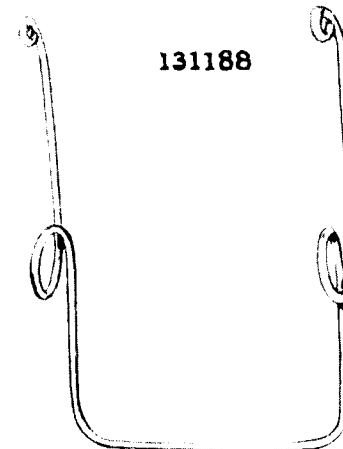

131265



PLATE 20529 - ONE-HALF SIZE

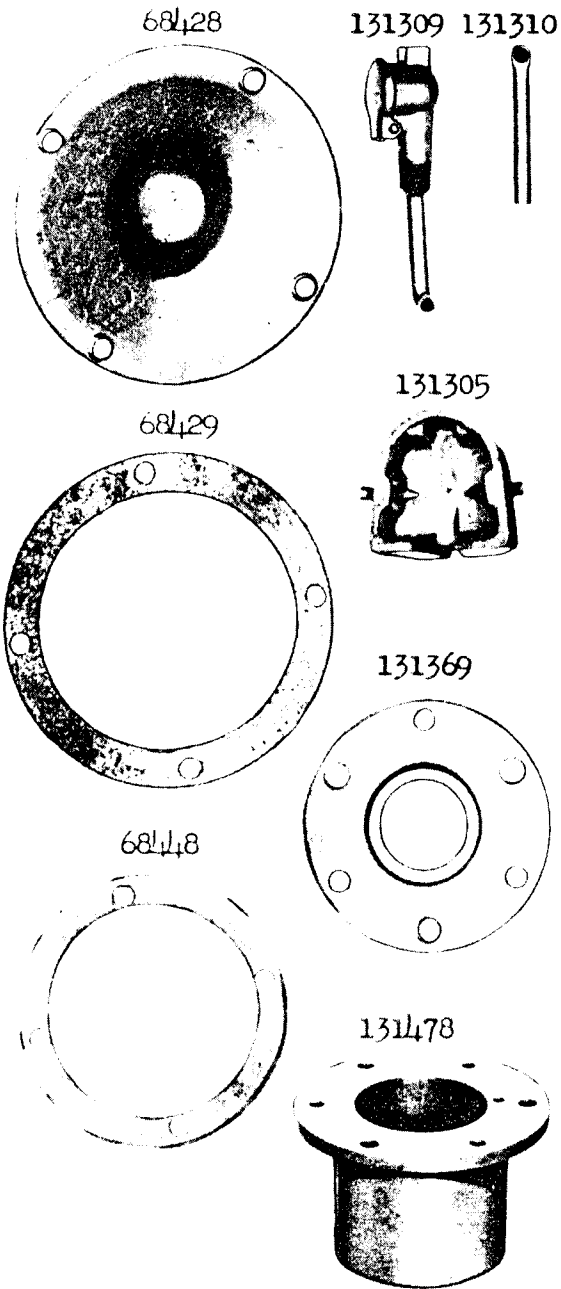

PLATE 20530 - FULL SIZE

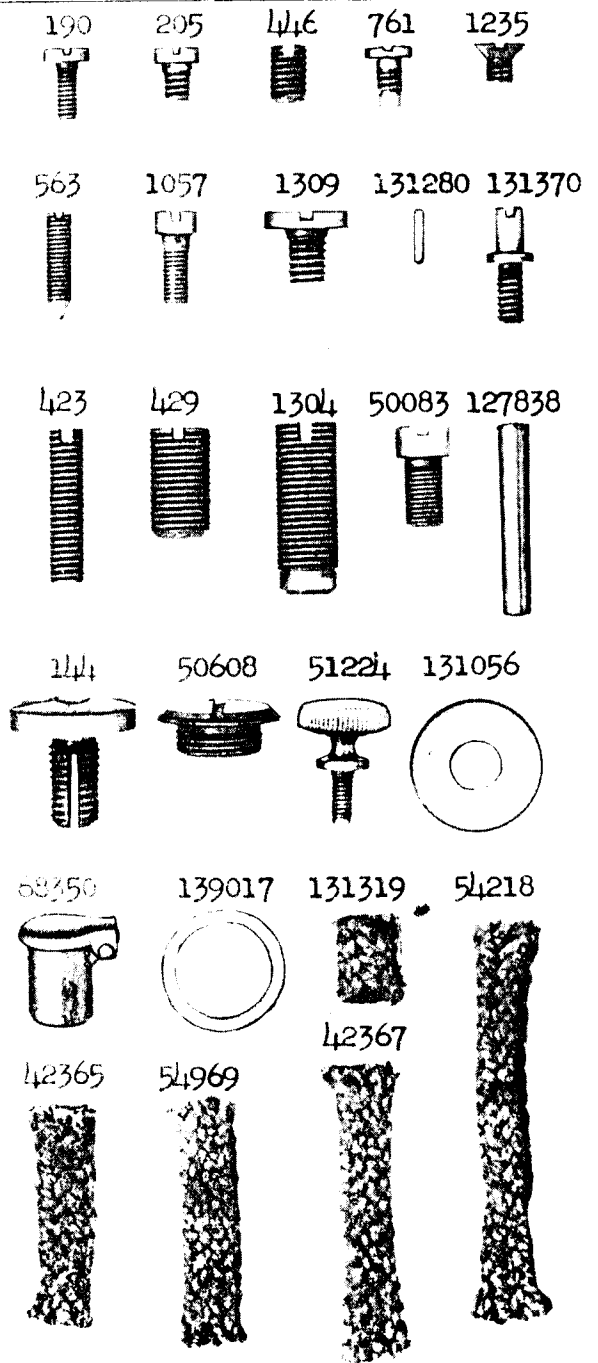

PLATE 20532 - ONE-HALF SIZE

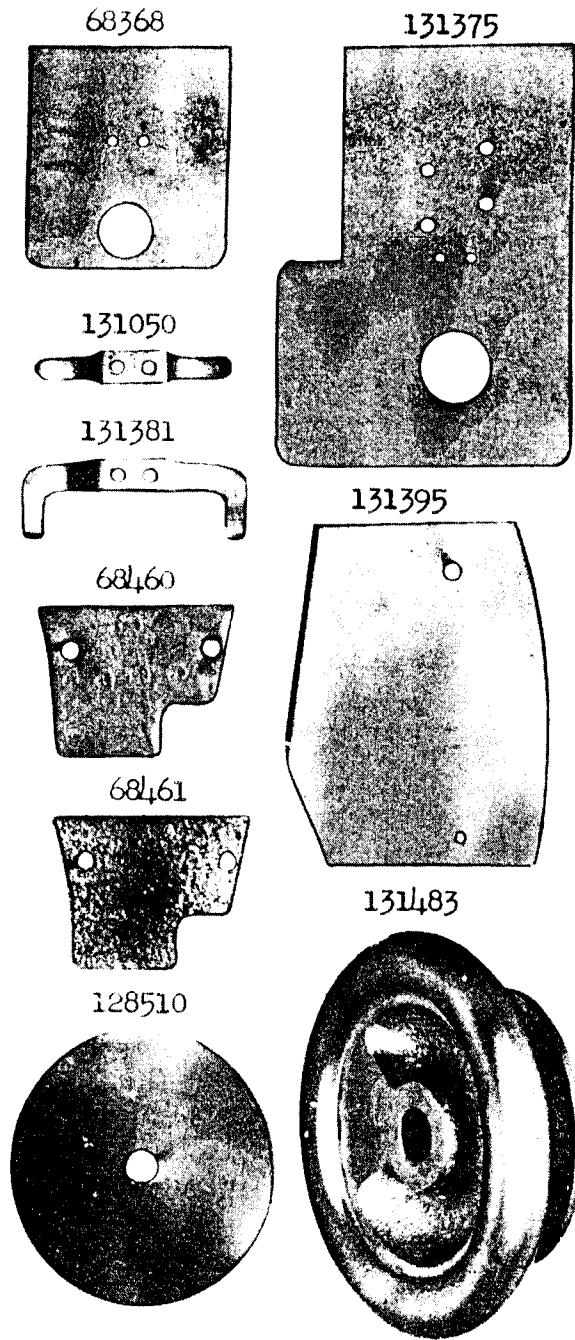

PLATE 20533 - FULL SIZE

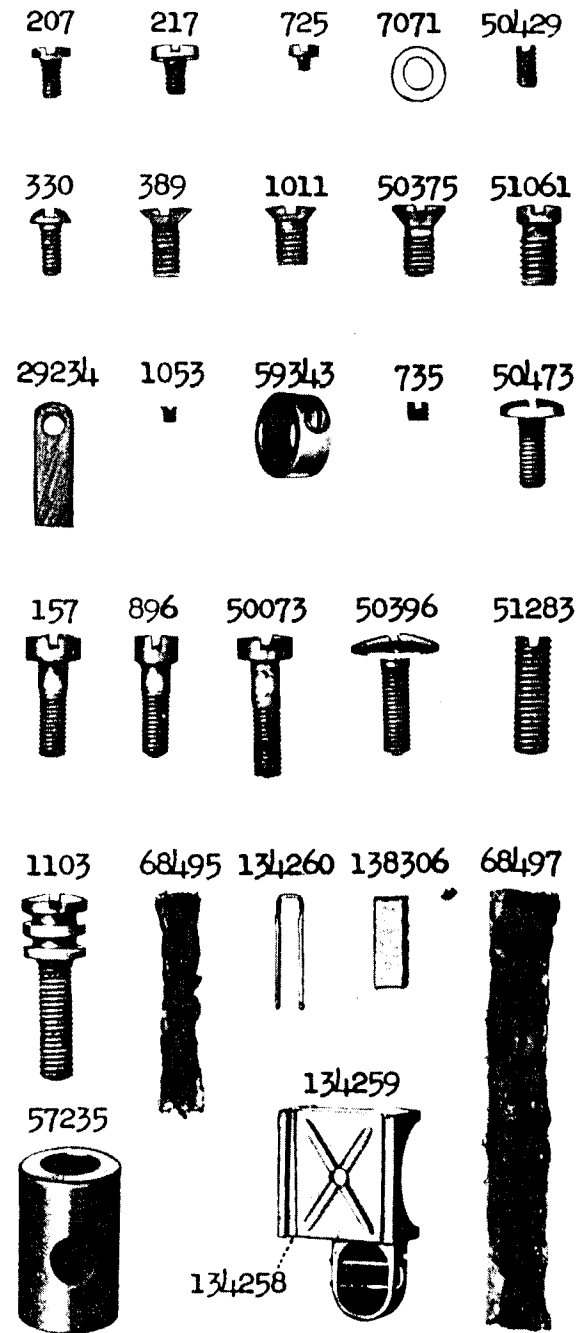

PLATE 20538 - ONE-HALF SIZE

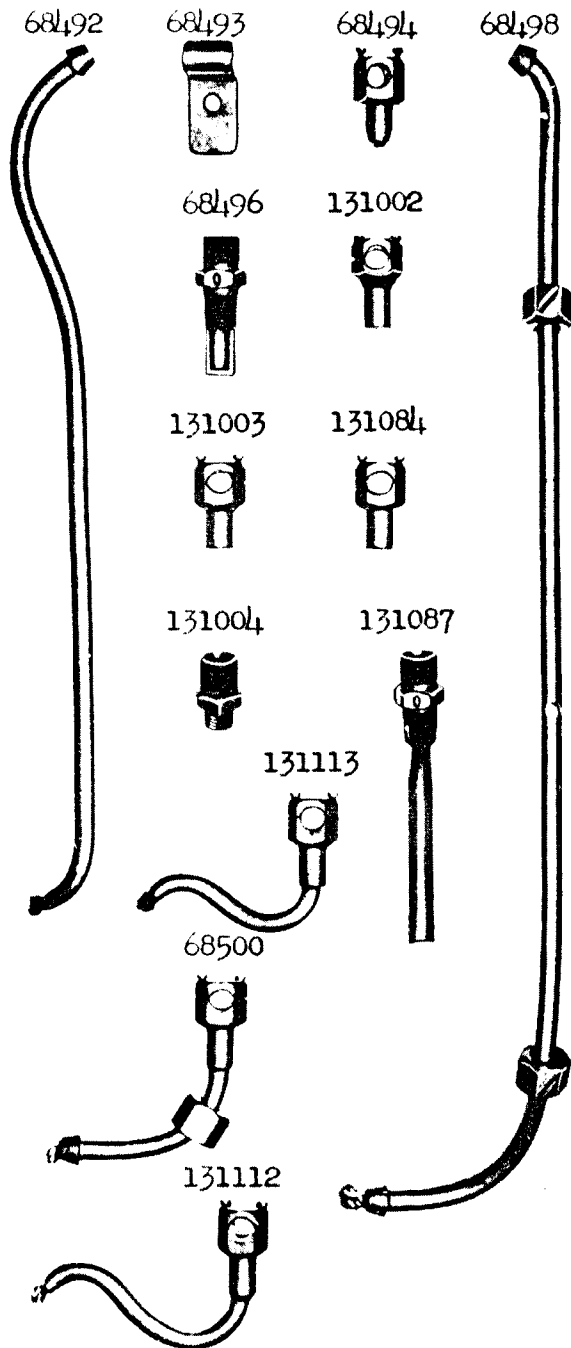

PLATE 20539 - FULL SIZE

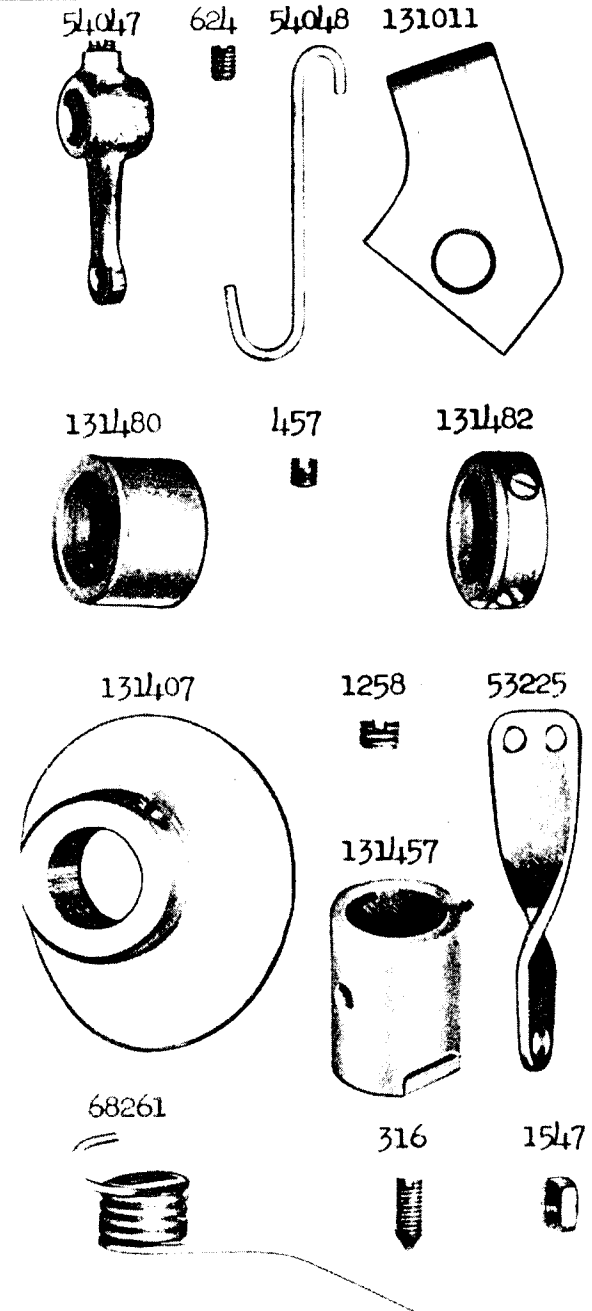
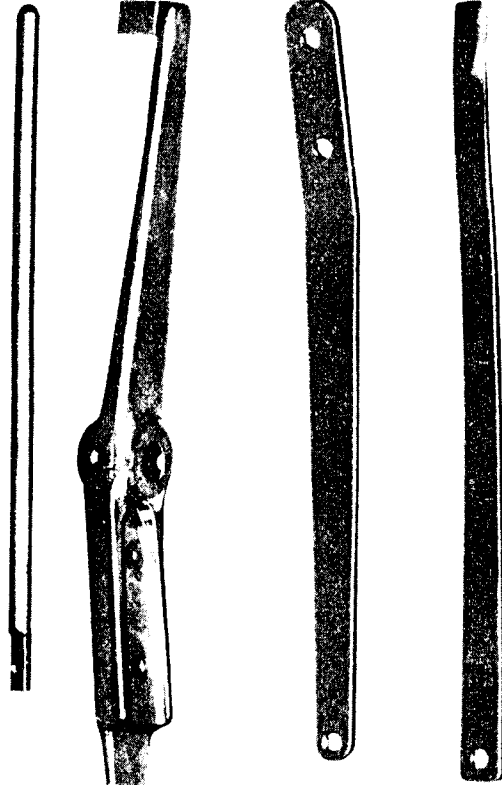

PLATE 20542 - ONE-HALF SIZE

64330 131402 68184 38467



131012



131411

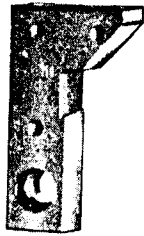

131410

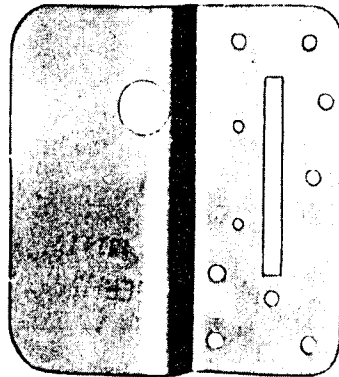
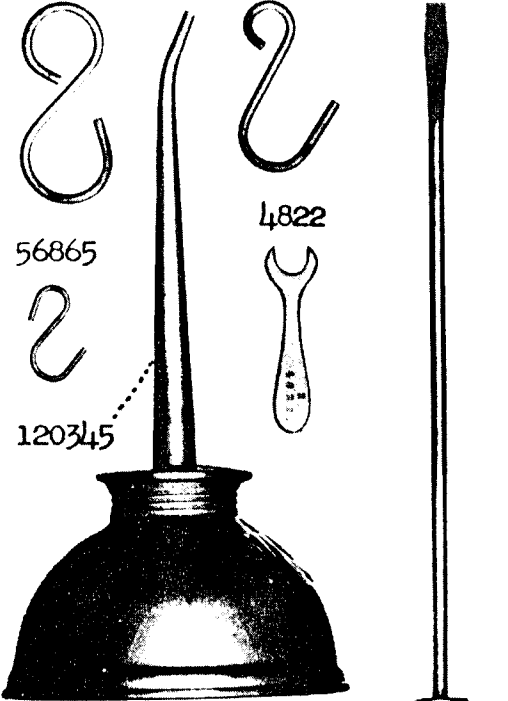

PLATE 20545 - ONE-HALF SIZE

4879 120344 56864 120440



56865



120345



120341 121108

8908

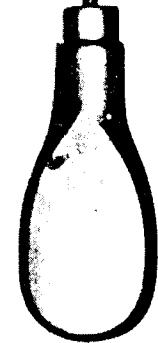
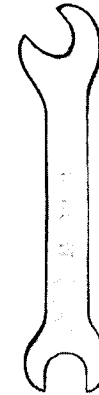

PLATE 20546 - FULL SIZE

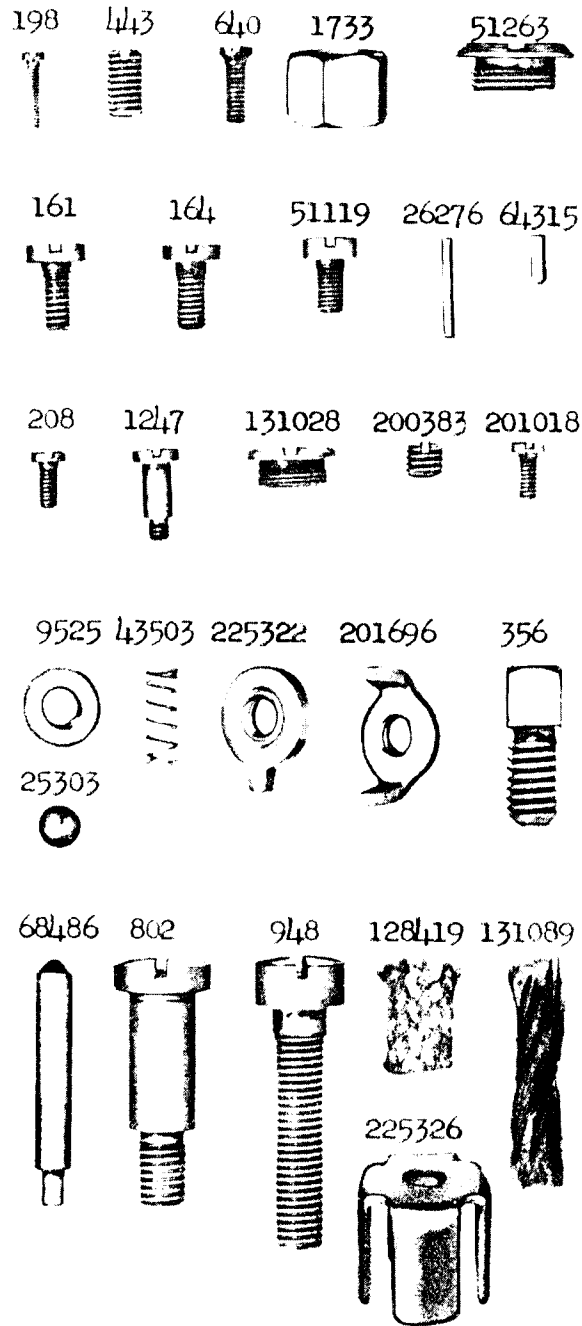

PLATE 20547 - FULL SIZE

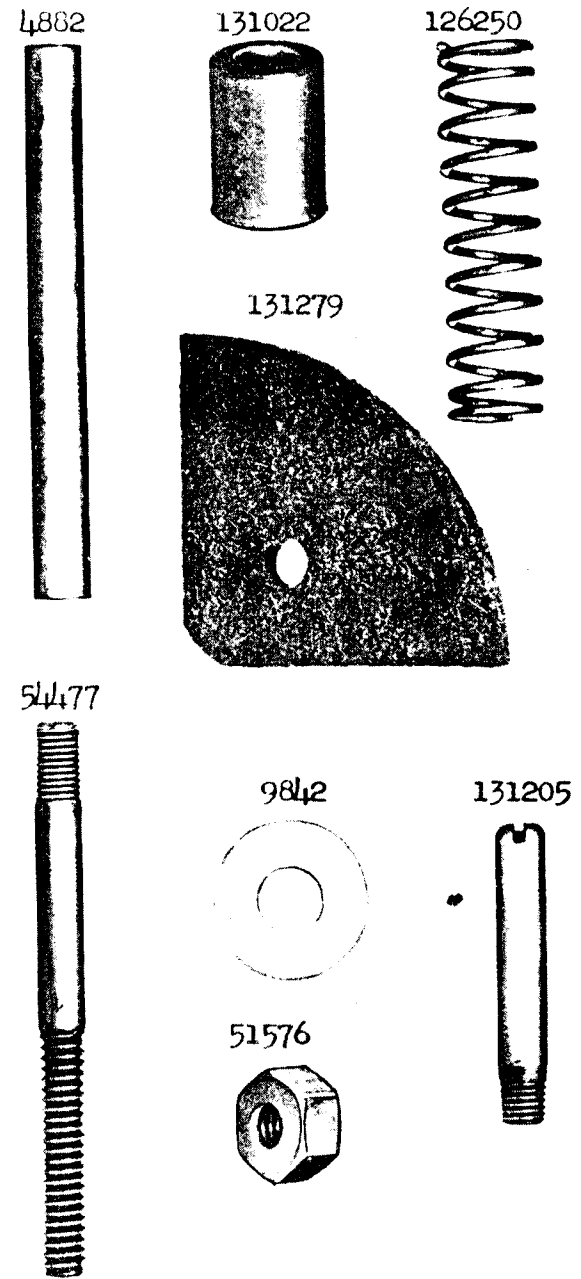
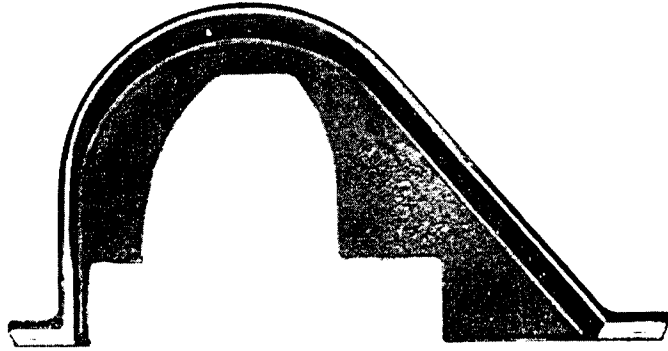
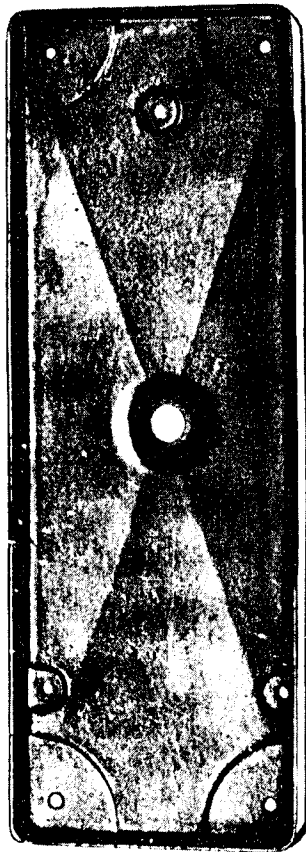

PLATE 20549 - ONE-FOURTH SIZE

68222



131263



150452

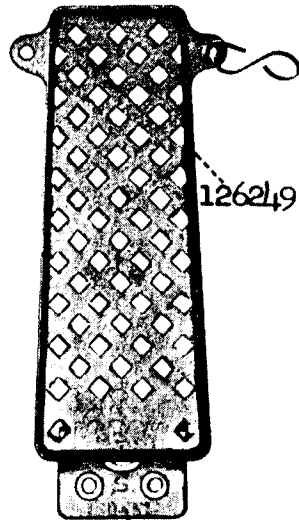

126249

150451

PLATE 20562 - FULL SIZE

54228



742



68479

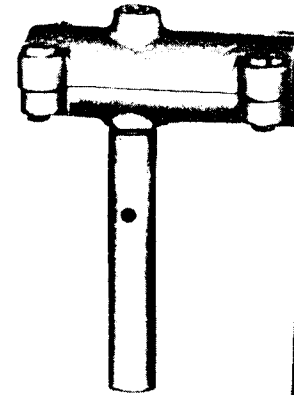

453



452

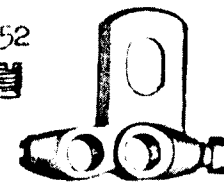

131052

131132

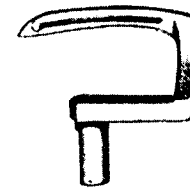

131459

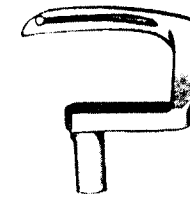

68479



453



452



131052

131131

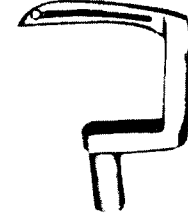

131458

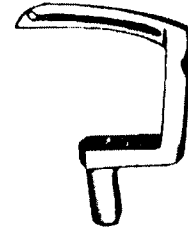

54227

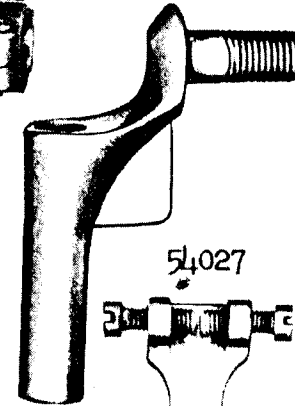

175



1120

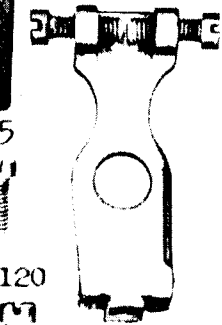

54027

PLATE 20565 - FULL SIZE

131006 54496 11173 38468 50326

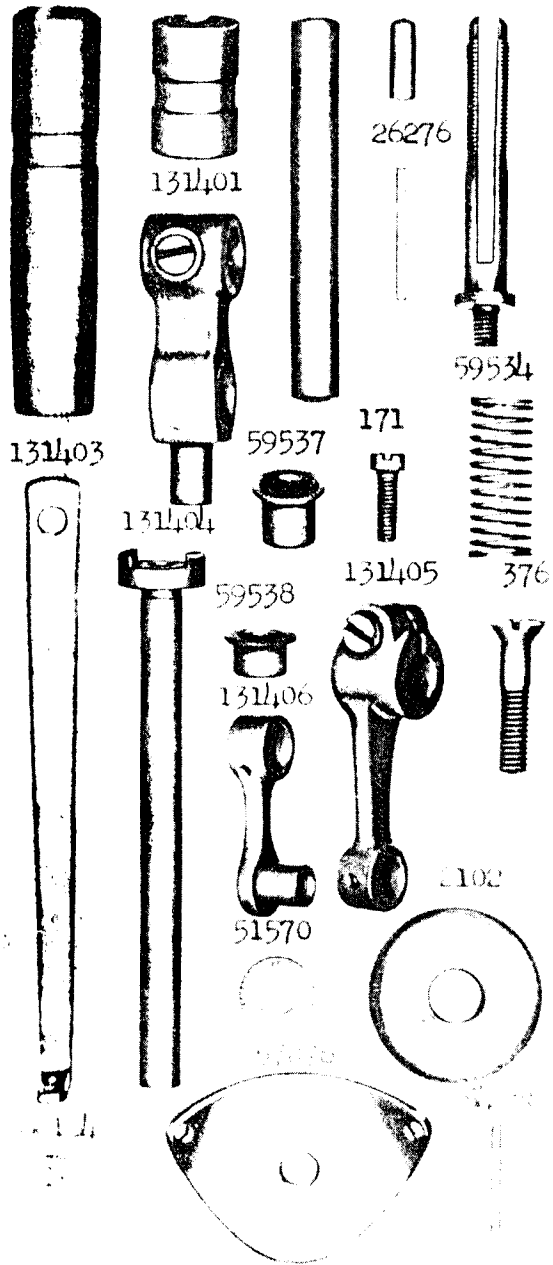

PLATE 20566 - FULL SIZE

64319 54070 131400

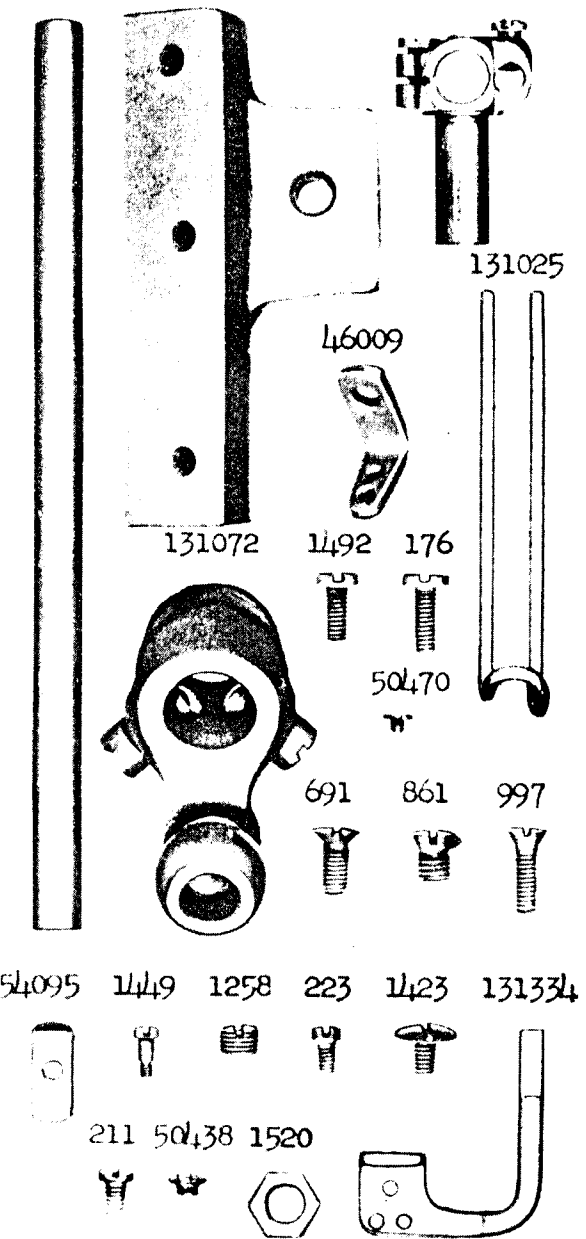
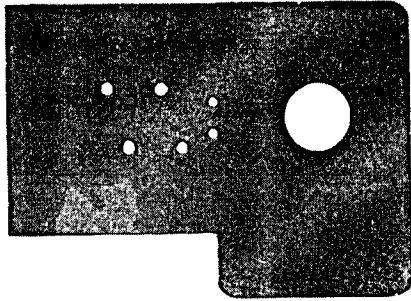
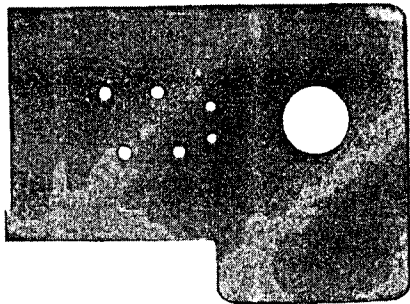

PLATE 20567 - ONE-HALF SIZE

131375



131376



131377

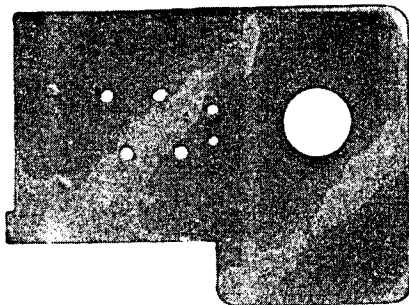
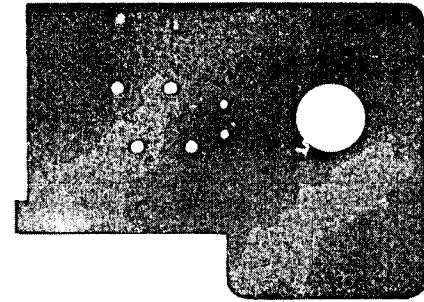
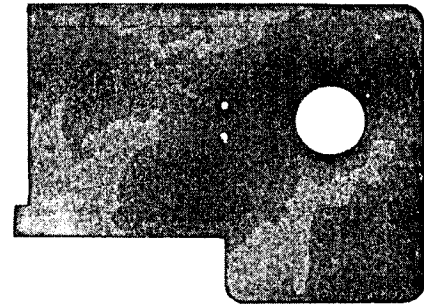

PLATE 20568 - ONE-HALF SIZE

131378



131379



131380

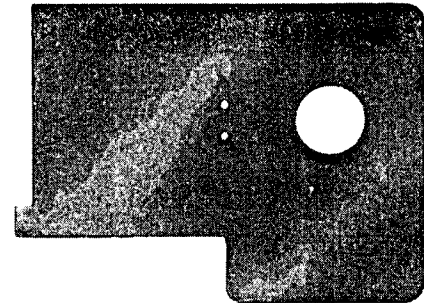

PLATE 20580 - FULL SIZE

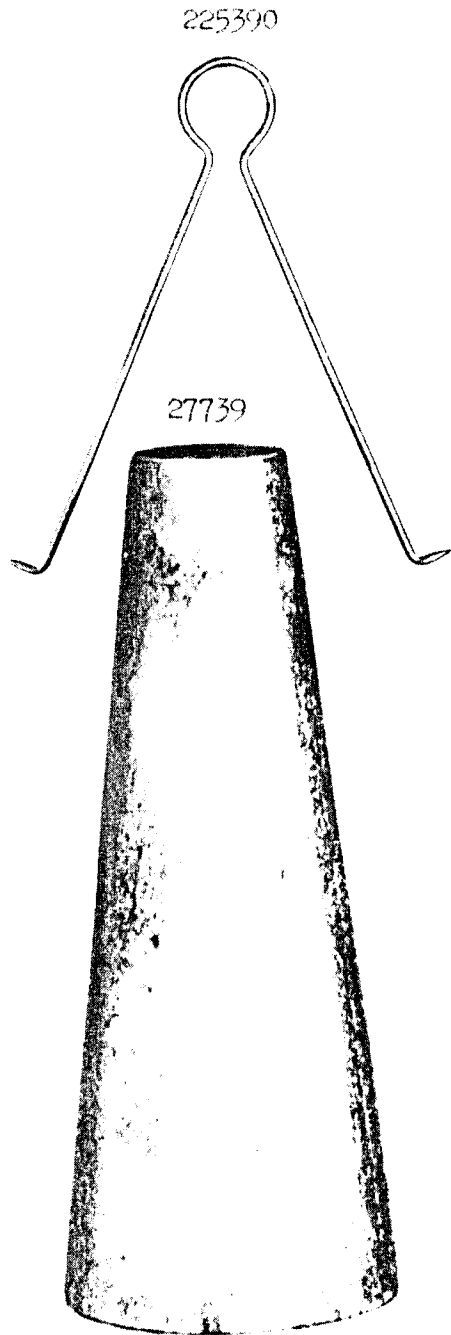

PLATE 20581 - FULL SIZE

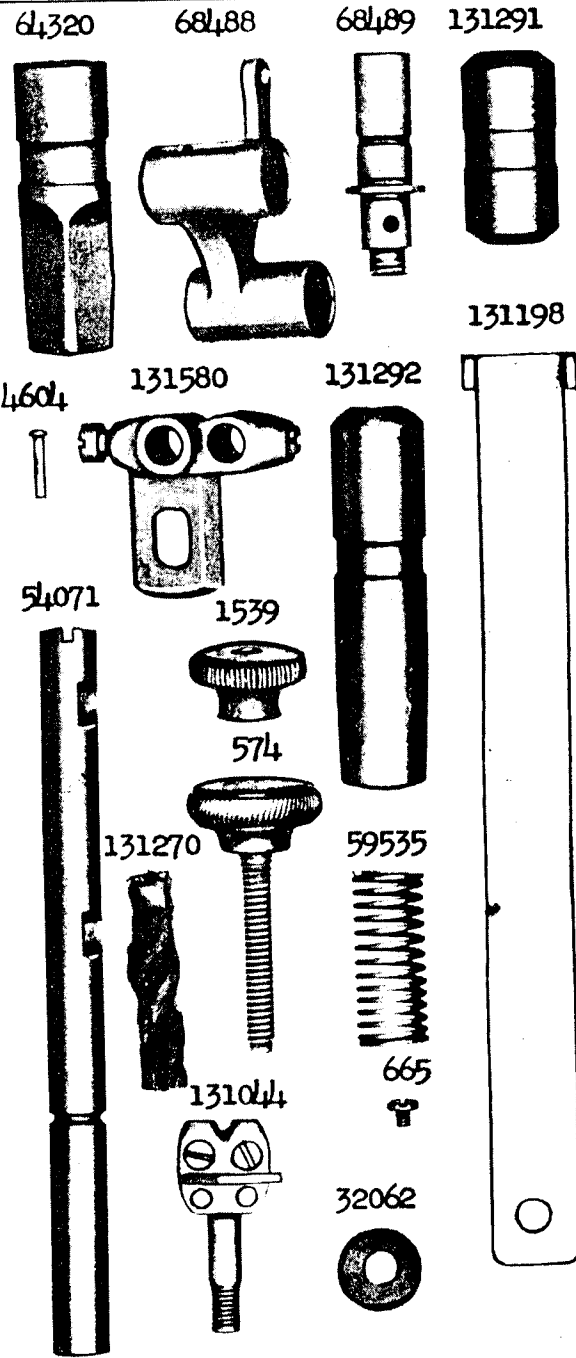

PLATE 20582 - FULL SIZE

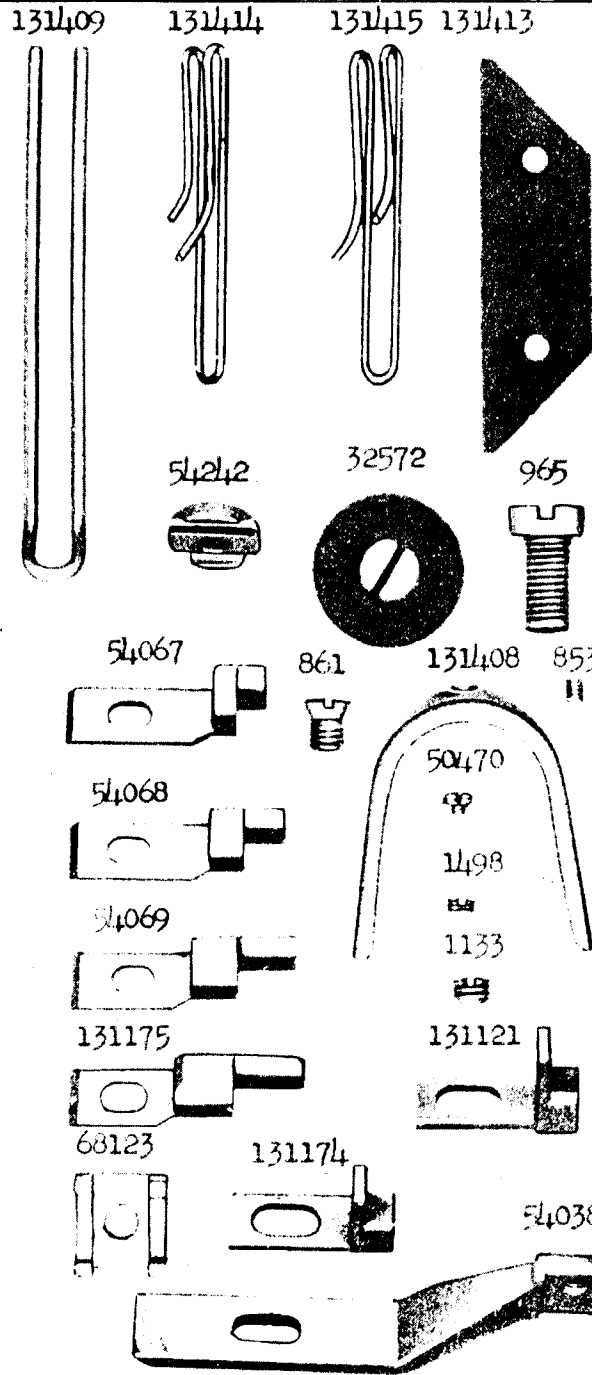

PLATE 20583 - ONE-HALF SIZE

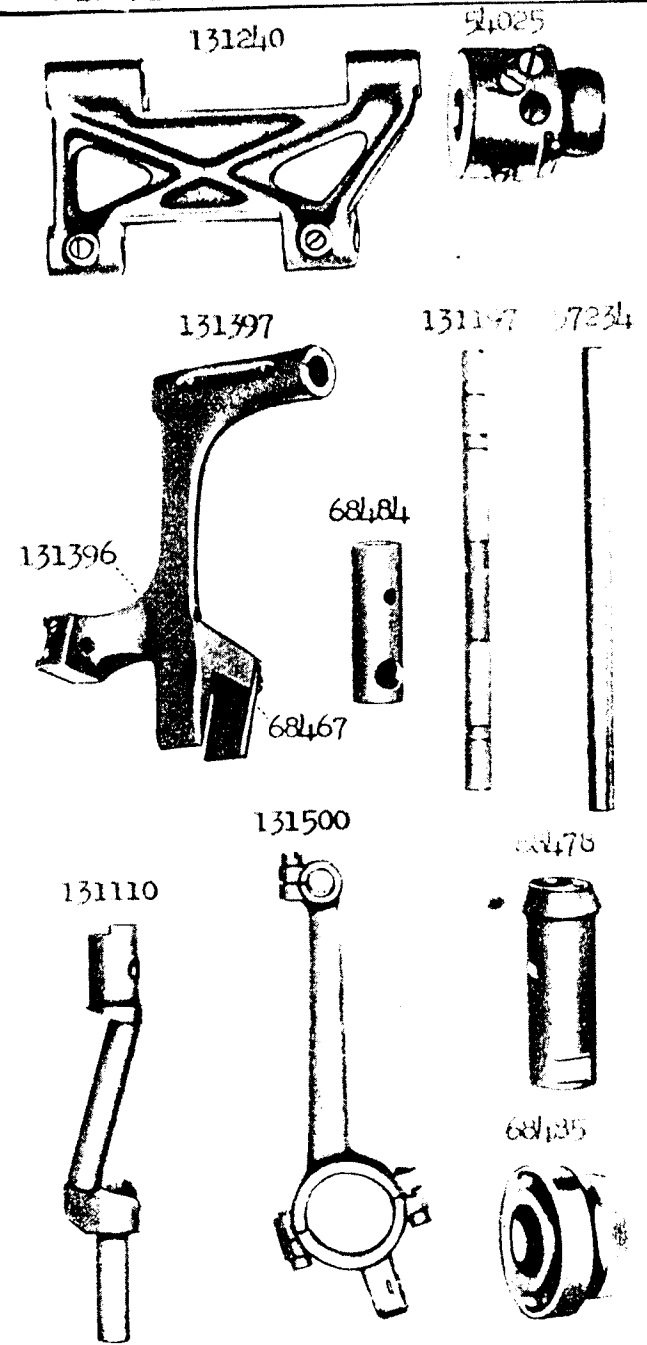

PLATE 20584 - ONE-HALF SIZE

131293 131471 131486

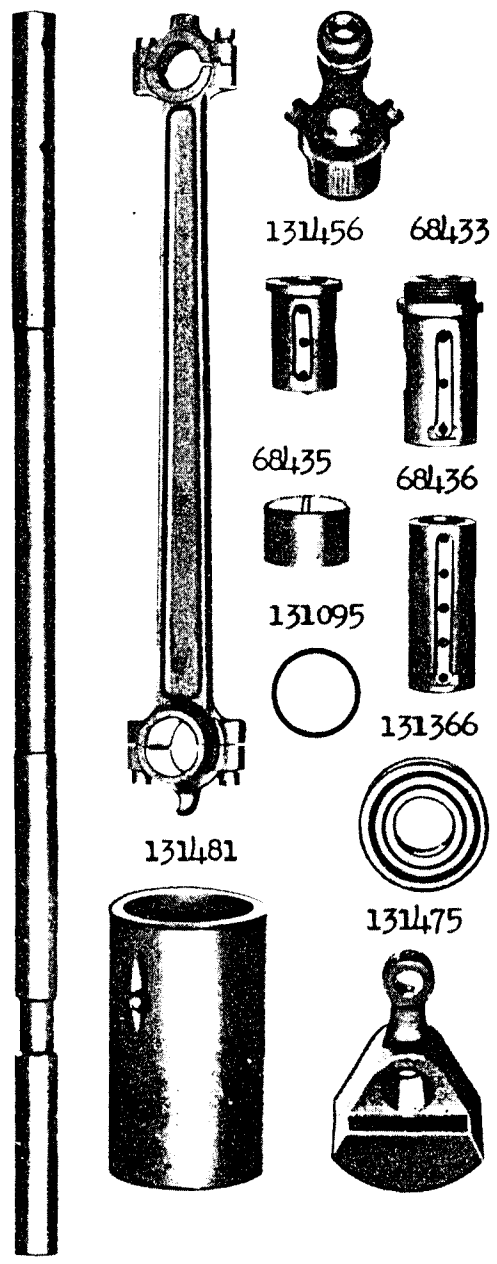

PLATE 20585 - FULL SIZE

131210 131032 131592

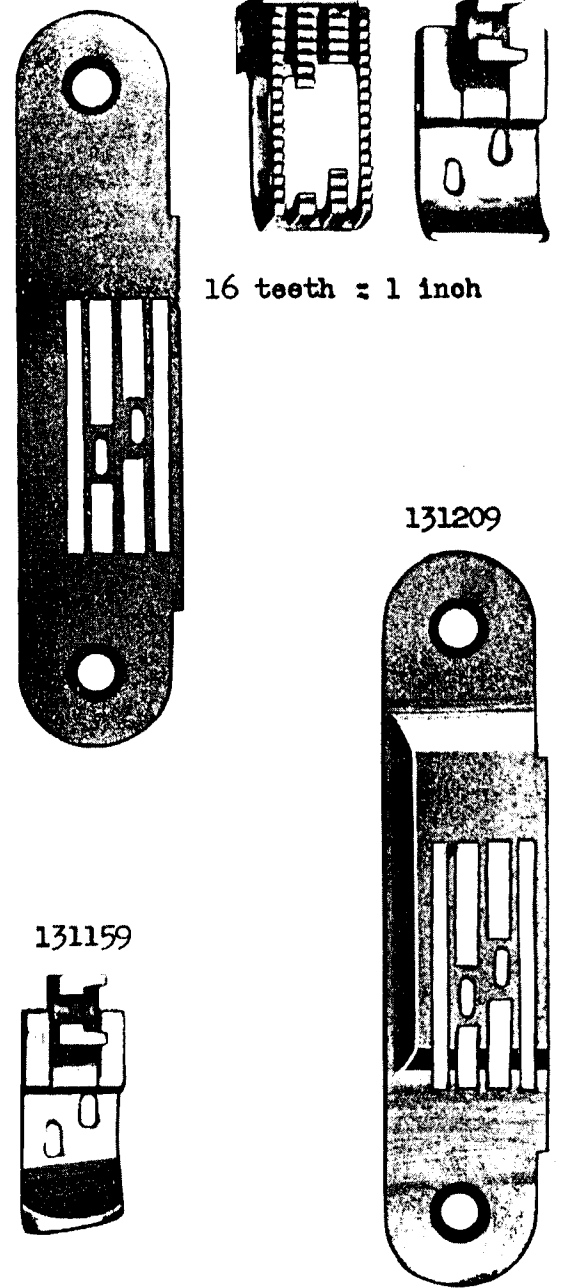
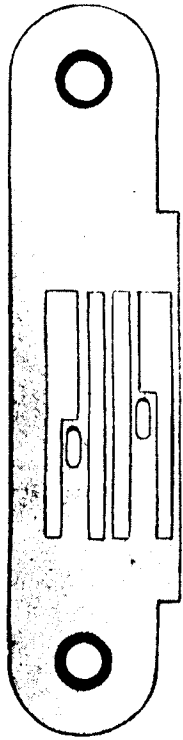
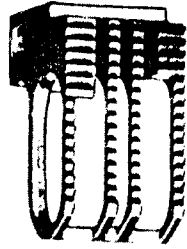

PLATE 20586 - FULL SIZE

131214



131093



131592

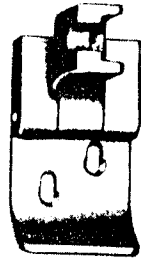

16 teeth = 1 inch

131213

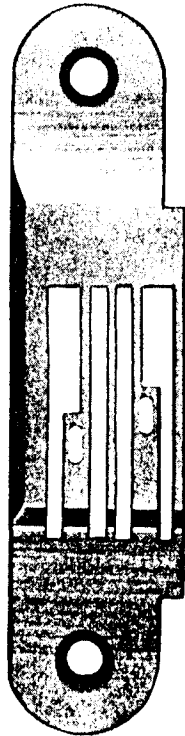

131159

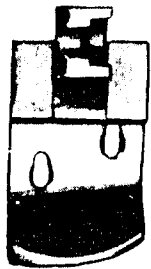
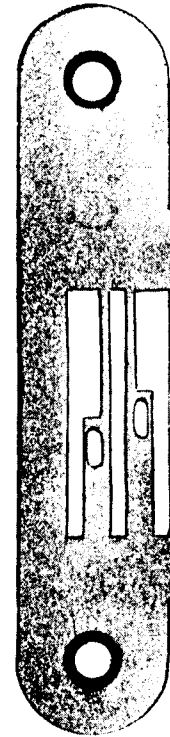
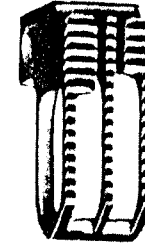

PLATE 20587 - FULL SIZE

131212



131321



131592

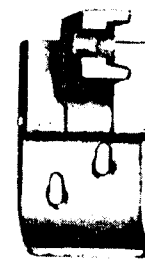

16 teeth = 1 inch

131211



131159

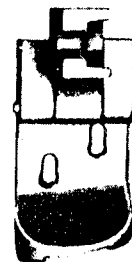

PLATE 20588 - FULL SIZE

131215



131118



131594

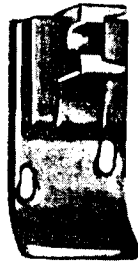

14 teeth = 1 inch

131124



131597

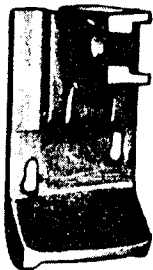
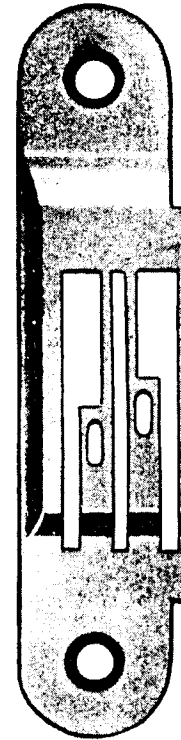
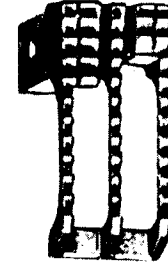

PLATE 20589 - FULL SIZE

131115



131241



10 teeth = 1 inch

131243

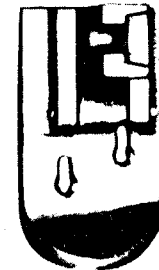
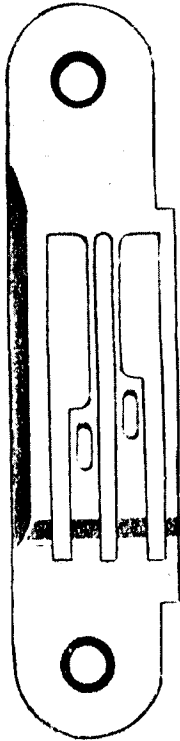
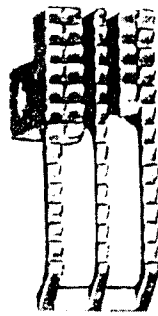

PLATE 20590 - FULL SIZE

131536



131529



10 teeth = 1 inch

131550

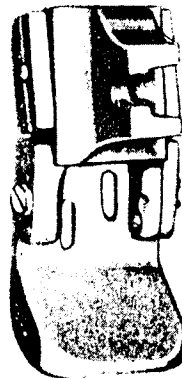
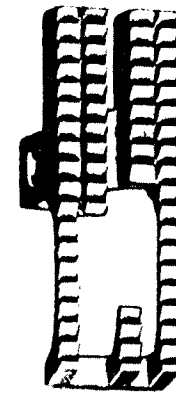

PLATE 20591 - FULL SIZE

131543



131537



10 teeth = 1 inch

131542

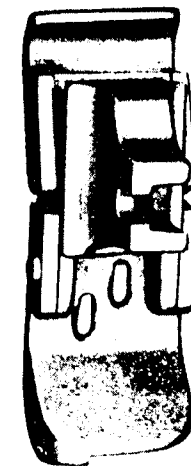

PLATE 20592 - ONE-FOURTH SIZE

131487

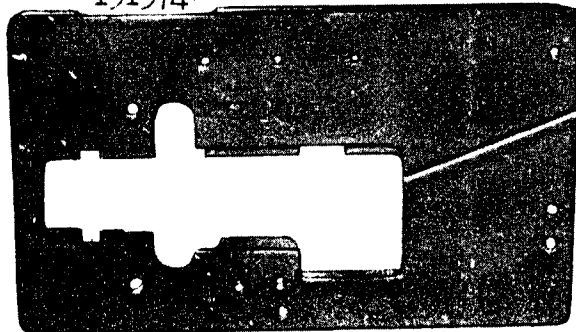
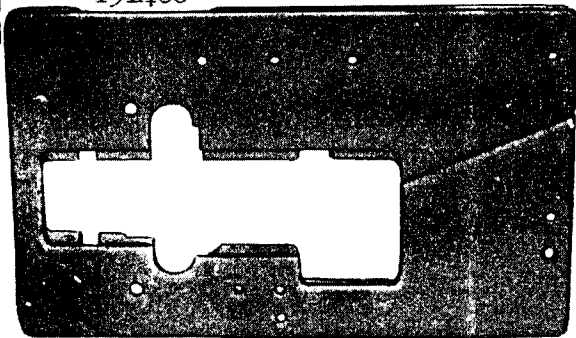
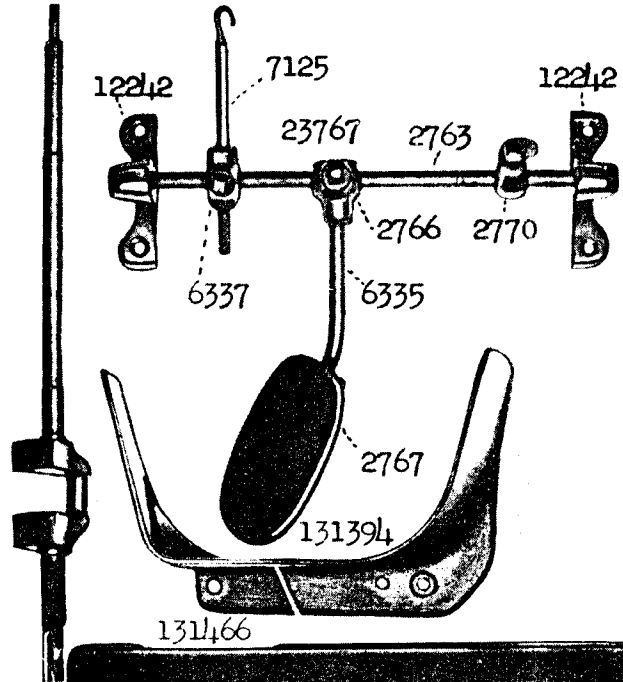
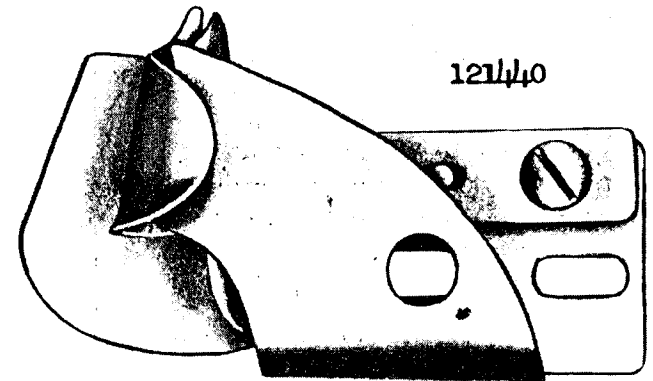
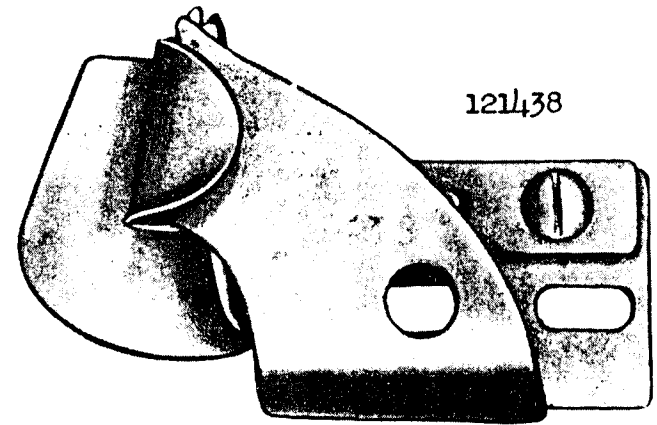

PLATE 20593 - FULL SIZE



1499



Free Manuals Download Website

<http://myh66.com>

<http://usermanuals.us>

<http://www.somanuals.com>

<http://www.4manuals.cc>

<http://www.manual-lib.com>

<http://www.404manual.com>

<http://www.luxmanual.com>

<http://aubethermostatmanual.com>

Golf course search by state

<http://golfingnear.com>

Email search by domain

<http://emailbydomain.com>

Auto manuals search

<http://auto.somanuals.com>

TV manuals search

<http://tv.somanuals.com>