

SINGER

46K48,K49,K53

Illustrated List of Parts

FOR

Nos. 46K48, 46K49 and
46K53 MACHINES

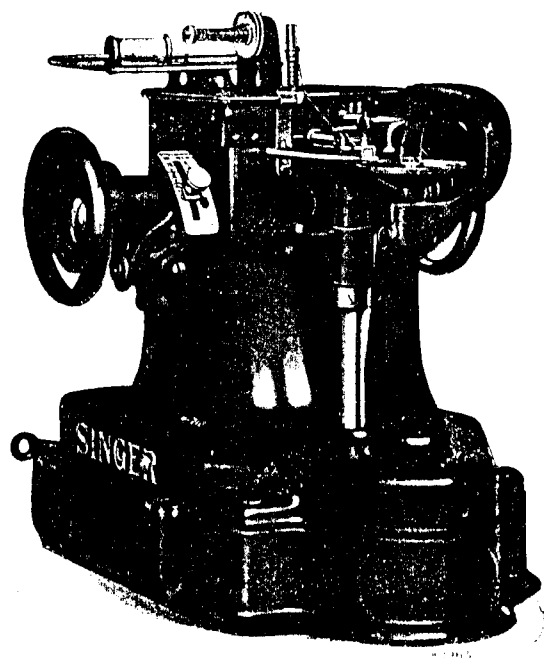

Machine No. 46K48.

** A Trade Mark of
THE SINGER MANUFACTURING COMPANY

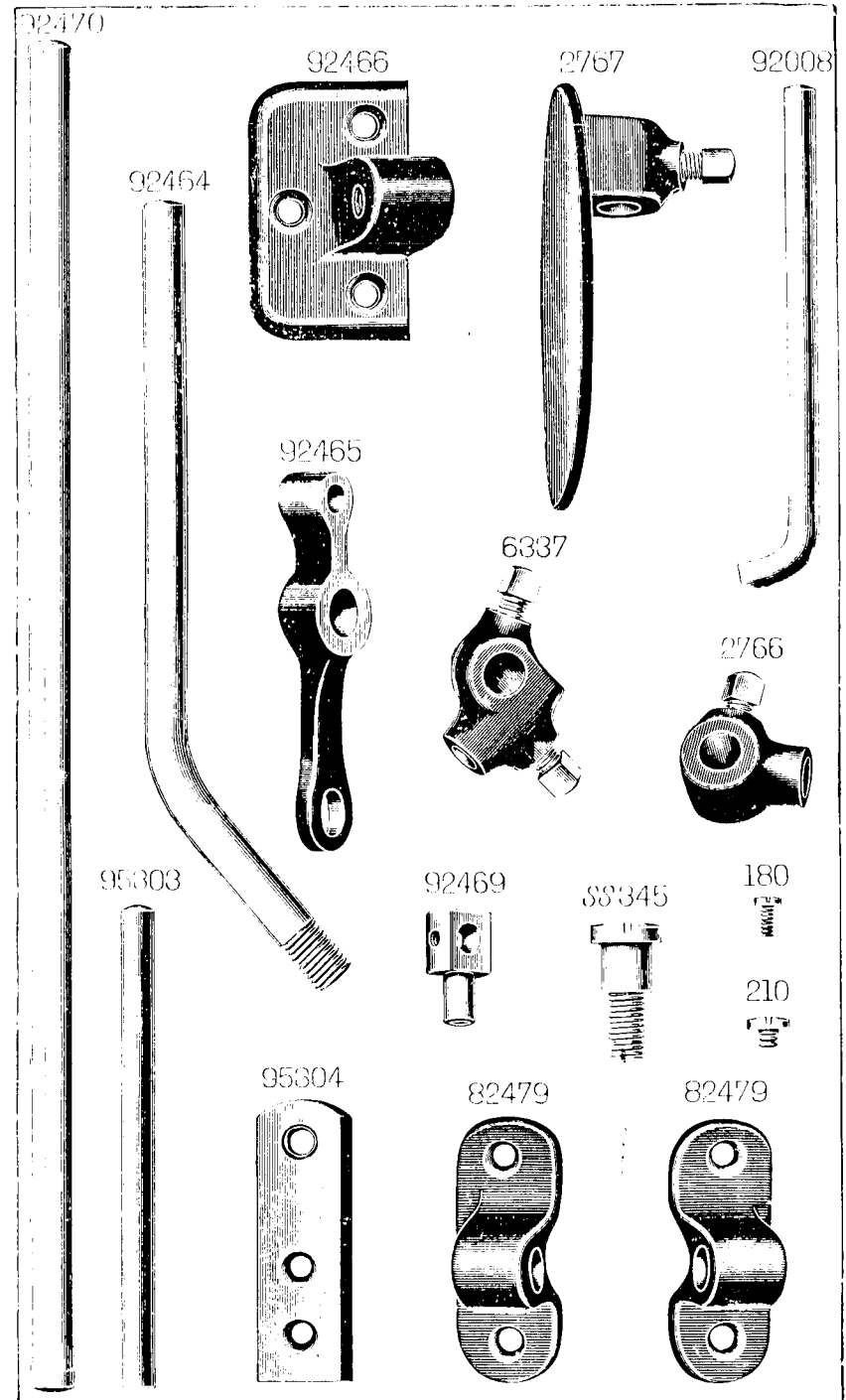

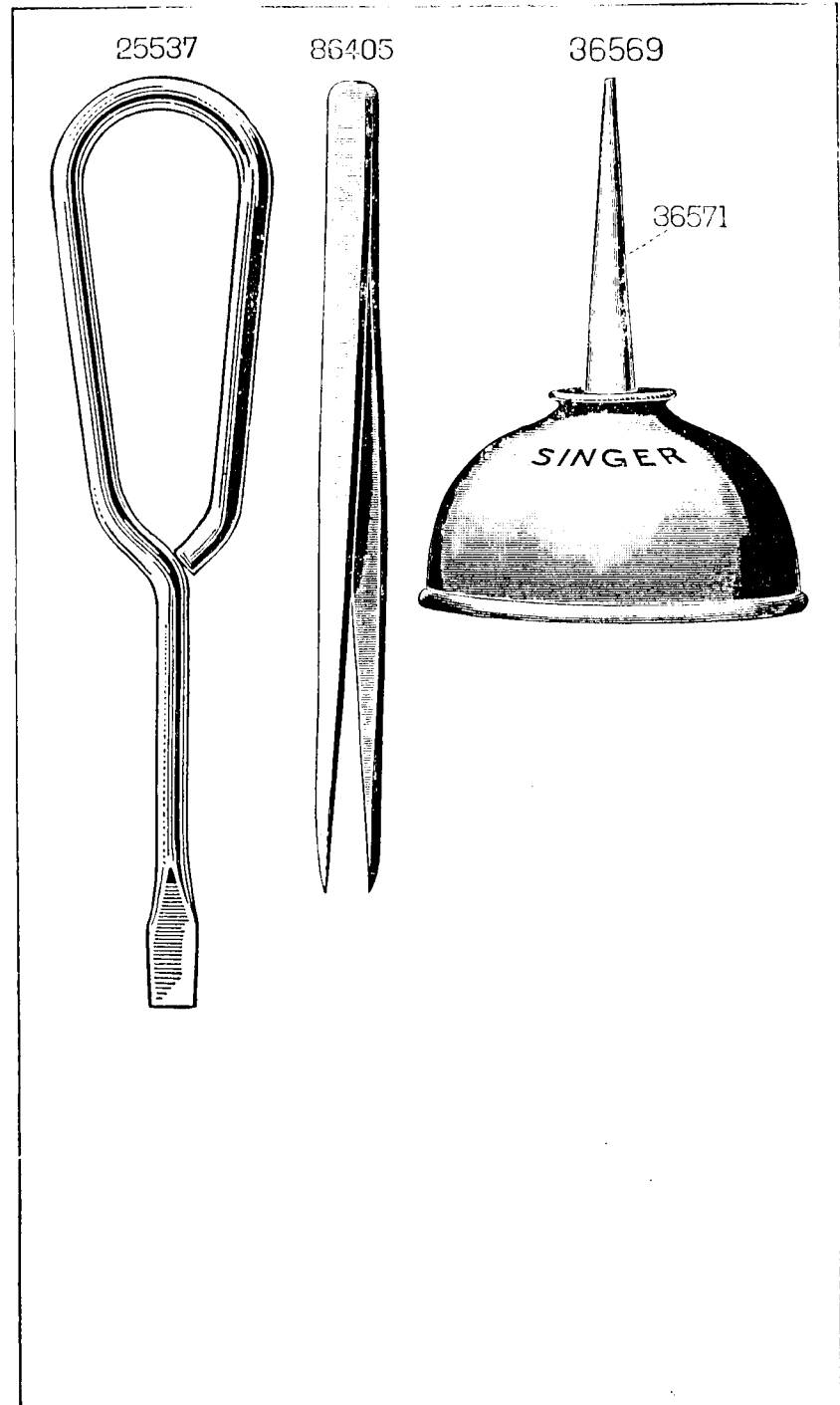
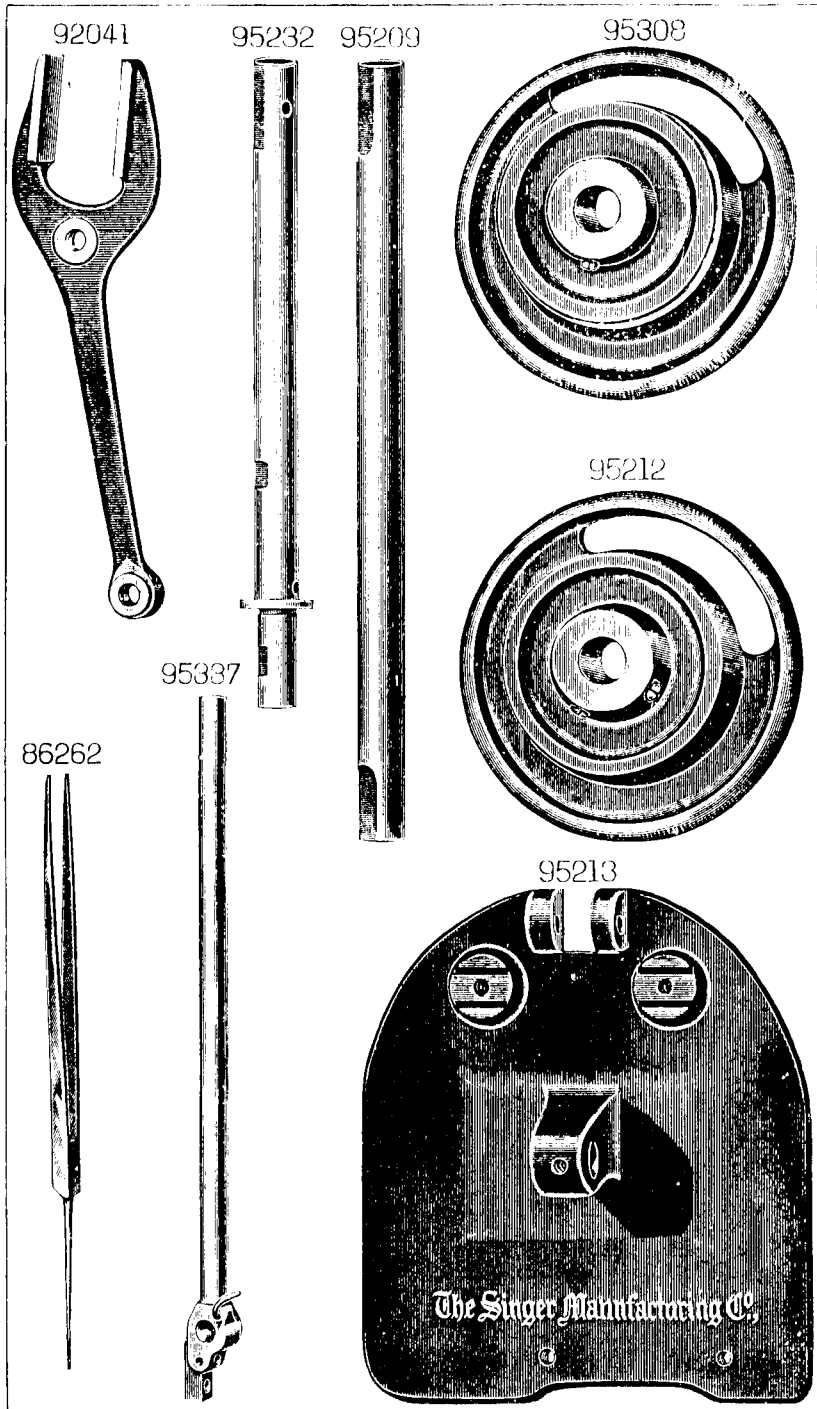

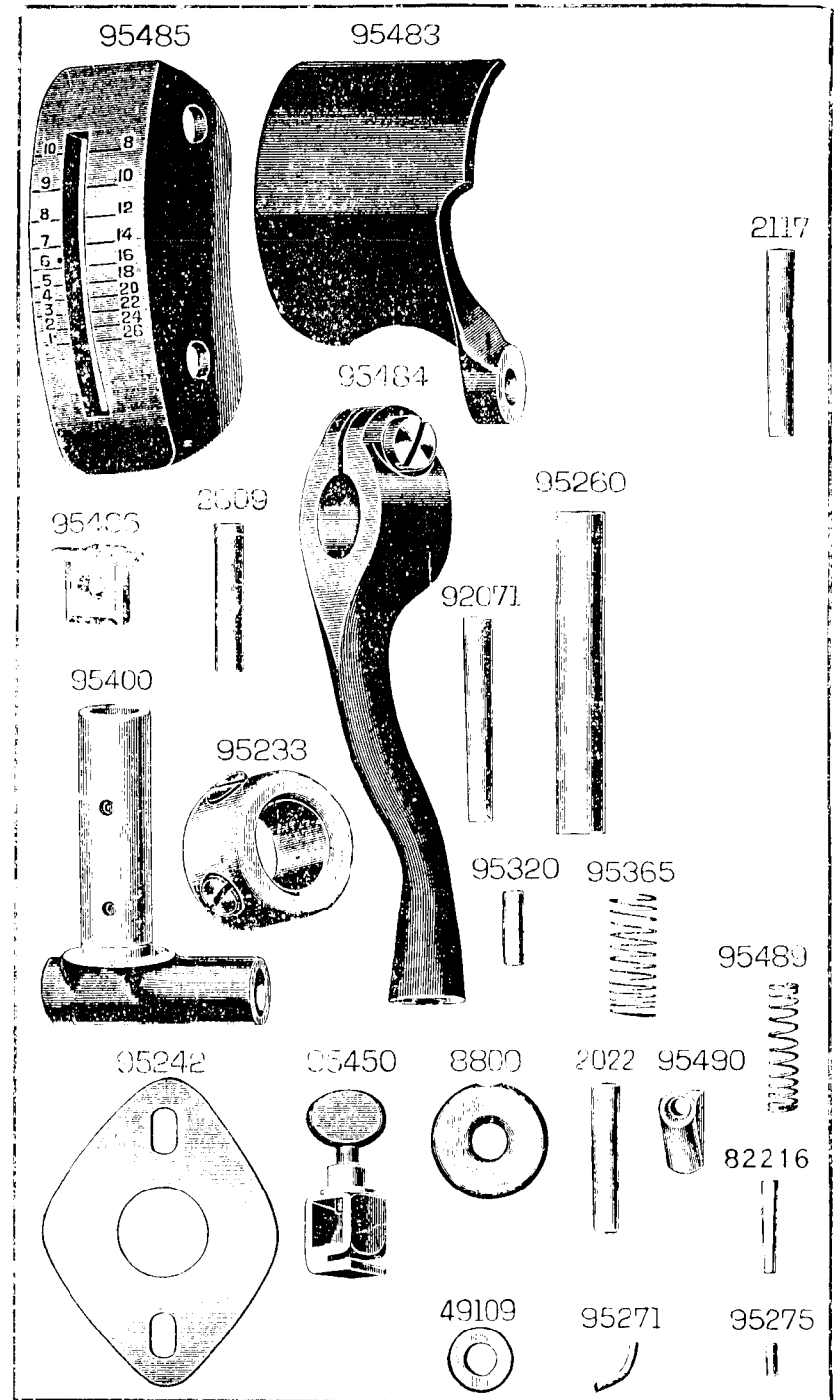

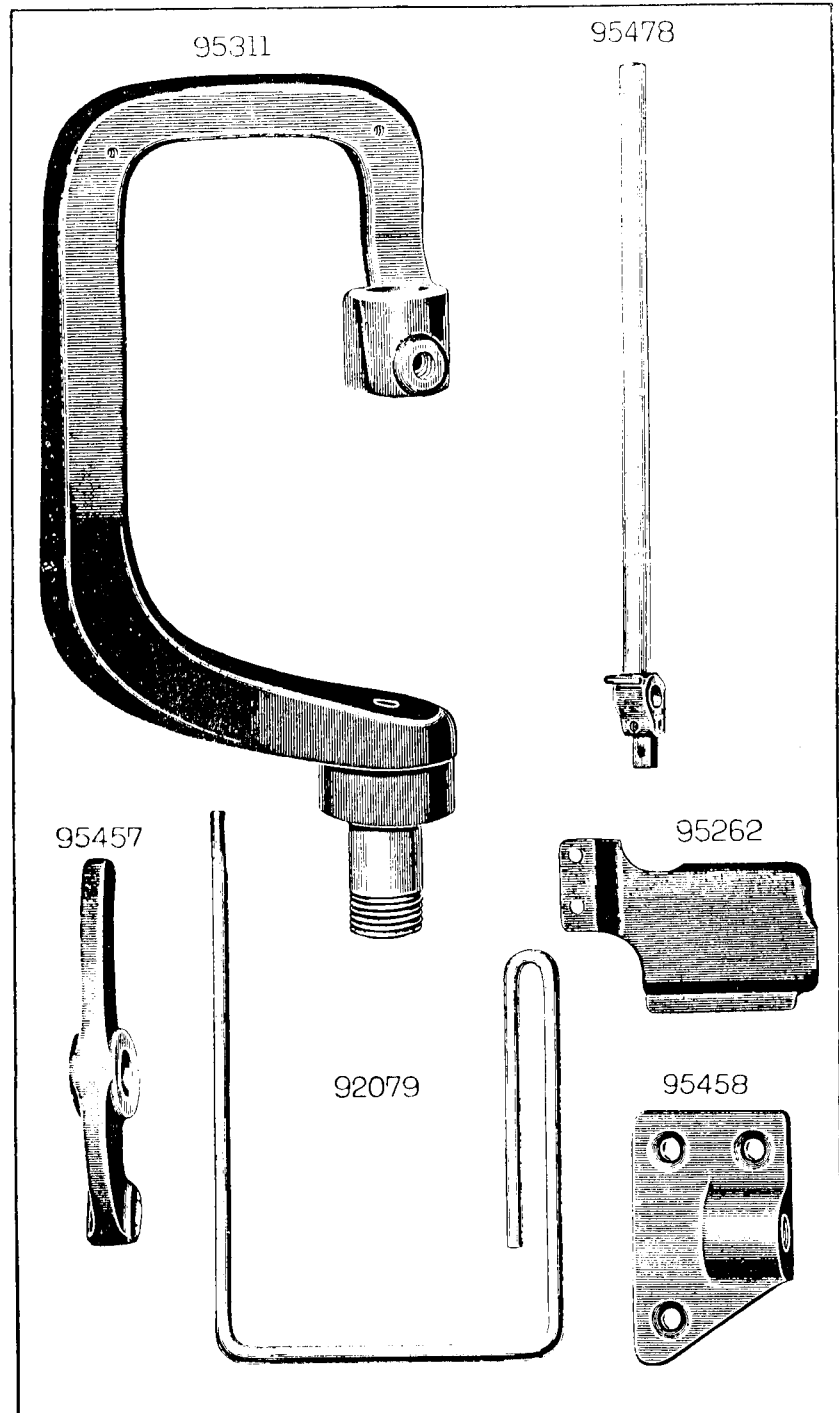
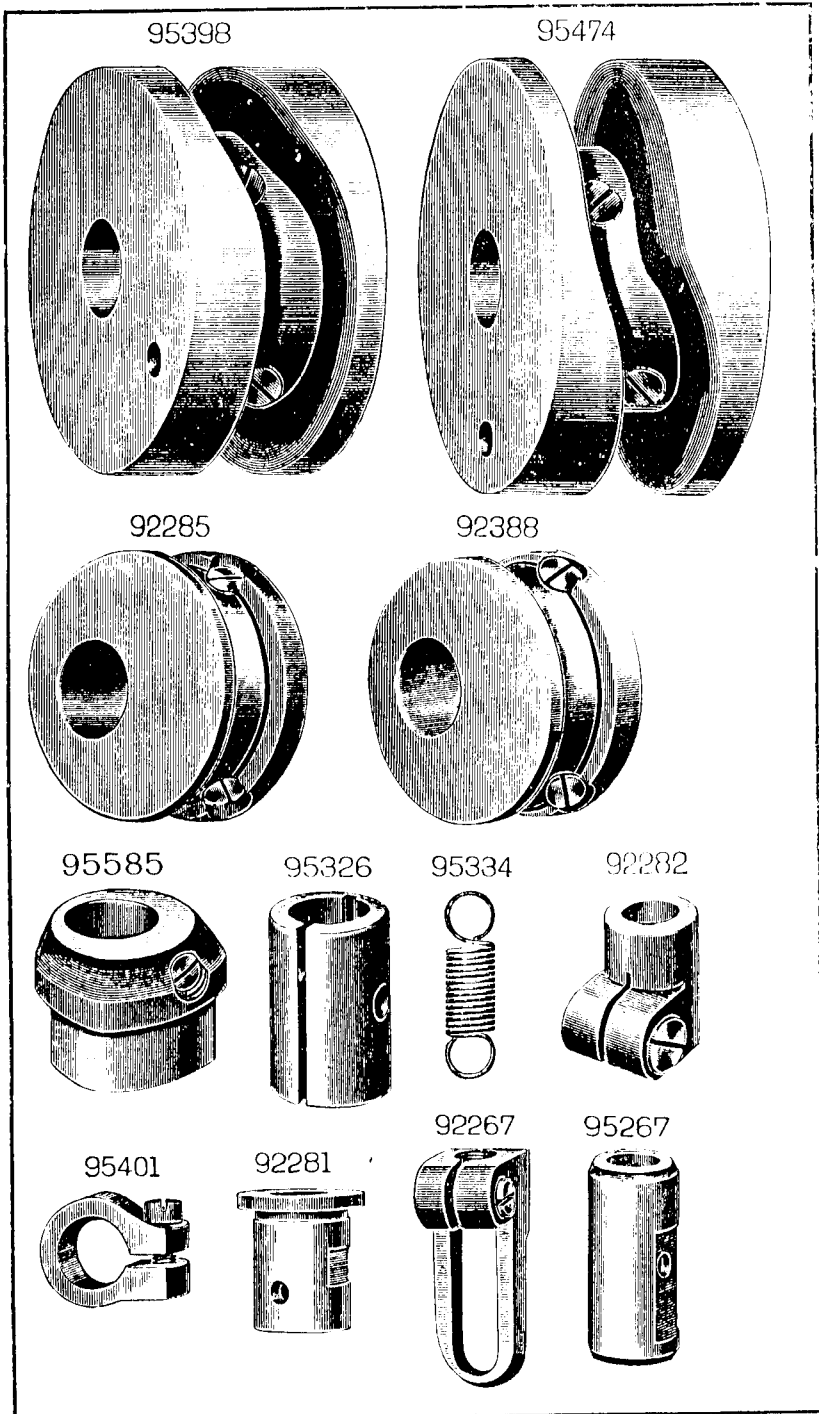

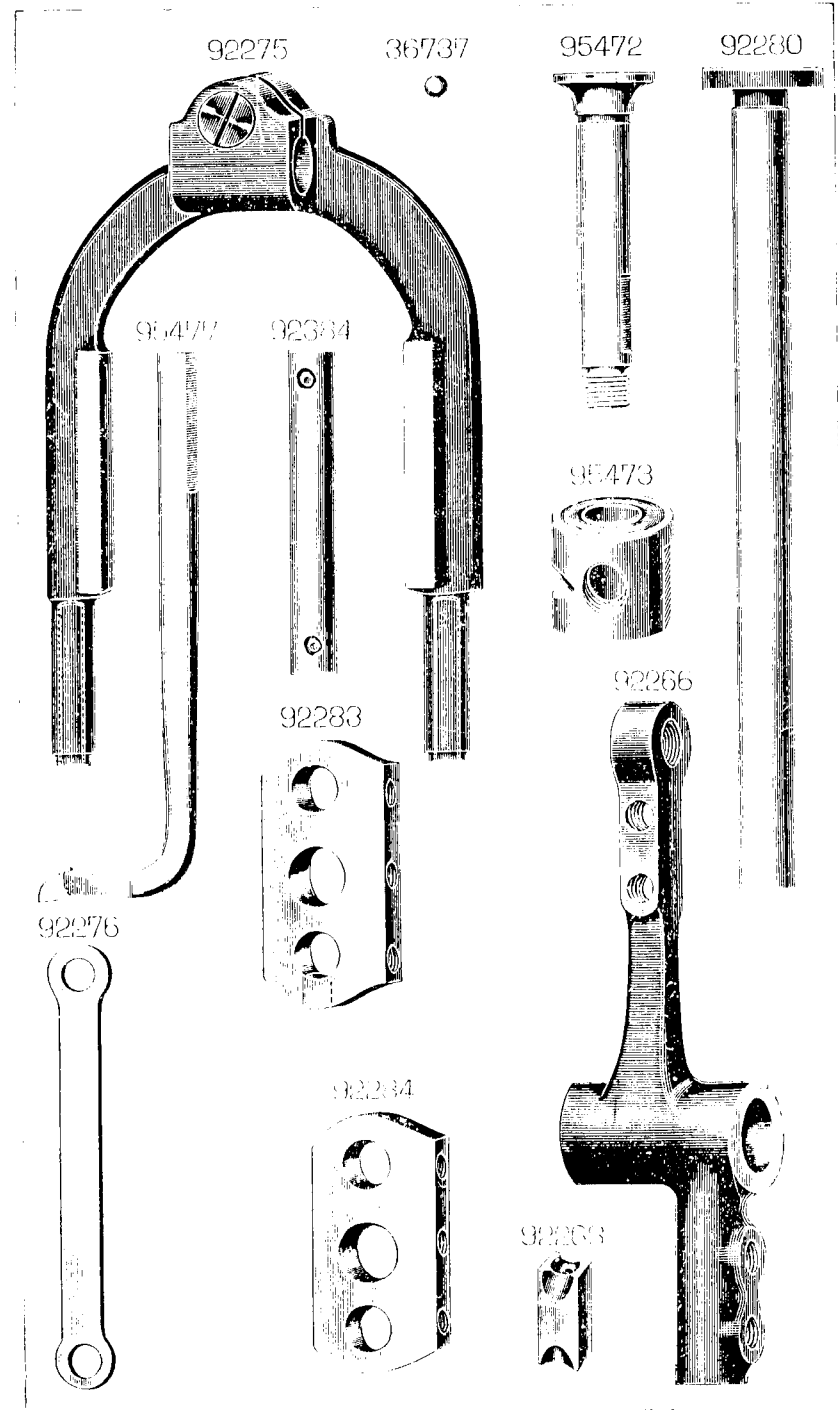
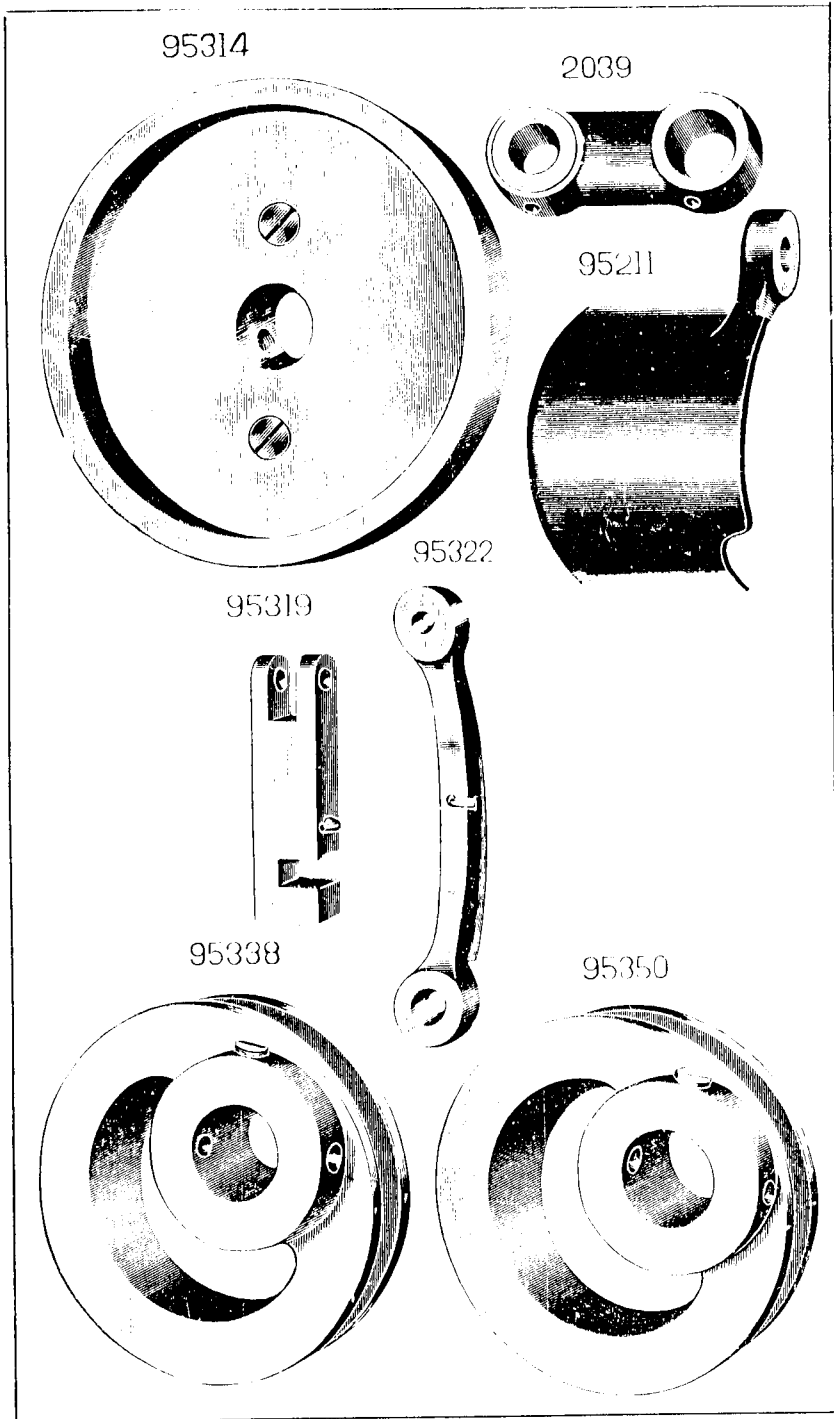

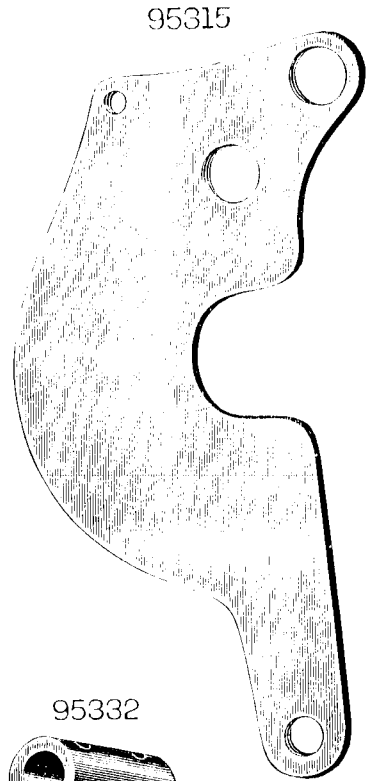

95357

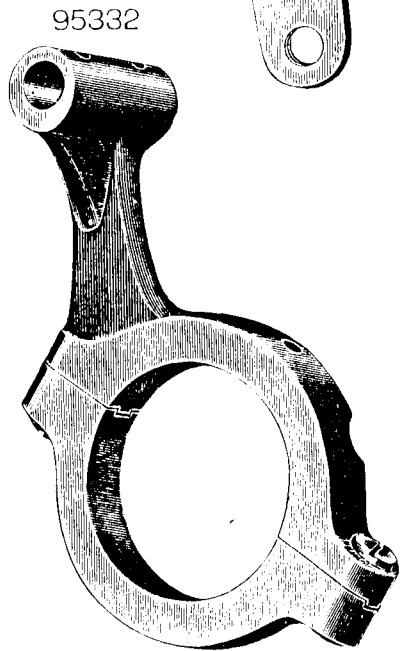
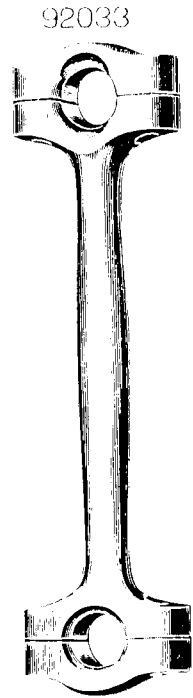

95300



95230



95352



94967



92100



95215



95340



95316



95317



95313

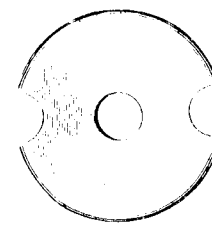

95243

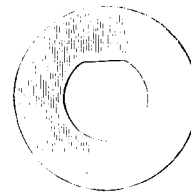

95298



8294



95366



95268



2102

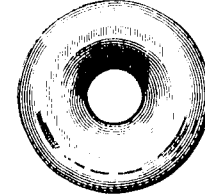

95567

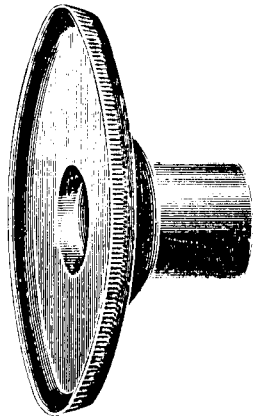

95574

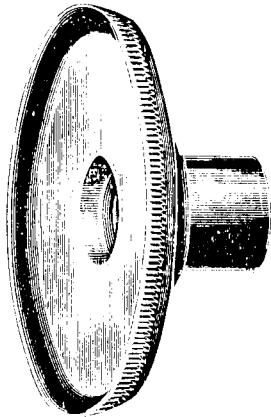

95569

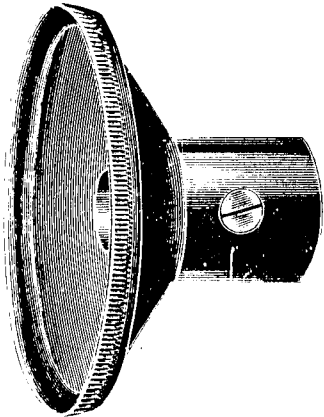

95576

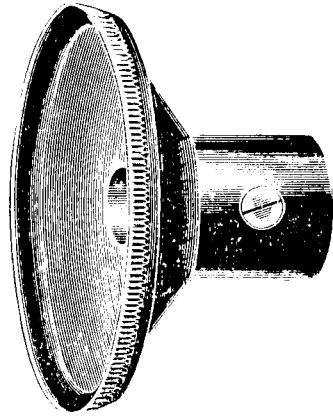

95560



95561



95562

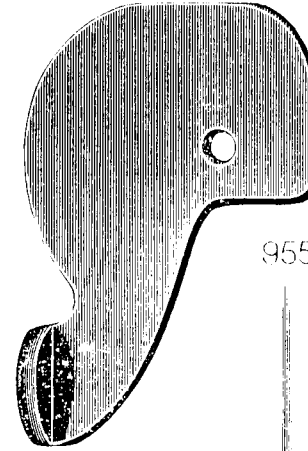

95564

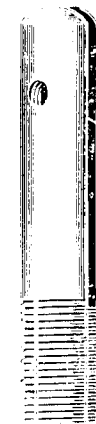

95563



184



1633

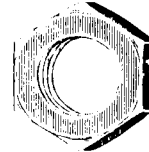

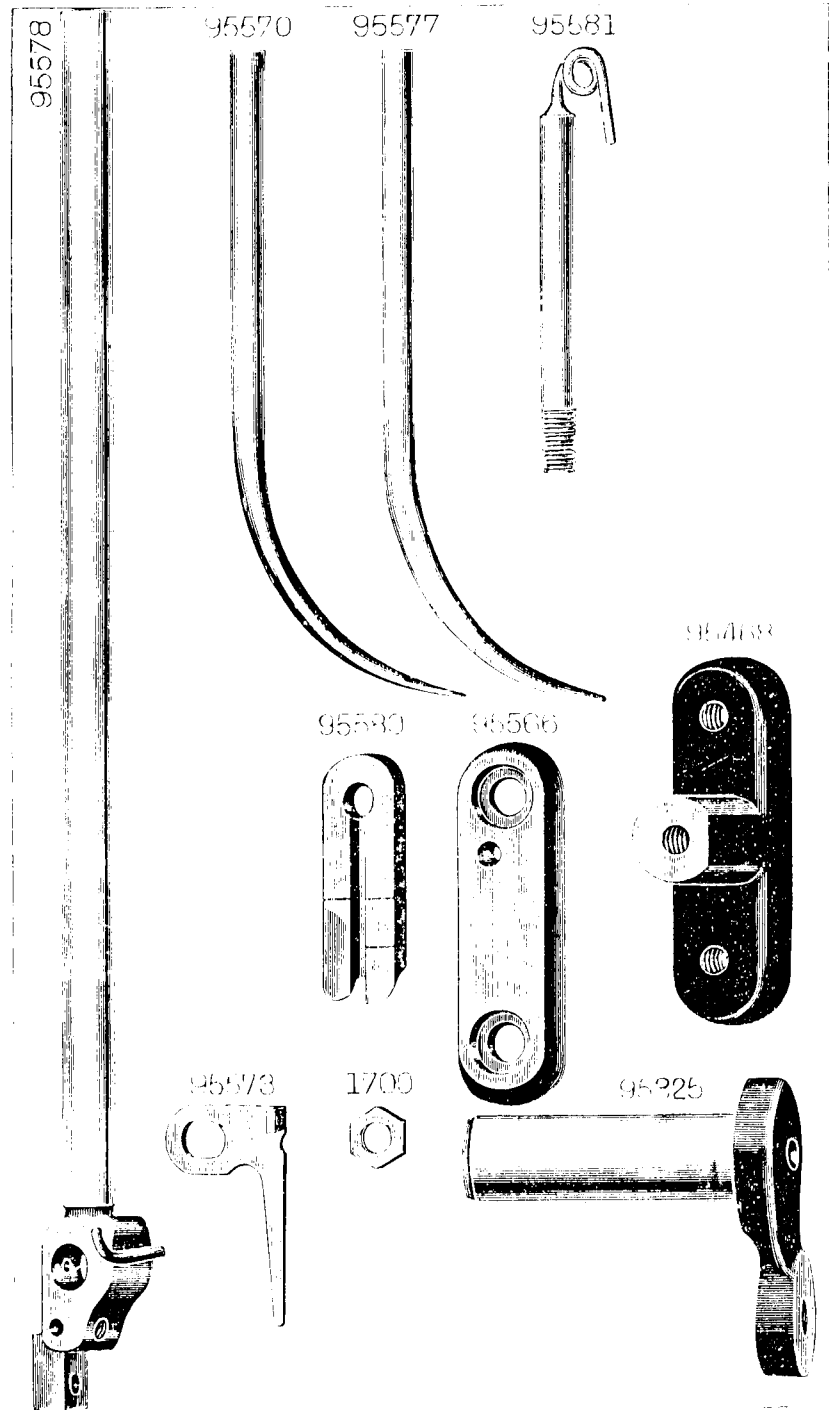
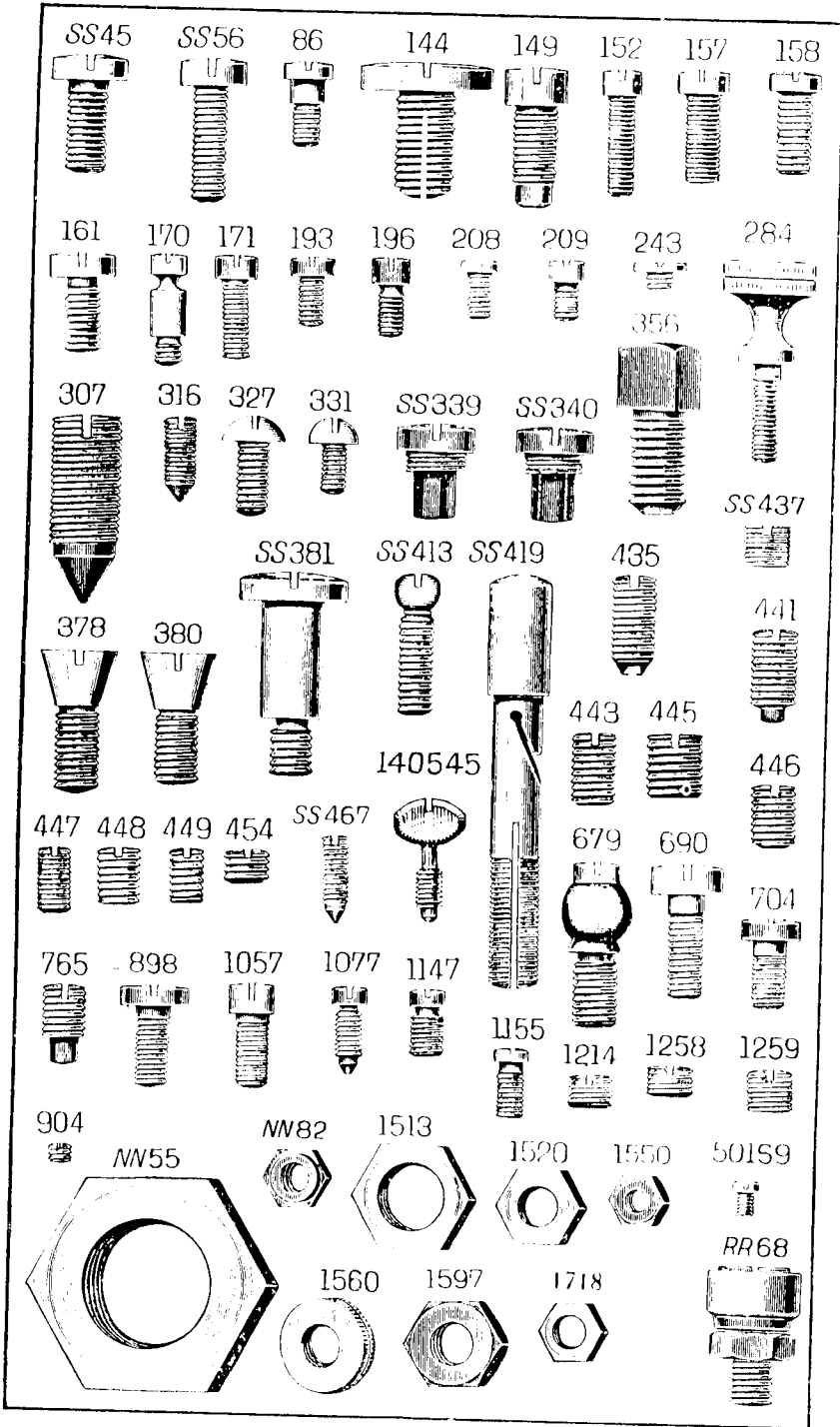

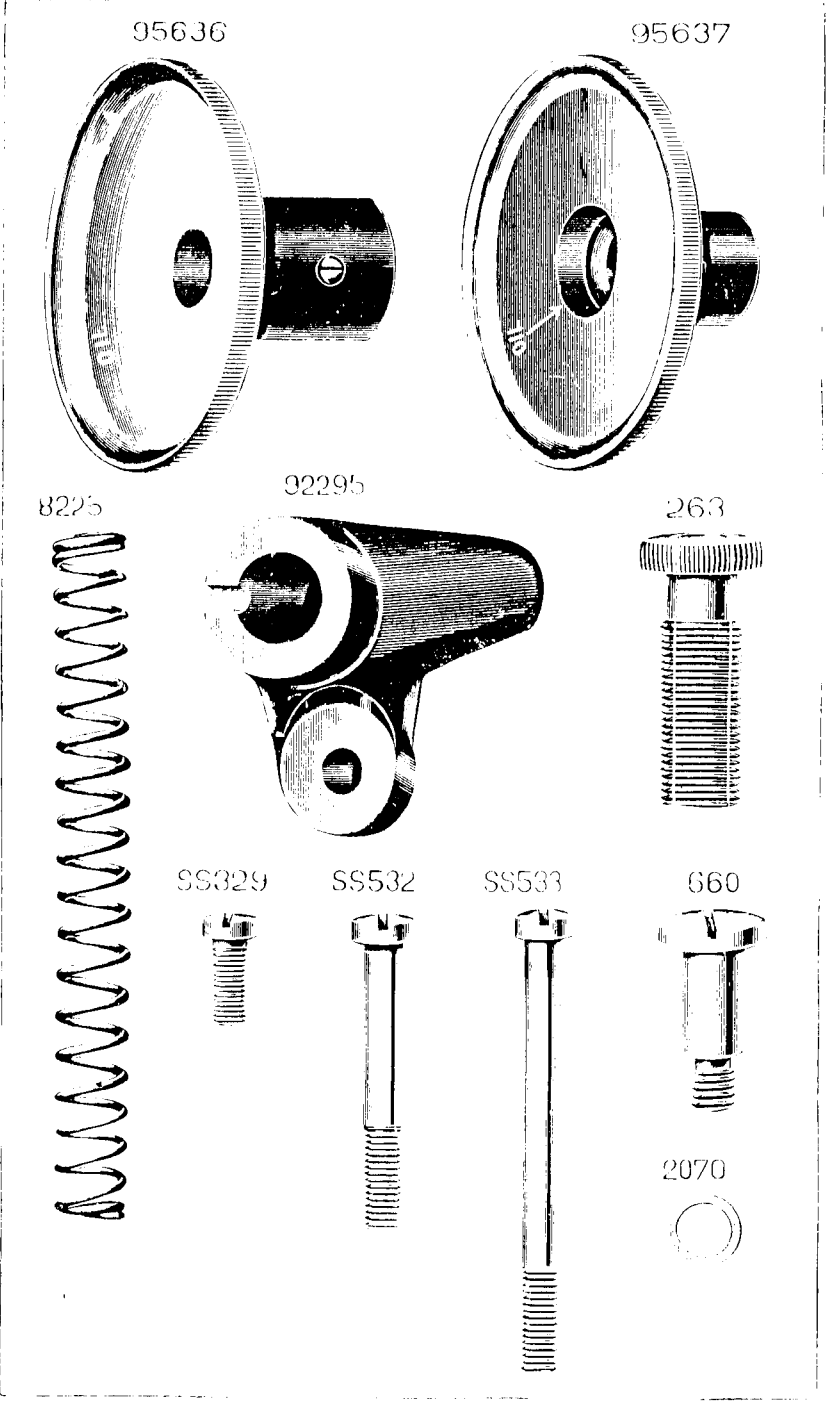
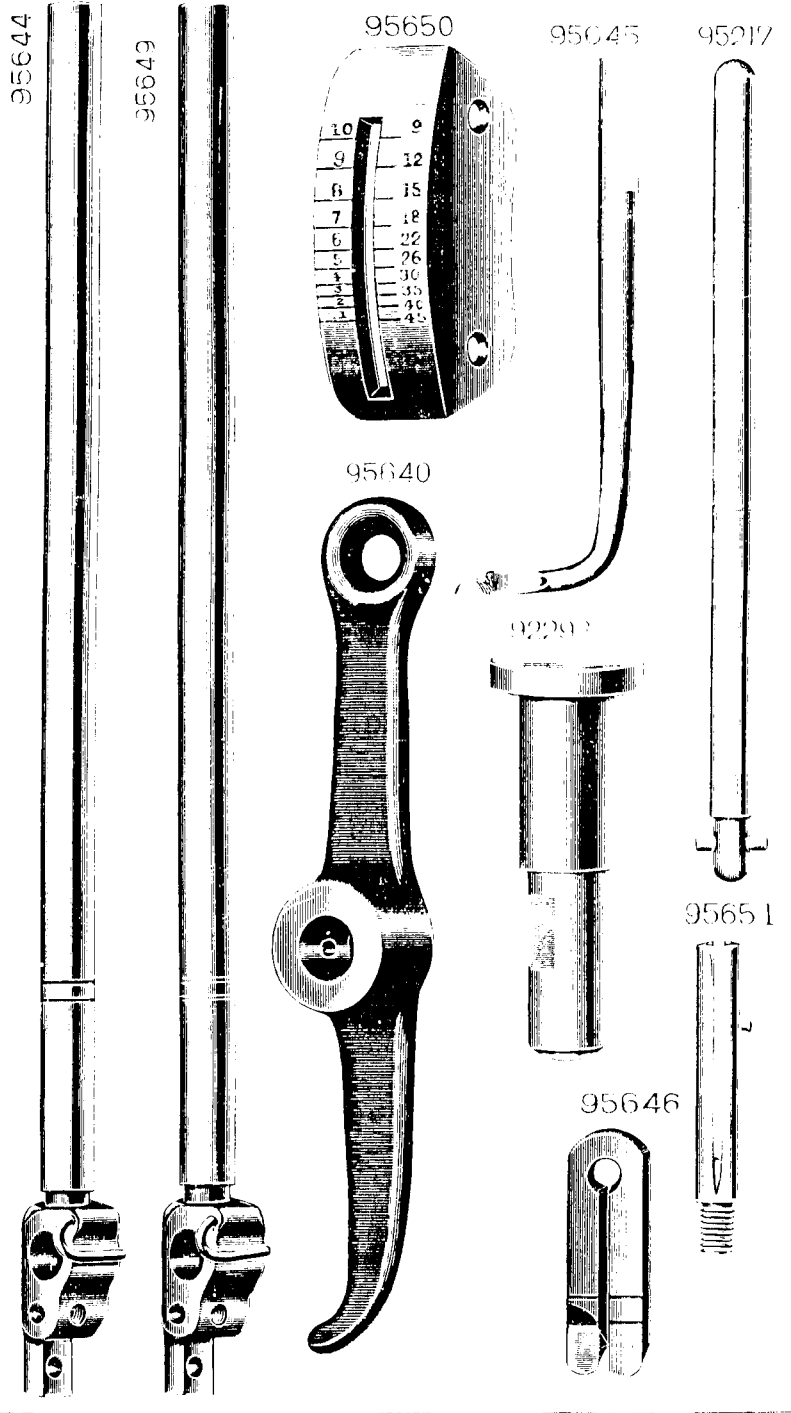

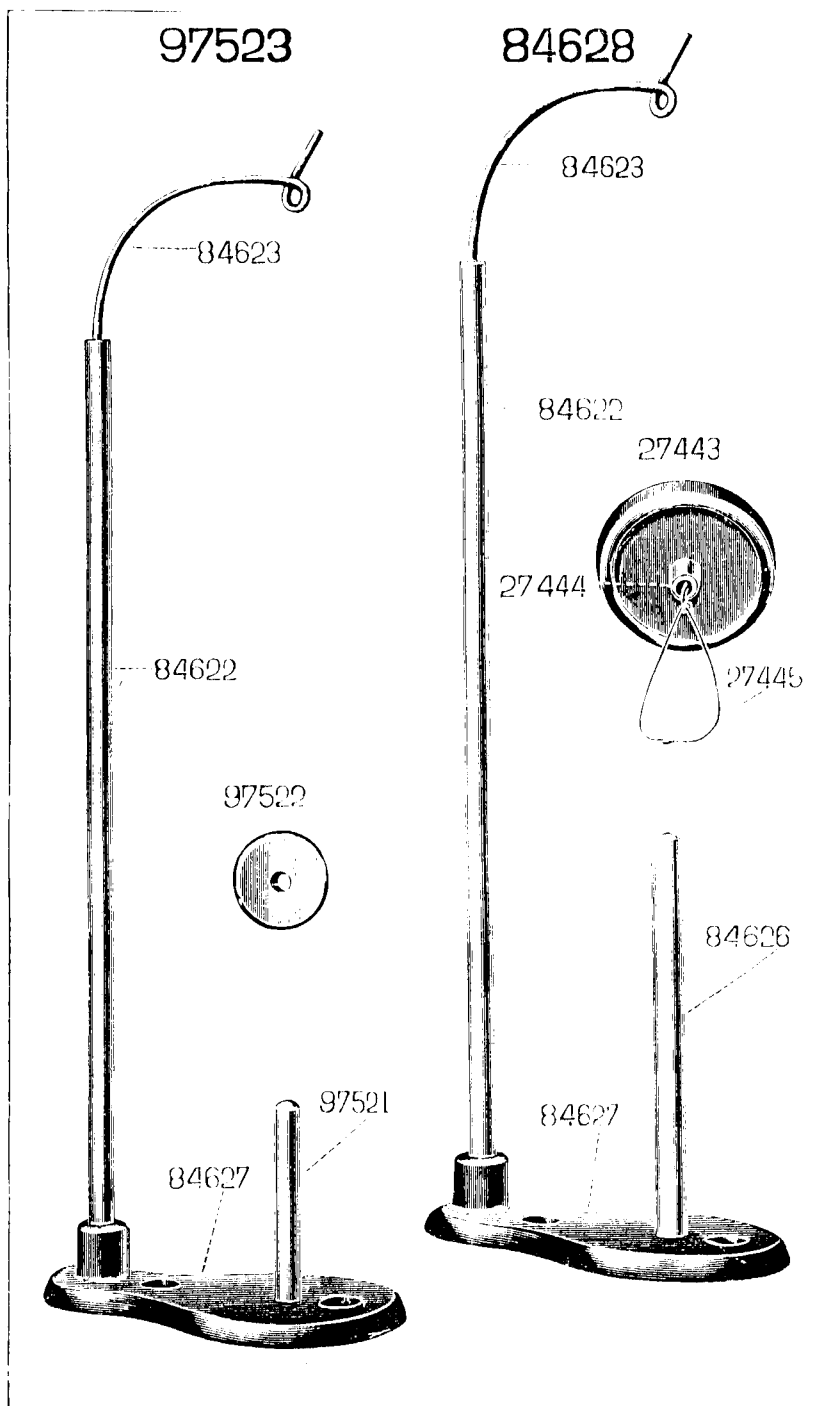

INSTRUCTIONS FOR ORDERING

In ordering from this List, the prefix and affix letters with the part number **MUST BE** quoted exactly as they are shown in the first column.

A number always indicates the same part in whatever List it may appear on or for whatever machine.

The affix letters (where shown) indicate the style of finish, as follows:

- A. Hardened, Polished, Nickel Plated and Buffed.
- A.A. Buffed and Chromium Plated.
- A.B. Hardened, Polished, Buffed and Chromium Plated.
- A.C. Brown Baking Enamel Finish.
- A.D. Grey Baking Enamel Finish.
- A.E. Hardened, Bright Rumbled and Nickel Plated.
- A.F. Hardened, Bright Rumbled and Nickel Plated, Bright Rumbled and Chromium Plated.
- A.J. Polished, Nickel Plated and Chromium Plated.
- A.K. Hardened, Polished, Nickel Plated and Chromium Plated.
- A.L. Heat Treated for Toughness.
- A.L.X. Heat Treated for Toughness and Black Oxide.
- A.P.P. Grey Wrinkle.
- B. Polished, Nickel Plated and Buffed.
- C. Hardened only.
- C.R. Hardened and Phosforic Treated.
- D. Polished only.
- E. Soft, not Polished.
- F. Hardened and Polished.
- F.J. Hardened, Polished and Nickel Plated.
- G. Bright Rumbled and Nickel Plated.
- H. Blued.
- J. Nickel Plated only.
- K. Hardened and Nickel Plated.
- L. Brass Plated.
- M. Oxidized.
- N. Japanned, Dull.
- P. Japanned, Bright.
- P.P. Wrinkle Finish.
- R. Phosforic Treated.
- S. Cadmium Plated.
- T. Copper Plated.
- T.A. Hardened, Polished, Copper and Nickel Plated and Buffed.
- T.B. Copper and Nickel Plated and Polished.
- T.J. Copper and Nickel Plated only.
- T.K. Hardened, Copper and Nickel Plated.
- T.L. Copper and Brass Plated.
- T.M. Copper Plated and Oxidized.
- U. Zinc Plated.
- V. Silver Plated.
- W. Polished and Nickel Plated.
- X. Black Oxide for Iron and Steel.
- X.C. Hardened and Black Oxide for Iron and Steel.
- Y. Black Nickel Plated only.
- Z. Chromium Plated.
- Z.A. Hardened, Polished, Nickel Plated, Buffed and Chromium Plated.
- Z.B. Polished, Nickel Plated, Buffed and Chromium Plated.
- Z.C. Hardened and Chromium Plated.
- Z.D. Polished and Chromium Plated.
- Z.G. Bright Rumbled, Nickel Plated, Bright Rumbled and Chromium Plated.
- Z.J. Nickel and Chromium Plated.
- Z.T. Copper and Chromium Plated.

Parts marked with an asterisk () are furnished only when the repairs are made at Factory.*

Parts Complete for No. 46K48 Machine

For Fine Fur Work (Surjeteuse) fitted with Stitch Regulator with Indicator, Friction Feed Motion and Ball-Bearing Front Feeding Disc. Single Thread Chain Stitch.

| No. | Plate | | | | | |
|-------|-------|--|-----|-----|-----|-----|
| 95213 | 1026 | Cover Plate | ... | ... | ... | ... |
| 95584 | | Cover Plate, complete, Nos. 331d, 88419f, 1560f, 19109, 95213, 95352, 95573, 95652 and two 2102 | ... | ... | ... | ... |
| | 2117 | Cover Plate Hinge Pin | ... | ... | ... | ... |
| 95213 | 1729 | " " Latch Spring | ... | ... | ... | ... |
| | 1931 | " " " " Screw (2) | ... | ... | ... | ... |
| 62301 | 1492 | Feed Adjusting Lever with 446 | ... | ... | ... | ... |
| | 446 | " " " Set Screw | ... | ... | ... | ... |
| | 307 | " " " Screw Centre (2) | ... | ... | ... | ... |
| | 1513j | " " " " " Nut (2) | ... | ... | ... | ... |
| 92100 | 1729 | " " " Spring | ... | ... | ... | ... |
| 95560 | 1734 | " " " " Guide with 82216 | ... | ... | ... | ... |
| 95561 | 1734 | " " " " Plunger | ... | ... | ... | ... |
| 82216 | 1723 | " " " " Position Pin | ... | ... | ... | ... |
| 95562 | 1734 | " " " " Regulator | ... | ... | ... | ... |
| | 184 | " " " " Hinge Screw | ... | ... | ... | ... |
| 95563 | 1734 | " " " " Plunger | ... | ... | ... | ... |
| 95564 | 1734 | " " " " Sleeve | ... | ... | ... | ... |
| | 1633 | " " " " Nut | ... | ... | ... | ... |
| 95565 | | Feed Adjusting Lever Spring Regulator, complete, Nos. 184, 1633, and 95560 to 95564 | ... | ... | ... | ... |
| 92295 | 1830 | Feed Bell Crank | ... | ... | ... | ... |
| 92017 | | " " " Connecting Rod | ... | ... | ... | ... |
| 92033 | 1728 | " " " " " 92017 with 92034, 92256 and four 196d | ... | ... | ... | ... |
| 92034 | | " " " " " Cap (plain countersink) (for Friction Drive Universal Joint Screw) | ... | ... | ... | ... |
| 92256 | | " " " " " Connecting Rod Cap (elongated countersink) (for Bell Crank Universal Joint Screw) | ... | ... | ... | ... |
| | 196d | " " " " " Connecting Rod Cap Binding Screw | ... | ... | ... | ... |
| 92293 | 1829 | " " " Fulcrum Stud | ... | ... | ... | ... |
| | 448 | " " " " " Set Screw | ... | ... | ... | ... |
| | 679c | " " " Universal Joint Screw | ... | ... | ... | ... |

| No. | Plate | | | | | | | |
|--------|-------|--|-----|-----|-----|-----|-----|-----|
| 95311 | 1725 | Feed Bracket (front) | ... | ... | ... | ... | ... | ... |
| NN55e | 1736 | " " Nut | ... | ... | ... | ... | ... | ... |
| 95585 | 1724 | Feed Cam with 443c | ... | ... | ... | ... | ... | ... |
| 443c | 1736 | " " Set Screw | ... | ... | ... | ... | ... | ... |
| 2039 | 1726 | Feed Connecting Link | ... | ... | ... | ... | ... | ... |
| 380c | 1736 | " " Hinge Screw (2) | ... | ... | ... | ... | ... | ... |
| 1520r | 1736 | " " Nut (2) | ... | ... | ... | ... | ... | ... |
| 92041 | 1026 | Feed Forked Connection | ... | ... | ... | ... | ... | ... |
| 378c | 1736 | " " Hinge Screw | ... | ... | ... | ... | ... | ... |
| 1520r | 1736 | " " Nut | ... | ... | ... | ... | ... | ... |
| 95232 | 1026 | Feed Friction Shaft (upright) | ... | ... | ... | ... | ... | ... |
| SS45d | 1736 | " " End Screw | ... | ... | ... | ... | ... | ... |
| 95313 | 1729 | " " Washer | ... | ... | ... | ... | ... | ... |
| 95212 | 1723 | " " Friction Spring | ... | ... | ... | ... | ... | ... |
| 765ad | 1736 | " " Tension Screw | ... | ... | ... | ... | ... | ... |
| 95213 | 1729 | " " Washer | ... | ... | ... | ... | ... | ... |
| 95233 | 1723 | " " Position Collar with 1258c and 1259c | ... | ... | ... | ... | ... | ... |
| 1258c | 1736 | " " Set Screw (short) | ... | ... | ... | ... | ... | ... |
| 1259c | 1736 | " " " (long) | ... | ... | ... | ... | ... | ... |
| 95314 | 1726 | Feed Friction Wheel with 435c, 441d and two 765ad | ... | ... | ... | ... | ... | ... |
| 441d | 1736 | " " Position Screw | ... | ... | ... | ... | ... | ... |
| 435c | 1736 | " " Set Screw | ... | ... | ... | ... | ... | ... |
| 95315 | 1728 | Feed Friction Wheel Driver | ... | ... | ... | ... | ... | ... |
| 95316 | 1729 | " " Block (inside) | ... | ... | ... | ... | ... | ... |
| SS339c | 1736 | " " (") Screw Stud | ... | ... | ... | ... | ... | ... |
| 95317 | 1729 | " " (") | ... | ... | ... | ... | ... | ... |
| SS340c | 1736 | " " (") Screw Stud | ... | ... | ... | ... | ... | ... |
| 243c | 1736 | " " (") End Screw | ... | ... | ... | ... | ... | ... |
| 94967 | 1729 | " " Spring | ... | ... | ... | ... | ... | ... |
| 95230 | 1728 | " " Hook | ... | ... | ... | ... | ... | ... |
| 170c | 1736 | " " Screw Stud | ... | ... | ... | ... | ... | ... |
| 679c | 1736 | " " Universal Joint Screw | ... | ... | ... | ... | ... | ... |
| 1520r | 1736 | " " Nut | ... | ... | ... | ... | ... | ... |
| 95318 | | Feed Friction Wheel Driver , complete, Nos. 170c, 243c, SS339c, SS340c and 95315 to 95317 | ... | ... | ... | ... | ... | ... |

| No. | Plate | | | | | | | |
|-------|-------|--|-----|-----|-----|-----|-----|-----|
| 95319 | 1726 | Feed Friction Wheel Retaining Clutch with 95271 | ... | ... | ... | ... | ... | ... |
| 95322 | 1726 | " " Bracket with 95271 | ... | ... | ... | ... | ... | ... |
| 95271 | 1723 | " " Spring Hook | ... | ... | ... | ... | ... | ... |
| 690c | 1736 | " " Screw | ... | ... | ... | ... | ... | ... |
| 95320 | 1723 | " " Hinge Pin | ... | ... | ... | ... | ... | ... |
| 95334 | 1724 | " " Spring | ... | ... | ... | ... | ... | ... |
| 95271 | 1723 | " " Hook | ... | ... | ... | ... | ... | ... |
| 95323 | | Feed Friction Wheel Retaining Clutch , complete, Nos. 95319, 95320 and 95322 | ... | ... | ... | ... | ... | ... |
| 95481 | 1723 | Feed Regulating Lever with 1581 | ... | ... | ... | ... | ... | ... |
| 1581 | 1736 | " " Binding Screw | ... | ... | ... | ... | ... | ... |
| 95485 | 1723 | " " Segment | ... | ... | ... | ... | ... | ... |
| 161c | 1736 | " " Screw (2) | ... | ... | ... | ... | ... | ... |
| 95486 | 1723 | " " Stitch Indicator | ... | ... | ... | ... | ... | ... |
| 284d | 1736 | " " Thumb Screw | ... | ... | ... | ... | ... | ... |
| 95375 | 1828 | Feed Regulator | ... | ... | ... | ... | ... | ... |
| 95376 | 1724 | " " Bush | ... | ... | ... | ... | ... | ... |
| 1491 | 1736 | " " Set Screw | ... | ... | ... | ... | ... | ... |
| 389c | 1736 | " " Hinge Screw | ... | ... | ... | ... | ... | ... |
| 1520r | 1736 | " " Nut | ... | ... | ... | ... | ... | ... |
| 95640 | 1829 | Feed Roll Opening Lever | ... | ... | ... | ... | ... | ... |
| 95644 | | " " 95640 with 660d | ... | ... | ... | ... | ... | ... |
| 660d | 1830 | " " Hinge Screw | ... | ... | ... | ... | ... | ... |
| 95567 | 1733 | Feeding Disc (front) | ... | ... | ... | ... | ... | ... |
| 36737 | 1727 | " " Ball, 1 1/2" diam. | ... | ... | ... | ... | ... | ... |
| 95472 | 1727 | " " Stud | ... | ... | ... | ... | ... | ... |
| 95473 | 1727 | " " Bushing | ... | ... | ... | ... | ... | ... |
| 445c | 1736 | " " Binding Screw | ... | ... | ... | ... | ... | ... |
| 316c | 1736 | " " Raising Set Screw | ... | ... | ... | ... | ... | ... |
| 1211c | 1736 | " " Set Screw | ... | ... | ... | ... | ... | ... |
| 1597c | 1736 | " " Nut | ... | ... | ... | ... | ... | ... |
| 95568 | | Feeding Disc (front, ball bearing), complete, Nos. 1211c, 1597c, 95472, 95473, 95567 and twenty 36737 | ... | ... | ... | ... | ... | ... |
| 95569 | 1733 | Feeding Disc (back) with 454d | ... | ... | ... | ... | ... | ... |
| 454d | 1736 | " " Set Screw | ... | ... | ... | ... | ... | ... |
| 95570 | 1828 | Fur Guide | ... | ... | ... | ... | ... | ... |
| 1521 | 1736 | " " Binding Screw | ... | ... | ... | ... | ... | ... |
| 95212 | 1026 | Hand Wheel with two 448c | ... | ... | ... | ... | ... | ... |
| 448c | 1736 | " " Set Screw | ... | ... | ... | ... | ... | ... |

| No. | Plate | |
|--------|-------|---|
| 95487 | | Head of Machine |
| SS56d | 1736 | " " " Binding Screw (2) |
| 95645 | 1829 | Looper |
| 1147c | 1736 | " Binding Screw (2) |
| 92266 | 1727 | " Holder |
| 92288 | " | " " 92266 with RR68 |
| 95244 | | Looper Holder Connection, complete, Nos. 209d, SS467c, 1077c, 1550h, 92280, 92283, 92284, 92288, 92384, 92388, 95260, 95332, 95400, 95401 and four 1155c |
| 92267 | 1724 | Looper Holder Position Link with 171c |
| 95468 | 1828 | " " " " Bracket |
| 95566 | 1828 | " " " " " Plate |
| SS56d | 1736 | " " " " " Binding Screw (2) |
| 2022 | 1723 | " " " " " Steady Pin |
| 92268 | 1727 | " " " " " Distance Rod |
| SS437c | 1736 | " " " " " End Screw |
| 171c | 1736 | " " " " " Binding Screw |
| SS413c | 1736 | " " " " " Universal Joint Screw |
| 1718b | 1736 | " " " " " Nut (bottom) |
| NN82c | 1736 | " " " " " Nut (top) |
| 92269 | | Looper Holder Position Link, complete, Nos. SS437c, 92267, 92268 and two SS413c |
| 92283 | 1727 | Looper Holder Rock Shaft Bracket (right side) |
| SS467c | 1736 | " " " " " (top) Adjusting Screw |
| 1550h | 1736 | " " " " " (bottom) Adjusting Screw Nut |
| 92284 | 1727 | " " " " " (left side) Set Screw |
| 1155c | 1736 | " " " " " Set Screw |
| 92388 | 1724 | " " " " " Eccentric with two 446c |
| 95332 | 1728 | " " " " " Connecting Rod with 95333 and two 1057c |
| *95333 | | " " " " " Connecting Rod Cap |
| 1057c | 1736 | " " " " " Screw |
| 95260 | 1723 | " " " " " Stud |
| 446c | 1736 | " " " " " Set Screw |
| 95400 | 1723 | " " " " " Fulcrum Joint |
| 95401 | 1724 | " " " " " Collar with 171c |
| 171c | 1736 | " " " " " Binding Screw |
| 92384 | 1727 | " " " " " Stud |
| 209d | 1736 | " " " " " Set Screw |
| 1077c | 1736 | " " " " " Spot Screw |
| 95262 | 1725 | " " " " " Oil Cover |

| No. | Plate | |
|---------|-------|---|
| 92280 | 1727 | Looper Holder Rock Shaft Stud |
| 92281 | 1724 | " " " " " Bushing |
| 117c | 1736 | " " " " " Set Screw |
| 92282 | 1724 | " " " " " Collar with 704c |
| 704c | 1736 | " " " " " Clamping Screw |
| RR68 | 1736 | " " " " " Roller and Screw Stud with 378c and 1520c |
| 378c | 1736 | " " " " " Screw |
| 1520c | 1736 | " " " " " Nut |
| 95264 | | Machine Base |
| 8291 | 1729 | " " " Hinge Connection |
| 2809 | 1723 | " " " " Pin |
| 95265 | | Machine Base, complete, Nos. 95264, two each 2809 and 8291 |
| 95308 | 1026 | Machine Driving Pulley with two 448c |
| 448c | 1736 | " " " " " Set Screw |
| 95309 | 1026 | " " " " " Shaft |
| 444c | 1736 | " " " " " End Screw (2) |
| 95398 | 1724 | " " " " " Looper Cam (Steel) with two 445c |
| 445c | 1736 | " " " " " Set Screw |
| 95211 | 1726 | " " " " " Oil Hole Cover (right) |
| 95483 | 1723 | " " " " " (left) |
| 86d | 1736 | " " " " " Hinge Screw (2) |
| 95644 | 1829 | Needle Bar with 95357 |
| 95267 | 1724 | " " " Bushing |
| 443c | 1736 | " " " " " Set Screw |
| 95268 | 1729 | " " " Clamp with 110545c |
| 110545c | 1736 | " " " " " Thumb Screw |
| 95338 | 1726 | " " " Eccentric with 449c |
| 92074 | 1723 | " " " " " Dowel Pin |
| 92275 | 1727 | " " " " " Fork with SS329c |
| SS329c | 1830 | " " " " " Clamping Screw |
| 92276 | 1727 | " " " " " Strap |
| 208c | 1736 | " " " " " Screw |
| 92277 | | " " " " " complete, Nos. 92275, 92276 and two 208c |
| 449c | 1736 | " " " " " Set Screw |
| 95357 | 1728 | " " " Thread Guide |
| 95298 | 1729 | " " " " " Ripper |
| 95489 | 1723 | " " " " " Spring |
| 95300 | 1728 | " " " " " Adjusting Bracket |
| 504c | 1736 | " " " " " Set Screw |

| No. | Plate | |
|--------|-------|--|
| 95649 | 1829 | Needle Bar with 95357 |
| 95490 | 1723 | " " Needle Stop |
| 50169d | 1736 | " " " " Screw |
| 95647 | | Needle Bar , complete, Nos. 50169d, 95490 and 95649 |

NOTE. Needle Bar No. 95647 is sent with this Machine unless otherwise specified on order.

| | | |
|--------|------|--|
| 95646 | 1829 | Needle Guide with two 95275 |
| 898f | 1736 | " " Binding Screw |
| 95275 | 1723 | " " Position Pin |
| 92079 | 1725 | Reel Holder |
| 327d | 1736 | " " Binding Screw (2) |
| 8800 | 1723 | " " " " Washer (2) |
| 2102 | 1729 | Tension Disc |
| SS419l | 1736 | " Screw Stud and Thread Guide |
| 331d | 1736 | " " " " Set Screw |
| 1560d | 1736 | " " " " Thumb Nut |
| 95352 | 1729 | " Spring |
| 95573 | 1828 | Thread Guide for Cover Plate |
| 49109 | 1723 | " " Washer |
| 95340 | 1729 | Thread Nipper Spindle |
| 171c | 1736 | " " " " Binding Screw |
| 95651 | 1829 | Thread Take-up Post with 95367 |
| 95365 | 1723 | " " Spring |
| 95366 | 1729 | " " " " Collar |
| 95367 | | " " " " Stop Pin |
| 95652 | | Thread Take-up , complete, Nos. 95365, 95366 and 95651 |
| 95639 | | Drip Pan with two each SS532d and Wood Screws $\frac{1}{4}$ " No. 10, for machines without Iron Base (1 $\frac{1}{2}$ " tables) |
| 95648 | | Drip Pan with two each SS533d and Wood Screws $\frac{1}{4}$ " No. 10, for machines on Power Tables (1 $\frac{3}{4}$ " tables) |
| SS532d | 1830 | Drip Pan Screw for 95639 |
| SS533d | 1830 | " " " " 95648 |

NOTE. As the machines are regularly fitted with Iron Base, Drip Pans are only supplied when specified on order.

Parts Special to No. 46K49 Machine

For Fur Work (Surjeteuse), fitted with Stitch Regulator with Indicator, Friction Feed Motion and Ball-Bearing Front Feeding Disc. Single Thread Chain Stitch.

This machine is the same as No. 46K48 with the following exceptions:—

| No. | Plate | |
|--|-------|---|
| 95583 | | Cover Plate , complete, Nos. 331d, SS419l, 1560d, 1700c, 49109, 95213, 95352, 95581 and two 2102 |
| 95574 | 1733 | Feeding Disc (front) |
| 95575 | | Feeding Disc (front, ball bearing), complete, Nos. 1214c, 1597c, 95472, 95473, 95574 and twenty 36737 |
| 95576 | 1733 | Feeding Disc (back) with 454d |
| 95577 | 1828 | Fur Guide |
| 95477 | 1727 | Looper |
| 95480 | | Looper Holder Connection , complete, Nos. 209d, SS467c, 1077c, 1550h, 92280, 92283 to 92285, 92288, 92381, 95260, 95332, 95400, 95401 and four 1155c |
| 92285 | 1724 | Looper Holder Rock Shaft Eccentric with two 116c |
| 95474 | 1724 | Machine Driving Pulley Shaft Looper Cam (steel) with two 115c |
| 95478 | 1725 | Needle Bar with 95357 |
| 95450 | 1723 | " " Clamp with 110545c |
| 95350 | 1726 | " " Eccentric with 119c |
| 95578 | 1828 | Needle Bar with 95357 |
| 95579 | | Needle Bar , complete, Nos. 50169d, 95490 and 95578 |
| <i>NOTE.</i> Needle Bar No. 95579 is sent with this machine unless otherwise specified on order. | | |
| 95580 | 1828 | Needle Guide with two 95275 |
| 95581 | 1828 | Thread Guide for Cover Plate |
| 1700c | 1828 | " " Nut |

Parts Special to No. 46K53 Machine

(OBSOLETE)

For Linen and Handkerchief Work, fitted with Stitch Regulator with Indicator, Friction Feed Motion and Ball-Bearing Front Feeding Disc, Single Thread Chain Stitch.

This machine is the same as No. 46K48 with the following exceptions:

| | | | |
|--------|-------|---|-----|
| No. | Plate | | |
| 95217 | 1829 | Feed Adjusting Lever Spindle with 82216 | ... |
| 82216 | 1723 | " " " " Position Pin | ... |
| 8225 | 1830 | Feed Adjusting Lever Spring | ... |
| 2636 | 1830 | " " " " Regulating Thumb Screw | ... |
| 2070 | 1830 | " " " " Washer | ... |
| 95650 | 1829 | Feed Regulating Lever Segment | ... |
| 95637 | 1830 | Feeding Disc (front) | ... |
| 95638 | | Feeding Disc (front, ball bearing), complete, Nos. 1214c, 1597c, 95472, 95473, 95637 and twenty 36737 | ... |
| 95636 | 1830 | Feeding Disc (back) with 1544 | ... |
| 95639 | | Drip Pan with two each S8532d and Wood Screws $\frac{1}{4}$ " No. 10, for machines without Iron Base (1 $\frac{1}{2}$ " table) | ... |
| 95648 | | Drip Pan with two each S8533d and Wood Screws $\frac{1}{4}$ " No. 10, for machines on Power Table (1 $\frac{1}{2}$ " table) | ... |
| S8532d | 1830 | Drip Pan Screw for 95639 | ... |
| S8533d | 1830 | " " " " 95648 | ... |

NOTE. Machine Base (Iron) No. 95265 is not regularly supplied with this machine, but it can be furnished in place of Drip Pan if specified on order.

Accessories

| No. | Plate | |
|----------|-------|---|
| 215 × 17 | | Needles , three each sizes 7 and 11, for 46K48 Machine |
| 215 × 15 | | " " " " " " 11 and 16, for 46K49 Machine |
| 215 × 17 | | " " " " " " six size 1, for 46K53 Machine |
| 36569 | 1355 | Oiler |
| 25537 | 1355 | Screw Driver |
| 86262 | 1026 | Tweezers , for 46K48 and 46K49 Machines |
| 86405 | 1355 | " " " " 46K53 Machine |
| | | Wood Screw 1½" × 1" (3) (for fixing machine to table) |

Knee Lifter

| No. | Plate | |
|--------|-------|---|
| 2767 | 1023 | Knee Plate with 356 |
| 356c | 1736 | " " " " Set Screw |
| 92464 | 1023 | " " " " Arm |
| 2766 | 1023 | " " " " Bracket with 356c |
| 356e | 1736 | " " " " " " Set Screw |
| 92465 | 1023 | Lifting Lever |
| SS345e | 1023 | " " " " Hinge Screw |
| 92466 | 1023 | " " " " Bracket |
| | | " " " " " " Screw (Wood) 1" No. 10 |
| 92008 | 1023 | " " " " Connecting Rod |
| 92009 | | " " " " " " 92008 with 6337 |
| 6337 | 1023 | " " " " " " Bracket with two 356c |
| 356e | 1736 | " " " " " " " " Set Screw |
| 95302 | | " " " " 92465 with 180d, 210d, SS345e, 92466, 92469 and 95303 |
| 95303 | 1023 | " " " " Releasing Pin |
| 95304 | 1023 | " " " " " " Guide Plate |
| | | " " " " " " " " Screw (Wood) 1" No. 10 |
| 180d | 1023 | " " " " " " " " Set Screw |
| 92469 | 1023 | " " " " Stud |
| 210d | 1023 | " " " " " " Position Screw |

| No. | Plate | |
|-------|-------|---|
| 92470 | 1023 | Rock Shaft |
| 92471 | | " " " " 92470 with 2766, 2767, 92009 and 92464 |
| 82479 | 1023 | " " " " Bracket |
| | | " " " " " " Screw (Wood) 1" No. 10 |
| 95305 | | Knee Lifter , complete, Nos. 92471, 95302, 95304, two 82479 and nine Wood Screws 1" No. 10 |

Knee Lifter

for Machines WITHOUT Iron Base when used on Stand and Table only.

| No. | Plate | |
|--------|-------|---|
| 2767 | 1023 | Knee Plate with 356c |
| 356e | 1736 | " " " " Set Screw |
| 92464 | 1023 | " " " " Arm |
| 2766 | 1023 | " " " " " " Bracket with 356c |
| 356e | 1736 | " " " " " " " " Set Screw |
| 95457 | 1725 | Lifting Lever |
| SS345e | 1023 | " " " " Hinge Screw |
| 95458 | 1725 | " " " " Bracket |
| | | " " " " " " Screw (Wood) 1" No. 10 |
| 92008 | 1023 | " " " " Connecting Rod |
| 92009 | | " " " " " " 92008 with 6337 |
| 6337 | 1023 | " " " " " " Bracket with two 356c |
| 356e | 1736 | " " " " " " " " Set Screw |
| 95459 | | " " " " 95457 with SS345e and 95458 |
| 92470 | 1023 | Rock Shaft |
| 92471 | | " " " " 92470 with 2766, 2767, 92009 and 92464 |
| 82479 | 1023 | " " " " Bracket |
| | | " " " " " " Screw (Wood) 1" No. 10 |
| 95499 | | Knee Lifter , complete, Nos. 92471, 95459, two 82479 and seven Wood Screws 1" No. 10 |

Thread Unwinder

For one spool of thread for 46K53 Machine.

| No. | Plate | |
|-------|-------|---|
| 84626 | 1898 | Spool Pin (1" high) |
| 84627 | 1898 | " Rest |
| 27443 | 1898 | " Weight with 27444 and 27445 |
| 27444 | 1898 | " " Centre |
| 27445 | 1898 | " " Thread Guide |
| 84622 | 1988 | Thread Eyelet Rod |
| 84623 | 1898 | " " Wire |
| 84624 | | " " " 84623 with 84622 |
| 84628 | 1898 | Thread Unwinder , complete, Nos. 27443, 84624, 84626, 84627 and two Wood Screws 1" No. 12 |

Thread Unwinder

For one small spool of thread for 46K53 Machine.

| No. | Plate | |
|-------|-------|---|
| 97521 | 1898 | Spool Pin (2" high) |
| 84627 | 1898 | " Rest |
| 97522 | 1898 | " Weight |
| 84622 | 1898 | Thread Eyelet Rod |
| 84623 | 1898 | " " Wire |
| 84624 | | " " " 84623 with 84622 |
| 97523 | 1898 | Thread Unwinder , complete, Nos. 84624, 84627, 97521, 97522 and two Wood Screws 1" No. 12 |

NOTE: Thread Unwinder No. 84628 is supplied with machine unless otherwise specified on order.

Free Manuals Download Website

<http://myh66.com>

<http://usermanuals.us>

<http://www.somanuals.com>

<http://www.4manuals.cc>

<http://www.manual-lib.com>

<http://www.404manual.com>

<http://www.luxmanual.com>

<http://aubethermostatmanual.com>

Golf course search by state

<http://golfingnear.com>

Email search by domain

<http://emailbydomain.com>

Auto manuals search

<http://auto.somanuals.com>

TV manuals search

<http://tv.somanuals.com>