

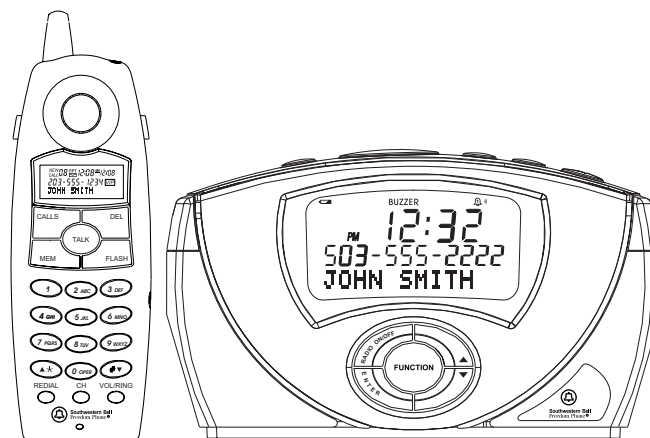

2.4GHz Clock Radio Cordless Telephone with Call Waiting Caller ID



STOP - DON'T TAKE ME BACK TO THE STORE.
LOOK - FOR THE TOLL-FREE "HELP" TELEPHONE NUMBER.
LISTEN - AS THE EXPERTS TALK YOU THROUGH THE PROBLEM.

For immediate answers to your questions regarding operation,
missing parts or installation, call:

Southwestern Bell Freedom Phone®
Retail Sales Help Line at

1-800-366-0937

Monday - Friday 8:30 a.m. - 9:00 p.m. EST

Saturday 8:30 a.m. - 12:30 p.m. EST

[http:// www.swbfreedomphone.com](http://www.swbfreedomphone.com)

SOUTHWESTERN BELL FREEDOM PHONE
7475 N. GLEN HARBOR BLVD., GLENDALE, AZ 85307

GH3060

Printed in China

IB-4640A

GH3060 OWNER'S MANUAL
Toll Free Helpline 1-800-366-0937
<http://www.swbfreedomphone.com>

PLEASE READ IMPORTANT SAFETY INSTRUCTIONS BEFORE USE.

Congratulations!

You have purchased a 2.4GHz Clock Radio Cordless Telephone with Call Waiting Caller ID that has been manufactured to the highest standards of **SOUTHWESTERN BELL FREEDOM PHONE**® Retail Sales. Its "DIGICLEAR PLUS™" circuitry combines noise filtering with state of the art technology that reduces background noise during your telephone conversations. Special compander circuitry compresses, then expands, the transmitted signal to enhance clean, clear audio.

BEFORE INSTALLING AND OPERATING THIS TELEPHONE, IT IS VERY IMPORTANT THAT YOU READ THIS OWNER'S MANUAL.

IMPORTANT SAFETY INSTRUCTIONS

WHEN USING YOUR TELEPHONE EQUIPMENT, BASIC SAFETY PRECAUTIONS SHOULD ALWAYS BE FOLLOWED TO REDUCE THE RISK OF FIRE, ELECTRIC SHOCK AND INJURY TO PERSONS, INCLUDING THE FOLLOWING:

1. Do not use this product near water, for example, near a bathtub, wash bowl, kitchen sink or laundry tub, in a wet basement or near a swimming pool.
2. Avoid using a telephone (other than a cordless type) during an electrical storm. There may be a remote risk of electric shock from lightning.
3. Do not use the telephone to report a gas leak in the vicinity of the leak.
4. Use only the power cord and batteries indicated in this manual. Do not dispose of batteries in a fire. They may explode. Check with local codes for possible special disposal instructions.

**5. CAUTION
RISK OF EXPLOSION IF BATTERY IS REPLACED BY AN INCORRECT TYPE.
DISPOSE OF USED BATTERIES ACCORDING TO THE INSTRUCTIONS.**

SAVE THESE INSTRUCTIONS

Safety Instructions for Batteries

Handset Battery Pack

CAUTION:

Use only a Southwestern Bell Freedom Phone® approved battery pack in the handset of your GH3060 Cordless Telephone. To reduce the risk of fire or injury, always do the following when replacing, discarding or charging batteries. When handling the batteries, be careful not to short the battery with conducting materials such as rings, bracelets, and keys. The battery or conducting material may overheat and cause burns.

- a. Use only the following type and size batteries in the cordless phone:
Self-contained 3-cell Nickel-Metal-hydride rechargeable battery supply,
GP60 AAAH 3BMXZ 3.6V 600mAh or JB60AAANM3BMX 3.6V 600mAh
GPI International Ltd. JB Energy (HK) Ltd.
- b. Do not dispose of the battery pack in a fire. The cell may explode. Check with local codes for possible special disposal instructions.
- c. Do not attempt to open or mutilate the battery pack. The chemicals are dangerous and may cause damage to the eyes or skin, and may be toxic if swallowed.
- d. Follow the charging instructions outlined in this manual. (See page 10)

Save These Instructions

Handset Battery Caution

CAUTION:

To Reduce the Risk of Fire or Injury to Persons, Read and Follow These Instructions.

1. Use only the following type and size batteries in the cordless phone:
Self-contained 3-cell Nickel-Metal-hydride rechargeable battery supply.
GP60 AAAH 3BMXZ 3.6V 600mAh or JB60AAANM3BMX 3.6V 600mAh
GPI International Ltd. JB Energy (HK) Ltd.
2. Use only the following type and size battery in the base unit: 9V (1604) Alkaline Battery.
3. Do not dispose of the battery(ies) in a fire. The cell may explode. Check with local codes for possible special disposal instructions.
4. Do not open or mutilate the battery(ies). Released electrolyte is corrosive and may cause damage to the eyes or skin. It may be toxic if swallowed.
5. Exercise care in handling batteries in order not to short the battery with conducting material such as rings, bracelets, and keys. The battery or conductor may overheat and cause burns.
6. Charge the battery(ies) provided with or identified for use with this product only in accordance with the instructions and limitations specified in this manual.
7. Do not mix old and new batteries in this product (applies to products employing more than one user replaceable second battery).
8. Do not mix batteries of different sizes or from different manufacturers in this product (applies to products employing more than one user replaceable secondary battery).
9. Do not attempt to recharge the battery(ies) provided with or identified for use with this product. The batteries may leak corrosive electrolyte or explode.
10. Do not attempt to rejuvenate the battery(ies) provided with or identified for use with this product by heating them. Sudden release of the battery electrolyte may occur causing burns or irritation to the eyes or skin.
11. When inserting batteries into this product, the proper polarity or direction must be observed. Reverse insertion of batteries can cause charging, and that may result in leakage or explosions. (Applies to product employing more than one separately replaceable primary battery).
12. Remove the batteries from this product if the product will not be used for a long period of time (several months or more) since during this time the battery could leak in the product.
13. Discard "dead" batteries as soon as possible since "dead" batteries are more likely to leak in a product.
14. Do not store this product, or the batteries provided with or identified for use with this product, in high temperature areas. Batteries that are stored in a freezer or refrigerator for the purpose of extending shelf life should be protected from condensation during storage and defrosting. Batteries should be stabilized at room temperature prior to use after cold storage.

Southwestern Bell Freedom Phone GH3060 Cordless Telephone

Contents

Subject	Page	Subject	Page
Safety Instructions.....	2	CALLER ID OPERATION.....	25
Handset Battery Pack.....	3	Receiving a Call	
Handset Battery Caution.....	4	Receiving Call Waiting Caller ID	
Handset Diagram.....	6	Reviewing Calls	
Base Diagram.....	7	Caller ID Redial	
Traits of Cordless Telephones.....	8	Caller ID Erase	
Box Contents.....	9	VIP Calls	
INSTALLATION.....	9	Common Questions.....	29
Preliminary Preparation.....	9	Troubleshooting Guide.....	30
Telephone Line Installation		Product Care.....	33
Modular Outlet		Additional Information.....	33
Battery Backup		Speed Dialing Numbers Index.....	33
Desk or Table Installation		Service.....	34
Handset Battery Charging		FCC Wants You to Know.....	35
To Replace Batteries		Limited Warranty.....	37
Caller ID Setup			
TELEPHONE OPERATION.....	12		
Tone/Pulse Switch			
Digital Security System			
40 Channel Operation			
Making a Call			
Receiving a Call			
Headset Jack			
Out of Range			
Memory Feature			
Call Timer			
Flash			
Temporary Tone Feature			
Receiver Volume Control			
Ringer Control			
Speakerphone Volume Control			
Page/Handset Locator			
LED/LCD Indications (Handset)			
To Reset Unit			
ALARM OPERATION.....	21		
Setting the clock			
Setting the alarm time			
Wake up to buzzer/radio			
Snooze function			
RADIO OPERATION.....	22		
To play the radio			
Presetting station			
Listen to preset memory stations			
Sleep function			

Handset Diagram

HANDBSET CONTROLS: The diagram below shows the controls of the GH3060 Handset.

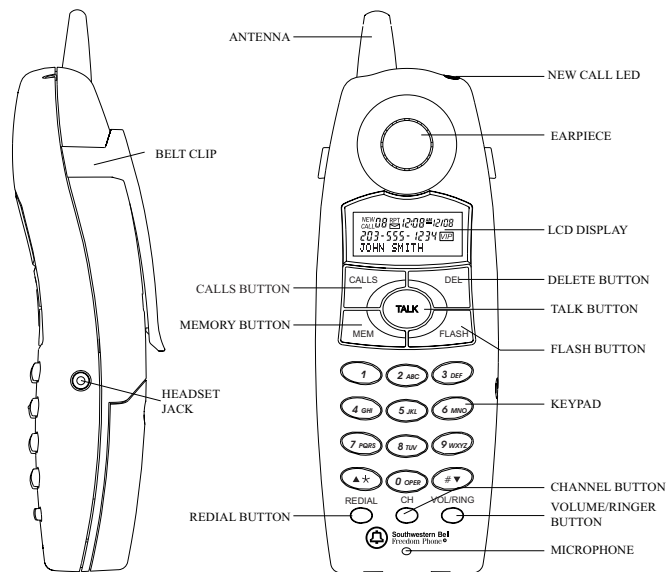

Base Diagram

BASE CONTROLS: This diagram shows the controls of the GH3060 Base.

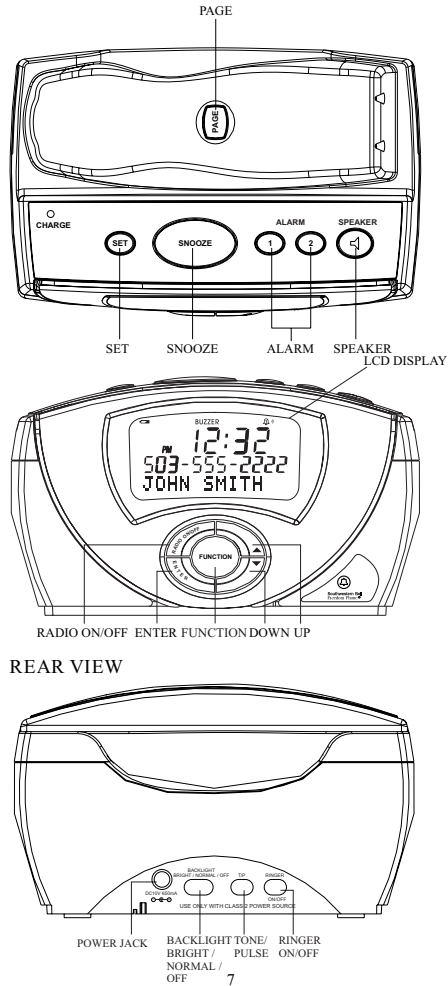

Traits of Cordless Telephones

A. Cordless telephones offer convenience and mobility during telephone conversations. The use of cordless telephones is dependent upon the availability of DC power. Any disruption of electrical power at your location will prevent the placing or receiving of telephone calls. It is recommended that a cordless telephone should not be installed as the only phone at your location.

B. The usable range of the cordless handset away from the base is dependent upon many factors. The telephone base is like a radio transmitter in that it transmits telephone line signals via radio waves to the handset. Therefore, the location of the base is important in order to maximize the usable range. For example, installing the base on the second floor, in some locations, will provide longer range than a ground floor installation. Pick a location that gives you the clearest signal. The following can adversely affect usable range:

- aluminum siding
- insulation with foil backing
- any metal construction which could shield radio signals.

Atmospheric conditions also play an important role in the performance of your cordless telephone.

Interference can be caused by placing the base near:

- fluorescent lights
- appliances that generate electrical noise, including:
 - microwaves
 - televisions
 - VCR's
 - baby monitors
 - computers

C. Always keep the base antenna fully upright.

D. For maximum performance, always keep the battery pack fully charged.

E. Plug your phone directly into an outlet, not an extension cord.

F. Do not plug other appliances into the outlet or control the outlet by a wall switch.

G. If you want to use more than one cordless telephone in your home, the telephones must operate on different channels. Press the channel key to select a channel that provides the clearest communication.

Installation

Box Contents

Before installing your phone, check the shipping carton to be sure you have the following:

- Base Unit
- Long Telephone Line Cord
- Handset with Rechargeable Battery
- Quick Installation Guide
- DC Adaptor with Cord
- Owner's Manual

Notes:

- Keep the shipping carton and packaging, in case you need to transport your phone.
- If there is visible damage, do not use this equipment. Contact your shipping agent or return the telephone to the place of purchase.

Preliminary Preparation

Telephone Line Installation

- Never install telephone jack during a lightning storm.
- Never install telephone jack in wet locations unless the jack is specifically designed for wet locations.
- Never touch uninsulated telephone wires or terminals unless the telephone line has been disconnected at the network interface.
- Use caution when installing or modifying telephone lines.

Modular Outlet

The GH3060 Cordless Telephone operates from a standard 110/120 volt outlet. The handset is powered by a rechargeable battery pack. Batteries are charged automatically when the handset is placed in the cradle of the base unit.

Battery Backup

One 9 volt battery (not included) is required to maintain clock and alarm time, and memory settings during a power failure. If there is a power failure and the battery is not installed, clock and alarm time, and memory settings will be lost.

- Make sure DC adaptor is unplugged from electrical outlet.
- On the bottom of the base, press on the tab (toward the battery compartment door), and then lift the door away from the unit.
- Install one 9 volt battery.
- Replace battery compartment door.
- Install a replacement battery once a year to ensure proper operation of the power failure protection feature. BATTERY LOW icon will turn on until a 9 Volt battery is installed. Your unit is fully functional. Battery is needed for power failure backup ONLY.

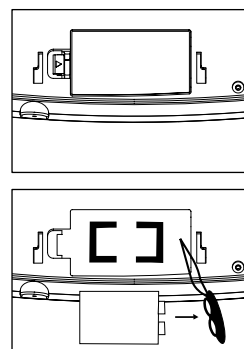

9

Installation (Cont.)

Table/Desk Installation

A. Plug one end of the long telephone line cord into the back of the unit and connect the other end to a modular wall jack. Press until locking lever clicks (Fig. 1).

B. Connect the AM look antenna into the back the unit (Fig.1). Place it on the desk or mount it on the wall (Fig.2).

C. Connect the DC Adaptor into the back of the unit. Plug the other end into a standard 110/120 volt outlet (Fig. 1).

D. Place the handset into the base. The handset will beep .

NOTE: BATTERY PACK MUST BE CHARGED FOR 10-14 HOURS BEFORE INITIAL OPERATION.

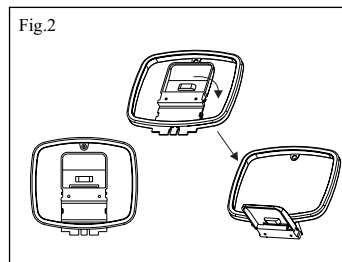
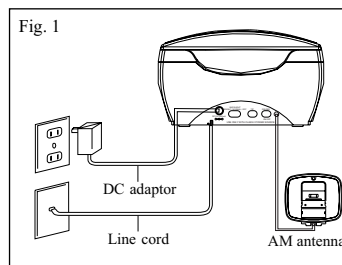

Handset Battery Charging

The battery pack in the handset must be fully charged for about 10-14 hours before using the telephone. The Radio may be used prior to the handset being fully charged. An extension telephone will be required until the handset is charged.

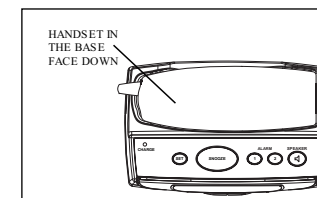

After connecting the unit to DC power, leave the handset in the base cradle for ten to fourteen hours before using it for the first time. The CHARGE LED on the base will be lit when the handset is in the cradle. Later, it will take less time for the battery to recharge.

Note:

- When the battery gets low, there will be a low-battery beep from the handset every 10 seconds . The handset will display "BATTERY LOW" on the bottom line.
- If the battery becomes low while you are using, you will be disconnected after about 1 minute. Terminate the call quickly and put the handset in the base to recharge the battery.
- The battery will hold its charge for several days out of the cradle, depending on use.

10

Installation (Cont.)

To Replace Batteries:

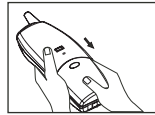

1. Remove battery cover.

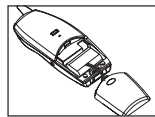

2. Remove old battery.

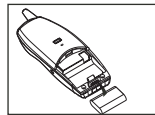

3. Install new battery.



4. Close battery cover. Charge 10-14 hours before first use.

Note : To maximize your battery's life, we recommend that you periodically fully drain the battery and then recharge it. To do this, unplug your phone line cord from your wall phone jack. Press the "TALK" button and allow the handset to remain on for 10 to 12 hours. Return the handset to the base and allow to fully charge for 12 hours. If this process is completed monthly, it will reduce the memory buildup that occurs from frequent partial charging.

Caller ID Setup

To Set Area Code

Note: In order that the Caller ID Redial feature works properly, you must set your local area code.
1. After installing the FULLY CHARGED handset battery, the handset display will light and will show "AREA CODE?"



2. Enter your 3-digit local area code using the handset keypad.
3. After entering the third digit, press the "MEM" button to confirm the displayed area code. The unit will return to Date/Time Screen.

To Set Language

1. Press the "CH" button for a second in Date/Time screen. The display will light and show "SET LANGUAGE"

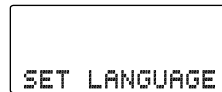

2. You can choose to see your LCD indications in English, French or Spanish. Press the "▲*" or "#▼" button to choose the desired language.



3. Press the "MEM" key to confirm the display language. The unit will begin to set the area code.
4. Set your local area code according to the above steps (To Set Area Code). Once finished, the unit will begin to set the remote access PIN code. Press the "MEM" button to skip the setting (PIN code not applicable in the GH3060 model). The unit will begin to set the handset display contrast level.

Caller ID Setup/Telephone Operation

To Set Handset Display Contrast



1. Press the "▲*" or "#▼" button to adjust the display contrast to the desired level (lighter or darker).
2. Press the "MEM" button to confirm the displayed contrast level. The time and date will be automatically updated when the first Caller ID call is received.

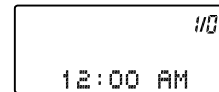

Note:

1. The Caller ID setup procedure will not begin until the handset has been fully charged for 10-14 hours.
2. To set up your GH3060 again, press the "CH" Button for a second in the Date/Time screen.
3. Your GH3060 will always stay in setup mode until you complete area code setup steps.
4. If you delay more than 20 seconds in between any of the above steps, the unit will revert to the beginning of the setup procedure.
5. To adjust the handset LCD display contrast while in the standby mode, press the "FLASH" button. Then press the "▲*" or "#▼" button to set the desired contrast. Press "MEM" button to confirm the contrast level.

Telephone Operation

Tone/Pulse Switch

The GH3060 will operate on tone or rotary systems.

1. If your house is wired for rotary service, move the Tone/Pulse (T/P) switch to the Pulse position (P).
2. If your house is wired for Touch Tone service, move the T/P switch to the Tone position (T).
3. If you are not certain which type of dialing service you have, set the switch to Tone (T). On the handset, press the TALK button and then any digit on the keypad. If the dial tone persists, switch to Pulse (P). To disconnect, press TALK again, or set the handset in the cradle.

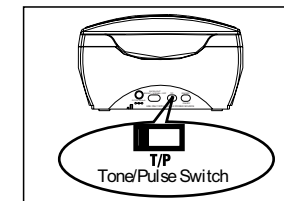

Digital Security System

Your GH3060 Cordless Telephone is equipped with a digital security coding system to protect your base unit from being accessed by other cordless telephones. The code allows your base and handset to recognize each other so that other cordless phones will not make calls on your line. If the DC adaptor is disconnected or a loss of power occurs while the handset is away from the base unit, the security code will be lost and the phone will be inoperable. If this occurs, reconnect the DC adaptor and return the handset to the base unit so that the security code is reset. The base will beep to confirm that the security code has been reset.

Telephone Operation (Cont.)

When the handset is not in the base, only a handset having the identical security code and operating on the same channel can access the base and use your phone line. When the handset is in the base, no other handset, even those having the identical security code and operating on the same channel, can access the base and use your line.

Digital security coding will also eliminate the "false" ringing associated with cordless telephones not equipped with this feature.

40 Channel Operation

Your cordless telephone has 40 operating channels. The phone will automatically search and select the clearest channel when you pick up the handset and press the "TALK" button. If you hear noise or other interference during your conversation, you can manually select a clearer channel by pressing and releasing the channel control on the handset to switch to another spare channel. Your call will not be interrupted.

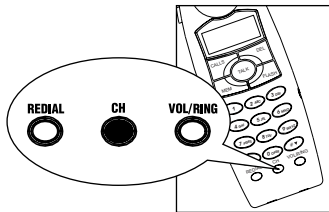

Note:

You must be within maximum range to change channel. If you come close to being out of range, you may lose the call. If this occurs, place the handset back into the base for ten seconds to reset the security code and then make the call again.

Making a Call

1. Lift the handset and press the "TALK" Button to be connected to the phone line.

The handset display will show TALK.
The base display will show LINE IN USE

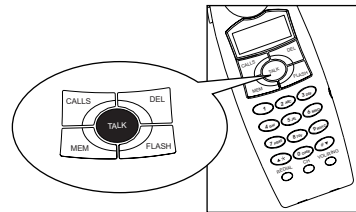

3. After hearing a dial tone, dial the desired number.
4. If you misdial, simply press the "TALK" button, wait for a couple of seconds, and press the "TALK" button again for a new dial tone.
5. After your conversation is completed, press the "TALK" button once to disconnect the line, or return the handset to the base.

Receiving a Call Through the Handset

When the Phone Rings

1. IF THE HANDSET IS OUT OF THE CRADLE, press any key on the handset.
2. IF THE HANDSET IS IN THE CRADLE, lift the handset. DO NOT press the "TALK" button, as you will be connected automatically.

Receiving Call Through the Base

Press the "SPEAKER" button on the base unit. You can speak through the microphone, without lifting the handset or press the "TALK" Button on the handset. H/S display will show "LINE IN USE". Press the "SPEAKER" button again to terminate a call.

Telephone Operation (Cont.)

Note:

If you experience difficulty with placing or receiving calls, lost security code may be the cause of the problem. When this occurs, the handset can no longer communicate with its base. The loss of the code can occur any of the following ways: the battery is drained and needs recharging; the DC adaptor is disconnected or a power loss has occurred; or anything that causes electrical interference, for example, multiple cordless telephones, baby monitors, televisions, VCR's etc. Reset the security code by placing the handset on the base for 10 seconds, removing it from the base, then replacing it on the base for an additional 10 seconds.

The unit will beep and you can now make the call. If that does not work, make sure DC adaptor is connected. If necessary, unplug the DC adaptor from the power source. Disconnect the battery for 5 seconds and then reconnect. Place the handset on the base and then replug the DC adaptor (see Troubleshooting). Let stand 2 minutes before use.

Headset Jack

You can connect a headset (not included) for hands-free conversations.

1. Insert the headset plug (must be 3/32 inch/2.5mm type) into the headset jack on the side of the handset.
2. Attach the belt clip to the back of the handset. Make sure the "arms" of the belt clip snap securely into the notches on the side of the handset. You can now attach the handset/belt clip to the desired location on your clothing.
3. Adjust the headset microphone to a comfortable position, placing it near your mouth.
4. Press the "TALK" button to make or receive a call.

5. To remove the belt clip from the back of the handset, use your fingernails to loosen one of the "arms" of the belt clip. The other "arm" of the belt clip will automatically release from the handset.

Note:

- When the belt clip is connected to the handset, the handset can not charge on the base.
- You can purchase a headset through our help line at 1-800-366-0937, our secure website at <http://www.swbfreedomphone.com>, or your local retailer.

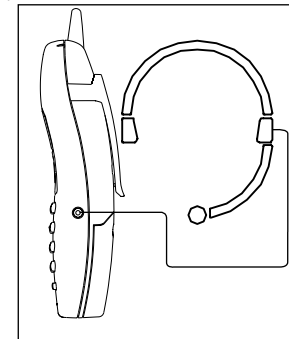

Out of Range

If you experience static while using the telephone, move closer to the base or change the channel by pressing the "CH" button on handset.

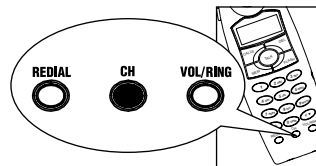

Telephone Operation (Cont.)

Memory Features

Your GH3060 is equipped with 10 memories for programming your most frequently dialed telephone numbers. You can store up to 16 digits in each of the memory locations 0 through 9, by following the steps outlined below. A record of the numbers to be speed-dialed may be kept on the speed dialing numbers index on page 33.

To Program Frequently Called Numbers

1. Press the "MEM" button on the handset, and the display will show "MEM x", with "x" representing the memory location that is currently displayed.

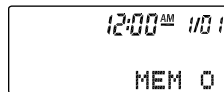

2. Press the "▲*" or "#▼" button to select the memory location where the telephone number is to be stored. You can choose from MEM 0-MEM 9.



Note : If a particular memory location is not empty, the display will show the current memory location and telephone number.

3. Enter the telephone number you wish to store, using the handset keypad.

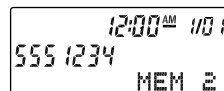

Note : If you accidentally press a 17th digit, an error tone will sound, and you must reprogram the number.

- Press the "REDIAL" button to enter a 4-second pause into the dialing sequence. A "P" will appear in the number sequence to show where the pause has been inserted.

4. To delete a particular digit that has already been entered, press the "DEL" button. The last entered digit will be deleted. To delete all of the digits, press the "FLASH" button.

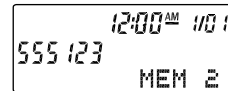

5. Press the "MEM" button to confirm the entered telephone number. The display will show "LOCATION ? x", with "x" representing the current memory location.

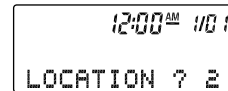

6. Press the "MEM" button again to confirm that you want to save the telephone number to that particular memory location number. If you want to choose another memory location number, press "*▲" or "#▼", or enter in the desired memory location, using the handset keypad. The display will show "MEM x STORED", with x representing the memory location number.

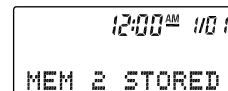

15

Telephone Operation (Cont.)

Scratchpad Memory

The GH3060 also functions as a scratchpad. If you want to save a displayed telephone number (up to 16 digits) into speed dial memory.

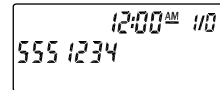

1. Press the "MEM" button on the handset. The display will show "LOCATION ? x", with "x" representing the first empty memory location.

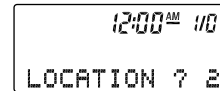
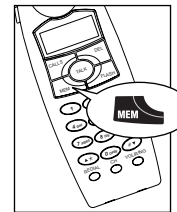

2. Press the "MEM" button again to confirm that you want to save the telephone number to that particular memory location number. If you want to choose another memory location number, press "*▲", "#▼" or enter in the desired memory location, using the handset keypad. The display will show "MEM x STORED", with "x" representing the memory location number.

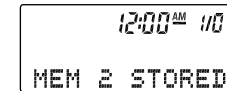

To Delete a Memory Location

1. Press the "MEM" button on the handset, and the display will show "MEM x" with "x" representing the memory location that is currently displayed.

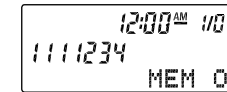

2. Press the "▲*" or "#▼" button to select the memory location where the telephone number is to be deleted.

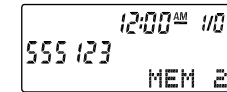

3. Press the "DEL" button to delete that memory location. The display will show "ERASE ?".

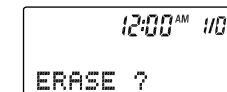

4. Press the "DEL" button again to confirm that you want to delete this memory location, and the memory location will be erased. If you do not want to delete that memory location, press any other key to cancel this procedure.

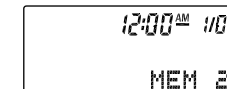

16

Telephone Operation (Cont.)

To Dial a Number Stored in Memory WHEN THE TALK BUTTON IS OFF:

1. Press the "MEM" button and the location number on the handset, and the display will show "MEM x" with "x" representing the memory location that is currently displayed.

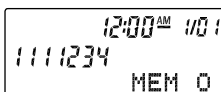

2. Press the "▲*" or "#▼" button to select the memory location where the telephone number is to be redialed. You can choose from MEM 0 -MEM 9.

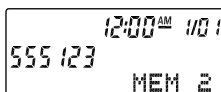

3. Press the "CALLS" button. The number will scroll across the screen from left to right as it is dialed.

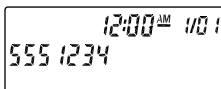
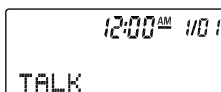

WHEN THE TALK BUTTON IS ON:

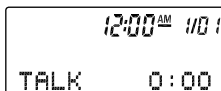

1. Press the "MEM" button on the handset.
2. Press the desired memory location (0 through 9).
3. The number you programmed will be automatically dialed.

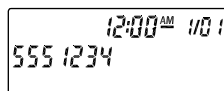

Redial

Your GH3060 remembers the last number (up to 32 digits) dialed. This is a convenient feature when trying to place a call to a phone number that is not being answered or is continuously busy.

Do Not Press The Talk Button

1. Press the "REDIAL" button, and the display will show the last telephone number you previously dialed.

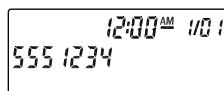

2. If you want to edit this displayed telephone number, you can choose the following options:

- a. To delete a particular digit that has already been entered, press the "DEL" button. The last entered digit will be deleted.
- b. To insert a digit at the end of the telephone number, enter the desired digit using the keypad.
- c. To delete all of the digits, press the "FLASH" button.

17

Telephone Operation (Cont.)

3. Press the "CALLS" button. The number will scroll across the screen from left to right as it is dialed.

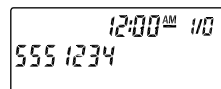
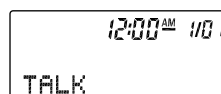

Call Timer

1. The LCD will display the call duration timer 10 seconds after a call has begun.

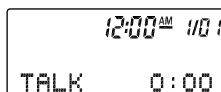

2. After the call has ended, the call timer will remain on the display for 5 seconds.

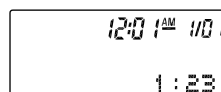

Flash

You can use your cordless telephone with special services such as Call Waiting or Three Way Calling (Special subscription from your local telephone company is required). During a telephone conversation, you may hear a tone or click, which indicates that you are receiving another call. To speak to the second caller and put the first call on Hold, press the "FLASH" button. Press "FLASH" again to return to the original call. You may also press the "FLASH" key to obtain a new dial tone.

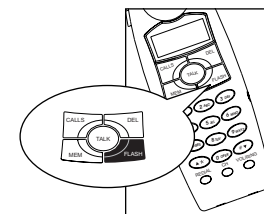

Temporary Tone Feature

In pulse dialing mode, you can access bank facilities, telephone answering machines, etc., by pressing the TONE (▲*) key. This will get you into the tone mode and will allow you to input the required tone codes. It will reset automatically to pulse dialing after you end your call.

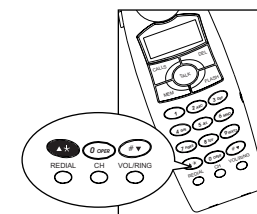

Receiver Volume Control

Your GH3060 allows you to adjust the handset volume to a more comfortable listening level. Press "VOL/RING" button to increase or decrease volume, while handset is in the Talk On mode. The default volume is set to level 1. The volume status will show on the LCD.

18

Telephone Operation (Cont.)



When The "VOL/RING" button is pressed, the receiver volume will increase to maximum (level 3) and then back down and decrease to minimum (level 1) in a repeated cycle.

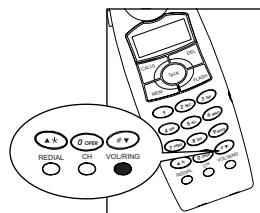

Ringer Control

If you do not want the handset and base to ring, set the RINGER switch on the back of the base unit to OFF and/or press the "VOL/RING" button on handset for 2 seconds to toggle the ringer to off. The LCD will show.

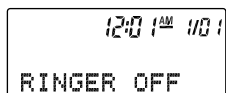

The handset and/or base unit will no longer ring when a call comes in.

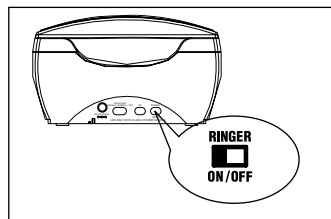

	-RINGER SWITCH-		-RING SOUND-	
	BASE	HANDSET	BASE	HANDSET
HANDSET OFF	ON	OFF	ON	OFF
CRADLE OFF	ON	ON	ON	ON
CRADLE ON	OFF	OFF	OFF	OFF
CRADLE OFF	OFF	ON	OFF	ON
HANDSET ON	ON	OFF	ON	OFF
CRADLE ON	ON	ON	ON	OFF
CRADLE OFF	OFF	OFF	OFF	OFF
CRADLE ON	OFF	ON	ON	OFF

Speakerphone Volume Control

Press the VOLUME control "▲" or "▼" button on the base to adjust the speakerphone volume level.

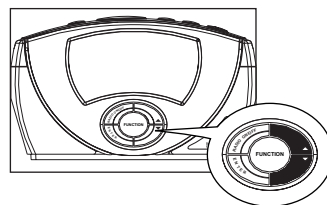

Page/Handset Locator

You can send a page signal from the base to the handset.

Press the "PAGE" button on the base once, and the handset will beep 3 times. Press and hold the "PAGE" button for 3 seconds, and the handset will beep for about 60 seconds. Press any button on the handset to stop the handset from beeping.

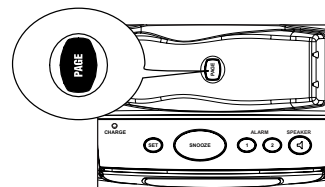

Telephone Operation (Cont.)

LCD/LED INDICATIONS (HANDSET)

LED	STATUS	INDICATIONS
NEW CALL LED	FLASHING	-New Caller ID information is in memory.
	OFF	-All new Caller ID information has already been reviewed.

LCD DISPLAY	INDICATIONS
BATTERY LOW	Handset battery power is low, and the handset battery should be charged.
PAGING	Base unit is paging handset.
TALK	Handset is connected to line.
LINE IN USE	Speakerphone active.

Power failure protection/Battery Backup

If DC power failure occurs, or the power plug comes out of the wall, your unit will shut down until the power is restored.

When the power is restored, clock and alarm time and memory settings recorded before the power failure will be saved IF YOU HAVE INSTALLED A 9 VOLT BATTERY.

If your unit is not operating properly when the power is restored, proceed with a unit reset.

To Reset Unit

1. Unplug the DC adaptor from the power outlet.
2. Remove the 9 volt battery. Replace with a fresh 9 volt battery (see page 9).
3. Plug DC adaptor back into power outlet.
4. Set clock and alarm time, radio memory station (see page 21).
5. Remove the handset battery, wait 5 seconds, and then reinstall the handset battery. You need to follow the Caller ID setup procedure.

IMPORTANT

During a power outage, your unit will NOT work, even if a 9 volt battery is installed.

Alarm Operation

Once the unit is powered on, the clock display will show 12:00AM. You can utilize the clock and alarm time setting as follows:

Before setting, you can select a comfortable contrast and back light. When the unit is in the standby mode, press the ENTER button. The LCD of the base will show CONTRAST, you can select the desired level by pressing ▲ or ▼ button. Then press the ENTER button to confirm. The LCD back light can be adjusted by BACKLIGHT BRIGHT / NORMAL / OFF switch.

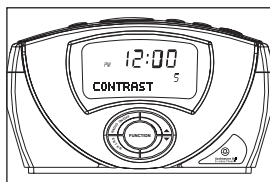

Setting The Clock

1. Press the FUNCTION button once; the base display will show "SET CLOCK".

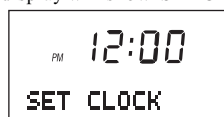

2. Press ENTER button; the hour digits will flash. Press ▲ or ▼ button to select the correct hour time. Press ENTER button again to confirm the hour digits, and the left minute digit will flash.
3. Press ▲ or ▼ button to select the correct value. Press ENTER button; the right minute digit will flash. Press ▲ or ▼ button to select the correct value. Press ENTER button again to complete the clock setting.

Setting The Alarm Time

1. Press the FUNCTION button once, then press the ▲ or ▼ button until the display shows "ALARM TIME". Press ENTER button; "ALARM1" will display on the LCD.

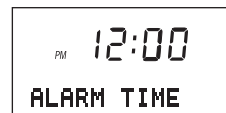

2. You can select "ALARM1" or "ALARM2" by pressing ▲ or ▼ button.
3. Press the ENTER button to confirm your selection. The LCD shows the last alarm setting. The hour digits will flash.

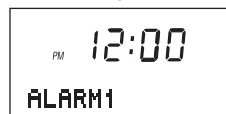

4. Press ▲ or ▼ button to select the correct hour. Then press ENTER button to confirm; the left minute digit will flash.
5. Press the ▲ or ▼ button to select the correct value. Press ENTER button to confirm; the right minute digit will flash. Press ▲ or ▼ button to select the correct value.
6. Press ENTER button again to complete the alarm time setting.

Note:

If your setting is not completed in 20 sec, it will timeout and resume the real clock mode. Press FUNCTION button can go back to the upper layer of the menu. The clock of the base is updated automatically after receiving incoming Caller ID.

Alarm Operation/Radio Operation

Wake Up To Buzzer/Radio

1. Press the FUNCTION button once, then choose "ALARM MODE" by pressing ▲ or ▼ button.
2. Press the ENTER button; once "ALARM1" will be displayed on the LCD. Press the ▲ or ▼ button to select one of the following: "ALARM1", "ALARM2", "ALARM1+2", "ALARM OFF".

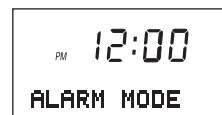

3. Press the ENTER button to confirm. If you select "ALARM1/ALARM2", press the ▲ or ▼ button to select "WAKE BUZZER" or "WAKE RADIO".
4. Press the ENTER button to confirm the selection. If "WAKE BUZZER" is selected, the buzzer icon will be lit and the alarm buzzer will sound at the set alarm time. If "WAKE RADIO" is selected, the radio icon will be lit and the radio will start playing at the set alarm time.
5. If you select "WAKE RADIO", "High VOL ON" will display on the LCD. Press the ▲ or ▼ button to select "High VOL ON" or "High VOL OFF".



6. Press the ENTER button to complete the selection.
7. When the ALARM x comes on at the set time, the BELL x icon will flash. Each alarm period is 15minutes. Pressing ALARM x button can stop the alarm and then BELL x icon will not flash. (where x is 1 or 2).

Note:

If you select the "High VOL ON", the volume of waking to radio will be louder than normal. Press the "RADIO ON/OFF" button can also stop the alarm from "wake to radio".
• If you are not in the mode of 'Alarm off' and 'Alarm 1+2', the latest alarm setting is effective.
• If your setting is not completed in 20 sec, it will timeout and resume the real clock mode.
• Press FUNCTION button to go back to the upper level of the menu.

Snooze Function

When alarm comes on, press the SNOOZE button, the alarm will stop and come on after 9 minutes. Total snooze time is 1 hour.

NOTE:

If both alarms (alarm1 and alarm2) are set within 9 minutes of each other, the last alarm will override the previous one.

IMPORTANT!!

1. Radio does not operate during DC power failure.
2. Radio is muted when the phone is in ringing and conversation status.
3. The icon 'ST' will be lit, if Stereo station is selected.
4. If your setting is not completed in 20 sec, it will timeout and resume the real clock mode.

Radio Operation To Play The Radio

1. Press the RADIO ON/OFF button to turn on the radio.

Radio Operation

2. Press the FUNCTION button, the display will show "FM".

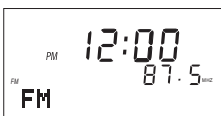

3. You can select "FM" or "AM" band by pressing the ▲ or ▼ button, then press the ENTER button to confirm.



4. Tune to the desired station by pressing the ▲ or ▼ button. Each time you press the button, the frequency will change by one step.

5. You can also use automatic tuning. Keep the ▲ or ▼ button pressed until the frequency starts to change rapidly, then release the button and it will stop at the next strong station.

6. When listening to the radio, you can adjust the volume ▲ or ▼ to select a suitable listening level.

7. To turn off the radio, press the RADIO ON/OFF button.

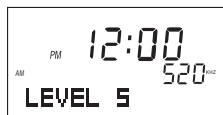

Presetting Station

1. Press the RADIO ON/OFF button to turn on the radio.

2. Press the FUNCTION button. The display will show "FM".

23

3. You can select "FM" or "AM" band by pressing the ▲ or ▼ button, then press the ENTER button to confirm.

4. Press the ▲ or ▼ button to select a station which you want to save.

5. Press and hold the SET button about one second. "PROG" icon will flash on the LCD display.



6. While the PROG is blinking, press the ▲ or ▼ button to choose a desired memory location. You can choose from CH1 to CH10.

7. Press the ENTER button to confirm.

The station now broadcasting will be stored in the preset memory.

8. By repeating the above steps 3 to 7, you can store other stations in the memory.

NOTE:

Up to 10AM and 10FM stations can be stored into preset memories.

Radio Operation

LISTEN TO PRESET MEMORY STATIONS

1. Press the RADIO ON/OFF button to turn on the radio.

2. Press the FUNCTION button to select "AM" "FM", then press the ENTER button to confirm.

3. Press the SET button once, the latest location will be kept. You can select the desired memory by pressing ▲ or ▼ button.

4. To turn off the radio, simply press the RADIO ON/OFF button.

SLEEP FUNCTION

If you want the radio turned off after a desired playing time. You can follow the below steps.

1. During Radio play, or in the standby mode, press the SET button. The LCD will show "SLEEP 15".

2. Press ▲ or ▼ button repeatedly to select the desired playing time. The display sequence is 15 minutes → 30 minutes → 60 minutes → 90 minutes → SLEEP OFF.

3. Press ENTER button to confirm, "sleep" icon will turn on.

NOTE:

During sleep mode, the wake up to buzzer/radio function still works.

24

Caller ID Operation

Receiving a Call

1. After the first ring, the caller's name and telephone number will be displayed on the handset screen.

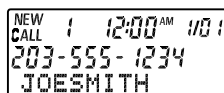

NEW
CALL 1 12:00 AM 101
203-555-1234
JOESMITH

The Caller ID information (up to 64 callers) will be stored in the handset display in the order received. If the received call information is the same as any of the new calls, the unit will display the "RPT" icon to indicate a repeat call. If the unit receives more than 64 calls, the oldest Caller ID information will be erased. The New Call LED will flash until you review all your new calls.

Note:

If you answer your incoming call before the second ring, the unit will not display the call information.

Receiving Call Waiting Caller ID

when you are on an existing phone call, your GH3060 will display incoming Call Waiting Caller ID information.

1. You will hear a beep and the telephone will be muted momentarily while the display shows the second caller Caller ID information.

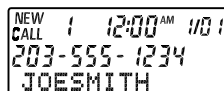

NEW
CALL 1 12:00 AM 101
203-555-1234
JOESMITH

2. When you access the Call Waiting, the Caller ID information will disappear and the Time/Day screen will be display.

IMPORTANT:

You must subscribe to Call Waiting and Call Waiting Caller ID service from your local telephone company in order to receive Call Waiting Caller ID information

Reviewing Calls

Reviewing New Call Records

1. When the display shows the current date/time, press the "▲*" or "#▼" button on the handset to display the information for the last new call received.

Note:

You can review up to 64 New Caller ID calls from the handset.

2. Continue pressing "▲*" or "#▼" button to review all new call records in the order the calls were received.

When a name received exceeds 12 characters, the first 12 characters will be shown with "▲" showing on the right hand side. Press the "#▼" button to view the remaining characters.

3. After the final call has been displayed, press the "▲*" or "#▼" button again. The New Call LED will stop blinking and the LCD will show "END NEW CALL"

Note:

If you do not review all new calls, the Time/Date screen will display after 20 seconds and the new call counter will show the total number of new calls received (including those you just reviewed).

Base will only show incoming call and does not have Review function.

Caller ID Operation (Cont.)

To Store a Caller ID Record to Speed Dial Memory

Note:

You can store a Caller ID record from the handset to Speed Dial Memory.

1. When the handset display shows the current time/day, press the "▲*" or "#▼" button to select the Caller ID record you want to store to Speed Dial Memory

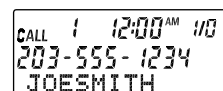

CALL 1 12:00 AM 101
203-555-1234
JOESMITH

2. Press the "MEM" button on the handset

3. The display will show "LOCATION? x", with "x" representing the first empty memory location.

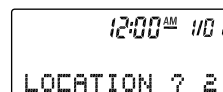

12:00 AM 101
LOCATION ? 2

4. Press the "MEM" button again to confirm that you want to save the telephone number to that particular memory location number. If you want to choose another memory location number, press "▲*" or "#▼" or enter in the desired memory location, using the handset keypad. The display will show "MEM x STORED".

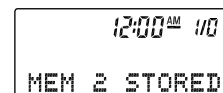

12:00 AM 101
MEM 2 STORED

Reviewing All Call Records

1. After you have reviewed all of the new calls (see page 25), press the "▲*" or "#▼" button on the handset. The displays will show the calls stored in memory.

You can review up to 64 Caller ID calls from the handset.

2. Once in the Caller ID review mode, press the "▲*" or "#▼" button. The LCD display will show the calls stored in memory.

3. Continue to press "▲*" button to display all records in the order they were received from the oldest to the newest, or "#▼" button from the newest to the oldest.

4. After the last call record has been reviewed, the LCD will show "--END--"

Caller ID Redial

THE LOCAL AREA CODE MUST BE PROGRAMMED IN ORDER TO FULLY UTILIZE THE REDIAL FEATURE (SEE PAGE 11). The GH3060 allows you to redial a phone number stored in the Caller ID memory.

1. When the display shows the current time/day, press the "▲*" or "#▼" button on the handset to select the Caller ID record that you want to dial.

Note:

- You can review and redial up to 64 Caller ID calls from the handset.

2. Press and release the "CALLS" button on the handset. The number will scroll across the screen from left to right as it is dialed.

Note:

- If you review the Caller ID call from the handset, then you will need to redial the call from the handset (by pressing the "CALLS" button).

Caller ID Operation (Cont.)

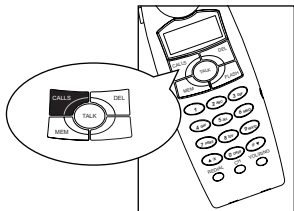

With current Telecom redialing situations, there are 4 redial options: (1) 7 digits without a 1 prefix; (2) 7 digits with a 1 prefix; (3) 10 digits without a 1 prefix; and (4) 10 digits with a 1 prefix.

1. 7 digits without a 1 : Assuming that you have programmed your correct area code, redial your local call by pressing the handset "CALLS" button ONCE.

2. 7 digits with a 1 : If it is necessary to Insert a 1 prefix before your local call, assuming that you have programmed your correct area code, simply press the handset "CALLS" button TWICE WITHIN 2 SECONDS.

3. 10 digits without a 1: In some areas of the country, the area code must be included, even when dialing a local call. In this situation, set your GH3060 area code to another 3 digit "fictitious" area code. (We recommend using an area code not currently being used in the U.S., i.e. 100, etc.). Once your area code is programmed as above, your GH3060 will show all "10 digits" for every incoming call. To redial a local 10 digit call, press the handset "CALLS" button TWICE WITHIN 2 SECONDS in succession. The "1" prefix is then omitted and the local 10 digit call is redialed.

27

4. 10 digits with a 1: Since the 1 prefix will be added automatically when dialing a 10 digit number, simply press the handset "CALLS" button ONCE to make your call. If your area code requires that you add 1 and your area code, even if the call is within the same area code, then you must reprogram your GH3060 to another 3-digit "fictitious" area code. The "1" prefix will be added before the 10 digit number and your long distance call will be dialed.

Note:

Use caution when pressing the handset "CALLS" button. Press and release rapidly; if the handset "CALLS" button is held down too long, the "VIP CALL" feature will be activated.

Caller ID Erase

To Erase a Single Call

1. When the handset display shows the current time/day, press the "▲*" or "#▼" button to select the Caller ID record you want to erase.

2. Press "DEL" button to erase the call displayed, the display will show "ERASE?" on the bottom line.

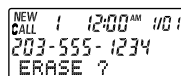

4. Press "DEL" button again, the Caller ID record will be erased and the display will show the next call message.

Note: If the current displayed message is the last message to come in, then the display will show "--END--".

Caller ID Operation (Cont.)

To Erase All Calls

1. You must press the "▲*" or "#▼" button to review all of the new Caller ID records received before you can erase all calls.

2. While the display is in standby mode, press and hold the "DEL" button for 2 seconds. The display will show "ERASE ALL?" on the bottom line.

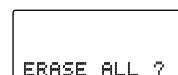

3. Press the "ERASE" button again, all VIEWED messages will be erased.

Note: 1. In this condition, all the Caller ID records are erased. If there are records that have not been reviewed, the "Erase All Calls" function cannot be performed.

2. VIP calls will not be erased when you erase all calls.

VIP Calls

The GH3060 allows you to create VIP call records. When a VIP call is received, 4 beeps will be heard (after the first ring), to alert you that this is a VIP call.

To Create a VIP Call:

1. Press the handset "▲*" or "#▼" button to select the caller ID which you want to assign a VIP indication.

2. Press and hold the "CALLS" button for 2 seconds until the "VIP" icon is displayed.

Note: Four beeps will also be heard when the incoming VIP call is a Call Waiting Caller ID call.

To Remove a VIP Call:

1. Press the handset "▲*" or "#▼" button to display the call you have marked "VIP".

2. Press and hold "CALLS" button for 2 seconds until the "VIP" icon has disappeared.

28

Answers to Commonly Asked Questions

Q. I can't get a dial tone. What do I do?

A. Your phone may have lost its digital security code and needs to be reset. Refer to the "To Reset" unit procedure on page 20

Q. How often do I need to replace the 9 volt battery?

A. You should replace the 9 volt battery once a year or after a power outage.

Q. Can my unit be left on for a long period of time?

A. Yes. Your unit is designed to be on 24 hours a day.

Q. My DC Adaptor feels warm to the touch. Is this normal?

A. Yes. It is characteristic of your DC Adaptor to feel slightly warm. There is no need to be alarmed.

Q. Will my unit operate in a very cold or hot environment?

A. Your unit is designed to perform most efficiently at room temperature. However, it can be used in environments ranging from 50 F to 120 F.

Q. Why are some of the digits on the display missing?

A. Information in the Transmission can not be decoded by your unit, so it cannot be displayed. If the error affects only a single digit, the display will sometimes show a "-" in the area of the digit effected. Your telephone is able to recover all available information, making it possible for you to determine who the call is from.

Q. How many calls can be stored in Caller ID memory?

A. The telephone number, name (if available), and time/day of up to 64 calls will be stored in memory on the handset display.

Troubleshooting Guide

If you have followed the instructions in this manual, and have difficulty operating your Southwestern Bell Freedom Phone® Cordless Telephone, locate the PROBLEM in the left column below. Check the corresponding POSSIBLE CAUSE and CORRECTIVE ACTION columns to locate and remedy the problem.

PROBLEM	POSSIBLE CAUSE	CORRECTIVE ACTION
The unit will not operate.	Improper installation.	Recheck all plug connections. Also, check the DC adaptor for proper connection to wall outlet and phone base.
	The digital security code has been lost due to a power loss while the handset was away from the base.	Reset the digital security code by returning the handset to the base. A new code is then set.
	The battery is not charged.	Charge the battery for about 10-14 hours before initial use or when the battery low beep sounds every 10 seconds from the handset.
No dial tone.	See the above mentioned possible causes.	See the above mentioned corrective actions.
	The handset is being used too far away from base.	Move the handset closer to the base.
Difficulty placing or receiving calls.	You may have lost the security code. The handset can no longer communicate with its base. The loss of the code can occur if the battery is drained and needs recharging, the DC adaptor is disconnected, a power loss has occurred, or there is electrical interference from other cordless phones, baby monitors, microwaves, etc. Even a momentary power interruption could erase your cordless phone's security code.	1. Return the handset to the base unit for 5-10 seconds to reset code. If that doesn't work: 2. Check to make sure the DC adaptor is connected. 3. Unplug DC adaptor from power source; disconnect handset battery for 5 seconds, then reconnect. Place handset back on base, then replug in the DC adaptor

Troubleshooting Guide (Cont.)

PROBLEM	POSSIBLE CAUSE	CORRECTIVE ACTION
Can't make outgoing calls.	Tone/Pulse switch is not set correctly.	Set the Tone/Pulse switch to proper position for your type of service.
	The digital security code has been lost.	Reset the security code by returning the handset to the base.
Battery pack is not recharging.	The base and handset battery contacts are not in contact with each other.	Make certain the battery contacts in the handset and base make contact when handset rests in the base.
	Battery pack needs to be replaced.	Replace the battery pack at least Once a year
Noise or interference is being heard during your conversation.	Current channel is not the clearest choice.	Press the channel button to switch from one channel to another. This will allow you to choose the clearest of 40 channels.
During a conversation, a loud static noise is heard.	The handset is being used too far away from the base.	Move the handset closer to the base station.
The incoming call's signal is intermittent or fades.	The battery is not charged.	Recharge the battery.
	The handset is being used too far away from the base.	Move the handset closer to the base.

Troubleshooting Guide (Cont.)

PROBLEM	POSSIBLE CAUSE	CORRECTIVE ACTION
Your telephone rings but the GH3060 doesn't show any Caller ID records.	The telephone line is not connected properly to the unit.	Connect the telephone line into the back of the unit. Check with your local telephone company to be sure Caller ID service is being provided on your telephone line. Also, if you pick up the phone before the first complete ring, the caller information will not be completely received.
You cannot redial a call record.	Your local area code is not programmed.	If the display does not indicate 7 digits for local incoming calls, reprogram the local area code.
	The number displayed is incorrect.	Verify the number displayed during redial. Data received was possibly corrupted during the transmission through the telephone lines. Dial the telephone number manually on your telephone.
You can't receive call waiting messages.	This service is not available.	You must subscribe to Caller ID, Call Waiting, as well as Call Waiting Caller ID service from your local phone company. The phone must be off-hook to hear the call waiting Caller ID alert signal.
The display screen is dim or blank.	The display contrast is set at too low level.	Press the handset "FLASH" and then the "▲*" or "#▼" button to adjust the handset contrast level.

Product Care

A. Avoid putting cordless phones near heating appliances and devices that generate electrical noise (motors, fluorescent lamps, etc.).

B. Avoid rough treatment of the phone by placing the handset gently into the base when hanging up. Avoid dropping the handset.

C. Clean your cordless telephone only with a soft cloth slightly dampened with water or mild hand soap. Do not use any type of solvent or abrasive cleaner. Before cleaning, always unplug the phone from the wall outlet.

D. Your cordless phone is not designed to be water resistant. Do not use the handset in the rain, in the pool or in the shower. Do not install your base unit outdoors, or near a sink, bathtub or shower. Do not expose to direct sunlight.

E. Retain the original packaging in case you need to ship the phone at a later date.

Additional Information

A. Connecting this telephone to a coin operated telephone or party line is prohibited by law.

B. If it is determined that your telephone is malfunctioning, the FCC requires that it be disconnected from the modular outlet until the problem has been corrected.

For immediate answers to all your questions regarding the operation of your Southwestern Bell Freedom Phone,[®] call the Consumer Hotline, toll free at (800) 366-0937.

Speed Dialing Numbers Index

LOCATION	NUMBER	LOCATION	NUMBER
0		5	
1		6	
2		7	
3		8	
4		9	

Service

According to FCC regulations, this equipment, which has been certified and registered by the FCC, may only be repaired by authorized persons. If repairs or adjustments are made by an unauthorized person, the FCC certification may be voided. Should you encounter any problems, please call the Southwestern Bell Freedom Phone[®] toll-free Customer Help Line for assistance: 1-800-366-0937, Monday - Friday 8:30 am - 9:00 pm, and Saturday 8:30 am - 12:30 pm. You can also visit our website at <http://www.swbfreedomphone.com>.

FOR IN WARRANTY SERVICE:

Package your complete unit (including all adaptors, line cords, and other accessories) and ship the unit postage prepaid* and insured (for your protection) to:

SOUTHWESTERN BELL FREEDOM PHONE[®]
DEPT.: Warranty Repair
7475 N. Glen Harbor Blvd., Glendale, AZ 85307

Be sure to include your return address, proof of purchase, a daytime phone number, \$9.50 for postage and handling*, and a brief explanation of your difficulties.

*NOTE: California residents need only provide proof of purchase and should call 1-800-366-0937 for shipping instructions.

FOR OUT OF WARRANTY SERVICE:

You may call our toll-free Help Line for the price of a replacement before returning your unit. Please follow all instructions for In-Warranty service (above) to return your unit, and mark the package: DEPT.: Out of Warranty.

If you have called and know the cost of your replacement, please include this information with your unit for prompt service.

QUESTIONS?

STOP...DON'T TAKE ME BACK TO THE STORE.
LOOK...FOR THE TOLL-FREE "HELP" TELEPHONE NUMBER.
LISTEN...AS THE EXPERTS TALK YOU THROUGH THE PROBLEM.

For immediate answers to your questions regarding operation, missing parts or installation, call the

SOUTHWESTERN BELL FREEDOM PHONE[®] HELP LINE AT:
1-800-366-0937
<http://www.swbfreedomphone.com>

FCC Wants You to Know

This equipment complies with Part 68 of the FCC rules and the requirements adopted by the ACTA. On the bottom of the bottom of this equipment is a label that contains, among other information, a product in the format US:AAAEQ##TXXXX. If requested, this number must be provided to the telephone company, the FCC Registration Number and Ringer Equivalence Number (REN) for this equipment. You must, upon request, provide this information to your telephone company. The REN is useful to determine the number of devices that may be connect to a telephone line. Excessive RENs on a telephone line may result in the devices not ringing in response to an incoming call. In most but not all areas, the sum of RENs should not exceed five (5.0). To be certain of the number of devices the may be connect to a line, as determined by the RENs, contact the local telephone company. [For product approved After July 23, 2001, the REN for this product is part of the product identifier that has the format US:AAAEQ##TXXXX. The digits represented by ## are the REN without a decimal point (e.g., 03 is a REN of 0.3). For earlier products, the REN is separately shown on the label.] To determine the maximum REN for your calling area.

If your telephone equipment causes harm to the telephone network, the telephone company may discontinue your service temporarily. If possible, they will notify you in advance. But if advance notice isn't practical, you will be notified as soon as possible. You will be informed of your right to File a complaint with the FCC.

Your telephone company may make changes in its facilities, equipment, operation or procedures that could affect the proper functioning of your equipment. If they do, you will be notified in advance to give you an opportunity to maintain uninterrupted telephone service. If you experience trouble with this telephone equipment disconnect from the network until the problem has been corrected or until you are sure that the equipment is not malfunctioning.

This equipment may not be used on coin service provided by the telephone company. Connection to party lines is subject to state tariffs.

Warning: Changes or modifications to this unit not expressly approved by the party responsible for compliance could void the user's authority to operate the equipment.

NOTE: This equipment has been tested and found to comply with the limits for a Class B digital device, pursuant to Part 15 of the FCC Rules. These limits are designed to provide reasonable protection against harmful interference in a residential installation. This equipment generates, uses and can radiate radio frequently energy and, if not installed and used in accordance with the instructions, may cause harmful interference to radio communications. However, there is no guarantee that interference will not occur in a particular installation. If this equipment does cause harmful interference to radio or television reception, which can be determined by turning the equipment off and on, the user is encouraged to try to correct the interference by one or more of the following measures:

- Increase the separation between the equipment and receiver.

- Connect the equipment into and outlet on a circuit different from that to which the receiver is connected.

- Consult the dealer or an experienced radio TV technician for help.

FCC Wants You to Know

An applicable certification jacks Universal Service Order Codes (USOC) for the equipment is provided (i.e., RJ11C) in the packaging with each piece of approved terminal equipment.

A plug and jack used to connect this equipment to the premises wiring and telephone network must comply with the applicable FCC Part 68 rules and requirements adopted by the ACTA. A compliant telephone cord and modular plug is provided with this product. It is designed to be connected to a compatible modular jack that is also compliant. See installation instructions for details.

NOTICE: If your home has specially wired alarm equipment connected to the telephone line, ensure the installation of this [equipment ID] does not disable your alarm equipment. If you have questions about what will disable alarm equipment, consult your telephone company or a qualified Installer.

NOTICE: According to telephone company reports, AC electrical surges, typically resulting from lightning strikes, are very destructive to telephone equipment connected to AC power sources. To minimize damage from these types of surges, a surge arrester is recommended.

Limited Warranty

This **Southwestern Bell Freedom Phone**® is warranted to the original purchaser to be free from defects in materials and workmanship under normal installation, use, and service for a period of one(1) year from the date of purchase as shown on the purchaser's receipt.

The obligation of **Southwestern Bell Freedom Phone**® Retail Sales under this warranty shall be limited to repair or replacement (at our option) during the warranty period of any part which proves defective in material or workmanship under normal installation, use, and service, provided the product is returned to **Southwestern Bell Freedom Phone**® Retail Sales (address below) TRANSPORTATION CHARGES PREPAID (California residents call 1-800-366-0937 for shipping instructions). Products returned to us or to an Authorized Service Center must be accompanied by a copy of the purchase receipt.

In the absence of such purchase receipt, the warranty period shall be one (1) year from the date of manufacture. To obtain service under this warranty, return the defective product to the service center nearest you together with your sales slip and \$9.50 for postage and handling (California residents need only provide proof of purchase). You may also have other warranty rights which vary from state to state.

This warranty shall be invalid if the product is damaged as a result of defacement, misuse, abuse, neglect, accident, destruction, or alteration of the serial number, improper electrical voltages or currents, repair alteration or maintenance by any person or party other than our own service facility or an authorized Service Center, or any use violative of instructions furnished by us.

This warranty is also rendered invalid if this product is removed from the country in which it was purchased, if it is used in a country in which it is not registered for use, and/or if it is used in a country for which it was not designed. Due to variations in telephone systems and communications laws, this product may be illegal for use in some countries. **Southwestern Bell Freedom Phone**® Retail Sales assumes no responsibility for damages or penalties incurred resulting from the use of this product in a manner or location other than that from which it is intended.

This one-year limited warranty is in lieu of all other expressed warranties, obligations, or liabilities. ANY IMPLIED WARRANTIES, OBLIGATIONS, OR LIABILITIES, INCLUDING BUT NOT LIMITED TO THE IMPLIED WARRANTIES OF MERCHANTABILITY AND FITNESS FOR A PARTICULAR PURPOSE, SHALL BE LIMITED IN DURATION TO THE ONE-YEAR DURATION OF THIS WRITTEN LIMITED WARRANTY. SOME STATES DO NOT ALLOW LIMITATIONS ON HOW LONG AN IMPLIED WARRANTY LASTS, SO THE ABOVE LIMITATIONS MAY NOT APPLY TO YOU.

IN NO EVENT SHALL WE BE LIABLE FOR ANY SPECIAL, INCIDENTAL OR CONSEQUENTIAL DAMAGES FOR BREACH OF THIS OR ANY OTHER WARRANTY, EXPRESSED OR IMPLIED, WHATSOEVER.

Some states do not allow the exclusion or limitation of special, incidental, or consequential damages, so the above limitation or exclusion may not apply to you. This warranty gives you specific legal rights, and you may also have other rights which vary from state to state.

SOUTHWESTERN BELL FREEDOM PHONE®
7475 NORTH GLEN HARBOR BLVD., GLENDALE, AZ 85307

Free Manuals Download Website

<http://myh66.com>

<http://usermanuals.us>

<http://www.somanuals.com>

<http://www.4manuals.cc>

<http://www.manual-lib.com>

<http://www.404manual.com>

<http://www.luxmanual.com>

<http://aubethermostatmanual.com>

Golf course search by state

<http://golfingnear.com>

Email search by domain

<http://emailbydomain.com>

Auto manuals search

<http://auto.somanuals.com>

TV manuals search

<http://tv.somanuals.com>