

# TOSHIBA



## DVD RECORDER D-R3

### OWNER'S MANUAL



Read this booklet first.



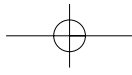

# TOSHIBA

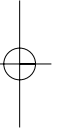
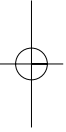

**UK**

AK68-00566A

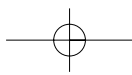

## Warning

TO REDUCE THE RISK OF ELECTRIC SHOCK, DO NOT REMOVE THE COVER(OR BACK). NO USER-SERVICEABLE PARTS ARE INSIDE. REFER SERVICING TO QUALIFIED SERVICE PERSONNEL.



This symbol indicates "dangerous voltage" inside the product that presents a risk of electric shock or personal injury.



This symbol indicates important instructions accompanying the product.

Do not install this equipment in a confined space such as a bookcase or similar unit.

**WARNING :** To prevent damage which may result in fire or electric shock hazard, do not expose this appliance to rain or moisture.

**CAUTION :** DVD Recorder-VCRS USE AN INVISIBLE LASER BEAM WHICH CAN CAUSE HAZARDOUS RADIATION EXPOSURE IF DIRECTED.  
BE SURE TO OPERATE RECORDER CORRECTLY AS INSTRUCTED.

### CAUTION

THIS PRODUCT UTILIZES A LASER. USE OF CONTROLS OR ADJUSTMENTS OR PERFORMANCE OF PROCEDURES OTHER THAN THOSE SPECIFIED HEREIN MAY RESULT IN HAZARDOUS RADIATION EXPOSURE. DO NOT OPEN COVERS AND DO NOT REPAIR YOUR-SELF. REFER SERVICING TO QUALIFIED PERSONNEL.

### CAUTIONS

Caution: To prevent electric shock, match wide blade of plug to wide slot, fully insert.

Attention: Pour éviter les chocs électriques, introduire la lame la plus large de la fiche dans la borne correspondante de la prise et pousser jusqu'au fond.

This product satisfies FCC regulations when shielded cables and connectors are used to connect the unit to other equipment. To prevent electromagnetic interference with electric appliances, such as radios and televisions, use shielded cables and connectors for connections.

### IMPORTANT NOTE

The mains lead on this equipment is supplied with a moulded plug incorporating a fuse. The value of the fuse is indicated on the pin face of the plug. If it requires replacing, a fuse approved to BS1362 of the same rating must be used.

Never use the plug with the fuse cover omitted if the cover is detachable. If a replacement fuse cover is required, it must be of the same colour as the pin face of the plug. Replacement covers are available from your dealer.

If the fitted plug is not suitable for the power points in your house or the cable is not long enough to reach a power point, you should obtain a suitable safety approved extension lead or consult your dealer for assistance.

However, if there is no alternative to cutting off the plug, remove the fuse and then safely dispose of the plug. Do not connect the plug to a mains socket, as there is a risk of shock hazard from the bared flexible cord.

### IMPORTANT

The wires in the mains lead are coloured in accordance with the following code: -

**BLUE = NEUTRAL BROWN = LIVE**

As these colours may not correspond with the coloured markings identifying the terminals in your plug, proceed as follows: -

The wire coloured BLUE must be connected to the terminal marked with the letter N or coloured BLUE or BLACK. The wire coloured BROWN must be connected to the terminal marked with the letter L or coloured BROWN or RED.

**WARNING: DO NOT CONNECT EITHER WIRE TO THE EARTH TERMINAL WHICH IS MARKED WITH THE LETTER E OR BY THE EARTH SYMBOL, OR COLOURED GREEN OR GREEN AND YELLOW.**

The product unit accompanying this user manual is licensed under certain intellectual property rights of certain third parties. This license is limited to private non-commercial use by end-user consumers for licensed contents. No rights are granted for commercial use. The license does not cover any product unit other than this product unit and the license does not extend to any unlicensed product unit or process conforming to ISO/IEC 11172-3 or ISO/IEC 13818-3 used or sold in combination with this product unit. The license only covers the use of this product unit to encode and/or decode audio files conforming to the ISO/IEC 11172-3 or ISO/IEC 13818-3. No rights are granted under this license for product features or functions that do not conform to the ISO/IEC 11172-3 or ISO/IEC 13818-3.

## Precaution

### Important Safety Instructions

Read these operating instructions carefully before using the unit. Follow all the safety instructions listed below. Keep these operating instructions handy for future reference.

- 1) Read these instructions.
- 2) Keep these instructions.
- 3) Heed all warnings.
- 4) Follow all instructions.
- 5) Do not use this apparatus near water.
- 6) Clean only with dry cloth.
- 7) Do not block any ventilation openings. Install in accordance with the manufacturer's instructions.
- 8) Do not install near any heat sources such as radiators, heat registers, stoves, or other apparatus (including amplifiers) that produce heat.
- 9) Do not defeat the safety purpose of the polarized or grounding-type plug. A polarized plug has two blades with one wider than the other. A grounding type plug has two blades and a third grounding prong. The wide blade or the third prong are provided for your safety. If the provided plug does not fit into your outlet, consult an electrician for replacement of the obsolete outlet.
- 10) Protect the power cord from being walked on or pinched particularly at plugs, convenience receptacles, and the point where they exit from the apparatus.
- 11) Only use attachments/accessories specified by the manufacturer.
- 12) Use only with the cart, stand, tripod, bracket, or table specified by the manufacturer, or sold with the apparatus. When a cart is used, use caution when moving the cart/apparatus combination to avoid injury from tip-over.
- 13) Unplug this apparatus during lightning storms or when unused for long periods of time.
- 14) Refer all servicing to qualified service personnel. Servicing is required when the apparatus has been damaged in any way, such as power-supply cord or plug is damaged, liquid has been spilled or objects have fallen into the apparatus, the apparatus has been exposed to rain or moisture, does not operate normally, or has been dropped.

### Handling Cautions

- Before connecting other components to this recorder, be sure to turn them all off.
- Do not move the recorder while a disc is being played, or the disc may be scratched or broken, and the recorder's internal parts may be damaged.
- Do not put a flower vase filled with water or any small metal objects on the recorder.
- Be careful not to put your hand into the disc tray.
- Do not place anything other than the disc in the disc tray.
- Exterior interference such as lightning and static electricity can affect normal operation of this recorder. If this occurs, turn the recorder off and on again with the STANDBY/ON button, or disconnect and then reconnect the AC power cord to the AC power outlet. The recorder will operate normally.

- Be sure to remove the disc and turn off the recorder after use.
- Disconnect the AC power cord from the AC outlet when you don't intend to use the recorder for long periods of time.
- Clean the disc by wiping in a straight line from the inside to the outside of the disc.

### Maintenance of Cabinet

For safety reasons, be sure to disconnect the AC power cord from the AC outlet.

- Do not use benzene, thinner, or other solvents for cleaning.
- Wipe the cabinet with a soft cloth.

### Disc Handling

- Use discs with regular shapes. If an irregular disc (a disc with a special shape) is used, this DVD recorder may be damaged.

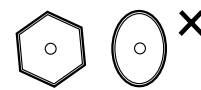

### Holding discs

- Avoid touching the surface of a disc where recording is performed.



### Cartridge

- This is used to prevent damage by dirt, scratches, etc. when using a DVD-RAM/RW/R disc.

### DVD-RAM, DVD-RW and DVD-R

- Clean with an optional DVD-RAM/PD disc cleaner. Do not use cleaners or cloths for CDs to clean DVD-RAM/DVD-RW/DVD-R discs.



### DVD-Video, CD

- Wipe off dirt or contamination on the disc with a soft cloth.

### Cautions on handling discs

- Do not write on the printed side with a ball-point pen or pencil.
- Do not use record cleaning sprays or antistatic. Also, do not use volatile chemicals, such as benzene or thinner.

- Do not apply labels or stickers to discs. (Do not use discs fixed with exposed tape adhesive or left-over peeled-off stickers.)
- Do not use scratch-proof protectors or covers.
- Do not use discs printed with label printers available on the market.
- Do not load warped or cracked discs.

## Disc Storage

Be careful not to harm the disc because the data on these discs is highly vulnerable to the environment.

- Do not keep under direct sunlight.
- Keep in a cool ventilated area.
- Store vertically.
- Keep in a clean protection jacket.
- If you move your DVD Recorder-VCR suddenly from a cold place to a warm place, condensation may generate on the operating parts and lens and cause abnormal disc playback. If this occurs, remove the disc and wait for one to two hours with the power on before attempting playback.

## Disc Specifications

### DVD-Video

- A digital versatile disc (DVD) can contain up to 135-minutes of images, 8-language audio and 32 subtitle languages. It is equipped with MPEG-2 picture compression and Dolby 3D surround, allowing you to enjoy vivid and clear theater quality images in the comfort of your own home.
- When switching from the first layer to the second layer of a double-layered DVD Video disc, there may be momentary distortion in the image and sound.  
This is not a malfunction of the unit.
- Once a DVD-RW/DVD-R recorded in Video Mode is finalized, it becomes DVD-Video.

### Audio CD

- An audio disc on which 44.1kHz PCM Audio is recorded.
- Plays CDDA format audio CD-R and CD-RW discs. This unit may not be able to play some CD-R or CD-RW discs due to the condition of the recording.

### CD-R/-RW

#### MP3 CD-R/-RW

- Only CD-R discs with MP3 files recorded with ISO9660 or JOLIET format can be played back
- Only MP3 files with the "mp3", and "MP3" extension can be used.
- For MP3 files recorded with a VBR(Variable Bit Rates), from 32 Kbps to 320 Kbps, the sound may cut in out.
- Playable bitrate range is from 56Kbps to 320Kbps.
- The unit can handle a maximum of 1000 files and folders.

#### JPEG CD-R/-RW

- Only JPEG files with the ".jpg", ".JPG" extension can be used.
- The unit can handle a maximum of 1000 files and folders.
- Maximum size of progressive JPEG is 3M pixels.
- MOTION JPEG is not supported.

#### Using CD-R/-RW

- Use a 700MB(80 minutes) CD-R/-RW disc. If possible, do not use a 800MB(90 minutes) or above disc, as the disc may not play back.
- If the CD-R/-RW disc was not recorded as a closed session, you may experience a delay in the early play-back time, and all recorded files may not play.
- Some CD-R/-RW discs may not be playable with this unit, depending on the device which was used to burn them.  
For contents recorded on CD-R/-RW media from CDs for your personal use, playability may vary depending on contents and discs.

### DVD-R Disc Playback and Recording

- Once a DVD-RW/DVD-R recorded in Video Mode is finalized, it becomes DVD-Video.
- You can record onto the available space on the disc and perform editing functions such as giving titles to discs and programs and erasing programs before finalizing.
- When programming is erased from a DVD-R, that space does not become available. Once an area on a DVD-R is recorded on, that area is no longer available for recording, whether the recording is erased or not.
- It takes about 30 seconds for the unit to complete recording management information after recording finishes.
- This product optimizes the DVD-R for each recording. Optimizing is carried out when you start recording after inserting the disc or turn on the unit. Recording onto the disc may become impossible if optimizing is carried out too many times.
- Playback may be impossible in some cases due to the condition of recording.
- This unit can play back DVD-R discs recorded and finalized with a Toshiba DVD recorder. It may not be able to play some DVD-R discs depending on the disc and the condition of the recording.

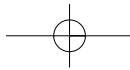

## DVD-RW Disc Playback and Recording

- Recording and playback can be performed on DVD-RW discs in both Video and VR Modes.
- Once a DVD-RW recorded in VR Mode is finalized, you cannot perform additional recording.
- Once a DVD-RW recorded in Video Mode is finalized, it becomes DVD-Video.
- In both modes, playback can be performed before and after finalization, but additional recording, deleting and editing can not be performed after finalization.
- If you want to record the disc in VR Mode and then record in V Mode, be sure to execute Format. Be careful when executing Format because all the recorded data may be lost.
- A DVD-RW blank disc is initialized to VR Mode when first initialized.
- **DVD-RW (VR mode)**
  - This is a format that is used for recording data on a DVD-RAM or DVD-RW disc. You can repeat recording, editing, deleting, partial deletion, creation of playlist, and etc.
  - A disc that is recorded in this mode may not be played by existing DVD players.
- **DVD-RW (Video mode)**
  - This is a format that is used for recording data on a DVD-RW or DVD-R disc. The disc can be played by an existing DVD player once it has been finalized.
  - If a disc that has been recorded in Video mode by a different manufacturer's recorder but has not been finalized it cannot be played or additionally be recorded by this recorder.

## DVD-RAM Disc Playback and Recording

- DVD-RAM discs come with or without a cartridge. For this product, we recommend DVD-RAM discs that come with cartridges.
- Some cartridges are able to eject the disc inside. Even if you are able to eject the disc, always use the disc with the cartridge to ensure correct operation.
- DVD-RAM discs have a Write Protect tab in order to avoid accidental erasure of recorded data. With the Write Protect tab set to PROTECT, you can play the disc, but recording or erasing will not work. Set the Write Protect tab to UNPROTECT to format the disc or erase data.
- Ensure that the recording mode is set to VR mode. Otherwise, this product will not be able to play the recording.
- You cannot play a DVD-RAM in most DVD players due to compatibility issues.
- Only DVD-RAM standard Version 2.0 discs can be played in this unit.
- DVD-RAM recorded on this unit may not work with other DVD Players. To determine compatibility with these DVD-RAM discs, refer to the user's manual for the player.
- This unit is compatible with both non-cartridge and cartridge DVD-RAM, but the write-protect tabs on cartridge-type discs give better protection to your recordings.

## Protection

This DVD Recorder can allow you to protect the contents of your discs, as described below.

- **Cartridge-protected:** With the Write Protect tab located in the protect position, the contents of the disc cannot be recorded, edited, or erased.
  - **Program-protected:** See page 69 "Locking a Title"
  - **Disc-protected:** See page 81 "Disc Protection"
- \* DVD-RAM/DVD-RW/DVD-R discs that are incompatible with VR/V format can not be played with this product.
- \* For more information on recording a DVD, consult your DVD-RAM/DVD-RW/DVD-R manufacturer.
- \* If poor quality DVD-RAM/DVD-RW/DVD-R discs are used, your recordings may fail.



Getting Started

## Do not use the following discs!

- LD, CD-G, CD-I, CD-ROM, DVD-ROM, VCD, DVD+R and DVD+RW discs should not be used in this product.

### [Note]

Disc types that can be played : CD/CD-R/CD-RW/MP3/ JPEG/DVD-Video/DVD-RAM/ DVD-RW/ DVD-R. However, if your DVD-RW disc was recorded with another device, it can be played only if it was recorded and finalized in video mode.

- Some commercial discs and DVD discs purchased outside your region may not be playable with this product. When these discs are played, either "No disc." or "Please check the regional code." will be displayed.
- If your DVD-RW disc is an illegal copy or is not in DVD video format, it may also not be playable.

## COPY PROTECTION

- Many DVD discs are encoded with copy protection. Because of this, you should only connect your DVD Recorder-VCR directly to your TV, not to a VCR. Connecting to a VCR results in a distorted picture from copy-protected DVD discs.
- This product incorporates copyright protection technology that is protected by methods claims of certain U.S. patents and other intellectual property rights owned by Macrovision Corporation and other rights owners. Use of this copyright protection technology must be authorized by Macrovision Corporation, and is intended for home and other limited viewing uses only unless otherwise authorized by Macrovision Corporation. Reverse engineering or disassembly is prohibited.
- It is permissible to record television programs, film, video tapes and other material only in the event that third party copyrights and other rights are not violated.

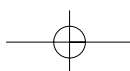

# Contents

## Getting Started

<b>Warning</b> .....	<b>2</b>
<b>Precaution</b> .....	<b>3</b>
Important Safety Instructions.....	3
Handling Cautions.....	3
Maintenance of Cabinet.....	3
Disc Handling .....	3
Disc Storage .....	4
Disc Specifications .....	6
<b>General Features</b> .....	<b>8</b>
<b>Before reading the user's manual</b> .....	<b>9</b>
<b>How to use the DVD Recorder</b> .....	<b>9</b>
<b>Description</b> .....	<b>11</b>
Front Panel .....	11
Front Panel Display.....	11
Rear Panel.....	12
Tour of the Remote Control.....	13

## Connecting & Setting UP

<b>Quick Overview</b> .....	<b>14</b>
<b>Step 1 : Unpacking</b> .....	<b>15</b>
Accessory .....	15
<b>Step 2 : Connecting SCART Cable</b> .....	<b>15</b>
Method 1 : Antenna + DVD Recorder + TV .....	15
Method 2 : Antenna + VCR/satellite receiver/cable box + DVD Recorder + TV .....	16
Method 3 : Antenna + DVD recorder + external decoder box + TV .....	17
<b>Step 3 : Other type of connecting the Video     output cable</b> .....	<b>17</b>
Method 1 : Connecting to a Composite Video output jack.....	17
Method 2 : Connecting to an S-video output jack.....	17

### Step 4 : Other type of connecting the Audio

<b>output cable</b> .....	<b>18</b>
Method 1 : Connecting to your TV.....	18
Method 2 : Connecting to a stereo amplifier with analogue output jacks.....	19
Method 3: Connecting to an AV amplifier with a digital output jack .....	19

### Step 5 : Connecting to AV3, AV4, DV input jack ....

Method 1 : Connecting a VCR, Set-Top Box(STB) or DVD player to the AV3 Input jacks.....	19
Method 2 : Connecting a Camcorder to the AV4 Input jacks.....	20
Method 3 : Connecting a Camcorder to the DV IN jack ...	20

### Step 6 : Preparing the Remote Control.....

Setting the Remote Control.....	21
---------------------------------	----

## System Setup

<b>On-Screen Menu Navigation</b> .....	<b>23</b>
<b>Plug &amp; Auto Set up</b> .....	<b>24</b>
<b>Clock Set</b> .....	<b>25</b>
<b>Auto Setup</b> .....	<b>26</b>
<b>Manual Setup</b> .....	<b>27</b>
<b>CM Skip Time Setting</b> .....	<b>28</b>
<b>Setting Up the NICAM Options</b> .....	<b>29</b>
<b>Setting Up Scart Jack Options</b> .....	<b>29</b>
<b>Setting Up the Language Features</b> .....	<b>30</b>
<b>Setting Up the Audio Options</b> .....	<b>31</b>
Audio Options.....	31
<b>Setting Up the Display(Video) Options</b> .....	<b>32</b>
Display(Video) Options .....	32
<b>Setting Up the Parental Control</b> .....	<b>33</b>
About the Change Password; .....	33

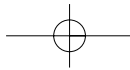

## Recording

<b>Before Recording</b> .....	<b>34</b>
Recordable discs.....	34
Recording Formats .....	35
Recording Mode.....	35
Unrecordable pictures.....	35
About DISPLAY Key .....	36
Checking the available disc space (Disc Information).....	36
<b>Recording the current TV program you are watching</b> .....	<b>36</b>
<b>Recording from external equipment you are watching</b> .....	<b>38</b>
<b>Reviewing Images Being Recorded (Time Slip)</b> .....	<b>39</b>
<b>Making a One Touch Recording (OTR)</b> .....	<b>40</b>
<b>Making a Standard Timer</b> .....	<b>41</b>
<b>Flexible Recording (for Timer recording only)</b> .....	<b>42</b>
<b>Editing a Standard Timer</b> .....	<b>42</b>
<b>Deleting a Standard Timer</b> .....	<b>43</b>
<b>Using the Video Plus+ Feature</b> .....	<b>44</b>
<b>Video Plus+ Extended</b> .....	<b>45</b>
<b>Recording the Standard Timer List</b> .....	<b>46</b>

## Playback

<b>Before Playing</b> .....	<b>47</b>
Region code (DVD-Video only).....	47
Disc types that can be played.....	47
Discs that cannot be played.....	47
<b>Playing a Disc</b> .....	<b>48</b>
Using the Disc & Title Menu.....	49
Using the Search Functions.....	49
Slow Motion Play .....	50
Step Motion Play.....	50
About ANYKEY .....	50
Using the Repeat Function.....	51
Selecting the Subtitle .....	54
Selecting the Audio language.....	54

Changing the Camera Angle.....	55
Zooming-In .....	55
Using PIP(Picture in Picture).....	56
Using Last Mark .....	56
Using Bookmarks.....	57
Using Markers .....	58
<b>Playing an Audio CD/MP3</b> .....	<b>59</b>
Playing an Audio CD (CD-DA)/MP3.....	59
<b>Playing a Picture CD</b> .....	<b>62</b>
<b>Playing the Title List</b> .....	<b>63</b>

## Editing

<b>Basic Editing (Title List)</b> .....	<b>66</b>
Renaming(Labeling) a Title .....	66
Locking(Protecting) a Title .....	67
Deleting a Title .....	67
Deleting a Section of a Title .....	68
<b>Advanced Editing (Play List)</b> .....	<b>70</b>
Creating a Playlist .....	70
Playing Entries in the Playlist .....	71
Renaming a Playlist Entry .....	72
Editing a Scene for the Playlist .....	73
Copying a Playlist Entry to the Playlist .....	76
Deleting a Playlist Entry from the Playlist.....	77
<b>Disc Manager</b> .....	<b>78</b>
Editing the Disc Name.....	78
Disc Protection .....	79
Formatting a Disc.....	79
Delete All Title Lists .....	80
Cartridge Protect Info.....	81
Finalizing a disc.....	81
Unfinalizing a disc (V/VR mode) .....	82

## Additional Information

<b>Troubleshooting</b> .....	<b>84</b>
<b>Specifications</b> .....	<b>88</b>

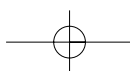
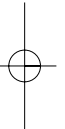



## General Features



The DVD-D-R3 allows you to record and play high quality digital images on DVD-RAM/DVD-RW/DVD-R discs. You can record and edit digital images on DVD-RAM/DVD-RW/DVD-R discs as if they were VCR tapes.

### High quality digital audio and video recording and playback

Record up to 12-hours of images with a double sided 9.4 GB DVD-RAM disc, and up to 6-hours of images with a 4.7 GB DVD-RAM/DVD-RW/DVD-R disc, depending on the recording mode.

### Selectable Recording Mode

You can set your recorder to one of five different recording speeds, each varying in recording quality and length. EP mode yields the most recording time, LP & SP modes provide less recording time with higher quality recording, and XP mode gives you the highest quality recording. There's also the FR (Flexible Recording) mode that lets you record with the best picture quality possible for the recording time and remaining space on the disc in timer recording.

### Automated Quality Adjustment for Timer Recording

If FR mode is selected, the video quality is adjusted automatically so that all images for the scheduled time can be recorded onto the free disc space. (See page 42.)

### Time Slip and Picture In Picture (PIP)

Use the Time Slip function to review the recorded images while a recording is underway. Use the PIP function to view both the playback and recording screens simultaneously. (See page 39 and 56.)

### Creating a DVD video title using DVD-RW/DVD-R disc

With a DVD-R100E, create your own DVD video title on 4.7 GB DVD-RW/DVD-R discs.

### Copying data from a digital camcorder using a DV input jack

Record digital camcorder images onto DVD-RAM or DVD-RW, DVD-R discs using the DV input jack (IEEE 1394-4pin/4pin). (See pages 20 and 38.)

### A variety of functions with an easy-to-use user interface

The integrated menu system and the messaging function allow you to perform desired operations both easily and conveniently. With a DVD-RAM or DVD-RW disc, you can edit recorded images, create a playlist, and edit images in a specific sequence according to your requirements.

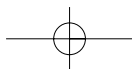

## Before reading the user's manual

Make sure to check the following matters before reading the user's manual.

### Icons that will be used in manual

Icon	Term	Definition
	DVD	This involves a function available in DVD or DVD-R/DVD-RW discs that have been recorded and finalised in Video Mode.
	RAM	This involves a function available in DVD-RAM.
	RW	This involves a function available in DVD-RW.
	R	This involves a function available in DVD-R.
	CD	This involves a function available in a data CD (CD-R or CD-RW).
	JPEG	This involves a function available in a data picture CD (CD-R or CD-RW).
	MP3	This involves a function available in a data CD (CD-R or CD-RW) on which MP3 is recorded.
	Caution	This involves a case where a function does not operate or settings may be cancelled.
	NOTE	This involves tips or instructions on the page that help each function operate.
	One-Touch button	A function that can be operated by using only one button.

### About the use of this user's manual

- 1) Be sure to be familiar with Safety Instructions before using this product. (See pages 4~3)
- 2) If a problem occurs, check for Troubleshooting. (See pages 84~87)

### Copyright

©2004 Tashiba Corporation  
All rights reserved; No part or whole of this user's manual may be reproduced or copied without the prior written permission of Tashiba Corporation.

## How to use the DVD Recorder

Getting Started

### Step 1 Select the disc type

This unit can record on the following types of discs. If you want to repeatedly record on the same disc or you want to edit the disc after recording, select a rewritable DVD-RW or DVD-RAM type disc. If you want to save recording without any change, choose a non-rewritable DVD-R.



### Step 2 Format the disc to start recording

Unlike a VCR, the recorder automatically starts formatting when an unused disc is inserted. This is required for the preparation of recording on a disc.

#### Using a DVD-RAM

This type of disc can be formatted in DVD-Video Recording format (VR mode). You can edit recorded image and create a playlist and edit images in a specific sequence according to your requirements.

#### Using a DVD-RW

This type of disc can be formatted in either DVD-Video format (Video mode) or DVD-Video Recording format (VR mode). For an unused disc, a message that asks whether to format in VR Mode or not is displayed. You can play a Video mode disc on various DVD components. A VR mode disc allows more varied editing.

#### Using a DVD-R

This type of disc can be formatted in DVD Video format. After formatting is complete, you can record on the disc. You can play this type of discs on various DVD components only when they have been finalised.



NOTE

- You can only use one format on a DVD-RW.
- You can change the DVD-RW format to another format. It should be noted that the data of the disc may be lost when changing formats.

**Step 3** Recording

There are two different recording methods, Direct Recording and Timer Recording. Timer recording is classified as recording type : Once, Daily or Weekly or recording mode : XP (high quality mode), SP (standard quality mode), LP (long recording mode), and EP (extended mode) according to the recording mode. When recording is set in the FR mode, the best quality picture is recorded with regards to the remaining time on the disc.

**Step 4** Playing

You can select the title you want to play in a displayed menu and then immediately start playback. A DVD consists of sections, called titles, and sub sections, called chapters. During recording, a title is created between two points where you start and stop recording. DVD-R/DVD-RW discs (in Video mode) can automatically create chapters according to the recording mode when finalised.

**Step 5** Editing a recorded disc

Editing on discs is easier than conventional video tapes. The recorder supports many different edit functions, possible only with DVDs. With a simple and easy edit menu, you can operate various edit functions, such as delete, copy, rename, lock, etc., on a recorded title.

**Creating a playlist (DVD-RAM/RW in VR mode)**

With this recorder, you can create a new playlist on the same disc and edit it without the change of the original recording.

**Step 6** Finalizing & Playing on other DVD components

To play your DVD on other DVD components, finalizing may be necessary. First, finish all editing and recording operations, then finalise the disc.

**When using a DVD-RW disc in VR Mode**

Although finalizing is generally unnecessary when playing the disc on a VR Mode compatible component, a finalised disc should be used for playback on that type of component.

**When using a DVD-RW disc in Video Mode**

The disc should be finalised first to enable playback on anything other than this recorder. No more editing or recording can be made on the disc once it has been finalised.

**When using a DVD-R disc**

You should finalise the disc to play it on a component other than this recorder. You cannot edit or record on the disc once it has been finalised.

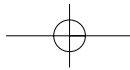

## Description

### Front Panel

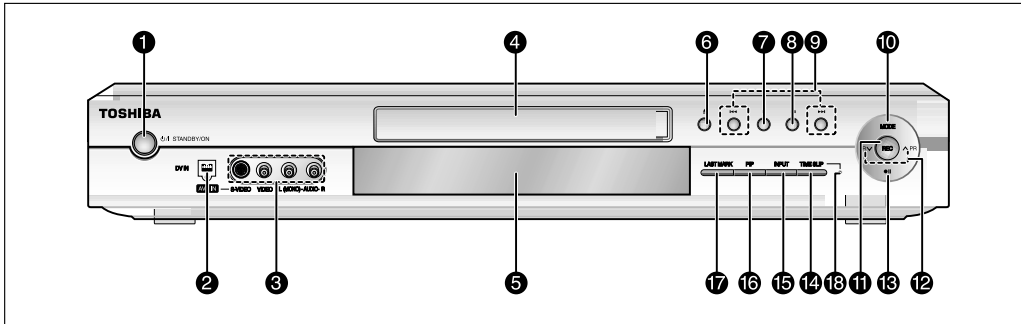

- |  |  |
|--|--|
| <p><b>1. STANDBY/ON</b><br/>Turns the recorder on and off.</p> <p><b>2. DV-IN</b><br/>Connects external digital equipment with a DV jack.</p> <p><b>3. AV4 IN</b><br/>Connects external equipment.</p> <p><b>4. DISC TRAY</b><br/>Opens to accept a disc.</p> <p><b>5. DISPLAY</b><br/>Displays the playing status, title/ chapter/ time, etc.</p> <p><b>6. OPEN/CLOSE</b><br/>Opens and closes the disc tray.</p> <p><b>7. STOP</b><br/>Stops disc playback.</p> <p><b>8. PLAY/PAUSE</b><br/>Plays a disc or pauses playback.</p> <p><b>9. SEARCH</b><br/>Goes to the next title/chapter/track, or goes back to the previous title/chapter/track.</p> <p><b>10. RECORD MODE</b><br/>Selects the recording mode.</p> | <p><b>11. REC</b><br/>Starts recording.</p> <p><b>12. PR (∨∧)</b><br/>Select TV preset channels.<br/>Same as PROG buttons in remote control.</p> <p><b>13. REC PAUSE</b><br/>Pauses recording.</p> <p><b>14. TIME SLIP</b><br/>The Time Slip function allows you to view a recorded program through the PIP window at least 10 seconds after recording starts. Playback and recording can be done at the same time.</p> <p><b>15. INPUT</b><br/>Selects equipment connected to the line inputs.</p> <p><b>16. PIP</b><br/>To watch an external source on the PIP(sub) picture or to monitor Time Slip.</p> <p><b>17. LAST MARK</b><br/>Goes to the last bookmarked position.</p> <p><b>18. TIME SLIP LED</b><br/>The LED indicator lights up green when the Time Slip function operates.</p> |
|--|--|

### Front Panel Display

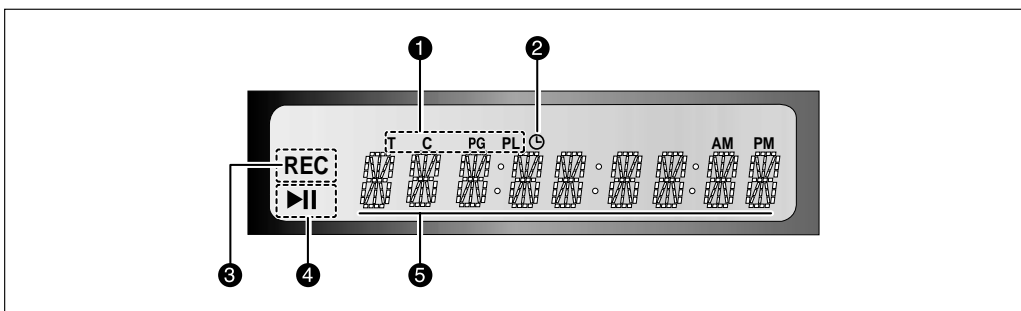

- |   |   |
|---|---|
| <p>1. This lights to indicate the names of the sections of the disc being played.</p> <p>2. Lights to indicate the timer recording mode.</p> <p>3. Lights in the record mode.</p> | <p>4. Lights in the playback/pause mode.</p> <p>5. Displays the title, chapter, title list or playlist number and displays the message during playback.</p> |
|---|---|

## Rear Panel

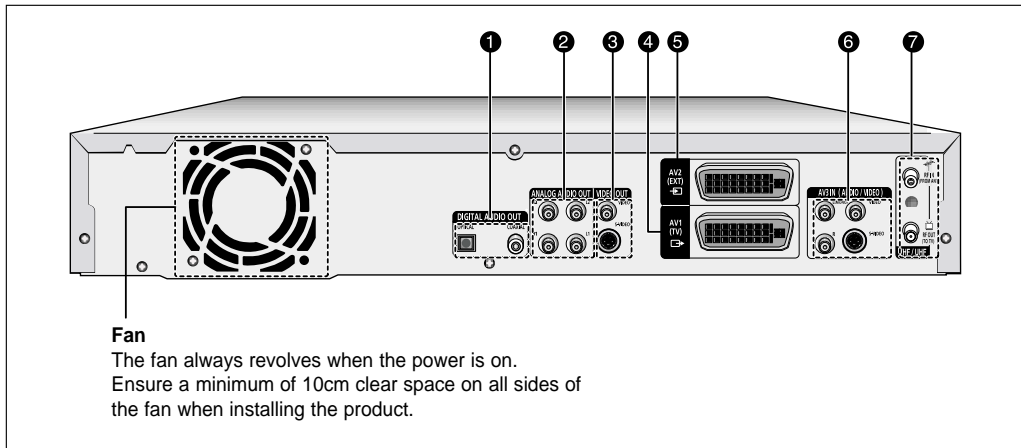

### 1. DIGITAL AUDIO OUT

Connects to an amplifier having a digital input jack.

### 2. ANALOGUE AUDIO OUT

Connects to the audio input of external equipment using audio cables.

### 3. VIDEO OUT

Connects the input of external equipment using a Video or S-Video cable.

### 4. AV1(TV) OUTPUT SCART

### 5. AV2(EXT) INPUT SCART

### 6. AV3 IN(AUDIO/VIDEO)

Connects the output of external equipment using an audio/video or S-Video cable.

### 7. VHF/UHF

Connects antenna cables.

## Tour of the Remote Control

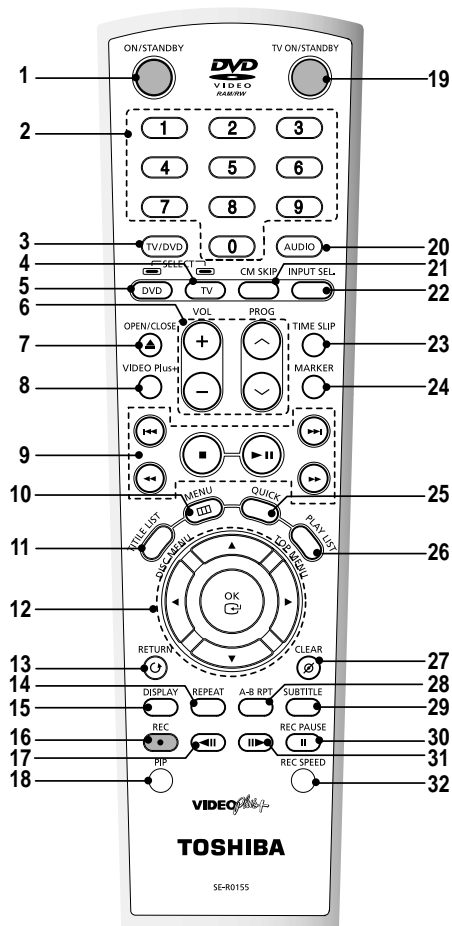

### 1. DVD STANDBY/ON Button

### 2. Number Buttons

### 3. TV/DVD Button

### 4. TV Button

Press this to operate TV.

### 5. DVD Button

Press this when you use a DVD.

### 6. TV Control Buttons

- TV VOL Button  
TV volume adjustment
- PROG Button  
Allows you to program a specific order.  
Same as PR buttons in Front panel.

### 7. OPEN/CLOSE Button

To open and close the disc tray.

### 8. VIDEO Plus+ Button

Press to make a timer recoding of a programme by entering the programmes VIDEO Plus+ number.

### 9. Playback-related buttons

Search, Skip, Stop, Play/Pause

### 10. MENU Button

Brings up the DVD Recorder's setup menu.

### 11. TITLE LIST/DISC MENU Button

Use this to enter the View Recording list/Disc menu.

### 12. OK/DIRECTION Buttons

(UP/DOWN or LEFT/RIGHT Buttons)  
This button functions as a toggle switch.

### 13. RETURN Button

Returns to a previous menu.

### 14. REPEAT Button

Allows you to repeat a title, chapter, track or disc.

### 15. DISPLAY Button

This will display current setting or disc status.

### 16. REC Button

Use to make a recording on DVD-RAM/-RW/-R discs.

### 17. REVERSE STEP Button

Each press of this button will play one-frame reverse.

### 18. PIP Button

Use to watch a sub program on the PIP screen while watching the main program on the main screen.

### 19. TV STANDBY/ON Button

### 20. AUDIO/TV MUTE Button

Use this to access various audio functions on a disc.(DVD mode)  
This operates as Sound Mute. (TV mode)

### 21. CM SKIP Button

When a program recorded on a DVD-RAM, a DVD-RW, a DVD-R or DVD-Video is played, the unit can be set to automatically skip a portion of the program.

### 22. INPUT SEL Button

Select line input signal in external input mode(Tuner or Line input)

### 23. TIME SLIP Button

The Time Slip function allows you to view a recorded program through the PIP window at least 10 seconds after recording starts. Playback and recording can be done at the same time.

### 24. MARKER Button

Use this to bookmark a position while playing a disc.

### 25. QUICK Button

Use this to view the status of the disc that is being played.

### 26. PLAY LIST/TITLE MENU Button

Use this to return to the Title menu, or to view the recorded files list.

### 27. CANCEL Button

### 28. REPEAT(A-B) Button

Press to repeat between A-B disc.

### 29. SUBTITLE Button

Press this to switch the DVD's subtitle language.

### 30. REC PAUSE Button

Use this to pause during recording.

### 31. FORWARD STEP Button

Each press of this button will play one-frame forward

### 32. REC SPEED Button

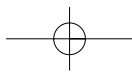

# Connecting & Setting Up

This section involves various methods of connecting the DVD player to other external components and required initial setting modes.

## Quick Overview



A Quick Overview presented in this guide will give you enough information to start using the recorder.

### Step 1 : Unpacking



### Step 2 : Connecting SCART Cable



### Step 3 : Other type of connecting the Video output cable



### Step 4 : Other type of connecting the Audio output cable



### Step 5 : Connecting to AV 3, AV 4, DV input jack



### Step 6 : Preparing the Remote Control

Quick Overview .....	14
Step 1 : Unpacking.....	15
Step 2 : Connecting SCART Cable .....	15
Step 3 : Other type of connecting the Video output cable.....	17
Step 4 : Other type of connecting the Audio output cable .....	18
Step 5 : Connecting to AV 3, AV 4, DV input jack .....	20
Step 6 : Preparing the Remote Control .....	21

● **Note to CATV system installer:** This reminder is provided to call CATV system installer's attention to Article 820-40 of the National Electrical Code (Section 54 of Canadian Electrical Code, Part I), that provides guidelines for proper grounding and, in particular, specifies that the cable ground shall be connected to the grounding system of the building as close to the point of cable entry as practical.

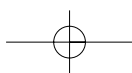

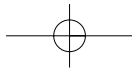

## Step 1: Unpacking

### Accessory

Check for the supplied accessories below.

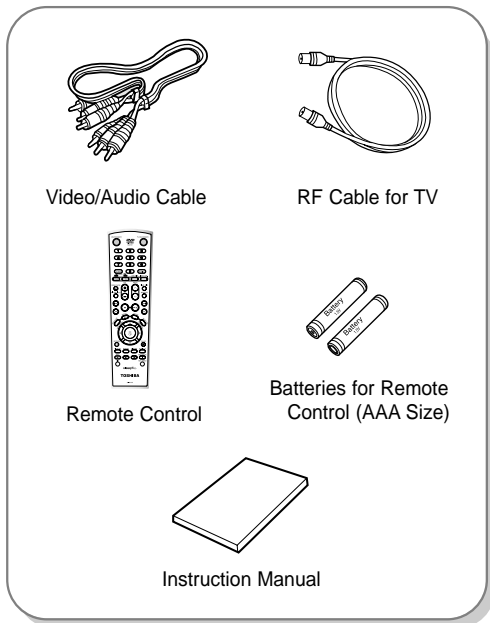

## Step 2: Connecting SCART Cable

There are several ways to connect your DVD Recorder using scart cables. Select one of the following connections that best suits you.

- Method 1 : Antenna + DVD Recorder + TV
- Method 2 : Antenna + VCR/satellite receiver/cable box + DVD Recorder + TV



NOTE

- If you are using an off-air antenna that has 300-ohm twin flat leads, use an external antenna connector (300-75 ohm adaptor : not supplied) to connect the antenna to the DVD Recorder.

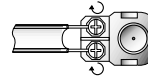

- If you have two separate antennas (one VHF and the other UHF), use a UHF/VHF combiner-adaptor (available at most electronics shops) to connect the antenna to the DVD Recorder.

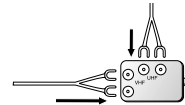

- The VHF/UHF RF OUT jack of this product sends only signals received through the antenna. It does not output Audio/ video signals. You must connect audio/video cables to view Video from the unit. (i.e. DVD playback)



## Method 1 : Antenna + DVD Recorder + TV

You can connect your DVD Recorder to the television using the SCART cable if the appropriate input is available on the television. You thus:

- Obtain better quality sound and pictures
- Simplify the setting up procedure of your DVD Recorder

1. Connect the RF cable as shown.
2. Connect one end of the SCART cable to the AV1 socket on the rear of the DVD Recorder.
3. Plug the other end into the appropriate connector on the television.

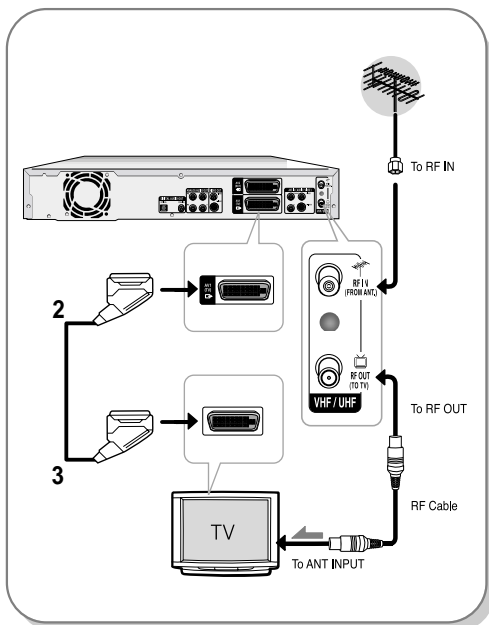

NOTE

- Regardless of the type of connection chosen, you must always connect the RF cable supplied. Otherwise, no picture will be visible on the screen when the DVD Recorder is switched off.
- Make sure that both the television and the DVD Recorder is switched off before connecting the cables.
- If you want to record one channel while watching another channel on TV screen, press TV/DVD button.

## Method 2 : Antenna + VCR/satellite receiver/cable box + DVD Recorder + TV

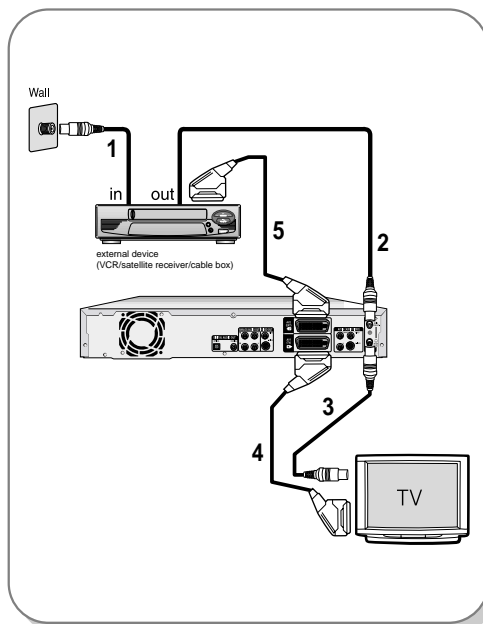

Before making or changing any rear panel connections, make sure that all components are switched off and unplugged from the wall outlet.

1. Connect the cable from the antenna/cable TV outlet to the antenna input on your VCR/satellite receiver/cable box.
2. Connect the antenna output of your VCR/satellite receiver/cable box to the ANTENNA IN of DVD Recorder using antenna cable.
3. Use another RF antenna cable to connect the ANTENNA OUT of DVD Recorder to the antenna input on your TV.
4. Connect the AV1 connector on DVD Recorder to the SCART AV connector on TV using a SCART cable.
5. Connect the AV2 connector to a SCART AV connector on VCR/satellite receiver/cable box.
6. Setup "AV1 Out option" using on-screen menu. Refer to page 29.

### Step3 : Other type of connecting the Video output cable

There are several ways to output video signal not using scart cables. Select one of the following video connecting that best suits you below.

- **Method 1** : Connecting to a Composite Video output jack
- **Method 2** : Connecting to an S-video output jack

#### S-Video Output Modes

- S-Video output are available only if your TV supports S-Video input. If S-Video output does not work, check the TV connections and the TV input selection settings. (For information on how to connect to a TV, see pages 15 to 16.)

### Method 1 : Connecting to a Composite Video output jack

Connect a video(yellow) cable between the VIDEO (yellow) OUT jack on DVD Recorder and VIDEO (yellow) IN jack on the TV (or AV amplifier).

- You will enjoy regular quality images.
- Connect audio cables( white and red) between the ANALOGUE AUDIO OUT jacks on the DVD Recorder and AUDIO IN jacks on TV( or AV amplifier). (See page 18)

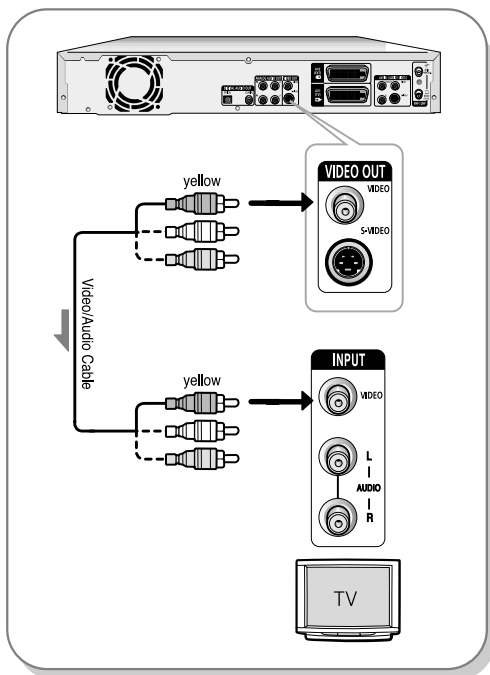

### Method 2 : Connecting to an S-video output jack

Connect an S-video cable(not supplied) between the S-VIDEO OUT jack on DVD Recorder and S-VIDEO IN jack on the TV (or AV amplifier).

- You will enjoy high quality images. S-Video separates the picture element into black and white (Y) and color (C) signals to present clearer images than regular video input mode.

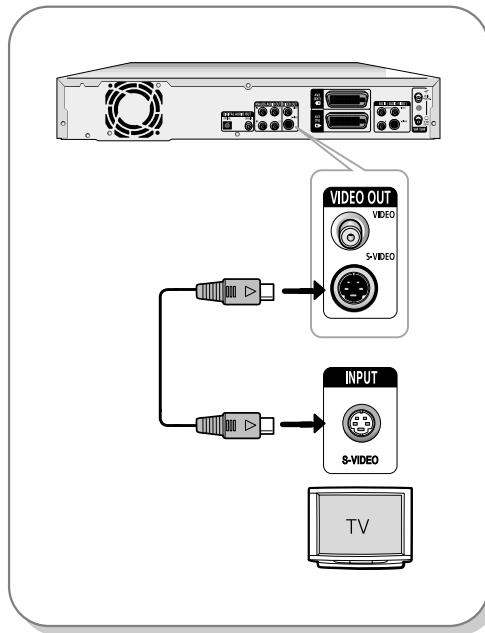

Connecting & Setting UP

## Step 4 : Other type of connecting the Audio output cable

There are several ways to output audio signal not using scart cables. Select the audio connection that best suits you below.

- **Method 1** : Connecting to your TV
- **Method 2** : Connecting to a stereo amplifier (analogue audio out / digital audio out)
- **Method 3** : Connecting to an AV amplifier with a digital output jack

Manufactured under license from Dolby Laboratories. "Dolby" and the double-D symbol are trademarks of Dolby Laboratories.

"DTS" and "DTS Digital Out" are trademarks of Digital Theater Systems, Inc.

### Method 1 : Connecting to your TV

This connection will use your TV's speakers.

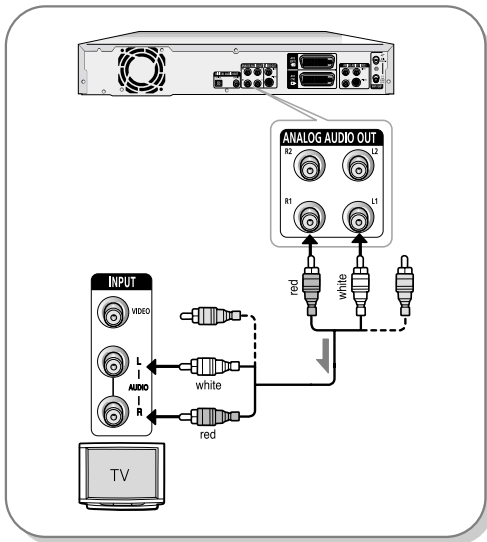

### Method 2 : Connecting to a stereo amplifier with analogue output jacks

If your stereo amplifier only has audio input jacks (L and R), use the analogue audio out jacks.

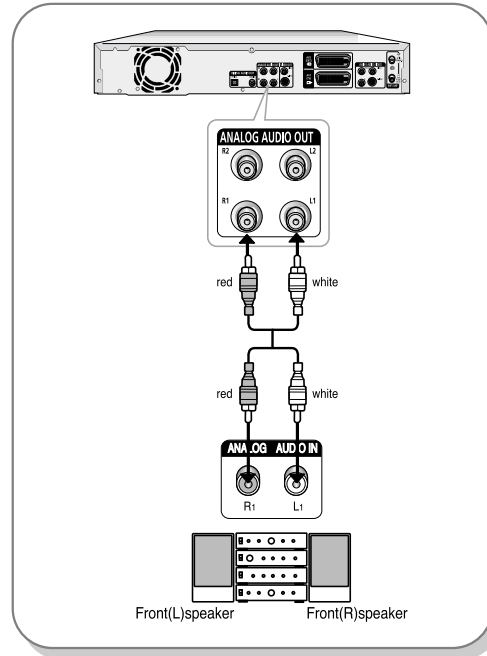

### Method 3: Connecting to an AV amplifier with a digital output jack

If your AV amplifier only has a Dolby Digital, MPEG-2 or DTS decoder and a digital input jack, use this connection. To enjoy Dolby Digital, MPEG-2 or DTS sound, you will set up the audio settings. (See page 31)

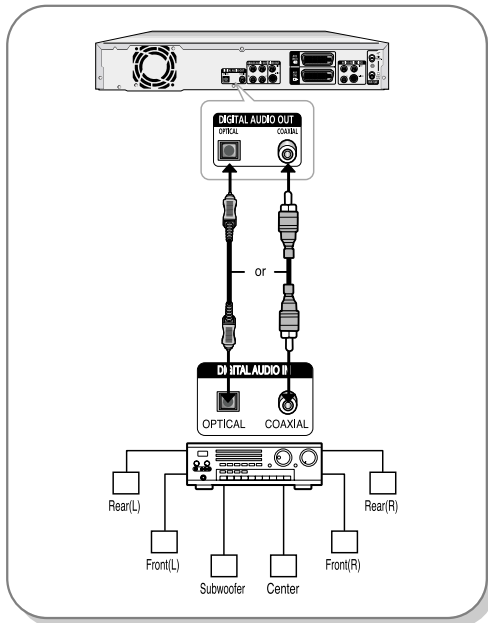

### Step 5 : Connecting to AV3, AV4, DV input jack

This allows you to connect your DVD Recorder to other external devices and view or record their outputs.

- **Method 1 :** Connecting a VCR, Set-Top Box(STB) or DVD player to the AV3 Input jacks
- **Method 2 :** Connecting a Camcorder to the AV4 Input jacks
- **Method 3 :** Connecting a Camcorder to the DV IN jack

### Method 1 : Connecting a VCR, Set-Top Box(STB) or DVD player to the AV3 Input jacks

Connecting a VCR or external device to AV3 IN jacks of the DVD Recorder. You can record from connected equipment (VCR, STB or DVD).

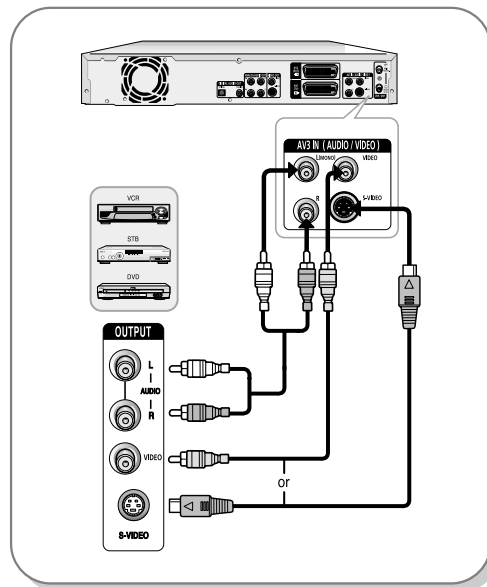

NOTE

- You can also use the AV4 IN jacks on the front panel of the DVD Recorder.
- When the S-Video jack and Video jack are both connected, the S-Video jack will have priority.
- AV IN Selection will be automatically done.
- Copy protected content cannot be recorded.

## Method 2 : Connecting a Camcorder to the AV 4 Input jacks

You can also use the AV 4 IN jacks on the front panel of the DVD Recorder. You can record from connected equipment.

When an input source is inserted into AV 4 while viewing TV, the input will be switched to AV 4 automatically.

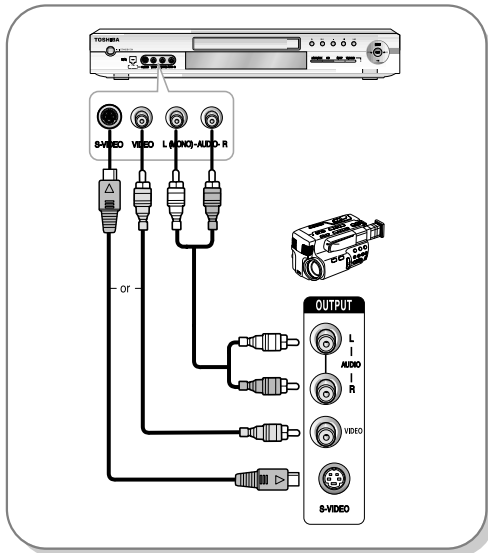

## Method 3 : Connecting a Camcorder to the DV IN jack

If your camcorder has a DV output jack, connect it to the DV input jack of your DVD Recorder.

DVs can be used as only input jack, not output jack.

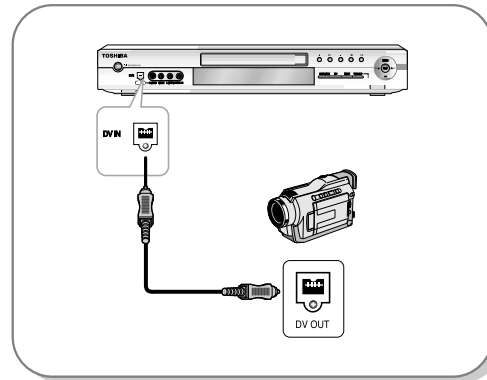

## Step 6 : Preparing the Remote Control

### Install Batteries in the Remote Control

- Open the battery cover on the back of the remote.
- Insert two AAA batteries. Make sure that the polarities (+ and -) are aligned correctly.
- Replace the battery cover.

### If remote does not operate properly:

- Check the polarity + - of the batteries (Dry-Cell)
- Check if the batteries are drained.
- Check if remote sensor is blocked by obstacles.
- Check if there is any fluorescent lighting nearby.

Dispose of batteries according to local environmental regulations. Do not put them in the household trash.

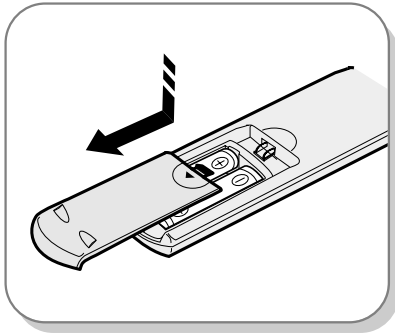

## Setting the Remote Control

Your DVD Recorder remote will work with Samsung televisions and compatible brands.

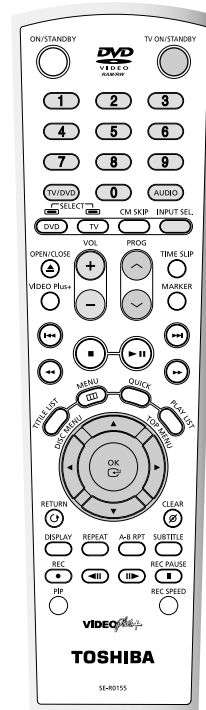

Connecting & Setting Up

**To determine whether your television is compatible, follow the instructions below.**

1. Switch your television on.
2. Point the remote control towards the television.
3. Hold down the TV STANDBY/ON button and enter the two-figure code corresponding to the brand of your television, by pressing the appropriate numeric buttons.

**Controllable TV Codes**

Brand name	Brand code
TOSHIBA	0001 0071 0211 0571
AIWA	0921
AKAI	0201 0241 0311 0431 0501 0521 0641
BAIRD	0171 0241
BANG & OLUFSEN	0471
BEKO	0181
BLAUPUNKT	0071 0321 0331
BRIONVEGA	0461 0471 0651
BUSH	0071 0501 0551 0571
CROWN	0111 0131 0411 0491 0501 0661
DANSAI	0501
DEAWOO	0401 0411 0501
DECCA	0091 0141 0171 0441 0451 0501
FERGUSON	0031 0071 0131 0191 0291 0311 0381 0541 0601
FINLUX	0021 0041 0071 0081 0091 0111 0271 0281 0291 0301 0341 0471
FISHER	0041 0121 0181 0201 0281 0471 0571 0651
FUNAI	0001 0191 0481 0491 0891
GEC	0171 0221
GOLDSTAR	0201 0251 0281 0411 0501
GOODMANS	0171 0281 0501 0571
GRANADA	0171 0241 0271 0501 0571 0651 0671
GRUNDIG	0011 0071 0271 0321 0331
HINARI	0241 0411 0571 0631
HITACHI	0021 0221 0251 0351 0371 0381 0431 0571 0641 0751
INNO HIT	0171 0281 0411 0501 0631 0661
ITT	0231 0241 0261 0271 0401 0611
ITT-NOKIA	0231 0241 0261 0271 0401 0611
JVC	0311 0431 0521 0571
LOEWE OPTA	0471 0501 0571 0651
LUXOR	0241 0261 0271 0281 0351
MAGNAVOX	0501 0071 0191 0221 0461 0471 0591 0611 0651
MARANTZ	0201 0501
MATSUI	0001 0171 0191 0231 0411 0441 0451 0501 0551 0571
METZ	0041 0331 0361 0461 0471 0651
MITSUBISHI	0201 0321 0331 0451 0501 0511 0571 0651 0771
NATIONAL	0371 0501 0511 0531 0761 0841 0911 1061
NOKIA	0231 0241 0261 0271 0401 0611
NORDMENDE	0281 0351 0381 0421 0431 0461 0521 0541 0641 0671
OCEANIC	0481
ORION	0001 0191 0231 0361 0411 0441 0451 0501 0551 0611
PANASONIC	0371 0501 0511 0531 0761 0841 0911 1061
PHILCO	0071 0111 0181 0201 0271 0301 0461 0501 0651
PHILIPS	0071 0191 0221 0461 0471 0501 0591 0611 0651
PIONEER	0381 0431 0501 0831 1051
PROSCAN-THOMSON	0971 1041 0201 0501
RCA	0971 1071 1081 1091 0201 1041 0501
REALISTIC	0631 1001 1011 1021 1031 0851 0201 0501 0481 0321 0331 0501 0651 0771

SABA	0281 0351 0381 0421 0431 0471 0541 0641 0651 0661 0671
SAISHO	0231 0411 0441 0451 0551
SALORA	0231 0241 0351
SAMSUNG	0171 0181 0251 0281 0411 0491 0501 0631 0661 0791
SANYO	0021 0041 0081 0121 0171 0181 0201 0231 0241 0451 0571 0651 0671 0701 0711 0721
SCHNEIDER	0011 0051 0061 0281 0461 0501 0581 0591
SEG	0091 0121 0151
SELECO	0031 0051 0061 0351 0501 0561
SHARP	0851 0511 0571 0201 0501
SIEMENS	0071 0321 0331 0571 0631
SINGER	0091 0471 0651
SINUDYNE	0001 0091 0101 0131 0191 0231 0361 0471 0501 0551 0581 0651
SONY	0441 0451 0571 0681
TANDBERG	0041 0301 0351 0431 0461 0571 0651
TATUNG	0091 0141 0171 0441 0451 0501
TECHNICS	0371 0501 0511 0531 0761 0841 0911 1061
TELEFUNKEN	0071 0281 0381 0421 0431 0521 0601 0621 0671
TENSAI	0041
THOMSON	0281 0351 0371 0381 0391 0421 0461 0521 0541 0641 0971 1041
THORN	0041 0071 0281 0291 0341 0421 0491 0601 0671
UNIVERSUM	0021 0491
YAMAHA	0201 0501 0321 0331 0451 0511 0571 0651 0771
ZANUSSI	0031 0051 0061 0351 0501 0561
ZENITH	0931

**Result:** If your television is compatible with the remote control, it will switch off.  
It is now programmed to operate with the remote control.



NOTE

- If several codes are indicated for your television brand, try each one in turn until you find one that works.
- If you replace the remote control's batteries, set the brand code again.

**You can then control the television using the following buttons.**

Button	Function
TV STANDBY/ON	Used to switch the television on and off.
INPUT	Used to select an external source.
TV VOL + or -	Used to adjust the volume of the television.
PROG ( ^ or v )	Used to select the required channel.
TV MUTE	Used to toggle the sound on and off.



NOTE

- The various functions will not necessarily work on all televisions. If you encounter problems, operate the television directly.

# System Setup

## On-Screen Menu Navigation

The on-screen menus allow you to enable or disable various functions on your DVD Recorder. Use the following buttons to open and navigate through the on-screen menus.

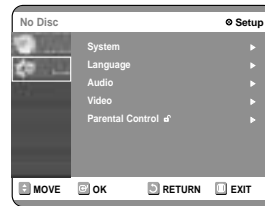

### 1 MENU Button

Press this button on the remote control while the DVD Recorder is in Stop or Play mode to open the on-screen MAIN MENU. And you can exit the on-screen MENU all together.

### 2 Up/Down and Left/Right

Use these buttons to move the selection bar up/down and left/right to cycle through the menu options.

### 3 OK Button

Press this button on the remote control to confirm any new settings.

### 4 RETURN Button

Press this button on the remote control to return to the last MENU screen displayed.

On-Screen Menu Navigation .....	23
Plug & Auto Set up .....	24
Clock Set .....	25
Auto Setup .....	26
Manual Setup .....	27
CM Skip Time Setting .....	28
Setting Up NICAM Options .....	29
Setting Up Scart Jack Options .....	29
Setting up the Language Features .....	30
Setting Up the Audio Options .....	31
Setting Up the Display(Video) Options .....	32
Setting Up the Parental Control .....	33



## Plug & Auto Set up

Your DVD Recorder will automatically set itself up when it is plugged in for the first time. TV stations and clock will be stored in memory. The process takes a few minutes. Your DVD Recorder will then be ready for use.

### 1 Connect the RF cable as indicated on page 15.

(Connecting Your DVD Recorder to the TV Using the RF cable)

### 2 Plug the DVD Recorder in.

### 3 Press a Number button to select the language.

Press 1 for English  
 Touche 2 pour Français  
 Drücken Sie 3 für Deutsch  
 Pulse 4 para Español  
 Premere 5 per Italiano  
 Druk op 6 voor Nederlands

### 4 Start the auto setup.

Auto setup will be started.  
 Check antenna and TV cable connection.

### 5 Auto Channel scan will be started.

Channel scan  
 Now, Scanning. 5%

- The number of stations automatically stored by the DVD Recorder depends on the number of stations that it has found.

### 6 After Auto Channel Scan is completed, Auto Clock Setting will be started automatically in 10 seconds. If you want to start Auto Clock Setting immediately, press OK button. If you do not want to do Auto Clock Setting, press CANCEL or MENU button.

Auto channel scan completed successfully.  
 Press [OK] button to auto clock set.

### 7 Wait until current date and time are displayed automatically. If you want to exit Auto clock setting, press MENU button.

Please wait. Now setting the clock.  
 If you want to exit clock setting,  
 press the [MENU] button.

### 8 Check the date and time.



- if it is : Correct, Press OK button then the date and time will be saved.
- if it is : Incorrect, input correct Time, Date, Year using ▼▲◀▶ buttons or number buttons.  
 Press OK button then the date and time will be saved.  
 When you need to change clock setting, you can set up it manually. (see page 25)



NOTE

- Now, DVD Recorder is ready for use. Function for "Plug & Auto Set Up" is fixed already. So if you want to change this fixed one, you can change it by Presetting the Stations in OSD "Manual Setup" menu. (see page 27)

## Clock Set

This menu is used to set the current time.  
You need to set the time to use timer recording.

**1** With the unit in Stop mode, press the MENU button.

**2** Using the ▼▲ buttons, move the selection bar to "Setup" then press OK button to select.

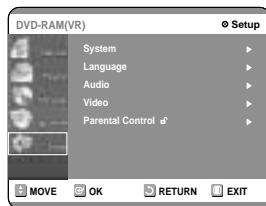

**3** Select "System" the ▼▲ buttons, then press the ► or OK button.

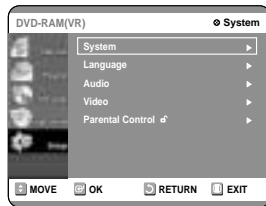

**4** Select "Clock Set" using the ▼▲ buttons, then press the ► or OK button.

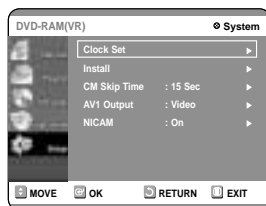

**5** Use navigation ▼▲◀▶ buttons to input Time, Date, Year. Use number button to input clock data directly.

**6** Set Auto clock tap "On" or "Off" using the ▲▼ buttons.

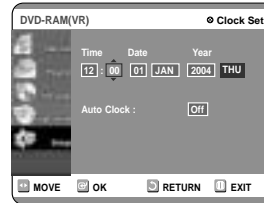

**7** Press OK button, then the date and time will be saved.

If you don't press OK button, it will not be saved.



NOTE

- You must have the antenna connected to set the Auto Clock. See page 15 Connections.
- Auto Clock : The recorder sets the clock automatically by searching for a channel that carries a time signal.

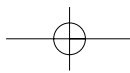

## Auto Setup

This feature allows you to manually set the DVD Recorder tuner band to Antenna or Cable, whichever you connected to the Antenna In jack during initial setup.

**6** Press OK button to continue. If you want to exit, press MENU button.

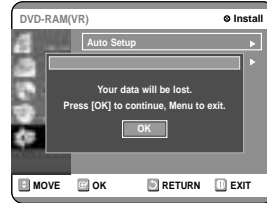

**1** With the unit in Stop mode, press the MENU button on the remote.

**2** Using the ▼▲ buttons, move the selection bar to "Setup" then press OK button to select.

**3** Using the ▼▲ buttons, move the selection bar to "System" then press OK button to select.

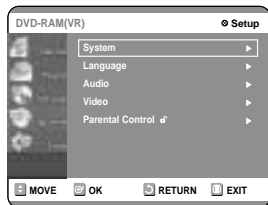

**4** Using the ▼▲ buttons, move the selection bar to "Install", then press OK button to select.

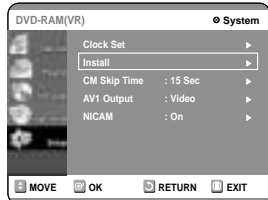

**5** Move the selection arrow to "Auto Setup" then press ► button to select from the following options:

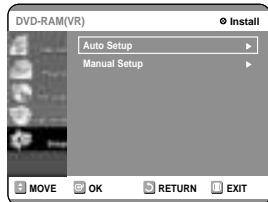

**7** Channel scan will be started. Select "Stop" using OK button to exit.

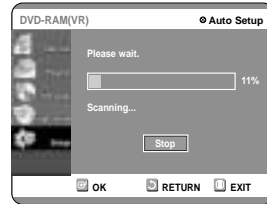

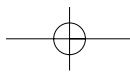

# Manual Setup

You can add preset channel that Auto Channel Search missed. And you can delete a channel you wish to remove.

**1** With the unit in Stop mode, press the MENU button on the remote.

**2** Using the ▼▲ buttons, move the selection bar to "Setup" then press OK button to select.

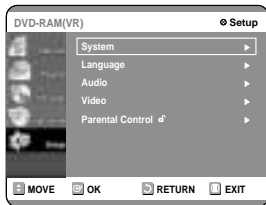

**3** Using the ▼▲ buttons, move the selection bar to "System" then press OK button to select.

**4** Using the ▼▲ buttons, move the selection bar to "Install", then press OK button to select.

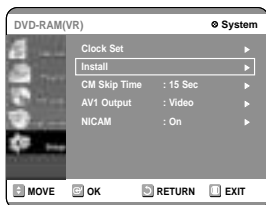

**5** Move the selection bar to "Manual Setup", then press OK button to select.

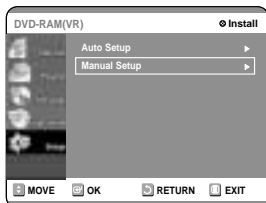

**6** Press the ▼▲ buttons to select a PR (program) you wish to edit, delete, or swap. And then press OK button.

**7** Select Edit, Delete, or Swap.

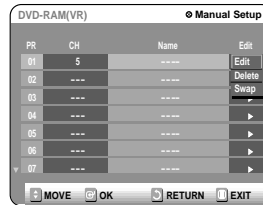

• In case of Edit : you can add or edit PR(program)

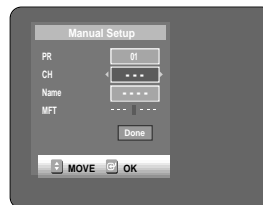

- CH : Tune the channel using ◀▶ buttons or number buttons.
- MFT : You can tune up the channel frequency better using ◀▶ buttons.
- Name : Display station name automatically detected in broadcasting signal. If not detected, you can edit name by using ▼▲▶ buttons.

• In case of Delete : the channel information of selected PR(program) will be removed.

• In case of Swap : You can swap the channel information of two PR(program). For example, if you wish to swap PR2 and PR5, select swap at PR2, then press OK button or ▶ button at PR5.

System Setup

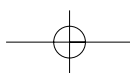
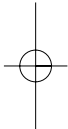

## CM Skip Time Setting

When a program recorded on a DVD-RAM, a DVD-RW, or a DVD-R is played, the unit can be set to automatically skip a portion of the program corresponding to a CM (commercial) Skip Time set by the user. The program can then be played from a point after the CM Skip Time. If the CM Skip button is pressed while a DVD disc is played, an instant skip function is performed for the set CM Skip Time.

**1** With the unit in Stop mode, press the MENU button on the remote control.

**2** Select Setup using the ▲▼ buttons, then press the ► or OK button.

You can't use the Setup functions while playing a disc.

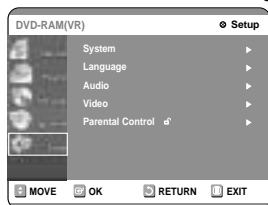

**3** Select System using the ▲▼ buttons, then press the ► or OK button.

System menu will be displayed.

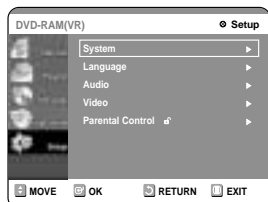

**4** Select CM Skip Time using the ▲▼ buttons, then press the ► or OK button.

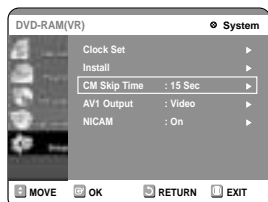

**5** Select the desired time using the ▲▼ buttons, then press the ► or OK button.

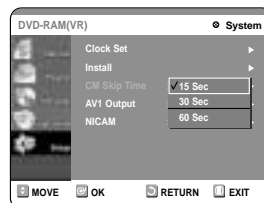

**6** If you press the CM SKIP button, the section corresponding to the set time is skipped, and then the next section is played.



NOTE

- CM Skip can be performed only during normal playback.
- When the time set is less than a remaining time of a current title: The next title is played from the beginning.
- When the time set is less than a remaining time of a play list, the next scene is played.
- CM Skip is not performed with respect to a still picture.
- When a set time is less than a remaining time of a scene, a last title, or a last track that is displayed currently, a prohibition mark appears.
- When the time set is less than the remaining time of the currently displayed track, title or scene, a prohibition mark appears.
- CM Skip releases Repeat (including Repeat A-B, Chapter, and Title).
- This may not operate with some DVD-Video discs.

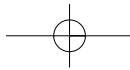

## Setting Up NICAM Options

NICAM programmes are divided into 3 types. NICAM Stereo, NICAM Mono and Bilingual (transmission in another language). NICAM programmes are always accompanied by a standard mono sound broadcast and you can select the desired sound by setting NICAM on or off.

- 1 With the unit in Stop mode, press the MENU button on the remote.
- 2 Select "Setup" using ▼▲ buttons, then press the ► or OK button.

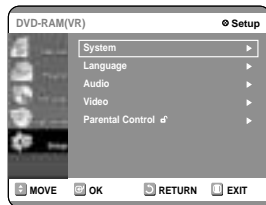

- 3 Using the ▼▲ buttons, move the selection bar to "System" then press ► or OK button to select.

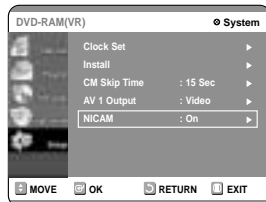

- 4 Using the ▼▲ buttons, move the selection bar to "NICAM" then press ► or OK button to select.

- 5 Using the ▼▲ and OK buttons, select "On" or "Off".
  - Off: Only set at this position to record the standard mono sound during a NICAM broadcast if the stereo sound is distorted due to inferior reception conditions.
  - On: NICAM mode

## Setting Up Scart Jack Options

If you connect external device (VCR/satellite receiver/cable box) or TV to DVD Recorder with Scart Jack(21pin), you need to set this options.

- 1 With the unit in Stop mode, press the MENU button on the remote.
- 2 Select "Setup" using ▼▲ buttons, then press the ► or OK button.
- 3 Using the ▼▲ buttons, move the selection bar to "System" then press ► or OK button to select.

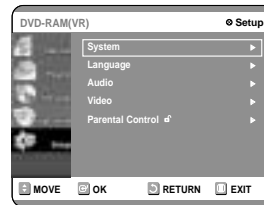

- 4 Using the ▼▲ buttons, move the selection bar to "AV1 Output" then press ► or OK button to select.

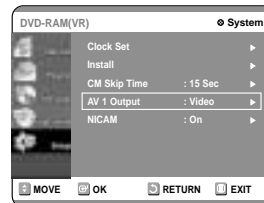

- 5 Using the ▼▲ and OK buttons, select "Video" or "RGB" to suit the AV terminal of TV.
  - AV2 input option will be set automatically according to the signal of external device (VCR/satellite receiver/cable box).

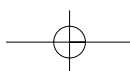
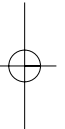

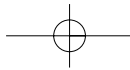

## Setting Up the Language Features

If you set the player menu, disc menu, audio and subtitle language in advance, they will come up automatically every time you watch a movie. If the selected language is not recorded on the disc, the original pre-recorded language is selected.

**1** With the unit in Stop mode, press the MENU button on the remote control.

**2** Select "Setup" using the ▲▼ buttons, then press the ► or OK button.

You can't use the Setup functions during disc playback.

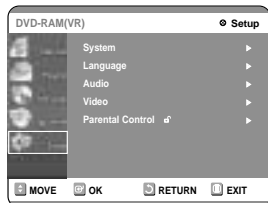

**3** Select "Language" using the ▲▼ buttons, then press the ► or OK button.

Language setup menu will be displayed.

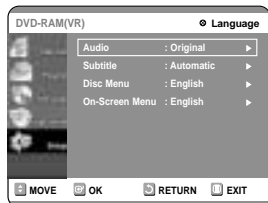
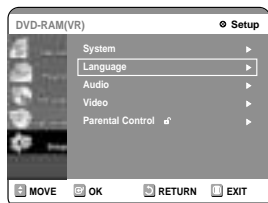

**4** Use the ▲▼ buttons to select the desired sub menu and press the OK or ► button.

- **Audio Language:** For the speaker sound.
- **Subtitle Language:** For the disc subtitles.
- **Disc Menu Language:** For the disc menu contained on the disc
- **On-Screen Menu:** For the on-screen menu of your DVD Recorder

**5** Select the desired Language using the ▲▼ buttons, then press the ► or OK button.

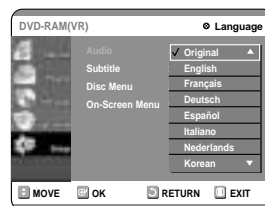

NOTE

- Press the RETURN or ◀ button to return to the previous menu. Press the MENU button to exit the menu.
- The selected language will only appear if it is supported on the disc.

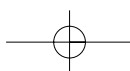

## Setting Up the Audio Options

Allow you to setup the Audio device and sound status depending on the audio system in use.

- 1** With the unit in Stop mode, press the MENU button on the remote.
- 2** Select "Setup" using ▼▲ buttons, then press the ► or OK button.
- 3** Select "Audio" using ▼▲ buttons, then press the ► or OK button. Audio setup menu will be displayed.

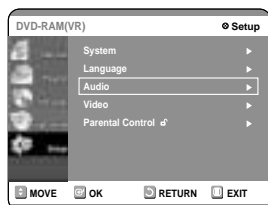

- 4** Use ▼▲ buttons to select the desired sub menu and press the OK or ► button.

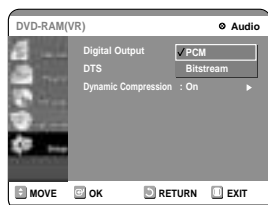

- 5** Use the ▼▲ buttons to select the desired item. Then press the ► or OK button.



NOTE

- Press the RETURN or ◀ button to return to the previous menu. Press the MENU button to exit the menu.

## Audio Options

### Digital Output

1. PCM : Select this when you have no equipment that can decode Dolby Digital (or MPEG-2) signal. When you play Dolby Digital (or MPEG-2) sound track, the digital output are converted to PCM Stereo.
2. Bitstream : Output Dolby Digital (or MPEG-2) audio as bitstream. Select this when your AV receiver or AV amplifier have Dolby Digital (or MPEG-2) Decoder.



NOTE

- Digital output setting is equally applied to both Dolby Digital and MPEG-2 audio. LPCM sound track is always outputted as PCM. It has no relation with Digital Output setting.
- Be sure to select the correct Digital Output or you will hear no sound or loud noise.

### DTS

1. Off : Doesn't output DTS signal. Select this when your AV receiver or AV amplifier does not have DTS decoder.
2. On : Outputs DTS Bitstream via digital output when you play DTS track. Select this only when your AV receiver (or AV amplifier) have DTS decoder.



NOTE

- When DTS soundtrack is played, sound does not output from Analogue Audio Output.

### Dynamic Compression

Dynamic Range Compression : This is only active when a Dolby Digital signal is detected.

- On : When the Movie-soundtracks are played at low volume or from smaller speakers, the system can apply appropriate compression to make low-level content more intelligible and prevent dramatic passages from getting too loud.
- Off : You can enjoy the movie with standard Dynamic Range.



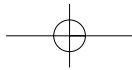

## Setting Up the Display(Video) Options

This function allows you to setup the TV screen settings.

### 1 With the unit in Stop mode, press the MENU button on the remote.

You can't use the Setup functions during playback.

### 2 Select "Setup" using ▼▲ buttons, then press the ► or OK button.

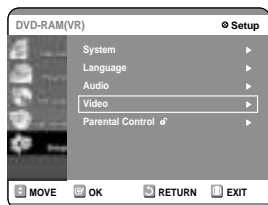

### 3 Select "Video" using ▼▲ buttons, then press the ► or OK button.

Video setup menu will be displayed.

### 4 Use ▼▲ buttons to select the desired sub menu and press the OK or ► button.

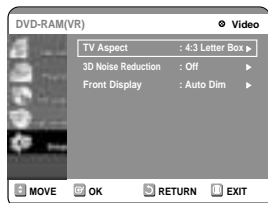

### 5 Use the ▼▲ buttons to select the desired item. Then press the ► or OK button.



NOTE

- Press the RETURN or ◀ button to return to the previous menu. Press the MENU button to exit the menu.

## Display(Video) Options

This function depends on disc type. It may not work for some disc types.

### TV Aspect

Depending on the type of television you have, you may want to adjust the screen setting. (aspect ratio)

- 4:3 Letter Box** : Select when you want to see the total 16:9 ratio screen DVD supplies, even though you have a TV with a 4:3 ratio screen. Black bars will appear at the top and bottom of the screen.
- 4:3 Pan - Scan** : Select this for conventional size TV when you want to see the central portion of the 16:9 screen. (Extreme left and right side of movie picture will be cut off.)
- 16:9 Wide** : You can view the full 16:9 picture on your widescreen TV.

### 3D Noise Reduction (motion adaptive noise reduction)

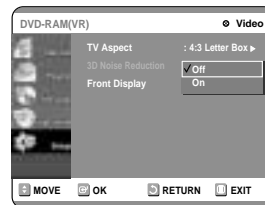

- On : Provides a cleaner picture through noise reduction (for recording).
- Off : Normal

### Front Display

Adjust the brightness of the unit's front panel display.



- Auto Dim : Makes the Front Panel Display dim automatically when playing a DVD.
- Dim : Makes the Front Panel Display dim.
- Bright : Makes the Front Panel Display bright.

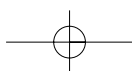

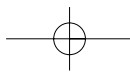

## Setting Up the Parental Control

The Parental Control function works in conjunction with DVDs that have been assigned a rating which helps you control the types of DVDs that your family watches. There are up to 8 rating levels on a disc.



**1** With the unit in Stop mode, press the MENU button on the remote.

**2** Select "Setup" using ▼▲ buttons, then press the ► or OK button.

**3** Select "Parental Control" using ▼▲ buttons, then press the ► or OK button.

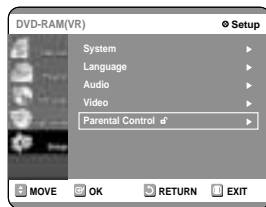

**4** Enter the 4-digit password using the 0 to 9 buttons on the remote.

- The 'Confirm the password.' message will be displayed. Enter your password again.

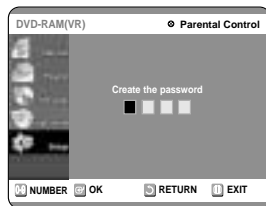

**5** Select "Password On/Off" using ► and ▼▲ buttons.

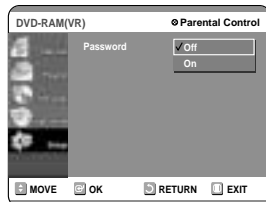

**6** Select "Rating Level" you want using ▼▲ buttons, then press the ► or OK button.

- For example, if you select up to Level 6, discs that contain Level 7, 8 will not play. Larger number indicates the program is more intended to adult use only.

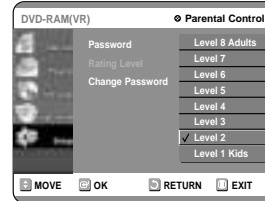

- Press the RETURN or ► button to return to the previous menu. Press the MENU button to exit the menu.
- Refer to Troubleshooting if you forget your password.

### About the Change Password;

**1** Select "Change Password" using ▼▲ buttons, then press the ► or OK button.

- The 'Enter the password.' message will be displayed.

**2** Enter the 4-digit password using the 0 to 9 buttons on the remote.

- The 'Confirm the password.' message will be displayed.

**3** Enter your password again using the 0 to 9 buttons on the remote.



- Press the RETURN or ◀ button to return to the previous menu. Press the MENU button to exit the menu.

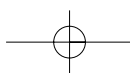

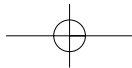

# Recording

This section shows various DVD recording methods.

Recording

- Before Recording .....34
- Recording the current TV program you are watching .....35
- Recording from external equipment you are watching .....38
- Reviewing Images Being Recorded(Time Slip)..39
- Making a One Touch Recording (OTR).....40
- Making a Standard Timer .....41
- Flexible Recording (only for Timer recording) ..42
- Editing a Standard Timer.....42
- Deleting a Timer Recording Entry .....43
- Using the Video Plus+ Feature .....44
- Video Plus+ Extend.....45
- Recording the Scheduled Record List .....46

## Before Recording

This unit can record on various types of discs. Before recording, read the following instructions and select the disc type according to your preference.

### Recordable discs

This recorder can record on the following discs.

DVD-RAM	DVD-RW	DVD-R

- DVD-RWs and DVD-RAMs are rewritable.
- DVD-Rs are non-rewritable

### Compatibility between Samsung Recorder and Other Company's Recorder

Disc Types	Recording format	Recording Device	Finalizing	Additional Recording in Toshiba Recorder
DVD-RAM	VR Mode	Thoshiba	X	Recordable
		Other Company	X	Recordable
DVD-RW	VR Mode	Thoshiba	finalized	Not recordable
			not finalized	Recordable
	Other Company	finalized	Not recordable	
		not finalized	Recordable	
DVD-R	V Mode	Thoshiba	finalized	Not recordable
			not finalized	Recordable
	Other Company	finalized	Not recordable	
		not finalized	Not recordable	
DVD-R	V Mode	Thoshiba	finalized	Not recordable
			not finalized	Recordable
	Other Company	finalized	Not recordable	
		not finalized	Not recordable	



- Finalise
  - This closes the DVD-R/RW so no additional recording can be done.
- Unfinalise
  - This allows additional recording on a finalised DVD-RW disc.
  - A DVD-RW disc that has been recorded by DAO (Disc At Once) mode in a PC cannot be unfinalised.
  - A DVD-RW disc that has been recorded in Video Mode of a different maker's recorder cannot be unfinalised.
  - A DVD-R disc cannot be unfinalised.

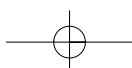

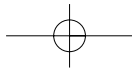

## Recording Formats

When you insert an unused disc, the following message appears; Since available functions differ depending on the disc type, select a disc that best fits your preferences.

DVD-RAM: Use after formatting the disc.



DVD-RW: When a blank disc is first inserted, the message "Do you want to initialize this disc?" will appear. When YES is selected, the mode will be formatted in VR Mode.



If you want to format in either VR Mode or Video Mode, refer to Formatting a Disc on page 82.



DVD-R: Formatting DVD is unnecessary and only Video Mode Recording is supported

### DVD-RW( Video mode)-R

- This mode automatically creates chapters at specified intervals during finalization.
- Simple editing (erasing titles/changing title name)

### DVD-RW(VR mode)-RAM

- This mode allows multiple editing functions (such as deletion of the whole of a title, partial deletion of a title, etc.)
- Various editing options using a created Playlist

## Recording Mode

Select one of four recording modes by pressing the REC MODE button repeatedly while the unit is in Stop mode for the desired recording time and picture quality. In general, picture quality improves as the recording time decreases.

In FR Mode, picture quality is adjusted automatically so that all images for the scheduled time can be recorded onto the free disc space.

Mode	Characteristic	Recording Times Data Rates
XP (high quality mode)	Select when the video quality is important.	Approx. 1 hour about 8 Mbps
SP (standard quality mode)	Select to record in standard quality.	Approx. 2 hours about 4 Mbps
LP (long recording mode)	Select when a long recording time is required.	Approx. 4 hours about 2 Mbps
EP (extended mode)	Select when a longer recording time is required.	Approx. 6 hours about 1.2 Mbps
FR (Flexible Recording)	for timer recording only see page 42.	Approx. 1 to 6 hours about 1.2 to 8 Mbps

## Unrecordable pictures

Pictures with copy protection cannot be recorded on this DVD Recorder. When the DVD Recorder receives a copy guard signal while recording, recording stops and the following message appears on the screen.

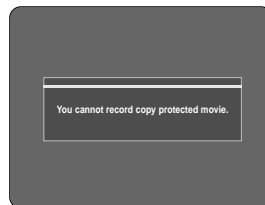

## Concerning Copy Control Signals

Broadcasts that contain copy control signals may have one of the following three signal types, COPY-Free, Copy-Once and Copy-Never. If you want to record a copy-once type program, use DVD-RW with CPRM in VR Mode and DVD-RAM.

	Copy-Free	Copy-Once	Copy-Never
DVD-RW(Ver.1.1)	0	-	
DVD-RW(Ver.1.1) with CPRM			
VR mode	0	0*	
Video mode	0	-	
DVD-R	0	-	
DVD-RAM (Ver. 2.0)	0	0*	

Once "Copy Once" has been recorded, additional recording cannot be performed.

This \* marked parts are compatible with CPRM.

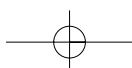
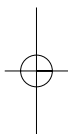
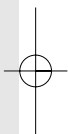
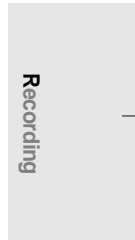

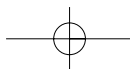

## About DISPLAY Key

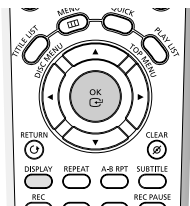

The DISPLAY function allows you to view the current status and progress of playback and recording. Depending on the kind of disc and status, the displayed screen may be different.

## Checking the available disc space (Disc Information)

When recording on an used disc, make sure that there is enough disc space for recording. With DVD-RWs or DVD-RAMs, you can free up disc space by erasing titles.

- Press the DISPLAY button.  
The disc information display window appears.  
Items in the display differ depending on the disc type or recording format.

DVD-RAM(VR)	Disc Name	Disc Info
1	2	3
4	Total Title	11
5	Total Playlist	None
6	Recordable Time	01:48 SP
7	Protection	Not Protected
8	Main Screen	PR 1 (Mono)
	PIP Screen	--
	01 JAN 2004 THU	12:00
		9

1. Disc Type
2. Current information display status
3. Disc Name
4. Total Titles : Total number of titles
5. Total Playlist : Total number of Playlists
6. Recordable Time : The longest continuous recording time in each of the recording modes(approximate)
7. Main picture window: the name of the program in the main picture
8. PIP window: the name of the program in the PIP window
9. Date : Current date and time

## Recording the current TV program you are watching



### Before you start

Check that the disc has enough available space for the recording. Adjust the recording picture quality mode.

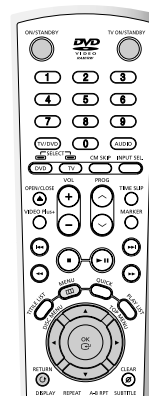

**1** Press the OPEN/CLOSE button and place a recordable disc on the disc tray.

**2** Press the OPEN/CLOSE button to close the disc tray.

Wait until "LOADING" disappears from the front panel display.

If an unused DVD-RAM disc is used, whether to format or not will be asked first. Make your selection, then press OK.(See page 35)

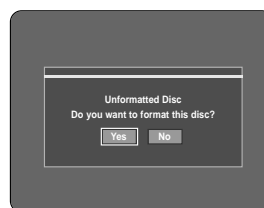

If an unused DVD-RW disc is used, whether to initialize or not will be asked first. Make your selection, then press OK.(See page 35)



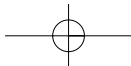

**3** Press the **PROG** (⊖/⊕) or number (Ⓜ~Ⓢ) buttons to select the current program you want to record.

**4** Press the **REC MODE** button repeatedly, (or Press the **REC MODE** button and then press the **▲▼** button) to select the recording speed(quality).

→ SP → LP → EP → XP



**5** Press the **REC** button. Information concerning the channel is displayed on the screen and then recording begins.



To view the current status of the disc and progress of recording : Press the **DISPLAY** button, and the information about the disc will appear.

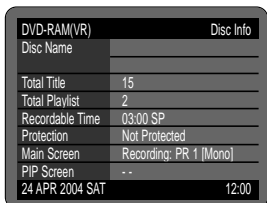

Press the **DISPLAY** button once again. Then you can check the information about the title under recording.

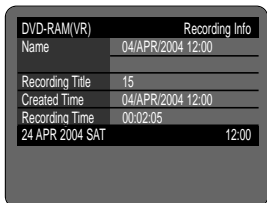

**To pause recording**

Press the **REC PAUSE** button to pause a recording in progress.

- Press the **REC PAUSE** button again to resume recording.
- You can switch channels by pressing the **PROG** (⊖/⊕) buttons while recording pauses.

**To stop recording**

Press the **STOP** (⊘) button to stop or finish a recording in progress.

- When using DVD-RAM/DVD-RW/DVD-R discs, the message 'Updating the information of disc. Please wait for a moment' is displayed.

**NOTE**

- You can not change the recording mode and the **PROG** while recording.
- Recording will stop automatically if there is no free space left for recording.
- Up to 99 titles can be recorded onto a disc.
- Recording will stop automatically if a copy protected image is selected.
- DVD-RAM/DVD-RW discs must be formatted before starting to record. Most new discs are sold unformatted.
- Do not use DVD-R authoring discs with this unit.

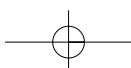
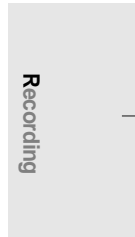

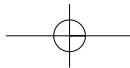

## Recording from external equipment you are watching



### Before you start

Check that the disc has enough available space for the recording. Adjust the recording mode.

#### 1 Press the OPEN/CLOSE button, and place a recordable disc on the disc tray.

#### 2 Press the OPEN/CLOSE button to close the disc tray.

Wait until "LOADING" disappears from the front panel display.

If an unused DVD-RAM disc is used, whether to format or not will be asked first. (See page 35)

If an unused DVD-RW disc is used, whether to initialize or not will be asked first. (See page 35)

#### 3 Press the INPUT button to select the input source according to the connection you made.

The front panel display changes in the following sequence:

PROG Number → AV1 → AV2 → AV3 → AV4 → DV

If you connect a digital camcorder, press the INPUT button to select DV.

#### 4 Press the REC MODE button repeatedly, (or Press the REC MODE button and then press the ▲▼ button) to select the recording speed(quality).

SP → LP → EP → XP



#### 5 Press the REC button.

##### To pause recording

Press the REC PAUSE button to pause a recording in progress.

- Press the REC PAUSE button again to resume recording.
- You can switch channels by pressing the **PROG** (⊙/⊙) buttons while recording pauses.

##### To stop recording

Press the STOP (⊙) button to stop or finish a recording in progress.

- When using DVD-RAM/DVD-RW/DVD-R discs, the message 'Updating the information of disc. Please wait for a moment' is displayed.



NOTE

- You can not change the recording mode and input source while recording.
- Recording will stop automatically if there is no free space left for recording.
- Up to 99 titles can be recorded onto a disc.
- Recording will stop automatically if a copy protected image is selected.
- DVD-RAM/DVD-RW discs must be formatted before starting to record. Most new discs are sold unformatted.
- Do not use DVD-R authoring discs with this unit.

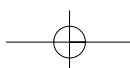

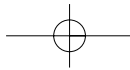

## Reviewing Images Being Recorded (Time Slip)



This function lets you watch recently recorded 10-second images on the PIP screen while a recording is in progress.

### 1 Press the TIME SLIP button during DVD-RAM recording.

The time slip lamp on your DVD Recorder lights. The recently recorded 10-second images are played back on the PIP screen.



- The Time Slip function allows you to view a recorded program through the PIP window at least 10 seconds after recording starts. Playback and recording can be done at the same time.
- During the operation of Time Slip, playback related buttons control the PIP window.
- On the time slip screen, you can play, scan, or perform other operations for the recorded program using the playback related buttons.
  - Press the ⏮ button to scan the recording in reverse order, from end to the start.
  - Press the ⏪ button to scan recently recorded 10-second images.

When the DISPLAY button is pressed, current information about the disc will appear.

DVD-RAM(VR)		Disc Info
Disc Name		
Total Title	15	
Total Playlist	2	
Recordable Time	03:00 SP	
Protection	Not Protected	
Main Screen	Recording: PR 1 (Mono)	
PIP Screen	Playback	
24 APR 2004 SAT		12:00

When the DISPLAY button is pressed again: Information about playback will appear.

DVD-RAM(VR)		Playing Info
Name	04/APR/2004 12:00	
	PR7	
Title	15/16	
Created Time	04/APR/2004 12:00	
Length	--:--:--	
Playing Time	00:02:05	
Title Protection	Not Protected	
24 APR 2004 SAT		12:00

When the DISPLAY button is pressed once again: Information about recording will appear.

DVD-RAM(VR)		Recording Info
Name	04/APR/2004 12:00	
Recording Title	15	
Created Time	04/APR/2004 12:00	
Recording Time	00:02:05	
24 APR 2004 SAT		12:00

### 2 Press the STOP button to clear the time slip function.

To stop a recording while the Time Slip function is in process, press the STOP button twice. The first press will stop playback of the Time Slip function. The second press will stop recording.



NOTE

- The Time Slip function operates only with DVD-RAM.
- The Time Slip function is not supported in the DV recording mode.

Recording

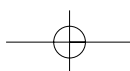



## Making a One Touch Recording (OTR)



You can set the DVD Recorder to record in 30-minute increments by pressing the REC button.

- 1** If you want to record a TV channel, use the PROG (⊖/⊕) buttons or number buttons to select a desired channel.  
If you want to record through a connected external component, press the INPUT button to select an appropriate external input (AV1, AV2, AV3, AV4 or DV).

- TV PROGRAM: 1 to 99

- 2** Press the REC button, and then press the button once again during recording. "OTR" appears on the front panel display.



- 3** Press the REC button to adjust the recording time.

0:30 → 1:00 → ...5:30 → 6:00 → 0:00



NOTE

- The timer counter decreases minute 6:00 to 0:00, then the DVD Recorder stops recording.

To view the current status of the disc and progress of recording : Press the DISPLAY button, and the information about the disc will appear.

DVD-RAM(VR)		Disc Info
Disc Name		
Total Title	15	
Total Playlist	2	
Recordable Time	03:00 SP	
Protection	Not Protected	
Main Screen	Recording: PR 1 [Mono]	
PIP Screen	--	
24 APR 2004 SAT	12:00	

Press the DISPLAY button once again. Then you can check the information about the title under recording.

DVD-RAM(VR)		Recording Info
Name	04/APR/2004 12:00	
Recording Title	15	
Created Time	04/APR/2004 12:00	
Recording Time	00:02:05	
24 APR 2004 SAT	12:00	

30 seconds before the recording is done, the message, which asks whether you want the recorder to power off when the recording is done, will appear on your screen.

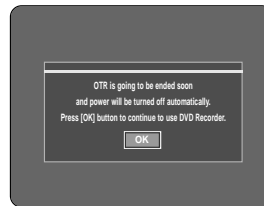

### To stop recording

Press the STOP (⊖) button. The message "Do you want to stop recording?" is displayed.



- Press the ◀▶ buttons to select Yes, and then press the OK button.

## Making a Standard Timer

### Before you start

1. Check the antenna cable is connected.
  2. Check the remaining time of the disc.
  3. Check the date and time are correct.
- Make sure the Clock has been set (Setup - System Setting) before you proceed with a timer recording.

### 1 Press the MENU button.

### 2 Press the ▼▲ buttons to select "Programme" and then press the OK or ► button.

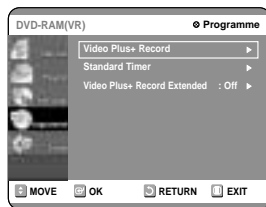

### 3 Press the ▼▲ buttons to select "Standard Timer" and then press the OK or ► button.

### 4 Press the ▼▲ buttons to select "Scheduled Record List", and then press the OK or ► button.

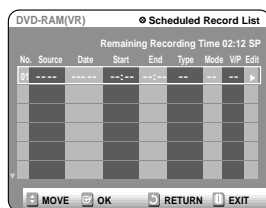

### 5 Set timer recording option.

- The Timer Recording screen is displayed. Fill the input items using the arrow buttons and number buttons.
  - ◀▶ : Moves to the previous/next item,
  - ▲▼ : Sets a value.
- **Source** : The video input source (AV1, AV2, AV3 AV4 or DV), or the broadcasting channel you want to make a timer recording from.
- **Date** : Set the recording day. (day/month)
- **Start/End Time** : Start and end time of the timer recording.
- **Type** (Recording cycle).
  - Once : Records once.
  - Weekly : Records at a set time every week.
  - Daily : Records at a set time every day.
- **V/P** : VPS(Video Programme System) or PDC(Programme Delivery Control) function.

- If you set this function on, you can control the starting and ending time of recording by special signal included in the broadcasting signal. If a TV programme is shortened or starts earlier or later than scheduled, this function synchronizes the starting and ending time of recording with the actual broadcasting time automatically.
- Set up the start-time EXACTLY according to the published TV schedule. Otherwise the timer recording will not take place.
- Do not select PDC or VPS unless you are sure the programme you wish to record is broadcast with PDC or VPS.

### Mode (Recording Mode)

- FR : Select when you want to set video quality automatically. It depends on the remaining time on the DVD.
- XP (high quality) : Select when video quality is important. (Approx. 1 hour)
- SP (standard quality) : Select to record in standard quality. (Approx. 2 hours)
- LP (low quality) : Select when a long recording time is required. (Approx. 4 hours)
- EP (extended mode) : Select when a longer recording time is required. (Approx. 6 hours about 1.2 Mbps)

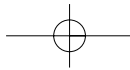

## 6 Press the OK button.

- will appear on the front panel. It means that a timer recording is registered.

### If you make a mistake

Press the ◀▶ button to select the item you want to change.

### If the timer settings overlap

The programs are recorded in order of priority. If timer recording is set for the first program and then again for the second program and both programs overlap, the following message will appear on the screen: "This setting is identical with 1". The message shows that the first program has priority. After recording of the first program is complete, the second program starts being recorded.

### To exit without saving the current setting

Press the MENU button.

### To return to the previous menu

Press the RETURN button if you don't want to set a timer recording.

## 7 Turn the power off to finish the Timer Recording setting. Timer Recording will not work when the power is on.

- will blink if disc is not inserted.



NOTE

- The timer recording time may differ from the set time depending on disc status and overall timer recording status (for example, recording times overlapping, or when the previous recording ends within 2 minutes before the start time of the next recording.)
- You can make the Timer Recording up to 12 programmes.

## Flexible Recording (for Timer recording only)



In FR mode, the timer recording's the video quality is adjusted automatically so that all images for the scheduled time can be recorded onto the free disc space.

The FR mode recording setup is the same as Timer Recording. When setting the mode in step5, set FR mode.

## Editing a Standard Timer



Follow these directions to edit the timer record list.

### 1 Press the MENU button.

### 2 Press the ▼▲ buttons to select "Programme" and then press the OK or ▶ button.

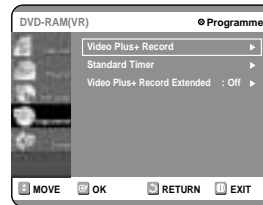

### 3 Press the ▼▲ buttons to select "Standard Timer", and then press the OK or ▶ button.

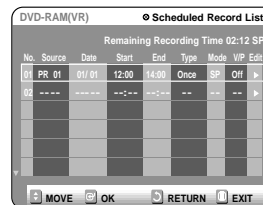

### 4 Press the ▼▲ buttons to select the number of the timer recording you want to edit, and then press the OK or ▶ button.

- The Edit and Delete items are displayed.



## 5 Press the ▼▲ buttons to select 'Edit', and then press the OK button.

- The Timer Recording screen is displayed.  
Edit the items you want to modify.  
See the "Making a Standard Timer" section for more information on Timer Recording Input items.

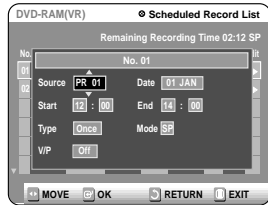

## 6 Press the OK button to confirm the edited setting.

## Deleting a Standard Timer



Follow these directions to delete an entry from the timer record list.

## 1 Press the MENU button.

## 2 Press the ▼▲ buttons to select "Programme" and then press the OK or ► button.

## 3 Press the ▼▲ buttons to select "Standard Timer", and then press the OK or ► button.

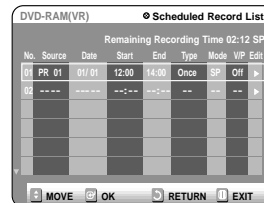

## 4 Press the ▼▲ buttons to select the number of the timer recording you want to delete, and then press the OK button.

- The Edit and Delete items are displayed.



## 5 Press the ▼▲ buttons to select "Delete", and then press the OK button.

- You will be prompted with the delete confirm message such as 'Do you want to delete No.02?'.

## 6 Press the ◀▶ buttons to select "Yes", and then press the OK button.

- The selected entry will be deleted from the list.

## 7 Press the MENU button after finishing the operation. The menu screen will disappear.

## Using the Video Plus+ Feature

Before presetting your DVD Recorder:

- Switch on both the television and your DVD Recorder.
  - Check that the date and time are correct.
- Up to twelve programmes can be preset.

### 1 Press the Video Plus+ button.

- A message is displayed to allow you to enter the Video Plus+ code.

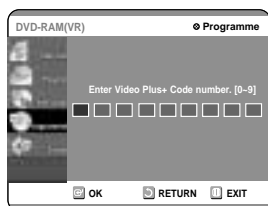

### Using the MENU button.

- Press the MENU button when the disc has stopped.
- Press the ▲▼ buttons to select "Programme", and then press the OK or ► button twice.

### 2 Press the numeric buttons to enter the code of the programme that you wish to record in your television magazine.

- If you wish to correct the Video Plus+ code that you are entering:
- Press the ◀ button until the digit to be corrected is cleared
- Enter the correct digit

### 3 Press the OK button.

- The information concerning the programme is displayed.
- When using the Video Plus+ function for the first time with stored stations, the programme number flashes. This one time, you must enter the PR number manually by pressing the ▼▲ buttons.

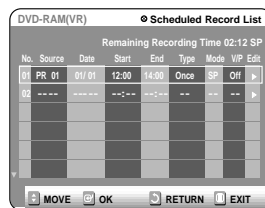
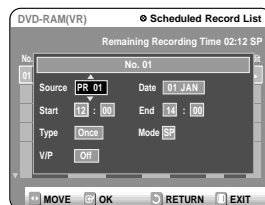

### 4 If the programme and times are correct, press the OK button.

### 5 Turn the power off by pressing the STANDBY/ON button to activate the Timer Recording setting.

### 6 Refer to page 41~43 if you wish to:

- Check whether the timer Recording has set correctly or not.
- Cancel a preset recording



NOTE

- The numbers next to each TV programme listing in the magazines or newspapers are Video Plus+ code numbers, which allow you to programme your video-recorder instantly with the remote control. Enter the Video Plus+ code for the programme you wish to record.
- Video Plus+ is a trademark of Gemstar Development Corporation. The Video Plus+ system is manufactured under licence from Gemstar Development Corporation.

## Video Plus+ Extended

To prevent delays or overruns, DVD Recorder has a function called Video Plus+ Extended allowing you to extend the recording time by up to 60 minutes.

**1** Press the MENU button in Stop Mode.

**2** Press the ▼▲ buttons to select “Programme” and then press the OK or ► button.

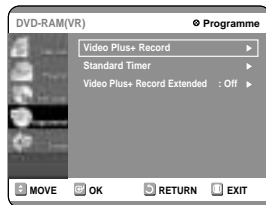

**3** Press the ▼▲ buttons to select “Video Plus+ Record Extended”.

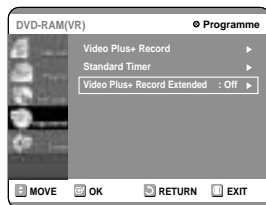

**4** Press the OK or ► button to set the “Video Plus+ Record Extended” time by increments of 10 minutes.

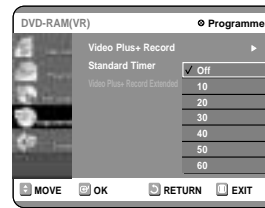

**5** Press the MENU button after finishing the operation.

Recording

## Recording the Standard Timer List

When the start time in the Scheduled record list reaches while the set is in power off, the set will be powered on and start the recording automatically.

### 1 When the scheduled recording is operating, the programme being recorded will not display on TV.

- Press TV/DVD button if you want to see the programmed being recorded on TV.
- Press TV/DVD button again if you don't want to see the programmed being recorded on TV.

### To stop Recording

Press the STOP(⊖) button, and the message that asks whether to end recording or not will be displayed.



- When "Yes" is selected: Recording stops
- When "No" is selected: Recording continues



NOTE

- If disc space lacks or a signal for the prevention of copy is received during recording, recording will stop.

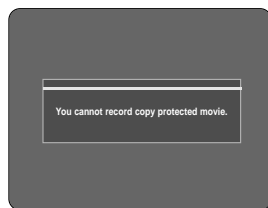

- If there is no free disc space even though the start time arrives or the disc is not recordable, recording will not operate. (You can record after replacing the disc.)

# Playback

This section introduces basic functions of playback and playback by disc type.



Dolby Digital



DTS



Digital Audio



Stereo



PAL broadcast system in U.K, France, Germany, etc.



MP3

Before Playing .....47  
 Playing a Disc .....48  
 Playing an Audio CD/MP3 .....59  
 Playing a Picture CD .....62  
 Playing the Title List .....63

## Before Playing





Read the following information before playing a disc.

### Region code (DVD-Video only)



Both the DVD recorder and the discs are coded by region. These regional codes must match in order for the disc to play. If the codes do not match, the disc will not play. The Region Number for this recorder is described on the rear panel of the recorder.

### Disc types that can be played

Disc Types	Disc Logo	Recorded content	Disc Shape	Max. Playing Time
DVD-VIDEO		AUDIO + VIDEO	Single sided(12cm)	240
			Double sided(12cm)	480
			Single sided(8cm)	80
			Double sided(8cm)	160
AUDIO-CD		AUDIO	Single sided(12cm)	74
			Single sided(8cm)	20
JPEG CD-R/RW		JPEG Images	Single sided(12cm)	-
MP3 CD-R/RW		MP3 Audio	Single sided(12cm)	-
			Single sided(8cm)	-
DVD-RAM		AUDIO + VIDEO	Single-sided(12cm)	1 (XP: Excellent Quality)
				2 (SP: Standard Quality)
			Double-sided(12cm)	4 (LP: Long Playback)
				6 (EP: Extended)
DVD-RW		AUDIO + VIDEO	12cm (4.7GB)	1 (XP: Excellent Quality)
				2 (SP: Standard Quality)
				4 (LP: Long Playback)
				6 (EP: Extended)
DVD-R		AUDIO + VIDEO	12cm (4.7GB)	1 (XP: Excellent Quality)
				2 (SP: Standard Quality)
				4 (LP: Long Playback)
				6 (EP: Extended)

### Discs that cannot be played

- DVD-Video with a region number other than "2" or "ALL"
- 12cm 2.6 GB and 5.2 GB DVD-RAM
- 3.9 GB DVD-R Disc for Authoring.
- DVD-RAM, DVD-RW(VR mode) not recorded following the Video Recording Standard
- Unfinalised DVD-R,unfinalised DVD-RW(V mode) recorded on other equipment.
- DVD-ROM/DVD+RW/PD/MV-Disc/DivX Video Disc, etc
- CVD/SVCD/CD-ROM/CDV/CD-G/CD-I

Playback



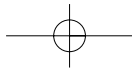

NOTE

- This DVD recorder can only operate with discs that are compatible with DVD-RAM Standard Version 2.0.
- Playback and/or recording may not work for some types of discs, or when specific operations, such as aspect ratio adjustment, are being performed. Information about the discs is written in detail on the box. Please refer to this if necessary.
- Do not allow the disc to become dirty or scratched. Fingerprints, dirt, dust, scratches or deposits of cigarette smoke on the recording surface may make it impossible to use the disc for recording.
- To protect a DVD-RAM/RW/R disc, from damage, use a cartridge.
- DVD-RAM/RW/R discs may not be able to play on some DVD players, depending on the player, disc and the condition of the recording.

## 2 Place a disc gently into the tray with the disc's label facing up.

For DVD-RAM discs, insert the printed side facing up.

## 3 Press the OPEN/CLOSE button to close the disc tray.

- Your DVD Recorder closes the disc tray and plays the disc automatically.
- The recorder does not play discs automatically after the initial power on.
- When the recorder is powered on and a disc is in the tray, the unit will be activated and wait in stop status.
- Press PLAY button to start playback.
- If you insert a MP3 Disc, your DVD Recorder will display the file list on the screen and start playing.
- When a JPEG disc is inserted, folders and a file list are displayed.
- To play automatically at the initial power on, power on with PLAY button. Since then, the disc plays automatically when you open and close the disc tray.

## 4 Press the STOP button to stop playback.

### Playing a Disc

Playback

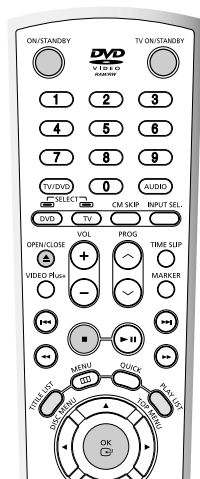

## 1 Press the OPEN/CLOSE button.

The tray opens.



NOTE

- When you stop playing disc, the recorder remembers where you stopped. So when you press PLAY button again, it will pick up where you left off. (unless the disc is removed or the recorder is unplugged, or if you press the STOP button twice.) This function is only applicable to DVD-VIDEO, DVD-RAM, DVD-RW, DVD-R or audio CDs (CD-DA).



CAUTION

- Do not move your DVD Recorder while playing, as this may cause damage to the disc.
- Make sure to press the OPEN/CLOSE button to open or close the disc tray.
- Do not push the disc tray while it is being opened or closed, as this may cause a product malfunction.
- Do not place foreign materials on or in the disc tray.
- Some functions may perform differently or be disabled depending on the disc type. If this occurs, refer to the instructions written on the disc case.
- Be especially careful that children's fingers are not caught between the disc tray and the tray chassis when it closes.

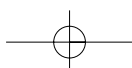

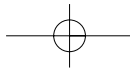

## Using the Disc & Title Menu

Some type of discs contain a dedicated menu system that allows you to select special functions for the title, such as chapters, audio tracks, subtitles, film previews, information on characters, etc.

For DVD-VIDEO discs



### 1 Press the DISC MENU button to enter the disc menu of the disc.

- Move to the setup menu related to the playback operation.
- You can select the audio languages and the subtitles provided by the disc.

### 2 Press the TITLE MENU button to move to the title menu of the disc.

- Use this button if the disc contains more than one title. Some type of discs may not support the title menu function.

For DVD-RAM/RW/R discs



### 1 Press the TITLE LIST button to move to the Title List.



- **Title List:** Title refers to a recorded video stream. Title List shows a list to help you select a title. Since the title list consists of the information on stream that is actually recorded, if one title is deleted, that title cannot be played again.
- **Play List:** This refers to a unit of playback, which is made by selecting a desired scene in the entire Title List. When one playlist is played, only the scene selected by the user will play and then stop. Since only the information necessary for playing a desired scene is included in a playlist, even if that playlist is deleted, the original stream will not be

## Using the Search Functions

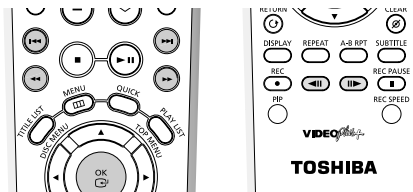

### Searching through a Chapter or Track



### 1 During play, press the SEARCH (↶↷) button on the remote control.

DVD-VIDEO/ DVD-RAM/ DVD-RW/DVD-R	▶▶ Fast X 2 → ▶▶ Fast X 4 → ▶▶ Fast X 8 → ▶▶ Fast X 16 → ▶▶ Fast X 32 → ▶▶ Fast X 128
AUDIO CD(CDDA)	▶▶ Fast X 2 → ▶▶ Fast X 4 → ▶▶ Fast X 8

- You can scan the program in reverse.  
To return to normal speed playback, press the ⏪ button.
- When you press and hold the SEARCH button (↶↷), playback is done at the default speed of 4X. If you release the SEARCH button, playback is performed at a normal speed.
- The speed marked in this function may be different from the actual speed of playback.



- No sound is heard during Scan(Search) mode.

Playback

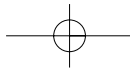

## Skipping Chapters or Tracks

- During play, you can search quickly through a chapter or track.

**1** During play, press the **SKIP** ( ) button on the remote control.

- If you press the **I◀◀** button, it moves to the beginning of the chapter or track or marker(DVD-RAM, DVD-RW(VR mode)). Pressing the button once again within 3 seconds returns to the beginning of the previous chapter or track or marker(DVD-RAM, DVD-RW(VR mode)).
- If you press the **▶▶I** button, it moves to the next chapter or track or marker (DVD-RAM,DVD-RW(VR mode)).

## Slow Motion Play



**1** In pause or step mode, press the **SEARCH** ( ) button on the remote control.

- If you press the **▶▶** button,   
▶ Slow 1/8 → ▶ Slow 1/4 → ▶ Slow 1/2
- If you press the **◀◀** button,   
◀ Slow 1/8 → ◀ Slow 1/4 → ◀ Slow 1/2
- To return to normal speed playback, press the **⊙** button.

Press and hold the **SEARCH** ( ) button during pause, and the disc will play slowly at a 1/4 speed. If the button is released, the pause operation will resume.



- The speed marked in this function may be different from the actual speed of playback.

## Step Motion Play



**1** Press the **◀▶** button on the remote control.

- Each time the button is pressed, a new frame will appear.   
When **◀▶** is pressed, the previous frame will be activated.   
When **▶▶** is pressed, the next frame will be activated.
- To return to normal speed playback, press the **⊙** button.

## About QUICK

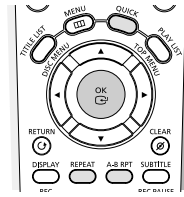

The QUICK function allows you to easily search for a desired scene by accessing title, chapter, track, and time. You can also change the subtitle and audio settings and set some features including Repeat, Angle, and Zoom.

### Moving to a scene directly using QUICK

- If you want to move to a title, a chapter or a track to find a desired scene.

**1** Press the **QUICK** button during playback.



**2** Press the **▲▼** buttons to select the "Title, Chapter or Track".



**3** Press the **◀▶** buttons or numerical (0~9) buttons to select the desired scene. Then, press the **OK** button.

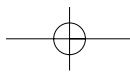

- If you want to move to a desired time to help you find a scene.

**1** Press the **QUICK** button during playback.

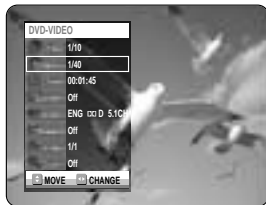

**2** Press the **▲▼** buttons to select the "Time".



**3** Enter the time in the sequence of hours, minutes, and seconds using the number buttons and then press the **OK** button.



- This may not work for some discs. When an audio CD(CD-DA) or a MP3 disc is inserted, according to a disc type, the information display may not be appear.
- The Time Search function does not operate in some discs.
- To make the screen disappear, press the **QUICK** again

**Using the Repeat Function**

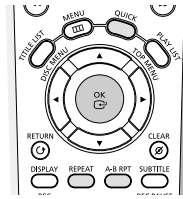

**Playing Repeatedly(Repeat Playback)**



**Using the REPEAT button**

**1** Press the **REPEAT** button.

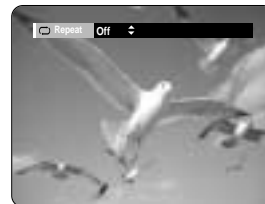

**2** Press the **REPEAT** button or press the **▲▼** buttons to select the "Title or Chapter" you want to play repeatedly. Press the **OK** button.

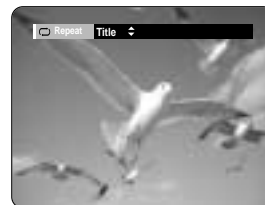

Chapter : Repeats the chapter that is playing.  
 Title : Repeats the title that is playing.

**- To return to normal playback -**

**3** Press the **▲▼** buttons to select "Off" and press the **OK** button or press the **REPEAT** button.

Press the **CANCEL** button to return to normal playback.

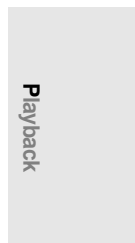

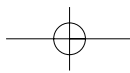

## Using the QUICK button

**1** Press the QUICK button.



**2** Press the ▲▼ buttons to select “Repeat” and press the ◀▶ buttons to select the “Title or Chapter” you want to play repeatedly.



**3** Press the OK button. To make the screen disappear, press the QUICK or RETURN button. Repeat play allows you to repeat a title or chapter.



NOTE

- DVD-RAM, DVD-RW(VR mode), unfinalised DVD-R and unfinalised DVD-RW (Video mode) do not repeat a chapter.

Playback

### Playing Repeatedly(Repeat Playback)



#### Using the REPEAT button



**1** Press the REPEAT button.

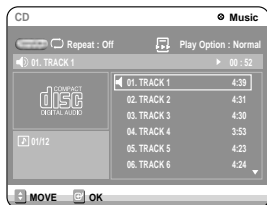

**2** Press the REPEAT button repeatedly to select the “Track or Disc” you want to play repeatedly.



To return to normal playback

**3** Press the REPEAT button repeatedly to select “Off”. Press the CANCEL button to return to normal playback.

## Using the QUICK button

**1** Press the QUICK button. Repeat is highlighted.



**2** Press the OK button.

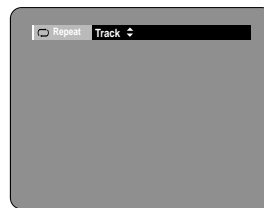

**3** Press the REPEAT button or ▲▼ buttons to select the “Track or Disc” you want to play repeatedly. Press the OK button. For MP3 discs, you can select “Track, Folder or Disc”.

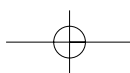

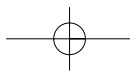

- To return to normal playback -

- 4 Press the REPEAT button repeatedly to select "Off".  
Press the CANCEL button to return to normal playback.

- To return to normal playback -

- 4 Press the REPEAT(A-B) button repeatedly to select "Off".

Playing a Certain section Repeatedly(A-B Repeat Playback)



Using the REPEAT A-B button

- 1 Press the REPEAT A-B button.



- 2 Press the REPEAT A-B button repeatedly to set start point A.



- 3 Press the OK button again to set end point B.  
Repeat playback of the A-B section starts.



Using the QUICK button

- 1 Press the QUICK button.



- 2 Press the ▲▼ buttons to select "Repeat" and press the ► button to select the "A-B".



- 3 Press the OK button.

- 4 Press the OK or REPEAT A-B button at the point where you want the repeat play to start (A) and press it again at the point where you want the repeat play to stop (B).  
Repeat playback of the A-B section starts.

- To return to normal playback -

Select "Off" on the Repeat item.  
Press the CANCEL button to return to normal playback.



- If you set point (B) before five seconds has lapsed, the prohibition mark (⊘) will appear.
- CDs do not support the Repeat A-B function.

Playback

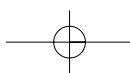
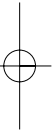
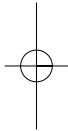

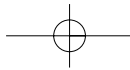

## Selecting the Subtitle

Subtitle languages may not work depending on the disc type. This is only available during playback.



### Using the SUBTITLE button

- 1 Press the SUBTITLE button during playback.



- 2 Press the SUBTITLE button or ▲▼ buttons to select the desired subtitle language.

## Selecting the Audio language

Audio languages may not work depending on the disc type. This is only available during playback.



### Using the AUDIO button

- 1 Press the AUDIO button during playback.



- 2 Press the AUDIO button or ▲▼ buttons to select the desired audio language.

## Using the QUICK button

- 1 Press the QUICK button during playback.

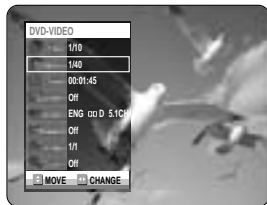

- 2 Press the ▲▼ buttons to select "Subtitle" and press the ◀▶ buttons to select the desired subtitle language.



NOTE

- The subtitle display may be different depending on the disc type.
- If the subtitles overlap, disable the caption function on your TV.
- Some discs allow you to select the language for the disc menu only.

## Using the QUICK button

- 1 Press the QUICK button during playback.



- 2 Press the ▲▼ buttons to select "Audio" and press the ◀▶ buttons to select the desired audio language.



NOTE

- Audio languages may be different because they are disc-specific.
- Some discs allow you to select the audio language for the disc menu only.

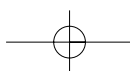

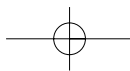

## Changing the Camera Angle

When a DVD-VIDEO contains multiple angles of a particular scene, you can select the Angle function. This is only available during playback.



**1** Press the QUICK button during playback.



**2** Press the ▲▼ buttons to select “Angle” and press the ◀▶ buttons or number buttons to select the desired angle.



NOTE

- This function is disc-dependent, and may not work on all DVDs.
- This function does not work when a DVD has not been recorded with a multi-camera angle system.

## Zooming-In



**1** Press the QUICK button during playback or pause.



**2** Press the ▲▼ buttons to select “Zoom”, and then press the OK button. (Ⓚ) will be displayed.



**3** Press the ▲▼◀▶ buttons to move to the area you want to enlarge.

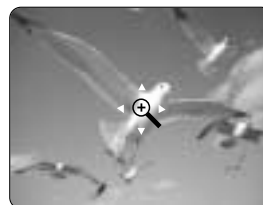

**4** Press the OK button. The screen will be enlarged to twice the normal size.

If you press the OK button again after the screen was enlarged to twice the normal size, the screen size will be enlarged to four times the normal size.

normal size → 2X → 4X → 2X



NOTE

- When recording is done in the EP mode, the Zoom function will not be supported.

Playback



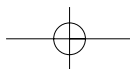

## Using PIP(Picture in Picture)

The PIP function allows you to view a sub screen together with the main screen. You can view TV while playing a DVD disc.

### 1 Press the PIP button.

The current disc is played in the PIP screen located at the bottom right of the screen.

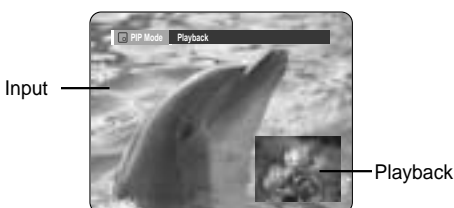

To view the current status and progress of playback : Press the DISPLAY button.

DVD-VIDEO		Info
Title	1/10	
Chapter	1/40	
Playing Time	00:01:10	
Main Screen	PR 1 [Mono]	
PIP Screen	Playback	
24 APR 2004 SAT		12:00

Playback

### Switching between the PIP and the main screens

### 2 Press the PIP button again.

The main and PIP screen will be switched. The input source is played in the PIP screen located at the bottom right of the screen.



To view the current status and progress of playback : Press the DISPLAY button.

DVD-VIDEO		Info
Title	1/10	
Chapter	1/40	
Playing Time	00:01:10	
Main Screen	Playback	
PIP Screen	PR 1 [Mono]	
24 APR 2004 SAT		12:00

### Deactivating PIP

### 3 Press the PIP button repeatedly to select Off.

Playback → Input → Off

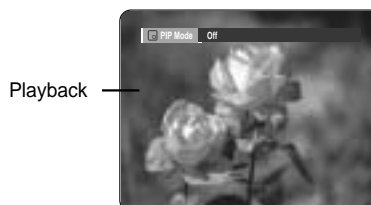

- You can not use PIP function, when you play MP3 files and CDs.
- You cannot use PIP function when the screen has highlight information, and PIP will go off automatically.

## Using Last Mark

Press LAST MARK key on Front Panel during playback. Current scene will be memorized to the disc.



When the Power is back On from Power Off status or disc tray is closed from open status, the recorder is going to be in Resume Stop status at the memorized position. Press the PLAY button. The Recorder will resume playing from the memorized scene, and the memorized position will be deleted. Each time LAST MARK is pressed, the recorder erases the old Last Mark information and records the new Last Mark information to the disc.



- When disc protect or cartridge protect is on, this function cannot be used.

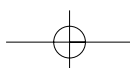

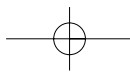

## Using Bookmarks



**1** Press the **MARKER** button during playback.



**2** Press the **OK** button when the desired scene appears.  
The number 1 is displayed and the scene is memorized.

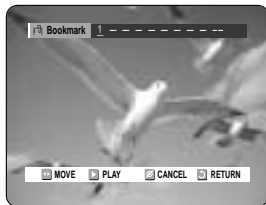

**3** Press the **◀▶** button to move to the next position.

**4** Press the **OK** button when the desired scene appears.  
The number 2 is displayed and the scene is memorized.

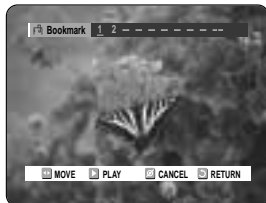

- Repeat above to bookmark other positions.
- You can bookmark up to 10 scenes.

**NOTE** ■ When the disc tray is opened and then closed, bookmarks will disappear.

## Playing Back a Bookmark

**1** Press the **MARKER** button.

**2** Press the **◀▶** buttons to select a bookmarked scene.

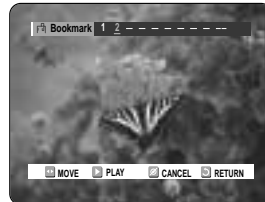

**3** Press the **OK** or **▶** button to start playing from the selected scene.

## Clearing a Bookmark

**1** Press the **MARKER** button.

**2** Press the **◀▶** buttons to select a bookmarked scene.

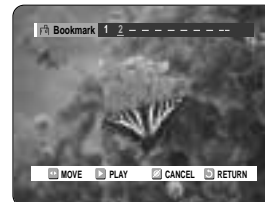

**3** Press the **CANCEL** button to delete the selected bookmark.



Playback

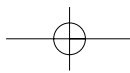

## Using Markers



**1** Press the MARKER button.



**2** Press the OK button when the desired scene appears.

The number 1 is displayed and the scene is memorized.



**3** Press the ◀▶ button to move to the next position.

**4** Press the OK button when the desired scene appears.

The number 2 is displayed and the scene is memorized.



- DVD-RAM or DVD-RW (VR Mode) discs have the Marker function instead of the Bookmark function. The Marker function allows you to mark up to 99 scenes. Since the scenes may be displayed as many different pages, numbering is necessary. If a disc in use is encoded with Cartridge Protection or Disc Protection, Markers cannot be set or deleted. Only playback is available.

## Playing Back a Marker

**1** Press the MARKER button.

**2** Press the ◀▶ buttons to select a bookmarked scene.



**3** Press the OK or ⏪ button to start playing from the selected scene.

- If you press the NEXT SKIP (⏩) button or the PREVIOUS SKIP (⏪) button in marker mode, when the next or current marked point plays for shorter than three seconds, playback starts from the previous marked point.

## Clearing a Marker

**1** Press the MARKER button.

**2** Press the ◀▶ buttons to select a bookmarked scene. Press the CANCEL button to delete the selected bookmark.



- When a marker is cleared while DVD-RAM/-RW (VR mode) is playing, marker numbers will change. For example, if the 7th marker is cleared after ten markers are registered, the marker numbers after the eighth will automatically move ahead by one.

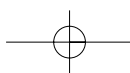

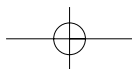

## Playing an Audio CD/MP3

### Playing an Audio CD (CD-DA)/MP3

Each disc has a variety of menu functions available.



### Playing an Audio CD(CD-DA)

#### 1 Insert an audio CD (CD-DA) into the disc tray.

The audio CD menu appears and the tracks (songs) are played automatically.

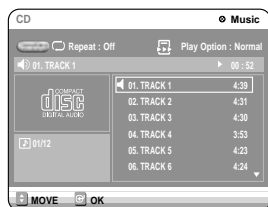

#### 2-1 Press the ▲▼ buttons to select the track you want to hear, and then press the OK button or ► button.

#### 2-2 Press the number buttons to select the track (song) and the track (song) is played automatically.

### Audio CD(CD-DA) Screen Elements



- Repeat mode:** Repeat off/Repeat Track/Repeat Disc
- Current track (song):** Displays the number of the track currently being played.
- Displays the current play index and total track number.
- This shows the operating state of a disc and a playback time corresponding to a portion that is currently played.
- Displays the track list (song list) and the playing time of each track.
- Button display.
- Play Option:** Normal, Random, Intro or Playlist

### The Buttons on the Remote Control

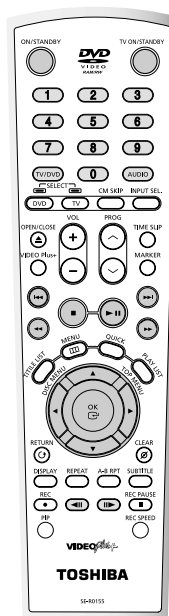

- ▲▼, 0-9:** Selects a track (song).
- :** Plays the selected track (song).
- OK button:** Plays the selected track (song).
- (⊕) button:** Plays the next track.
- (⊖) button:** Returns to the beginning of the current track when pressed during playback. If pressed again, your DVD recorder moves to and plays the previous track.  
If you press this button within three seconds after playback starts, the previous track will be played. If you press this button after three seconds, the current track will be replayed from the beginning.
- Press the (⊕/⊖) button:** Fast Play (X2, X4, X8)
- ⊖:** Stops a track(song).
- ⊞:** Plays a track(song) or pauses playback.

Playback

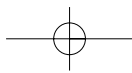

## Playing a MP3 Disc



- 1 Insert a MP3 Disc into the disc tray.**  
The MP3 menu appears and the tracks(songs) are played automatically.

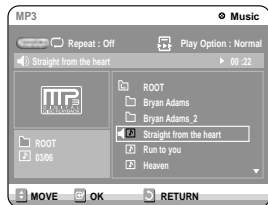

- 2-1 Press the ▲▼ buttons to select the track (song) you want to hear, and then press the OK button or ► button.**

- 2-2 Press the number buttons to select the track (song) and the track (song) is played automatically.**

## MP3 Screen Elements

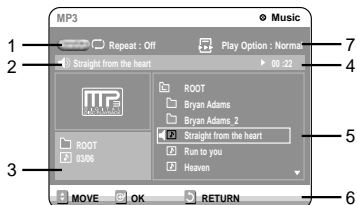

- 1. Repeat mode:** Repeat off, Repeat Track, Repeat Folder or Repeat Disc
- 2. Current track (song):** Displays the name of the track being played.
- Displays the current folder and play index.
- This shows the operating state of a disc and a playback time corresponding to a portion that is currently played.
- Displays the information for the folder and its tracks.
- Button display.
- Play Option :** Normal, Random, Intro or Playlist

## The Buttons on the Remote Control

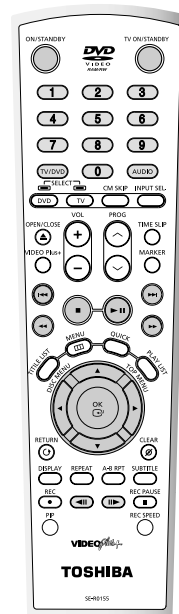

- ▲▼, 0-9:** Selects a track (song).
- :** Plays the selected track (song).
- OK button:** Plays back the selected track (song) or displays the files in the selected folder.
- RETURN button:** Moves to the folder to which the current song belongs.
- (⏸) button:** Plays the next track.
- (⏮) button:** Returns to the beginning of the current track when pressed while playing. If pressed again, your DVD recorder moves to and plays the previous track.  
If you press this button within three seconds, the previous track will be played.  
If you press this button after three seconds, the current track will be replayed from the beginning.
- (⏹) :** Stops a track(song).
- (⏸) :** Plays a track(song) or pauses playback.

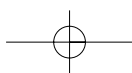

## Play Option Mode

The Play Option can be used with an audio CD or MP3 in the Play or Stop mode.



- 1 Press the **QUICK** button.  
Repeat Mode will be highlighted.

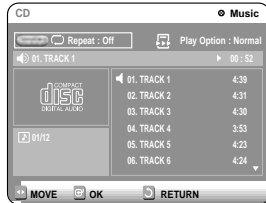

- During Playback, Repeat Mode will be highlighted.
- During Stop, Play Option will be highlighted.

- 2 Select "Play Option" Mode using the ◀ ▶ buttons and press the OK button.

The play option screen will appear.

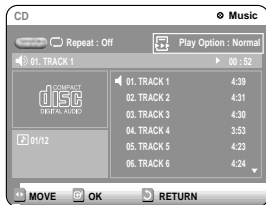

- 3 Select a desired play option (Normal, Random, Intro or Playlist) using the ▲ ▼ buttons.

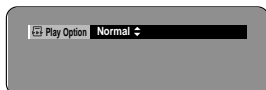

- **Normal:** Tracks on a disc are played in the order in which they were recorded on the disc.
- **Random:** The Random option plays a disc's tracks in random order. After a random list is generated and played completely, another random list is generated and played.  
Random Play is continued until the play option is changed.
- **Intro:** The first 10 seconds of each track will be played.  
If you want to listen to the music that you have selected, press the OK button or ⏸ button.  
The play option will be changed to Normal Play.  
If you Press ⏸ button, the recorder will skip to next track with play option of Intro.  
When Intro Play is completed, Normal Play is performed.
- **Playlist:** The Playlist playback option allows you to select the order in which you want tracks to play.

## To Program Tracks

You can register a maximum 30 tracks in the playlist.

- 1 Press the **QUICK** button.  
Repeat Mode will be highlighted.



- 2 Select "Play Option" using the ◀ ▶ buttons.

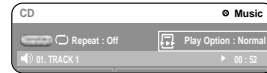

- 3 Press the **OK** button.  
The play option screen will appear.  
Select **Playlist** using the ▲ ▼ buttons.



- 4 Press the **OK** button.  
The Playlist screen will appear.  
Select "Tracks" in the order in which you want them to play using the ▲ ▼ buttons. Press the **OK** button.



Press the **PLAY** button to playback playlist.

- 5 If you playlisted a wrong track, select the wrong track using the ▲ ▼ buttons and press the **CANCEL** button.  
The wrong track will be removed.

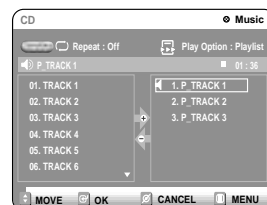

Playback

## Playing a Picture CD



There are two types of Picture CD. One is a CD with only JPEG files. The other one is a CD with JPEG files and MP3 files.(mixed CD)

1. When mixed CD is played, a menu will be shown in order to have you choose which contents, either JPEG or MP3, you want to play.
  - 1-1. If you want to play MP3 files on a mixed CD, choose Music on the menu, then it will take you to MP3 playing back screen. See page 60.
  - 1-2. If you want to play JPEG files on a mixed CD, choose Photo on the menu, then it will take you to photo playing back screen. See number 3 on this page.
2. When a Picture CD(CD with only JPEG files) is played, the recorder will show Album screen, showing thumbnail images. See number 3 on this page.

### 1 Insert a Picture CD(JPEG only) or Mixed CD(JPEG + MP3)into the disc tray.

### 2 In case of playing a Mixed CD, press the ▲▼ buttons to select Photo and press the OK or ► button. (In case of playing a Picture CD, see number 3 on this page.)

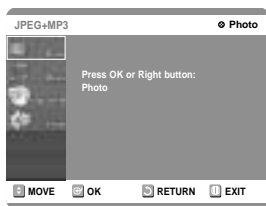

### 3 Press the ▲▼◀▶ buttons to select a picture.

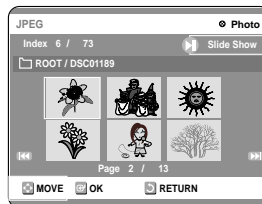

- To see the next 6 pictures, press the ☺ button.
- To see the previous 6 pictures, press the ☹ button.

### 4-1 If your press the PLAY(☺) button, the Slide show screen will appear.

The picture interval (Slide show speed) must be set.



### 4-2 Use the ◀▶ buttons to select a picture file in Album screen and then press the OK button.

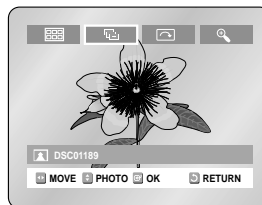

- ☰ : Returns to the Album screen.
- ☺ : The unit enters slide show mode.  
Before the slide show can begin, the picture interval (Slide show speed) must be set.
- ☹ : Each time the OK button is pressed, the picture rotates 90 degrees clockwise.
- 🔍 : Each time the OK button is pressed, the picture is enlarged up to 4X.  
(Normal → 2X → 4X → 2X → Normal)

- Press the QUICK button to clear or display menus.

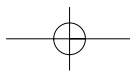

## Playing the Title List



Follow these instructions to play back a scene from the Title List.



### Using the TITLE LIST button

- 1 Press the **TITLE LIST** button.  
The Title List screen is displayed.

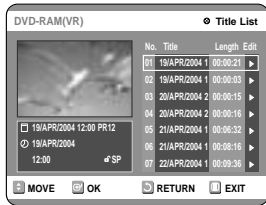

- 2 Press the **▲▼** buttons to select an entry you want to play from Title List, and then press the **PLAY** button.

The selected entry (title) will be played back.

- 3 To stop title play, press the **STOP** button. To return the title list screen, press the **TITLE LIST** button.

### Using the MENU button

- 1 Press the **MENU** button.

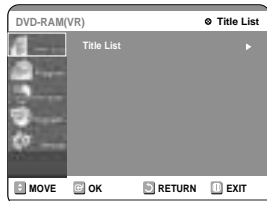

- 2 Press the **▲▼** buttons to select Title List, and then press the **OK** or **▶** button twice.

The Title List screen is displayed.

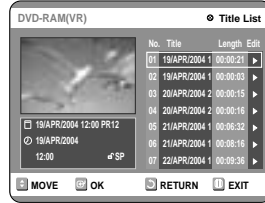

- 3 Press the **▲▼** buttons to select Title, and then press the **OK** or **▶** button.

The Edit menu is displayed on the right.

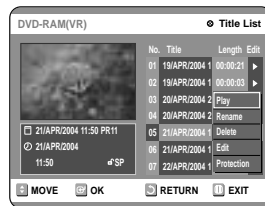

(Play, Rename, Delete, Edit, Protection : See pages 66~69)

- 4 Press the **▲▼** buttons to select "Play" to play the title list and then press the **OK** button.

The selected entry (title) will be played back.



Playback

To view the current status of the disc and progress of playback : Press the **DISPLAY** button, and the information about the disc will appear.

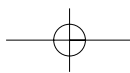
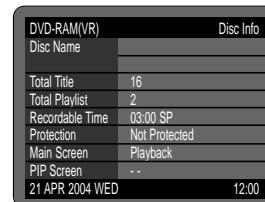



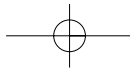

Press the DISPLAY button once again. Then you can check the information about the title under playback.

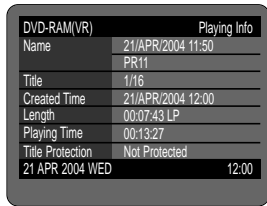

**5** To stop title play, press the STOP button. To return the title list screen, press the TITLE LIST button.



NOTE

- You can also play a recorded program by pressing the QUICK button.



- Press the ▲▼ buttons to select Title.
- Press the ◀▶ buttons to select to play the title list and then press the OK button.

## Title List Screen Elements

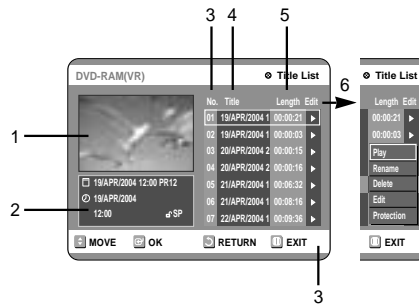



- Playback screen for recorded entries.
- Information window for the selected entry:  
Title name, recording date, recording time, lock status, recording mode
- Recorded entry No.
- Recorded entry title
- Recording duration (i.e., the playing time)
- Title list edit items  
Play: Plays the selected entry.  
Rename: Renames the title of a selected entry.  
Delete: Deletes the selected entry from the list.  
Edit: Deletes a section.  
Protection: Locks or unlocks the selected entry.
- Button display.

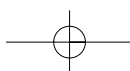

NOTE

- This may depend on the type of disc.
- DVD-R/DVD-RW(Video) has limited editing function.

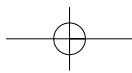

# Editing

This section introduces basic functions of DVD editing and explains both edit functions for the recording on a disc and edit functions for the entire disc.

Basic Editing (Title List) .....	66
Advance Editing (Play List).....	70
Disc Manager.....	78



- **Title List**  
Title refers to a recorded video and audio stream. Title List shows a list to help you select a title. Since the title list consists of the information on stream that is actually recorded, if one title is deleted, that title cannot be played again.
- **Play List**  
This refers to a unit of playback, which is made by selecting a desired scene in the entire Title List. When one playlist is played, only the scene selected by the user will play and then stop. Since only the information necessary for playing a desired scene is included in a playlist, even if that playlist is deleted, the original stream will not be deleted.

***If recording or editing could have not been finished properly because of any kinds of error, such as sudden power failure, the recording or editing might have not been done.***

***Please be aware that a material that has been damaged is unable to be retrieved to its original content.***

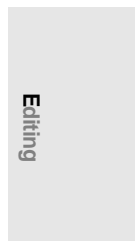

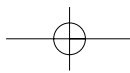

## Basic Editing (Title List)

### Renaming(Labeling) a Title

Follow these instructions to rename a title list entry, i.e., to edit the title of a recorded program.



#### Using the TITLE LIST button

#### 1 Insert the recorded disc, Press the TITLE LIST button.

The Title List screen is displayed

##### Using the MENU button

- Press the MENU button.
- Press the ▲▼ buttons to select Title List, and then press the OK or ► button twice.

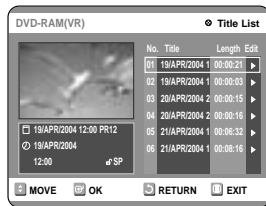

#### 2 Press the ▲▼ buttons to select an entry you want to rename from the Title List, and then press the OK or ► button.



#### 3 Press the ▲▼ buttons to select "Rename", and then press the OK button.

The Rename screen is displayed.

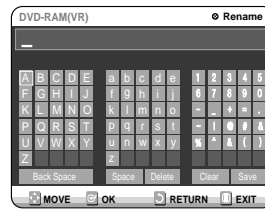

#### 4 Select the desired characters using the arrow (▲▼◀▶) buttons, press the OK button.

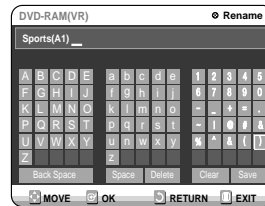

- **Back Space:** Moves the cursor one position backwards. (Equivalent to the CANCEL button)
- **Space:** Enters a blank and moves the cursor one forward (to the right).
- **Delete:** Deletes the character at the cursor position.
- **Clear:** Deletes all the character inputs.
- **Save:** Registers the character inputs.

#### 5 Press the arrow buttons to select "Save", and then press the OK button.

The changed title name is displayed on the title item of the selected entry.



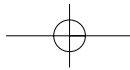

## Locking(Protecting) a Title

Follow these instructions to lock an entry to protect it from accidental deletion.



### Using the TITLE LIST button

#### 1 Insert the recorded disc, Press the TITLE LIST button.

The Title List screen is displayed

#### Using the MENU button

- Press the MENU button.
- Press the ▲▼ buttons to select Title List, and then press the OK or ► button twice.



#### 2 Press the ▲▼ buttons to select an entry you want to protect in the Title List, and then press the OK or ► button.



#### 3 Press the ▲▼ buttons to select "Protection", and then press the OK button.



#### 4 Press the ◀▶ buttons to select "On", and then press the OK button. The key icon on the information window for the selected entry changes to the locked status. (Ⓛ → Ⓚ)

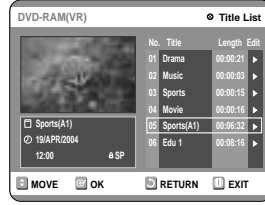

## Deleting a Title

Follow these instructions to delete an entry from the Title List.



### Using the TITLE LIST button

#### 1 Insert the recorded disc, Press the TITLE LIST button.

The Title List screen is displayed

#### Using the MENU button

- Press the MENU button.
- Press the ▲▼ buttons to select Title List, and then press the OK or ► button twice.



#### 2 Press the ▲▼ buttons to select an entry you want to delete in the Title List, and then press the OK or ► button.

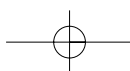

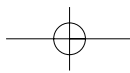

**3** Press the ▲▼ buttons to select “Delete”, and then press the OK button.



You will be prompted with the confirmation message.  
 DVD-RAM(VR), DVD-RW(VR mode): Since Playlist is present, the message ‘Do you want to delete?( Related playlist may be deleted.)’ is displayed.  
 DVD-RW(Video mode), DVD-R: Since Playlist is not present, the message ‘Do you want to delete?’ is displayed.



- This may depend on the type of disc.

**4** Press the ◀▶ buttons to select “Yes”, and then press the OK button.



NOTE

- You cannot delete a protected entry. If you want to delete a protected entry, select “OFF” in the Title Protection menu.
- Disc Protection: When Protected or Cartridge Protection has been set when a DVD-RAM is used, data cannot be deleted from a disc.
- Once an entry is deleted from the Title List it cannot be recovered.
- Once DVD-R, DVD-RW is finalised, it cannot be deleted.
- With DVD-R, titles are only deleted from the menu, however, the Title remains physically on the disc.

Editing

**Deleting a Section of a Title**

Follow these instructions to delete a section of a Title List entry.



**Using the TITLE LIST button**

**1** Insert the recorded disc, Press the TITLE LIST button.

The Title List screen is displayed

**Using the MENU button**

- Press the MENU button.
- Press the ▲▼ buttons to select Title List, and then press the OK or ▶ button twice.



**2** Press the ▲▼ buttons to select an entry you want to edit from the Title List, and then press the OK or ▶ button.



**3** Press the ▲▼ buttons to select “Edit”, and then press the OK button.

The Edit Title List screen is display

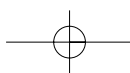

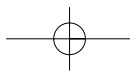

**4 Press the OK button at the starting point.**

The image and starting point time are displayed in the section deletion starting point window.



**Edit Title List Screen Elements**



1. Playback bar
2. Playtime
3. Section deletion starting point window and time
4. Section deletion end point window and time
  - Select the start and end points of the section you want to delete using the playback related buttons.
  - Playback related buttons: (⏪, ⏩, ⏴, ⏵, ⏶, ⏷, ⏸, ⏹).

**5 Press the OK button at the end point.**

The image and end point time are displayed in the Section deletion ending point window.



**6 Press the ▲▼ buttons to select “Delete”, and then press the OK button.**

The selected section has been deleted.



To return to the Title List screen, press the ▲▼ buttons to select Return.

**7 Press the MENU button after the operation has finished.**

The Title List screen will disappear.



- The length of the section to be deleted must be at least 5 seconds long.
- If the length of the section to be deleted is less than 5 seconds, you will be prompted with the message 'The range is too short.'
- If the end time precedes the starting time, you will be prompted with the message 'End point cannot be marked earlier than start point'.
- The section cannot be deleted when it includes a still picture.



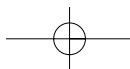

## Advanced Editing (Play List)

### Creating a Playlist

Follow these instructions to create a new playlist entry from a recorded title.



**1** Press the MENU button with the disc stopped.

**2** Press the ▲▼ buttons to select “Playlist”, and then press the OK or ► button.

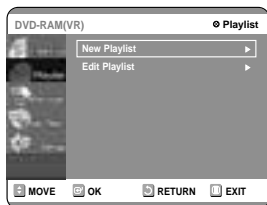

**3** Press the ▲▼ buttons to select “New Playlist”, and then press the OK or ► button.

The Make Scene screen is displayed.



**4** Press the OK button at the start point.

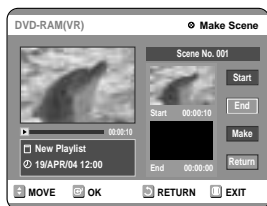

- The image and time at the start point are displayed on the Start window.
- The yellow-colored selection bar moves to the End item.
- Select the starting point of the section from which you want to create a new scene using the playback related buttons (◀, ▶, ⏪, ⏩, ⏹, ⏸, ⏺, ⏻).

**5** Press the OK button at the end point.



- The image and end point time are displayed in the End window.
- The yellow-colored selection bar moves to the Make item.

- To make a new playlist -

**6** Press the ▲▼ buttons to select “Make”, and then press the OK button.

A new Scene will be added to the current Playlist. A new Make Scene screen is displayed. Repeat the above steps to create further scenes.



NOTE

- If you want to make a new playlist, go to MENU → new playlist.
- You can check and see all the scenes on Edit Playlist screen.

- To return to Edit Playlist menu -

**7** Press the ▲▼ buttons to select “Return”, and then press the OK button.

The Edit Playlist screen is displayed.

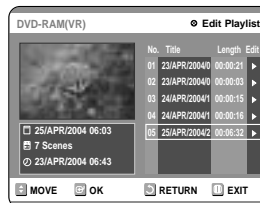

**8** Press the MENU or PLAY LIST button after the operation has finished.

The Edit Playlist screen will disappear.



NOTE

- You can create up to 99 playlist entries.
- Depending on the kind of disc, the displayed screen may have a slight difference.

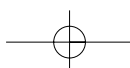

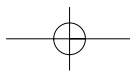

## Playing Entries in the Playlist

Follow these instructions to play the playlist entries.



### 1 Insert the recorded disc, Press the PLAY LIST button.

The Edit Playlist screen is displayed.

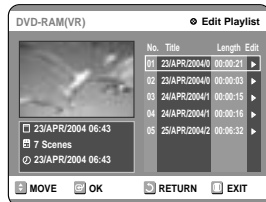

#### Using the MENU button

- Press the MENU button when the disc has stopped.
- Press the ▲▼ buttons to select Playlist, and then press the OK or ▶ button.
- Press the ▲▼ buttons to select Edit Playlist, and then press the OK or ▶ button.



### 2 Press the ▲▼ buttons to select the title you want to edit from the Playlist, and then press the OK or ▶ button.

The Edit Playlist menu is displayed : Play, Rename, Edit Screen, Copy, Delete.

### 3 Press the ▲▼ buttons to select "Play", and then select the OK button.

The playlist entries will be played.

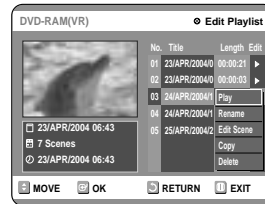

- To view the current status of the disc and progress of playback : Press the DISPLAY button, and the information about the disc will appear.

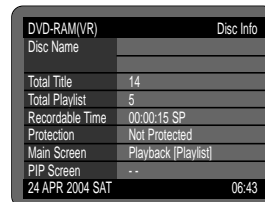

- Press the DISPLAY button once again. Then you can check the information about the playlist under play back.



- The screen returns to the Edit Playlist screen when the playback has finished.

### 4 Press the STOP button to stop playing.

The screen returns to the Edit Playlist screen.



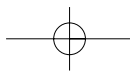

## Renaming a Playlist Entry

Follow these instructions to rename a playlist entry, i.e. to edit the title of a playlist entry.



- 1 **Insert the recorded disc, Press the PLAY LIST button.**  
The Edit Playlist screen is displayed.

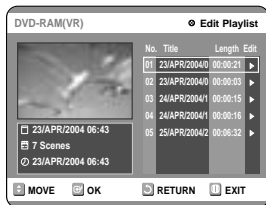

### Using the MENU button

- Press the MENU button when the disc has stopped.
- Press the ▲▼ buttons to select Playlist, and then press the OK or ► button.
- Press the ▲▼ buttons to select Edit Playlist, and then press the OK or ► button.

- 2 **Press the ▲▼ buttons to select the title you want to edit from the Playlist, and then press the OK or ► button.**

The Edit Playlist menu is displayed :Play, Rename, Edit Scene, Copy, Delete



- 3 **Press the ▲▼ buttons to select "Rename", and then press the OK button.**

The Rename screen is displayed.



- 4 **Enter the desired characters using the ▲▼◀▶ buttons.**

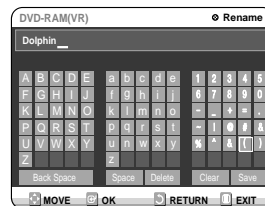

- This function is the same as the Rename function in the renaming the title list. (See page 66.)
- The maximum number of characters that can be entered is 31. All 31 characters can then be displayed by pressing the DISPLAY button.

- 5 **Press the arrow buttons to select "Save", and then press the OK button.**

The changed title is displayed in the title field of the selected playlist entry.

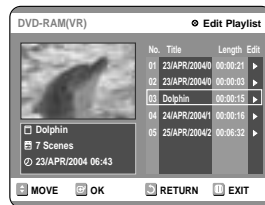

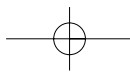

## Editing a Scene for the Playlist

Follow these instructions to edit scenes for a playlist.



- 1 Insert the recorded disc, Press the **PLAY LIST** button. The Edit Playlist screen is displayed.

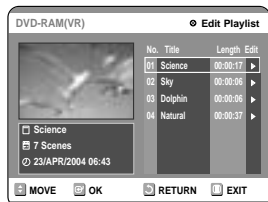

### Using the MENU button

- Press the MENU button when the disc has stopped.
- Press the ▲▼ buttons to select Playlist, and then press the OK or ▶ button.
- Press the ▲▼ buttons to select Edit Playlist, and then press the OK or ▶ button.

- 2 Press the ▲▼ buttons to select the title you want to edit from the Playlist, and then press the OK or ▶ button.

The Edit Playlist menu is displayed.:Play, Rename, Edit Scene, Copy, Delete

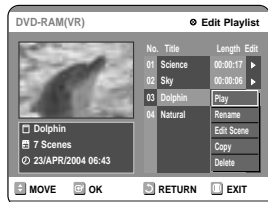

- 3 Press the ▲▼ buttons to select "Edit Scene", and then press the OK button.

The Edit Scene screen is displayed.

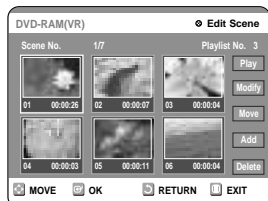

## Playing a Selected Scene

- 4 Press the arrow buttons to select the scene you want to play, and then press the OK button.

The playlist entry to be played is selected.

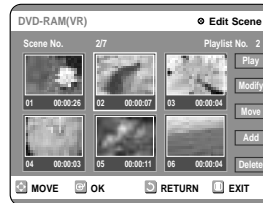

- 5 Press the OK button.

The selected scene is played.

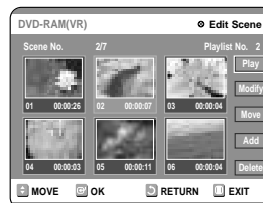

- To stop scene play, press the STOP button.
- Select a desired scene by using the ▲▼◀▶ buttons and press the PLAY button. Then playback will operate.

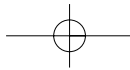

**Modifying a Scene (Replacing a Scene)**

**4** Press the arrow buttons to select the scene you want to modify, and then press the OK button.

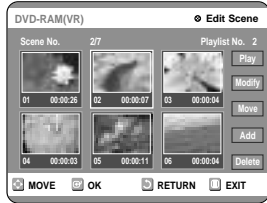

**5** Press the ▲▼ buttons to select 'Modify', and then press the OK button. The Modify Scene screen is displayed.

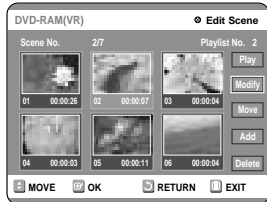

**6** Press the OK button at the start point of the scene.

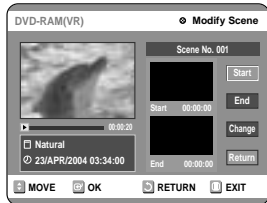

- The image and starting point time are displayed on the Start window.
- Select the starting or ending point of the section you want to modify using the playback related buttons (⏪, ⏩, ⏴, ⏵, ⏶, ⏷, ⏸, ⏹).

**7** Press the OK button at the end point of the scene.

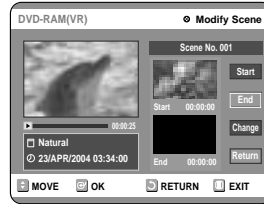

- The image and ending point time are displayed in the End window.

**8** Press the ▲▼ buttons to select "Change", and then press the OK button.

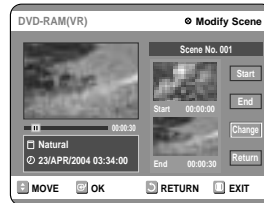

- The scene you want to modify is changed with the selected section.

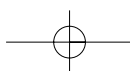
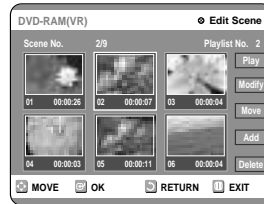

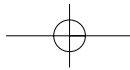

**Moving a Scene (Changing the Position of a Scene)**

**4** Press the ▲▼◀▶ buttons to select the scene you want to move (change the position), and then press the OK button.

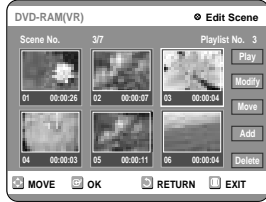

**5** Press the ▲▼ buttons to select "Move", and then press the OK button.

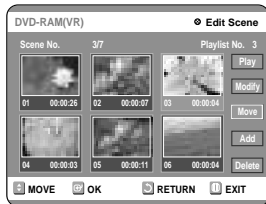

- A yellow selection window is displayed on the scene to be moved.

**6** Press the ▲▼◀▶ buttons to select the position to which you want to move the selected scene, and then select the OK button.

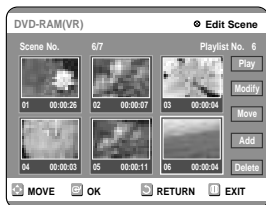

- The selected scene is moved to the selected position.

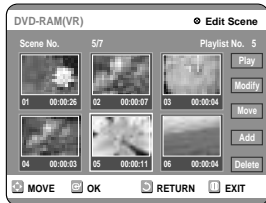

NOTE

- You cannot move the selected scene to the position of the next scene, because the selected scene should be inserted before that position, which requires no action.
- Depending on the kind of disc, the displayed screen may have a slight difference.

**Adding a Scene**

**4** Press the ▲▼◀▶ buttons to select the scene that will have a new scene inserted before it, and then press the OK button.

A yellow selection window is displayed on the scene to be added as the new scene.

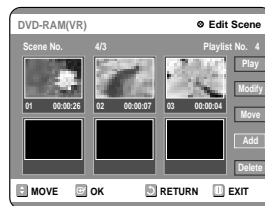

**5** Press the OK button. The Add Scene screen is displayed.

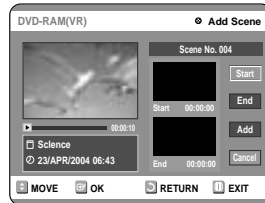

**6** Press the OK button at the starting point of the scene.

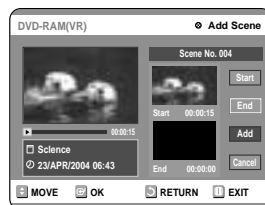

- The image and starting point time are displayed in the Start window.
- Select the end point of the section where you want to add the new scene using the playback related buttons (◀, ▶, ⏪, ⏩, ⏴, ⏵, ⏶, ⏷).

Editing

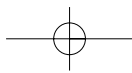

**7** Press the OK button at the end point of the scene.

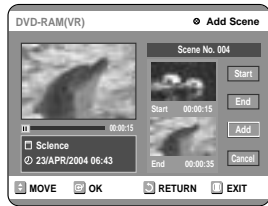

- The image and time of the end point are displayed in the End window.

**8** Press the ▲▼ buttons to select “Add”, and then press the OK button.

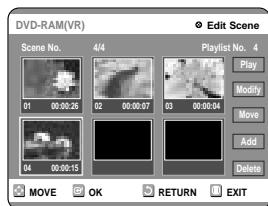

- The section you want to add is inserted prior to the scene selected in step 4 of Adding a Scene on the previous page.
- To cancel, press the ▲▼ buttons to select cancel and then press the OK button.

**Deleting a Scene**

**4** Press the arrow buttons to select the scene you want to delete, and then press the OK button.

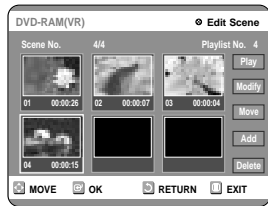

**5** Press the ▲▼ buttons to select “Delete”, and then press the OK button.

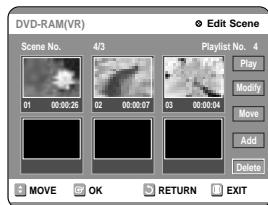

**Copying a Playlist Entry to the Playlist**



**Using the PLAY LIST button**

**1** Insert the recorded disc, Press the PLAY LIST button. The Edit Playlist screen is displayed.

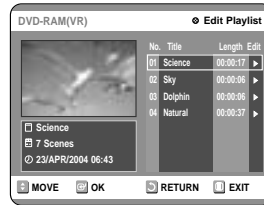

**Using the MENU button**

- Press the MENU button. When the disc has stopped.
- Press the ▲▼ buttons to select Playlist, and then press the OK or ▶ button.
- Press the ▲▼ buttons to select Edit Playlist, and then press the OK or ▶ button.

**2** Press the ▲▼ buttons to select the title you want to edit from the Playlist, and then press the OK or ▶ button.

The Edit Playlist menu is displayed.:Play, Rename, Edit Scene, Copy, Delete

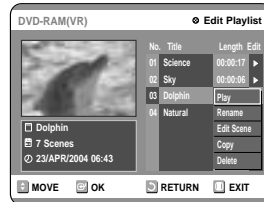

**3** Press the ▲▼ buttons to select “Copy”, and then press the OK button.

Playlist that has been selected at last will be copied.

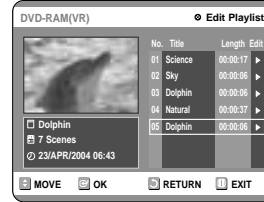

Editing

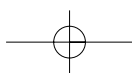

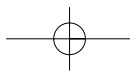

**4** Press the **MENU** button after the operation has finished. The menu screen will disappear.



- You can create up to 999 scenes on one disc. In some cases, this may be different from the actual numbers.

**3** Press the **▲▼** buttons to select “Delete”, and then press the **OK** button.

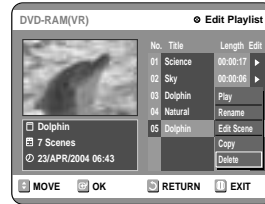

- You will be prompted with the delete confirmation message 'Do you want to delete?'.

## Deleting a Playlist Entry from the Playlist



Using the **PLAYLIST** button

**1** Insert the recorded disc, Press the **PLAY LIST** button. The Edit Playlist screen is displayed..

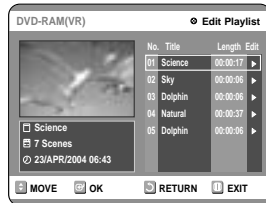

**4** Press the **◀▶** buttons to select “Yes”, and then press the **OK** button.

You automatically returned to the Edit Playlist screen after the delete operation has finished.

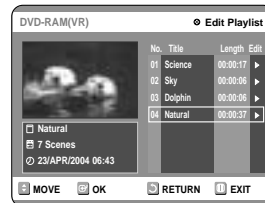
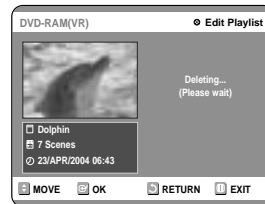

### Using the **MENU** button

- Press the **MENU** button. When the disc has stopped.
- Press the **▲▼** buttons to select Playlist, and then press the **OK** or **▶** button.
- Press the **▲▼** buttons to select Edit Playlist, and then press the **OK** or **▶** button.

**2** Press the **▲▼** buttons to select the title you want to edit from the Playlist, and then press the **OK** or **▶** button.

The Edit Playlist menu is displayed.:Play, Rename, Edit Scene, Copy, Delete

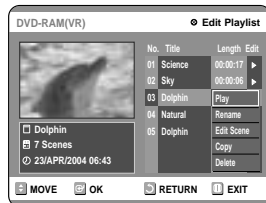

Editing

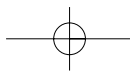

# Disc Manager

## Editing the Disc Name

Follow these instructions to give a name to a disc.



**1** Insert the disc, Press the MENU button with the disc stopped.



**2** Press the ▲▼ buttons to select “Disc Manager”, and then press the OK or ► button.

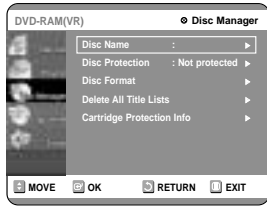

**3** Press the ▲▼ buttons to select “Disc Name”, and then press the OK or ► button.

The Edit Name screen is displayed.

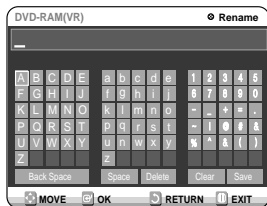

**4** Enter the desired characters using the arrow buttons.

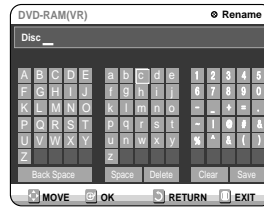

**5** Press the arrow buttons to select “Save” and then press the OK button.

A disc name is given to the disc.

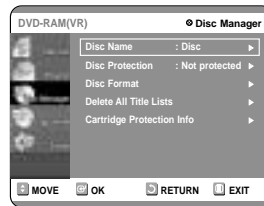

- You may need to clear cartridge protect or disc protect before beginning editing.
- Depending on the kind of disc, the displayed screen may be different.

Editing

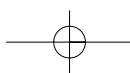

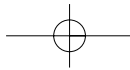

## Disc Protection

Disc Protect allows you to protect your discs from being formatted or deleted due to unintended operations.



- 1 Press the **MENU** button with the disc stopped.



- 2 Press the **▲▼** buttons to select “Disc Manager”, and then press the **OK** or **▶** button. Press the **▲▼** buttons to select “Disc Protection”.

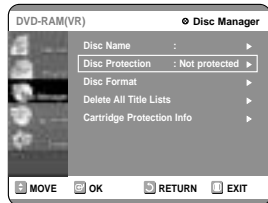

- 3 Press the **OK** or the **▶** button and then press the **▲▼** button to select Protected.

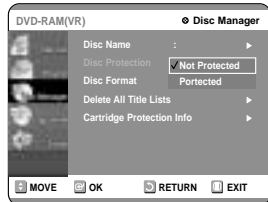

- 4 Press the **OK** button.

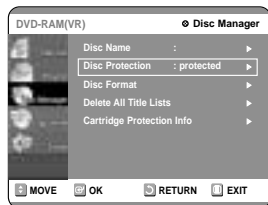

**NOTE** ■ Disc Protection will operate only if cartridge protection has been cleared. (DVD-RAM only)

## Formatting a Disc

Use these instructions to format a disc. The cartridge write protect tab should be set to the unprotect position. The disc protect should also be cleared.



- 1 Insert the recorded to be formatted, Press the **MENU** button with the disc stopped.

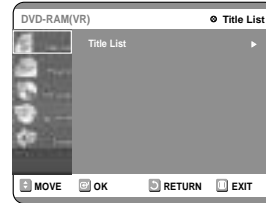

- 2 Press the **▲▼** buttons to select “Disc Manager”, and then press the **OK** or **▶** button.

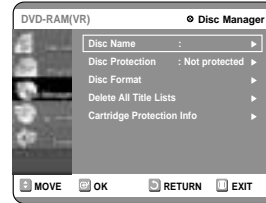

- 3 Press the **▲▼** buttons to select “Disc Format”, and then press the **OK** or **▶** button.

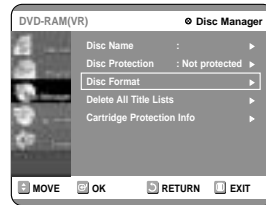

### DVD-RAM

- You will be prompted with the confirmation message 'Do you want to format disc?'.



- You will be prompted with the confirmation message 'All data will be deleted. Do you want to continue?'.

Editing

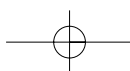



**DVD-RW**

- You will be prompted with the confirmation message 'Choose the recording format for DVD- RW.'



**2** Press the ▲▼ buttons to select “Disc Manager”, and then press the OK or ► button.

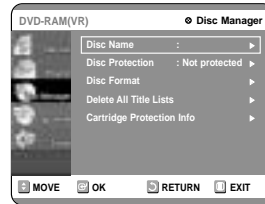

**4** Press the ◀▶ buttons to select “Yes”, and then press the OK button. The disc is formatted.

DVD-VR and DVD-V are defined according to their recording format.

	DVD-VR	DVD-V
Editing	Possible (Partial editing is possible)	Inconvenience
DISC	DVD-RAM DVD-RW	DVD-RW DVD-R

**3** Press the ▲▼ button to select “Delete All Title Lists”, and then press the OK or ► button.

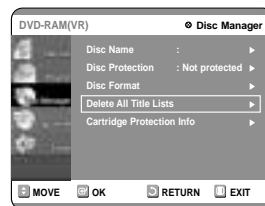

- You will be prompted with the confirmation message 'Do you want to delete all title lists?'.

**Delete All Title Lists**



**1** Insert the recorded disc, Press the MENU button with the disc stopped.

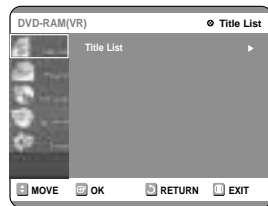

- When Protected Entry exists: The Delete All Title List function will not operate. If there is a title containing a still picture, however, that function will not operate. If you want to delete a protected entry, disable Protect for it on the Lock item.
- Disc Protection: When Protected or Cartridge Protection has been set, when a DVD-RAM is used, data cannot be deleted from a disc.

**4** Press the ◀▶ buttons to select “Yes”, and then press the OK button. All title lists are deleted.

Editing

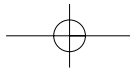

## Cartridge Protection Info

Disc Protection allows you to protect discs from disc formatting and program deletion due to unintended operations. The cartridge write protect tab should be set to the unprotect position to be able to make a recording to a DVD-RAM disc.



**1** Insert the disc, Press the MENU button with the disc stopped.

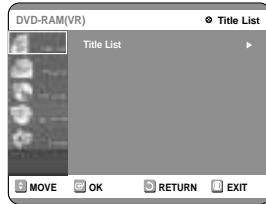

**2** Press the ▲▼ buttons to select “Disc Manager”, and then press the OK or ► button.

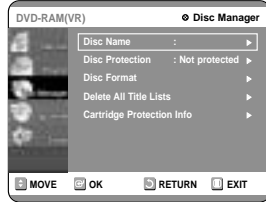

**3** Press the ▲▼ buttons to select “Cartridge Protect Info”, and then press the OK or ► button.

- The cartridge protection info for the disc is displayed.
- If the disc cartridge is protected, open the disc tray and check the disc.

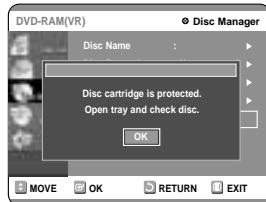

If the disc cartridge is not protected, proceed with recording to the disc.

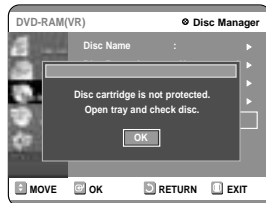

- Disc Protection will operate only if cartridge protect is set to Not Protected.

## Finalizing a disc

After you record titles onto a DVD-RW/DVD-R disc with your DVD recorder, it needs to be finalised before it can be played back on external devices.



**1** Insert the recorded disc, Press the MENU button with the disc stopped.

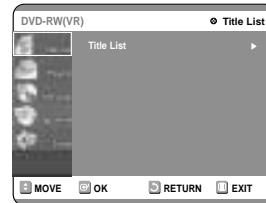

**2** Press the ▲▼ buttons to select “Disc Manager”, and then press the OK or ► button.

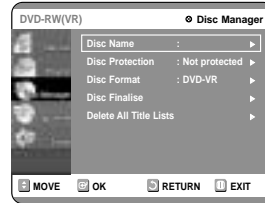

**3** Press the ▲▼ button to select “Disc Finalise”, and then press the OK or ► button.

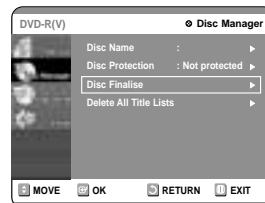
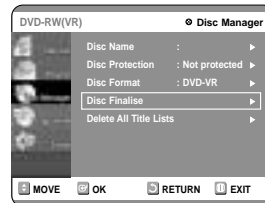

Editing

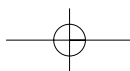

You will be prompted with the message 'Do you want to finalise disc?'. If you select Yes, you will be prompted again with the message 'Disc will be finalised. Do you want to continue?'



#### 4 Press the ◀▶ buttons to select "Yes", and then press the OK button.

The disc is finalised.



NOTE

- Once a disc is finalised, you cannot delete entries from the record list.
- After being finalised, the DVD-R/DVD-RW(video mode) operates in the same manner as a DVD-Video.
- Depending on the kind of disc, the displayed screen may have a slight difference.
- Finalizing time may be different depending on the amount of data recorded on the disc.
- Data on the disc will be damaged if the recorder is powered off during finalise process.

## Unfinalizing a disc (V/VR mode)



### 1 Insert the recorded disc, Press the MENU button with the disc stopped.

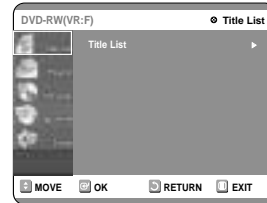

### 2 Press the ▲▼ buttons to select "Disc Manager", and then press the OK or ▶ button.



### 3 Press the ▲▼ button to select "Disc Unfinalise", and then press the OK or ▶ button.

You will be prompted with the message 'Do you want to unfinalise disc?'.



If you select Yes, you will be prompted again with the message 'Disc will be unfinalised. Do you want to continue?'.



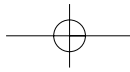

## 4 Press the ◀▶ buttons to select “Yes”, and then press the OK button.

The disc is unfinalised.



NOTE

- A DVD-RW can be finalised or unfinalised in Video mode.

	Finalise	Unfinalise
Mark	DVD-Video(RW)	DVD-RW(V)
Operation	Same as DVD-Video	Additional recording, protection and deletion are possible.

- A DVD-RW can be finalised or unfinalised in VR mode.

	Finalise	Unfinalise
Mark	DVD-RW(VR:F)	DVD-RW(VR)
Operation	Additional recording, deletion, editing, and protection are impossible.	Additional recording, deletion, editing, and protection are possible.

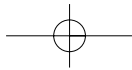

# Additional Information

Additional Information

Troubleshooting .....	84
Specification.....	88

## Troubleshooting



If your product malfunctions, go through the checkpoints below before contacting a Toshiba authorized service center.

### Power

The input is displayed for a while when the power is turned on.



**Checkpoint 1** The DVD recorder requires some time to initialize and the input will be displayed for approx. 10 seconds after it is turned on.

### Recording

Cannot record TV programs.



**Checkpoint 1** Check whether the power cord is securely plugged into the power outlet.

**Checkpoint 2** Did you set the DVD recorder channel settings correctly?

**Checkpoint 3** Check the free space on your DVD-RAM/DVD-RW/DVD-R discs.

I pressed the REC button but there is no response.



**Checkpoint 1** Recording is possible for DVD-RAM/DVD-RW/DVD-R discs only. If a program is copy protected, it cannot be recorded.

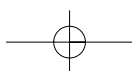

Differences between Using REC PAUSE Button and Using Stop Button during Recording



**Checkpoint 1** Each press of the Stop button during recording creates a title. When the REC PAUSE button is pressed, the paused state is kept. When the REC PAUSE button is pressed again during REC pause, the title under pause will be kept recording.

Play mode settings are different from the settings configured in the Settings menu.



**Checkpoint 1** The disc does not support all selected functions. In this case, some settings configured in the settings menu may not work properly.

Cannot change the aspect ratio.



**Checkpoint 1** The aspect ratio is fixed for DVD discs. (See page 30.)

## Playback

Cannot play the disc.



**Checkpoint 1** Check whether the disc is inserted correctly with the label facing up.

**Checkpoint 2** Check the regional code of the DVD disc.

**Checkpoint 3** This DVD recorder cannot play some types of discs. (See page 5, 47.)

The angle operation does not work while playing a DVD disc.



**Checkpoint 1** The angle operation is available only when the disc contains images captured from different angles.

⊘ icon appears on the screen.



**Checkpoint 1** You cannot use this operation or function due to one of the following reasons:

- (1) Your DVD disc restricts it.
- (2) Your DVD disc does not support this feature (for example: angles)
- (3) The feature is not available at the moment.
- (4) You've requested a title, chapter, or scan time that is out of range.

The selected audio and/or subtitle language is not played.



**Checkpoint 1** Audio and subtitle languages are disc-specific. Only the sound and subtitle languages contained on the DVD disc are available and displayed in the disc menu.

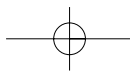

## Video

The disc revolves, but no image or bad quality images are displayed.



- Checkpoint 1** Check whether there is damage to or any foreign material on your disc.
- Checkpoint 2** Some low quality discs may not play properly.
- Checkpoint 3** If scenes change from dark to bright suddenly, the screen may shake vertically temporarily, but this is not a fault.

## Sound

No sound.



- Checkpoint 1** Are you watching a program in slow or skip mode?  
If you are playing a program at a speed other than normal speed, sound will not be heard.
- Checkpoint 2** Check the connections and settings.
- Checkpoint 3** Check whether the disc is damaged. Clean the disc, if necessary.
- Checkpoint 4** Check whether the disc is inserted correctly with the label facing up.

No audio output.



- Checkpoint 1** Check whether you have selected the correct digital output options in the Audio Output Options menu. (See page 31.)

## Timer Recording

Timer lamp flickers.



- Checkpoint 1** Check there is enough space in the disc for recording.
- Checkpoint 2** Check whether the current disc is recordable or not. Make sure to check before the start time of recording.

Timer recording does not work properly.



- Checkpoint 1** Re-check the recording time and the end time settings again.
- Checkpoint 2** Recording will be cancelled, if the power is disconnected due to a power failure or another similar reason while recording.

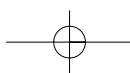

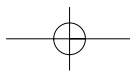

## Remocon

The remote control doesn't work.



- Checkpoint 1** ▶ Point the remote control at the remote control sensor on your DVD recorder. Allow for proper distance. Remove obstacles between your DVD recorder and the remote control.
- Checkpoint 2** ▶ Check whether the batteries are empty.
- Checkpoint 3** ▶ Check for the TV/DVD selection button.

Other problems.



- Checkpoint 1** ▶ Read the table of contents and then find and read the section describing your problem, and follow the instructions given.
- Checkpoint 2** ▶ Turn your DVD recorder off and on.
- Checkpoint 3** ▶ If the problem still persists, contact a nearby Toshiba service center.

## Other

I forgot my password for parental supervision.



- Checkpoint 1** ▶ Press the (⊕) and (⊖) buttons on your DVD recorder simultaneously when the power is on. All settings including the password will revert to the factory settings. Do not use this unless absolutely necessary. (Note that this function is possible only when no disc is inserted.)

Is it possible to change a subtitle and an audio signal on a recorded disc?



- Checkpoint 1** ▶ A recorded disc is played with only the subtitle and the audio signal which were selected during recording.

Additional Information



## Specifications

General	Power requirements	230V AC, 50Hz
	Power consumption	35 Watts
	Weight	3.75Kg
	Dimensions	430mm(W) x 280mm(D) x 68.5mm(H)
	Operating temp.	+5°C to +35°C
	Other conditions	Keep level when operating. Less than 75% operating humidity
Input	Video (AV3, AV4)	Composite Video : 1.0 V p-p at 75Ω load, sync negative
		S-Video input (Y: 1.0Vp-p, C: 0.286Vp-p at 75Ω load)
	Audio(AV3, AV4)	Max.Audio Input Level : 2Vrms
	DV Input	IEEE 1394(4p) compatible jack
	Receivable Channels	PAL I
Scart Jack	AV1 (Scart TV)	Video : Composite, Audio: analogue
	AV2 (Scart Ext)	Video : Composite, RGB Audio: analogue
Output	Audio	Analogue output jacks 1, 2
		Optical/Coaxial digital audio output
		Full scale Analogue output level : 2Vrms
	Video	Composite Video : Video output jack 1
		S-Video output 1 (Y:1.0Vp-p, C:0.286Vp-p at 75Ω load)
	Scart Jack	AV1 (Scart TV)
AV2 (Scart Ext)		Video : Composite Audio: analogue
Recording	Picture Compression format	MPEG-II
	Audio Compression format	Dolby Digital 2ch/256kbps, MPEG-II
	Recording Quality	XP (about 8 Mbps), SP (about 4 Mbps), LP (about 2 Mbps),
		EP (about 1.2 Mbps), FR (about 1.2 Mbps to 8 Mbps)
Audio Frequency Response	20 Hz ~ 20 kHz	

**Audio Output** For DVD discs, audio signals recorded at 96kHz sampling frequency are converted and output at 48kHz.

Disc Type	DVD	AUDIO CD(CDDA)
Analogue Audio Output	48 / 96kHz	44.1kHz
Digital Audio Output	48kHz	44.1kHz

## Free Manuals Download Website

<http://myh66.com>

<http://usermanuals.us>

<http://www.somanuals.com>

<http://www.4manuals.cc>

<http://www.manual-lib.com>

<http://www.404manual.com>

<http://www.luxmanual.com>

<http://aubethermostatmanual.com>

Golf course search by state

<http://golfingnear.com>

Email search by domain

<http://emailbydomain.com>

Auto manuals search

<http://auto.somanuals.com>

TV manuals search

<http://tv.somanuals.com>