



*Commander.*



**500-19-54**

**700-19-54**

**DUAL CHANNEL  
DIGITAL TELEPHONE  
INTERFACE USER  
GUIDE**

ISSUE 1.2

TRILOGY COMMUNICATIONS LIMITED

26 Focus Way  
Walworth Estate  
Andover  
Hampshire  
SP10 5NY  
England

Telephone  
Fax  
Email  
Web site

+44 (0) 1264 384000  
+44 (0) 1264 334806  
[0Hmail@trilogycomms.com](mailto:0Hmail@trilogycomms.com)  
[1Hwww.trilogycomms.com](http://1Hwww.trilogycomms.com)

The Copyright of the information and drawings in this document is the property of Trilogy Communications Limited of Andover, Hampshire and is neither to be reproduced in whole or in part, nor disclosed to a third party, without the prior written consent of Trilogy Communications Limited.

The information in this document has been carefully compiled and checked for accuracy. However, Trilogy Communications Limited accepts no responsibility for inaccuracies which may occur and, further, reserves the right to make changes to specification or design without prior notice.

Comments or correspondence concerning this manual should be addressed to The Documentation Manager at the address given at the front of this User Guide.

**DOCUMENT NUMBER**

**500-19-604**

**ISSUE 1.2**

<b>Issue</b>	<b>Date</b>	<b>Reason for Change</b>	<b>Approved</b>
1.1	1 June 2005	New digital card	
1.2	20 November 2008	Company details updated. Added 700 series.	

**ERRATA SHEET**

*This sheet contains information regarding errors in this user guide.*

<b>Date</b>	<b>Description</b>
-	none

**CONTENTS**

<b>1. INTRODUCTION.....</b>	<b>5</b>
1.1 SAFETY PRECAUTIONS.....	5
1.2 TRANSPORTATION AND STORAGE.....	5
1.3 MAINS CONNECTOR AND PLUG.....	5
1.4 FUSES.....	5
1.5 REMOVAL OF COVERS.....	5
<b>2. SYSTEM DESCRIPTION.....</b>	<b>7</b>
2.1 FEATURES.....	7
2.2 GENERAL.....	8
2.3 DUAL HYBRID FRAME – 500/700 -19-54 CARD LAYOUT ( ONE OR TWO TIC CARDS ).....	10
<b>3. INSTALLATION.....</b>	<b>11</b>
3.1 DUAL HYBRID WITH TIC MODULES INSTALLED.....	11
3.2 DUAL HYBRID WITHOUT TIC MODULES INSTALLED.....	11
3.3 SPECIFICATION.....	11
<b>4. CONNECTORS.....</b>	<b>13</b>
4.1 MAINS CONNECTOR - POWER CONNECTION. IEC MAINS.....	13
4.2 MATRIX CONNECTOR – RJ45 CONNECTOR.....	13
4.3 AUDIO CONNECTOR. 9W D CHASSIS PLUG CONNECTOR.....	13
4.4 LINE CONNECTOR. RJ11 CONNECTOR.....	13
4.5 PHONE CONNECTOR. RJ11 CONNECTOR.....	14
<b>5. FRONT PANEL CONTROLS AND INDICATORS.....</b>	<b>15</b>
5.1 I/F POWER LED.....	15
5.2 HYBRID POWER LED.....	15
5.3 COMMS LINK FAIL/OK LED.....	15
5.4 HYBRID ON/OFF LED.....	15
5.5 AUTO SWITCH.....	15
5.6 SEIZE SWITCH.....	15
5.7 DROP SWITCH.....	15
<b>6. 500-19-21 DUAL HYBRID SET-UP.....</b>	<b>17</b>
6.1 INTRODUCTION.....	17
6.2 IMP.....	17
6.3 DIAL TONE / K-BREAK.....	17
6.4 RESET SWITCH.....	17
6.5 PROGRAMMABLE PORT.....	17
<b>7. 500-19-00 TELEPHONE INTERFACE CARD SET-UP.....</b>	<b>19</b>
7.1 INTRODUCTION.....	19
7.2 RING OUT.....	19
7.3 PANEL RING.....	19
7.4 PANEL DTMF.....	19

## **1. INTRODUCTION**

### **1.1 Safety Precautions**

This equipment has been designed and tested to the highest safety standards. The following precautions should be covered to ensure safe operation of the apparatus.

### **1.2 Transportation and Storage**

Careful inspection of the unit must be made after it has been subject to transportation or storage. Any serious damage, which could render it dangerous, must be acted upon to safeguard any potential user.

### **1.3 Mains Connector and Plug**

The supply lead plug shall only be inserted into a supply socket equipped with an earth contact. Extension of the lead must include a suitable conductor for the protective earth.

This equipment must be earthed.

#### CSA requirements

- 1) "The socket outlet shall be installed near the equipment and shall be easily accessible"
- 2) "The Telephone Hybrid utilizes a AC power source; 90-250Vac, 50-60Hz, 0.25 Amps per cord"

### **1.4 Fuses**

Only the specified value and type of fuse must be fitted in the event of a replacement.

The brown supply lead (live) is fitted with a series fuse located in the mains connector fitted on the rear panel. Should the unit be fitted with a two-pin plug then it is possible, if the supply is reversed, for parts of the equipment to remain at supply potential after the fuse has ruptured.

### **1.5 Removal of Covers**

Care must be exercised if the covers of the unit are removed. All internal live parts are covered but the equipment should be disconnected from the supply source before repair or maintenance.

Should it be necessary to carry out adjustments with the supply voltage connected then this work must be done by suitably qualified personnel.

Note that capacitors in power supplies and mains filters can be charged when the equipment is disconnected from the supply. Before commencing work on the unit, these components should be discharged in a safe manner.

It is important to note the designation of securing screws. These must be replaced in the positions to which they were supplied to reduce the possibility of damage to circuit boards mounted close to chassis securing screws.



## 2. SYSTEM DESCRIPTION

### 2.1 Features

The telephone unit is a 1U unit containing a power supply and three printed circuit cards; these provide one or two channels of telephone interface.

The digital hybrid card has smart algorithms to enhance line cancellation and reduce line howl round.

It has software controlled parameters pre-set in the factory.

The front panel controls are simple to use and there are indicators to show the status.

#### Digital Hybrid Card

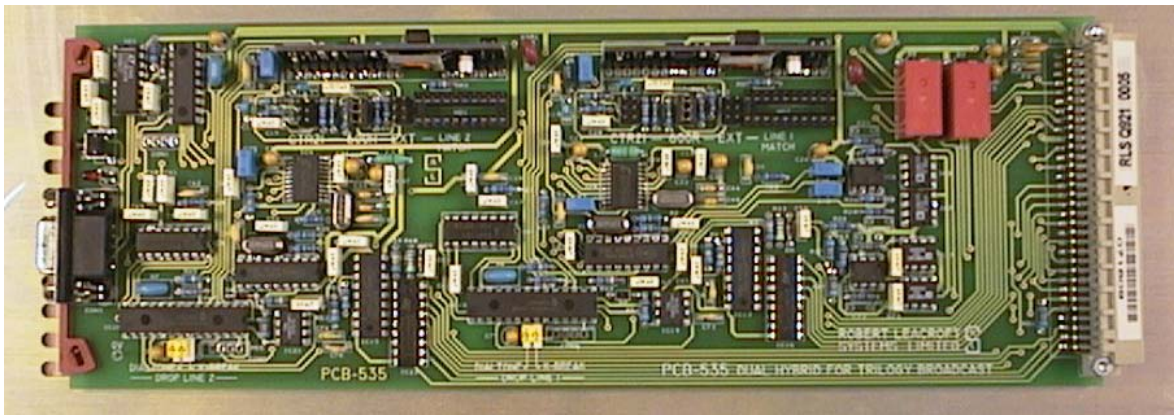

#### Mercury / Commander TIC Card

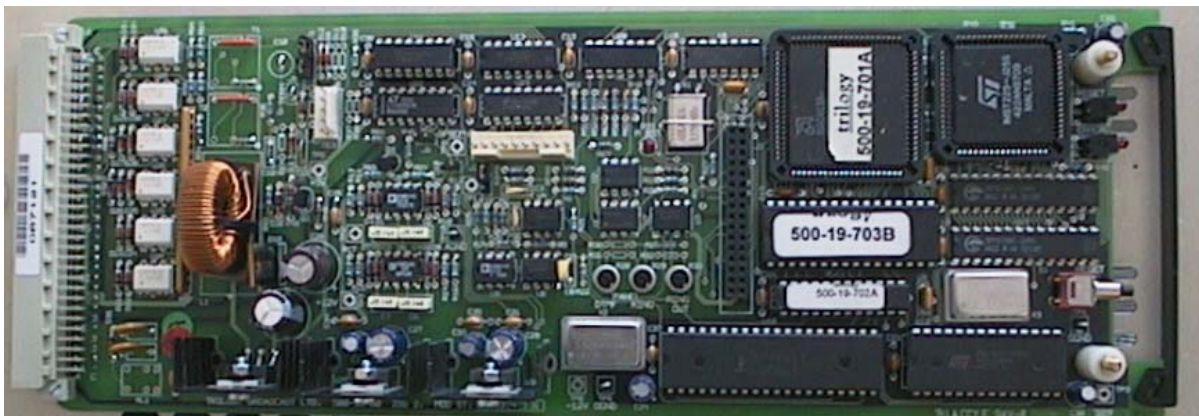

## 2.2 General

The unit contains one dual hybrid card 500-19-21 which can be used as either a means of converting 2 telephone lines to a line level 4 wire circuit or, if installed with one or two TICs (Telephone Interface Card 500-19-00 for Commander and 700-19-00 for Mercury), allow a full DTMF telephone integration with the Trilogy system. For information on the software integration of the frame into a system refer to the Pathfinder User Guide (chapter 17) or the Mercury Configuration Manual.

The following diagram shows a typical installation.

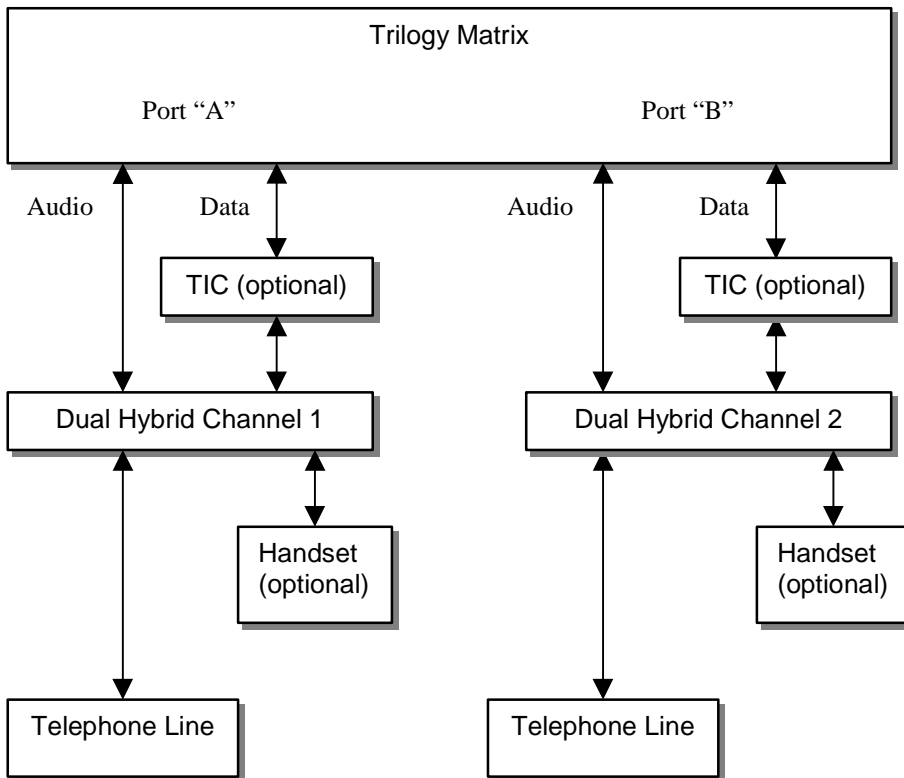

The Dual Hybrid module plugs into the second card slot of the frame, the first and third slots are for channel one and channel two Telephone Interface cards (TIC) respectively.

Each channel of the digital Dual Hybrid has identical features. The line interface has jumper selectable CTR21 or 600 ohms that allows the hybrid to operate in the majority of countries. Also provided on the card is a DIL header to allow the addition of a balance network when required. This is normally done after consulting Trilogy Support.

The provision of the optional parallel handset connection when auto is set to off this allows for manually setting up and answering calls when used in conjunction with the manual seize and drop controls on the Hybrids front panel. If the front panel switch is selected to Auto the parallel handset will be disconnected.



## Front Panel Controls (single channel)

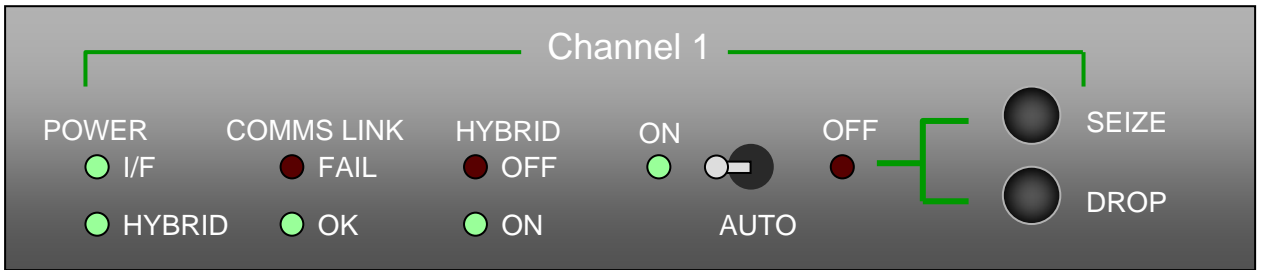

When in Auto mode, an incoming call will be answered with a blip of 2 tones being sent down the line. The tones are an indication to the caller to enter the Direct Dial DTMF tones, if required, to call an individual panel within the Telephone group. This feature is only available when the TIC card is installed. This is set up in the configuration software.

Whilst the Hybrid is active it will detect the presence of continuous tone (dial tone) for 6 seconds or a DC break on the line (K-break) to detect the caller has gone on-hook and to drop the line.

This is done individually for each channel and configured by setting jumpers.

**2.3 Dual Hybrid Frame – 500/700 -19-54 Card layout ( one or two TIC cards )**

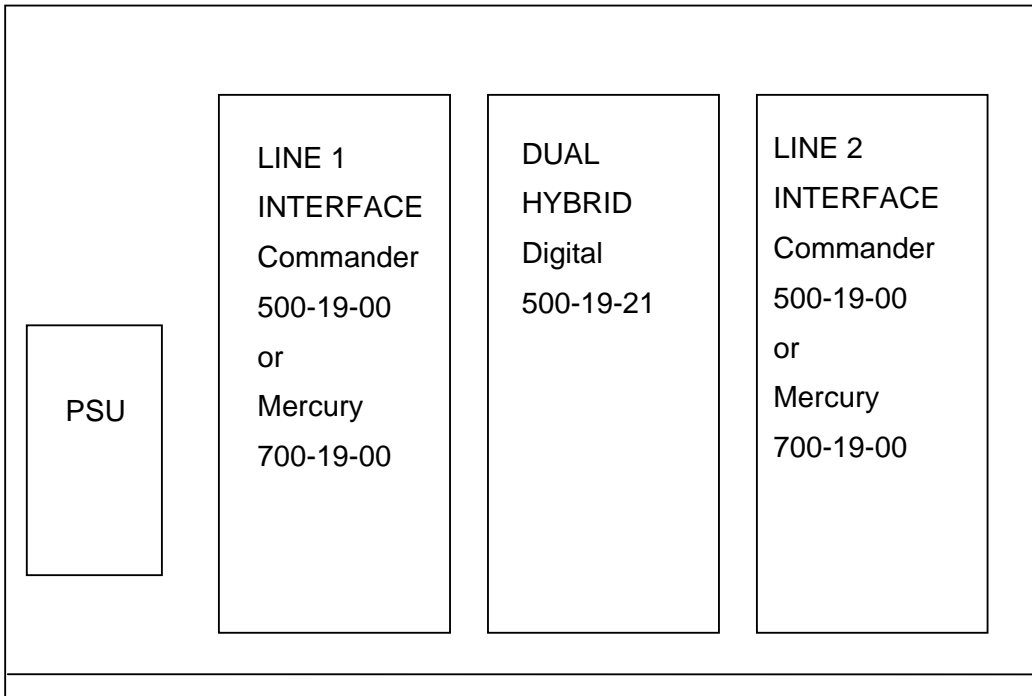

FRONT OF FRAME

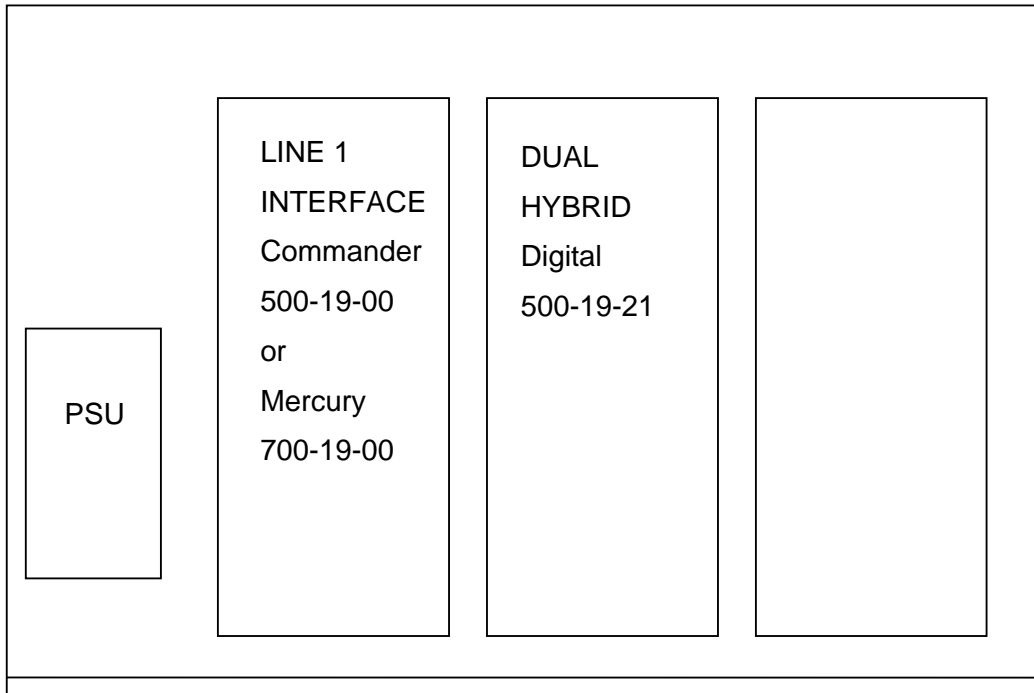

FRONT OF FRAME

### 3. INSTALLATION

#### 3.1 Dual Hybrid with TIC modules installed

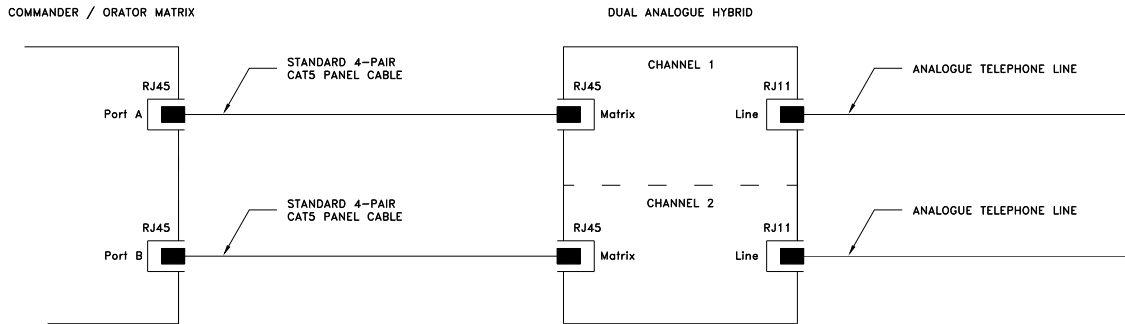

#### 3.2 Dual Hybrid without TIC modules installed

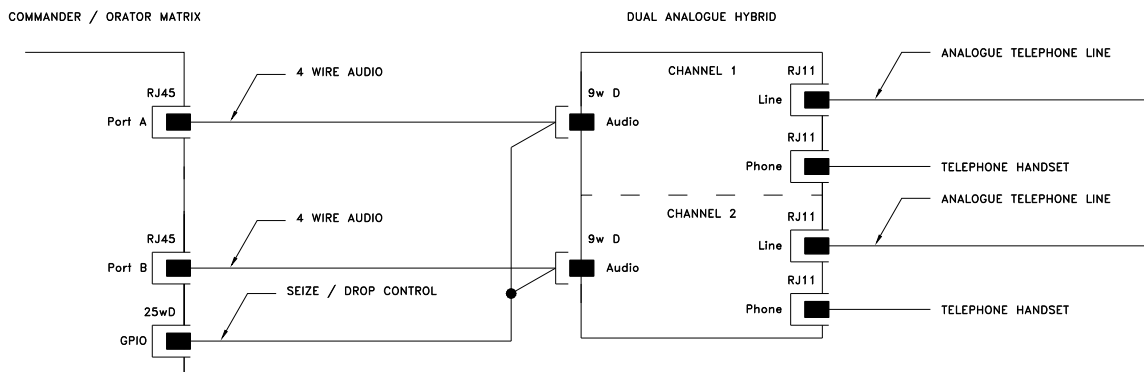

### 3.3 Specification

#### Trilogy 500-19-5x Telephone Interface Frame

Dimensions	485mm wide x 44.5mm high x 440mm deep (excluding connectors) 19" x 1RU rack mounting
Mains Input	90 – 260 V ac, 50-60Hz
Power Consumption	55VA

#### Connector Detail (per channel)

Active link to matrix	RJ45
Audio and Remote Control	D9 Male
Telephone Line	RJ11
Parallel Handset	RJ11



## 4. CONNECTORS

Rear view

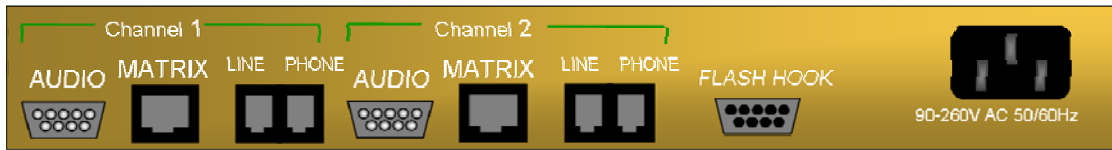

### 4.1 Mains connector - Power connection. IEC mains

Pin Number	Signal	Direction From Unit
L	Live	Input
N	Neutral	Input
E	Earth	Input

### 4.2 Matrix connector – RJ45 connector

Hybrid RJ45 (“Matrix”)	Hybrid Signal	Matrix RJ 45
1 – pair 1	Data RX (a)	1 – pair 1
2 – pair 1	Data RX (b)	2 – pair 1
3 – pair 2	Data TX (a)	3 – pair 2
4 – pair 3	Audio in (b)	4 – pair 3
5 – pair 3	Audio in (a)	5 – pair 3
6 – pair 2	Data TX (b)	6 – pair 2
7 – pair 4	Audio out (a)	7 – pair 4
8 – pair 4	Audio out (b)	8 – pair 4

**Note:** Please ensure that any cables are correctly wired, following the 4-pair wiring indicated above. Failure to do so may lead to incorrect operation of the hybrid frame.

### 4.3 Audio connector. 9w D chassis plug connector.

Pin Number	Signal	Direction From Unit
1.	Chassis ground	Switch Ground
2.	Seize Switch	Input
3.	Drop Switch	Input
4.	Audio Out (-)	Output
5.	Audio in (-)	Input
6.		
7.		
8.	Audio out (+)	Output
9.	Audio in (+)	Input

### 4.4 Line connector. RJ11 connector.

Pin Number	Signal	Direction From Unit
1.		
2.		
3.	Line +	Input / Output
4.	Line -	Input / Output
5.		
6.		

**4.5 Phone connector. RJ11 connector.**

Pin Number	Signal	Direction From Unit
1.		
2.		
3.	Line +	Input / Output
4.	Line -	Input / Output
5.		
6.		

**NOTE**

The Trilogy Dual Hybrid frame should only be connected to a Line via an appropriate approved fuse disconnection barrier.

## 5. FRONT PANEL CONTROLS AND INDICATORS

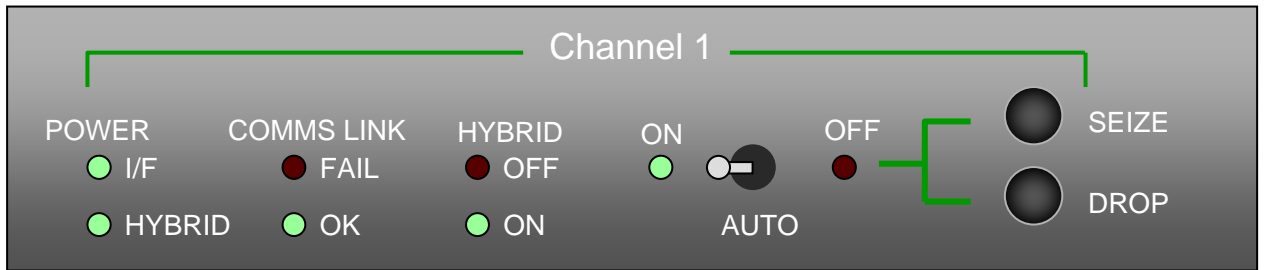

### 5.1 I/F Power LED

Indicates the TIC card is present and powered.

### 5.2 Hybrid Power LED

Indicates the Hybrid card is present and powered.

### 5.3 Comms Link Fail/OK LED

Indicates the state of the data comms between the TIC card and the matrix.

### 5.4 Hybrid ON/OFF LED

Indicates when the Hybrid is ON or OFF hook.

### 5.5 Auto Switch

Enables / disables the Auto answer mode of the Hybrid.

### 5.6 Seize Switch

Manually selects the hybrid off-hook.

### 5.7 Drop Switch

Manually selects the hybrid on-hook.





## 6. 500-19-21 DUAL HYBRID SET-UP

### 6.1 Introduction

The 500-19-21 card carries two identical circuits and is controlled by the 700/500-19-00 interface cards and/or the front panel controls (see the previous section for information on the controls). Jumpers on the card allow matching to different line and exchange conditions as shown below. For details on the positions of the jumpers, please refer to the circuit board legend.

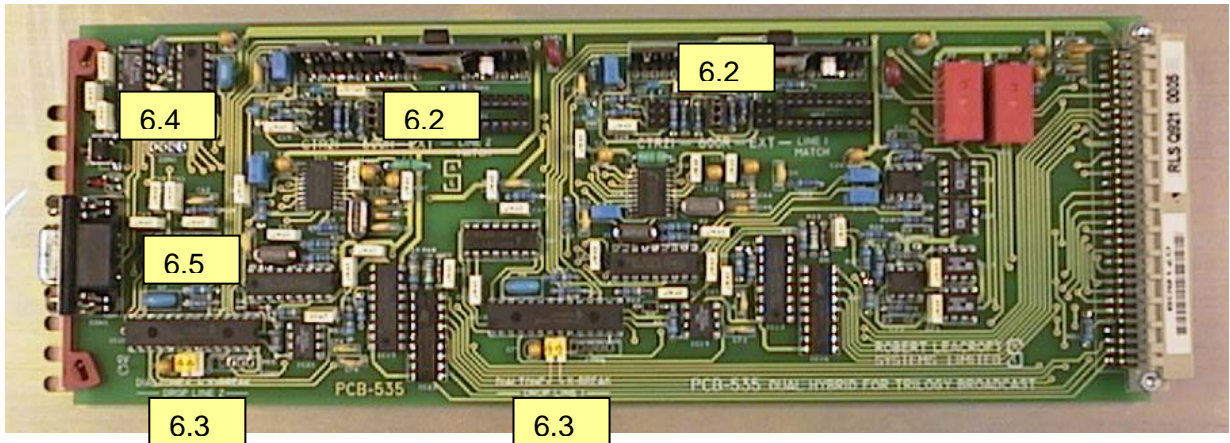

### 6.2 IMP

This jumper allows matching of the line impedance to “CTR21”, to 600R or to a custom network by fitting components onto a plug-in header “Net1/2”. If you are not sure which setting to use , try both “CTR21” and 600R and select the one with the best match to your line impedance, that is the setting with least voice feeding back.

### 6.3 Dial Tone / K-Break

In auto mode the line hold condition can be dropped automatically on detection of continuous dial tone for 6 seconds or by the detection of a break in the line current generated from the exchange, (called K break).

With the jumpers fitted these signals will be detected. In some uses the automatic clearing by one or both methods might be a problem and the required jumper can be removed to disable detection.

### 6.4 Reset Switch

You can return the card to Factory Default by pressing and holding the button for about 6 seconds. It will give 10 slow flashes and then speed up. When it speeds up let go and it will be reset.

### 6.5 Programmable Port

This is for factory use only.

**The Trilogy Dual Hybrid frame should only be connected to a Line via an appropriate approved fuse disconnection barrier.**



## 7. 500-19-00 TELEPHONE INTERFACE CARD SET-UP

### 7.1 Introduction

The 700-19-00 interface card acts as a buffer between the hybrid that connects directly to the telephone line and the audio and data circuits of the Commander matrix. Each card interfaces one telephone line to one matrix port. The card is largely digital, but there are three level controls that although factory pre-set, can be varied if necessary

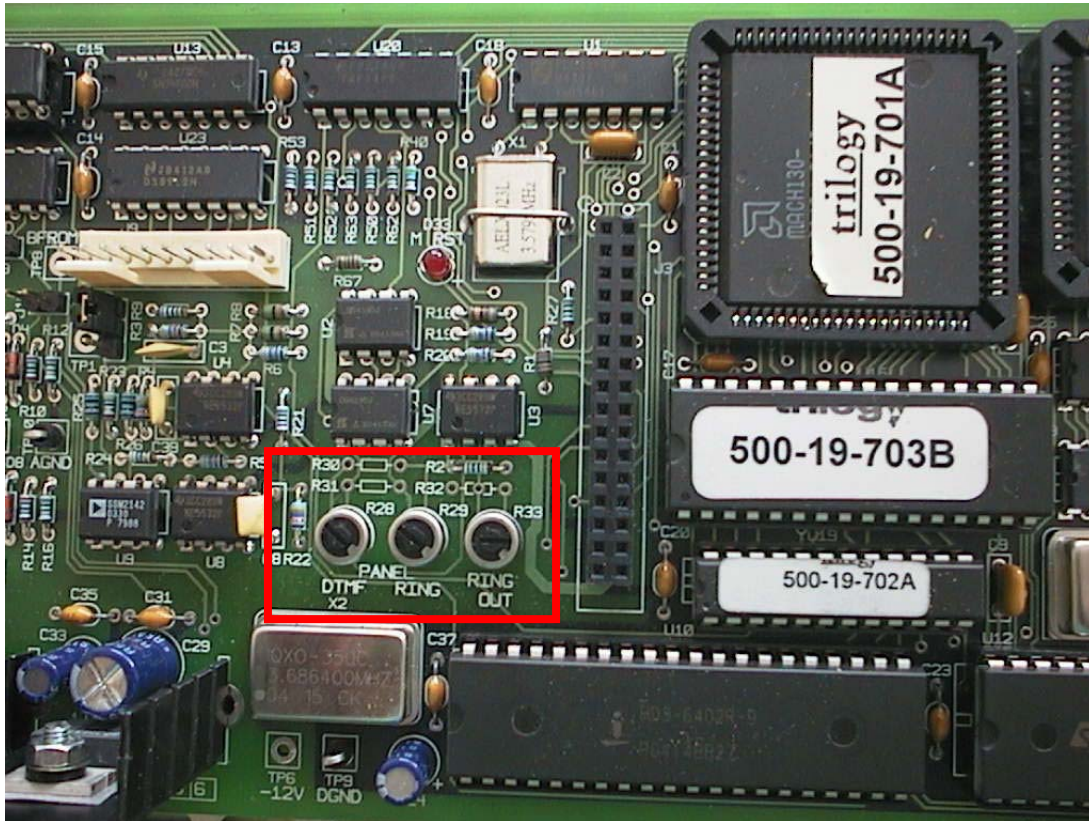

### 7.2 Ring Out

This function that is pre-set by R33 controls the ring level heard at the caller's earpiece when dialling in.

### 7.3 Panel Ring

This function that is pre-set by R29 controls the ring level at the panel when receiving an incoming call:-

### 7.4 Panel DTMF

This function that is pre-set by R28 controls the level of DTMF on the local panel's loudspeaker when dialling out from the panel:

## Free Manuals Download Website

<http://myh66.com>

<http://usermanuals.us>

<http://www.somanuals.com>

<http://www.4manuals.cc>

<http://www.manual-lib.com>

<http://www.404manual.com>

<http://www.luxmanual.com>

<http://aubethermostatmanual.com>

Golf course search by state

<http://golfingnear.com>

Email search by domain

<http://emailbydomain.com>

Auto manuals search

<http://auto.somanuals.com>

TV manuals search

<http://tv.somanuals.com>