

High Definition Digital Video Camera 990HD

User's Manual

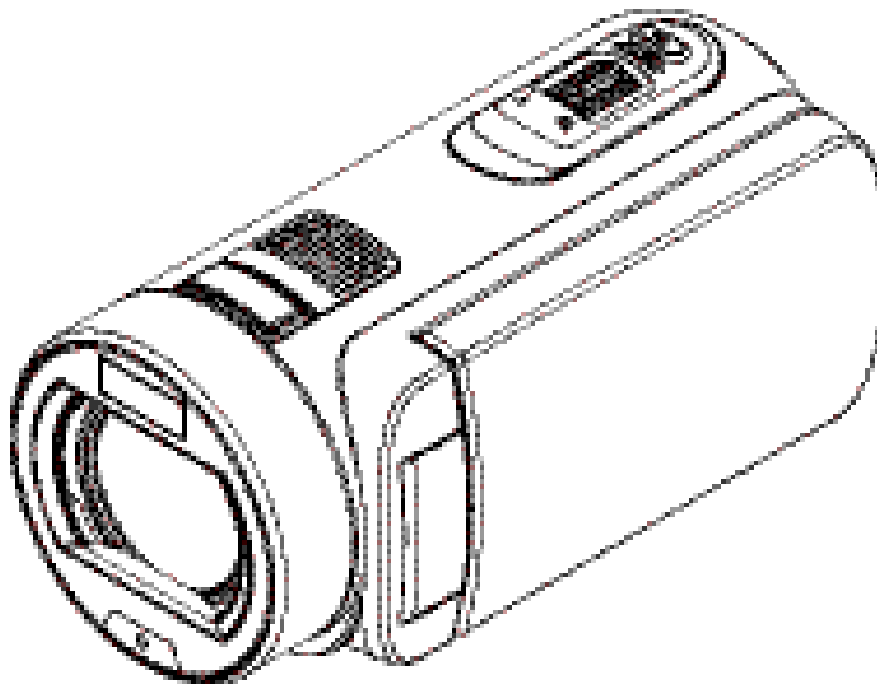

Vivitar[®]
we make it easy[™]

© 2009-2011 Sakar International, Inc. All rights reserved.
Windows and the Windows logo are registered trademarks of Microsoft Corporation.
All other trademarks are the property of their respective companies.

Read This Before Using the Camera

SAFETY INSTRUCTIONS

- Do not drop, puncture or disassemble the camera.
- Use the camera with care. Rough handling may damage the internal components.
- Do not expose the camera to high temperature. Avoid contact with water.
- Please notice that the camera body may become warm when operating it for an extended period.
- Test for proper operation before using the camera.
- Only use accessories supplied by the manufacturer.
- Use only the type of battery that came with your camera.
- Remove the battery if the camera is not going to be used for long periods.

Product Information

- Designs and specifications of the camera are subject to change without notice. This includes primary product specifications, software, and this User's Manual.
- This User's Manual is a general reference guide for the camera.
- The illustrations in this manual may not be the same as the actual design of your camera and those you see on the LCD screen.

Contents

Read This Before Using the Camera	2
Section 1 Getting to Know Your Camera.....	4
Section 2 Getting Started.....	7
Section 3 Enjoying the Record Mode	9
Section 4 Enjoying the Playback Mode.....	21
Section 5 Setting Your Camera	26
Section 6 Viewing Photos and Videos on TV.....	30
Section 7 Using the Software	31
Section 8 Transferring Media	34
Section 9 Sakar Warranty Card	35
Section 10 Technical Support	37
Section 11 Specifications and System Requirements	36
Section 12 Troubleshooting	38

Section 1

Getting to Know Your Camera

Overview

The camera is equipped with a 5 Mega Pixel sensor that can take H.264 format videos. The H.264 technology allows for extended video recording with less memory. High quality images up to 16 megapixels can also be delivered smoothly. With a color LCD monitor, you can view and examine the videos and photos easily.

The camera features 3" (16:9) LCD touch panel which is an ideal platform for you to operate your camera. The menu options are accessible with your finger. With the touch panel, you can select the options directly and quickly.

The camera also features video recording at an HD resolution of 1920x1080. You can also connect it to an HDTV via an HDMI cable, and easily playback the recorded high-definition videos on the wide screen HDTV.

Moreover, the CD included with the camera has an advanced uploading feature. With the exclusive **Vivitar Experience Image Manager** application, you can upload videos and photos captured by the camera to online social network sites effortlessly .

ISO sensitivity and color balance can either be adjusted automatically or changed manually. A 23 x Optical zoom helps you to control over the videos and photos you take.

The varied effect options, such as Time Lapse and Slow Motion, make recording more fun.

The built-in memory allows you to take photos and to record videos without a memory card. The memory card slot allows users to increase the storage capacity.



Note

- *Partial memory of the built-in memory is used for the camera's Firmware code and software.*
- *Install the bundled software application on the CD, Vivitar Experience Image Manager, for viewing the videos and photos on a PC.*

Standard Accessories

Unpack the package and make sure all standard accessories listed are included:

- Camera
- USB Cable
- AV Cable
- HDMI Cable
- Adaptor
- Lithium-ion Rechargeable Battery
- Camera Easy Guide
- CD-ROM (Software, User's Manual)
- Pouch
- Lens Cover Set (Lens cover and Strap)

Front View

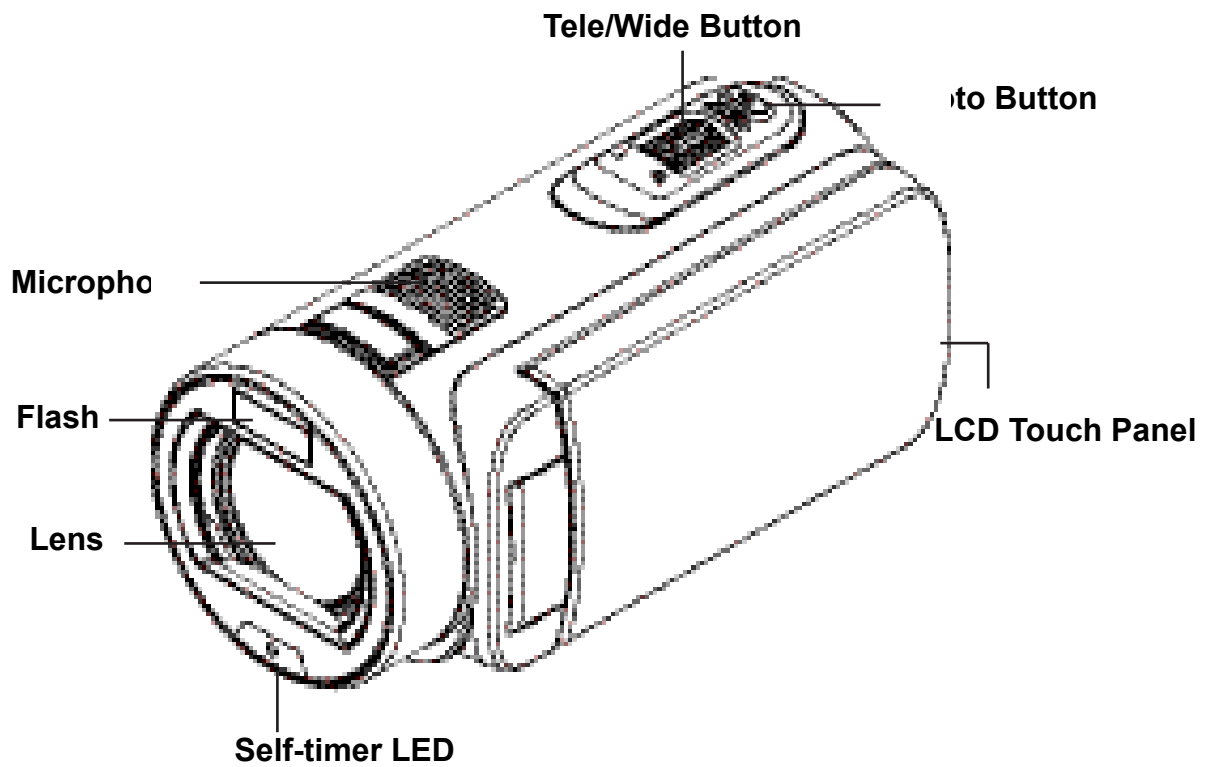

Rear View

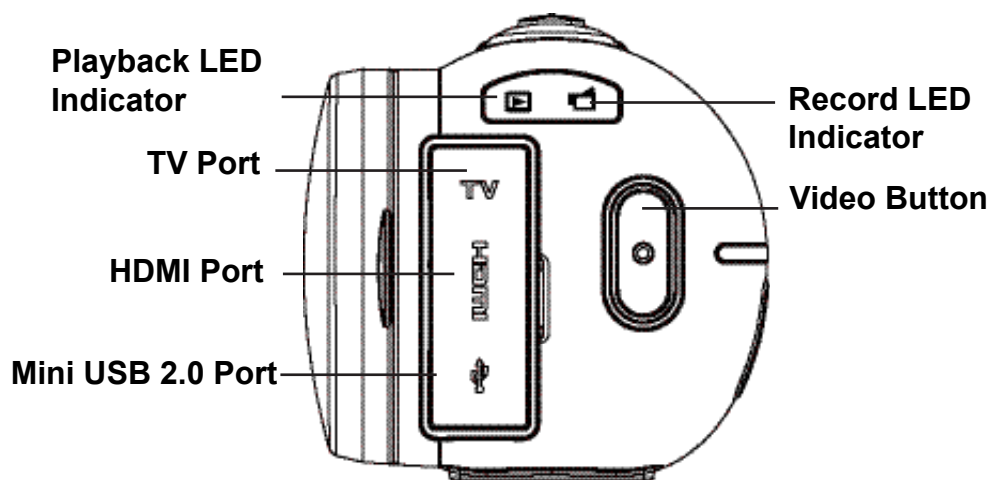

Side View

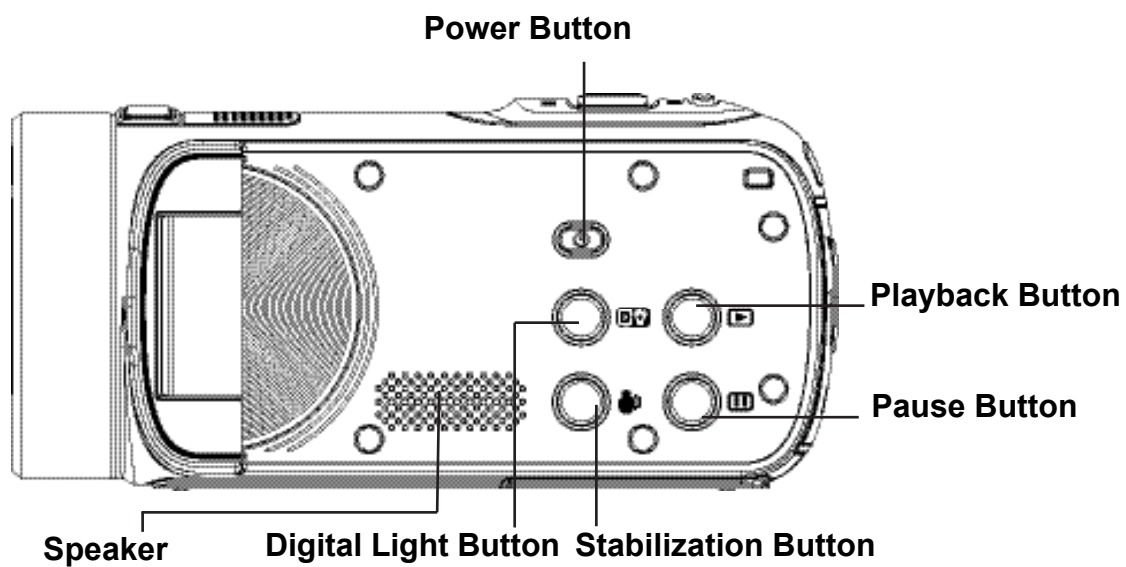

Bottom View

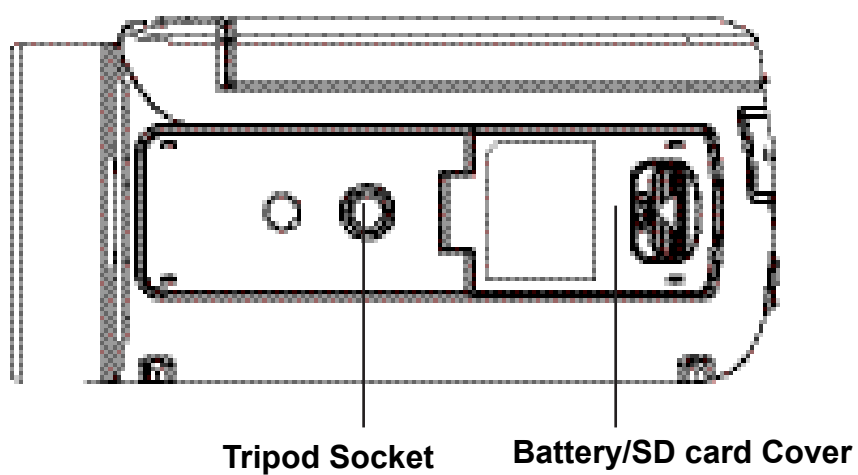

Section 2 Getting Started

Loading the Battery

Before using the camera, you must load the Lithium-ion rechargeable battery come within the package.

1. Insert the battery according to the correct polarity marks (+ or -).
2. Close the battery cover firmly.

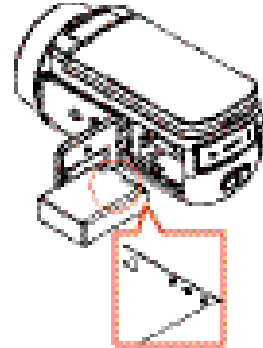

Charging the Battery

You must use the supplied AC charger or the USB cable. The camera must be turned OFF. The blinking light confirms the camera is currently charging, and the light becomes constant after the charging is completed. In AC charging Mode, the light will turn itself off automatically after 3~5 minutes. The full charge time is about 4 to 5 hours. (Actual charging time may vary. It depends on the battery conditions.)

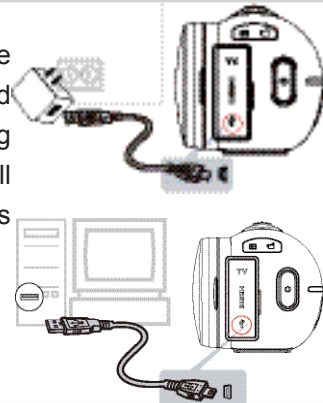

Inserting and Removing an SD Card (Optional)

The camera comes with an internal memory that allows you to store photos and videos. You can expand the memory capacity by using an optional SD memory card.

1. Insert the memory card into the slot. Please refer to the figure on the right side.
2. To remove the installed SD card, press the card inward to release it.
3. When the card pops out, gently remove it from its slot.
4. Recommended memory capacity: 1GB or above.

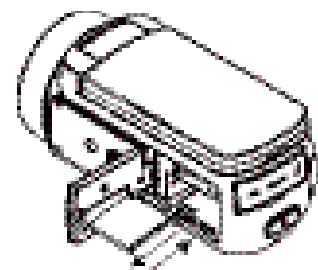

Note

- When a memory card is fitted, videos/photos are saved to the card rather than the built-in memory.
- Protecting Data on an SD Card: SD Card is read-only when it is locked. No photos or videos can be recorded when the SD card is locked. Make sure the lock is on the writeable position before recording any media.

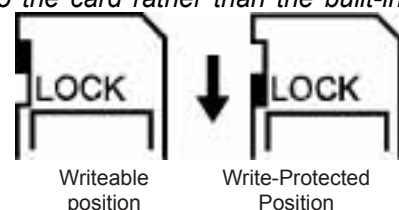



Turning the Camera On

- To turn on the camera:
 - Flip out the LCD panel; the camera will turn on automatically.
 - Or press [Power Button] for approximately one second to turn it on.

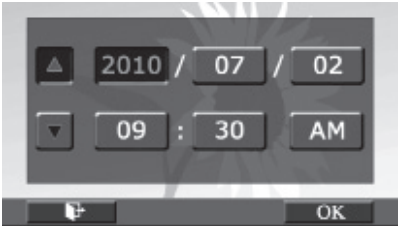

Configuring the Initial Date and Time Setup

- The time setting screen appears to allow you to setup date and time:

Operation	Display Screen
<ol style="list-style-type: none"> Touch Year, Month, Day, Hour, Minute, and AM/PM to set. Adjust the numeric value by touching  /  Touch the [OK] icon to validate the setting. Touch the Exit icon () to exit. 	

Getting Started

- To record video: Press [Video Button] to record video. To stop recording, press it again.
- To pause recording: Press [Pause Button] to pause recording. To continue the recording, press it again.
- To take a photo during video recording: When recording video, press [Photo Button] to capture the image. The Dual record icon () appears on the LCD monitor.
- To take a photo: Press [Photo Button] halfway down until the focusing frame turns from white to green. Then, press it fully down to take photo.

	
Focusing Frame: White	Focusing Frame: Green

- To view stored videos and photos: Press [Playback Button] or touch  on the screen to switch to the Playback mode.









Turning the Camera Off

- To turn off the camera: You can either press [Power Button] for one second, or you can place the LCD panel back to its original position.

Section 3

Enjoying the Record Mode









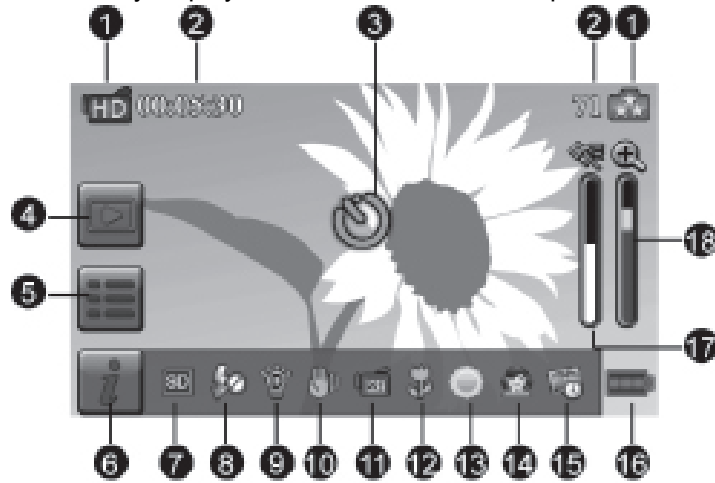





Button Function



























	<p>Video Button:</p> <ol style="list-style-type: none"> 1. Press to take video. 2. To stop recording, press it again.
	<p>Photo Button:</p> <ol style="list-style-type: none"> 1. Press to take photo. 2. When recording video, press to capture the image.
	<p>Tele Button:</p> <ol style="list-style-type: none"> 1. Zoom In. <p>Wide Button</p> <ol style="list-style-type: none"> 1. Zoom out.
	<p>Power Button:</p> <ol style="list-style-type: none"> 1. Press down for one second to turn on or turn off the camera.
	<p>Playback Button:</p> <ol style="list-style-type: none"> 1. Switch between Record / Playback Mode. 2. For quick review, press it after recording.
	<p>Pause Button:</p> <ol style="list-style-type: none"> 1. Press to pause the recording. 2. To continue the recording, press it again.
	<p>Digital Light Button:</p> <p>Digital Light On/Off.</p>
	<p>Stabilization Button:</p> <p>Stabilization On/Off.</p>

LCD Monitor Information

The indicators shown below may display on LCD when videos and photos are recorded:



(1)	Video Resolution	
		Full HD (1080p 30 fps)
		HD (720p 60 fps)
		HD (720p 30 fps)
		VGA (640X480)
		Slow Motion (Record video at 432x240(QVGA) resolution.)
	Photo Resolution	
	16MP	
	5MP	
	3MP	
(2)	00:05:30	Recording time of the video that can still be taken at current resolution
	71	Number of images that can still be taken at current resolution
(3)		Self-timer enabled
		Dual Record
(4)		Playback Mode On
(5)		Menu On
(6)		Information bar On
(7)		SD Card Inserted





(8)		Flash Auto (Photo Recording Only)
		Red Eye Reduction (Photo Recording Only)
		Flash Off
(9)		Digital Light On
(10)		Stabilization
(11)		Pre-Record Mode
		Time Lapse
		Smile Detection
(12)		Macro Focusing On
(13)		Daylight
		Fluorescent
		Tungsten
(14)	Scene	
		Skin
		Night
		Backlight
		Black/White
		Classic
(15)		Negative
		Date Printing On
(16)		Battery: full power
		Battery: medium power
		Battery: low power
		Battery: empty power
		DC power mode
(17)		Motion Detection
(18)		Zoom meter: 1X~2700X (23X Optical zoom and 120X Digital zoom)







Note

- Stabilization, Time Lapse, and Slow Motion functions can not be used simultaneously.
- Stabilization and Night Mode functions can not be used simultaneously.
- Pre-Record, Motion Detect, Slow Motion, and Time Lapse functions can not be used simultaneously.

Video Recording

- Press [Video Button] to start recording. When a video is being recorded, a time indicator will display on the LCD monitor ( 00:00:25). To stop recording, press it again.
- To pause recording: Press [Pause Button] to pause recording ( 00:00:36). To continue the recording, press it again.
- Dual record: press [Photo Button] to capture the image. The Dual record icon () appears on the LCD monitor.
- Press [Playback Button] or touch  on the screen to view the recorded video.
- Four resolution settings are available:

Video Quality	
	Full HD (1080p 30 fps)
	HD (720p 60 fps)
	HD (720p 30 fps)
	VGA (640X480)



Note

- The image resolution captured during video recording is the same as the video resolution.
- The flash can not be used when capturing image during movies recording.

Photo Capturing





- Press [Photo Button] halfway down until the focusing frame turns from white to green. Then, press it fully down to take photo.
- Press [Playback Button] or touch  on the screen to view the photos.
- Three resolution settings are available:

Image Quality	
	16 Mega Pixels
	5 Mega Pixels
	3 Mega Pixels

Using Zoom Function

- The zoom magnifies images when recording video or taking photo.
 1. To zoom in/out, press the Tele/Wide Button.
 2. It can be set from 1X~2700X (23X Optical zoom)

Using Digital Light Function





- The setting allows you to extend the brightness of the objects that are dark or in the shadow. It can extend the dynamic range for backlight and high contrast sense, so that the objects will be brighter and clearer.
- To use the Digital Light function:
 - Press [Digital Light Button] in Record Mode. The Digital Light icon() appears on the LCD monitor.
 - Press [Video Button] to start recording or press [Photo button] to take photo.

Using Stabilization Function





- To record with an effect of reducing camera shake to result in more stable video.
- To use the Stabilization function:
 - Press [Stabilization Button] in Record Mode. The Stabilization icon() appears on the LCD monitor.
 - Press [Video Button] to start recording.

Showing Information on the screen

- Touch the on-screen button to display or not to display the indicators on the LCD screen.





Operation	Screen
1. Touch  on the screen. The information bar will display on the screen. 2. Touch again to hide all indicators.	
3. Touch  to display the indicators.	 

Options for Record Menu



Video	Photo	Effect	Setting*
			
<ul style="list-style-type: none"> • Resolution • Pre-record • Motion Detect • Slow Motion • Time Lapse 	<ul style="list-style-type: none"> • Resolution • Flash • Self-Timer • Smile Detect • ISO 	<ul style="list-style-type: none"> • Scene • WB(White Balance) • Macro Mode • Face Tracking 	<ul style="list-style-type: none"> • Sound • TV • Language • Time Setting • Date Printing • Format • Default Setting

* Please refer to Section 5 for the detailed information about [Setting].

Operations for Record Mode

Operation	Display Screen
<p>1. Touch  on the screen in Record Mode. The menu will appear on the screen.</p>	
<p>2. Touch the option icons on the screen lightly with your finger. The options are Video, Photo, Effect, and Setting.</p> <p>3. The option submenus will pop up on the screen.</p> <p>4. Touch to select the specific option you want to adjust. (The selected option will be highlighted.)</p> <p>5. Touch the Exit icon () to exit.</p>	



Video

Operation	Display Screen
<ol style="list-style-type: none"> 1. Touch  on the screen in Record Mode. The menu will appear on the screen. 2. Touch the [Video] icon on the screen. Submenu of Video will pop out on the screen. 3. The Video submenu contains 5 options-- Resolution, Pre-record, Motion Detect, Slow Motion, and Time Lapse --for you to adjust the camera settings. 	

Video Resolution



Four resolution settings are available.

- **FHD (1080p 30)**: Record videos at 1920x1080p 30 fps resolution.
- **HD+ (720p 60)**: Record videos at 1280x720p 60 fps resolution.
- **HD (720p 30)**: Record videos at 1280x720p 30 fps resolution.
- **VGA (640x480)**: Record videos at 640x480p 30 fps resolution.

Operation	Display Screen
<ol style="list-style-type: none"> 1. In the Video menu, touch the [Resolution] icon on the screen. 2. Touch to select the desired option. 3. Touch the Exit icon () to exit. 	

Pre-record

The Pre-record function ensures that you will not miss any critical recording opportunities. The videos are recorded 3 additional seconds before the [Video Button] is pressed.

Operation	Display Screen
<ol style="list-style-type: none"> 1. In the Video menu, touch the [Pre-record] icon on the screen. 2. Touch to select [Off] or [On] (<input checked="" type="checkbox"/> <input type="checkbox"/>). 3. Touch the Exit icon () to exit. 	





Note

- Aim the camera at the subject and position it securely.



Motion Detection

Record videos automatically when the camera detects a movement.

Operation	Display Screen
<ol style="list-style-type: none"> In the Video menu, touch the [Motion Detect] icon on the screen. Touch to select [Off] or [On] (<input type="checkbox"/> <input checked="" type="checkbox"/> <input type="checkbox"/> <input checked="" type="checkbox"/>). Touch the Exit icon () to exit. The camera will start to record video automatically if it detects a movement. The camera stops recording if it does not detect a movement. 	

Slow Motion

Record videos with slow motion effect. When the video is played, the playback time will be longer than the actual recording time.

Operation	Display Screen
<ol style="list-style-type: none"> In the Video menu, touch the [Slow Motion] icon on the screen. Touch to select [Off] or [On] (<input type="checkbox"/> <input checked="" type="checkbox"/> <input type="checkbox"/> <input checked="" type="checkbox"/>). Touch the Exit icon () to exit. 	





Note

- *Pause function can not be used when Slow Motion function is activated.*

Time Lapse

Record still images at specific intervals you can set and play them as one video file.

- **Off:** Disable Time Lapse.
- **1 Second.:** Record one frame per second.
- **3 Seconds:** Record one frame every 3 seconds.
- **5 Seconds:** Record one frame every 5 seconds.

Operation	Display Screen
<ol style="list-style-type: none"> In the Video menu, touch the [Time Lapse] icon on the screen. Touch to select the desired option. Touch the Exit icon () to exit. 	



Note

- *Pause function can not be used when Time Lapse function is activated.*

Photo





Operation	Display Screen
<ol style="list-style-type: none"> 1. Touch  on the screen in Record Mode. The menu will appear on the screen. 2. Touch the [Photo] icon on the screen. Submenu of Photo will pop out on the screen. 3. The Photo submenu contains 5 options for you to adjust the camera settings -- Resolution, Flash, Self-Timer, Smile Detect, and ISO. -- 	

Photo Resolution

Three photo resolution settings are available.

- **16MP:** Shoot photo at 4608 x 3456, 16MP quality.
- **5MP:** Shoot photo at 2592 x 1944, 5MP quality.
- **3MP:** Shoot photo at 2048 x 1536, 3MP quality.

Operation	Display Screen
<ol style="list-style-type: none"> 1. In the Photo menu, touch the [Resolution] icon on the screen. 2. Touch to select the desired option. 3. Touch the Exit icon () to exit. 	

Flash

This camera has three flash settings.

- **Flash Auto:** The flash fires automatically according to light conditions. Use this mode for general photography.
- **Red Eye Reduct.** (Red Eye Reduction) :The pre-flash will fire to reduce the red-eye effect.
- **Flash Off:** The flash will not fire under any circumstances. Use this mode when taking photo in a place where flash photography is prohibited, or when the subject is distant (beyond the range of the flash).

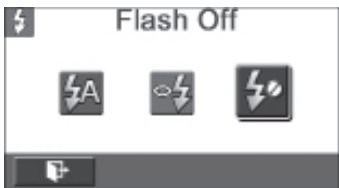
Operation	Display Screen
<ol style="list-style-type: none"> 1. In the Photo menu, touch the [Flash] icon on the screen. 2. Touch to select the desired option. 3. Touch the Exit icon () to exit. 	





Note

The flash will be disabled automatically when the battery power is low ().





Self-Timer

The Self-Timer allows you to take photos with a ten-second time delay. The Self-Timer light on the front of the camera will also blink. The speed of blinking will increase just before the photo is taken.

Operation	Display Screen
<ol style="list-style-type: none"> In the Photo menu, touch the [Self-Timer] icon on the screen. Touch to select [Off] or [On] (<input type="checkbox"/> <input checked="" type="checkbox"/> <input type="checkbox"/>). Touch the Exit icon () to exit. 	

Smile Detection

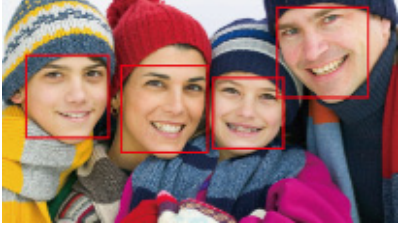
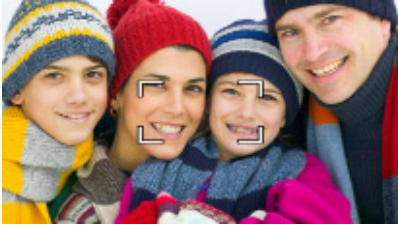
Capture an image automatically when the camera detects a smile.

Operation	Display Screen
<ol style="list-style-type: none"> In the Photo menu, touch the [Smile Detect] icon on the screen. Touch to select [Off] or [On] (<input type="checkbox"/> <input checked="" type="checkbox"/> <input type="checkbox"/>). Touch the Exit icon () to exit. 	   

ISO

The camera adjusts the ISO sensitivity of its images automatically. Four manual ISO sensitivity settings are available. (800/1600/3200/6400). The larger the number is, the higher the ISO sensitivity is set. Select a small number to shoot a smoother image. Select a large number to shoot an image in a dark location or to shoot a subject moving at high speed.

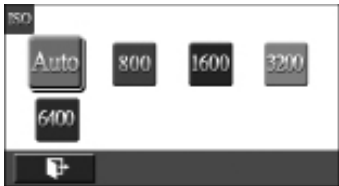

Operation	Display Screen
<ol style="list-style-type: none"> 1. In the Photo menu, touch the [ISO] icon on the screen. 2. Touch to select the desired option. 3. Touch the Exit icon () to exit. 	



Note

The image may become noisy when the ISO number is large.



Effect

Operation	Display Screen
<ol style="list-style-type: none"> 1. Touch  on the screen in Record Mode. The menu will appear on the screen. 2. Touch the [Effect] icon on the screen. Submenu of Effect will pop out on the screen. 3. The Effect submenu contains 4 options for you to adjust the camera settings -- Scene, White Balance, Macro Mode, and Face Tracking. 	

Scene

You can select the mode according to the scene condition.

- **Auto:** Shoot without any special effect on the image.
- **Skin:** Shoot with an effect that makes skin tones more natural.
- **Night:** Use Night Mode for night scenes or low light conditions.
- **Backlight:** You can take shots when the bright light is behind the subject.
- **Black/White:** The image is converted to black-and-white.
- **Classic:** The image is converted to a sepia look.
- **Negative:** The image is converted as the negative of the normal.

Operation	Display Screen
<ol style="list-style-type: none"> 1. In the Effect menu, touch the [Scene] icon on the screen. 2. Touch to select the desired option. 3. Touch the Exit icon () to exit. 	





Note

To avoid blurry photos, place the camera on a flat, steady surface, or use a tripod when taking shots in the Night Mode.

White Balance

The camera adjusts the color balance of images automatically. Three manual white balance settings are available:

- **Auto:** The camera automatically adjusts white balance.
- **Daylight:** Under outdoor condition.
- **Fluorescent:** Under fluorescent light condition.
- **Tungsten:** Under tungsten light condition.

Operation	Display Screen
<ol style="list-style-type: none"> 1. In the Effect menu, touch the [White Balance] icon on the screen. 2. Touch to select the desired option. 3. Touch the Exit icon () to exit. 	

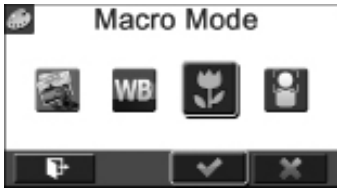

Macro Mode

You can select the Macro mode for recording close-up videos and photos.

Operation	Display Screen
<ol style="list-style-type: none"> 1. In the Effect menu, touch the [Macro Mode] icon on the screen. 2. Touch to select [Off] or [On] (<input checked="" type="checkbox"/> <input type="checkbox"/>). 3. Touch the Exit icon () to exit. 	

Face Tracking

The camera can detect human face(s) and focus on the face(s) automatically. This function works with video recording and photo capturing. It is wonderful for capturing beautiful portraits in a backlight situation.

Operation	Display Screen
<ol style="list-style-type: none"> 1. In the Effect menu, touch the [Face Tracking] icon on the screen. 2. Touch to select [Off] or [On] (<input checked="" type="checkbox"/> <input type="checkbox"/>). 3. Touch the Exit icon () to exit. 	 



Note





When Face Tracking is activated, aim the camera at the human face(s). The focus frame(s) will appear on the LCD before the [Video Button]/[Photo Button] is pressed.

Section 4

Enjoying the Playback Mode

Button Function









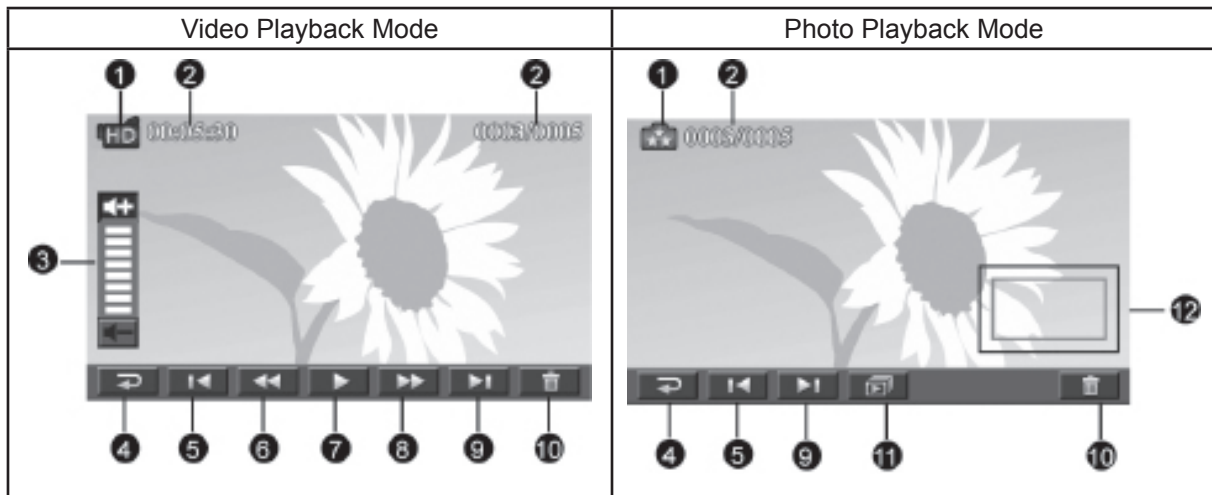





The Buttons have the following functions in Playback Mode.









	Video Button: 1. Switch to Record Mode.
	Tele Button: 1. Zoom In. Wide Button 1. Zoom out.
	Playback Button: 1. Switch between Record / Playback Mode. 2. For quick review, press it after recording.
	Pause Button: 1. In Video Playback Mode, press to pause the recorded video.

LCD Monitor Information

Indicators on the LCD screen while in Playback Mode:







(1)	Video Resolution	
		Full HD (1080p 30 fps)
		HD (720p 60 fps)
		HD (720p 30 fps)
		VGA (640X480)
		Slow Motion (432x240(QVGA))
	Photo Resolution	
		16MP
		5MP
		3MP
	Dual Record (The image resolution captured during videos recording is the same as the video resolution.)	
(2)	00:05:30	Video playback time counter.
	0003/0005	Current number/ Total number of photo/video.
(3)		Volume
(4)		Return
		Video stop
(5)		Previous video/photo
(6)		Video fast rewind











(7)		Video play
		Video pause
(8)		Video fast forward
(9)		Next video/photo
(10)		Delete
(11)		Slide Show
		Slide Show stop
(12)		Magnification Indicator

Operations for Playback Mode

The Playback Mode allows you to view and manage your captured videos and photos from the built-in memory or from the SD Card.

Operation	Display Screen
1. Press [Playback Button] or touch  on the screen to switch to the Playback mode.	
2. Touch to select the specific option. 3. Touch () to back to Record Mode.	

Video Playback



Operation	Display Screen
<ol style="list-style-type: none"> 1. In the Video Playback mode, touch  /  to play or pause the videos. 2. Sweep to the right or touch  to go to the previous video; sweep to the left or touch  to go to the next video. 3. While playing videos, touch  /  to fast rewind/forward. 4. Touch  to increase the volume; touch  to reduce the volume. 5. Touch () to exit. 	



Note

- When the LCD is idle for a few seconds, the playback function icons will disappear automatically.

Delete Videos

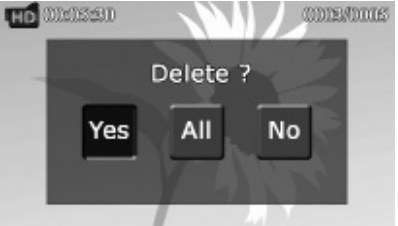
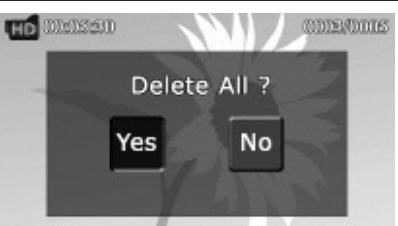





Operation	Display Screen
<ol style="list-style-type: none"> 1. Touch  to go to the Delete option screen. 	
<ol style="list-style-type: none"> 2. Touch [Yes] to delete the current video or [No] to cancel the operation and to exit; touch [All (Delete All)] to delete all videos. 3. Before all videos are about to be deleted, a confirmation screen will appear; touch [Yes] to execute the operation and [No] to cancel the operation. 	
	



Note

- If a memory card has been inserted, you can only delete those videos stored on the card.
- Videos on a written-protected memory card cannot be deleted.

Photo Playback





Operation	Display Screen
<ol style="list-style-type: none"> In the Photo Playback mode, sweep to the right or touch  to go to the previous photo; sweep to the left or touch  to go to the next photo. While the photo is selected, press [Tele Button] to magnify. (The Magnification Indicator appears on the screen) To navigate the magnified photo, press on the screen and move as well. (The inner Magnification Indicator turns red) Press [Wide Button] to zoom out or exit the magnification mode. Touch  /  to start or to stop the Slide Show. Touch () to exit. 	



Note

- When the LCD is idle for a few seconds, the playback function icons will disappear automatically.

Delete Photo

Operation	Display Screen
<ol style="list-style-type: none"> Touch  to go to the Delete option screen. 	
<ol style="list-style-type: none"> Touch [Yes] to delete the current photo or [No] to cancel the operation and to exit; touch [All (Delete All)] to delete all photos. Before all photos are deleted, a confirmation screen will appear; touch [Yes] to execute the operation and [No] to cancel the operation. 	 





Note

- If a memory card has been inserted, you can only delete those photos stored on the card.
- Photos on a written-protected memory card cannot be deleted.

Section 5



Setting Your Camera

Setting Menu

Operation	Display Screen
<ol style="list-style-type: none"> 1. Touch  on the screen in Record Mode. The menu will appear on the screen. 2. Touch the [Setting] icon on the screen. The Setting Submenus will appear on the screen. 3. The Setting submenu contains 7 options for configuring your camera setup: Sound (operation sound), TV, Language, Time Setting, Date Printing, Format, and Default Setting. 	

Sound



Enable or disable the keypad tone and the operation sound.

Operation	Display Screen
<ol style="list-style-type: none"> 1. In the Setting menu, touch the [Sound] icon on the screen. 2. Touch to select [Off] or [On] (<input type="checkbox"/> <input type="checkbox"/>). 3. Touch the Exit icon () to exit. 	

TV



Ensure that the appropriate TV standard of your area is selected – either NTSC or PAL. Wrong TV system setting may cause image flickers.

- **NTSC**(60Hz):USA, Canada, Japan, South Korea and Taiwan, etc.
- **PAL**(50Hz):UK, Europe, China, Australia, Singapore and Hong Kong, etc.



Operation	Display Screen
<ol style="list-style-type: none"> 1. In the Setting menu, touch the [TV] icon on the screen. 2. Touch to select [PAL] or [NTSC]. 3. Touch the Exit icon () to exit. 	

Language

Use this option to select the language of the user interface.

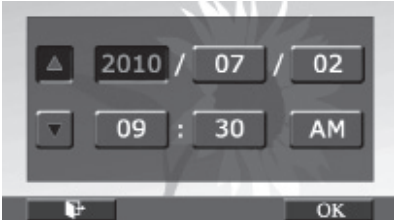

Operation	Display Screen
<ol style="list-style-type: none"> In the Setting menu, touch the [Language] icon on the screen. Touch to select the desired option. Touch the Exit icon () to exit. 	

Time Setting

Operation	Display Screen
<ol style="list-style-type: none"> In the Setting menu, touch the [Time Setting] icon on the screen to enter the time setting screen. Touch Year, Month, Day, Hour, Minute, and AM/PM to set. Adjust the numeric value by touching  / . Touch the [OK] icon to validate the setting. Touch the Exit icon () to exit. 	

Date Printing

Imprint the date and time on the video and photo.

Operation	Display Screen
<ol style="list-style-type: none"> In the Setting menu, touch the [Date Printing] icon on the screen. Touch to select [Off] or [On] (<input checked="" type="checkbox"/> <input type="checkbox"/>). Touch the Exit icon () to exit. 	



Note

- Date Printing function can not be used when Slow Motion function is activated.*

Format

- **Yes:** Format the built-in memory (when there is no SD card in the camera) / SD Card (when there is an SD card in the camera).
- **No:** Do not format the built-in memory (when there is no SD card in the camera) / SD Card (when there is an SD card in the camera).

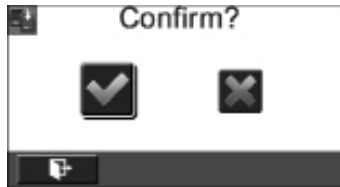
Operation	Display Screen
1. In the Setting menu, touch the [Format] icon on the screen. 2. Touch to select [Yes] or [No] (<input type="checkbox"/> <input checked="" type="checkbox"/> <input type="checkbox"/> <input checked="" type="checkbox"/>). (Touch [Yes] <input checked="" type="checkbox"/> to enter the confirmation screen.)	
3. Touch the [Yes <input checked="" type="checkbox"/>] icon to execute the operation and the [No <input checked="" type="checkbox"/>] icon to cancel the operation.	



Note

All the data will be erased if the SD card is formatted. Make sure all the data are copied to your PC before formatting the SD card.

Default Setting

To restore the default factory setting, select this option.

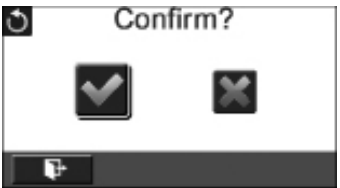
Operation	Display Screen
1. In the Setting menu, touch the [Default Setting] icon on the screen. 2. Touch to select [Yes] or [No] (<input type="checkbox"/> <input checked="" type="checkbox"/> <input type="checkbox"/> <input checked="" type="checkbox"/>). (Touch [Yes] <input checked="" type="checkbox"/> to enter the confirmation screen.)	
3. Touch the [Yes <input checked="" type="checkbox"/>] icon to execute the operation and the [No <input checked="" type="checkbox"/>] icon to cancel the operation.	

The following table indicates the camera's default settings

Setting	Default Factory Setting
Resolution	FHD (1080p 30) for Video 5MP for Photo
Stabilization	Off
Motion Detection	Off
Slow Motion	Off
Time Lapse	Off
Self-Timer	Off
Smile Detection	Off
ISO	Auto
Scene	Auto
White Balance	Auto
Face Tracking	Off
Flash	Off
Sound	On
TV	Depends on shipping area
Language	Depends on shipping area
Date Printing	Off
Volume	Level 6

Section 6

Viewing Photos and Videos on TV

Connecting to a High-Definition 16:9(Wide) TV

1. Connect the HDMI cable to your camera's HDMI Out port.
2. Connect the other end of the cable to a television.
3. Set the video input source of your TV to "HDMI."
4. The steps for viewing stored videos and photos on HDTV are exactly the same as for viewing them on the LCD monitor.

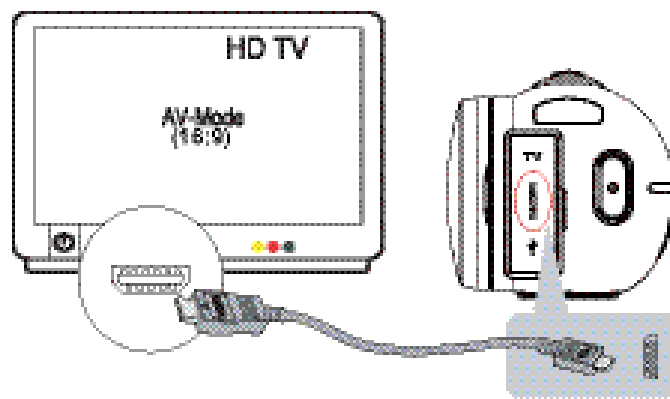

Connecting to a non-high-definition 4:3 TV

1. Connect one end of the AV cable to your camera's AV out port.
2. Connect the other end of the cable to a television.
3. The steps for viewing stored videos and photos on TV are exactly the same as for viewing them on the LCD monitor.

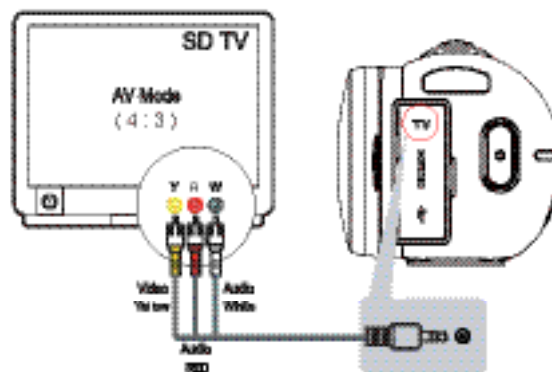

Section 7

Using the Software

Installing the Software

You must be connected to the internet to install and run the Vivitar Experience Image Manager software.

1. Insert the installation CD into your CD-ROM drive. The installation screen should automatically open.



2. On PC: The Vivitar Experience Image Manager Installer window appears. If the window does not appear, open the application's CD/DVD drive and click on "Setup.exe" to launch the installer.
3. On Macintosh: Click the icon that appears on the desktop to install the Vivitar Experience Image Manager.
4. If you do not have internet access at the time of inserting the CD-ROM, connect to the internet and then click the "Install Vivitar Experience Image Manager" button to begin the installation.

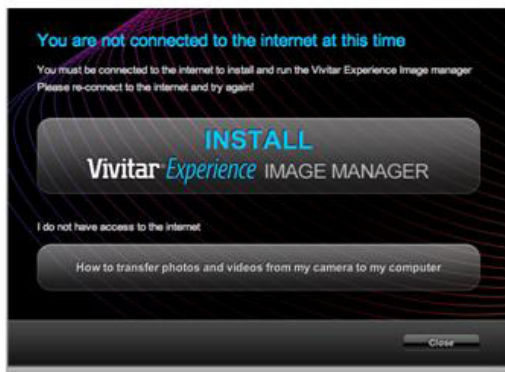

Note

- If you do not have internet access, you can still download media from the camera. Click the "How to transfer photos and videos from my camera to my computer" button for instructions.
5. If you have internet access, the "Choose your language" window opens, choose your language and click "Next" to open the next window.
 6. Select your camera model from the list and click "Next" to open the next window.
 7. Click "Next" to confirm your camera model selection and to install the application.
 8. Please wait while the application is being installed on your computer.
 9. Please review the license terms.
On PC and Macintosh: Click the "I accept the terms of this license agreement" and then click

“Next” to continue.

10. On PC only: Let the “Vivitar Experience Image Manager” installer create the folder to where the program will be installed, and then click “Install”.
11. Please wait while the application continues the installation process on your computer.
12. On PC: Click the “Close” button when the installation is complete.
Click the “Launch Vivitar Experience Image Manager” to open the application.
13. On Macintosh: Click the “Quit” button when the installation is complete.
Click the “Launch Vivitar Experience Image Manager” to open the application.
14. If you close the application you can run the Vivitar Experience Image Manager from the Programs (PC) or Applications (Mac) menu on your computer.



Connecting the Camera to a Computer

1. Connect the computer and camera with the supplied mini USB 2.0 cable.
2. Power the camera ON.
3. The first time you connect the device to the computer you will have to wait a few seconds until the computer recognizes the device.

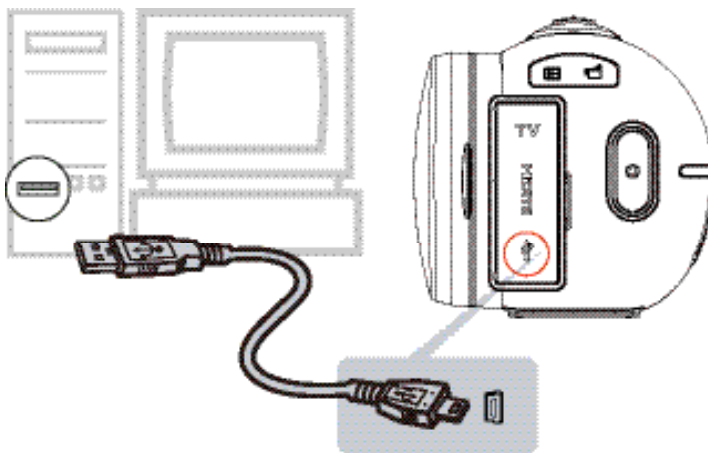

Getting Photos and Videos from your Camera to your Computer

Do not disconnect the cable during transfer. Doing so will cancel the transfer of any files on their way to your computer.

1. Select the “Get Images” button from the Main menu.



2. The “Get Images from device” window opens.
3. You can select to download photos, videos or both.
4. Select your camera (removable disk) from the device window. If your camera is the only USB device connected then it will be selected automatically.
5. Select a location on the computer where to place the new photo and video files.
6. Add the new photo and video files to albums if desired.
7. Select to remove the media files from the selected device (removable disk) after the import.
8. Click the “Get Images” button to transfer the photos and videos from your camera to your computer.
9. A media download progress bar appears on the bottom left showing the number of media files downloading to your computer. A message appears when the download is complete.
10. The photo and video files that you selected are now downloaded to your computer to the selected folder and albums ready for your use.

Get Started!

Using the Vivitar Experience Image Manager, you can:

- Upload and manage photos and videos to and from the most popular photo sharing and social networking sites - Facebook, Flickr, Picasa, MySpace, Photobucket, Twitpic, Twitgoo and YouTube
- Seamlessly transfer photos and videos from one social network to another
- Organize your images by creating offline and online albums
- Edit images using automatic and manual tools
- Use automatic “Geotagging” with built in Google Maps

For more details on how to use the Vivitar Experience Image Manager open the Help file or click the “Take the Tour” button on the application’s Home page.

Section 8

Transferring Media

Transferring Videos and Photos: Using Windows

To transfer media from your camera to your computer manually using Windows:

1. Use the USB cable that came with your camera to connect your camera to your computer.
2. MSDC appears on the LCD.
3. A window appears with a list of options, select "Open folder to view files" and click OK.
4. Open the DCIM folder and the folder inside to view the media files.
5. Select the media and copy the files from this folder into your computer. Optionally, select the files and choose Copy from the Edit menu. Then select a folder and choose Paste from the Edit menu.
6. It is recommended that you copy the images into the Pictures/My Pictures folder and the videos into the Videos/My Videos folder.
7. Do not disconnect the cable during transfer. Doing so will cancel the transfer of any files on their way to your computer.

Transferring Videos and Photos: Using Macintosh

To transfer media from your camera to your computer manually using Macintosh:

1. Use the USB cable that came with your camera to connect your camera to your computer.
2. MSDC appears on the LCD.
3. The camera's device icon appears on the desktop.
4. Click on the device icon and open the DCIM folder and the folder inside to view the media files.
5. Select the files and drag them into your computer. Optionally, select the files and choose Copy from the Finder's Edit menu. Then select a folder and choose Paste from the Edit menu.
6. We recommend that you copy the images into the Pictures folder and the videos into the Movies folder.
7. Do not disconnect the cable during transfer. Doing so will cancel the transfer of any files on their way to your computer.

Section 9

Sakar Warranty Card

This warranty covers for the original consumer purchaser only and is not transferable. Products that fail to function properly **UNDER NORMAL USAGE**, due to defects in material or workmanship will be repaired at no charge for parts or labor for a period of one year from the time of purchase.

What Is Not Covered By Warranty:

Damages or malfunctions not resulting from defects in material or workmanship and damages or malfunctions from other than normal use, including but limited to, repair by unauthorized parties, tampering, modification or accident.

What to Do When Service Is Required:

When returning your defective product (postage pre-paid) for service, your package should include:

- 1) Copy of **original** bill of sale
- 2) A detailed written description of the problem.
- 3) Your return address and telephone number (Daytime)

MAIL TO ADDRESS BELOW:

<u>Sakar US</u>	<u>Sakar UK/Europe</u>	<u>Sakar Australia</u>
Sakar International Attention: Service Department 195 Carter Drive Edison, NJ 08817	Attention: Service Department 2D, Siskin Parkway East 4020 Middlemarch Business Park Coventry, CV3 4PE	Return faulty camera to the Refund Counter at the store where purchased

Section 10

Technical Support

For technical support issues please visit our website at **www.vivitar.com**. You can find manuals, software and FAQ's at the website. Can't find what you are looking for? E-mail us at **support@vivitar.com** and one of our technical support team members will answer your questions. For phone support in the US please call 1-800-592-9541, in the UK call 0800 917 4831, in Australia call 1800-006-614. If you would like to call from anywhere else, please visit **www.vivitar.com** for your local toll free number.

Section 11

Specifications and System Requirements

Specification	
Image sensor	5 Mega pixel CMOS sensor
Operation modes	Video record, Photo record
Lens	Auto Focus Lens (F3.5)
Focus range	Macro Mode: 1cm~120cm Normal Mode: 1 cm ~ infinite
Zoom	1X~2700X (23X Optical zoom and 120X Digital zoom)
Shutter	Electronic
LCD monitor	3" touch LCD (16:9)
Storage media	Built-in 128MB memory (partial memory is used for firmware code and software); SD/SDHC/SDXC card slot support (up to 64GB)
Image resolution	High 4608 x 3456 (16M pixels) (Interpolated) Standard 2592x1944 (5M pixels) Low 2048x1536 (3M pixels)
Video resolution	FHD (1080p 30) 1920X1080(30fps) HD+ (720p 60) 1280X720(60fps) HD (720p 30) 1280X720(30fps) VGA (640X480) 640X480(30fps)
White balance	Auto/Manual (Daylight, Fluorescent, Tungsten)
ISO	Auto/800/1600/3200/6400
Self-timer	10 seconds delay
Flash	Flash Auto/Red-Eye-Reduction/Flash Off
File format	Photo: JPG Video: AVI
Image play	Single image/Slide Show
PC interface	Mini USB 2.0 port
TV out	NTSC/PAL selectable, HDMI
Battery	Lithium-ion rechargeable battery
Dimension	126mm (L) x 57mm (H) x 60mm (W)
Weight	340g (without battery)

System requirements

WINDOWS OS

To be able to download photos and videos to your PC, you will need the following minimum configuration:

- Microsoft® Windows XP with Service Pack 3, Windows Vista with Service Pack 1 or Windows 7
- Pentium® 4 processor (or above)
- 512 MB of RAM, with 250 MB of free hard disk space
- 16-bit Color monitor, 1024 X 768 recommended screen resolution
- CD-ROM Drive
- QuickTime® 6 or higher
- Microsoft® Internet Explorer 7 or higher
- Windows Media Player 10 or higher
- DirectX 9 or higher
- Internet connection required

MACINTOSH OS

To be able to download photos and videos to your MAC, you will need the following minimum configuration:

- Intel processor running Mac OS X v10.5.x or later
- 256 MB RAM, 250 MB free hard disk space
- Display: 1024 x 768 or higher-resolution monitor
- QuickTime® 6 or higher
- Internet connection required



Note

The LCD screen is manufactured using extremely high-precision technology, so over 99.99% of the pixels are operational for effective use. However, some tiny black and/or bright dots (white, red, blue or green) may appear on the LCD screen. These dots are a normal result of the manufacturing process, and do not affect the recording.

Section 12

Troubleshooting

1. The flash is not working.

The battery power is low.

The camera is in DC power mode.

In flash auto mode, camera flash fires ONLY when necessary (in dark setting as example).

2. The files on the memory card do not display smoothly when the LCD shows the “!” marking.

The “!” means the SD card is low speed or is having wrong content inside. The way to solve this condition is to format SD card by the camera instead of a PC (Please refer to the detailed Format instruction in Section 5).

Or please change the SD/SDHC/SDXC card to a high speed one.

3. Why do some of my indoor photos look blurry and dark?

The camera extends photo exposure time under low light/ indoor condition. Keep the camera (and the target subject) steady for several seconds when taking photos. The shutter will sound when photos are being taken.

4. How do I charge battery?

You must use the supplied AC charger or the USB cable. The camera must be turned OFF. The blinking light confirms the camera is currently charging, and the light becomes constant after the charging is completed. In AC charging Mode, the light will turn itself off automatically after 3~5 minutes . The full charge time is about 4 to 5 hours. (Actual charging time may vary. It depends on the battery conditions.)

5. After connecting the USB cable to the computer,

A. The disk [DV] indicates the internal memory of the camera. (The disk label may be different according to different model and PC OS.)

B. [Removable Disk] indicates the external memory. (Under the circumstances of within the SD/SDHC/SDXC card in the camera)

6. I have taken photos and selected the “Get Images” button. I get a message that the images were successfully transferred but the photos do not appear on my computer. What do I do?

First ensure that you have in fact taken photos. Press the Shutter button to take some sample photos and then try downloading them again.

With test photos if the camera powers off before you upload them to the computer the photos are not stored in the camera’s memory. These photos should be uploaded quickly before the camera powers off. If the photos are saved to the SD memory card then all the photos should appear.

7. How do I make sure I don't lose important pictures?

We recommend always downloading your photos to your computer as soon as possible to prevent unintentional data loss.

8. I deleted images using the Vivitar Experience Image Manager. The images were also deleted from my computer. How do I recover images that I accidentally deleted?

All images deleted using the Vivitar Experience Image Manager are sent to your computer's Recycle or Trash Bin and can be retrieved from there.

Free Manuals Download Website

<http://myh66.com>

<http://usermanuals.us>

<http://www.somanuals.com>

<http://www.4manuals.cc>

<http://www.manual-lib.com>

<http://www.404manual.com>

<http://www.luxmanual.com>

<http://aubethermostatmanual.com>

Golf course search by state

<http://golfingnear.com>

Email search by domain

<http://emailbydomain.com>

Auto manuals search

<http://auto.somanuals.com>

TV manuals search

<http://tv.somanuals.com>