

DVR 810HD

Digital Video Camcorder

User's Manual



Vivitar®

© 2009 Sakar International, Inc. All rights reserved.

Windows and the Windows logo are registered trademarks of Microsoft Corporation.
All other trademarks are the property of their respective companies.

Download from www.Somanuals.com. All Manuals Search And Download.

Table of Contents

| | |
|--|----|
| Introduction | 2 |
| Key Features | 2 |
| What your digital video camera includes | 3 |
| Computer System Requirements for Windows XP | 4 |
| Computer System Requirement for Windows Vista | 4 |
| Computer System Requirements for Macintosh | 5 |
| A Quick Look at your Digital Video Camera..... | 6 |
| Preparing Your Camera for Use | 7 |
| Inserting an SD Memory Card..... | 8 |
| DVR Function Control | 10 |
| Install the Vivitar Experience Image Manager Software..... | 35 |
| Connect your camera to the computer | 39 |
| Get photos and videos from your camera to your computer | 39 |
| Get started! | 41 |
| Transfer media from my camera to my computer manually (Using Windows)..... | 42 |
| Transfer media from my camera to my computer manually (Using Macintosh) | 42 |
| Maintenance of Your Digital Camera | 43 |
| Sakar Warranty Card | 43 |
| Technical Specifications..... | 45 |

Introduction

Thank you for purchasing the DVR 810HD Digital Video Camcorder. With your camera you can shoot video clips, take individual photos and record audio files. In addition, a SD compatible memory card of up to 8GB needs to be inserted for normal use in order to expand the memory of your DVR camera.

Key Features

- 5 dial modes - Camera, Video, Audio, Playback and Set Up.
- Digital Video resolutions – 1280x720 Pixels (HD), 640x480 (VGA), 320x240 (QVGA).
- 8.1 mega-pixels camera with choice of 6 digital camera resolutions- 8M, 7M ,5M, 3M ,2M and 1.3 M
- 2.7" TFT LCD
- 8 X Digital Zoom
- Supports external SD memory card up to 8GB

- Built-in Microphone
- Takes digital photos, videos and record audio files
- Delete, rotate, protect, crop and print photos directly on and from your camera
- Vivitar Experience Image Manager software for uploading and managing photos and videos to or from the most popular photo sharing and social network websites.

What your digital video camera includes

- Digital Video Camcorder
- USB cable
- TV cable
- Vivitar Experience Image Manager software Installation CD
- Quick Start Guide
- Wrist strap

Computer System Requirements for Windows XP

To be able to download photos and videos to your PC, you will need the following minimum configuration:

- Pentium 4 processor or above with Windows XP service pack 2
- 512 MB RAM, with 100MB of free disk space
- 1024 x 768 Recommended screen resolution
- 16-bit color or higher display adaptor
- CD-ROM Drive
- QuickTime 6 or higher
- Microsoft Internet Explorer 7 or higher
- Windows Media Player 10 or higher
- Internet connection required

Computer System Requirement for Windows Vista

To be able to download photos and videos to your PC you will need the following minimum configuration:

- Windows Vista
- 800MHz processor and 512 MB of system memory

- 20GB hard drive with at least 15GB of available space
- Support for Super VGA graphics
- Available USB Interface
- CD-ROM drive
- QuickTime 6 or higher
- Microsoft Internet Explorer 7 or higher
- Internet connection required

Computer System Requirements for Macintosh

- Macintosh with Intel processor running Mac OS X v10.4.6 or later
- 256 MB RAM, 100 MB free disk space
- Display: 1024 x 768 or higher-resolution monitor
- QuickTime 6 or higher
- Internet connection required

A Quick Look at your Digital Video Camera

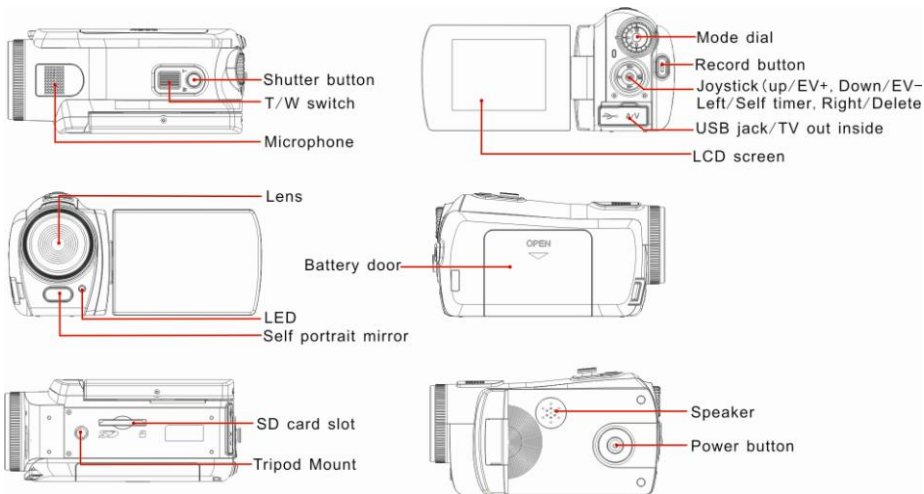

Preparing Your Camera for Use

Battery Installation

Your DVR camcorder requires 4 “AAA” batteries (not included). It is recommended that alkaline batteries be used.

1. Open the battery compartment on the side of the camera.
2. Insert the batteries in accordance with the polarity indicated in the battery compartment.
3. Return and close the battery cover.

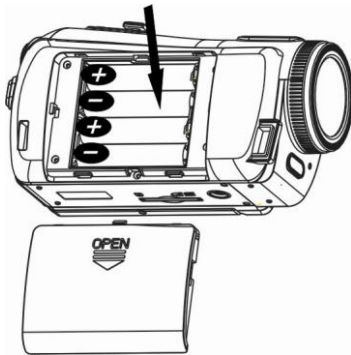

7

Note:

- On removing the batteries from the camera all photos and videos clips in limited built-in memory will be lost.
- Limited internal memory is provided in order to test photos and videos
- A SD Memory card is required for normal use. All the media in the built-in memory will be lost if no SD Memory Card has been inserted in the DVR when you change your batteries.
- We strongly recommend downloading your photos and videos regularly to your computer.
- Remove the batteries from the DVR camera when not in use for an extended period.

Inserting an SD Memory Card

An SD compatible memory card of up to 8GB (not included) is needed for normal use and should be inserted into your DV camera. SD Memory cards expand the amount of memory thus allowing an increase in the number of movies, photos and audio that can be captured before transferring them to a computer.

Media sitting on the memory card is not lost when your camera's power runs low or on replacing the batteries.

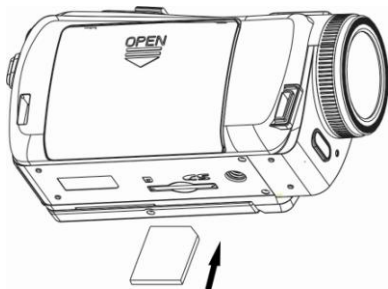

1. Locate the SD card slot on the bottom of the camera.
2. Insert an SD memory card correctly in the direction shown.
3. Press the memory card until you hear a "Click" sound. The memory card when properly inserted will sit flush with the camera.

Note: After you insert an SD memory card, the  icon will appear on the LCD, indicating that your SD memory card has been installed successfully, and the media you capture will now be stored on the card and not in the limited internal memory.

- This product supports SD cards of up to 8GB.
- Formatting will delete all data on the SD Memory Card including protected data.
- Do not remove the SD memory Card during formatting as this may damage the card and render it unusable.
- Be sure to format the card with the camera.

DVR Function Control

To power on the camera you need to flip open the LCD Screen. The Power button is situated on the inside of the camera.

Power on

Press the Power button to turn on your DVR.

The LCD monitor will light up indicating that your DVR is ready for use.

Power off

Press the Power button to turn your DVR camera off. The DVR camera will switch off. If the DVR camera is not in use or in an operation mode for 60 seconds it will switch off automatically.

When there is insufficient battery power, a “Low Battery” message will appear on the LCD screen. The camera will automatically power off a few moments later.

Capturing Videos

In order to capture videos (with audio) using your camera you need to turn the dial to the Video mode. This camera requires a compatible SD card of up to 8 GB for normal operation.

The video  icon will now appear on the top left corner of the LCD.

1. Press the Record button to the right of the dial to start shooting.
2. A  icon will appear and begin to flash. The elapsed time of the video will appear on the top right on the LCD.
3. Press the Record button again to stop the recording.

4. The recorded file will be saved in AVI format.

Note:

1. During shooting the video you can adjust the zoom to focus in on your subject.
2. You can view the AVI files in playback mode.
3. Once they are downloaded to the PC view them using Quick Time and Windows Media Player.
4. As the internal memory of the camera is limited it should be used for test files only.
5. Please insert an SD memory card of up to 8 GB for normal use.
6. When the internal memory is full, a "Disk Full" message will flash on the LCD screen when you attempt to shoot further videos.

In Video mode there are three video resolutions for you to choose from before capturing your video. The higher the resolution selected the better the quality of the video, however higher quality videos use up more memory.

To enter the Setup options for Video mode press on the OK button on the joystick. The different modes are explained in detail below.

Scene

Your camcorder comes supplied with different scenes for you to take photos in almost every type of environment - Auto, Scenery, Night Scenery, Portrait, Night Portrait, Beach, Sports and Party.

Select the scenery for the present light and environmental conditions.

1. Press the OK button.
2. Press the Right/Left joystick button to select the Scene icon  that appears on the bottom left of the LCD.
3. Press the Up/Down joystick button to select the desired scenery option from the menu that appears.
4. Press the OK button to confirm, save your choice and exit.

Note:

After selecting your scenery, the corresponding icon will appear on the left hand side of the LCD.

Resolution

You can select different Video resolutions - High Definition (HD) 1280x720 pixels / VGA 640x480 pixels / QVGA 320x240 pixels

1. Press the OK button.

2. Press the Right/Left joystick button to select the Resolution icon **MP** that appears on the bottom left of the LCD.
3. Press the Up/Down joystick button to select the desired resolution option from the menu that appears.
4. Press the OK button to confirm, save your choice and exit.

Note:

After selecting your resolution, the corresponding icon will appear on the left hand side of the LCD.

Exposure

This setting allows you to control the brightness of your images.

1. Press the OK button.
2. Press the Right/Left joystick button to select the Exposure option.
3. Press the Up/Down joystick button to select an exposure value (from +3 to -3) from the menu that appears.
4. Press the OK button to confirm, save your choice and exit.

Note:

The corresponding exposure number will appear on the left side of the LCD screen.

White Balance

This setting is used to adjust the color of your videos as per your light source.

1. Press the OK button.
2. Press the Right/Left joystick button to select the White balance option.
3. Press the Up/Down joystick button to choose the best option from the menu that appears: Auto/Daylight/Cloudy/Fluorescent/Incandescent.
4. Press the OK button to confirm, save your choice and exit.

Note:

The corresponding White Balance icon will appear on the left side of the LCD screen.

Noise Reduction

Your camcorder has a built-in function to reduce noise during recordings

1. Press the OK button.
2. Press the Right/Left joystick button to select the Noise Reduction option.
3. Press the Up/Down joystick button to choose On or Off from the menu that appears.
4. Press the OK button to confirm, save the choice and exit.

Note: The corresponding Noise Reduction icon will appear on the left side of the LCD screen.

Taking photos

After you power on your camcorder, switch the mode dial to the camera  icon. The camera icon will now appear on the top left corner of the LCD screen. The camera's internal memory is limited to a few photos per each resolution.

Important: Insert a compatible SD card of up to 8GB for normal camera use

Use the image that appears in the LCD to compose your shot.

1. Hold the camera steady and press the shutter button on the top of the camera near the zoom control.
2. The camera will beep and the picture taken is now saved to the memory.
3. The number of photos that can be taken for each resolution and per the memory card inserted appears on the top right of the LCD screen.
4. After the shot is taken the number is reduced by one.

5. When the camcorder's internal memory is full, "Disk Full" will appear on the LCD screen when you attempt to press the Shutter button to take a photo. Either download the photo to your computer using the Vivitar Experience Image Manager software as described below in the section "**Transfer photos and videos to your computer**" and thereafter delete them from your SD card or insert another SD card to continue taking more photos and videos
6. The number of photos that can be captured not only depends on the SD card's capacity but also on the resolution selected. Better quality photos are taken at higher resolutions but these will also take up more memory on the card.

Delete last file

While in camera mode, you can delete the last photo taken.

1. Press the Right/Delete joystick button.
2. A Delete message appears on the LCD
3. Use the Right/Left joystick button to select either "Yes" or "No".
4. Press the OK button to confirm and save your choice and revert to the camera mode.

Digital Zoom function

You can magnify your subject up to 8 times using the digital zoom.

1. Press the T/W button found at the top of the camera to the right to zoom in to the object.
2. Press the T/W button left to zoom back out.
3. The digital zoom icon  will appear on your LCD screen.

Self-Timer

You can include yourself in a photo by using this feature to delay the time between your pressing of the shutter button and when the photo is actually taken.

1. Press the OK button
2. Press the Right/Left joystick button to select the Self Timer icon  on the bottom left of the LCD screen.
3. Press the Up/Down joystick button to select one of the options 5S/10S/Off from the menu that appears.
4. Press the OK button to confirm, save the choice and exit.
5. The Self Timer icon selected now appears on the top of the LCD.
6. Press the Shutter button to begin the timer to take the photo.
7. The timer countdown will appear in the center of the LCD accompanied by loud beeps until the photo is taken.

Note: For quick Self Timer settings whilst in the Camera mode you can press the Left joystick button to select the self timer options 5S/10S/Off. The camera will beep and the Self Timer icon on the top of the LCD will change as per your choice.

Multi-Snapshot

Take 3 consecutive photos automatically.

You will need an SD card inserted in order to use this feature

1. Press the OK button.
2. Press the Right/Left joystick button to select the Multi-Snapshot option.
3. Press the Up/Down joystick button to select On from the menu that appears.
4. Press the OK button to confirm, save the choice and exit.
5. Press the shutter button.
6. The camera will take 3 consecutive photos

Note: The default setting for the Multi-snapshot icon that appears at the top of the LCD is Off.

Resolution

The image size and quality settings determine the number of photos that can be saved and the amount of memory required for each photo. The higher the quality of the photo the more memory it will take. The image size and quality will also affect the maximum size you can print your photo effectively.

To set the resolution:

1. Press the OK button.
2. Press the Right/Left joystick button to select icon **MP** option on the bottom left of the LCD.
3. Press the Up/Down joystick button to select the resolution size you choose – 8M, 7M, 5M, 3M, 2M or 1.3M.
4. Press the OK button to confirm.

Note: The resolution icon appears beneath the camera icon on the LCD screen.

Quality

The quality of your photos also affects the number of shots you can take. The Super setting means you can take fewer photos, but they will be better quality.

1. Press the OK button.
2. Press the Right/Left joystick button to select the Image Quality option.
3. Press the Up/Down joystick button to select the quality you desire – Super/Fine/Normal.

4. Press the OK button to confirm.

Note: The corresponding Quality icon will appear at the top left of the LCD screen.

ISO

This is a special function that allows you to compensate the light conditions when the light source is not good and also where you are not using the flash or tripod. When you want to use ISO sensitization, please choose the low ISO value to prevent blotches appearing on your photo.

1. Press the OK button.
2. Press the Right/Left joystick button to select the ISO option.
3. Press the Up/Down joystick button to select an ISO value from the menu that appears – 100/200/400/800/1600/3200.
4. Press the OK button to confirm, save and exit.

Note: The corresponding ISO icon will appear on the LCD screen.

Sharpness

This setting allows you to adjust the sharpness of your images, making edges more or less distinct.

1. Press the OK button.
2. Press the Right/Left joystick button to select the Sharpness option.
3. Press the Up/Down joystick button to select a sharpness value from the menu that appears – Soft/Normal/Sharp.
4. Press the OK button to confirm, save your choice and exit.

Anti-Shake

Your Digital Camcorder has a function that prevents blurry photos as a result of trembling when taking photos. Due to this function, you are not required to use a tripod for steady shooting photos.

To set as below:

1. Press the OK button.
2. Press the Right/Left joystick button to select the icon  option
3. Press the Up/Down joystick button to select On from the menu that appears.
4. Press the OK button to confirm, save and exit.

Note: The icon  will appear on the LCD screen.

Time Stamp

With this function, you may record the date and time on your photo.

1. Press the OK button.
2. Press the Right/Left joystick button to select the Time Stamp option.
3. Press the Up/Down joystick button to select On/Off from the menu.
4. Press the OK button again to confirm, save and exit.

Scene

Your camcorder comes supplied with different scenes for you to take photos in almost every type of environment - Auto, Scenery, Night Scenery, Portrait, Night Portrait, Beach, Sports and Party.

Select the scenery for the present light and environmental conditions.

1. Press the OK button.
2. Press the Right/Left joystick button to select the Scene icon  that appears on the bottom left of the LCD.
3. Press the Up/Down joystick button to select the desired scenery option from the menu that appears.
4. Press the OK button to confirm, save your choice and exit.

Note:

After selecting your scenery, the corresponding icon will appear on the left hand side of the LCD.

Exposure

This setting allows you to control the brightness of your images.

1. Press the OK button.
2. Press the Right/Left joystick button to select the Exposure option.
3. Press the Up/Down joystick button to select an exposure value (from +3 to -3) from the menu that appears.
4. Press the OK button to confirm, save your choice and exit.

Note:

The corresponding exposure number will appear on the left side of the LCD screen.

White Balance

This setting is used to adjust the color of your videos as per your light source.

1. Press the OK button.
2. Press the Right/Left joystick button to select the White balance option.

3. Press the Up/Down joystick button to choose the best option from the menu that appears: Auto/Daylight/Cloudy/Fluorescent/Incandescent.
4. Press the OK button to confirm, save your choice and exit.

Note:

The corresponding White Balance icon will appear on the left side of the LCD screen.

Audio Mode

An SD card needs to be inserted to use this mode.

Switch the mode dial to the  position.

1. Press the Shutter button to start recording audio files.
2. The elapse time will appear on the LCD screen.
3. Press the Shutter button to stop and save the file as a WAV audio on your SD memory card.

Playback mode

Switch the mode dial to the  icon position. You can playback the photos and videos in your camcorder.

In Playback mode you can rotate, protect, delete your photos and you can protect and delete video clips. You can also print photos directly from your camcorder using PictBridge.

Note:

If there are no images in your memory the “No FILE” message will appear on the LCD screen.

Thumbnail display

When the camcorder is in the Playback Mode

1. Press the Up button for the images to appear as thumbnails.
2. Select a JPG file and press the OK button for the image to appear in full screen.
3. In full screen display mode, you can press the W/T button right/left to enter zoom in/out mode
4. Press the Up/Down/Left/Right joystick button to scroll through the photo.

Note: when you select a JPEG file, the icon  will appear on the LCD screen.

Operation for still photos

Select a still photo (an icon  will show on the LCD).

You now have the option to edit these photos - delete, rotate, protect, crop or print.

Protect

You can protect your photos/videos from accidental deletion.

1. Press the OK button.
2. Press the Right/Left joystick button to select the Protect option.
3. Press the Up/Down joystick button to select one of Lock One/Lock All/Unlock One/Unlock All.
4. Press the OK button to confirm, save and exit.

Note: At step 3, select “Unlock one/Unlock all” and press OK button to unlock the file.

Rotate

You can rotate photos on the camera

1. Press the OK button.
2. Press the Right/Left joystick button to select the Rotate option.
3. Press the Up/Down joystick button to select how much degrees you want to rotate the photo.
4. Press the OK button to confirm, save and exit.

Delete

You can delete unwanted photos and videos at any time to free up memory. You can delete one image or video clip at a time or delete all the unprotected photos and videos that are currently recorded on the memory card at once.

1. Press the OK button.
2. Press the Right/Left joystick button to select the Delete option.
3. Press the Up/Down joystick button to select either This Image/This Video (to delete the currently selected image) or ALL (delete all unprotect images).
4. Press the OK button.
5. A Delete message will appear.
6. Press the Right/Left joystick button to select "Yes" or "No".
7. Press the OK button to confirm, save your choice and exit.

Print directly with PictBridge

Your camcorder allows you to print photos directly from your camera to a compatible printer with PictBridge.

1. Select a photo you want to print.
2. Press the OK button.

3. Press the Right/Left joystick button to select the PictBridge  option.
4. Press the Up/Down joystick button and select PictBridge to print the photo.
5. Press the OK button to enter the PictBridge mode. If you are not connected to a printer the following message will appear on the LCD "Please connect to device".
6. Connect your camcorder to a compatible printer with the provided USB cable to allow for direct printing.
7. If you wish to print the selected photo select the "This Image" option.
8. Press the OK button to start Printing.

9. If you want to print another photo, select "Select Image" option.
10. Press the OK button.
11. Press the Left/Right button to select the photo you wish to print.
12. Press the OK button and select "This Image" to start printing.

Operation for AVI file

You can playback AVI files recorded on your camera

1. Select an AVI file you want to play.
2. Press the Record button to start playing the file.
3. Press the Record button again to stop.

Note: For how to protect and delete photos/videos, please refer to the **Operation of still photos** section above.

Setup Mode

To access the Setup mode turn the mode dial all the way to the left to Set Up. In this mode you can set the Default setting, Format, Date format, Time format, Date/Time setting, Frequency, TV-out, Auto power off and Buzzer.

Default setting

1. Press the OK button.
2. Press the Right/Left joystick button to select the Default Setting option.
3. Press the Up/Down joystick button to select “Yes” or “No”.
4. Press the OK button to confirm, save your choice and exit.

Format

You can delete all files in internal memory or SD memory card by using this feature.

Caution: Please make sure to download the images first before using this

feature as all the images sitting in the card will be erased from the card or internal memory. This process is irreversible.

1. Press the OK button.
2. Press the Right/Left joystick button to select the Format option.
3. Press the Up/Down button to select "OK" or "Cancel"
4. Press the OK button.
5. A Format message will appear on the LCD.
6. Press the Right/Left joystick button to select "Yes" or "No".
7. Press the OK button to confirm, save and begin the format.

Date Format

You can set the date format that will appear on the LCD as well as in the metadata of the photo.

1. Press the OK button.
2. Press the Right/Left joystick button and select the Date Format option.
3. Press the Up/Down joystick button to select one of the following date formats - YY/MM/DD; MM/DD/YY; DD/MM/YY; Hide.
4. Press the OK button to confirm, save and exit to the LCD screen.

Note: the Date format will be displayed on the LCD screen in both the camera mode and video mode. If you selected Hide in step 3, it won't be displayed on the screen.

Time Format

You can set the time up in either a 12 hour or 24 hour format.

1. Press the OK button.
2. Press the Right/Left joystick button and select the Time Format option.
3. Press the Up/Down joystick button to select one of 12 hour/24 hour/Hide.
4. Press the OK button to confirm, save and exit.

Note: the Time format will be displayed on the LCD screen in both the camera mode and video mode. If you selected Hide in step 3, it won't be displayed on the screen.

Date/Time Setting

Set the correct date and time via this function.

1. Press the OK button.
2. Press the Right/Left joystick button and select the Date/Time Setting option.
3. Press the Up/Down joystick button to select Date/Time Setting.
4. Press the OK button to confirm.
5. Now you can select and highlight the Time/Date options by pressing the Right/Left joystick button.
6. Press the Up/Down joystick button to set the date and time.

7. Once you have set the Date and Time continue to use the Left/Right joystick button to select the Confirm option.
8. Press the OK button to confirm, save and exit.

Note: the Date/Time format will be displayed on the LCD screen in both the camera mode and video mode.

Frequency

Generally speaking, 60HZ is for the U.S. and 50HZ for Europe and Japan. The default setting is 60HZ

1. Press the OK button.
2. Press the Right/Left joystick button to select the Frequency option.
3. Press the Up/Down joystick button to select 50/60Hz from the menu.
4. Press the OK button to confirm, save and exit.

TV Out

The image of the picture you wish to capture on the LCD can also be displayed on your TV screen instead when using the TV cable provided.

1. Press the OK button.
2. Press the Right/Left joystick button to select the TV Out option.

3. Press the Up/Down joystick button to select either NTSC or PAL mode according to how your TV is set.
4. Press the OK button to confirm and save this choice.
5. Connect your DVR to your TV with the supplied TV cable.

Auto Power Off

In order to conserve the energy supply of your camera when it is not in use you can set the time the camcorder will automatically turn off when not active.

1. Press the OK button.
2. Press the Right/Left joystick button to select the Auto Power off option.
3. Press the Up/Down joystick button to select one of 1 Minute/2Minutes/Off.
4. Press the OK button to confirm and save your choice

Note: If you select "Off" from the menu your camera will never automatically turn off.

If left on for an extended period of time without turning it off yourself this will lead to the batteries being drained quicker.

Buzzer

Your camcorder emits a beep or buzzer sound when you press any button. The default setting is on. To set this buzzer on or off

1. Press the OK button.

2. Press the Right/Left joystick button to select the Buzzer option.
3. Press the Up/Down button to select either "Buzzer on" or "Buzzer off".
4. Press the OK button to confirm and save your choice.

Install the Vivitar Experience Image Manager Software

Warning: Do not plug your camera into the computer until the software installation is complete.

You must be connected to the internet to install and run the Vivitar Experience Image Manager software.

1. Insert the installation CD into your CD-ROM drive. The installation screen should automatically open.



2. On PC: The Vivitar Experience Image Manager Installer window appears. If the window does not appear, open the application's CD/DVD drive and click on "Setup.bat" to launch the installer.
3. On Macintosh: Click the icon to install the Vivitar Experience Image Manager.
4. If you do not have internet access at the time of inserting the CD-ROM, connect to the internet and then click the "Install Vivitar Experience Image Manager" button to begin the installation

Note: If you do not have internet access, you can still download media from the

camera. Click the “How to transfer photos and videos from my camera to my computer” button for instructions.



5. If you have internet access, the “Choose your language” window opens, choose your language and click “Next” to open the next window.
6. Select your camera model from the list and click “Next” to open the next window.
7. Click “Next” to confirm your camera model selection and to install the application.
8. Please wait while the application is being installed on your computer.

9. Please review the license terms.
On PC: Click the “I Agree” button to continue.
On Macintosh: Click the “I accept the terms of this license agreement” and then click “Next” to continue.
10. On PC only: Let the “Vivitar Experience Image Manager” installer create the folder to where the program will be installed, and then click “Install”.
11. Please wait while the application continues the installation process on your computer.
12. On PC: Click the “Close” button when the installation is complete.
On Macintosh: Click the “Quit” button when the installation is complete.
13. Click the “Launch Vivitar Experience Image Manager” to open the application or close the window and run the Vivitar Experience Image Manager from your computer.



Connect your camera to the computer

1. Use the USB cable that came with your camera to connect your camera to your computer.
2. Turn your camera on.
3. The first time you connect the device to the computer you will have to wait a few seconds until the computer recognizes the device.

Get photos and videos from your camera to your computer

An SD card needs to be inserted. Do not disconnect the cable during transfer. Doing so will cancel the transfer of any files on their way to your computer.

1. Select the “Get images” button from the Main menu.

Vivitar[®] Experience IMAGE MANAGER



Get Images



Manage Images



Send by Email



Slideshow



Print Photos



Frame Maker



Facebook



Flickr



Picasa
Web Albums



Photobucket



YouTube

Take a Tour 

2. The “Get media from device” window opens.

3. You can select to download photos, videos or both.
4. Select your camera (removable disk) from the device window. If your camera is the only USB device connected then it will be selected automatically.
5. Select a location on the computer where to place the new photo and video files.
6. Add the new photo and video files to albums if desired.
7. Select to remove the media files from the selected device (removable disk) after the import.
8. Click the “Get media” button to transfer the photos and videos from your camera to your computer.
A media download progress bar appears on the bottom left showing the number of media files downloading to your computer. A message appears when the download is complete.
9. The photo and video files that you selected are now downloaded to your computer to the selected folder and albums ready for your use.

Get started!

Using the Vivitar Experience Image Manager, you can upload and manage photos and videos to and from the most popular photo sharing and social networking sites - Facebook, Flickr, MySpace, Picasa, Photobucket and YouTube. Seamlessly transfer photos and videos from one social network to another. Organize your images by creating offline and online albums. Edit images using automatic and manual tools. Use automatic “Geotagging” with built in Google Maps.

For more details on how to use the Vivitar Experience Image Manager open the Help file or click the “Take the Tour” button on the application’s Home page.

Transfer media from my camera to my computer manually (Using Windows)

1. Use the USB cable that came with your camera to connect your camera to your computer.
2. A window appears with a list of options, select “Open folder to view files” and click OK.
3. Open the DCIM folder and the folder inside to view the media files.
4. Select the media and copy the files from this folder into your computer. Optionally, select the files and choose Copy from the Edit menu. Then select a folder and choose Paste from the Edit menu.
5. We recommend that you copy the images into the Pictures/My Pictures folder and the videos into the Videos/My Videos folder.
6. Do not disconnect the cable during transfer. Doing so will cancel the transfer of any files on their way to your computer.

Transfer media from my camera to my computer manually (Using Macintosh)

1. Use the USB cable that came with your camera to connect your camera to your

- computer.
2. The camera's device icon appears on the desktop.
 3. Click on the device icon and open the DCIM folder and the folder inside to view the media files.
 4. Select the files and drag them into your computer. Optionally, select the files and choose Copy from the Finder's Edit menu. Then select a folder and choose Paste from the Edit menu.
 5. We recommend that you copy the images into the Pictures folder and the videos into the Movies folder.
 6. Do not disconnect the cable during transfer. Doing so will cancel the transfer of any files on their way to your computer.

Maintenance of Your Digital Camera

The digital camera is a delicate device. Please handle your camera with care to avoid damaging it.

Sakar Warranty Card

This warranty covers for the original consumer purchaser only and is not transferable. Products that fail to function properly UNDER NORMAL USAGE, due to defects in material or workmanship. Your product will be repaired at no charge for parts or labor for a period of one year.

What Is Not Covered By Warranty:

Damages or malfunctions not resulting from defects in material or workmanship and damages or malfunctions from other than normal use, including but limited to, repair by unauthorized parties, tampering, modification or accident.

What To Do When Service Is Required:

When returning your defective product (postage pre-paid) for service, your package should include:

1. Copy of **original** bill of sale
2. A detailed written description of the problem.
3. Your return address and telephone number (Daytime)

MAIL TO ADDRESS BELOW:

Sakar International
Attention: Service Department
195 Carter Drive
Edison, NJ 08817

TECHNICAL SUPPORT

For technical support issues please visit our website at www.vivitar.com. You can find manuals, software and FAQ's at the website. Can't find what you are looking for? E-mail us at support@vivitar.com and one of our technical support team members will answer your questions. For phone support in the US please call 1-800-592-9541, in the UK call



0800 917 4831. If you would like to call from anywhere else, please visit www.vivitar.com for your local toll free number.

Technical Specifications

| | |
|--------------------|--|
| Image Sensor | CMOS Sensor |
| Image Resolution | 3264*2448(8.1M),3072*2304(7.0M), 2592*1944(5.0M),2048*1536(3.0M), 1600*1200(2.0M). 1280*960 (1.3M) |
| Video Resolution | HD: 1280*720p (20fps); VGA: 640*480 (30fps); QVGA: 320*240 (30fps) |
| LCD Display | 2.7" TFT(4:3) |
| LCD Swivel | 90° |
| Internal Memory | 16MB |
| External Memory | SD card up to 8 GB |
| Storage capability | Example: External Memory of 2GB SD Card: Video: HD/16min; VGA/29min; QVGA/60min Images: 8.1M/2088; 7.0M/2164; 5.0M/2880; 3.0M/4016;2.0M/5730;1.3M/7612. |
| Lens | f=7.45mm, F=2.8 |

| | |
|---------------------|--|
| Digital Zoom | 8x |
| Self-timer | 5s/10s |
| File Format | JPEG (Still Image) /AVI (Video) / WAV (Audio) |
| Anti-Shake | YES |
| TV out | YES |
| Microphone | YES |
| Speaker | YES |
| Recorder | YES |
| Interface | USB 2.0 |
| System Requirements | Windows XP, VISTA or Mac OS X (10.4.6 or higher) |
| Battery | 4*AAA |
| Working Temperature | 0-40 C |

Trouble Shooting

| Relative parts | Symptom | Explanation/ Solution |
|----------------------|---|--|
| Taking a Video/photo | The DV can't take video/photos after you press Shutter button. | <ul style="list-style-type: none">.Batteries level is too low. Replace them with new ones.The DV is not in  /  mode. Please set DV to the correct mode.. Auto Power off. Restart your device.. The SDRAM or SD card is fully loaded with files. Please delete some useless files or change a memory card. |
| Auto power off | The camcorder goes off automatically. | <ul style="list-style-type: none">.You have left the camcorder to STBY for more than 60s without using it..The battery pack is fully exhausted. |
| Battery pack | The battery pack is quickly exhausted. | <ul style="list-style-type: none">.The atmospheric temperature is too low..The battery pack is completely dead. Please replace them with new ones. |
| DV & battery | The DV or battery is hot | <ul style="list-style-type: none">. Using the DV continually for a long time. |
| Photos | The photos are too blur | <ul style="list-style-type: none">. Exposure is not sufficient. |
| Deleting | You can't delete the files | <ul style="list-style-type: none">. The battery lever is low. Please replace them with new ones in time. |
| SD card | You can't insert an memory card correctly | <ul style="list-style-type: none">. The direction of inserting card may be incorrect. |
| Downloading | Movies/ photos can't be downloaded to PC. | <ul style="list-style-type: none">. The set is wrong. Please refer to how to enter PC mode. There may not install the drive of DV in your PC. Please install drive before downloading. |

Q: I have taken photos and selected the “Get Images” button. I get a message that the images were successfully transferred but the photos do not appear on my computer. What do I do?

First ensure that you have in fact taken photos. Press the Shutter button to take some sample photos and then try downloading them again. With test photos if the camera powers off before you upload them to the computer the photos are not stored in the camera's memory. These photos should be uploaded quickly before the camera powers off. If the photos are saved to the SD memory card then all the photos should appear.

Q: How do I make sure I don't lose important pictures?

Your camera uses SDRAM memory, which requires a constant electric current to store your test photos. Should your camera lose power (for instance if the battery dies or run out of power) all stored pictures will be lost. This camera requires an SD card for normal use. If the camera powers off nothing will happen to the images stored on the SD memory card. We recommend always downloading your photos to your computer as soon as possible to prevent unintentional data loss.

Q: I deleted images using the Vivitar Experience Image Manager. The photo was also deleted from my computer. How do I recover photos that I accidentally deleted?

All images deleted using the Vivitar Experience Image Manager are sent to your computer's Recycle or Trash Bin and can be retrieved from there.

RP08DVEDV030C7RKSE00

A00-090518GES

Free Manuals Download Website

<http://myh66.com>

<http://usermanuals.us>

<http://www.somanuals.com>

<http://www.4manuals.cc>

<http://www.manual-lib.com>

<http://www.404manual.com>

<http://www.luxmanual.com>

<http://aubethermostatmanual.com>

Golf course search by state

<http://golfingnear.com>

Email search by domain

<http://emailbydomain.com>

Auto manuals search

<http://auto.somanuals.com>

TV manuals search

<http://tv.somanuals.com>