

DVR 850W

Underwater Digital Video Camcorder

Owner's Manual



Vivitar®

© 2009 Sakar International, Inc. All rights reserved.

Windows and the Windows logo are registered trademarks of Microsoft Corporation.

All other trademarks are the property of their respective companies.

Table of Contents

Introduction.....	2
Key Features	2
What your digital video camcorder includes	2
Computer System Requirements for Windows XP	3
Computer System Requirement for Windows Vista.....	3
Computer System Requirements for Macintosh	3
A Quick Look at your Digital Video Camcorder	4
Preparing Your Camcorder for Use	5
Install lithium battery.....	5
Inserting a SD Memory Card	6
Maintenance and Care	7
Software Installation: Snap 'n Share Pro and Video Express	8
Powering on and setting DVR Function Control	12
Capturing Videos.....	15
Video Setting options.....	16
Capturing Still Photos	23
Photo Setting options	25
Playback mode.....	32
AV mode – Using your TV to view images	35
Connect DVR with PC using USB cable provided.....	35
Connect DVR with printer using USB cable provided	36
Transferring Images to your PC using the software	37
Manually transfer images and videos to your Digital Camcorder.....	42
Transferring photos and videos to your MAC manually	43
Everything you need to get the most of your media and MORE	43
Video Express application	45
Technical Support	51
Sakar Warranty Card.....	51
Technical Specifications	52
Trouble Shooting	53
Important Note: Using Camcorder Underwater	54

Introduction

Thank you for purchasing the DVR 850W Underwater Digital Video Camcorder. With your camcorder you can shoot video clips and take individual photos. In addition, a SD compatible memory card of up to 8GB can be inserted in order to expand the memory of your DVR camcorder. Your camcorder can be used up to 3 meters underwater.

Key Features

- 4 modes – Video, Camera, Playback and Set Up.
- Digital Video resolutions – 640x480 (VGA), 320x240 (QVGA).
- 8.1 mega-pixel camcorder with choice of 4 digital camera resolutions – 8.1M(3320X2490); 5M(2592X1944); 3M(2048X1536); VGA(640X480)
- 2.4" TFT LCD
- 8 X Digital Zoom
- 64MB Internal Memory
- Supports external SD memory card up to 8GB
- Built-in Microphone
- Takes digital photos and videos
- Snap 'n Share Pro software application can be used to download the photos and videos from your camcorder
- Edit, add text, clip art and more on your digital photos
- Produce colorful movies to upload, copy to CD/DVD and much more with Video Express software.

What your digital video camcorder includes

- Digital Video Camcorder
- USB and AV Dual Cable
- Snap n Share Pro Software installation CD
- Quick Start Guide
- Hand strap
- Lithium battery
- AC charger

Computer System Requirements for Windows XP

To be able to download photos and videos to your PC you will need the following minimum configuration:

- Pentium 4 Processor (or above), 2.6 GHZ., with Windows XP Service Pack 2
- 512 MB RAM, 200MB free disk space.
- Available USB Interface
- CD-ROM Drive
- Recommended screen resolution 1024 X 768 pixels or higher.
- 16-bit color or higher display adaptor.
- Windows Media Player 9 (or above) as default media player

Computer System Requirement for Windows Vista

To be able to download photos to your PC you will need the following minimum configuration:

- Windows Vista
- 800MHz processor and 512 MB of system memory
- 20GB hard driver with at least 15GB of available space
- Support for Super VGA graphics
- Available USB Interface
- CD-ROM drive

Computer System Requirements for Macintosh

- Power Macintosh G3 500 MHz or higher
- Mac OS X version 10.2.6 or later
- 128 MB or more available system RAM (256 MB recommended), 150 MB free disk space
- 1024 x 768 or higher-resolution monitor displaying millions of colors.

Note: The Snap `n Share Pro software as well as the Video Express software are not compatible on Macintosh computers. You may however use the camcorder as a regular MSDC USB removable device.

A Quick Look at your Digital Video Camcorder

1. DC mode/Shutter
2. DV mode/Shutter
3. Up/Zoom in
4. Left
5. Right/Flashlight mode
6. OK/Menu
7. Down/Zoom out
8. DC/DV mode LED
9. Li-ion battery charging LED
10. LCD Color display
11. Battery/SD card/USB slot compartment
12. Playback
13. Power on/off
14. Speaker
15. Microphone
16. Lens
17. Flashlight
18. Tripod Mount

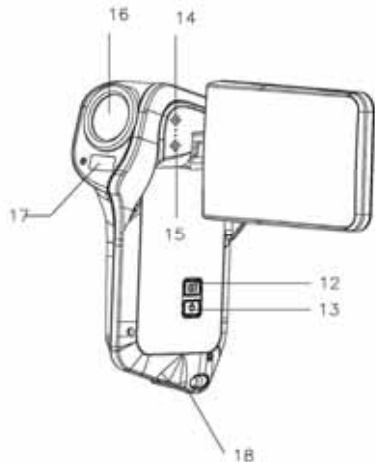
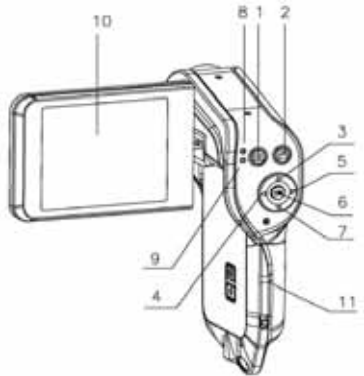

Preparing Your Camcorder for Use

Install lithium battery

Your digital camcorder needs a lithium battery in order to operate. The battery is found separately in the packaging. To install it correctly see the diagram below:

1. Push the black battery cover lever up for the battery door to spring open.

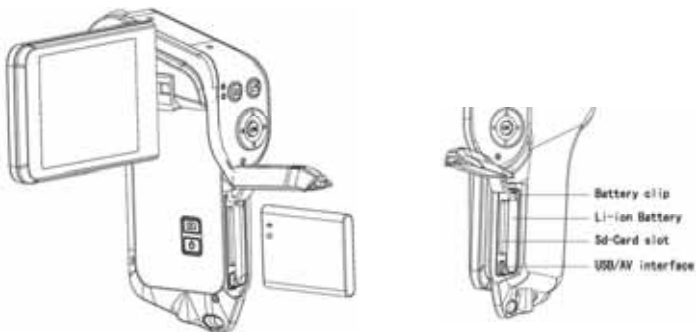

2. Insert the battery in the battery compartment with the correct polarity facing up.
3. Use the battery clip found in the battery compartment to make sure that the battery is sitting firmly and secure.
4. Before closing the battery door, be sure that the rubber seal on the battery door is clean and smooth.
5. Close the battery door and hear a click as it locks into place.
6. On powering on your camcorder the battery icon will appear on the top left of the LCD screen.

Note:

1. In order to charge your lithium battery, make sure the battery is inserted correctly and then connect your camcorder to a running PC with the USB cable provided, or use the AC charger provided in the package. The red LED will light up indicating that your camcorder is in charging mode. The

- LED will switch off when your camcorder is fully charged after approximately 4 hours. The camcorder should not be on while charging.
2. A red battery icon will flash on the LCD when the battery power is insufficient. Shortly thereafter your camcorder will power off.
 3. Please remove your battery when you don't intend to use your camcorder for a long time.
 4. 64 MB of internal memory is provided in order to take photos and videos.
 5. Use a SD Memory card to expand the memory in order to capture and record many more media items. All the media in the built-in memory will not be lost if no SD Memory Card has been inserted in the DVR when battery power is low or when you change your battery.
 6. Do not open the battery door to take out the battery or SD card while the photo and video are being saved to the camcorder. Doing so may cause the photo and video to be lost or damaged.
 7. We strongly recommend downloading your photos and videos regularly to your computer.

Inserting a SD Memory Card

To expand the amount of memory, a SD compatible memory card of up to 8GB (not included) should be inserted into your DV camcorder. SD Memory cards increase the number of videos and photos that can be captured with the camcorder before transferring them to a computer.

Media sitting on the memory card is not lost when your camcorder's power runs low or on replacing the battery.

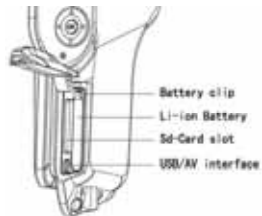

1. Push the black battery cover lever up for the battery door to spring open.
2. Locate the SD card slot to the left of the battery compartment.
3. Insert the SD memory card correctly in the direction shown.
4. Press the memory card until you hear a “Click” sound.

Note: After you insert an SD memory card, the SD card icon will appear on the top left of the LCD, indicating that your SD memory card has been installed successfully. The media you capture will now be stored on the card and not in the internal memory.

- This product supports SD cards of up to 8GB.
- Make sure that the card is not locked. Locked cards do not allow media transfer.
- Formatting will delete all data on the SD Memory Card.
- Download all the media to your computer before you format the card.
- Do not remove the SD Memory Card during formatting as this may damage the card and render it unusable.
- Before using the camcorder, be sure to format the card with the camcorder (see the Setup section further on the manual for instruction on how to format the card).

Maintenance and Care

Before using the video camcorder, please ensure that you read and understand the safety precautions described below:

- This camcorder can be used underwater to 10 feet, when there is the Phenomenon of water leaking into the camcorder, the camcorder working properly, this is normal.
- Once use the camcorder in the sea, clean the camcorder with clean water after using, and put in a dry place, so that the water inside the camcorder dry.
- On Lifting and opening the LCD screen, be careful not to over rotate the screen.
- Direct sunlight might cause damage to the camcorder.
- Only clean the lens and LCD with a soft cloth.
- Do not store the camcorder in temperatures above 40°C.
- Condensation may appear with sudden changes in temperature. Take care to

- not leave the camcorder in extreme temperatures.
- Do not try to open the case of the video camcorder or attempt to modify this video camcorder in any way. Maintenance and repairs should be carried out only by authorized service providers.
 - Opening the cover of the Camcorder may cause electrical shock and will void your warranty.
 - Use only the recommended power accessories. Use of power sources not expressly recommended for this equipment may lead to overheating, distortion of the equipment, fire, electrical shock or other hazards.

Software Installation: Snap 'n Share Pro and Video Express

Follow the step by step instructions that appear on your computer screen during the installation process.

Software Installation

1. Insert the CD into your CD-Rom drive.
2. Wait for the computer to automatically recognize and open the first stage of the software installation
3. The Welcome to the Snap 'n Share Pro Installation Wizard Setup screen will appear.
Note: On Vista operating systems you may see an AutoPlay window appear. Select the **SMSetup.exe** option to begin the software setup.
4. Click the "**Begin**" button to begin the software setup and installation process.



5. The Setup wizard will start to install the Snap 'n Share Pro application on your computer. Click "**Next**" to continue.



6. Please review the license terms and click the **"I Agree"** button to continue.



7. In the Installation options you can choose where to install this application on your computer. However, it is recommended to let the Snap 'n Share Pro installer create the folder to where the program will be installed. Click **"Install"** and follow the instructions.

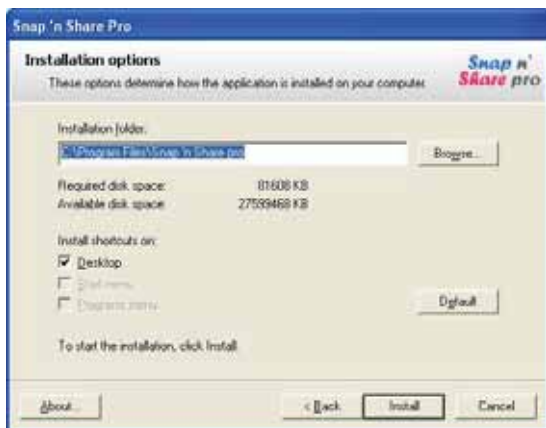

8. Click **“Finish”** to let the Snap ‘n Share Pro installer finish the installation program.



9. The Setup will now begin to silently install the Video Express software. This might take a few seconds to install depending on the operating system you are running.



- Click the **"Finish"** button to finish the installation.



Congratulations!! You have successfully installed the Snap 'n Share Pro and Video Express software on your PC.

Powering on and setting DVR Function Control

To power on the camcorder, flip open the LCD Screen. The camcorder automatically powers on. The Power button is situated on the inside of the camcorder facing the LCD screen.

Power on

Press the Power button to turn on your DVR.

The LCD monitor and a blue LED next to the DC/DV shutter button, will light up indicating that your DVR is ready for use.

Power off



Press the Power button to turn your DVR camcorder off. The DVR camcorder will switch off.

By default if the DVR camcorder is not in use or in an operation mode for 3 minutes(180 seconds) it will automatically switch off.

When there is insufficient battery power, a red battery icon will appear on the LCD screen. The camcorder will automatically power off a few moments later.

Setting the Language

When using the video camcorder for the first time after purchasing it, be sure to choose a language and set the date & time before use.



1. Turn the **Power** on to enter the DV mode.
2. Press the **OK/Menu** button.
3. Press the **Left/Right/Up/Down** arrow buttons on the OK dial to select the **Setup Mode**  icon from the menu icons that appear.
4. Press the **OK/Menu** button.
5. Press the **Left/Right/Up/Down** button on the OK dial and select the **Language**  icon submenu option.
6. Press the **OK/Menu** button.
7. Press the **Left/Right/Up/Down** button to highlight and select the language you desire.

*English /German / French / Spanish / Portuguese / Italian /Dutch /
Russian / Turkish*

8. Press the **OK** button to save your choice and for the interface of the camcorder to change to the language you selected.
9. Press the **DV** mode button to close the menu and press it again to exit the Setup mode function.

Setting the Date and Time

To set the time and date that will appear on the photos you capture.

1. Turn the **Power** on to enter the DV mode.
2. Press the **OK/Menu** button.
3. Press the **Left/Right/Up/Down** button on the OK dial to select the **Setup Mode**  icon from the menu icons that appear.
4. Press the **OK/Menu** button.
5. Press the **Left/Right/Up/Down** button on the OK dial and select the **Date/Time**  icon submenu option.
6. Press the **OK/Menu** button.
7. Press the **Left/Right** button to highlight and select the **Year, Month, Day, 24H, Hour and Minutes** options you desire to change.
8. Press the **Up/Down** button to change the digits for each of the date or time options you desire to update.
9. Press the **OK** button to save the date and time you selected.
10. Press the **DC/DV** mode button to close the menu and press it again to exit the Setup mode function.

Changing the camcorder's modes

There are four modes in this DVR camcorder.

1. Press the **Power** button to turn on the camcorder.
2. The **DV (Video)** default capture mode appears on the LCD.
3. Press the **DC (Camera)** mode button to change from the video to the camera mode.
4. Press the **DV** mode button to revert back to the video mode.

5. Press the **Playback** button situated above the Power button on the inside wall of the camcorder to preview all the images you have captured.
6. Press the **OK** button while in the DV or DC mode in order to open the main menu with Setting and Setup modes appearing for each respectively.
7. The **Setup** mode for the DVR can be accessed while in either the **DV or DC** mode.
8. Select the mode you wish to enter by pressing the **Right/Left/Up/Down** arrow buttons and press the **OK** button to enter the submenu.

Capturing Videos

In order to capture videos (with audio) using your camcorder you need to select the **DV** video mode. On turning on your camcorder the first mode to appear is the **DV** mode. To change between the function modes on your DVR, press the **DV/DC** buttons.

The camcorder has 64MB of built in memory. Use a compatible SD card of up to 8 GB to expand the memory capacity to capture even more and longer videos than can be captured using internal memory only.

The video icon will now appear on the top right corner of the LCD.

1. The amount of time left at that resolution and memory appears on the bottom right of the LCD.
2. Aim the camcorder at the subject or object you wish to capture.
3. Press the **DV Shutter** button again to start shooting.
4. The elapsed time of the video will appear in red font on the bottom right on the LCD.
5. Press the **DV Shutter** button again to stop the recording.
6. The recorded file will be saved to your memory (internal or SD card) in AVI format.

Note:

1. Press the **Up** button to **Zoom In** or the **Down** button to **Zoom Out** of the subject during the shooting to focus in on your subject.
2. The Zoom icon appears on the bottom left of the LCD screen.
3. You can view the AVI files in playback mode.

4. Once they are downloaded to the PC view them using QuickTime and Windows Media Player.
5. As the internal memory of the camcorder is limited to 64MB the size of videos are limited.
6. Please insert a SD memory card of up to 8 GB to capture longer videos.
7. When the internal memory is full, a "F" icon will show on the LCD screen when you attempt to shoot further videos.

Video Setting options

In Video mode there are two video resolutions for you to choose from before capturing your video (VGA – 640x480, QVGA – 320x240 pixels). The higher the resolution selected the better the quality of the video, however higher quality videos use up more memory. You can also enter and change the White Balance/Exposure/ Color Effect /Setup Mode.

Resolution

White Balance

Exposure

Color Effect

Setup

To enter the Settings submenu options for the Video mode:

1. Press the **OK** button.
2. Press the **Right/Left/Up/Down** button to select the Setting you wish to change from the main menu that appears.

Resolution

You can select different Video resolutions - VGA 640x480 pixels / QVGA 320x240 pixels. Using the smaller resolution allows you to take longer videos. Videos captured at higher resolution are of better quality.

1. Press the **Right/Left/Up/Down** button to select the **Resolution**



menu icon.

2. Press the **OK** button to open the **Resolution** submenu.
3. Press the **Right/Left** button to highlight and select the resolution option:

320x240, 640x480

4. Press the **OK** button to confirm, save your choice and exit to the Setting menu.
5. Press the **DV** button to revert back to the Video capture mode to start capturing videos with the new resolution selected.

Note:

After selecting your resolution, the corresponding icon (VGA/QVGA) will appear on the top right of the LCD.

White Balance

This setting is used to adjust the color of your videos as per your light source.

1. Press the **Right/Left/Up/Down** button to select the **White Balance**  menu icon.
2. Press the **OK** button to open the **White Balance** submenu.
3. Press the **Right/Left/Up/Down** button to highlight and select the White Balance option icon you desire:



4. Press the **OK** button to confirm, save your choice and exit to the Setting menu.
5. Press the **DV** button to revert back to the Video capture mode to start

capturing videos with the new white balance setting selected.

Note:

After selecting your White Balance choice, the corresponding icon will appear on the top of the LCD screen.

Exposure

This setting allows you to manually compensate for unusual lighting conditions such as indirect indoor lighting, dark backgrounds, and strong backlighting. The exposure value range is -2.0 (Dark) to 2.0 (Bright).

1. Press the **Right/Left/Up/Down** button to select the **Exposure** menu icon. 
2. Press the **OK** button to open the **Exposure** submenu.
3. Press the **Left/Right** buttons to select the exposure setting as per the present light condition:

EV-2.0 / EV-1.7 / EV-1.3 / EV-1.0 / EV-0.7 / EV-0.3 / EV+0.0 / EV+0.3 / EV+0.7 / EV+1.0 / EV+1.3 / EV+1.7 / EV+2.0

4. The Exposure effect selected automatically appears on the LCD.
5. Press the **OK** button to confirm, save your choice and exit to the Setting menu.
6. Press the **DV** button to revert back to the Video capture mode to start capturing videos with the new exposure setting selected.

Note:

After selecting your Exposure choice, the corresponding icon will appear on the bottom of the LCD.

Color Effect

This setting is used to adjust the photo effect of your videos.

1. Press the **Right/Left/Up/Down** button to select the **Color Effect** menu icon.
2. Press the **OK** button to open the **Color Effect** submenu.
3. Press the **Right/Left** button to highlight and select the Color Effect option icon you desire:

Color/ Monochrome / Sepia

4. Press the **OK** button to confirm, save your choice and exit to the Setting menu.
5. Press the **DV** button to revert back to the Video capture mode to start capturing videos with the new color effect setting selected.

Note:

The color effect selected now appears on the LCD screen.

Setup Mode

In Setup mode you can adjust the way the camcorder is setup.

1. Press the **Right/Left/Up/Down** button to select the **Setup Mode**  menu icon.
2. Press the **OK** button to open the **Setup Mode** submenu.
3. Press the **Right/Left/Up/Down** button to highlight and select the Setup Mode option icon you desire:



Auto Power Off – this power saving mode allows you to select the stand-by time that is activated automatically if the camcorder is left inactive.

- Press the **OK** button.
- Press the **Right/Left** button to highlight and select one of the

icons:

60 Sec/ 180 Sec/ Disable

- Press the **OK** button to confirm, save your choice and exit to the Setup mode submenu.
- The camcorder will automatically power off if inactive for the time selected.



Buzzer – activate or inactivate the beep sound that is emitted when pressing a button

- Press the **OK** button.
- Press the **Right/Left** button to highlight and select one of the icons:

Enable/ Disable

- Press the **OK** button to confirm, save your choice and exit to the Setup mode submenu.
- If Disable is selected the camcorder will be silent and not emit beeps when buttons are pressed.



Brightness – adjust the brightness of the LCD screen

- Press the **OK** button.
- Press the **Right/Left** button to select the brightness option:

-2.0 (dark) / -1.0 / 0.0 / 1.0 / 2.0 (bright)

- The LCD screen will automatically adjust as the option is selected.
- Press the **OK** button to confirm, save your choice and exit to

the Setup mode submenu.



TV output – You can use your bigger TV screen to playback and view the images and videos on the camcorder instead of using the LCD screen. Before connecting the cable to your TV you need to select the TV system for the TV you are connecting to.

- Press the **OK** button.
- Press the **Right/Left** button to highlight and select one of the icons:

NTSC / PAL

- Press the **OK** button to confirm, save your choice and exit to the Setup mode submenu.



Format – Using this option you can format the built-in memory and SD Card if inserted.

Caution: Formatting the memory will erase all the images. Please download and save all the images to your computer before formatting.

- Press the **OK** button.
- A “FORMAT WILL ERASE ALL DATA CONTINUE?” message appears on the LCD screen with 2 options.
- Press the **Up/Down** button to select the format option:

NO / YES

- If you selected YES the memory will be formatted on pressing the **OK** button.
- If you selected NO the memory will not be formatted and the camcorder will revert to the Setup mode submenu on pressing

the **OK** button.



Date / Time – To set the Date and Time that will appear on images.

- Press the **OK** button.
- Press the **Right/Left** button to select each of the date and time options:

YEAR / MONTH / DAY / 24H / HOUR / MINUTE

- Press the **Up/Down** button to adjust the digits per each date and time option selected.
- Press the **OK** button to confirm, save your choice and exit to the Setup mode submenu.



Light Frequency – Fluorescent lighting flickers very quickly at the same frequency as the mains supply. This can affect the quality of your photos and videos. The anti-flicker frequency can be changed when taking pictures in fluorescent light to correspond with the frequency of the mains supply. 50Hz is used in USA. 60Hz is used in Europe.

- Press the **OK** button.
- Press the **Right/Left** button to select one of the icons:

50Hz / 60 Hz

- Press the **OK** button to confirm, save your choice and exit to the Setup mode submenu.



Default Settings – You can restore you camcorder to the

default factory settings.

- Press the **OK** button.
- A “RESTORE DEFAULT ARE YOU SURE?” message appears on the LCD with 2 options.
- Press the **Up/Down** button to select the default option:

NO / YES

- If you selected YES, the default factory setting will be reset on pressing the **OK** button.
- If you selected NO, the camcorder will revert to the Setup mode submenu on pressing the **OK** button.



Language – adjust the camcorder’s language that appears for the menus on the LCD screen

- Press the **OK** button.
- Press the **Right/Left** button to select the language option:
English / German / French / Spanish / Portuguese / Italian / Dutch / Russian / Turkish
- Press the **OK** button to confirm, save your choice and exit to the Setup mode submenu.
- The LCD menu screens will now appear in the language option selected.

The DVR setup mode  is independent of the video and photo modes and can be accessed from either the **DV** video menu or the **DC** camera menu.

Capturing Still Photos

In order to capture still photos using your camcorder you need to select the

DC camera mode. On turning on your camcorder the first mode to appear is the **DV** mode. To change between the function modes on your DVR, press the **DV or DC** button.

The camcorder has 64MB of built in memory. Use a compatible SD card of up to 8 GB to expand the memory capacity to capture even more memorable photos than can be captured using internal memory only.

The photo icon will now appear on the top right corner of the LCD.

1. The amount of photo left to take at that resolution and memory appears on the bottom right of the LCD.
2. Aim the camcorder at the subject or object you wish to capture.
3. Use the image that appears in the LCD to compose your shot.
4. Hold the camcorder steady and press the **DC Shutter** button again to capture the shot.
5. The camcorder will emit a capture sound as the photo is saved to memory.
6. After the shot is taken the number is reduced by one.
7. The photo file will be saved to your memory (internal or SD card) in JPEG format.
8. The number of photos that can be captured not only depends on the internal memory or the SD card's capacity but also on the resolution selected. Better quality photos are taken at higher resolutions but these will also take up more memory on the card.

Note:

1. Press the **Up** button to **Zoom In** or the **Down** button to **Zoom Out** of the object being photographed.
2. The Zoom icon appears on the bottom left of the LCD screen.
3. You can view the JPEG files in playback mode.
4. As the internal memory of the camcorder is limited to 64MB the amount of photos that can be captured is limited.

5. Please insert an SD memory card of up to 8 GB to capture more photos without having to download them to the computer to free up internal memory.
6. When the internal memory is full, a “F” icon will show on the LCD screen when you attempt to capture further photos.

Photo Setting options

In Photo capture mode there are four photo resolutions for you to choose from before capturing your photos (640x480, 2048x1536, 2592x1944 and 3320x2490 pixels). The higher the resolution selected the better the quality of the photo, however higher quality photos use up more memory. You can also enter and change the Flash Setup / Quality / White Balance / Exposure / Self Timer / Color Effect /Date Stamp and Setup Mode.

Flash Setup

Quality

Resolution

White Balance

Exposure

Self timer

Color Effect

Date Stamp

Setup



To enter the Settings submenu options for the Photo mode:

1. Press the **OK** button.
2. Press the **Right/Left/Up/Down** button to select the Setting you wish to change from the main menu that appears.

Flash Setup

This setting is used to adjust the flash that can be activated in poor light conditions. The flash is affective when taking photos where the object is within 1.8 to 2.5 meters.

1. Press the **Right/Left/Up/Down** button to select the **Flash Setup**  menu icon.
2. Press the **OK** button to open the **Flash Setup** submenu.
3. Press the **Right/Left/Up/Down** button to highlight and select the Flash Setup option icon you desire:

Auto  / Forced  / Off 

4. Press the **OK** button to confirm, save your choice and exit to the Setting menu.
5. Press the **DC** button to revert back to the Photo capture mode.
6. Press the **DC Shutter** button to capture the photo using the flash option that you selected.

Note:

After selecting your Flash Setup choice, the corresponding icon will appear on the top of the LCD screen.

Selecting the Auto choice will let the camcorder decide when to use the flash in the present lighting conditions.

Flash Short-cut button

To activate and toggle between the flash options without going in the Setting menu, press the **Right** button. On each consecutive pressing the flash icon on the top of the LCD will change. Select the flash option and press the DC Shutter button to capture the photo.

Quality

This setting is used to compress the pictures you take in order to make their file-size smaller. While this has the advantage of enabling you to squeeze more photos into the available memory, picture quality is sacrificed.

1. Press the **Right/Left/Up/Down** button to select the **Quality**  menu icon.
2. Press the **OK** button to open the **Quality** submenu.

3. Press the **Right/Left/Up/Down** button to highlight and select the Quality Setup option icon you desire:



4. Press the **OK** button to confirm, save your choice and exit to the Setting menu.
5. Press the **DC** button to revert back to the Photo capture mode.
6. Press the **DC Shutter** button to capture photos using the quality option that you selected.

Resolution

You can select different Photo resolutions – VGA 640x480 pixels / 3 Mega Pixels 2048x1536 / 5 Mega Pixels 2592x1944 / 8.1 Mega Pixels 3320x2490. Using the smaller resolution allows you to take more photos. Photos captured at higher resolution are of better quality but take up more memory.

1. Press the **Right/Left/Up/Down** button to select the **Resolution** menu icon.



2. Press the **OK** button to open the **Resolution** submenu.
3. Press the **Right/Left** button to highlight and select the resolution option:

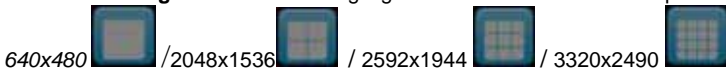

4. Press the **OK** button to confirm, save your choice and exit to the Setting menu.
5. Press the **DC** button to revert back to the Photos capture mode to start capturing photos with the new resolution selected.

Note:

After selecting your resolution, the corresponding icon (VGA / 3M / 5M / 8M) will appear on the top right of the LCD.

White Balance

This setting is used to adjust the color of your photos as per your light source.

1. Press the **Right/Left/Up/Down** button to select the **White Balance**  menu icon.
2. Press the **OK** button to open the **White Balance** submenu.
3. Press the **Right/Left/Up/Down** button to highlight and select the White Balance option icon you desire:

Auto  /Daylight  /Cloudy  /Fluorescent  / Tungsten 

4. Press the **OK** button to confirm, save your choice and exit to the Setting menu.
5. Press the **DC** button to revert back to the Photo capture mode to start capturing photos with the new white balance setting selected.

Note:

After selecting your White Balance choice, the corresponding icon will appear on the top of the LCD screen.

Exposre

This setting allows you to manually compensate for unusual lighting conditions such as indirect indoor lighting, dark backgrounds, and strong backlighting. The exposure value range is -2.0 (Dark) to 2.0 (Bright)

1. Press the **Right/Left/Up/Down** button to select the **Exposure**  menu icon.
2. Press the **OK** button to open the **Exposure** submenu.
3. Press the **Left/Right** buttons to select the exposure setting as per the present light condition:

*EV-2.0 / EV-1.7 / EV-1.3 / EV-1.0 / EV-0.7 / EV-0.3 / EV+0.0 / EV+0.3 /
EV+0.7 / EV+1.0 / EV+1.3 / EV+1.7 / EV+2.0*

4. The Exposure effect selected automatically appears on the LCD.
5. Press the **OK** button to confirm, save your choice and exit to the Setting menu.
6. Press the **DC** button to revert back to the Photo capture mode to start capturing photos with the new EV exposure setting selected.

Note:

After selecting your Exposure choice, the corresponding icon will appear on the bottom of the LCD.

Selftimer

You can include yourself in a photo by using this feature to delay the time between your pressing of the shutter button and when the photo is actually taken. Place the camcorder on a tripod or on a flat and sturdy surface before pressing the Shutter button.

There are 2 methods to activate the Selftimer.

Method 1:

1. In the DC camera mode, press the **Left** button.
2. The Selftimer icon on the top of the LCD will appear.
3. Press the **Left** button until you see the Selftimer option you wish to use appear:



5 Seconds,



10 Seconds,



Burst (continuous snapshot)

4. Press the **DC Shutter** button.
5. The camcorder emits loud beeps until the photo is captured.
6. After the selected time delay the photo will be taken.

Method 2:

1. Press the **Right/Left/Up/Down** button to select the **Selftimer**  menu

icon.

2. Press the **OK** button to open the Selftimer submenu.
3. Press the **Left/Right** buttons to select the selftimer setting:



4. Press the **OK** button to confirm, save your choice and exit to the Setting menu.
5. Press the **DC** button to revert back to the Photo capture mode to start capturing photos with the new self timer setting selected.
6. The Selftimer icon appears on the top of the LCD screen.
7. Press the **DC Shutter** button.
8. The camcorder emits loud beeps as it counts down until the photo is captured.
9. After the selected time delay the photo will be taken.

Burst

Take 3 consecutive photos automatically. You will need enough memory in the camcorder to use this option.

The Burst option is found together with the Selftimer options when using the **Left** button Selftimer method 1 short cut option as explained above.

1. The Burst  icon will appear on the top of the LCD.
2. Press the **DC Shutter** button.
3. Move and point the camcorder at a moving object.
4. The camcorder will now silently and automatically take and save 3 continuous photos.

Color Effect

This setting is used to adjust the color tone of your photos.

1. Press the **Right/Left/Up/Down** button to select the **Color Effect** menu

icon.

2. Press the **OK** button to open the **Color Effect** submenu.
3. Press the **Right/Left** button to highlight and select the Color Effect option icon you desire:

Color/ Monochrome / Sepia

4. Press the **OK** button to confirm, save your choice and exit to the Setting menu.
5. Press the **DC** button to revert back to the Video capture mode to start capturing videos with the new color effect setting selected.



Note:

The image that appears on the LCD screen now appears with the color effect selected.

Date Stamp

You can select to have the Date & Time stamp appear on the photos or not.

1. Press the **Right/Left/Up/Down** button to select the **Date Stamp** menu icon. 
2. Press the **OK** button to open the **Date Stamp** submenu.
3. Press the **Right/Left/Up/Down** button to highlight and select the Date Stamp option icon you desire:

Disable  / *Enable* 

4. To set the Date and Time select **Enable** option and press the Ok button to open the submenu.
5. Press the **Left/Right** button to highlight and select the Year, Month, Day, 24H, Hour and Minutes options you desire to change
6. Press the **Up/Down** button to change the digits for each of the date or time options you desire to update.

7. Press the **OK** button to save the date and time you selected and exit to the Setting menu.
8. Press the **DC** button to revert back to the Photo capture mode.
9. Press the **DC Shutter** button to capture photos with date and time stamps appearing on the photos when viewing the photos in Playback mode or when downloaded to the computer.

Setup Mode





The DVR setup mode is independent of the video and photo modes and can be accessed from either the **DV** video menu or the **DC** camera menu.

See the description of the Setup mode as explained at the end of the Video Setting options section of this manual.

Playback mode

You can playback the videos on your camcorder or attach the TV In cable to watch them on your TV screen.

1. After you open the LCD panel and power on your camcorder, press the **Playback**  mode button situated above the Power On button on the inside wall of the camcorder.
2. The Playback screen will appear with the Playback  icon appearing on the top right corner of the screen.
3. The Playback mode will appear on the LCD as a 2 X 2 matrix of image thumbnails.
4. Press the **Left/Right/Up/Down** buttons to toggle through and select the images you wish to view.
5. Photos will appear with a photo icon and Videos will appear with a video icon on the top left corner of the thumbnails.

6. The number of the images will appear on the bottom right corner of the thumbnail.
7. Press the **OK** button for the images to appear in full screen.
8. Press the **Right/ Left** button to toggle through the images in full screen.

Zoom In and Out of still images:

9. Press the **Up/Down** button to Zoom In and Out of images in full screen.
10. Press the **OK** button to activate and use the **Left/Right/Up/Down** buttons to navigate around in the image.
11. Press the **OK** button again to cancel the navigation feature.

Playback videos:

1. Toggle through the images and videos.
2. Videos in full screen appear with a red square on the top middle of the LCD.
3. Press the **OK** button to Play the video.
4. Press the **OK** button to Pause the video and again to continue playing the video.
5. Press the **Left** button to Fast Rewind the video while it is playing.
6. Press the **Right** button to Fast Forward the video while it is playing.
7. Press the **Up/Down** button to adjust the playback speaker volume of the video.
8. Press the **DV** or **DC Shutter** button to stop the video.

Delete images:

1. Select an image and videos in the Playback mode.
2. Press the **DV** or **DC** button for the Playback menu to appear.
3. Press the **Left/Right** button to select the submenu options:
Delete / Setup
4. Press the **OK** button.

5. If Delete is selected the following submenus appear:
Delete Current / Delete All
6. To Delete the selected image, press the **Left/Right** button to select the Delete Current icon and then press the **OK** button.
7. A "DELETE CURRENT FILE?" message appears on the LCD with NO and YES choices.
8. Press the **Up/Down** button to select the option and then select the **OK** button.
9. If YES is selected the selected image is deleted.
10. To Delete ALL the images on the camcorder's memory, press the **Left/Right** button to select the Delete All icon and then press the **OK** button.
11. A "DELETE ALL ARE YOU SURE?" message appears on the LCD with NO and YES choices.
12. Press the **Up/Down** button to select the option and then select the **OK** button.
13. If YES is selected All the images in the memory are deleted.

Caution: This process is irreversible and the images will be lost forever if they are not firstly downloaded to the computer before deletion.

Setup Mode

The Setup mode for the camcorder can also be access from the Playback mode. For details of the Setup options please see a detailed explanation in the Video settings option section of this manual.

AV mode – Using your TV to view images

You can use your TV to playback and view the images on the camcorder.

1. Plug the camcorder into your TV.
2. Make sure the Display format mode setting on the camcorder is the same as the TV system (NTSC or PAL) you are using.
3. Turn you TV on and turn to Video In (AV mode)
4. Connect the yellow terminal (Video) of the USB cable to VIDEO IN and connect the white terminal (Audio) of the USB cable to AUDIO IN on the TV
5. Insert the USB into the camcorder and turn the camcorder on.
6. Set the camcorder to Playback mode and preview the videos and still images on your bigger TV screen.

Attention:

- When connecting the video cable to the camcorder, the LCD of the camcorder will be blank.
- When connected to the TV the camcorder will continue to use and consume battery power.
- The TV system may affect the quality of the images. Please remember to adjust the display format of the camcorder to the same as that of the TV. (PAL/NTSC)
- The image may not be displayed on the center of the TV screen. This is caused by the TV setting and not a camcorder malfunction.

Connect DVR with PC using USB cable provided

1. Plug one end of the provided USB cable into the USB slot on the back of the camcorder, plug the other end of the USB cable into a USB port on your computer.
2. Turn your camcorder on.
3. The four icons will appear on the camcorder screen.

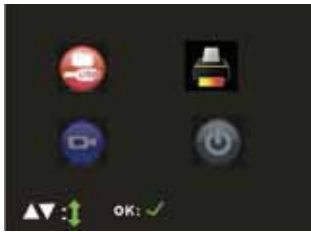

4. Press the Right/Left /Up/Down button to highlight and select the icon you desire, press the OK button to activate this mode, or wait for around 10 seconds to activate this mode automatically.



MSDC (Mass storage)



Printing function is disabled.

When enter into this mode, a  will appear on the screen, after 3 seconds, camcorder revert back to four icons screen automatically.



USB power supply

In this mode, camcorder will consume power of computer, not battery power inside the camcorder.



Power OFF

To power off the camcorder and change to battery charging mode.

Connect DVR with printer using USB cable provided

1. Be sure you have taken some photos in your camcorder before using this function.
2. Plug one end of the provided USB cable into the USB slot on the back of the camcorder, plug the other end of the USB cable into the printer USB slot.
3. Turn your printer on.

4. Turn your camcorder on.
5. The four icons will appear on the camcorder screen. In this mode, only **Print** function is enabled.

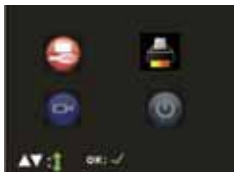

6. Press the Right/Left /Up/Down button to highlight and select the **Print** icon, press the **OK** button to active this function. "Connect Printer" will appear on the screen.
7. press the **Right** button to select the photo want to print, press **Ok** button, "PRINTING CURRENT PHOTO" will appear on the screen, the current photo will be printed out.
8. Once finished printing, repeat Step 7 to print next photo.

Note: In this mode, only **Print** mode is enabled. If enter into the other three modes, pull out the USB cable from camcorder USB slot, and repeat the steps to print photos.

Transferring Images to your PC using the software

Once you have taken photos and videos with your camcorder you now need to download or transfer them to your computer. This allows you to save all your photos and videos for playing, editing, emailing or uploading as you desire.

Once your photos and videos are transferred to the PC you may delete them from your camcorder thereby freeing up the camcorder's memory to take more memorable shots.

Use the "Snap 'n Share Pro" program to import the photos and videos from your camcorder.

1. Plug one end of the provided USB cable into the USB slot on the back of your camcorder.
2. Plug the other end of the USB cable into a USB port on your computer.
3. Turn your camcorder on.
4. Make sure your camcorder is in MSDC (Mass Storage) mode
5. Be sure to wait until the camcorder is recognized by your computer.

Important: We recommend not opening the software until you see the “Your new hardware is installed and ready to use” pop-up box on the taskbar. The camcorder may not function properly if you do not see this message before you open your application.

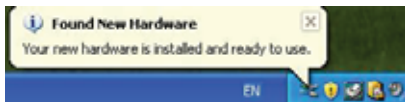

1. Double-click the “Snap ‘n Share Pro” icon that appears on your desktop to launch the “Snap ‘n Share Pro” program.



2. The “**Welcome to Snap ‘n Share Pro**” Product Registration screen will open. This screen will appear each time you open the application until you register. To register your product please click the “Register Online” button and fill out the online registration form (This requires an internet connection).

Important:

1. In order to complete the installation process you are required to register. Registering your product entitles you to discounts on upgrades as well as Free Customer Support.
2. You will not be requested to enter information other than your name, email and address.

Once you have registered successfully you will be able to open and use the Snap 'n Share Pro application.

If you choose to register at a later time click the “**Continue**” button.



- a. The “Snap 'n Share Pro” Main Menu screen appears. Click on the “**Get Media**” button to open the Get Media Wizard to begin transferring the photos and videos captured with your camcorder to the computer.



- Step 1 - Select the device (drive) where media is stored on your camcorder from the Active Devices window. Select the “**Custom**” copy method option to preview and choose the photos and videos you wish to download from the camcorder to your PC.



Note: Selecting the “**Express**” copy option will automatically download all media from the selected device drive to the computer without the option of selecting the media items.

- Step 2 - Select the media items you wish to download and click the “**Next**” button.

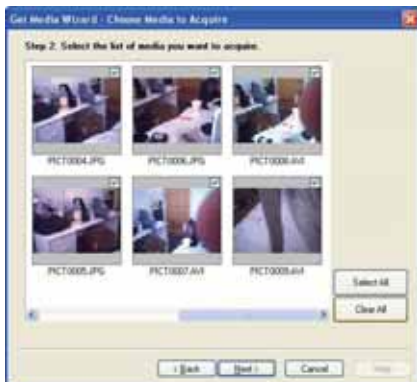

5. Step 3 - If you have photos you can choose to batch these photos once they download. Add active captions to the picture - add a date, keywords and categories. Click the "**Next**" button to continue.



6. Step 4 - Choose where to place your media once it is downloaded to the computer.
- You can also choose the website where you would like to upload your media.
 - You can also select to "Delete the media from the camcorder after the files have been transferred". This will automatically delete the images on your camcorder and free up memory to continue capturing photos and videos.
 - On clicking the "**Finish**" button your media will begin to download from the camcorder to the selected location.



Note: If you also selected a website, once the media is downloaded it can be viewed in the 'Select Photos' mode of your application and the application will jump to the 'Upload' mode and open the web browser of the site you chose.

For more information please refer to the Quick Start Help Guide or Show Me How Tour tutorial from within the "Snap 'n Share Pro" application.

Manually transfer images and videos to your Digital Camcorder

Your camcorder is a Mass Storage device

1. Connect your DV camcorder to your computer using the USB cable.
2. A  icon will appear on top left of the LCD, indicating that your DV camcorder is in Mass Storage Mode, press **OK** button to enter into Mass Storage mode.
3. Double click the My Computer icon on your desktop. Click the Removable Disk that appears. Open the DCIM folder.
4. You can import media from your computer directly to this folder to use it as a removable Disk.
5. You can copy and save the images and videos that you recorded with your camcorder to any folder you wish on your computer

Note: After you connect your DV to your PC, you will need to turn the camcorder on. The camcorder will remain on all the while it is plugged into the USB and it won't be switched off. On disconnecting the USB cable the camcorder will automatically switch off.

Transferring photos and videos to your MAC manually

The Snap 'n Share Pro software is not compatible and will not install on a Mac.

In order to transfer photos, videos from your camcorder to your Macintosh computer:

1. Plug the camcorder into an available USB port
2. A new drive should mount on the desktop which stores any photos, videos and audio files that have been taken.

Everything you need to get the most of your media and MORE

The "Snap 'n Share Pro" software that is now installed on your computer allows you to edit existing photos that you have on your computer as well as playing, emailing and uploading the videos that you have captured with your camcorder.

Note: In order to play the videos Window Media Player needs to be the default player on your computer.

Click the "Snap 'n Share Pro" icon that appears on your desktop to open the "Snap 'n Share Pro" Software.



From the Main Menu screen that appears, select the "**Select Photos**", "**Enhance Photos**" or "**Captions & Sounds**" buttons. You can use these features to edit your photos:



- **Manage your photos** by creating countless unique photo collections without duplicating any photos. Simply select the photos from the Thumbnail window and add them to the collection window at the bottom of the screen. Click the 'Add' button or drag the photo into the window.
- **Play your videos** – double click on the video that appears in the thumbnail screen in the Select Photos mode, or right click on the video and select the 'Play' option from the menu that appears.
- **Burn CD's** of any folders for backup and storage by right clicking on the folder in the Directory tree and choose the 'Burn to CD' option. To burn a CD of your collection, select the collection you wish to burn and then open the Manage Collections drop down menu and choose the Burn to CD option.
- **Enhance your photos** - Auto Enhance, Crop, Correct Red Eye, Manually Adjust and add Special Effects.
- **Add Active Captions and Sounds** - Add Text Captions, Audio, Frames, Shapes, Keywords, Clipart... and more to your photo, that can be viewed or hidden any time.

- **Locate and Organize your photos and collections** - Search by Captions, Category, Keyword or Date directly from the operating system of your computer.
- **SlideShow** – View all the photos in your collection and add background music to your slideshow
- **Share your photos** via E-mail, Local Printing and Create HTML web pages for uploading online.
- **Workshop features** - Create Photo Albums, Frames, Calendars, two-sided Greeting Cards and Postcards to email or print on standard photo paper.
- **Upload Photos & Videos** – Choose one of the websites to upload photos and videos to your account profile in myspace, flickr, facebook or YouTube.



For more detailed information of how to use all these features please refer to the Quick Start Help Guide and/or the Show Me How Tour tutorial from within the “Snap ‘n Share Pro” application.

Video Express application

The Snap ‘n Share Pro software installs a custom built Video Express application.

This application is a convenient and powerful tool for creating your very own professional looking movies.

Create movies on whatever theme you wish. Using all the media that you have on your computer as well as the videos that you capture with your camcorder you can edit, save, upload and burn your movies to CD or DVD to share with family and friends.

The movie is saved in highly compressed wmv format with excellent picture quality.

To open the Video Express:

1. Click the **'Create Videos'** icon from the Snap 'n Share Pro Main Menu to launch the "Video Express" application, or



2. Double click the **"Video Express"** icon that appears on your desktop to launch and open the "Video Express" application.



The following is a basic overview of the steps involved in making a movie.

1. **Create a Project (Manage mode)**

- A movie project is a movie that is still open for editing and revising.
- All of the source files and elements that make up your movie (videos, pictures, audio files) are arranged in a desired sequence with effects and transitions to create your very own movie.

- It is possible to create several unfinished projects at one time.
- Opening a new project in the **'Manage'** mode is the first step in creating your movie.



2. You are now ready you create your own movie by using the **'Prepare'**, **'Effects'** and **'Text'** mode features.

3. Find Media and Create Collections

- The **"Prepare"** mode is the next step in creating a movie. Find the media files on your PC or camcorder that you would like to use in your movie project.
- A movie is made up of video and photo files that are places sequentially with accompanying audio and special effects.
- Media on your PC can either be inserted directly from the **"Folder"** (directory tree) of your computer into your movie project or placed in a "Collection".

- “Collections” are unique compilations of video, picture and audio files that are saved on your PC that you think you might want to use in your movie project.
- Putting a file in a "**Collection**" does not add the file to the movie project or obligate you to do so. It is just a convenient container for files that you think you might want to use at a later point.
- At any stage of the movie creation you can preview the movie by using the **Video Player controls**



4. **Adding Media to your Movie Project**

- The next step is to actually add the media files to your movie project and begin shaping your movie.
- Click the "**Open Media**" button to import media from your Computer to the Video Express
- Click on the "**Get Media**" button to download videos from the camcorder inserted.
- Any file that you want to include in your movie is dragged or added to the '**Timeline/Storyboard**' window.
- This 'Timeline/Storyboard' window displays the files in chronological order.

- Files that have been placed in the 'Timeline/Storyboard' can be easily moved, arranged and added to or removed.
- Use the **"Effects"** mode to add various special effects and transitions between files can also be inserted to give your movie a smooth, professional look and feel.



- You can add **'Text'** either as Titles or Credits to the beginning or end of your movie or as overlay text that will appear anywhere you wish on the selected clip.



5. Creating and Saving a Completed Movie File

- When all of the arranging and editing is finished in the Timeline/Storyboard and your movie project is complete, you are ready to create a completed movie file.
- Completed movie files will be saved to your PC as a .WMV file
- The application gives you the choice of how to share your movie
- The completed movie once saved to your computer can be shared via email, uploaded to the web, copied to a CD or burn to a DVD.



Congratulations!! You have created your very own movie using Video Express.

For more detailed information of how to use all these features please refer to the Quick Start Help Guide and/or the Show Me How Tour tutorial from within the "Video Express" application.

Technical Support

For all installation and software related technical support you can email your enquiries to cs@smithmicro.com.

For all hardware and warranty related issue with the camcorder see the next section.

Your DVR camcorder is a delicate instrument- please handle it with care.

Sakar Warranty Card

This warranty covers for the original consumer purchaser only and is not transferable. Products that fail to function properly UNDER NORMAL USAGE, due to defects in material or workmanship. Your product will be repaired at no charge for parts or labor for a period of one year.

What Is Not Covered By Warranty:

Damages or malfunctions not resulting from defects in material or workmanship and damages or malfunctions from other than normal use, including but limited to, repair by unauthorized parties, tampering, modification or accident.

What To Do When Service Is Required:

When returning your defective product (postage pre-paid) for service, your package should include:

1. Copy of **original** bill of sale
2. A detailed written description of the problem.
3. Your return address and telephone number (Daytime)

MAIL TO ADDRESS BELOW:

Sakar International
Attention: Service Department
195 Carter Drive
Edison, NJ 08817

For technical support issues please visit our website at www.sakarhelp.com. You can find manuals, software, drivers, and FAQ's at the website. Can't find what you are looking for? Fill out an online ticket and one of our technical support team members will answer your questions or call our tech support department toll free at (877) 397-8200

Technical Specifications

Image Sensor	5 Mega Pixels CMOS Sensor
Image Resolution	8.1M(3320X2490); 5 M(2592X1944); 3M(2048X1536); VGA 0.3M(640X480)
Video Resolution	VGA: 640*480 QVGA: 320*240
LCD Display	2.4" TFT color LCD
Focus range	150cm ~ infinity
Shutter	Electronic Shutter: 1/4 ~ 1/1800 s
Internal Memory	64MB
External Memory	SD card up to 8 GB
Focus range	1.0m to infinite
Lens	f = 7.36mm F=3.2
Digital Zoom	8x
Self-timer	5s/10s
File Format	JPEG (Still Image) /AVI (Video)
White balance	Auto / Daylight / Tungsten / Fluorescent / Cloudy
Exposure compensation	-2 (Dark) to +2 (Bright)
Flash mode	Forced, auto, off
Language	English, French, German, Italian, Spanish, Portuguese, Dutch, Russian, Turkish
Auto shutoff	Disable, 60Sec, 180 Sec
TV out	NTSC / PAL
Microphone	YES
Speaker	YES
Recorder	YES
ISO	Auto
Interface	USB 2.0
System Requirements	Windows XP, VISTA or MAC OS 10.2.6 or higher in Mass Storage mode
Battery	Lithium battery 3.7V/>800mAHr

Storage Temperature	Normal Temperature
Working Temperature	0 - 40° C

Trouble Shooting

Power does not turn on.

- | | |
|--|---|
| 1. The Battery is inserted in the wrong direction. | ★Reload battery in the correct direction. |
| 2. The Battery has insufficient power to power on. | ★Replace or recharge the battery. |

The camcorder does not take pictures.

- | | |
|--|--|
| 1. The Memory is full. | ★Insert a new memory card. |
| 2. The Memory card is not formatted correctly. | ★Format the memory card again or use a new card. |

Image is blurry or out of focus.

- | | |
|--|---|
| 1. The video camcorder was moving when the image was captured. | ★Hold the video camcorder steady when shooting picture. |
|--|---|

Image is not displayed on the LCD monitor.

- | | |
|--|---|
| 1. A memory card with non-PICT images (recorded with other camcorder) is loaded. | ★This video camcorder cannot display non-PICT images. |
|--|---|

Recorded images are not saved in memory.

- | | |
|--|---|
| 1. The video camcorder was turned off before the images are saved in memory. | ★If the battery low indicator appears on the LCD monitor, recharge the battery immediately. |
|--|---|

Important Note: Using Camcorder Underwater

The DVR 850W can also be used to capture photos and videos underwater up to a depth of 10 feet/ 3 meters.

- Before using the camcorder underwater make sure you know how the camcorder works. Reading through the User Manual will help you get to know your camcorder.
- Insert the SD card with dry hands before going underwater.
- Make sure the waterproof battery cover door is closed properly before going underwater with your camcorder.
- Do not open the battery cover while underwater.
- Use the camcorder as you normally would to capture photos and videos.
- After capturing images underwater it is perfectly normal that some water may enter the camcorder. This will not damage the camcorder or the images captured.

Note: Once out of the water any water in the camcorder will drain and gradually dry out by itself. Do not attempt to open the camcorder casing, tamper or dismantle the camcorder.

If you use the camcorder in sea water, please rinse the camcorder with fresh clean water as soon as you can afterwards. Sea water has a high salt content as well as small particles of sand and this may damage the camcorder.

Free Manuals Download Website

<http://myh66.com>

<http://usermanuals.us>

<http://www.somanuals.com>

<http://www.4manuals.cc>

<http://www.manual-lib.com>

<http://www.404manual.com>

<http://www.luxmanual.com>

<http://aubethermostatmanual.com>

Golf course search by state

<http://golfingnear.com>

Email search by domain

<http://emailbydomain.com>

Auto manuals search

<http://auto.somanuals.com>

TV manuals search

<http://tv.somanuals.com>