



WHITE-RODGERS

1F89-11

Non-Programmable Electronic Digital
Heat Pump Thermostat
**INSTALLATION AND
OPERATION INSTRUCTIONS**

Operator: Save these instructions for future use!

**FAILURE TO READ AND FOLLOW ALL INSTRUCTIONS CAREFULLY
BEFORE INSTALLING OR OPERATING THIS CONTROL COULD CAUSE
PERSONAL INJURY AND/OR PROPERTY DAMAGE.**

DESCRIPTION

Your new White-Rodgers Digital Heat Pump Thermostat uses the technology of a solid-state microcomputer to provide precise temperature control. This thermostat offers you the flexibility to set heating and cooling temperatures that fit your needs.

Features:

- Simultaneous heat and cool temperature storage
- LCD continuously displays set point and room temperature

- °F/°C convertibility
- Temperature range 45° to 90°F
- Eight terminals for single or two-transformer systems
- O/B terminal for heat pump systems
- Armchair Demonstration Capability

PRECAUTIONS

This thermostat is intended for use with a 24-volt system; do not use this thermostat with a millivolt or line voltage system. If in doubt about whether your wiring is millivolt, line, or low voltage, have it inspected by a qualified heating and air conditioning contractor or electrician.

Do not exceed the specification ratings.

All wiring must conform to local and national electrical codes and ordinances.

This control is a precision instrument, and should be handled carefully. Rough handling or distorting components could cause the control to malfunction.

⚠ CAUTION

To prevent electrical shock and/or equipment damage disconnect electric power to system at main fuse or circuit breaker box until installation is complete.

⚠ WARNING

Do not use on circuits exceeding specified voltage. Higher voltage will damage control and could cause shock or fire hazard.

Do not short out terminals on gas valve or primary control to test. Short or incorrect wiring will damage thermostat and could cause personal injury and/or property damage.

SPECIFICATIONS

ELECTRICAL DATA

Electrical Rating:

20 to 30 VAC 50/60 Hz. or D.C.

0.05 to 1.5 Amps (Load per terminal)

1.5 Amps Maximum Total Load (All terminals combined)

THERMAL DATA

Setpoint Temperature Range:

45°F to 90°F (7°C to 32°C)

Operating Ambient Temperature Range:

32°F to 105°F

Operating Humidity Range:

0 to 90% RH (non-condensing)

Shipping Temperature Range:

-40°F to 150°F

APPLICATIONS

For use with:

- Heat pump systems with up to two stages heat, one stage cool

DO NOT USE WITH:

- Millivolt systems
- Systems exceeding 30 VAC and 1.5 amps
- 3-wire zoned hydronic heating systems



WHITE-RODGERS DIVISION
EMERSON ELECTRIC CO.
9797 REAVIS ROAD
ST. LOUIS, MISSOURI 63123-5398

Printed in U.S.A.

PART NO. 37-5741A

Replaces 37-5612B
9636

INSTALLATION

REMOVE OLD THERMOSTAT

1. Shut off electricity at the main fuse box until installation is complete. Ensure that electrical power is disconnected.
2. Remove the front cover of the old thermostat. **With wires still attached**, remove wall plate from the wall. If the old thermostat has a wall mounting plate, remove the thermostat and the wall mounting plate as an assembly.
3. **Identify each wire attached to the old thermostat using the labels enclosed with the new thermostat.**
4. Disconnect the wires from old thermostat one at a time. **DO NOT LET WIRES FALL BACK INTO THE WALL.**
5. Install new thermostat using the following procedures.

ATTACH THERMOSTAT BASE TO WALL

1. Remove the packing material from the thermostat.
2. If necessary, cut the non-electric heat jumper (see **NON-ELECTRIC HEAT SYSTEMS**). Check the setting of the O/B switch (see **O/B TERMINAL SWITCH SELECTION**).
3. If you want to review the thermostat features before mounting the thermostat on the wall, see **ARMCHAIR DEMONSTRATION**.
4. Gently pull the thermostat cover straight off the base. Forcing or prying on the thermostat will cause damage to the unit.
5. Check that the system switch is in the **OFF** position. Connect wires beneath terminal screws on base using appropriate wiring schematic (see figs. 3 through 5).
6. Place base over hole in wall and mark mounting hole locations on wall using base as a template.
7. Move base out of the way. Drill mounting holes.
8. Fasten base loosely to wall, as shown in fig. 2, using two mounting screws. Place a level against bottom of base, adjust until level, and then tighten screws. (Leveling is for appearance only and will not affect thermostat operation.) If you are using existing mounting holes, or if holes drilled are too large and do not allow you to tighten base snugly, use plastic screw anchors to secure subbase.
9. Push excess wire into wall and plug hole with a fire-resistant material (such as fiberglass insulation) to prevent drafts from affecting thermostat operation.

NON-ELECTRIC HEAT SYSTEMS

Read the following information before clipping the non-electric heat jumper. If you are unsure of your application, contact a qualified serviceperson.

If your emergency or auxiliary system is non-electric (gas, oil, etc.) and will energize the blower, then jumper, W904, on the back of the thermostat base must be cut (see fig. 1).

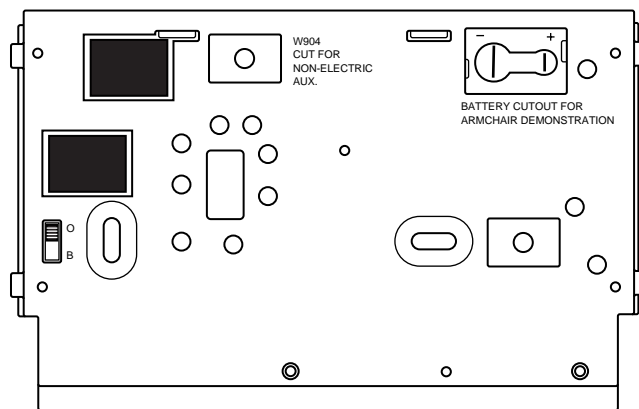

Figure 1. Back of thermostat base

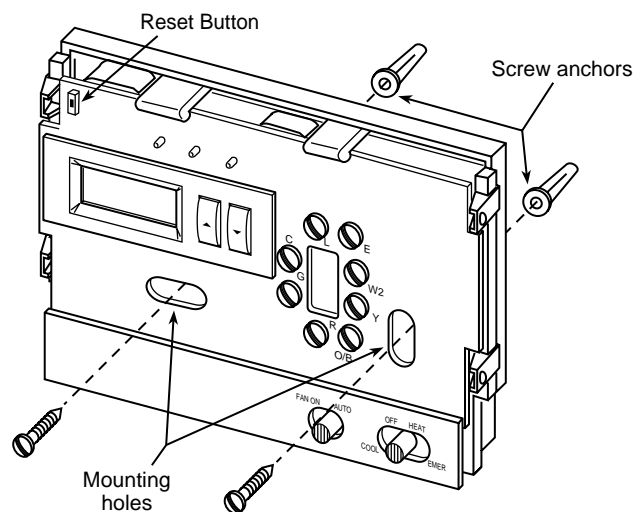

Figure 2. Thermostat base

If your emergency or auxiliary heat system is electric and requires that the thermostat energize the fan circuit, do not cut jumper W904.

O/B TERMINAL SWITCH SELECTION

The O/B switch on this thermostat is factory set to the "O" position. This will accommodate the majority of heat pump applications, which require the changeover relay to be energized in COOL. If the thermostat you are replacing or the heat pump being installed with this thermostat require the "B" terminal, to energize the changeover relay in HEAT, the O/B switch must be moved to the "B" position.

ARMCHAIR DEMONSTRATION

Armchair Demonstration is a unique feature that allows you to review your thermostat features before being mounted on the wall.

If you wish an Armchair Demonstration of your thermostat, temporarily hold a new 9-volt battery against the wires in the battery cutout on the back of the thermostat base for approximately 45 seconds. This will provide a charge that will last approximately 30 to 45 minutes to allow the thermostat to be observed.

NOTE

The following wiring diagrams show **typical** terminal identification and wiring. For proper installation, refer to the original manufacturer's instructions. Relay contacts shown are thermostatically operated.

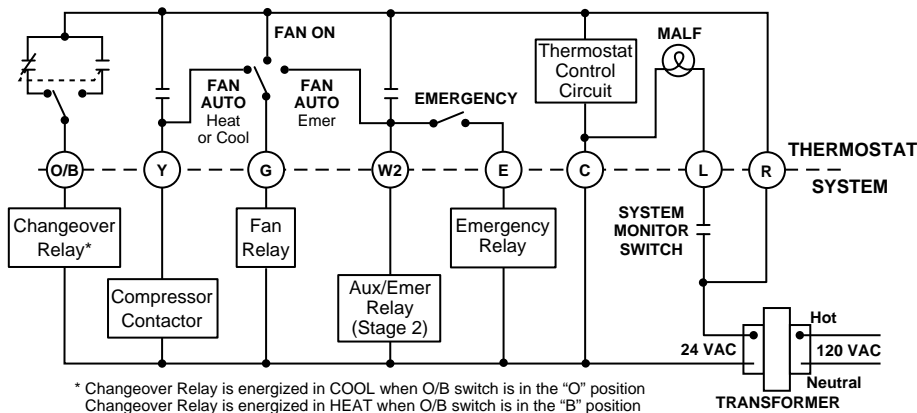

Figure 3. Typical wiring diagram for single transformer systems

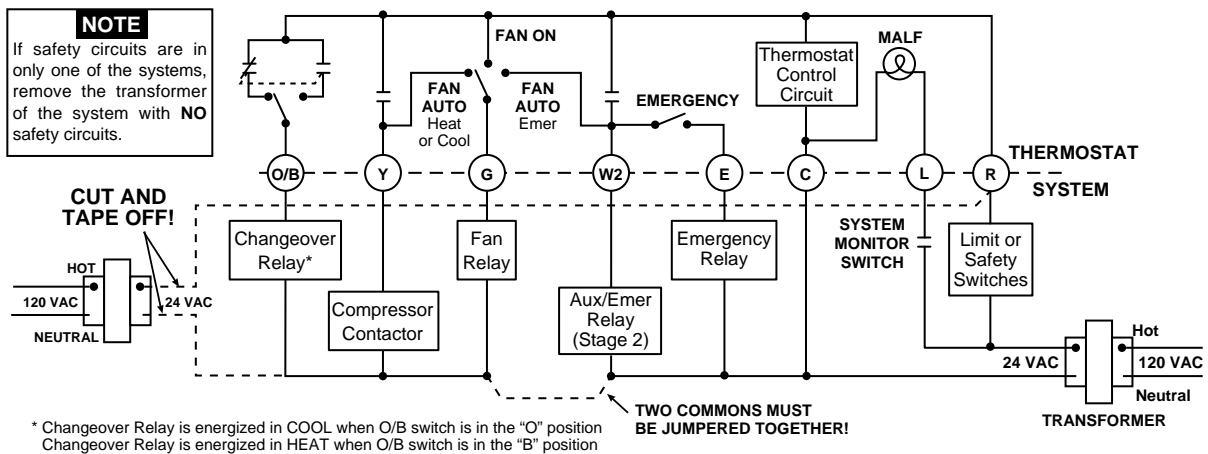

Figure 4. Typical wiring diagram for two transformer systems with NO safety circuits

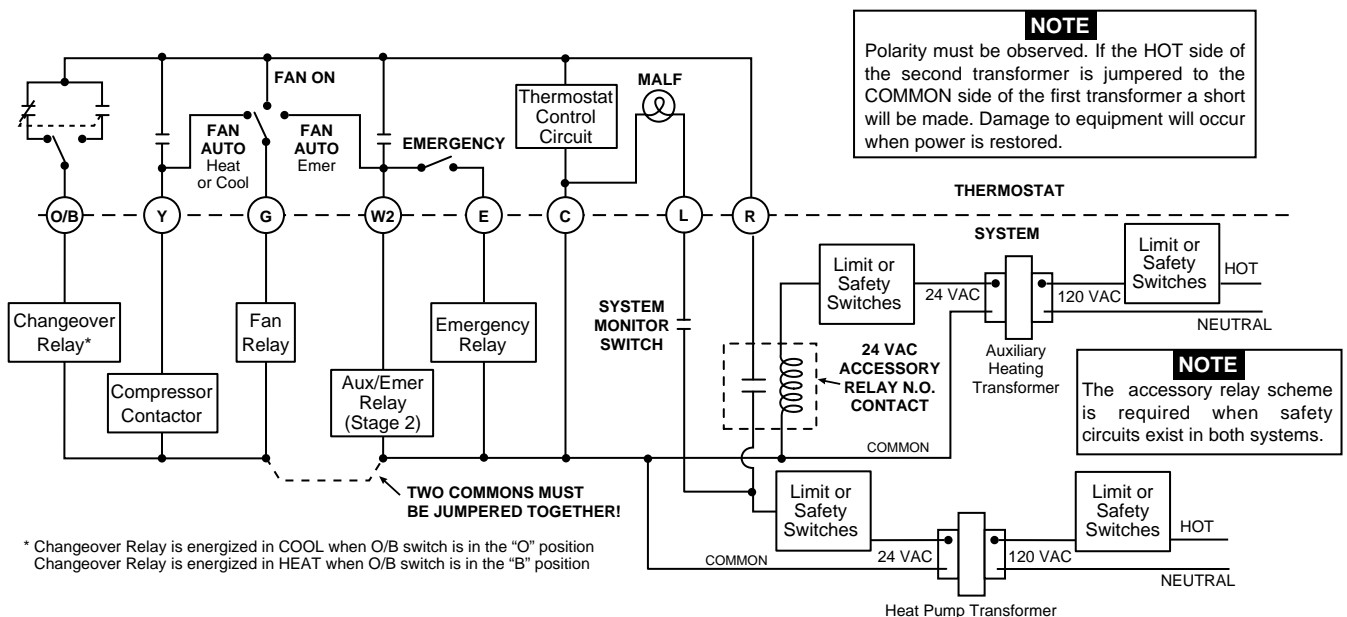



Figure 5. Typical wiring diagram for two transformer systems with safety circuits in BOTH systems

ADJUSTABLE ANTICIPATION

The first stage has anticipation that can be set to 2.5 or 4 cycles per hour for heating or cooling. The second stage heat has a fixed anticipation. To change the first stage anticipation in the HEAT mode, place the SYSTEM switch in the **OFF** position. While holding the  button, move the SYSTEM switch to **HEAT**. The display will show **S** for slow (factory setting) or **F** for fast. Release the  button when the desired anticipation setting is displayed.



CHECK THERMOSTAT OPERATION

If at any time during testing your system does not operate properly, contact a qualified serviceperson.

Fan Operation

1. Turn on power to the system.
2. Move SYSTEM switch to **OFF** position.
3. Move FAN switch to **ON**. The blower should begin to operate.
4. Move FAN switch to **AUTO** position. The blower should stop within a short period of time.



Heating System

1. Move SYSTEM switch to **HEAT** position. If the auxiliary heating system has a standing pilot, be sure to light it.
2. Press  to adjust thermostat setting to 90° and hold for five seconds. Both stages of the heating system should begin to operate. However, if the word **HEAT** is flashing, the compressor lockout feature is operating (see **Lockout Bypass Option** to temporarily override the compressor lockout feature during testing).
3. Press  to adjust temperature setting below room temperature. The auxiliary heating system will stop immediately, and the first stage will stop within three to four minutes.

Cooling System

CAUTION

To prevent compressor and/or property damage, if the outdoor temperature is below 50°F, DO NOT operate the cooling system.

1. Move SYSTEM switch to **COOL** position.
2. Press  to adjust thermostat setting below room temperature. The blower should come on immediately on high speed, followed by cold air circulation. However, if the fan is running but the compressor is not running and the word **COOL** is flashing, the compressor lockout feature is operating (see **Lockout Bypass Option** to temporarily override the compressor lockout feature during testing).
3. Press  to adjust temperature setting above room temperature. The cooling system should stop operating.

LOCKOUT BYPASS OPTION

FOR QUALIFIED SERVICE TECHNICIANS' USE ONLY. OPERATORS SHOULD NOT USE THIS FEATURE DUE TO POSSIBILITY OF EQUIPMENT OR PROPERTY DAMAGE, OR PERSONAL INJURY.



COMPRESSOR SHORT TERM CYCLE PROTECTION

This thermostat has a built-in short term (5-minute) time delay. During this 5-minute period, the thermostat will lock out the compressor to allow head pressure to stabilize. If you want to override this feature while testing thermostat operation, move the SYSTEM switch to **OFF** position for 6 to 10 seconds then back to the desired mode.

DO NOT USE THE LOCKOUT BYPASS OPTION UNLESS THE COMPRESSOR OIL HEATERS HAVE BEEN OPERATIONAL FOR 6 HOURS AND THE SYSTEM HAS NOT BEEN OPERATIONAL FOR AT LEAST 5 MINUTES.

Before you begin operating your thermostat, you should be familiar with its features and with the display and the location and operation of the thermostat buttons. Your thermostat consists of two parts: the **thermostat cover** and the **base**. To remove the cover, gently pull it straight out from the base. To replace the cover, line up the cover with the base and press gently until the cover snaps onto the base.

THE THERMOSTAT BASE

Other than the  and  buttons, the following are located behind the door on the bottom of the thermostat cover (see fig. 6). Pull the door down to open it.

The Thermostat Buttons and Switches





- ① (Red arrow) Raises temperature setting.
- ② (Blue arrow) Lowers temperature setting.
- ③ FAN switch (**ON**, **AUTO**).
- ④ SYSTEM switch (**COOL**, **OFF**, **HEAT**, **EMER**).

The Display

- ⑤ **HEAT** is displayed when the SYSTEM switch is in the **HEAT** position. **COOL** is displayed when the SYSTEM switch is in the **COOL** position. **COOL** or **HEAT** is displayed (flashing) when the compressor is in lockout mode. **OFF** is displayed when the SYSTEM switch is in the **OFF** position.
- ⑥ Displays current room temperature.
- ⑦ **EMERGENCY** is displayed when the system switch is in the **EMER** position.
- ⑧ Displays current set temperature.

OPERATING FEATURES

Now that you are familiar with the thermostat buttons and display, read the following information to learn about the many features of the thermostat.

- **TEMPERATURE SET POINT** — Press  or  until the display shows the temperature you want.
- **°F/°C CONVERTIBILITY** — Press  and  buttons until the temperature display is in Celsius (°C). To display Fahrenheit (°F), repeat the process.
- **TEMPERATURE DISPLAY ADJUSTMENT** — Your new thermostat has been accurately set in our factory. However, if you wish, you may adjust your new thermostat temperature display to match your old thermostat. This can be accomplished (within a $\pm 4^\circ$ range) as follows:

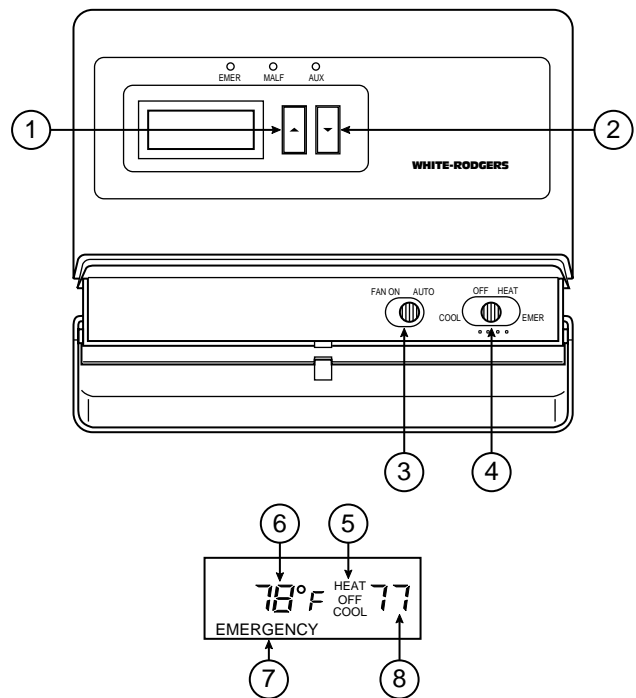







Figure 6. Thermostat display, buttons, and switches

1. Place the SYSTEM switch in the **OFF** position.
 2. While holding the  button, move the SYSTEM switch to **HEAT** or **COOL**. Release the  button when the display shows only the current temperature.
 3. Press  or  to adjust the displayed temperature to your desired setting.
 4. The thermostat will resume normal operation within two minutes.
- **RESET BUTTON** - (see fig. 2) resets the thermostat to the factory setting. This button can be used to reset the thermostat if it has been subjected to a voltage spike and has become scrambled or frozen.

SETTING YOUR THERMOSTAT

This thermostat is easy to operate. Set the SYSTEM switch to **HEAT**, **COOL** or **EMERGENCY**. Press  or  until the temperature to maintain is shown on the right side of the display. To turn the system off, move the SYSTEM switch to **OFF**.

The FAN switch controls the fan operation. When the FAN switch is set to **AUTO**, the fan will cycle with the Heat Pump. When the FAN switch is set to **ON**, the fan will run continuously, regardless of SYSTEM switch position.

Free Manuals Download Website

<http://myh66.com>

<http://usermanuals.us>

<http://www.somanuals.com>

<http://www.4manuals.cc>

<http://www.manual-lib.com>

<http://www.404manual.com>

<http://www.luxmanual.com>

<http://aubethermostatmanual.com>

Golf course search by state

<http://golfingnear.com>

Email search by domain

<http://emailbydomain.com>

Auto manuals search

<http://auto.somanuals.com>

TV manuals search

<http://tv.somanuals.com>