

OWNER'S MANUAL 2008

450 SMR

ART. NO. 3211243en



KTM

Congratulations on your decision to purchase a KTM motorcycle. You are now the owner of a state-of-the-art sports motorcycle that will give you enormous pleasure if you service and maintain it accordingly.

We wish you great pleasure riding the vehicle!

Enter the serial numbers of your vehicle below.

Chassis number (☛ P. 9)	Dealer's stamp
Engine number (☛ P. 9)	

The owner's manual corresponded to the latest state of this series at the time of printing. Slight deviations resulting from continuing development and design of our motorcycles can however not be completely excluded.

All specifications are not binding. KTM Sportmotorcycle AG in particular reserves the right to modify or delete technical specifications, prices, colors, forms, materials, services, designs, equipment, etc., without prior notice and without specifying reasons, to adapt these to local conditions, as well as to stop production of a particular model without prior notice. KTM accepts no liability for delivery options, deviations from illustrations and descriptions, as well as printing and other errors. The models portrayed partly contain special equipment that does not belong to the regular scope of delivery.

© 2007 by KTM-Sportmotorcycle AG, Mattighofen Austria

All rights reserved

Reproduction, even in part, is permitted only with the express written permission of the copyright owner.























ISO 9001(12 100 6061)

Within the meaning of the international quality management standard ISO 9001, KTM uses quality assurance processes that lead to the maximum possible quality of the products.

Issued by: TÜV Management Service





KTM-Sportmotorcycle AG
5230 Mattighofen, Austria

MEANS OF REPRESENTATION	4	Adjusting compression damping of fork	25
IMPORTANT NOTES	5	Adjusting rebound damping of fork.....	26
VIEW OF VEHICLE.....	7	Bleeding fork legs.....	26
View of vehicle, front left side.....	7	Cleaning dust boots of fork legs	26
View of vehicle, rear right side	8	Removing the fork protector.....	27
LOCATION OF SERIAL NUMBERS	9	Installing the fork protector	27
Chassis number.....	9	Checking play of steering head bearing	27
Type label.....	9	Adjusting play of steering head bearing 🛠️.....	28
Engine number.....	9	Fork offset	28
Fork part number.....	9	Setting the fork offset 🛠️	29
Shock absorber part number	9	Removing the fork legs 🛠️	29
OPERATING ELEMENTS	10	Installing the fork legs 🛠️.....	29
Clutch lever	10	Removing the lower triple clamp 🛠️	30
Hot start lever	10	Installing the lower triple clamp 🛠️	30
Hand brake lever	10	Greasing the steering head bearing 🛠️	31
Short circuit button	10	Dismounting the front fender.....	31
Electric starter button	10	Installing the front fender.....	31
Fuel tap.....	11	Dismount the start number plate.....	32
Opening filler cap.....	11	Fitting the start number plate	32
Closing filler cap	11	Handlebar position	32
Choke.....	11	Adjusting handlebar position 🛠️.....	32
Shift lever.....	12	Checking gas Bowden cable route	33
Foot brake pedal	12	Checking play in the gas Bowden cable	33
Plug-in stand	12	Adjusting the gas Bowden cable play 🛠️	33
GENERAL TIPS AND HINTS ON PUTTING INTO OPERATION.....	13	Checking chain dirt	34
Advice on first use.....	13	Cleaning the chain.....	34
Running in the engine.....	14	Checking the chain tension	34
RIDING INSTRUCTIONS	15	Checking the chain tension when fitting rear wheel.....	35
Checks before putting into operation	15	Checking the rear sprocket / engine sprocket for wear	35
Starting	15	Checking chain wear	35
Starting up	16	Adjusting the chain tension	36
Shifting, riding.....	16	Adjusting chain tension - after checking	37
Braking	16	Adjusting chain tension - fitting rear wheel	37
Stopping, parking.....	16	Adjusting chain guide 🛠️	38
Refueling.....	17	Brake fluid reservoir.....	38
GREASING AND SERVICE TABLE	18	Brake calipers	38
Important maintenance work to be carried out by an authorized KTM workshop.	18	Checking brake discs	38
Important maintenance work to be carried out by an authorized KTM workshop. (as additional order).....	19	Checking free play of hand brake lever.....	39
Important checks and maintenance work to be carried out by the rider.	19	Adjusting basic position of handbrake lever.....	39
MAINTENANCE WORK ON CHASSIS AND ENGINE.....	21	Checking front brake fluid level.....	39
Jacking up the motorcycle.....	21	Topping up the front brake fluid 🛠️	40
Removing the motorcycle from the work stand.....	21	Checking the front brake linings.....	40
Checking the basic chassis setting with the rider's weight	21	Removing front brake linings 🛠️.....	41
Compression damping of shock absorber.....	21	Mounting front brake linings 🛠️	41
Adjusting high-speed compression damping of the shock absorber	21	Changing the front brake linings 🛠️.....	42
Adjusting the low-speed compression damping of the shock absorber.....	22	Checking free play of foot brake lever	43
Adjusting rebound damping of the shock absorber	22	Adjusting basic position of footbrake lever 🛠️.....	43
Measuring rear wheel sag unloaded	23	Checking the rear brake fluid level	43
Checking static sag of the shock absorber	23	Adding rear brake fluid 🛠️.....	44
Check the riding sag of the shock absorber.	23	Checking rear brake linings	44
Adjusting spring preload of the shock absorber 🛠️	24	Removing rear brake linings 🛠️	45
Adjusting riding sag 🛠️.....	24	Installing the rear brake linings 🛠️	45
Removing the shock absorber 🛠️.....	25	Changing the rear brake linings 🛠️	46
Installing shock absorber 🛠️	25	Removing front wheel 🛠️.....	46
Checking basic setting of fork	25	Fitting front wheel 🛠️	47
		Removing rear wheel 🛠️	48
		Fitting rear wheel 🛠️.....	48
		Tire condition checking.....	49
		Checking tire air pressure.....	49
		Checking spoke tension.....	50
		Removing the battery 🛠️	50

Installing the battery 	50	STANDARDS.....	86
Recharging the battery 	51	INDEX.....	87
Removing a fuse.....	52		
Replacing the fuse.....	52		
Ignition curve plug connection.....	52		
Changing the ignition curve.....	52		
Removing the seat.....	53		
Mounting the seat.....	53		
Dismounting the fuel tank 	53		
Installing the fuel tank 	54		
Cooling system.....	55		
Checking antifreeze and coolant level.....	55		
Checking the coolant level.....	55		
Draining coolant 	56		
Refilling coolant 	56		
Removing main silencer.....	57		
Fitting the main silencer.....	57		
Glass fiber yarn filling of main silencer.....	57		
Removing glass fiber yarn filling of main silencer 	57		
Fitting glass fiber yarn filling of main silencer 	58		
Changing glass fiber yarn filling of main silencer 	58		
Dismounting the air filter box lid.....	58		
Installing the air filter box lid.....	58		
Removing the air filter 	58		
Installing the air filter 	59		
Cleaning air filter 	59		
Adjusting basic position of clutch lever.....	59		
Checking fluid level of hydraulic clutch.....	60		
Changing fluid level of hydraulic clutch 	60		
Carburetor - idle.....	61		
Carburetor - adjusting idle 	61		
Emptying the carburetor float chamber 	62		
Checking engine oil level.....	62		
Changing engine oil and oil filter, cleaning oil screen 	63		
Draining engine oil 	63		
Cleaning the oil screen 	63		
Removing the oil filter 	64		
Mounting oil filter 	64		
Filling up with engine oil 	64		
Topping up engine oil.....	65		
TROUBLESHOOTING.....	66		
CLEANING.....	68		
Cleaning motorcycle.....	68		
STORAGE.....	69		
Storage.....	69		
Putting into operation after storage.....	69		
TECHNICAL DATA - ENGINE.....	70		
Capacity - engine oil.....	70		
Capacity - coolant.....	70		
TECHNICAL DATA - ENGINE TIGHTENING TORQUES.....	71		
TECHNICAL DATA - CARBURETOR.....	73		
TECHNICAL DATA - CHASSIS.....	74		
Capacity - fuel.....	75		
TECHNICAL DATA - FORK.....	76		
Capacity - fork oil.....	76		
TECHNICAL DATA - SHOCK ABSORBER.....	77		
TECHNICAL DATA - CHASSIS TIGHTENING TORQUES.....	78		
WIRING DIAGRAM.....	80		
Wiring diagram.....	80		
SUBSTANCES.....	82		
AUXILIARY SUBSTANCES.....	84		

Symbols used

The symbols used are explained in the following.

-
- | | |
|--|---|
|  | Indicates an expected reaction (e.g. of a work step or a function). |
|  | Indicates an unexpected reaction (e.g. of a work step or a function). |
|  | All work marked with this symbol requires specialist knowledge and technical understanding. In the interest of your own safety, have these jobs done in an authorized KTM workshop! There, your motorcycle will be serviced optimally by specially trained experts using the specialist tools required. |
|  | Identifies a page reference (more information is provided on the specified page). |
-

Formats used

The typographical and other formats used are explained in the following.

-
- | | |
|----------------------|--|
| Specific name | Identifies a specific name. |
| Name® | Identifies a protected name. |
| Brand™ | Identifies a brand in merchandise traffic. |
-

Use definition

KTM sport motorcycles are designed and built to withstand the normal stresses and strains of competitive use. The motorcycles comply with currently valid regulations and categories of the top international motorsport organizations.



Info

The motorcycle must be used only on secluded property remote from public road traffic.

Maintenance

A prerequisite for perfect operation and prevention of wear is that the engine and chassis maintenance and adjustment work described in the owner's manual are properly carried out. Poor adjustment and tuning of the engine and chassis can lead to damage and breakage of components.

Using the motorcycle in extreme conditions such as very muddy or wet terrain can lead to above-average wear of components such as the transmission train or the brakes. For this reason, it may be necessary to service or replace worn parts before the limit specified in the greasing and service table is reached.

Pay careful attention to the prescribed running-in period, inspection and maintenance intervals. If you observe these exactly, you will ensure a much longer service life for your motorcycle.

Warranty

The maintenance work prescribed in the greasing and service table must be carried out in an authorized KTM workshop and confirmed in the customer's service record, since otherwise no warranty claims will be recognized. No warranty claims can be considered for damage resulting from manipulations and alterations to the motorcycle.

Fuel, oils, etc.

You should use the fuels, oils and greases according to specifications as listed in the owner's manual.

Spare parts, accessories

For your own safety, use only spare parts and accessories approved by KTM. KTM accepts no liability for other products and any resulting damage or loss.

Transport

Note

Danger of damage Danger of damage by the vehicle running away or falling over.

- Always place the vehicle on a firm and even surface.

Note

Fire hazard Some components (engine, radiator and exhaust system) get very hot when the engine is running.

- Do not place the vehicle where there are flammable or explosive substances.

- switch off engine.

- Turn the handle ❶ of the fuel tap to the **OFF** position.

- Use straps or other suitable devices to secure the motorcycle against accidents or falling over.

Environment

Offroad motorcycling is a wonderful sport and we naturally hope that you will be able to enjoy it to the fullest. However, it is a potential problem for the environment and can lead to conflicts with other persons. But if you use your motorcycle responsibly, you can ensure that such problems and conflicts do not have to occur. To protect the future of motorcycle sport, make sure that you use your motorcycle legally, display environmental consciousness, and respect the rights of others.

Warning notes

In your own interest, read the specified warning notes.



Info

Various warning labels are attached to your vehicle. Do not remove any warning labels. If they are missing, you or others may not recognize dangers and may therefore be injured.

Grades of risks



Danger

Danger that leads immediately and certainly to severe and permanent injury or death.



Warning

Danger that will probably lead to severe and permanent injury or death.

Note

Danger of serious damage to machine or material.



Warning

Risk of environmental damage.

OWNER'S MANUAL

- Read this owner's manual carefully and completely before making your first trip. It contains a lot of information and tips to help you operate and handle your motorcycle. Only then will you find out how to customize the motorcycle ideally for your own use and how you can protect yourself from injury. The owner's manual also contains important information on servicing the motorcycle.
- The owner's manual is an important component of the motorcycle and should be handed over to the new owner if the vehicle is sold.

View of vehicle, front left side



500182-10

- | | |
|----|--------------------|
| 1 | Hand brake lever |
| 2 | Start number plate |
| 3 | Front fender |
| 4 | Front wheel |
| 5 | Fork part number |
| 6 | Oil filter cover |
| 7 | Plug-in stand |
| 8 | Shift lever |
| 9 | Choke button |
| 10 | Air filter |
| 11 | Filler cap |
| 12 | Clutch lever |

View of vehicle, rear right side



500183-10

1	Main silencer
2	Shock absorber
3	Brake caliper of rear wheel brake
4	Rear wheel
5	Foot brake pedal
6	Manifold
7	Chassis number/type label
8	Throttle grip

Chassis number



The chassis number ❶ is stamped on the steering head on the right.

Type label



The type label ❶ is fixed to the front of the steering head.

Engine number

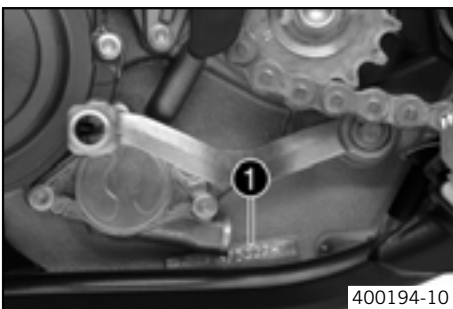

The engine number ❶ is stamped on the left side of the engine under the engine sprocket.

Fork part number

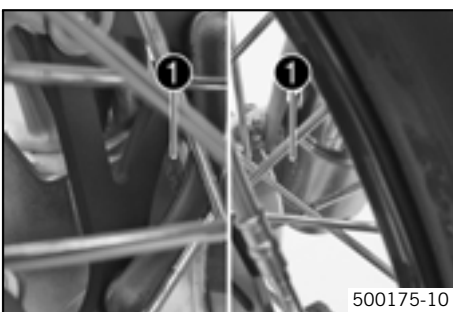

The fork part number ❶ is stamped on the inner side of the fork stub.

Shock absorber part number



The shock absorber part number ❶ is stamped on the top of the shock absorber above the adjusting ring on the engine side.

Clutch lever

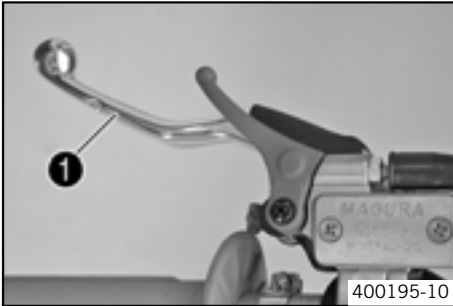

The clutch lever ❶ is fitted on the left side of the handlebar. The clutch is hydraulically operated and self-adjusting.

Hot start lever

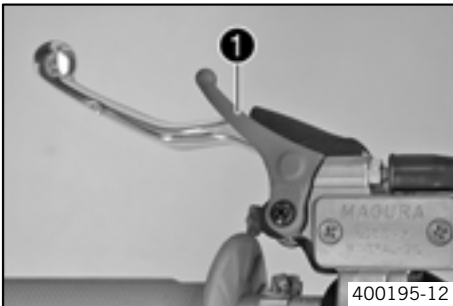

The hot start lever ❶ is fitted on the left side of the handlebar. If you pull the hot start lever to the handlebar during the start procedure, a bore is opened in the carburetor through which the engine can draw in extra air. This gives a leaner fuel-air mixture, which is needed for a hot start.

Possible states

- Hot start function activated – Hot start lever is pulled out to the stop.
- Hot start function deactivated – Hot start lever is pushed back to the stop.

Hand brake lever

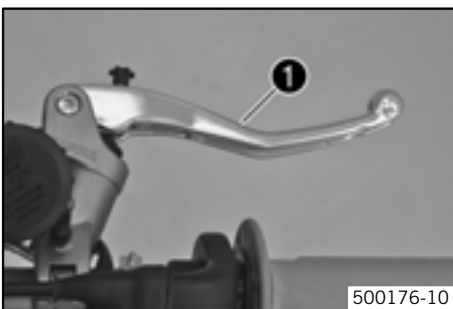

The hand brake lever ❶ is located on the right side of the handlebar and operates the front wheel brake.

Short circuit button

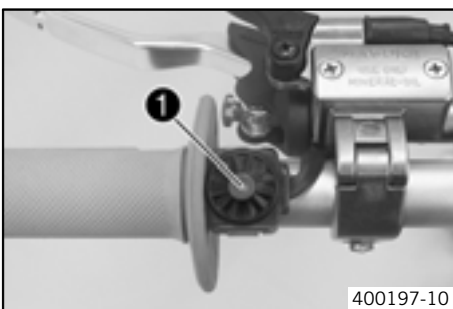

The short circuit button ❶ is fitted on the left side of the handlebar.

Possible states

- Short circuit button ☒ in basic position – In this position, the ignition circuit is closed, and the engine can be started.
- Short circuit button ☒ pressed – In this position, the ignition circuit is interrupted, a running engine stops, and a non-running engine will not start.

Electric starter button



The electric starter button ❶ is fitted on the right side of the handlebar.

Possible states

- Electric starter button ☑ in basic position
- Electric starter button ☑ pressed – In this position, the electric starter is actuated.

Fuel tap

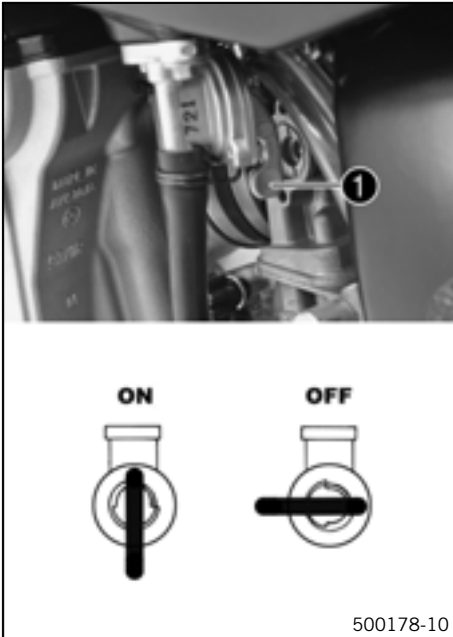

500178-10

With the tap handle ❶ on the fuel tap, you can open or close the supply of fuel to the carburetor.

Possible states

- Fuel supply closed **OFF** – No fuel can flow from the tank to the carburetor.
- Fuel supply open **ON** – Fuel can flow from the tank to the carburetor. The fuel tank empties completely.

Opening filler cap

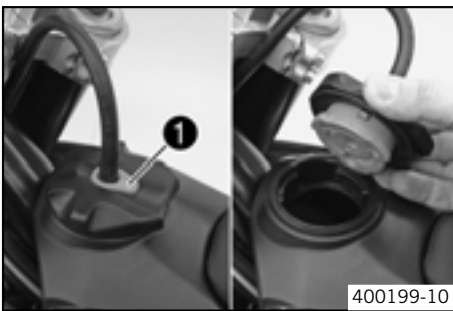

400199-10

- Press release button ❶, turn filler cap counterclockwise and lift it free.

Closing filler cap

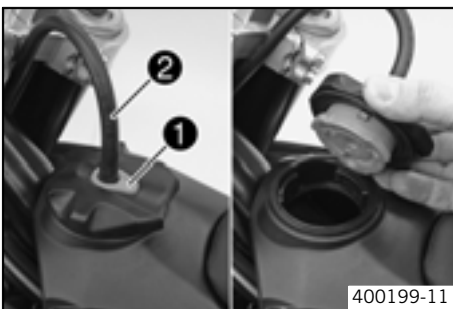

400199-11

- Replace the filler cap and turn clockwise until the release button ❶ locks in place.



Info

Run the fuel tank breather hose ❷ without kinks.

Choke

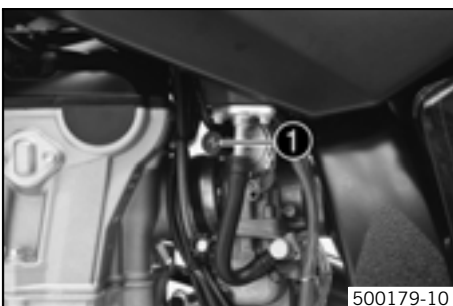

500179-10

The choke ❶ is fitted on the left side of the carburetor.

Activating the choke function frees an opening through which the engine can draw extra fuel. This gives a richer fuel-air mixture, which is needed for a cold start.

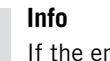

Info

If the engine is warm, the choke function must be deactivated.

Possible states

- Choke function activated – The choke lever is pulled out to the stop.
- Choke function deactivated – The choke lever is pushed in to the stop.

Shift lever

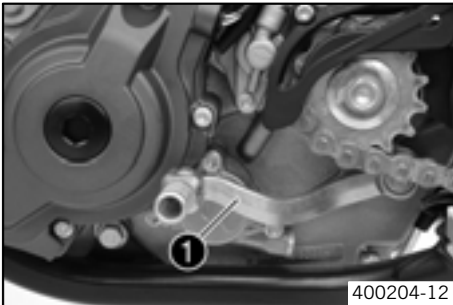

The shift lever ❶ is mounted on the left side of the engine.

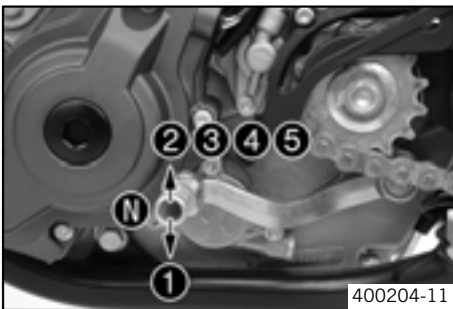

The gear positions can be seen in the photograph. The neutral or idle position is between the first and second gears.

Foot brake pedal



The foot brake pedal ❶ is located in front of the right footrest and operates the rear wheel brake.

Plug-in stand

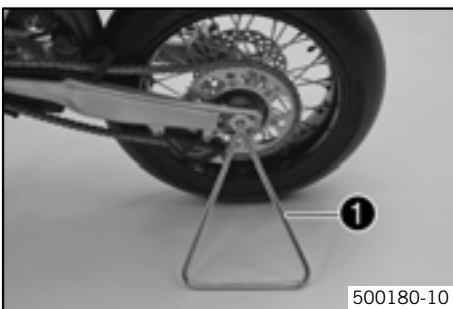

Note

Danger of damage Danger of damage by the vehicle running away or falling over.







- Always place the vehicle on a firm and even surface.

To stand the motorcycle, plug the plug-in stand ❶ into the left side of the wheel spindle.

Info

Before riding, remove the plug-in stand.

Advice on first use

-  **Danger**
Danger of accidents Danger from inadequate traffic experience.
 - Do not use the vehicle if you are inexperienced or if you have consumed alcohol or drugs.
-  **Warning**
Risk of injury Risk of injury by missing/inadequate protective clothing.
 - Wear protective clothing (helmet, boots, gloves, pants and jacket with protectors) every time you ride the vehicle.
-  **Warning**
Danger of accidents Critical riding behavior due to inappropriate riding.
 - Adapt your riding speed to the road conditions and your riding ability.
-  **Warning**
Danger of accidents Accident risk caused by presence of a passenger.
 - Your vehicle is not designed to carry passengers. Do not ride with a passenger.
-  **Warning**
Danger of accidents Brake system failure.
 - If the foot brake pedal is not released, the brake linings drag permanently. The rear brake can fail due to overheating. Take your foot off the foot brake pedal if you do not want to brake.
-  **Warning**
Danger of accidents Unstable riding behavior.
 - Do not exceed the maximum permitted weight and axle loads.
-  **Warning**
Risk of misappropriation Usage by unauthorized persons.
 - Never leave the vehicle while the engine is running. Secure the vehicle against use by unauthorized persons.

 **Info**
When using your motorcycle, remember that others may feel disturbed by excessive noise.

- Make sure that the pre-delivery inspection work has been carried out by an authorized KTM workshop. You receive a delivery certificate and the service record at vehicle handover.
- Before your first trip, read the entire operating instructions carefully.
- Get to know the operating elements.
- adjust the basic position of clutch lever. (☛ P. 59)
- adjust the basic position of handbrake lever. (☛ P. 39)
- Adjust the basic position of the footbrake lever. (☛ P. 43)
- Get used to handling the motorcycle on a suitable piece of land before making a longer trip.

 **Info**
Your motorcycle is not licensed for use on public roads.

- Try also to ride as slowly as possible and in a standing position to get a better feeling for the vehicle.
- Do not make any trips that over-stress your ability and experience.
- Hold the handlebar firmly with both hands and keep your feet on the footrests when riding.
- Do not make any changes to the motorcycle, and use only KTM approved parts.
- Do not carry any baggage.

 **Info**
Motorcycles react sensitively to any changes of weight distribution.

- Do not exceed the overall maximum permitted weight and the axle loads.

Specification

Maximum permissible overall weight	335 kg (738.54 lb.)
Maximum permissible front axle load	145 kg (319.67 lb.)
Maximum permissible rear axle load	190 kg (418.87 lb.)

- Run the engine in.

Running in the engine

- During the running-in phase, do not exceed the specified engine speed and engine performance.

Specification

Maximum engine speed	
During the first 3 service hours	7000 rpm
Maximum engine performance during the running-in period	
During the first 3 service hours	≤ 50 %
During the next 12 service hours	≤ 75 %

- Avoid fully opening the throttle!

Checks before putting into operation



Info

Make sure that the motorcycle is in a perfect technical condition before use.



Info

In the interests of riding safety, make a habit of making a general check before you ride.

- Check the engine oil level. (☛ P. 62)
- Check the chain tension. (☛ P. 34)
- Check the chain dirt accumulation. (☛ P. 34)
- Check the tire condition. (☛ P. 49)
- Checking the tire air pressure. (☛ P. 49)
- Check the front brake brake fluid level. (☛ P. 39)
- Check the rear brake fluid level. (☛ P. 43)
- Check the front brake linings. (☛ P. 40)
- Check the rear brake linings. (☛ P. 44)
- Check brake system function.
- Check the coolant level. (☛ P. 55)
- Check that all operating elements are correctly adjusted and free to move.

Starting



Danger

Danger of poisoning Exhaust gases are poisonous and can result in unconsciousness and/or death.

- When running the engine, always make sure there is sufficient ventilation, and do not start or run the engine in a closed space.

Note

Engine failure High engine speeds in cold engines have a negative effect on the service life of the engine.

- Always warm up the engine at low engine speeds.



Info

If the motorcycle is unwilling to start, the cause can be old fuel in the float chamber. The flammable elements of the fuel evaporate after a long time of standing.

If the float chamber is filled with fresh fuel, the engine starts immediately.

Press the starter for a maximum of 5 seconds. Wait for a least 5 seconds until trying again.

Conditions

Motorcycle standing still: ≥ 1 week

- Empty the carburetor float chamber. (☛ P. 62)
- Turn the handle ❶ of the fuel tap to the **ON** position. (Figure 500178-10 ☛ P. 11)
- ✓ Fuel can flow from the tank to the carburetor.
- Remove the motorcycle from the stand.
- Shift gear to neutral.

Conditions

Engine cold

- Pull choke lever out as far as possible.

Conditions

Engine warm

- Pull the hot start lever out to the stop.
- Press the electric starter button. (☞)



Info

Don't open the throttle.

Conditions

Engine hot and running

- Push back the hot start lever to the stop with the engine running.

Starting up

- Pull the clutch lever, engage 1st gear, release the clutch lever slowly and simultaneously open the throttle carefully.

Shifting, riding



Warning

Danger of accidents If you change down at high engine speed, the rear wheel can lock up.

- Do not change into a low gear at high engine speed. The engine races and the rear wheel can block.



Info

If you hear unusual noises while riding, stop immediately, switch off the engine and contact an authorized KTM workshop. First gear is used for starting off or for steep inclines.

- When conditions allow (incline, road situation, etc.), you can shift into a higher gear. To do so, release the throttle while simultaneously pulling the clutch lever, shift into the next gear, release the clutch and open the throttle.
- If the choke function was activated, deactivate it after the engine has warmed up.
- When you reach maximum speed after fully opening the throttle, turn back the throttle to about 3/4 of its range; the speed hardly drops, but the fuel consumption falls considerably.
- Always open the throttle only as much as the engine can handle – abrupt throttle opening increases fuel consumption.
- To shift down, brake if necessary and close the throttle at the same time.
- Pull the clutch lever and shift into a lower gear, release the clutch lever slowly and open the throttle or shift again.
- Switch off the engine if you expect to be standing for a long time.

Specification

≥ 2 min

- Avoid frequent and longer slipping of the clutch. This heats the engine oil, the engine and the cooling system.
- Ride with a lower engine speed instead of with a high engine speed and a slipping clutch.

Braking



Warning

Danger of accidents If you brake too hard, the wheels can lock.

- Adapt your braking to the traffic situation and the road conditions.



Warning

Danger of accidents Reduced braking caused by spongy pressure point of front or rear brake.

- Have the brake system checked in an authorized KTM workshop, and do not ride any further.



Warning

Danger of accidents Reduced braking due to wet or dirty brakes.

- Clean or dry dirty or wet brakes by riding and braking gently.

- On sandy, wet or slippery surfaces, use the rear brake.
- Braking should always be completed before you go into a bend. Change down to a lower gear appropriate to your road speed.
- On long downhill stretches, use the braking effect of the engine. Change down one or two gears, but do not overstress the engine. In this way, you have to brake far less and the brakes do not overheat.

Stopping, parking



Warning

Danger of burns Some vehicle components get very hot when the machine is driven.

- Do not touch hot components such as exhaust system, radiator, engine, shock absorber and brakes. Allow these components to cool down before starting work on them.

Note

Danger of damage Danger of damage by the vehicle running away or falling over.

- Always place the vehicle on a firm and even surface.

Note

Fire hazard Some components (engine, radiator and exhaust system) get very hot when the engine is running.

- Do not place the vehicle where there are flammable or explosive substances.
-
- Brake the motorcycle.
 - Shift gear to neutral.
 - Press the short circuit button ☒ when the engine is idling until the engine stops.
 - Turn the handle ❶ of the fuel tap to the **OFF** position. (Figure 500178-10 ☛ P. 11)
 - Stand the motorcycle on a hard surface.

Refueling



Danger

Fire hazard Fuel can easily catch fire.

- Never fill up the vehicle near open flames or burning cigarettes, and always switch off the engine first. Be careful that no fuel is spilt, especially on hot vehicle components. Clean up spilt fuel immediately.
- Fuel in the fuel tank expands when warm and can escape if the tank is overfilled. See specifications on filling up with fuel.



Warning

Danger of poisoning Fuel is poisonous and a health hazard.

- Avoid contact between fuel and skin, eyes and clothing. Do not inhale fuel vapors. If fuel gets into your eyes, rinse immediately with water and contact a doctor. Wash affected skin areas immediately with soap and water. If fuel is swallowed, contact a doctor immediately. Change clothing that has come into contact with fuel.



Warning

Environmental hazard Improper handling of fuel is a danger to the environment.

- Do not allow fuel to get into the ground water, the ground, or the sewage system.

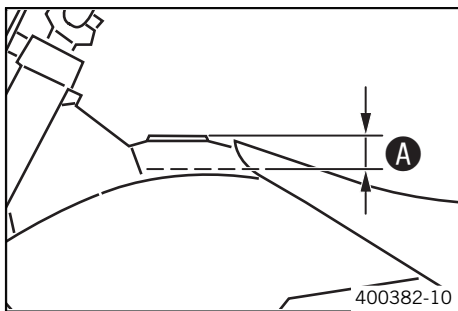

- Open the filler cap. (☛ P. 11)
- Fill the fuel tank with fuel up to measurement **A**.
Specification

Measurement of A	35 mm (1.38 in)	
-------------------------	-----------------	--

Tank capacity	8.2 l (2.17 US gal)	Super unleaded (ROZ 95 / RON 95 / PON 91) (☛ P. 82)
---------------	------------------------	---

- Close the filler cap. (☛ P. 11)

Important maintenance work to be carried out by an authorized KTM workshop.

		S3N	S10A	S30A
Engine	Change the engine oil and oil filter, and clean the oil screen. (☛ P. 63)	•	•	
	Replace spark plug.			•
	Check and adjust valve clearance.	•	•	
	Check engine mounting screws for tightness.	•	•	
	Clean spark plug connectors and check for tightness.	•	•	
	Check screw of shift lever for tightness.	•	•	
Carburetor	Check carburetor connection boots for cracks and leakage.		•	
	Check vent hoses for damage and routing without sharp bends.	•	•	
	Check idle.	•	•	
Attachments	Check the cooling system for leakage.	•	•	
	Check the antifreeze and coolant level. (☛ P. 55)	•	•	
	Check the exhaust system for leakage and looseness.		•	
	Check Bowden cables for damage, smooth operation and routing without sharp bends.	•	•	
	Check the fluid level of the hydraulic clutch. (☛ P. 60)	•	•	
	Clean the air filter. (☛ P. 59)	•	•	
	Check cables for damage and routing without sharp bends.		•	
Brakes	Check the front brake linings. (☛ P. 40)	•	•	
	Check the rear brake linings. (☛ P. 44)	•	•	
	Check the brake discs. (☛ P. 38)	•	•	
	Check the front brake brake fluid level. (☛ P. 39)	•	•	
	Check the rear brake fluid level. (☛ P. 43)	•	•	
	Check brake lines for damage and leakage.	•	•	
	Check the free play of the hand brake lever. (☛ P. 39)	•	•	
	Check the free play of the foot brake lever. (☛ P. 43)	•	•	
	Check brake system function.	•	•	
	Check screws and guide bolts of brake system for tightness.	•	•	
Chassis	Check shock absorber and fork for leakage and functioning.	•	•	
	Clean dust boots of fork legs. (☛ P. 26)		•	
	Bleed fork legs. (☛ P. 26)		•	
	Check swingarm bearing.		•	
	Check play of steering head bearing. (☛ P. 27)	•	•	
	Check all screws to see if they are tight.	•	•	
Wheels	Check the spoke tension. (☛ P. 50)	•	•	
	Check rim run-out.	•	•	
	Check the tire condition. (☛ P. 49)	•	•	
	Checking the tire air pressure. (☛ P. 49)	•	•	
	Check the chain wear. (☛ P. 35)	•	•	
	Check the chain tension. (☛ P. 34)	•	•	
	Clean the chain. (☛ P. 34)	•	•	
	Check wheel bearing for play.	•	•	
	Clean and grease adjusting screws of chain adjuster.	•	•	

S3N: After 3 service hours - corresponds to about 21 liters of fuel

S10A: Every 10 service hours - corresponds to about 70 liters of fuel / after every race

S30A: Every 30 service hours - corresponds to about 210 liters of fuel

Important maintenance work to be carried out by an authorized KTM workshop. (as additional order)

	S10A	S20N	S40N	J1A	J2A
Carry out a complete fork service.				•	
Carry out a complete shock absorber service.					•
Grease the steering head bearing. (☛ P. 31)				•	
Clean and adjust carburetor.				•	
Treat electric contacts with contact spray.				•	
Change hydraulic clutch fluid.				•	
Change brake fluid.				•	
Check wear of clutch discs.		•			
Check long clutch springs.		•			
Check clutch slave cylinder for dents.		•			
Check outer clutch hub for dents.		•			
Check cylinder wear and change pistons.			•		
Check camshaft wear. (visual check)			•		
Check wear of valve spring seat.			•		
Check wear of valve guides.			•		
Change valves.			•		
Change valve springs.			•		
Check the timing-chain tensioner function.			•		
Check crankshaft and crankshaft journal for run-out.			•		
Change conrod bearing.			•		
Check piston pin bearing.			•		
Change the crankshaft main bearing.			•		
Check wear of all transmission components including shafts and bearings.			•		
Check the spring length of the oil pressure regulator valve.			•		
Change glass fiber yarn filling of main silencer. (☛ P. 58)	•				
Replace foot brake cylinder seals.		•			
Check carburetor components.			•		

S10A: Every 10 service hours - corresponds to about 70 liters of fuel / after every race

S20N: After 20 service hours - corresponds to about 140 liters of fuel

S40N: After 40 service hours - corresponds to about 280 liters of fuel

J1A: annually

J2A: every 2 years

Important checks and maintenance work to be carried out by the rider.

	NB1A
Check the engine oil level. (☛ P. 62)	•
Check the front brake brake fluid level. (☛ P. 39)	•
Check the rear brake fluid level. (☛ P. 43)	•
Check the front brake linings. (☛ P. 40)	•
Check the rear brake linings. (☛ P. 44)	•
Check and adjust Bowden cables.	•
Bleed fork legs. (☛ P. 26)	•
Clean dust boots of fork legs. (☛ P. 26)	•
Clean the chain. (☛ P. 34)	•
Check the chain tension. (☛ P. 34)	•
Check the chain wear. (☛ P. 35)	•
Check the rear sprocket / engine sprocket for wear. (☛ P. 35)	•
Clean the air filter. (☛ P. 59)	•
Checking the tire air pressure. (☛ P. 49)	•
Check the tire condition. (☛ P. 49)	•

	NB1A
Check the coolant level. (☛ P. 55)	•
Empty the carburetor float chamber. (☛ P. 62)	•
Check that all operating elements for smooth operation.	•
Check braking.	•
Check all screws, nuts and hose clamps regularly for tightness.	•

NB1A: Depending on conditions of use according to requirements.

Jacking up the motorcycle

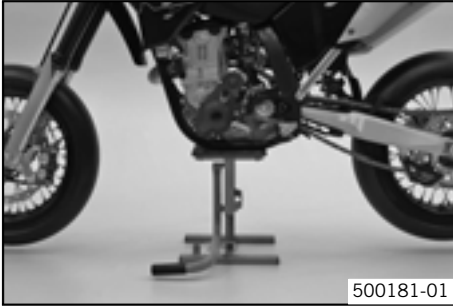

500181-01

Note

Danger of damage Danger of damage by the vehicle running away or falling over.

- Always place the vehicle on a firm and even surface.

- Jack up the motorcycle underneath the engine. The wheels must no longer touch the ground.

Work stand (59229055000)

- Secure the motorcycle against falling over.

Removing the motorcycle from the work stand

Note

Danger of damage Danger of damage by the vehicle running away or falling over.

- Always place the vehicle on a firm and even surface.

- Remove the motorcycle from the work stand.
- Remove the work stand.

Checking the basic chassis setting with the rider's weight



Info

When adjusting the basic chassis setting, first adjust the shock absorber and then the fork.

For optimal motorcycle riding characteristics and to avoid damage to forks, shock absorbers, swing arm and frame, the basic settings of the suspension components must match your body weight.

As delivered, KTM motorcycles are adjusted for a standard rider weight (with full protective clothing).

Standard rider weight	75... 85 kg (165.34... 187.39 lb.)
-----------------------	------------------------------------

If your weight is above or below the standard range, you have to adjust the basic setting of the suspension components accordingly. Small weight differences can be compensated by adjusting the spring preload, but in the case of large weight differences, the springs must be replaced.

Compression damping of shock absorber

The shock absorber can regulate compression damping in low- and high-speed range separately (Dual Compression Control).

The term low and high speed refers to the movement of the shock absorber during compression and not the riding speed of the motorcycle.

The low- and high-speed technology works non-specifically.

Adjusting high-speed compression damping of the shock absorber



Danger

Danger of accidents The shock absorber is under high pressure.

- The shock absorber is filled with highly compressed nitrogen, so never dismantle the shock absorber or carry out any maintenance on it yourself.



Info

The high-speed setting can be seen during the fast compression of the shock absorber.



500184-10

- Turn the adjusting screw ❶ clockwise with a ring wrench until it stops.



Info

Do not loosen nut ❷!

- Turn back counterclockwise the number of turns corresponding to the shock absorber type.

Specification

Compression damping, high-speed	
Standard	1.5 turns

- Info**
Turn clockwise to increase damping, turn counterclockwise to reduce suspension damping.

Adjusting the low-speed compression damping of the shock absorber

- Danger**
Danger of accidents The shock absorber is under high pressure.

- The shock absorber is filled with highly compressed nitrogen, so never dismantle the shock absorber or carry out any maintenance on it yourself.

- Info**
The low-speed setting can be seen during the slow to normal compression of the shock absorber.

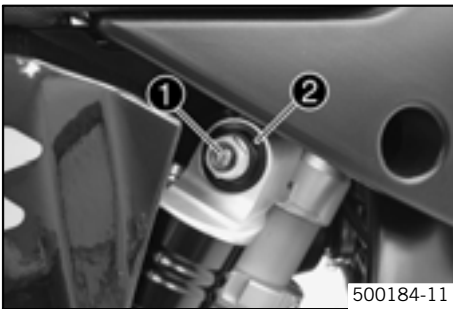

- Turn the adjusting screw ❶ clockwise with a screwdriver until it stops.

- Info**
Do not loosen nut ❷!

- Turn back counterclockwise the number of clicks corresponding to the shock absorber type.

Specification

Compression damping, low-speed	
Standard	10 clicks

- Info**
Turn clockwise to increase damping, turn counterclockwise to reduce suspension damping.

Adjusting rebound damping of the shock absorber

- Danger**
Danger of accidents The shock absorber is under high pressure.

- The shock absorber is filled with highly compressed nitrogen, so never dismantle the shock absorber or carry out any maintenance on it yourself.

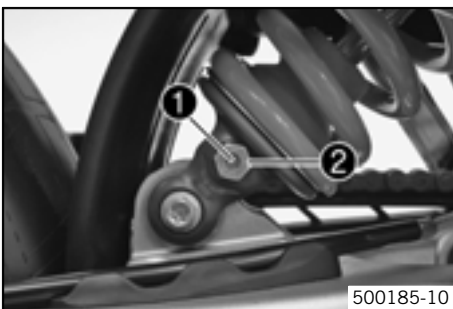

- Turn the adjusting screw ❶ clockwise until it stops.

- Info**
Do not loosen nut ❷!

- Turn back counterclockwise the number of clicks corresponding to the shock absorber type.

Specification

Rebound damping	
Standard	20 clicks

- Info**
Turn clockwise to increase damping, turn counterclockwise to reduce suspension damping.

Measuring rear wheel sag unloaded

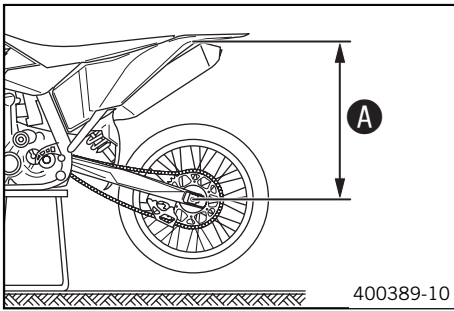

- Jack up the motorcycle. (☛ P. 21)
- Measure the distance – as vertical as possible – between the rear axle and a fixed point, for example, a mark on the side cover.
- Make a note of the value as measurement **A**.
- Remove the motorcycle from the work stand. (☛ P. 21)

Checking static sag of the shock absorber

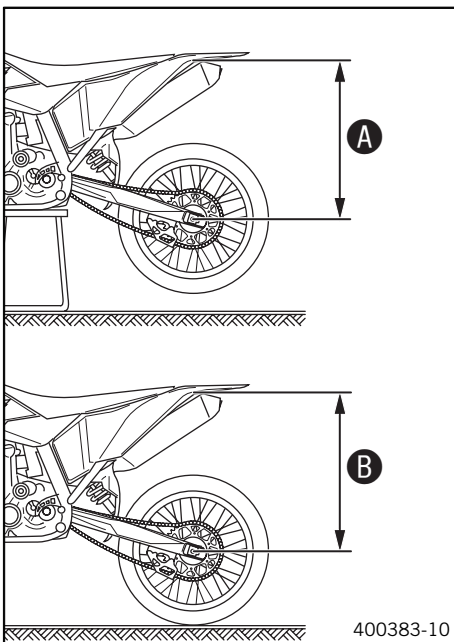

- Measure distance **A** of rear wheel unloaded. (☛ P. 23)
- Ask someone to help you by holding the motorcycle upright.
- Measure the distance between the rear axle and the fixed point again.
- Make a note of the value as measurement **B**.

i Info

The static sag is the difference between measurements **A** and **B**.

- Check the static sag.

Static sag	15... 20 mm (0.59... 0.79 in)
------------	-------------------------------

- » If the static sag is less or more than the specified value:
 - Adjust the spring preload of the shock absorber. (☛ P. 24)

Check the riding sag of the shock absorber.

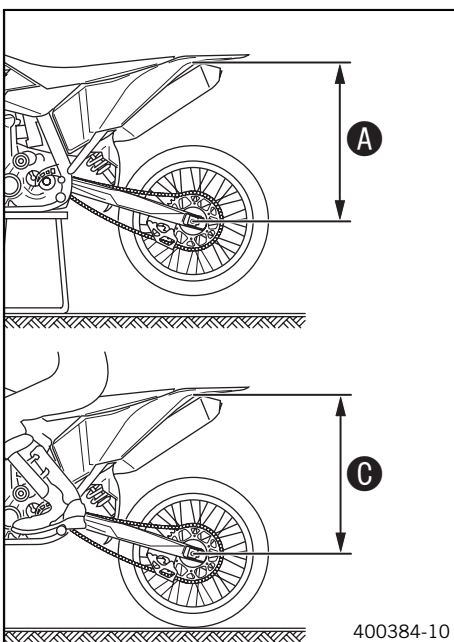

- Measure distance **A** of rear wheel unloaded. (☛ P. 23)
- With another person holding the motorcycle, sit on the saddle with full protective clothing in a normal sitting position (feet on footrests) and bounce up and down a few times until the rear suspension levels out.
- The other person now has to measure the distance between the rear axle and a fixed point.
- Make a note of the value as measurement **C**.

i Info

The riding sag is the difference between measurements **A** and **C**.

- Check the riding sag.

Riding sag	80... 90 mm (3.15... 3.54 in)
------------	-------------------------------

- » If the riding sag differs from the specified measurement:
 - Adjust the riding sag. (☛ P. 24)

Adjusting spring preload of the shock absorber



Danger

Danger of accidents The shock absorber is under high pressure.

- The shock absorber is filled with highly compressed nitrogen, so never dismantle the shock absorber or carry out any maintenance on it yourself.



Info

Before changing the spring preload, make a note of the present setting, e.g., by measuring the length of the spring.

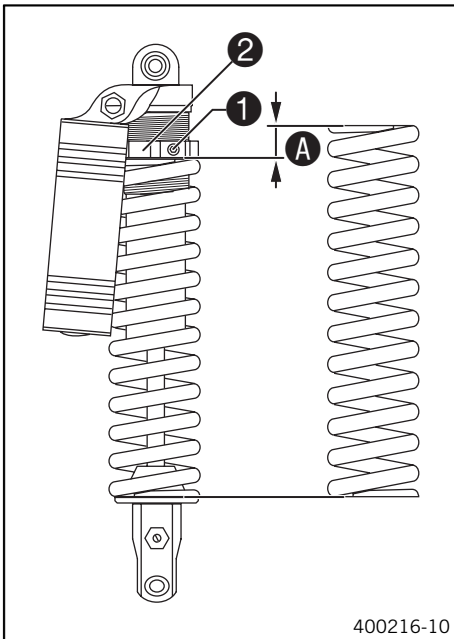

- Remove shock absorber. (☛ P. 25)
- After removing the shock absorber, clean it thoroughly.
- Loosen screw ①.
- Turn adjusting ring ② until the spring is no longer under tension.

Combination wrench (50329080000)

Hook wrench (T106S)

- Measure the overall spring length when not under tension.
- Tighten the spring by turning adjusting ring ① to measurement A.

Specification

Spring preload	11 mm (0.43 in)
----------------	-----------------

- Tighten screw ②.
- Specification

Screw, shock absorber adjusting ring	M6	5 Nm (3.69 lbf ft)
--------------------------------------	----	--------------------

- Installing shock absorber. (☛ P. 25)

Adjusting riding sag

- Remove shock absorber. (☛ P. 25)
 - After removing the shock absorber, clean it thoroughly.
 - Choose and fit a suitable spring.
- Specification

Spring rate	
Weight of rider: 65... 75 kg (143.3... 165.34 lb.)	76 N/mm (433.97 lb/in)
Weight of rider: 75... 85 kg (165.34... 187.39 lb.)	80 N/mm (456.81 lb/in)
Weight of rider: 85... 95 kg (187.39... 209.44 lb.)	84 N/mm (479.65 lb/in)





Info

The spring rate is shown on the outside of the spring.

- Installing shock absorber. (☛ P. 25)
- Check the static sag of the shock absorber. (☛ P. 23)
- Adjust the rebound damping of the shock absorber. (☛ P. 22)

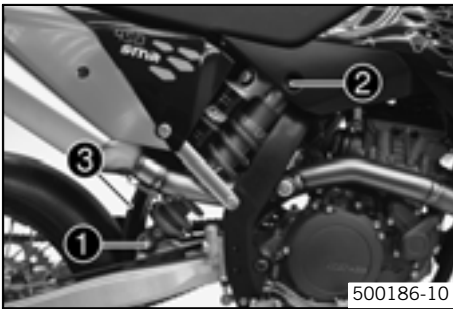
Removing the shock absorber



- Jack up the motorcycle. ( P. 21)
- Remove screw ❶ and lower the rear wheel with the swing arm as far as possible without blocking the rear wheel. Fix the rear wheel in this position.
- Remove screw ❷, push splash protector ❸ to the side, and remove the shock absorber.

Installing shock absorber

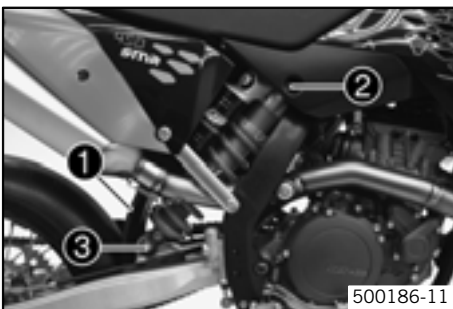

- Check parts for damage and wear. Replace damaged or worn parts.
- Push splash protector ❶ to the side and position the shock absorber. Mount and tighten screw ❷.

Specification

Screw, top shock absorber	M12	80 Nm (59.01 lbf ft)	Loctite® 243™
---------------------------	-----	-------------------------	---------------

- Mount and tighten screw ❸.

Specification

Screw, bottom shock absorber	M12	80 Nm (59.01 lbf ft)	Loctite® 243™
------------------------------	-----	-------------------------	---------------

Info

The heim joint for the shock absorber at the swing arm is Teflon coated. It must not be greased with grease or with other lubricants. Lubricants dissolve the Teflon coating, thereby drastically reducing the service life.

- Remove the motorcycle from the work stand. ( P. 21)

Checking basic setting of fork

Info

For various reasons, no exact riding sag can be determined for the forks.

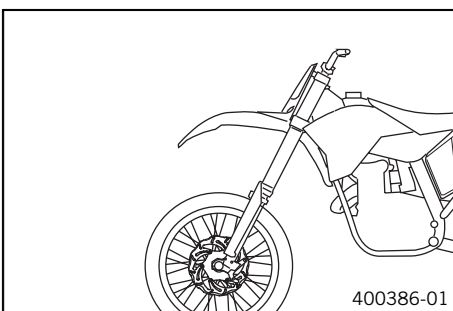

As with the shock absorber, smaller weight differences can be compensated by the spring preload. However, if your fork is often overloaded (hard end stop on compression), you must fit harder springs to avoid damage to the fork and frame.

Adjusting compression damping of fork

Info

The hydraulic compression damping determines the fork suspension behavior.

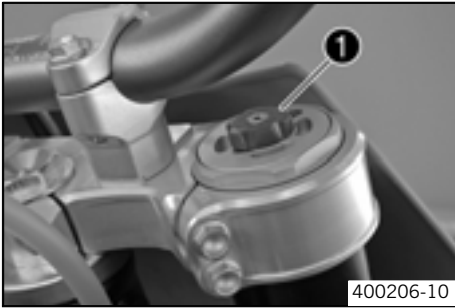

- Turn adjusting screws ❶ clockwise until they stop.



Info

The adjusting screws ❶ are located at the top end of the fork legs. Make the same adjustment on both fork legs.

- Turn back counterclockwise the number of clicks corresponding to the fork type. Specification

Compression damping	
Standard	15 clicks



Info

Turn clockwise to increase damping, turn counterclockwise to reduce suspension damping.

Adjusting rebound damping of fork



Info

The hydraulic rebound damping determines the fork suspension behavior.

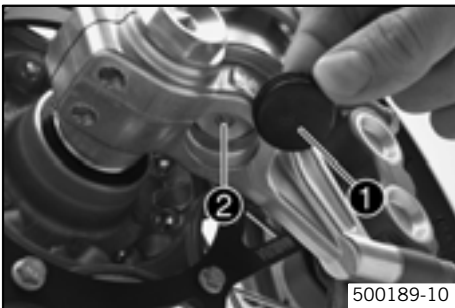

- Remove protection covers ❶.
- Turn adjusting screws ❷ clockwise until they stop.



Info

The adjusting screws ❷ are located at the bottom end of the fork legs. Make the same adjustment on both fork legs.

- Turn back counterclockwise the number of clicks corresponding to the fork type. Specification

Rebound damping	
Standard	15 clicks



Info

Turn clockwise to increase damping, turn counterclockwise to reduce suspension damping.

- Mount protection covers ❶.

Bleeding fork legs



- Jack up the motorcycle. (☛ P. 21)
- Remove bleeder screws ❶ briefly.
 - ✓ Any excess pressure escapes from the interior of the fork.
- Mount and tighten bleeder screws.
- Remove the motorcycle from the work stand. (☛ P. 21)

Cleaning dust boots of fork legs

- Jack up the motorcycle. (☛ P. 21)
- Remove the fork protector. (☛ P. 27)



- Push dust boots ❶ of both fork legs downwards.



Info

The dust boots should remove dust and coarse dirt particles from the fork tubes. Over time, dirt can penetrate behind the dust boots. If this dirt is not removed, the oil seals behind can start to leak.



Warning

Danger of accidents Reduced braking due to oil or grease on the brake discs.

- Always keep the brake discs free of oil and grease, and clean them with brake cleaner when necessary.

- Clean and oil the dust boots and inner fork tube of both fork legs.

Universal oil spray (☛ P. 84)

- Press the dust boots back into their normal position.
- Remove excess oil.
- Install the fork protector (☛ P. 27)
- Remove the motorcycle from the work stand. (☛ P. 21)

Removing the fork protector

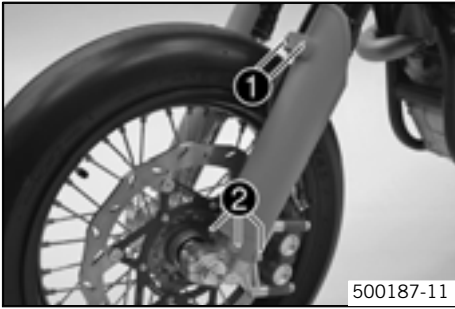

- Remove screws ❶ and take off clamp.
- Remove screws ❷ on left fork leg. Remove the fork protector.
- Remove the screws on the right fork leg. Remove the fork protector.

Installing the fork protector

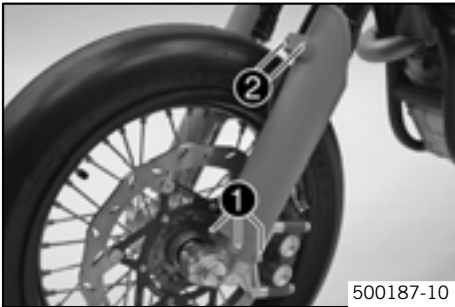

- Check parts for damage and wear. Replace damaged or worn parts.
- Position the fork protection on the left fork leg. Mount and tighten screws ❶. Specification

Remaining screws, chassis	M6	10 Nm (7.38 lbf ft)
---------------------------	----	------------------------

- Position the brake line. Put the clamp on, mount and tighten screws ❷.
- Position the fork protection on the right fork leg. Mount and tighten screws. Specification

Remaining screws, chassis	M6	10 Nm (7.38 lbf ft)
---------------------------	----	------------------------

Checking play of steering head bearing



Warning

Danger of accidents Unsafe riding behavior due to incorrect steering head bearing play.

- The steering head bearing play should be adjusted immediately in an authorized KTM workshop.



Info

If the bike is driven for a longer time with play in the steering head bearing, the bearing and the bearing seats in the frame can be damaged after time.

- Jack up the motorcycle. (☛ P. 21)

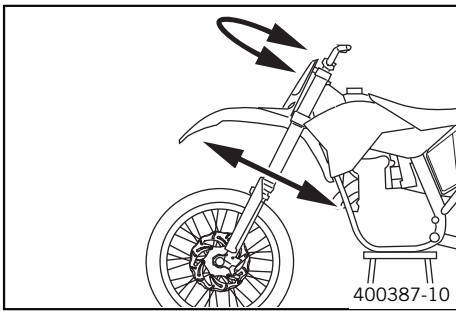

- Move the handlebar to the straight-ahead position. Move the fork legs to and fro in the direction of travel.
- | |
|--|
| No play should be noticeable in the steering head bearing. |
|--|
- » If there is noticeable play present:
 - Adjust play of the steering head bearing (☛ P. 28)
 - Move the handlebar to and fro over the entire steering range.
- | |
|--|
| The handlebar must be able to move easily over the entire steering range. No resting locations should be noticeable. |
|--|
- » If click positions are noticeable:
 - Adjust play of the steering head bearing (☛ P. 28)
 - Check the steering head bearing and replace if required.
 - Remove the motorcycle from the work stand. (☛ P. 21)

Adjusting play of steering head bearing ☛

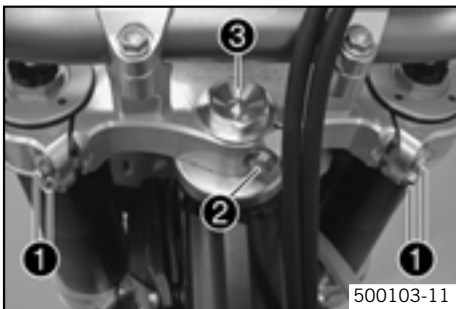

- Jack up the motorcycle. (☛ P. 21)
- Loosen screw ❶. Remove screw ❷.
- Loosen and retighten screw ❸.

Specification

Screw, top steering head	M20x1,5	10 Nm (7.38 lbf ft)
--------------------------	---------	------------------------

- Using a plastic hammer, tap lightly on the upper triple clamp to avoid strains.
- Fully tighten screw ❶.

Specification

Screw, top triple clamp	M8	17 Nm (12.54 lbf ft)
-------------------------	----	-------------------------

- Mount and tighten screw ❷.

Specification

Screw, top steering stem	M8	17 Nm (12.54 lbf ft)	Loctite® 243™
--------------------------	----	-------------------------	---------------

- Check play of steering head bearing. (☛ P. 27)

Fork offset

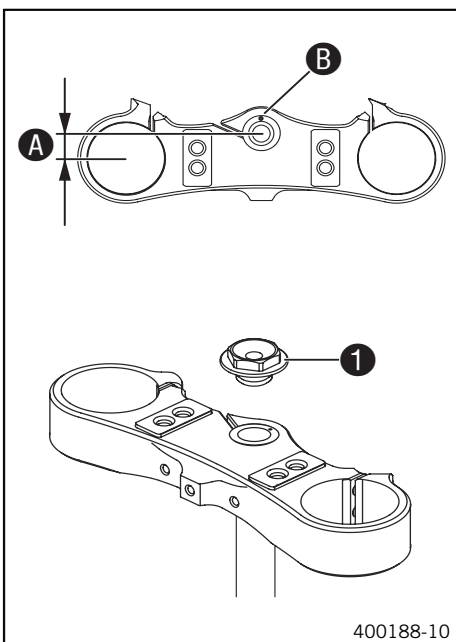

You can see the currently set offset if you remove screw ❶.
 The fork offset **A** has an impact on the handling of the vehicle. It is calculated from the center of the fork leg to the center of the steering head bearing.
 The fork offset can optionally be adjusted.
 Marking **B** to the front gives greater stability on fast racetracks.

Fork offset	
Front marking	14 mm (0.55 in)

Marking **B** to the rear gives better handling in bends.

Fork offset	
Rear marking	16 mm (0.63 in)

Setting the fork offset

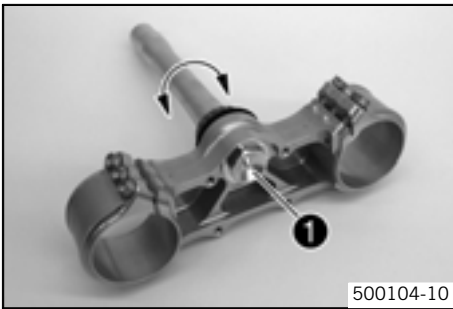

- Remove the lower triple clamp. ( P. 30)
- Remove screw **1**. Remove the steering stem.
- Clean the parts and check for damage.
- Rotate the steering stem 180° and insert into the triple clamp. Mount and tighten screw **1**.

Specification

Screw, bottom steering head	M20x1,5	60 Nm (44.26 lbf ft)	Loctite® 243™
-----------------------------	---------	-------------------------	---------------

- Install the lower triple clamp. ( P. 30)

Removing the fork legs

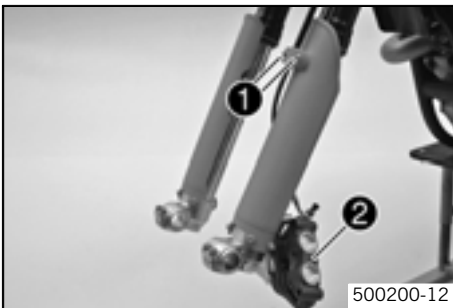

- Remove front wheel. ( P. 46)
- Remove screws **1** and take off clamp.
- Hang the brake caliper **2** and the brake line loosely to the side.

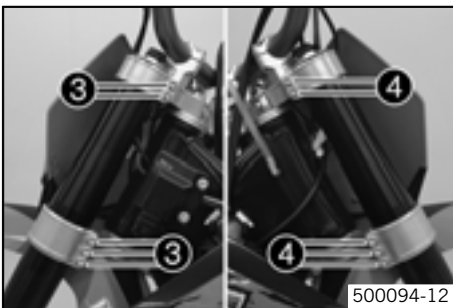

- Loosen screw **3**. Remove the fork leg on the left.
- Loosen screw **4**. Remove the fork leg on the right.

Installing the fork legs



- Check parts for damage and wear. Replace damaged or worn parts.
- Position the fork legs.



Info

The topmost sunk nut in the fork leg must be flush to the upper edge of the upper triple clamp.

Position the bleeder screw **1** to the front.

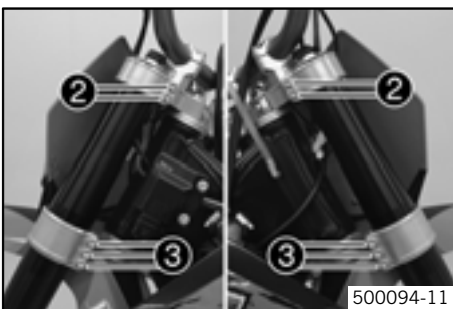

- Fully tighten screw **2**.

Specification

Screw, top triple clamp	M8	17 Nm (12.54 lbf ft)
-------------------------	----	-------------------------

- Fully tighten screw **3**.

Specification

Screw, bottom triple clamp	M8	12 Nm (8.85 lbf ft)
----------------------------	----	------------------------

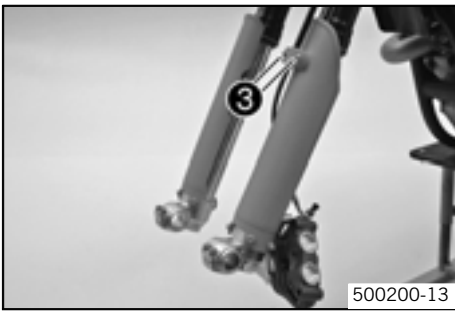

- Position the brake line. Put the clamp on, mount and tighten screws ③.
- Fit front wheel. (☛ P. 47)

Removing the lower triple clamp ☛

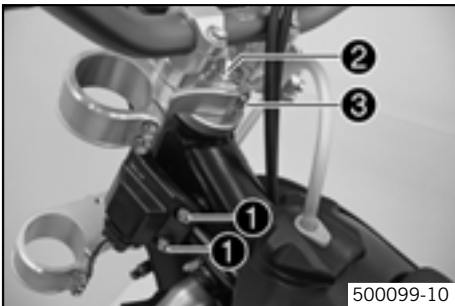

- Remove the fork legs. (☛ P. 29)
- Dismount the start number plate (☛ P. 32)
- Dismount the front fender. (☛ P. 31)
- Remove screws ① and hang the CDI control unit to the side.

i Info
Do not unplug the CDI control unit.

- Remove screw ②. Remove screw ③, take off top triple clamp with the handlebar and place it on one side.

i Info
Protect the motorcycle and its attachments from damage by covering them. Do not bend the cables and lines.

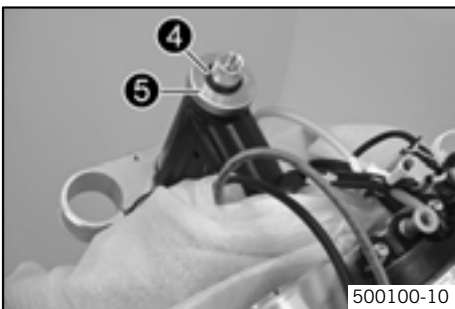

- Remove o-ring ④. Remove protector ring ⑤.
- Remove the lower triple clamp with the steering stem.
- Remove the upper steering head bearing.

Installing the lower triple clamp ☛

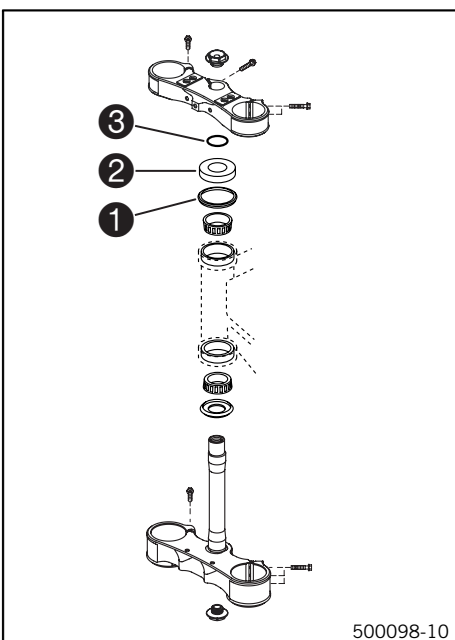

- Clean the bearing and sealing elements, check for damage, and grease. Replace damaged or worn parts.

Long-life grease (☛ P. 84)

- Insert the lower triple clamp with the steering stem. Mount the upper steering head bearing.

i Info
Check whether the top steering head seal ① is correctly positioned.

- Push up protective ring ② and o-ring ③.

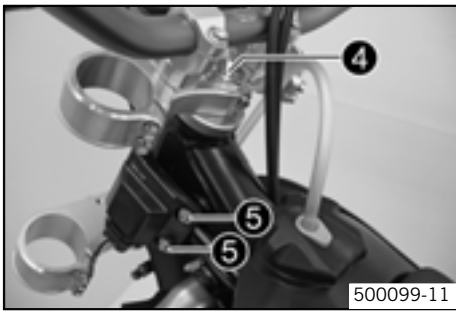

- Position the upper triple clamp with the steering.
 - Mount and tighten screw 4.
- Specification

Screw, top steering head	M20x1,5	10 Nm (7.38 lbf ft)
--------------------------	---------	------------------------

- Position the clutch line, wiring harness and CDI control unit. Mount and tighten screws 5.
- Specification

Remaining screws, chassis	M6	10 Nm (7.38 lbf ft)
---------------------------	----	------------------------

- Install front fender. (☛ P. 31)
 - Fit the start number plate. (☛ P. 32)
 - Install the fork legs. (☛ P. 29)
 - Mount and tighten screw 6.
- Specification

Screw, top steering stem	M8	17 Nm (12.54 lbf ft)	Loctite® 243™
--------------------------	----	-------------------------	---------------

- Check the cable harness, cable, brake and clutch line for free movement and free laying.
- Check play of steering head bearing. (☛ P. 27)

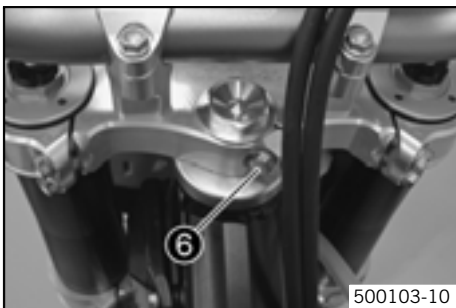

Greasing the steering head bearing ☛

- Remove the lower triple clamp. (☛ P. 30)
- Install the lower triple clamp. (☛ P. 30)

Dismounting the front fender

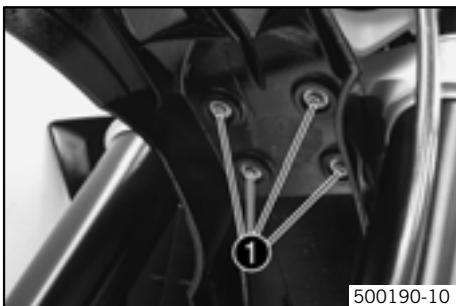

- Remove screws 1. Remove the front fender.
- Make sure that the distance bushings remain in place.

Installing the front fender

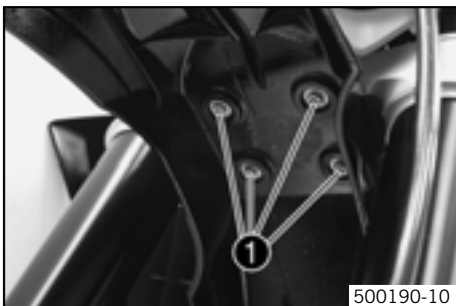

- Check parts for damage and wear. Replace damaged or worn parts.
 - Make sure that the spacing sleeves are mounted in the fender.
 - Position the front fender. Mount and tighten screws 1.
- Specification

Remaining screws, chassis	M6	10 Nm (7.38 lbf ft)
---------------------------	----	------------------------



Info

Take care with the contact of the holding lugs to the start number plate.

Dismount the start number plate

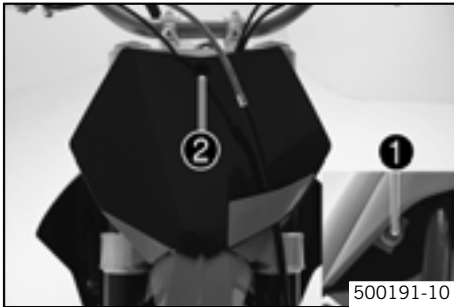

- Remove screw ❶ and take off clamp.
- Remove screw ❷. Remove the start number plate.

Fitting the start number plate

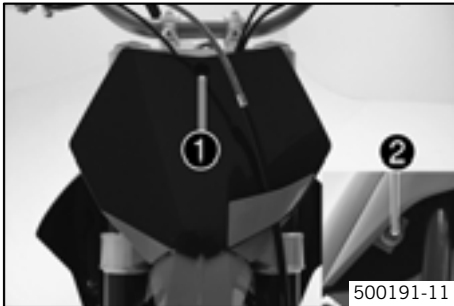

- Check parts for damage and wear. Replace damaged or worn parts.
 - Position the start number plate. Mount and tighten screw ❶.
- Specification

Remaining screws, chassis	M6	10 Nm (7.38 lbf ft)
---------------------------	----	------------------------

i Info
Take care with the contact of the holding lug at the fender.

- Position brake line. Put the clamp on, mount and tighten screw ❷.

Handlebar position

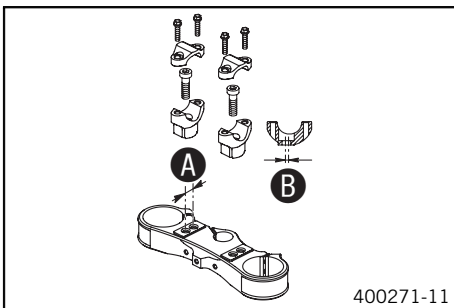

On the upper triple clamp, there are 2 holes at a distance of **A** to each other.

Drilling distance A	15 mm (0.59 in)
---------------------	-----------------

The holes on the handlebar support are placed at a distance of **B** from the center.

Drilling distance B	3.5 mm (0.14 in)
---------------------	------------------

The handlebar can be mounted in 4 different positions. This enables you to mount the handlebar in the position most suitable for the rider.

Adjusting handlebar position

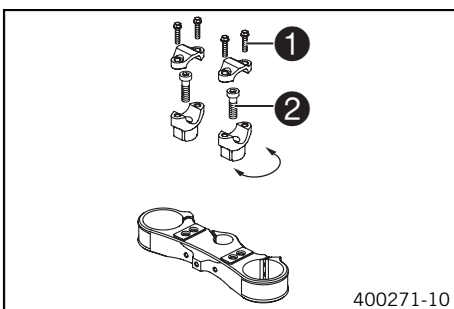

- Remove the four screws ❶. Remove the handlebar clamp. Remove the handlebar and lay it to one side.

i Info
Protect the motorcycle and its attachments from damage by covering them. Do not bend the cables and lines.

- Remove the two screws ❷. Remove the handlebar support.
- Place the handlebar support in the required position. Fit and tighten the two screws ❷.

Specification

Screw, handlebar support	M10	40 Nm (29.5 lbf ft)	Loctite® 243™
--------------------------	-----	------------------------	----------------------

i Info
Position the left and right handlebar supports evenly.

- Position the handlebar.

i Info
Make sure cables and wiring are positioned correctly.

- Position the handlebar clamp. Fit and evenly tighten the four screws ❶.

Specification

Screw, handlebar clamp	M8	20 Nm (14.75 lbf ft)
------------------------	----	-------------------------

Checking gas Bowden cable route

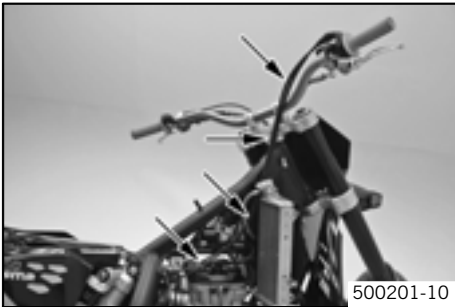

- The two gas Bowden cables must run parallel behind the handlebar down to the frame. They must be routed directly on the frame above the tank bearing to the carburetor.

Checking play in the gas Bowden cable

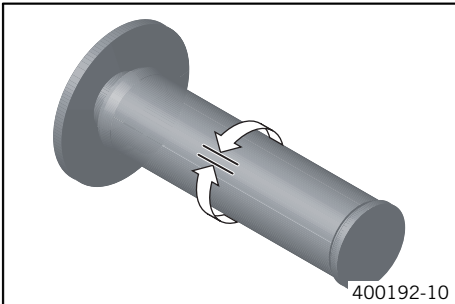

- Move the handlebar to the straight-ahead position. Move the throttle grip back and forth slightly to ascertain the play in the gas Bowden cable.

Play in gas Bowden cable	3... 5 mm (0.12... 0.2 in)
--------------------------	----------------------------

- » If the gas Bowden cable play does not meet specifications:
 - Adjust the gas Bowden cable play. (☛ P. 33)



Danger

Danger of poisoning Exhaust gases are poisonous and can result in unconsciousness and/or death.

- When running the engine, always make sure there is sufficient ventilation, and do not start or run the engine in a closed space.

- Start the engine and let it run idle. Move the handlebar to and fro over the entire steering range.

The idle speed must not change.

- » If the idle speed changes:
 - Adjust the gas Bowden cable play. (☛ P. 33)

Adjusting the gas Bowden cable play ☛

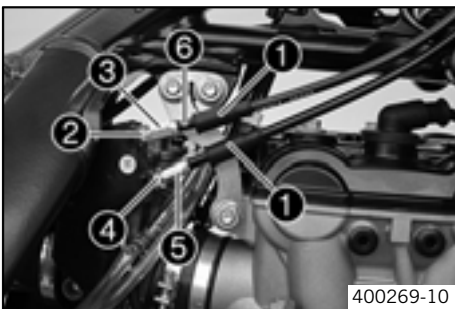

- Dismount the fuel tank. (☛ P. 53)
- Check gas Bowden cable route. (☛ P. 33)
- Move the handlebar to the straight-ahead position.
- Push back bellows ①.
- Loosen nut ②. Turn adjusting screw ③ in as far as possible.
- Loosen nut ④. Turn adjusting screw ⑤ so that there is play in the gas Bowden cable at the throttle grip.

Specification

Play in gas Bowden cable	3... 5 mm (0.12... 0.2 in)
--------------------------	----------------------------

- Tighten nut ④.
- Press and hold the throttle grip in the closed setting. Turn adjusting screw ③ out until there is no play in the Bowden cable ⑥.
- Tighten nut ②.
- Push bellows ① on. Check the throttle grip for smooth operation.
- Install the fuel tank. (☛ P. 54)
- Check play in the gas Bowden cable. (☛ P. 33)

Checking chain dirt

- Check the chain for coarse dirt accumulation.
 - » If the chain is very dirty:
 - Clean the chain. (☛ P. 34)

Cleaning the chain

Warning
Danger of accidents Oil or grease on the tires reduces their grip.

- Remove oil and grease with a suitable cleaning material.

Warning
Danger of accidents Reduced braking due to oil or grease on the brake discs.

- Always keep the brake discs free of oil and grease, and clean them with brake cleaner when necessary.

Warning
Environmental hazard Problem materials cause environmental damage.

- Dispose of oil, grease, filters, fuel, cleaning substances, brake fluid, batteries, etc. according to regulations.

Info
 The service life of the chain depends largely on its maintenance.

- Clean the chain regularly and then treat with chain spray.

Chain cleaner (☛ P. 84)

Offroad chain spray (☛ P. 84)

Checking the chain tension

Warning
Danger of accidents Danger caused by incorrect chain tension.

- If the chain tension is too high, the components of the secondary power train (chain, engine sprocket, rear sprocket, bearings in transmission and rear wheel) are under additional load. Apart from premature wear, in extreme cases the chain can rupture or the countershaft of the transmission can break. On the other hand, if the chain is loose, it can fall off the engine sprocket or the rear sprocket and block the rear wheel or damage the engine. Check for correct chain tension and adjust if necessary.

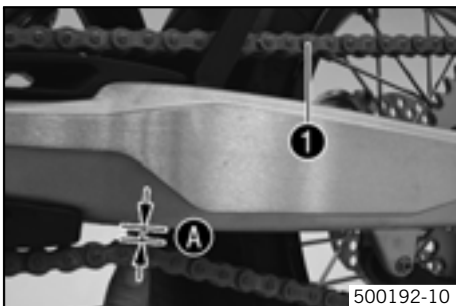

- Jack up the motorcycle. (☛ P. 21)
- Push the chain at the end of the chain sliding component upwards to measure the chain tension **A**.

Info
 The upper chain section **1** must be taut.
 Chain wear is not always even, so you should repeat this measurement at different chain positions.

Chain tension	8... 10 mm (0.31... 0.39 in)
---------------	------------------------------

- » If the chain tension does not meet specifications:
 - Adjusting chain tension - after checking. (☛ P. 37)
- Remove the motorcycle from the work stand. (☛ P. 21)

Checking the chain tension when fitting rear wheel

Warning
Danger of accidents Danger caused by incorrect chain tension.

- If the chain tension is too high, the components of the secondary power train (chain, engine sprocket, rear sprocket, bearings in transmission and rear wheel) are under additional load. Apart from premature wear, in extreme cases the chain can rupture or the countershaft of the transmission can break. On the other hand, if the chain is loose, it can fall off the engine sprocket or the rear sprocket and block the rear wheel or damage the engine. Check for correct chain tension and adjust if necessary.

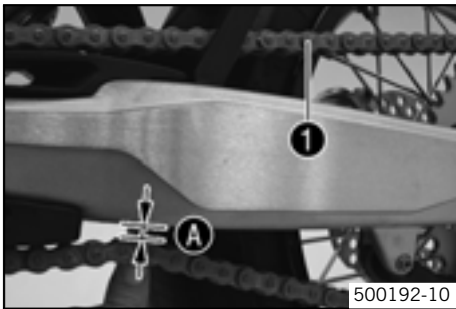

500192-10

- Make sure that the chain adjusters are fitted correctly on the adjusting screws.
- Push the chain at the end of the chain sliding component upwards to measure chain tension **A**.

Info
 The upper chain section **1** must be taut.
 Chain wear is not always even, so you should repeat this measurement at different chain positions.

Chain tension	8... 10 mm (0.31... 0.39 in)
---------------	------------------------------

- » If the chain tension does not meet specifications:
 - Adjust the chain tension when fitting rear wheel. (☛ P. 37)

Checking the rear sprocket / engine sprocket for wear

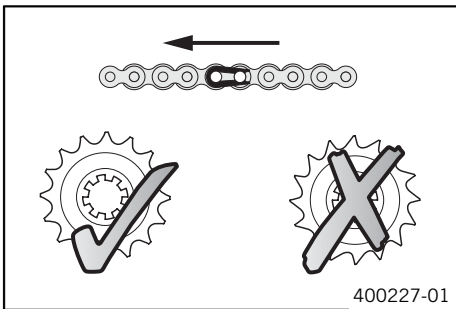

400227-01

- Check the rear sprocket / engine sprocket for wear.
 - » If the rear sprocket / engine sprocket are worn:
 - Replace rear sprocket / engine sprocket.

Info
 When fitting the chain joint, always make sure that the closed side of the joint faces forward (riding direction).
 The engine sprocket, rear sprocket and chain should always be replaced together.

- Check that the chain guide is firmly seated and not worn.

Checking chain wear

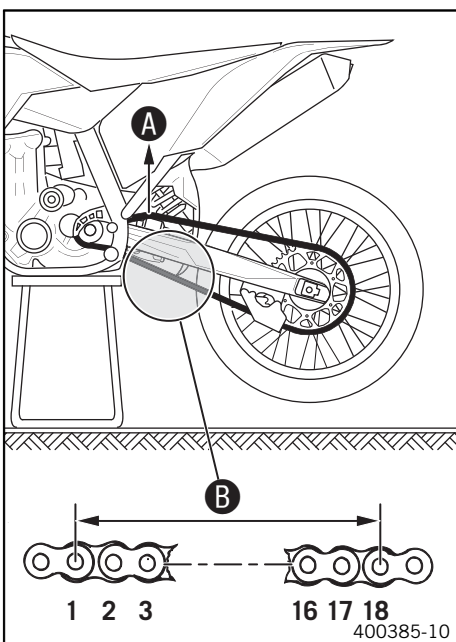

400385-10

- Jack up the motorcycle. (☛ P. 21)
- Shift to neutral and pull the upper chain length with the specified tension **A**.
 Specification

Chain tension	10... 15 kg (22.05... 33.07 lb.)
---------------	----------------------------------

- Measure distance **B** of 18 chain links in the lower chain section.

Info
 Chain wear is not always even, so you should repeat this measurement at different chain positions.

Maximum distance B at the longest chain section	272 mm (10.71 in)
--	-------------------

- » If distance **B** is greater than the specified measurement:
 - Replace the chain.

Info
 When you replace the chain, you should also replace the rear and engine sprockets.
 New chains wear out faster on old, worn sprockets.

- Remove the motorcycle from the work stand. (☛ P. 21)

Adjusting the chain tension

- Warning**
Danger of accidents Danger caused by incorrect chain tension.
- If the chain tension is too high, the components of the secondary power train (chain, engine sprocket, rear sprocket, bearings in transmission and rear wheel) are under additional load. Apart from premature wear, in extreme cases the chain can rupture or the countershaft of the transmission can break. On the other hand, if the chain is loose, it can fall off the engine sprocket or the rear sprocket and block the rear wheel or damage the engine. Check for correct chain tension and adjust if necessary.

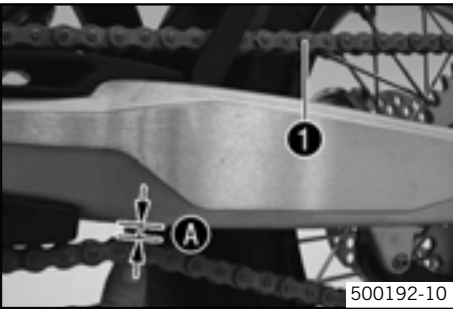

500192-10

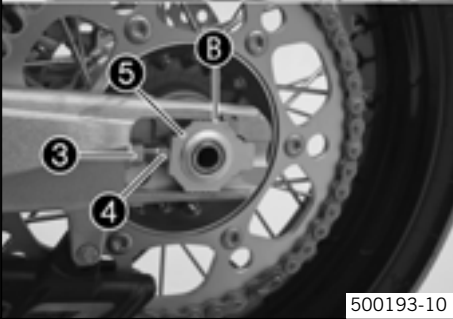
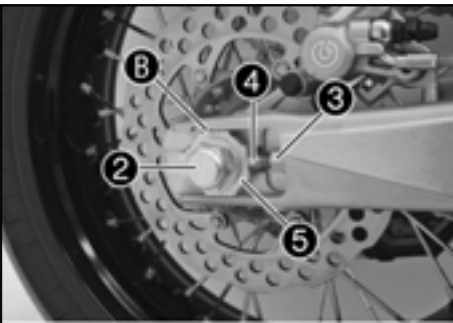

500193-10

- Jack up the motorcycle. (🔧 P. 21)
- Push the chain at the end of the chain sliding component upwards to measure chain tension **A**.

i Info
 The upper chain section **1** must be taut.
 Chain wear is not always even, so you should repeat this measurement at different chain positions.

- Loosen nut **2**.
- Loosen nuts **3**.
- Adjust the chain tension by turning the left and right adjusting screws **4**.
 Specification

Chain tension	8... 10 mm (0.31... 0.39 in)
Turn the left and right adjusting screws 4 so that the markings on the left and right chain adjusters are in the same position relative to the reference marks B . The rear wheel is then correctly aligned.	

- Tighten nuts **3**.
- Make sure that chain adjusters **5** are fitted correctly on the adjusting screws **4**.
- Tighten nut **2**.
 Specification

Nut, rear wheel spindle	M20x1,5	80 Nm (59.01 lbf ft)
-------------------------	---------	-------------------------

i Info
 The wide adjustment range of the chain adjusters (32 mm) enables different secondary transmissions with the same chain length.
 Chain adjusters **5** can be turned by 180°.

- Remove the motorcycle from the work stand. (🔧 P. 21)

Adjusting chain tension - after checking

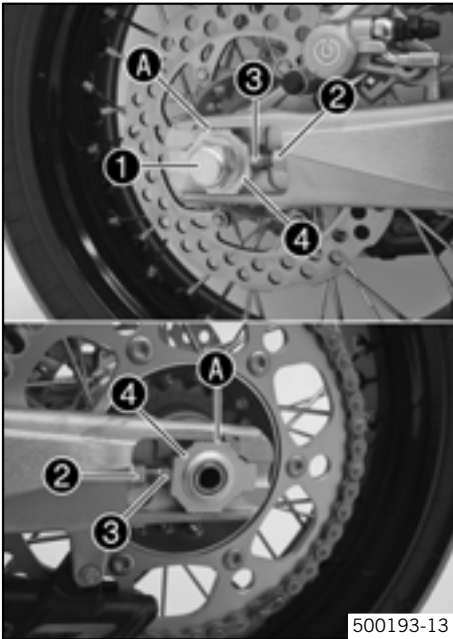

- Loosen nut ①.
- Loosen nuts ②.
- Adjust the chain tension by turning the adjusting screws ③ left and right.

Specification

Chain tension	8... 10 mm (0.31... 0.39 in)	
Turn the adjusting screws ③ left and right so that the markings on the left and right chain adjusters are in the same position relative to the reference marks ④. The rear wheel is then correctly aligned.		

- Tighten nuts ②.
- Make sure that the chain adjusters ④ are fitted correctly on the adjusting screws ③.
- Tighten nut ①.

Specification

Nut, rear wheel spindle	M20x1,5	80 Nm (59.01 lbf ft)
-------------------------	---------	-------------------------

i Info
The wide adjustment range of the chain adjusters (32 mm) enables different secondary transmissions with the same chain length. The chain adjusters ④ can be turned by 180°.

Adjusting chain tension - fitting rear wheel

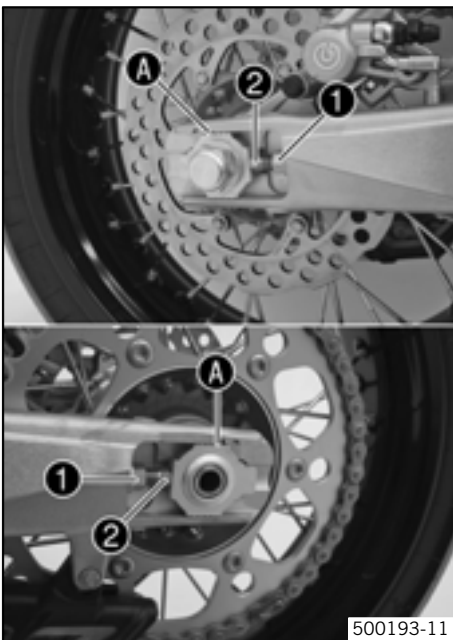

- Loosen nuts ①.
- Adjust the chain tension by turning the adjusting screws ② left and right.

Specification

Chain tension	8... 10 mm (0.31... 0.39 in)	
Turn the adjusting screws ② left and right so that the markings on the left and right chain adjusters are in the same position relative to the reference marks ④. The rear wheel is then correctly aligned.		

- Tighten nuts ①.

Adjusting chain guide

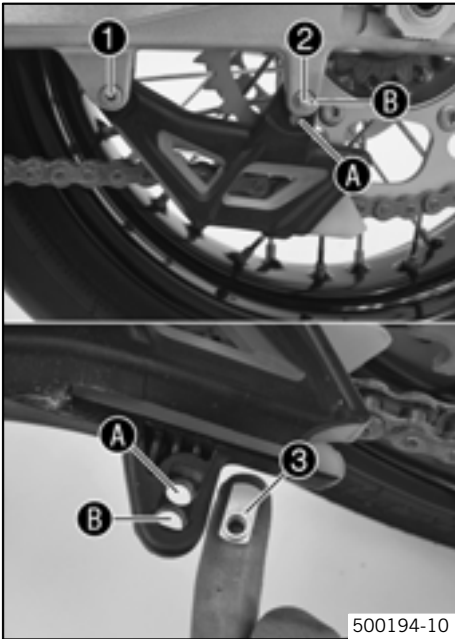

- Remove screws ❶ and ❷. Take off the chain guide.

Conditions

Number of teeth: ≤ 44 teeth

- Insert nut ❸ in hole ❶. Position the chain guide.
- Mount and tighten screws ❶ and ❷.

Specification

Remaining screws, chassis	M6	10 Nm (7.38 lbf ft)
---------------------------	----	------------------------

Conditions

Number of teeth: ≥ 45 teeth

- Insert nut ❸ in hole ❷. Position the chain guide.
- Mount and tighten screws ❶ and ❷.

Specification

Remaining screws, chassis	M6	10 Nm (7.38 lbf ft)
---------------------------	----	------------------------

Brake fluid reservoir



Warning

Danger of accidents Brake system failure.

- If the brake fluid level falls below the **MIN** mark, this indicates a leakage in the brake system or worn-out brake linings. Have the brake system checked in an authorized KTM workshop, and do not ride any further.

The brake fluid reservoirs of the front and rear brakes are dimensioned so that they do not need topping up with brake fluid even if the brake linings are worn.

Brake calipers

The brake calipers of this series are "floating", which means that they are not fixed to the brake caliper support. The lateral compensation ensures an optimal position of the brake pad in relation to the brake disc.

Checking brake discs



Warning

Danger of accidents Reduced braking due to worn brake discs.

- Worn brake discs should be replaced immediately by an authorized KTM workshop.

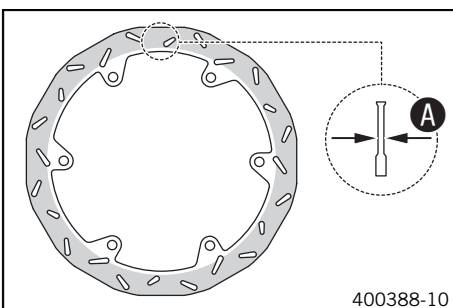

- Check the thickness of the front and rear brake discs at several places on the disc to see if it conforms to measurement ❶.



Info

Wear reduces the thickness of the brake disc around the area used by the brake linings.

Wear limit of brake discs	
front	4.5 mm (0.18 in)
Rear	3.5 mm (0.14 in)

- » The brake disc thickness is less than the specified value.
 - Replace the brake disc.

Checking free play of hand brake lever

- Warning**
Danger of accidents Brake system failure.
- If there is no free travel on the hand brake lever, pressure builds up on the front brake in the brake system. The front brake can fail due to overheating. Adjust free travel on hand brake lever according to specifications.

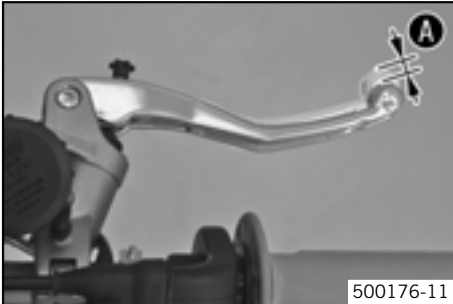

- Push the hand brake lever forwards and check free play. **A**.

Free play of hand brake lever	$\geq 3 \text{ mm } (\geq 0.12 \text{ in})$
-------------------------------	---

- » If the free travel does not meet specifications:
 - adjust the basic position of handbrake lever. (☛ P. 39)

Adjusting basic position of handbrake lever

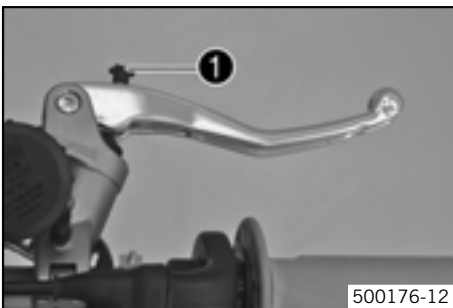

- Adjust the basic setting of the handbrake lever to your hand size by turning adjusting screw **1**.

i Info
 If you turn the adjusting screw clockwise (as seen in the direction of travel), the handbrake lever moves nearer to the handlebar.
 If you turn the adjusting screw counterclockwise (as seen in the direction of travel), the handbrake lever moves away from the handlebar.
 The range of adjustment is limited.
 Turn the adjusting screw by hand only, and do not apply any force.
 Do not make any adjustments while riding!

- Check the free play of the hand brake lever. (☛ P. 39)

Checking front brake fluid level

- Warning**
Danger of accidents Brake system failure.
- If the brake fluid level falls below the **MIN** mark, this indicates a leakage in the brake system or worn-out brake linings. Have the brake system checked in an authorized KTM workshop, and do not ride any further.

- Warning**
Danger of accidents Reduced braking due to old brake fluid.
- Have the front and rear brake fluid replaced according to the service plan in an authorized KTM workshop.



- Move the brake fluid reservoir mounted on the handlebar to a horizontal position.
- Check the brake fluid level in the brake fluid reservoir **1**.
 - » If the brake fluid is below the **MIN** mark:
 - Top up the brake fluid of the front brake. (☛ P. 40)

Topping up the front brake fluid

- Warning**
Danger of accidents Brake system failure.
- If the brake fluid level falls below the **MIN** mark, this indicates a leakage in the brake system or worn-out brake linings. Have the brake system checked in an authorized KTM workshop, and do not ride any further.

- Warning**
Skin irritations Brake fluid can cause skin irritation on contact.
- Avoid contact with skin and eyes, and keep out of the reach of children.
 - If brake fluid gets into your eyes, rinse thoroughly with water and contact a doctor immediately.

- Warning**
Danger of accidents Reduced braking due to old brake fluid.
- Have the front and rear brake fluid replaced according to the service plan in an authorized KTM workshop.

- Warning**
Environmental hazard Problem materials cause environmental damage.
- Dispose of oil, grease, filters, fuel, cleaning substances, brake fluid, batteries, etc. according to regulations.

- Info**
 KTM recommends DOT 5.1 brake fluid from **Motorex**[®]. This has a higher wet boiling point than DOT 4 brake fluid and provides greater safety for high demands.
 Never use DOT 5 brake fluid! This is based on silicone oil and is colored purple. Oil seals and brake lines are not designed for DOT 5 brake fluid.
 Avoid contact between brake fluid and painted parts. Brake fluid attacks paint!
 Use only clean brake fluid from a sealed container!

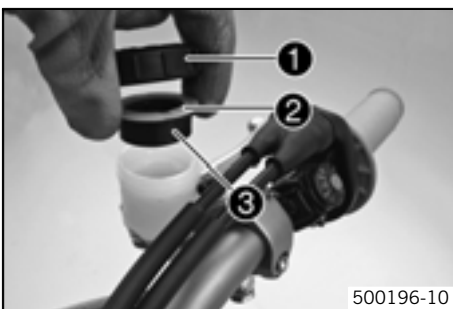

- Move the brake fluid reservoir mounted on the handlebar to a horizontal position.
- Remove screw cap ①.
- Remove the plastic ring ② with membrane ③.
- Top up the brake fluid to level **MAX**.

Brake fluid DOT 5.1 (☛ P. 82)

- Check parts for damage and wear. Replace damaged or worn parts.
- Fit the membrane and the plastic ring. Mount and tighten the screw cap.

- Info**
 Clean up overflowed or spilt brake fluid immediately with water.

Checking the front brake linings

- Warning**
Danger of accidents Reduced braking due to worn brake linings.
- Worn brake linings should be replaced immediately in an authorized KTM workshop.



- Check the brake linings for minimum thickness **A**.
 - » Minimum thickness **A**: $\geq 1 \text{ mm}$ ($\geq 0.04 \text{ in}$)
 If the minimum thickness is less than specified:
 - Change the front brake linings. (☛ P. 42)

Removing front brake linings



Warning

Danger of accidents Improper brake maintenance and repair.

- Always have your brake system maintained and repaired in an authorized KTM workshop.



- Remove locking split pins ❶.

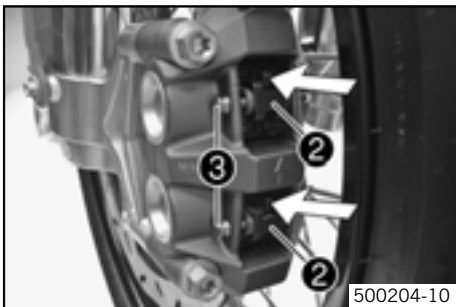

- Press the spring hanger of the spring ❷ forwards and withdraw the bolt ❸.
- Take off the springs ❷. Remove the brake linings.

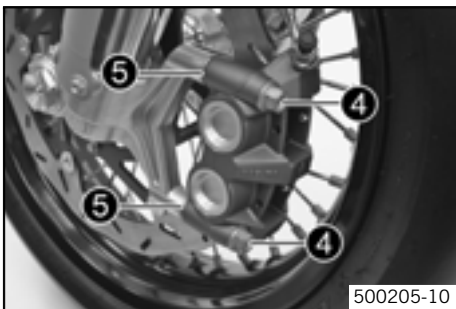

- Remove screws ❹ with washers ❺ and take off the brake caliper.
- Clean the brake caliper.

Mounting front brake linings



Warning

Danger of accidents Reduced braking due to oil or grease on the brake discs.

- Always keep the brake discs free of oil and grease, and clean them with brake cleaner when necessary.



Warning

Danger of accidents Reduced braking due to use of non-approved brake linings.

- Brake linings available from accessory suppliers are often not tested and approved for use on KTM vehicles. The construction and friction factor of the brake linings and therefore the brake power can differ considerably from the original KTM brake linings. If brake linings are used that differ from the originals, there is no guarantee that they comply with the original license. The vehicle no longer corresponds to the condition at delivery, and the warranty is no longer valid.

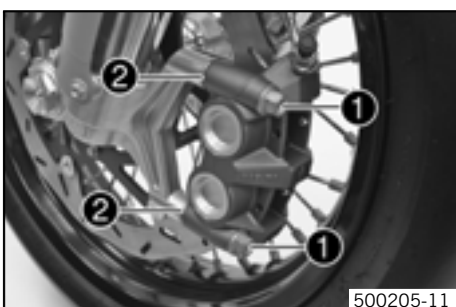

- Check the brake discs. (🔧 P. 38)
 - Check parts for damage and wear. Replace damaged or worn parts.
 - Position the brake caliper. Fit and tighten screws ❶ with washers ❷.
- Specification

Screw, front brake caliper	M10x1,25	40 Nm (29.5 lbf ft)	Loctite® 243™
----------------------------	----------	------------------------	---------------

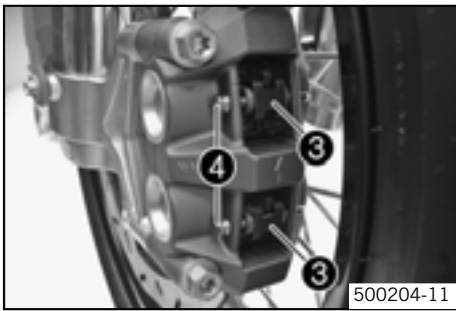

- Fit the brake linings. Position the springs ③ and mount the bolts ④.



Info

The spring hanger of the springs ③ must be positioned upwards.



- Fit the locking splint pins ⑤.
- Operate the hand brake lever repeatedly until the brake linings lie on the brake disc and there is a tight spot.

Changing the front brake linings 🛠️



Warning

Skin irritations Brake fluid can cause skin irritation on contact.

- Avoid contact with skin and eyes, and keep out of the reach of children.
- If brake fluid gets into your eyes, rinse thoroughly with water and contact a doctor immediately.



Warning

Danger of accidents Reduced braking due to old brake fluid.

- Have the front and rear brake fluid replaced according to the service plan in an authorized KTM workshop.



Warning

Environmental hazard Problem materials cause environmental damage.

- Dispose of oil, grease, filters, fuel, cleaning substances, brake fluid, batteries, etc. according to regulations.



Info

KTM recommends DOT 5.1 brake fluid from **Motorex®**. This has a higher wet boiling point than DOT 4 brake fluid and provides greater safety for high demands.

Never use DOT 5 brake fluid! This is based on silicone oil and is colored purple. Oil seals and brake lines are not designed for DOT 5 brake fluid.

Avoid contact between brake fluid and painted parts. Brake fluid attacks paint!

Use only clean brake fluid from a sealed container!

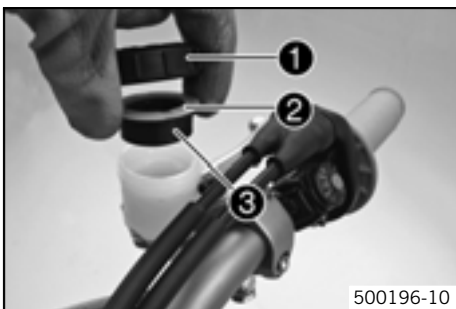

- Remove the front brake linings. (👉 P. 41)
- Move the brake fluid reservoir mounted on the handlebar to a horizontal position.
- Remove screw cap ①.
- Remove the plastic ring ② with membrane ③.
- Press the brake piston back to its basic position and make sure that no brake fluid overflows from the reservoir.
- Mount the front brake linings. (👉 P. 41)
- Top up the brake fluid to level **MAX**.

Brake fluid DOT 5.1 (👉 P. 82)

- Check parts for damage and wear. Replace damaged or worn parts.
- Fit the membrane and the plastic ring. Mount and tighten the screw cap.



Info

Clean up overflowed or spilt brake fluid immediately with water.

Checking free play of foot brake lever

Warning
Danger of accidents Brake system failure.

- If there is no free travel on the foot brake pedal, pressure builds up on the rear brake in the brake system. The rear brake can fail due to overheating. Adjust free travel on foot brake pedal according to specifications.



- Disconnect spring ❶.
- Move the foot brake lever backwards and forwards between the end stop and the foot brake cylinder piston bracket and check free play ❸.

Specification

Free play at foot brake lever	3... 5 mm (0.12... 0.2 in)
-------------------------------	----------------------------

- » If the free travel does not meet specifications:
 - Adjust the basic position of the footbrake lever. (P. 43)

- Reconnect spring ❶.

Adjusting basic position of footbrake lever

Warning
Danger of accidents Brake system failure.

- If there is no free travel on the foot brake pedal, pressure builds up on the rear brake in the brake system. The rear brake can fail due to overheating. Adjust free travel on foot brake pedal according to specifications.

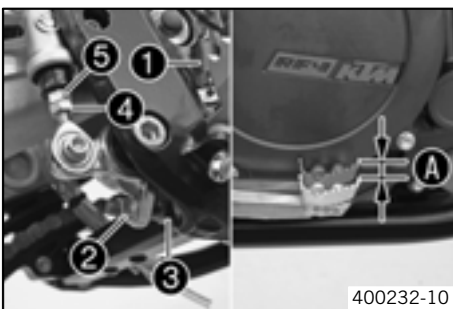

- Disconnect spring ❶.
- Loosen nut ❷ and with push rod ❺, turn it back until you have maximum free play.
- To adjust the basic position of the footbrake lever individually, loosen nut ❷ and turn screw ❸ accordingly.

Info
 The range of adjustment is limited.

- Turn push rod ❺ accordingly until you have free play ❸. If necessary, adjust the basic position of the footbrake lever.

Specification

Free play at foot brake lever	3... 5 mm (0.12... 0.2 in)
-------------------------------	----------------------------

- Hold screw ❸ and tighten nut ❷.

Specification

Remaining nuts, chassis	M8	30 Nm (22.13 lbf ft)
-------------------------	----	-------------------------

- Hold push rod ❺ and tighten nut ❷.

Specification

Remaining nuts, chassis	M6	15 Nm (11.06 lbf ft)
-------------------------	----	-------------------------

- Reconnect spring ❶.

Checking the rear brake fluid level

Warning
Danger of accidents Brake system failure.

- If the brake fluid level falls below the **MIN** mark, this indicates a leakage in the brake system or worn-out brake linings. Have the brake system checked in an authorized KTM workshop, and do not ride any further.

Warning
Danger of accidents Reduced braking due to old brake fluid.

- Have the front and rear brake fluid replaced according to the service plan in an authorized KTM workshop.

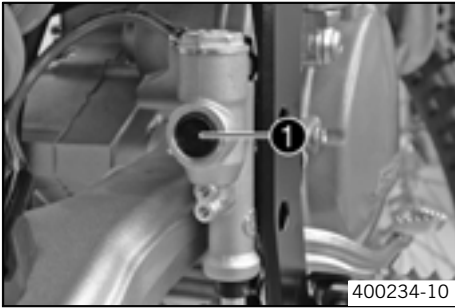

- Stand the vehicle upright.
- Check the brake fluid level in the viewer ❶.
 - » When in the viewer ❶ an air bubble is visible:
 - Add rear brake fluid. (☞ P. 44)

Adding rear brake fluid 🛠️

Warning
Danger of accidents Brake system failure.

- If the brake fluid level falls below the **MIN** mark, this indicates a leakage in the brake system or worn-out brake linings. Have the brake system checked in an authorized KTM workshop, and do not ride any further.

Warning
Skin irritations Brake fluid can cause skin irritation on contact.

- Avoid contact with skin and eyes, and keep out of the reach of children.
- If brake fluid gets into your eyes, rinse thoroughly with water and contact a doctor immediately.

Warning
Danger of accidents Reduced braking due to old brake fluid.

- Have the front and rear brake fluid replaced according to the service plan in an authorized KTM workshop.

Warning
Environmental hazard Problem materials cause environmental damage.

- Dispose of oil, grease, filters, fuel, cleaning substances, brake fluid, batteries, etc. according to regulations.

Info
 KTM recommends brake fluid DOT 5.1 from **Motorex®**. This brake fluid has a higher wet boiling point than brake fluid DOT 4 and offers more protection under high load.
 Never use DOT 5 brake fluid! This is based on silicone oil and is colored purple. Oil seals and brake lines are not designed for DOT 5 brake fluid.
 Avoid contact between brake fluid and painted parts. Brake fluid attacks paint!
 Use only clean brake fluid from a sealed container!

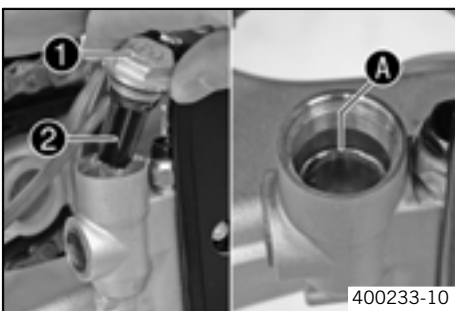

- Stand the vehicle upright.
 - Remove screw cap ❶ with membrane ❷ and the O-ring.
 - Add brake fluid to level A.
- Brake fluid DOT 5.1 (☞ P. 82)
- Check parts for damage and wear. Replace damaged or worn parts.
 - Mount the screw cap with the membrane and the O-ring.

Info
 Clean up overflowed or spilled brake fluid immediately with water.

Checking rear brake linings

Warning
Danger of accidents Reduced braking due to worn brake linings.

- Worn brake linings should be replaced immediately in an authorized KTM workshop.

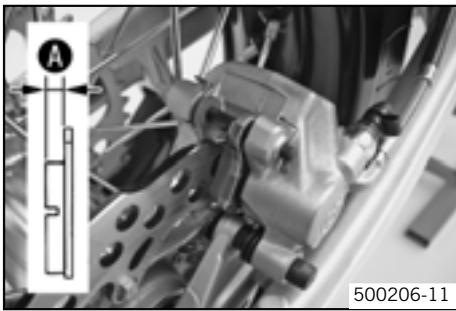

500206-11

- Check the brake linings for minimum thickness **A**.
 - » Minimum thickness **A**: $\geq 1 \text{ mm}$ ($\geq 0.04 \text{ in}$)
 - If the minimum thickness is less than specified:
 - Change the rear brake linings. (☛ P. 46)

Removing rear brake linings ☞



Warning

Danger of accidents Improper brake maintenance and repair.

- Always have your brake system maintained and repaired in an authorized KTM workshop.

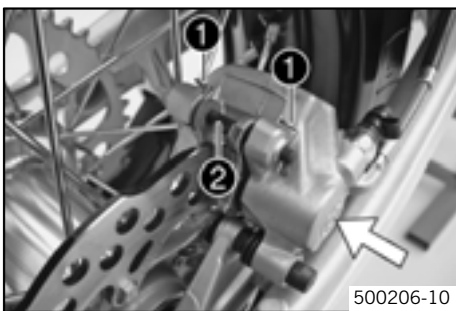

500206-10

- Press the brake caliper by hand on to the brake disc in order to press back the brake piston.



Info

Make sure when pushing back the brake piston that you do not press the brake caliper against the spokes.

- Remove the locking split pins **1**, withdraw the bolt **2**, and take out the brake pads.
- Clean brake caliper and brake caliper support.

Installing the rear brake linings ☞



Warning

Danger of accidents Reduced braking due to oil or grease on the brake discs.

- Always keep the brake discs free of oil and grease, and clean them with brake cleaner when necessary.



Warning

Danger of accidents Reduced braking due to use of non-approved brake linings.

- Brake linings available from accessory suppliers are often not tested and approved for use on KTM vehicles. The construction and friction factor of the brake linings and therefore the brake power can differ considerably from the original KTM brake linings. If brake linings are used that differ from the originals, there is no guarantee that they comply with the original license. The vehicle no longer corresponds to the condition at delivery, and the warranty is no longer valid.

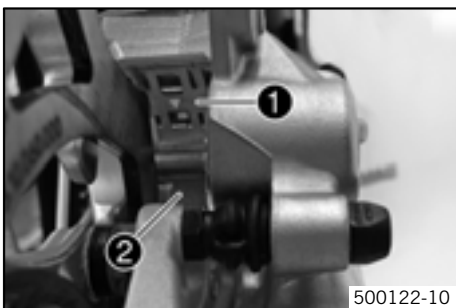

500122-10

- Check the brake discs. (☛ P. 38)
- Check parts for damage and wear. Replace damaged or worn parts.
- Check that leaf spring **1** in the brake caliper and sliding plate **2** in the brake caliper support are seated correctly.



Info

The arrow on the leaf spring points in the rotation direction of the brake disc.

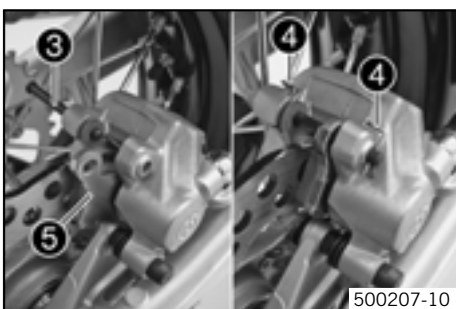

500207-10

- Fit the brake linings, insert bolt **3**, and mount locking split pins **4**.



Info

Make sure that the decoupling plate **5** is mounted on the piston side of the brake pad.

- Operate the foot brake lever repeatedly until the brake linings lie on the brake disc and there is a tight spot.

Changing the rear brake linings

Warning
Skin irritations Brake fluid can cause skin irritation on contact.

- Avoid contact with skin and eyes, and keep out of the reach of children.
- If brake fluid gets into your eyes, rinse thoroughly with water and contact a doctor immediately.

Warning
Danger of accidents Reduced braking due to old brake fluid.

- Have the front and rear brake fluid replaced according to the service plan in an authorized KTM workshop.



Warning
Environmental hazard Problem materials cause environmental damage.

- Dispose of oil, grease, filters, fuel, cleaning substances, brake fluid, batteries, etc. according to regulations.

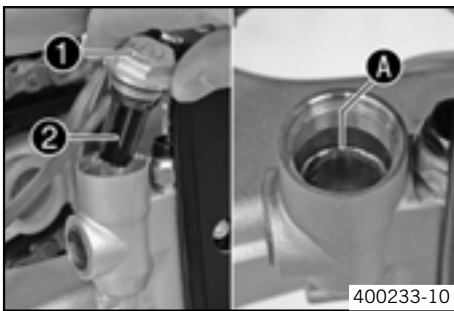
i Info
 KTM recommends brake fluid DOT 5.1 from **Motorex®**. This brake fluid has a higher wet boiling point than brake fluid DOT 4 and offers more protection under high load.
 Never use DOT 5 brake fluid! This is based on silicone oil and is colored purple. Oil seals and brake lines are not designed for DOT 5 brake fluid.
 Avoid contact between brake fluid and painted parts. Brake fluid attacks paint!
 Use only clean brake fluid from a sealed container!



400233-10

- Remove the rear brake linings. ( P. 45)
- Stand the vehicle upright.
- Remove screw cap 1 with membrane 2 and the O-ring.
- Press the brake piston back to its basic position and make sure that no brake fluid overflows from the brake fluid reservoir.
- Install the rear brake linings. ( P. 45)
- Add brake fluid to level A.

Brake fluid DOT 5.1 ( P. 82)

- Check parts for damage and wear. Replace damaged or worn parts.
- Mount the screw cap with the membrane and the O-ring.

i Info
 Clean up overflowed or spilt brake fluid immediately with water.

Removing front wheel



500209-10

- Jack up the motorcycle. ( P. 21)
- Remove screw 1.
- Loosen screw 2.



500208-10

- Remove screws 3 with washers 4 and take off the brake caliper.

i Info
 Do not pull the handbrake lever when the brake caliper is removed.

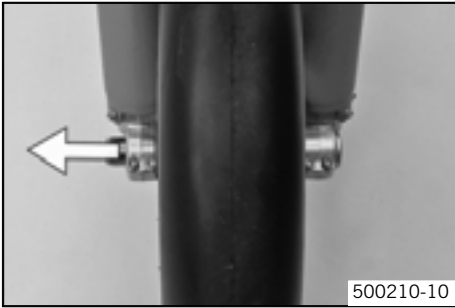

500210-10

- Holding the front wheel, withdraw the wheel spindle. Take the front wheel out of the fork.

i Info

Always lay the wheel down in such a way that the brake disc is not damaged.

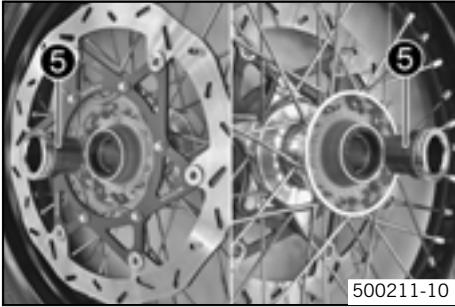

500211-10

- Remove the spacing sleeves 5.

Fitting front wheel ↩



Warning

Danger of accidents Reduced braking due to oil or grease on the brake discs.

- Always keep the brake discs free of oil and grease, and clean them with brake cleaner when necessary.

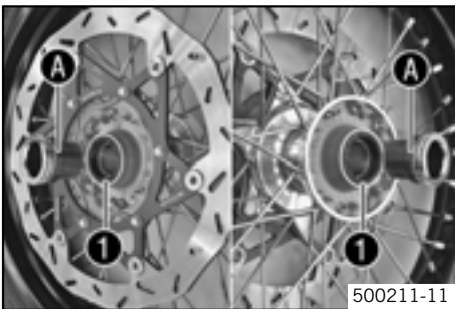

500211-11

- Check parts for damage and wear. Replace damaged or worn parts.
- Clean and grease shaft seal rings 1 and bearing surface A of the spacing sleeves.

Long-life grease (☛ P. 84)

- Fit the spacing sleeves.

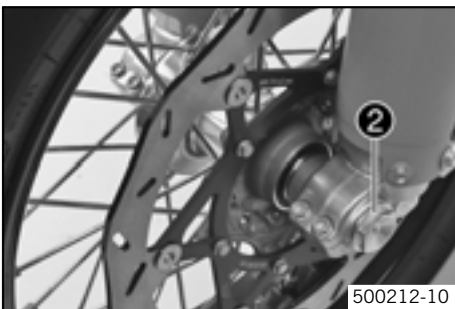

500212-10

- Lift the front wheel into the fork, position it, and insert the wheel spindle.

- Mount and tighten screw 2.

Specification

Screw, front wheel spindle	M24x1,5	40 Nm (29.5 lbf ft)
----------------------------	---------	------------------------

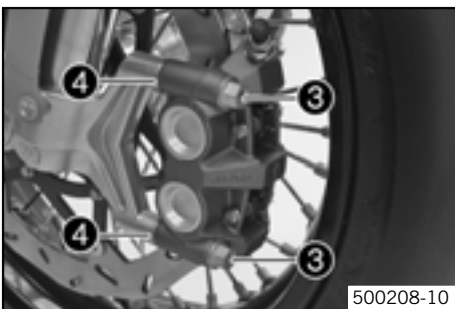

500208-10

- Position the brake caliper. Fit and tighten screws 3 with washers 4.

Specification

Screw, front brake caliper	M10x1,25	40 Nm (29.5 lbf ft)	Loctite® 243™
----------------------------	----------	------------------------	---------------

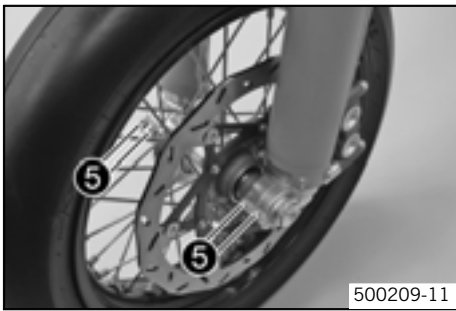

500209-11

- Operate the hand brake lever repeatedly until the brake linings lie on the brake disc and there is a tight spot.
- Remove the motorcycle from the work stand. (☛ P. 21)
- Pull the front wheel brake and push down hard on the fork several times to align the fork legs.
- Fully tighten screw 5.

Screw, fork stub	M8	15 Nm (11.06 lbf ft)
------------------	----	-------------------------

Removing rear wheel ☛

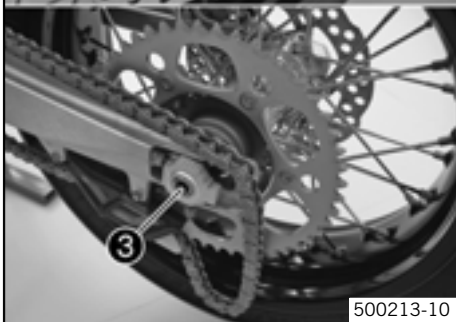
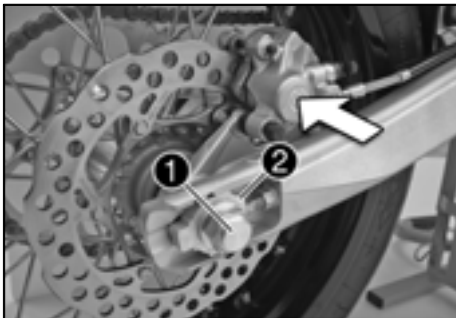

500213-10

- Jack up the motorcycle. (☛ P. 21)
- Press the brake caliper by hand on to the brake disc in order to press back the brake piston.

i Info
Make sure when pushing back the brake piston that you do not press the brake caliper against the spokes.

- Remove nut 1.
- Remove chain adjuster 2. Withdraw the wheel spindle 3 only enough to allow the rear wheel to be pushed forward.
- Push the rear wheel forward as far as possible. Remove the chain from the rear sprocket.
- Holding the rear wheel, withdraw the wheel spindle. Take the rear wheel out of the swing arm.

i Info
Do not operate the foot brake when the rear wheel is removed. Always lay the wheel down in such a way that the brake disc is not damaged.

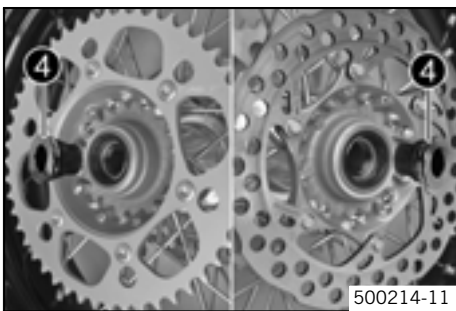

500214-11

- Remove the spacing sleeves 4.

Fitting rear wheel ☛

Warning
Danger of accidents Reduced braking due to oil or grease on the brake discs.

- Always keep the brake discs free of oil and grease, and clean them with brake cleaner when necessary.

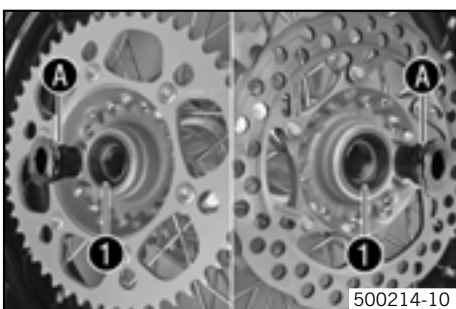

500214-10

- Check parts for damage and wear. Replace damaged or worn parts.
- Clean and grease shaft seal rings 1 and bearing surface A of the spacing sleeves.

Long-life grease (☛ P. 84)

- Fit the spacing sleeves.

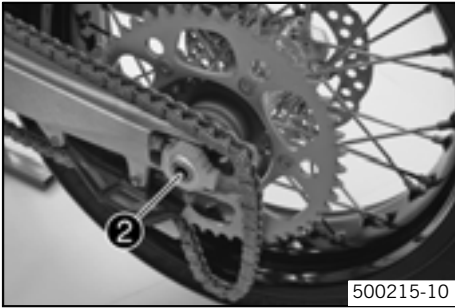

500215-10

- Lift the rear wheel into the swing arm, position it, and insert the wheel spindle ②.
- Put the chain on.

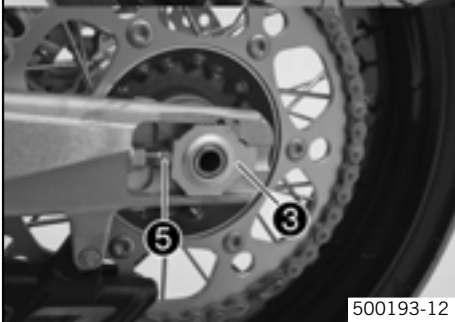
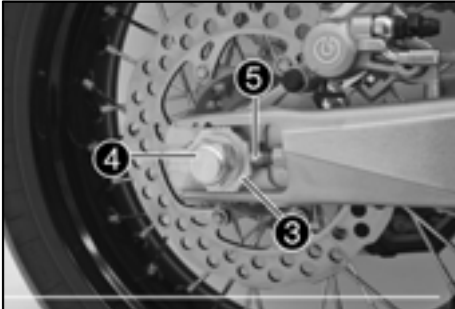

500193-12

- Position the chain adjuster ③. Fit nut ④, but do not tighten it yet.
- Check the chain tension when fitting rear wheel. (☛ P. 35)
- Make sure that the chain adjusters ③ are fitted correctly on the adjusting screws ⑤.
- Tighten nut ④.

Specification

Nut, rear wheel spindle	M20x1,5	80 Nm (59.01 lbf ft)
-------------------------	---------	-------------------------

i Info

The wide adjustment range of the chain adjusters (32 mm) enables different secondary transmissions with the same chain length.
The chain adjusters ③ can be turned by 180°.

- Operate the foot brake lever repeatedly until the brake linings lie on the brake disc and there is a tight spot.
- Remove the motorcycle from the work stand. (☛ P. 21)

Tire condition checking

i Info

Fit only tires approved by KTM.
Other tires could have a negative effect on riding behavior.
The type, condition and air pressure of the tires all have an important impact on the riding behavior of the motorcycle.
The front and rear wheels must be fitted with tires with similar profiles.
Worn tires have a negative effect on riding behavior, especially on wet surfaces.

- Examine the tires for cuts, foreign bodies and other damage.

Checking tire air pressure

i Info

Low tire air pressure leads to abnormal wear and overheating of the tire.
Correct tire air pressure ensures optimal riding comfort and maximum tire service life.



500216-01

- Remove dust cap.
- Check tire air pressure when tires are cold.

Tire air pressure	
front	1.6 bar (23.21 psi)
Rear	1.6 bar (23.21 psi)

- » If the tire pressure does not meet specifications:
 - Correct tire pressure.
- Mount dust cap.

Checking spoke tension

- Warning**
Danger of accidents Unstable riding behavior due to loose spokes.
- If you ride with loose spokes, the spokes can break. Have the spoke tension corrected in an authorized KTM workshop.

Info
 A loose spoke can cause wheel imbalance, which leads to more loose spokes in a short time. If the spokes are too tight, they can break due to local overload. Check the spoke tension regularly, especially on a new motorcycle.

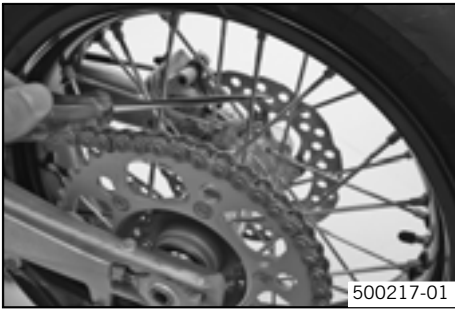

- To check spoke tension, tap each spoke with a screwdriver. Specification

You should hear a high note.

Spoke nipple, front wheel	M4,5	5 Nm (3.69 lbf ft)
Spoke nipple, rear wheel	M5	5 Nm (3.69 lbf ft)

Info
 If you hear different tone frequencies from different spokes, this is an indication of different spoke tensions.

Removing the battery

- Warning**
Risk of injury Battery acid and battery gases cause serious cauterization.

- Keep batteries out of the reach of children.
- Wear suitable protective clothing and goggles.
- Avoid contact with battery acid and battery gases.
- Keep the battery away from sparks or open fire. Charge only in well ventilated rooms.
- In the event of skin contact, rinse with large amounts of water. If battery acid gets in the eyes, rinse with water for at least 15 minutes and contact a doctor.



- Switch off all power-consuming components and switch off the engine.
- Remove the seat. (P. 53)
- Disconnect the negative (minus) cable ❶ of the battery.
- Pull back the plus pole cover ❷ and disconnect the positive (plus) cable of the battery.
- Hang the rubber band ❸ out to the bottom.
- Lift the battery up.

Installing the battery



- Check parts for damage and wear. Replace damaged or worn parts.
- Place the battery in the battery holder.

Condition

Outdoor temperature: $\geq 10\text{ }^{\circ}\text{C}$ ($\geq 50\text{ }^{\circ}\text{F}$)

3Ah battery (YTX4L-BS) (P. 74)

Condition

Outdoor temperature: $\leq 10\text{ }^{\circ}\text{C}$ ($\leq 50\text{ }^{\circ}\text{F}$)

4Ah battery (YTX5L-BS) (P. 74)

- Reconnect the rubber band ❶.
- Attach the plus cable and replace the plus pole cover ❷.
- Attach the minus cable ❸.

- Mount the seat. (🔧 P. 53)

Recharging the battery 🔧

- Warning**
Risk of injury Battery acid and battery gases cause serious cauterization.
- Keep batteries out of the reach of children.
 - Wear suitable protective clothing and goggles.
 - Avoid contact with battery acid and battery gases.
 - Keep the battery away from sparks or open fire. Charge only in well ventilated rooms.
 - In the event of skin contact, rinse with large amounts of water. If battery acid gets in the eyes, rinse with water for at least 15 minutes and contact a doctor.

- Warning**
Environmental hazard Components and battery acid are a danger to the environment.
- Do not dispose of batteries in normal household waste. Take defective or used batteries to a battery recycling operator.

- Warning**
Environmental hazard Problem materials cause environmental damage.
- Dispose of oil, grease, filters, fuel, cleaning substances, brake fluid, batteries, etc. according to regulations.

- i Info**
 Even if there is no load on the battery, it loses power every day.
 The charge state and the type of charge are very important for the service life of the battery.
 Fast recharging with a high charge current shortens the battery's service life.
 If the charge current, the charge voltage and the charge time are exceeded, electrolyte escapes through the breathing holes.
 The battery capacity is then reduced.
 If the battery is discharged from starting, it must be recharged immediately.
 If it stands for a long time in a discharged state, the battery becomes over-discharged and sulfated, and then it is destroyed.
 The battery is maintenance-free, i.e., the acid level does not have to be checked.

- Switch off all power-consuming components and switch off the engine.
- Remove the seat. (🔧 P. 53)
- Disconnect the minus (negative) cable of the battery to avoid damage to the motorcycle's electronics.
- Connect the battery charger to the battery. Switch on the battery charger.

Battery charger (58429074000)

You can also use the battery charger to test rest potential and start potential of the battery, and to test the generator. With this device, you cannot overcharge the battery.



- i Info**
 Never remove the lid ❶.
 Charge the battery according to the instructions ❷ on the battery casing.

- Switch off the charger after charging. Disconnect the battery.
- Specification

The charge current, charge voltage and charge time must not be exceeded.

Charge the battery regularly when the motorcycle is not in use.	3 months
---	----------

- Mount the seat. (🔧 P. 53)

Removing a fuse

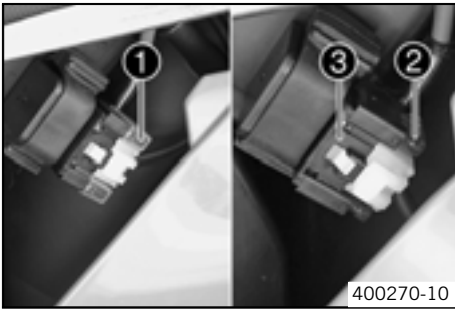

400270-10

- Switch off all power-consuming components and switch off the engine.
- Dismount the air filter box lid. (↖ P. 58)
- Remove the protection cover ❶.



Info

The fuse ❷ is located in the starter relay ❸ under the filter box cover.

- Remove the fuse ❷.

Replacing the fuse



Warning

Fire hazard The electrical system can be overloaded by the use of incorrect fuses.

- Use only fuses with the prescribed amperage. Never by-pass or repair fuses.

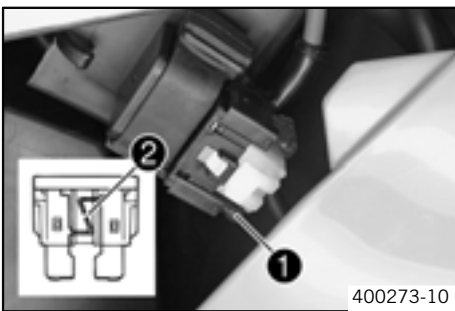

400273-10

- Check parts for damage and wear. Replace damaged or worn parts.



Info

A reserve fuse ❶ is located in the starter relay. Replace a burned-out fuse ❷ only by an equivalent fuse.

- Refit the fuse.

Fuse (58011109110)



Info

If the new fuse burns out, contact an authorized KTM workshop.

- Replace the protection cover.
- Install the air filter box lid. (↖ P. 58)

Ignition curve plug connection



500218-10

The plug connection ❶ is located in front of the fuel tank on the left of the frame.

Possible states

- Soft – If the plug connection is separated, riding is more flexible.
- Performance – If the plug connection is connected, higher performance is achieved.

Changing the ignition curve

Changing the ignition curve from Performance to Soft.

- Separate plug connection ❶. (Figure 500218-10 ↖ P. 52)
- ✓ Soft – Greater flexibility

Changing the ignition curve from Soft to Performance.

- Connect plug connection ❶. (Figure 500218-10 ↖ P. 52)
- ✓ Performance – Higher performance

Removing the seat

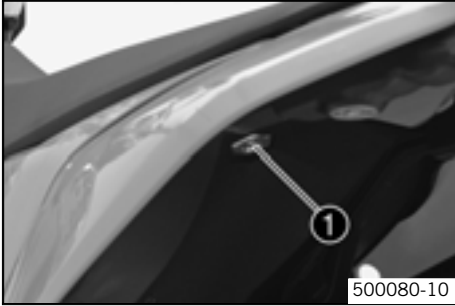

- Remove screw ❶. Lift up the seat at the rear, pull it back and then remove from above.

Mounting the seat



- Check parts for damage and wear. Replace damaged or worn parts.
- Hook the front of the seat into the flange adapter of the fuel tank, lower the rear of the seat and simultaneously push it forwards.
- Make sure that the seat is correctly locked in.
- Mount and tighten the screw of the seat fixing.

Specification

Remaining screws, chassis	M6	10 Nm (7.38 lbf ft)
---------------------------	----	------------------------

Dismounting the fuel tank

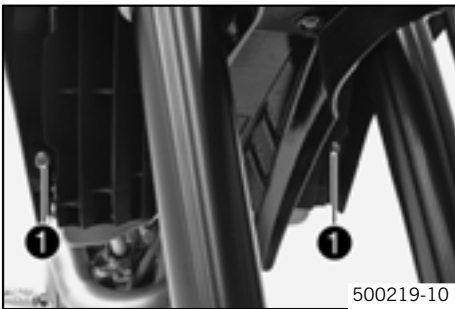

- Remove the seat. (🔧 P. 53)



Danger

Fire hazard Fuel can easily catch fire.

- Never fill up the vehicle near open flames or burning cigarettes, and always switch off the engine first. Be careful that no fuel is spilt, especially on hot vehicle components. Clean up spilt fuel immediately.
- Fuel in the fuel tank expands when warm and can escape if the tank is overfilled. See specifications on filling up with fuel.



Warning

Danger of poisoning Fuel is poisonous and a health hazard.

- Avoid contact between fuel and skin, eyes and clothing. Do not inhale fuel vapors. If fuel gets into your eyes, rinse immediately with water and contact a doctor. Wash affected skin areas immediately with soap and water. If fuel is swallowed, contact a doctor immediately. Change clothing that has come into contact with fuel. Store fuel in a suitable canister according to regulations and keep it out of the reach of children.

- Turn off the fuel tap and pull off the fuel hose.
- Remove screws ❶ with collar sleeve.
- Remove screw ❷ with collar sleeve.
- Remove the tube from the fuel tank vent line.

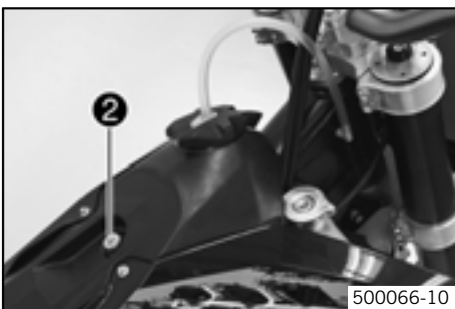



- Pull both spoilers to the side of the radiator bracket ③ and take the fuel tank away upwards.

Installing the fuel tank 🛠️



Danger

Fire hazard Fuel can easily catch fire.

- Never fill up the vehicle near open flames or burning cigarettes, and always switch off the engine first. Be careful that no fuel is spilt, especially on hot vehicle components. Clean up spilt fuel immediately.
- Fuel in the fuel tank expands when warm and can escape if the tank is overfilled. See specifications on filling up with fuel.



Warning

Danger of poisoning Fuel is poisonous and a health hazard.

- Avoid contact between fuel and skin, eyes and clothing. Do not inhale fuel vapors. If fuel gets into your eyes, rinse immediately with water and contact a doctor. Wash affected skin areas immediately with soap and water. If fuel is swallowed, contact a doctor immediately. Change clothing that has come into contact with fuel.

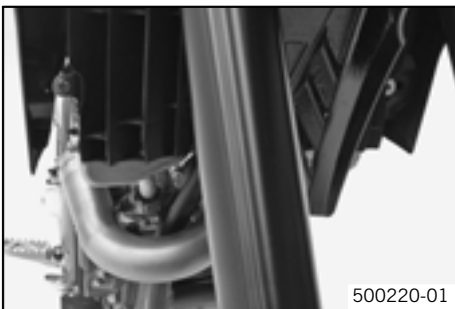

- Check parts for damage and wear. Replace damaged or worn parts.
- Position the fuel tank and fit the two spoilers to the side of the radiator fixing.
- Make sure that no cables or Bowden cables are trapped or damaged.

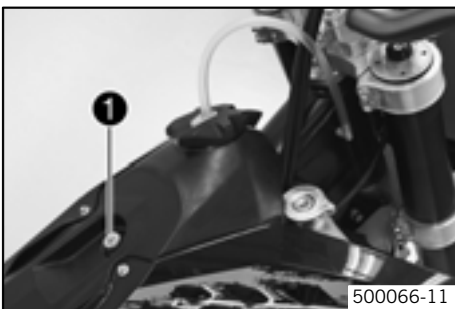

- Mount the fuel tank vent hose.
- Fit and tighten screw ① with collar sleeve.

Remaining screws, chassis	M6	10 Nm (7.38 lbf ft)
---------------------------	----	------------------------



- Fit and tighten screws ② with collar sleeve.

Remaining screws, chassis	M6	10 Nm (7.38 lbf ft)
---------------------------	----	------------------------

- Connect fuel hose.
- Mount the seat. (👉 P. 53)

Cooling system

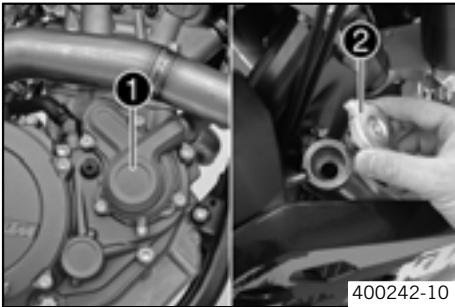

The water pump ❶ in the engine forces the coolant to flow. The pressure resulting from the warming of the cooling system is regulated by a valve in the radiator cap ❷. The specified coolant temperature is therefore permissible without danger of function problems.

120 °C (248 °F)

Coolant (☞ P. 82)

Cooling is effected by the air stream.

The lower the speed, the less the cooling effect. Dirty cooling fins also reduce the cooling effect.

Checking antifreeze and coolant level

- Warning**
Danger of scalding The coolant gets very hot when the motorcycle is driven and is under high pressure.
- Do not open the radiator, radiator hoses or other cooling system components when the engine is hot. Allow the engine and cooling system to cool down. If you scald yourself, hold the affected area under cold water immediately.

- Warning**
Danger of poisoning Coolants are poisonous and a health hazard.
- Avoid contact between coolants and skin, eyes and clothing. If fuel gets into your eyes, rinse immediately with water and contact a doctor. Wash affected skin areas immediately with soap and water. If coolant is swallowed, contact a doctor immediately. Change clothes that have come into contact with coolants. Keep coolants out of the reach of children.

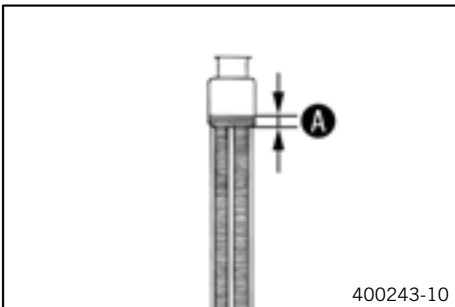

- Stand the motorcycle upright on a horizontal surface.
- Remove the radiator cap.
- Check antifreeze of coolant.

-25... -45 °C (-13... -49 °F)

- » If the antifreeze of the cooling liquid does not meet specifications:
 - Correct antifreeze of coolant.

- Check the coolant level in the radiator.

Coolant level A above radiator fins.	10 mm (0.39 in)
--------------------------------------	-----------------

- » If the level of the cooling liquid does not meet specifications:
 - Correct the coolant level.

Alternative 1

Coolant (☞ P. 82)

Alternative 2

Coolant (mixed ready to use) (☞ P. 82)

- Refit the radiator cap.

Checking the coolant level

- Warning**
Danger of scalding The coolant gets very hot when the motorcycle is driven and is under high pressure.
- Do not open the radiator, radiator hoses or other cooling system components when the engine is hot. Allow the engine and cooling system to cool down. If you scald yourself, hold the affected area under cold water immediately.

- Warning**
Danger of poisoning Coolants are poisonous and a health hazard.
- Avoid contact between coolants and skin, eyes and clothing. If fuel gets into your eyes, rinse immediately with water and contact a doctor. Wash affected skin areas immediately with soap and water. If coolant is swallowed, contact a doctor immediately. Change clothes that have come into contact with coolants. Keep coolants out of the reach of children.

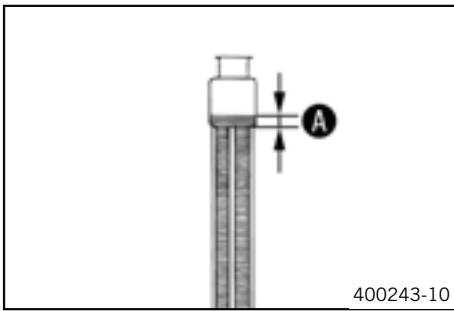

- Stand the motorcycle upright on a horizontal surface.
- Remove the radiator cap.
- Check the coolant level in the radiator.

Coolant level A above radiator fins.	10 mm (0.39 in)
---	-----------------

- » If the level of the cooling liquid does not meet specifications:
 - Correct the coolant level.

Alternative 1

Coolant (☛ P. 82)

Alternative 2

Coolant (mixed ready to use) (☛ P. 82)

- Refit the radiator cap.

Draining coolant 🛠️

- Warning**
Danger of scalding The coolant gets very hot when the motorcycle is driven and is under high pressure.
- Do not open the radiator, radiator hoses or other cooling system components when the engine is hot. Allow the engine and cooling system to cool down. If you scald yourself, hold the affected area under cold water immediately.

- Warning**
Danger of poisoning Coolants are poisonous and a health hazard.
- Avoid contact between coolants and skin, eyes and clothing. If fuel gets into your eyes, rinse immediately with water and contact a doctor. Wash affected skin areas immediately with soap and water. If coolant is swallowed, contact a doctor immediately. Change clothes that have come into contact with coolants. Keep coolants out of the reach of children.

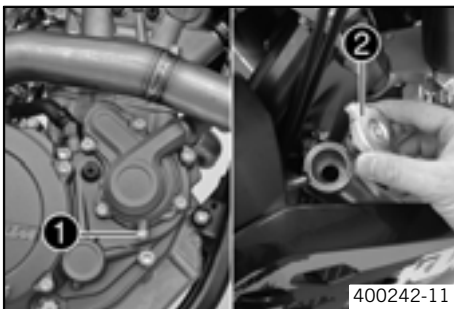

- Stand the vehicle upright.
 - Place a suitable container under the water pump cover.
 - Remove screw **1**. Remove the radiator cap **2**.
 - Completely drain the coolant.
 - Fit screw **1** with a new seal and tighten it.
- Specification

Screw, water pump cover	M6	10 Nm (7.38 lbf ft)
-------------------------	----	------------------------

Refilling coolant 🛠️

- Warning**
Danger of poisoning Coolants are poisonous and a health hazard.
- Avoid contact between coolants and skin, eyes and clothing. If fuel gets into your eyes, rinse immediately with water and contact a doctor. Wash affected skin areas immediately with soap and water. If coolant is swallowed, contact a doctor immediately. Change clothes that have come into contact with coolants. Keep coolants out of the reach of children.

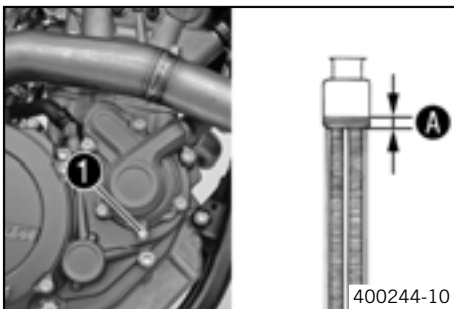

- Make sure that the screw **1** is tightened.
 - Stand the vehicle upright.
 - Pour coolant in up to measurement **A** above the radiator fins.
- Specification

10 mm (0.39 in)		
Coolant	1.2 l (1.27 qt.)	Coolant (☛ P. 82)
		Coolant (mixed ready to use) (☛ P. 82)

- Refit the radiator cap.
- Make a short test ride.
- Check the coolant level. (☛ P. 55)

Removing main silencer



Warning

Danger of burns The exhaust system gets very hot when the vehicle is driven.

- Allow the exhaust system to cool down. Do not touch hot components.

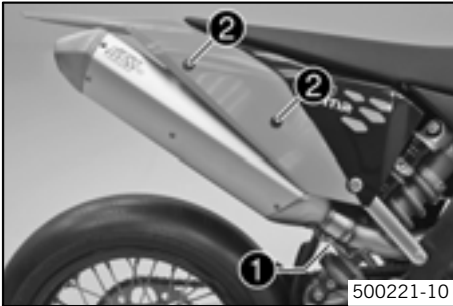

- Disconnect spring ①.
- Remove screws ② and take off main silencer.

Fitting the main silencer

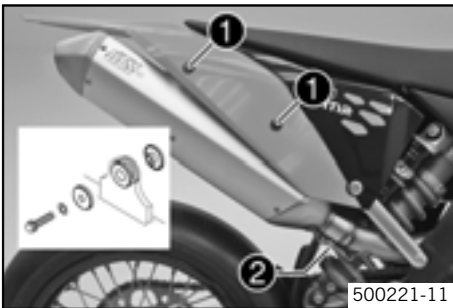

- Check parts for damage and wear. Replace damaged or worn parts.
- Mount the main silencer. Mount and tighten screws ①.

Specification

Remaining screws, chassis	M6	10 Nm (7.38 lbf ft)
---------------------------	----	------------------------

- Reconnect spring ②.

Glass fiber yarn filling of main silencer

The main silencer is filled with glass fiber yarn.

Over a period, the fibers of the insulating material vanish into the air, and the silencer "burns out".

Not only is the noise level higher, the performance characteristic changes.

Removing glass fiber yarn filling of main silencer



Warning

Danger of burns The exhaust system gets very hot when the vehicle is driven.

- Allow the exhaust system to cool down. Do not touch hot components.

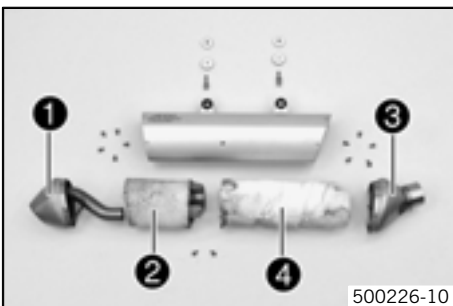

- Remove the main silencer. (☛ P. 57)
- Remove screws of end cap ①. Remove the end cap.
- Remove screws of insert ②. Remove insert.
- Remove screws of cap ③. Remove cap.
- Remove inner-tube ④.
- Remove glass fiber yarn filling from insert ② and inner-tube ④.
- Clean parts to be refitted.

Fitting glass fiber yarn filling of main silencer

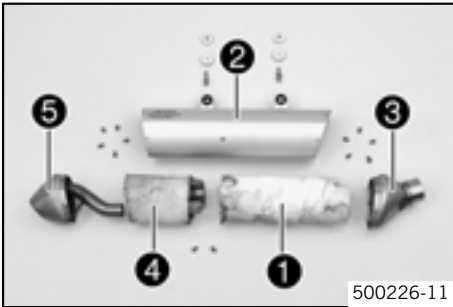

500226-11

- Check parts for damage and wear. Replace damaged or worn parts.
- Attach the glass fiber yarn filling to inner tube ①. Fit the inner tube into the outer tube ②.
- Insert cap ③. Mount and tighten screws.
- Attach the glass fiber yarn filling to insert ④. Fit the insert into the outer tube ②. Mount and tighten screws.
- Insert end cap ⑤. Mount and tighten screws.
- Fit the main silencer. (☛ P. 57)

Changing glass fiber yarn filling of main silencer

- Remove glass fiber yarn filling of main silencer. (☛ P. 57)
- Fit the glass fiber yarn filling of the main silencer. (☛ P. 58)

Dismounting the air filter box lid



500222-10

- Pull off the air filter box lid in area ① to the side and remove to the front.

Installing the air filter box lid

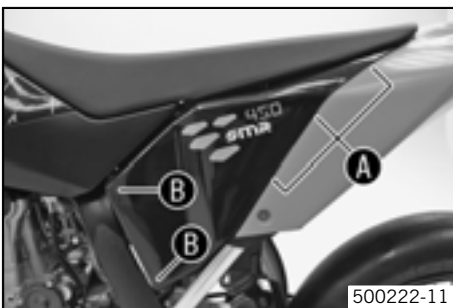

500222-11

- Check parts for damage and wear. Replace damaged or worn parts.
- Insert the air filter box lid into the rear area ① and clip it into the front area ②.

Removing the air filter

Note

Engine failure Unfiltered intake air has a negative effect on the service life of the engine.

- Never ride the vehicle without an air filter since dust and dirt can get into the engine and result in increased wear.



Warning

Environmental hazard Problem materials cause environmental damage.

- Dispose of oil, grease, filters, fuel, cleaning substances, brake fluid, batteries, etc. according to regulations.

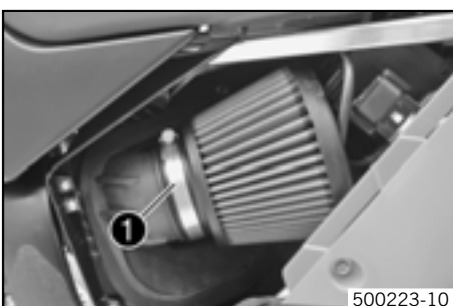

500223-10

- Dismount the air filter box lid. (☛ P. 58)
- Undo the hose clip ①.
- Remove the air filter.

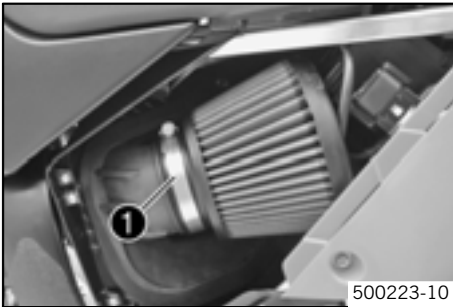

Installing the air filter



- Check parts for damage and wear. Replace damaged or worn parts.
- Fit a clean air filter.

 **Info**

If the air filter is not correctly mounted, dust and dirt can penetrate into the engine and can cause damage.

- Position and tighten the hose clip .
- Install the air filter box lid. ( P. 58)

Cleaning air filter

 **Warning**

Environmental hazard Problem materials cause environmental damage.

- Dispose of oil, grease, filters, fuel, cleaning substances, brake fluid, batteries, etc. according to regulations.

 **Info**

Do not use fuel or kerosene for cleaning the air filter.



- Remove the air filter. ( P. 58)
- Remove large pieces of dirt by shaking. Use a soft brush to clean the air filter.
- Spray on the cleaner and let it penetrate for 10 minutes.

Air filter cleaner ( P. 84)

- Rinse the air filter from the inside with a soft jet of water.
- Shake off remaining water. Allow the air filter to dry.

 **Info**

Do not use compressed air for drying!

- Spray the dry air filter carefully with filter oil.

Air filter oil ( P. 84)

- Allow the filter oil to penetrate for 20 minutes.
- Clean the air filter box.
- Check the distribution of the filter oil.
 - » If unoiled areas are visible:
 - Oil the air filter again.
- Wipe off excess filter oil.

 **Info**

Do not over-oil the air filter.

- Check carburetor connection boot for damage and tightness.
- Install the air filter. ( P. 59)

Adjusting basic position of clutch lever

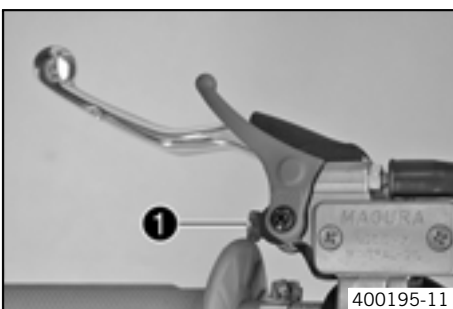

- Adjust the basic setting of the clutch lever to your hand size by turning adjusting screw .

 **Info**

Turn the adjusting screw clockwise to increase the distance between the clutch lever and the handlebar.
 Turn the adjusting screw counterclockwise to decrease the distance between the clutch lever and the handlebar.
 The range of adjustment is limited.
 Turn the adjusting screw by hand only, and do not apply any force.
 Do not make any adjustments while riding!

Checking fluid level of hydraulic clutch



Info

The fluid level rises with increasing wear of the clutch lining disc.
Do not use brake fluid.

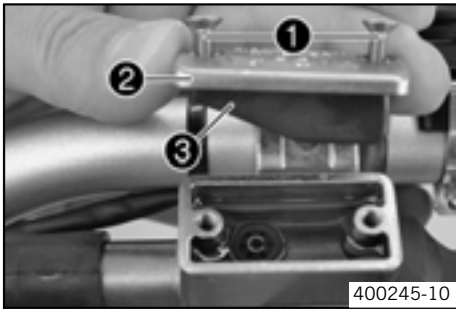

- Move the clutch fluid reservoir mounted on the handlebar to a horizontal position.
- Remove screws ❶.
- Remove the cover ❷ with membrane ❸.
- Check the fluid level.

Fluid level under top level of container.	4 mm (0.16 in)
---	----------------

- » If the level of the cooling liquid does not meet specifications:
 - Correct the fluid level of the hydraulic clutch.

Hydraulic fluid (15) (☛ P. 82)

- Check parts for damage and wear. Replace damaged or worn parts.
- Position the cover with the membrane. Mount and tighten screws.

Changing fluid level of hydraulic clutch 🛠️



Warning

Environmental hazard Problem materials cause environmental damage.

- Dispose of oil, grease, filters, fuel, cleaning substances, brake fluid, batteries, etc. according to regulations.

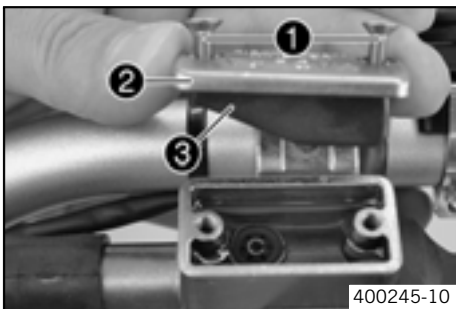

- Move the clutch fluid reservoir mounted on the handlebar to a horizontal position.
- Remove screws ❶.
- Remove the cover ❷ with membrane ❸.

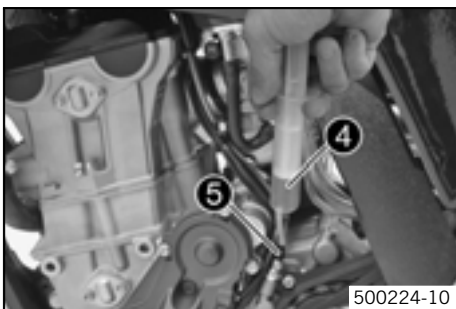

- Fill the bleeding syringe ❹ with the appropriate hydraulic fluid.

Bleed syringe (50329050000)

Hydraulic fluid (15) (☛ P. 82)

- On the slave cylinder, remove the bleeder screw ❺ and fit the bleeding syringe ❹.



- Inject the liquid into the system until it escapes from the bore hole ❻ of the master cylinder without bubbles.
- To prevent overflow, drain fluid occasionally from the master cylinder reservoir.
- Remove the bleeding syringe. Mount and tighten screws bleeder screw.
- Correct the fluid level of the hydraulic clutch.

Specification

Fluid level under top level of container.	4 mm (0.16 in)
---	----------------

- Check parts for damage and wear. Replace damaged or worn parts.
- Position the cover with the membrane. Mount and tighten screws.

Carburetor - idle

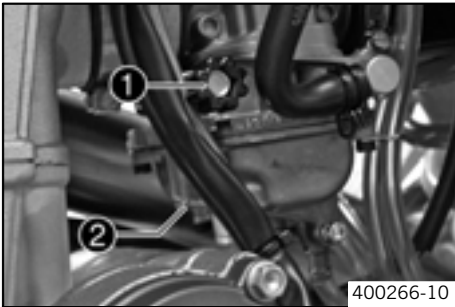

400266-10

The idle setting of the carburetor has a big influence on the starting behavior, stable idling and the response to throttle opening. That means that an engine with a correctly set idle speed is easier to start than if the idle is set wrongly.

i Info
The carburetor and its components are subject to increased wear caused by engine vibration. Wear can result in malfunctioning.

The idle speed is adjusted with the adjustment screw ❶.
The idle mixture is adjusted with the idle mixture adjustment screw ❷.

Carburetor - adjusting idle 🐘

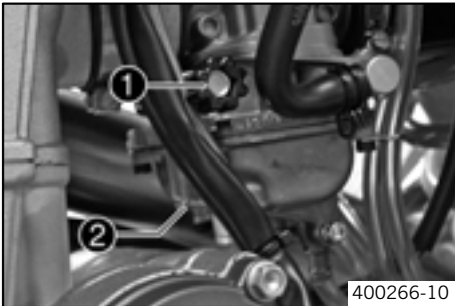

400266-10

- Screw in the idle adjusting screw ❷ until it stops and then to the prescribed basic setting.

Specification

Idle mixture adjusting screw	
Open	1.5 turns

Adjustment tool for mixture control screw (77329034000)

- Run the engine until warm.

Specification

Warm-up time	≥ 5 min
--------------	---------

- Adjust the idle speed with the adjusting screw ❶.

Specification

Choke function activated – The choke lever is pushed in to the stop. (🐘 P. 11)	
Idle speed	1600... 1650 rpm

- Turn the idle adjusting screw ❷ slowly until the idle speed begins to fall.
- Note the position and turn the idle adjusting screw slowly counterclockwise until the idle speed falls.
- Adjust to the point between these two positions with the highest idle speed.

i Info
If there is a big engine speed rise, reduce the idle speed to a normal level and repeat the above steps.
The extreme sport motocyclist will set the mixture about 1/4 of a turn back from this ideal value (leaner, in a clockwise direction) since the engine becomes hotter in sporting use.
If the procedure described here does not lead to satisfactory results, the cause may be a wrongly dimensioned idling jet.
If you can turn the idle adjusting screw to the end without any change of engine speed, you have to fit a smaller idling jet.
The idle adjusting screw must not be opened more than two turns. If more than two turns are necessary (rich mixture), use a larger idling jet.
After changing the idling jet, start from the beginning with the adjusting steps.

- Adjust the idle speed with the adjusting screw ❶.

Specification

Choke function activated – The choke lever is pushed in to the stop. (🐘 P. 11)	
Idle speed	1600... 1650 rpm

i Info
Following extreme air temperature or altitude changes, adjust the idle speed again.

Emptying the carburetor float chamber

- Danger**
Fire hazard Fuel can easily catch fire.
- Never fill up the vehicle near open flames or burning cigarettes, and always switch off the engine first. Be careful that no fuel is spilt, especially on hot vehicle components. Clean up spilt fuel immediately.
 - Fuel in the fuel tank expands when warm and can escape if the tank is overfilled. See specifications on filling up with fuel.

- Warning**
Danger of poisoning Fuel is poisonous and a health hazard.
- Avoid contact between fuel and skin, eyes and clothing. Do not inhale fuel vapors. If fuel gets into your eyes, rinse immediately with water and contact a doctor. Wash affected skin areas immediately with soap and water. If fuel is swallowed, contact a doctor immediately. Change clothing that has come into contact with fuel. Store fuel in a suitable canister according to regulations and keep it out of the reach of children.

- Warning**
Environmental hazard Improper handling of fuel is a danger to the environment.
- Do not allow fuel to get into the ground water, the ground, or the sewage system.

Info
 Carry out this work with a cold engine.

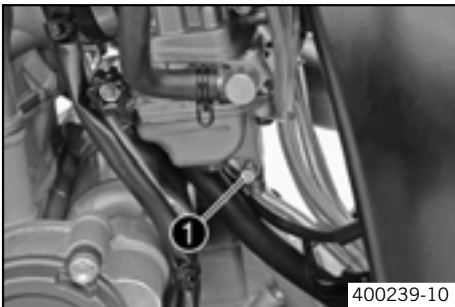

400239-10

- Turn the handle ❶ of the fuel tap to the **OFF** position. (Figure 500178-10 P. 11)
 ✓ No more fuel flows from the tank to the carburetor.
- Guide the hose coming down behind the engine into a suitable container.

Info
 Water in the float chamber results in malfunctioning.

- Undo the screw ❶ (turn it counterclockwise) a few turns and drain the fuel from the float chamber.
- Tighten screw ❶.

Checking engine oil level

Info
 The engine oil level can be checked on a cold or hot engine.

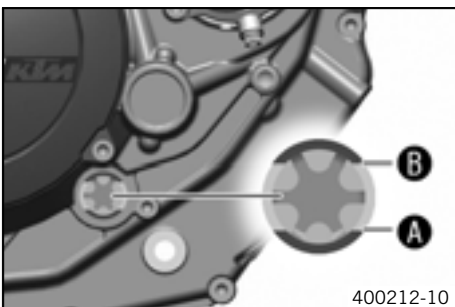

400212-10

- Stand the motorcycle upright on a horizontal surface.

Condition

The engine is at operating temperature.

- Check the engine oil level.

The engine oil reaches the top of the viewer ❷.

- » When the engine oil does not reach the top of the viewer:
 - Top up the engine oil. (P. 65)

Condition

Engine is cold.

- Check the engine oil level.

The engine oil reaches the bottom of the viewer ❶.

- » When the engine oil does not reach the bottom of the viewer:
 - Top up the engine oil. (P. 65)

Changing engine oil and oil filter, cleaning oil screen

- Drain the engine oil. (☞ P. 63)
- Remove the oil filter. (☞ P. 64)
- Mount the oil filter. (☞ P. 64)
- Fill up with engine oil. (☞ P. 64)

Draining engine oil

- Warning**
Danger of scalding Engine oil and gear oil get very hot when the motorcycle is driven.
- Wear suitable protective clothing and gloves. If you scald yourself, hold the affected area under cold water immediately.
- Warning**
Environmental hazard Problem materials cause environmental damage.
- Dispose of oil, grease, filters, fuel, cleaning substances, brake fluid, batteries, etc. according to regulations.

Info
 Drain the engine oil only when the engine is warm.

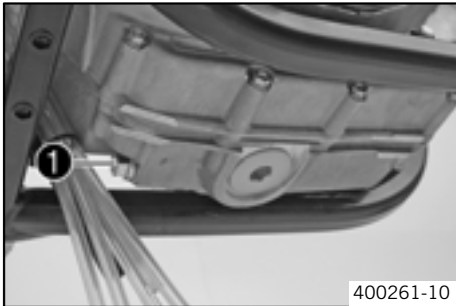

- Stand the motorcycle on its side stand on a horizontal surface.
- Place a suitable container under the engine.
- Remove the oil drain plug ❶ with the seal ring.
- Completely drain the engine oil.
- Thoroughly clean the oil drain plug with a magnet.
- Clean the sealing area on the engine.
- Check parts for damage and wear. Replace damaged or worn parts.
- Refit oil drain plug ❶ with seal ring and tighten it.

Specification

Oil drain plug with magnet	M12x1,5	20 Nm (14.75 lbf ft)
----------------------------	---------	-------------------------

- Clean the oil screen. (☞ P. 63)

Cleaning the oil screen

- Warning**
Danger of scalding Engine oil and gear oil get very hot when the motorcycle is driven.
- Wear suitable protective clothing and gloves. If you scald yourself, hold the affected area under cold water immediately.
- Warning**
Environmental hazard Problem materials cause environmental damage.
- Dispose of oil, grease, filters, fuel, cleaning substances, brake fluid, batteries, etc. according to regulations.

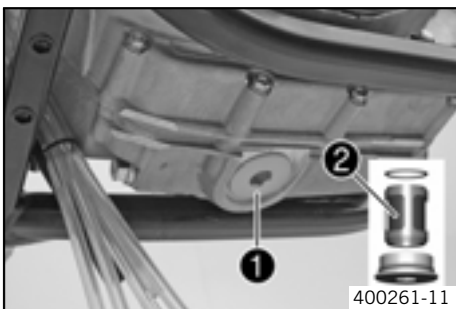

- Place a suitable container under the engine.
- Loosen the plug ❶ with a few light hammer blows.
- Remove plug ❶ with oil screen ❷ and O-rings.
- Completely drain the remaining engine oil.
- Thoroughly clean parts and sealing area.
- Check parts for damage and wear. Replace damaged or worn parts.
- Fit and tighten plug ❶ with oil screen ❷ and O-rings.

Specification

Plug, oil screen	M32x1,5	30 Nm (22.13 lbf ft)
------------------	---------	-------------------------

Removing the oil filter 🛠️

- Warning**
Danger of scalding Engine oil and gear oil get very hot when the motorcycle is driven.
- Wear suitable protective clothing and gloves. If you scald yourself, hold the affected area under cold water immediately.

- Warning**
Environmental hazard Problem materials cause environmental damage.
- Dispose of oil, grease, filters, fuel, cleaning substances, brake fluid, batteries, etc. according to regulations.

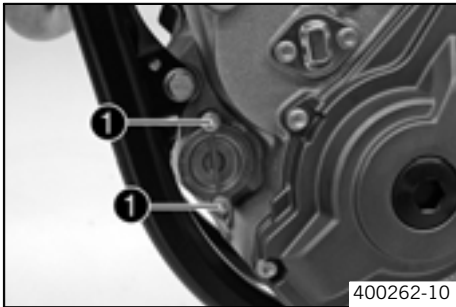

- Place a suitable container under the engine.
- Remove screws ❶. Remove oil filter cover with O-ring.

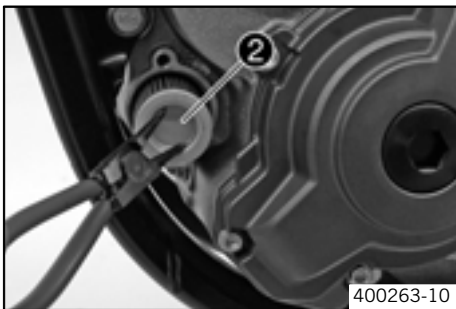

- Pull the oil filter insert ❷ out of the oil filter casing.
- | |
|--------------------------------------|
| Circlip pliers reverse (51012011000) |
|--------------------------------------|
- Completely drain the engine oil.
 - Thoroughly clean parts and sealing area.

Mounting oil filter 🛠️

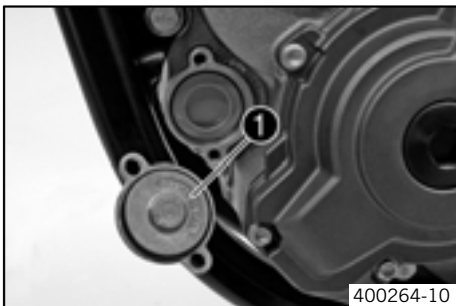

- Check parts for damage and wear. Replace damaged or worn parts.
- Lay the motorcycle on its side and fill the oil filter housing to about 1/3 full with engine oil.
- Fill the oil filter with engine oil and place it in the oil filter container.
- Oil the O-ring of the oil filter cover and assemble it with the oil filter cover ❶.
- Mount and tighten screws.

Specification

Screw, oil filter cover	M6	10 Nm (7.38 lbf ft)
-------------------------	----	------------------------

- Stand the motorcycle up.

Filling up with engine oil 🛠️

- i Info**
 Too little engine oil or poor-quality engine oil results in premature wear to the engine.

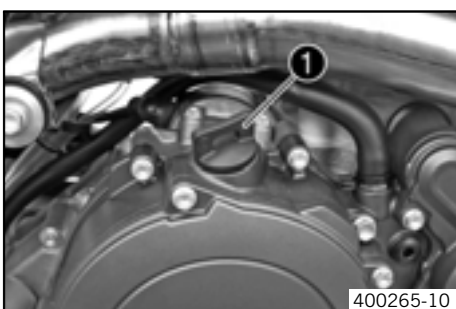

- Remove the screw cap ❶ on the clutch cover and fill up with engine oil.

Engine oil	1.35 l (1.43 qt.)	Engine oil (SAE 10W/50) (☛ P. 82)
------------	-------------------	-----------------------------------

- Mount and tighten screw cap ❶.

- Warning**
Danger of poisoning Exhaust gases are poisonous and can result in unconsciousness and/or death.
- When running the engine, always make sure there is sufficient ventilation, and do not start or run the engine in a closed space.

- Start the engine and check that it is oil-tight.

- Check the engine oil level. (🔧 P. 62)

Topping up engine oil



Info

Too little engine oil or poor-quality engine oil results in premature wear to the engine.

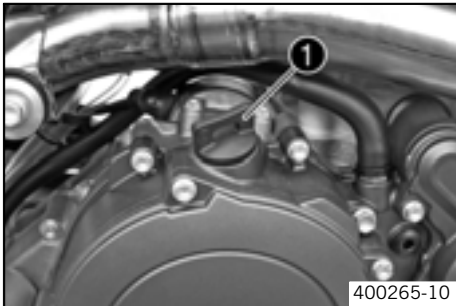

- Remove the screw cap ❶ on the clutch cover and fill up with engine oil.

Engine oil (SAE 10W/50) (🔧 P. 82)

- Mount and tighten screw cap ❶.



Danger

Danger of poisoning Exhaust gases are poisonous and can result in unconsciousness and/or death.

- When running the engine, always make sure there is sufficient ventilation, and do not start or run the engine in a closed space.

- Start the engine and check that it is oil-tight.

Faults	Possible cause	Measure
The engine cannot be cranked (electric starter).	Battery discharged	<ul style="list-style-type: none"> – Recharge the battery. (☛ P. 51) – Check the cause of discharging.
	Fuse blown	<ul style="list-style-type: none"> – Remove the fuse. (☛ P. 52) – Replace the fuse. (☛ P. 52)
	Low external temperature	<ul style="list-style-type: none"> – Use the battery supplied in the accessories package. 4Ah battery (YTX5L-BS) (☛ P. 74)
Engine turns but does not start.	Operating error	<ul style="list-style-type: none"> – Carry out the instructions for starting. (☛ P. 15)
	Motorcycle was out of use for a long time and there is old fuel in the float chamber	<ul style="list-style-type: none"> – Empty the carburetor float chamber. (☛ P. 62)
	Fuel feed interrupted	<ul style="list-style-type: none"> – Check tank vent. – Clean fuel tap. – Clean carburetor.
	Engine flooded	<ul style="list-style-type: none"> – Clean and dry spark plug or replace if necessary.
	Spark plug oily or wet	<ul style="list-style-type: none"> – Clean and dry spark plug or replace if necessary.
	Electrode distance (plug gap) of spark plug too wide	<ul style="list-style-type: none"> – Adjust plug gap. Specification spark plug electrode gap 0.7 mm (0.03 in)
	Spark plug connector or spark plug defective	<div style="border: 1px solid black; padding: 5px;"> <p> Warning Risk of injury The ignition system is under high voltage.</p> <ul style="list-style-type: none"> – Do not touch parts of the ignition system. Have work on the ignition system carried out in an authorized KTM workshop. </div> <ul style="list-style-type: none"> – Remove spark plug, connect ignition cable, hold spark plug to ground (bare metal area on engine), and try to start the engine. Specification You should see a strong spark on the spark plug. – If there is no spark, change the spark plug. – If there is still no spark, remove the spark plug cap from the ignition cable, hold it at the specified distance from the ground contact, and try to start the engine. Specification 5 mm (0.2 in) – If you now have a spark, replace the spark plug connector. – If there is no spark, have the ignition system checked.
	Short-circuit cable in wiring harness chafed, short-circuit button defective	<ul style="list-style-type: none"> – Check wiring harness. (visual check) – Check electrical system.
	Socket connector of CDI control device, pulse generator or ignition coil oxidized.	<ul style="list-style-type: none"> – Clean socket connector and treat it with contact spray.
Water in carburetor or jets blocked	<ul style="list-style-type: none"> – Clean carburetor. 	
Engine has no idle.	Idling jet blocked	<ul style="list-style-type: none"> – Clean carburetor.
	Adjusting screws on carburetor distorted	<ul style="list-style-type: none"> – Have the carburetor adjusted.
	Spark plug defective	<ul style="list-style-type: none"> – Change spark plug.

Faults	Possible cause	Measure
Engine has no idle.	Ignition system defective	– Have ignition system checked.
Engine does not speed up.	Carburetor running over because float needle dirty or worn	– Have carburetor checked.
	Loose carburetor jets	– Have carburetor checked.
	Electronic ignition adjustment defective	– Have ignition system checked.
Engine has too little power.	Fuel feed interrupted	– Check tank vent. – Clean fuel tap. – Clean carburetor.
	Air filter very dirty	– Clean the air filter. (☛ P. 59)
	Exhaust system leaky, deformed or too little glass fiber yarn filling in main silencer	– Check exhaust system for damage. – Change glass fiber yarn filling of main silencer. (☛ P. 58)
	Valve clearance too little	– Have valve clearance adjusted.
	Electronic ignition adjustment defective	– Have ignition system checked.
Engine stalls or is popping into the carburetor	Lack of fuel	– Clean and check the fuel system and carburetor.
	Engine takes in bad air	– Check rubber sleeves and carburetor for tightness.
Engine overheats.	Too little coolant in cooling system	– Check the cooling system for leakage. – Check the coolant level. (☛ P. 55)
	Too little air stream	– Switch off engine when standing.
	Radiator fins very dirty	– Clean radiator fins.
	Foam formation in cooling system	– Drain the coolant. (☛ P. 56) – Refill the coolant. (☛ P. 56)
	Bent radiator hose	– Replace the radiator hose.
High oil consumption	Engine vent hose bent	– Route the vent hose without bends or replace it if necessary.
	Engine oil level too high	– Check the engine oil level. (☛ P. 62)
	Engine oil too thin (low viscosity)	– Change the engine oil and oil filter, and clean the oil screen. (☛ P. 63)
Battery discharged	Battery is not charged by generator	– Check electrical system.

Cleaning motorcycle

Note

Material damage Damage and destruction of components by high-pressure cleaning equipment.

- Never clean the vehicle with high-pressure cleaning equipment or a strong water-jet. The excessive pressure can penetrate electrical components, connects, Bowden cables, and bearings, etc., and can damage or destroy these parts.



Warning

Environmental hazard Problem materials cause environmental damage.

- Dispose of oil, grease, filters, fuel, cleaning substances, brake fluid, batteries, etc. according to regulations.



Info

If you clean the motorcycle regularly, its value and appearance are maintained over a long period. Avoid direct sunshine on the motorcycle during cleaning.

- Before you clean the motorcycle, seal the exhaust system to prevent penetration by water.
- First remove coarse dirt particles with a gentle water spray.
- Spray very dirty areas with a normal motorcycle cleaner and then clean with a paintbrush.

Motorcycle cleaner (☛ P. 84)



Info

Use warm water containing normal motorcycle cleaner and a soft sponge.

- After rinsing the motorcycle with a gentle water spray, allow it to dry thoroughly.
- Empty the carburetor float chamber. (☛ P. 62)



Warning

Danger of accidents Reduced braking due to wet or dirty brakes.

- Clean or dry dirty or wet brakes by riding and braking gently.

- After cleaning, ride the vehicle a short distance until the engine warms up, and then apply the brakes.



Info

The heat produced causes water at inaccessible positions in the engine and the brakes to evaporate.

- Push back the protection covers on the handlebar instruments to allow water to evaporate.
- After the motorcycle has cooled off, oil or grease all moving parts and bearings.
- Clean the chain. (☛ P. 34)
- Treat bare metal parts (except for brake discs and exhaust system) with anti-corrosion materials.

Cleaning and polishing materials for metal, rubber and plastic (☛ P. 84)

- Treat all painted parts with a mild paint polish.

High-luster polish for paint (☛ P. 85)

- To prevent electrical problems, treat electric contacts and switches with contact spray.

Contact spray (☛ P. 85)

Storage



Warning

Danger of poisoning Fuel is poisonous and a health hazard.

- Avoid contact between fuel and skin, eyes and clothing. Do not inhale fuel vapors. If fuel gets into your eyes, rinse immediately with water and contact a doctor. Wash affected skin areas immediately with soap and water. If fuel is swallowed, contact a doctor immediately. Change clothing that has come into contact with fuel. Store fuel in a suitable canister according to regulations and keep it out of the reach of children.



Info

If you want to garage the motorcycle for a longer period, take the following actions.

Before storing the motorcycle, check all parts for function and wear. If service, repairs or replacements are necessary, you should do this during the storage period (less workshop overload). In this way, you can avoid long workshop waiting times at the start of the new season.

- Clean the motorcycle. (🔧 P. 68)
- Change the engine oil and oil filter, and clean the oil screen. (🔧 P. 63)
- Check the antifreeze and coolant level. (🔧 P. 55)
- Drain the fuel from the tanks into a suitable container.
- Empty the carburetor float chamber. (🔧 P. 62)
- Checking the tire air pressure. (🔧 P. 49)
- Remove the battery. (🔧 P. 50)
- Recharge the battery. (🔧 P. 51)

Specification

Storage temperature of battery without direct sunshine.	0... 35 °C (32... 95 °F)
---	--------------------------

- The storage place should be dry and not subject to large temperature differences.



Info

KTM recommends jacking up the motorcycle.

- Jack up the motorcycle. (🔧 P. 21)
- Cover the motorcycle with a porous sheet or blanket. Do not use non-porous materials since they prevent humidity from escaping, thus causing corrosion.



Info

Avoid running the engine for a short time only. Since the engine cannot warm up properly, the water vapor produced during combustion condenses and causes valves and exhaust system to rust.

Putting into operation after storage

- Remove the motorcycle from the work stand. (🔧 P. 21)
- Install the battery. (🔧 P. 50)
- Fill up with fuel. (🔧 P. 17)
- Checks before putting into operation (🔧 P. 15)
- Make a test ride.

Design	1-cylinder 4-stroke engine, water-cooled
Displacement	449.3 cm ³ (27.42 cu in)
Stroke	60.8 mm (2.39 in)
Bore	97 mm (3.82 in)
Compression ratio	12,5:1
Idle speed	1600... 1650 rpm
Control	4 valves controlled by cam levers and 2 camshafts, driven by helical gear pair and tooth-wheel chain
Valve diameter, intake	40.4 mm (1.59 in)
Valve diameter, exhaust	31.7 mm (1.25 in)
Valve clearance, cold, intake	0.07... 0.13 mm (0.0028... 0.01 in)
Valve clearance, cold, exhaust	0.12... 0.18 mm (0.0047... 0.01 in)
Crankshaft bearing	2 cylinder roller bearing
Conrod bearing	Needle bearing
Piston pin bearing	Bronze bush
Pistons	Forged light alloy
Piston rings	1 compression ring, 1 oil scraper ring
Engine lubrication	Pressure circulation lubrication with 3 rotor pumps
Primary transmission	29:74
Transmission ratio	
1st gear	18:31
2nd gear	20:29
3rd gear	22:27
4th gear	24:25
5th gear	26:23
Generator	12 V, 42 W
Ignition	Contactless controlled fully electronic ignition with digital ignition adjustment, type Kokusan
Spark plug	NGK CR 9 EKB
spark plug electrode gap	0.7 mm (0.03 in)
Cooling	Water cooling, permanent circulation of coolant by water pump
Starting aid	Electric starter

Capacity - engine oil

Engine oil	1.35 l (1.43 qt.)	Engine oil (SAE 10W/50) (☛ P. 82)
------------	-------------------	-----------------------------------

Capacity - coolant

Coolant	1.2 l (1.27 qt.)	Coolant (☛ P. 82)
		Coolant (mixed ready to use) (☛ P. 82)

Engine housing vent jet	M4		Loctite® 243™
Oil jet, piston cooling	M4	4 Nm (2.95 lbf ft)	Loctite® 243™
Oil jet, cam lever lubrication	M4	6 Nm (4.43 lbf ft)	Loctite® 243™
Oil jet, clutch oil supply	M5x1	6 Nm (4.43 lbf ft)	Loctite® 243™
Screw, locking lever	M5	6 Nm (4.43 lbf ft)	Loctite® 243™
Screw, camshaft bearing retaining bracket	M5	6 Nm (4.43 lbf ft)	Loctite® 243™
Screw, timing train axle retaining bracket	M5	6 Nm (4.43 lbf ft)	Loctite® 243™
Screw, ignition pulse generator	M5	6 Nm (4.43 lbf ft)	Loctite® 243™
Screw, ignition pulse generator adapter	M5	6 Nm (4.43 lbf ft)	Loctite® 243™
Screw, stator cable holder	M5	6 Nm (4.43 lbf ft)	Loctite® 243™
Screw, bearing bolt of oil pump idler shaft	M5	6 Nm (4.43 lbf ft)	Loctite® 243™
Locking screw for bearing	M5	6 Nm (4.43 lbf ft)	Loctite® 243™
Screw, oil pump cover	M5	6 Nm (4.43 lbf ft)	Loctite® 243™
Screw, stator bracket	M5	6 Nm (4.43 lbf ft)	Loctite® 243™
Oil jet, timing chain tensioner	M6x0,6	6 Nm (4.43 lbf ft)	Loctite® 243™
Nut, water-pump wheel	M6	6 Nm (4.43 lbf ft)	Loctite® 243™
Nut, cylinder head	M6	10 Nm (7.38 lbf ft)	Engine oil (any)
Screw, exhaust flange	M6	10 Nm (7.38 lbf ft)	Loctite® 243™
Screw, starter motor	M6	10 Nm (7.38 lbf ft)	–
Screw, ignition pulse generator cable holder	M6	10 Nm (7.38 lbf ft)	Loctite® 243™
Screw, clutch cover	M6	10 Nm (7.38 lbf ft)	–
Screw, clutch spring	M6	10 Nm (7.38 lbf ft)	–
Screw, clutch slave cylinder	M6	10 Nm (7.38 lbf ft)	–
Screw, engine housing	M6	10 Nm (7.38 lbf ft)	–
Screw, oil filter cover	M6	10 Nm (7.38 lbf ft)	–
Screw, oil pump casing	M6	10 Nm (7.38 lbf ft)	Loctite® 243™
Screw, shift drum locating	M6	10 Nm (7.38 lbf ft)	Loctite® 243™
Screw, shift lever	M6	10 Nm (7.38 lbf ft)	Loctite® 243™
Screw, valve cover	M6	8 Nm (5.9 lbf ft)	–
Screw, water pump cover	M6	10 Nm (7.38 lbf ft)	–
Screw, ignition cover	M6	10 Nm (7.38 lbf ft)	–
Stud, cylinder head	M6	10 Nm (7.38 lbf ft)	–
Screw, clutch cover	M7x1	14 Nm (10.33 lbf ft)	–
Screw, engine housing	M7x1	14 Nm (10.33 lbf ft)	–
Screw, camshaft bearing bridge	M7x1	14 Nm (10.33 lbf ft)	Engine oil (any)
Plug, crankshaft location	M8	20 Nm (14.75 lbf ft)	–
Screw, unlocking of timing chain tensioner	M10x1	10 Nm (7.38 lbf ft)	–
Screw, camshaft gear	M10x1	50 Nm (36.88 lbf ft)	Engine oil (any)
Screw, ignition rotor	M10x1	80 Nm (59.01 lbf ft)	Engine oil (any)
Plug, oil channel	M10x1	10 Nm (7.38 lbf ft)	–
Plug, cam lever axle	M10x1	10 Nm (7.38 lbf ft)	–
Nut, cylinder head	M10x1,25	Tightening sequence: Tighten in diagonal sequence. Tightening stage 1 10 Nm (7.38 lbf ft) Tightening stage 2 30 Nm (22.13 lbf ft) Tightening stage 3 50°	Engine oil (any)

Stud, cylinder head	M10x1,25	20 Nm (14.75 lbf ft)	–
Screw, engine sprocket	M10	60 Nm (44.26 lbf ft)	Loctite® 243™
Spark plug	M10	10... 12 Nm (7.38... 8.85 lbf ft)	–
Screw-in studs for clutch cover	M12x1,5	20 Nm (14.75 lbf ft)	–
Oil drain plug with magnet	M12x1,5	20 Nm (14.75 lbf ft)	–
Axle guide rail for timing chain	M14x1	15 Nm (11.06 lbf ft)	–
Axle tension rail for timing chain	M14x1	15 Nm (11.06 lbf ft)	–
Nut, compensating sprocket	M14x1	20 Nm (14.75 lbf ft)	Loctite® 243™
Oil suction pipe	M14x1	15 Nm (11.06 lbf ft)	Loctite® 243™
Oil pressure regulator valve plug	M14x1,5	18 Nm (13.28 lbf ft)	–
Nut, inner clutch hub	M18x1,5	80 Nm (59.01 lbf ft)	Loctite® 243™
Plug, timing chain tensioner	M24x1,5	25 Nm (18.44 lbf ft)	–
Nut, freewheel hub	M27x1	80 Nm (59.01 lbf ft)	Loctite® 243™
Nut, primary gear	M27x1	80 Nm (59.01 lbf ft)	Loctite® 243™
Plug, oil screen	M32x1,5	30 Nm (22.13 lbf ft)	–

Carburetor type	KEIHIN FCR-MX 41
Carburetor identification number	4125I
Needle position	4th position from top
Idle mixture adjusting screw	
Open	1.5 turns
Pump membrane stop	2.15 mm (0.08 in)
Hot start button	
Diameter of bore in carburetor body	2.5 mm (0.1 in)
Main jet	185
Jet needle	OBDTR
Idling jet	42
Main air jet	200
Idle air jet	100
Cold start jet	85
Throttle slide	15

Frame	Central tube frame made of chrome molybdenum steel tubing	
Fork	WP 4860 MXMA CC	
Suspension travel		
front	280 mm (11.02 in)	
Rear	310 mm (12.2 in)	
Fork offset		
Front marking	14 mm (0.55 in)	
Rear marking	16 mm (0.63 in)	
Shock absorber	WP PDS 5018 DCC	
Brake system		
front	Single disc brake with radially screwed four-piston fixed caliper, floating brake disc	
Rear	Single disc brake with single-piston floating caliper, fixed brake disc	
Diameter of brake discs		
front	310 mm (12.2 in)	
Rear	220 mm (8.66 in)	
Wear limit of brake discs		
front	4.5 mm (0.18 in)	
Rear	3.5 mm (0.14 in)	
Tire air pressure		
front	1.6 bar (23.21 psi)	
Rear	1.6 bar (23.21 psi)	
Rear wheel gearing	14:48	
Chain	5/8 x 1/4"	
Rear sprockets available	38, 40, 42, 45, 48, 49, 50, 51, 52	
Steering head angle	63.5°	
Wheelbase	1475±10 mm (58.07±0.39 in)	
Seat height unloaded	920 mm (36.22 in)	
Ground clearance unloaded	300 mm (11.81 in)	
Weight without fuel	111.5 kg (245.81 lb.)	
Maximum permissible front axle load	145 kg (319.67 lb.)	
Maximum permissible rear axle load	190 kg (418.87 lb.)	
Maximum permissible overall weight	335 kg (738.54 lb.)	

3Ah battery	YTX4L-BS	Battery voltage: 12 V Nominal capacity: 3 Ah maintenance-free
4Ah battery	YTX5L-BS	Battery voltage: 12 V Nominal capacity: 4 Ah maintenance-free

Front tire	Rear tire
125/80 R 420 TL Dunlop KR106	170/55 R 17 TL Dunlop KR108
For further information, see: http://www.ktm.com	

Capacity - fuel

Tank capacity	8.2 l (2.17 US gal)	Super unleaded (ROZ 95 / RON 95 / PON 91) (☛ P. 82)
---------------	---------------------	---

Fork part number	14.18.7D.18
Fork	WP 4860 MXMA CC
Compression damping	
Standard	15 clicks
Rebound damping	
Standard	15 clicks
Spring length with preload spacer(s)	482 mm (18.98 in)
Spring rate	
Weight of rider: 65... 75 kg (143.3... 165.34 lb.)	4.6 N/mm (26.27 lb/in)
Weight of rider: 75... 85 kg (165.34... 187.39 lb.)	4.8 N/mm (27.41 lb/in)
Weight of rider: 85... 95 kg (187.39... 209.44 lb.)	5 N/mm (28.55 lb/in)
Gas pressure	1.2 bar (17.4 psi)
Fork length	920 mm (36.22 in)

Capacity - fork oil

Oil capacity / cartridge	195 ml (6.59 fl. oz.)	Fork oil (SAE 5) (☛ P. 82)
Oil capacity / fork tube without cartridge	390 ml (13.19 fl. oz.)	Fork oil (SAE 5) (☛ P. 82)

Shock absorber part number	12.18.7D.15
Shock absorber	WP PDS 5018 DCC
Compression damping, low-speed	
Standard	10 clicks
Compression damping, high-speed	
Standard	1.5 turns
Rebound damping	
Standard	20 clicks
Spring preload	11 mm (0.43 in)
Spring rate	
Weight of rider: 65... 75 kg (143.3... 165.34 lb.)	76 N/mm (433.97 lb/in)
Weight of rider: 75... 85 kg (165.34... 187.39 lb.)	80 N/mm (456.81 lb/in)
Weight of rider: 85... 95 kg (187.39... 209.44 lb.)	84 N/mm (479.65 lb/in)
Spring length	250 mm (9.84 in)
Gas pressure	10 bar (145.04 psi)
Static sag	15... 20 mm (0.59... 0.79 in)
Riding sag	80... 90 mm (3.15... 3.54 in)
Fitted length	403 mm (15.87 in)

Spoke nipple, front wheel	M4,5	5 Nm (3.69 lbf ft)	–
Spoke nipple, rear wheel	M5	5 Nm (3.69 lbf ft)	–
Remaining nuts, chassis	M6	15 Nm (11.06 lbf ft)	–
Remaining screws, chassis	M6	10 Nm (7.38 lbf ft)	–
Screw, rear brake disc	M6	14 Nm (10.33 lbf ft)	–
Screw, front brake disc	M6	14 Nm (10.33 lbf ft)	–
Screw, shock absorber adjusting ring	M6	5 Nm (3.69 lbf ft)	–
Screw, ball joint of push rod on foot-brake cylinder	M6	10 Nm (7.38 lbf ft)	–
Nut, rear sprocket screw	M8	35 Nm (25.82 lbf ft)	Loctite® 243™
Nut, rim lock	M8	10 Nm (7.38 lbf ft)	–
Remaining nuts, chassis	M8	30 Nm (22.13 lbf ft)	–
Remaining screws, chassis	M8	25 Nm (18.44 lbf ft)	–
Screw, top triple clamp	M8	17 Nm (12.54 lbf ft)	–
Screw, bottom triple clamp	M8	12 Nm (8.85 lbf ft)	–
Screw, fork stub	M8	15 Nm (11.06 lbf ft)	–
Screw, top steering stem	M8	17 Nm (12.54 lbf ft)	Loctite® 243™
Screw, handlebar clamp	M8	20 Nm (14.75 lbf ft)	–
Screw, engine brace	M8	33 Nm (24.34 lbf ft)	–
Screw, subframe	M8	35 Nm (25.82 lbf ft)	Loctite® 243™
Screw, front brake caliper	M10x1,25	40 Nm (29.5 lbf ft)	Loctite® 243™
Engine carrying screw	M10	60 Nm (44.26 lbf ft)	–
Remaining nuts, chassis	M10	50 Nm (36.88 lbf ft)	–
Remaining screws, chassis	M10	45 Nm (33.19 lbf ft)	–
Screw, handlebar support	M10	40 Nm (29.5 lbf ft)	Loctite® 243™
Nut, seat fixing	M12x1	20 Nm (14.75 lbf ft)	–
Screw, top shock absorber	M12	80 Nm (59.01 lbf ft)	Loctite® 243™
Screw, bottom shock absorber	M12	80 Nm (59.01 lbf ft)	Loctite® 243™
Nut, swingarm pivot	M16x1,5	100 Nm (73.76 lbf ft)	–
Screw-in nozzles, cooling system	M20x1,5	12 Nm (8.85 lbf ft)	Loctite® 243™
Nut, rear wheel spindle	M20x1,5	80 Nm (59.01 lbf ft)	–
Screw, top steering head	M20x1,5	10 Nm (7.38 lbf ft)	–
Screw, bottom steering head	M20x1,5	60 Nm (44.26 lbf ft)	Loctite® 243™
Screw, front wheel spindle	M24x1,5	40 Nm (29.5 lbf ft)	–

Wiring diagram

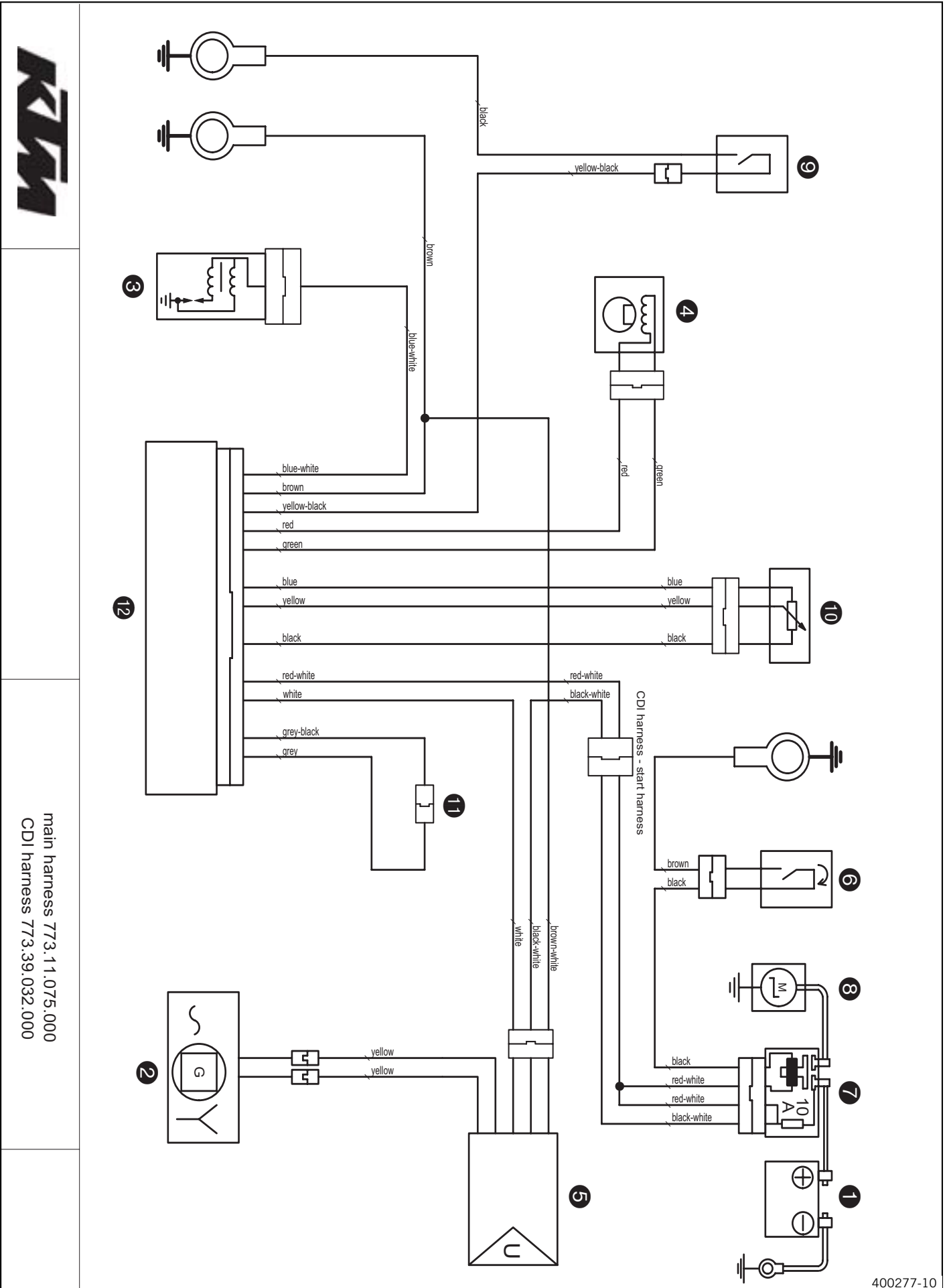

main harness 773.11.075.000
CDI harness 773.39.032.000

Components

1	Battery
2	Generator
3	Ignition coil
4	Pulse generator
5	Voltage regulator/rectifier
6	Starter button
7	Starter relay
8	Starter motor
9	Short circuit button
10	Throttle valve sensor TPS
11	Ignition curve plug connection
12	CDI controller

Cable colors

black	black
black-white	black-white
brown	brown
brown-white	brown-white
blue	blue
blue-white	blue-white
green	green
grey	gray
grey-black	gray-black
red	red
red-white	red-white
white	white
yellow	yellow
yellow-black	yellow-black

Super unleaded (ROZ 95 / RON 95 / PON 91)

according to

- DIN EN 228 (ROZ 95 / RON 95 / PON 91)

Brake fluid DOT 5.1

according to

- DOT

Specification

- Use only brake fluid that complies with the specified standards (see specifications on the container) and that possesses the corresponding properties. KTM recommends **Motorex®** products.

Supplier

Motorex

- **Motorex® Brake Fluid DOT 5.1**

Coolant

Specification

- Use only suitable coolant (even in countries with high temperatures). Using inferior antifreeze can result in corrosion and foaming. KTM recommends **Motorex®** products.

Mixture ratio

Antifreeze: -25... -45 °C (-13... -49 °F)	50 % Anti-corrosion/antifreeze 50 % distilled water
---	--

Coolant (mixed ready to use)

Antifreeze	-40 °C (-40 °F)
------------	-----------------

Supplier

Motorex

- **Motorex® Anti Freeze**

Hydraulic fluid (15)

according to

- ISO VG (15)

Specification

- Use only hydraulic fluid that complies with the specified standards (see specifications on the container) and that possesses the corresponding properties. KTM recommends **Motorex®** products.

Supplier

Motorex

- **Motorex® Hydraulic Fluid 75**

Engine oil (SAE 10W/50)

according to

- JASO T903 MA (☛ P. 86)
- SAE (☛ P. 86) (SAE 10W/50)

Specification

- Use only engine oils that comply with the specified standards (see specifications on the container) and that possess the corresponding properties. KTM recommends **Motorex®** products.

Synthetic engine oil

Supplier

Motorex

- **Motorex® Cross Power 4T**

Fork oil (SAE 5)

according to

- SAE (SAE 5)

Specification

- Use only oils that comply with the specified standards (see specifications on the container) and that possesses the corresponding properties. KTM recommends **Motorex®** products.

Supplier

Motorex

- **Motorex® Racing Fork Oil**

Universal oil spray**Specification**

- KTM recommends **Motorex®** products.

Supplier

Motorex

- **Motorex® Joker 440 Universal**

Long-life grease**Specification**

- KTM recommends **Motorex®** products.

Supplier

Motorex

- **Motorex® Long Therm 2000**

Chain cleaner**Specification**

- KTM recommends **Motorex®** products.

Supplier

Motorex

- **Motorex® Chain Clean 611**

Offroad chain spray**Specification**

- KTM recommends **Motorex®** products.

Supplier

Motorex

- **Motorex® Chain Lube 622**

Air filter cleaner**Specification**

- KTM recommends **Motorex®** products.

Supplier

Motorex

- **Motorex® Twin Air Dirt Bio Remover**

Air filter oil**Specification**

- KTM recommends **Motorex®** products.

Supplier

Motorex

- **Motorex® Air Filter Oil Spray 655**

Motorcycle cleaner**Specification**

- KTM recommends **Motorex®** products.

Supplier

Motorex

- **Motorex® Moto Clean 900**

Cleaning and polishing materials for metal, rubber and plastic**Specification**

- KTM recommends **Motorex®** products.

Supplier

Motorex

- **Motorex® Protect & Shine 645**

High-luster polish for paint

Specification

- KTM recommends **Motorex®** products.

Supplier

Motorex

- **Motorex® Moto Polish**

Contact spray

Specification

- KTM recommends **Motorex®** products.

Supplier

Motorex

- **Motorex® Accu Contact**

JASO T903 MA

Different technical development directions required a new specification for 4-stroke motorcycles – the JASO T903 MA Standard. Earlier, engine oils from the automobile industry were used for 4-stroke motorcycles because there was no separate motorcycle specification. Whereas long service intervals are demanded for automobile engines, high performance at high engine speeds are in the foreground for motorcycle engines. With most motorcycles, the gearbox and the clutch are lubricated with the oil as the engine. The JASO MA Standard meets these special requirements.

SAE

The SAE viscosity classes were defined by the Society of Automotive Engineers and are used for classifying oils according to their viscosity. The viscosity describes only one property of oil and says nothing about quality.

A

Accessories 5

Air filter

 cleaning 59

 fitting 59

 removing 58

Air filter box lid

 fitting 58

 removing 58

Antifreeze

 checking 55

B

Basic chassis setting

 checking with rider's weight 21

Battery

 fitting 50

 recharging 51

 removing 50

Brake calipers 38

Brake discs

 checking 38

Brake fluid

 of rear brake, adding 44

 Topping up brake fluid of front brake 40

Brake fluid level

 Checking the front brake brake fluid level 39

 of rear brake, checking 43

Brake linings

 Changing the front brake linings 42

 Mounting front brake linings 41

 of front brake, checking 40

 of rear brake, changing 46

 of rear brake, checking 44

 of rear brake, installing 45

 of rear brake, removing 45

 Removing front brake linings 41

C

Carburetor

 adjusting idle 61

 emptying the float chamber 62

 idle 61

Chain

 cleaning 34

Chain guide

 adjusting 38

Chain tension

 adjusting 36

 checking 34

Chain wear

 checking 35

Chassis number 9

Choke 11

Cleaning 68

Clutch

 changing fluid 60

 checking fluid level 60

Clutch lever 10

 adjusting basic position 59

Compression damping

 fork, adjusting 25

Compression damping, high-speed

 of shock absorber, adjusting 21

Compression damping, low-speed

 of shock absorber, adjusting 22

Coolant

 draining 56

 refilling 56

Coolant level

 checking 55

Cooling system 55

D

Dust boots

 Cleaning, of fork legs 26

E

Electric starter button 10

Engine

 running in 14

Engine number 9

Engine oil

 changing 63

 draining 63

 refilling 64

 topping up 65

Engine oil level

 checking 62

Environment 5

F

Filler cap

 closing 11

 opening 11

Filling up

 Fuel 17

Foot brake pedal 12

 adjusting basic position 43

 checking free play 43

Fork

 checking basic setting 25

Fork legs

 bleeding 26

 fitting 29

 removing 29

Fork offset 28

 setting 29

Fork protector

 fitting 27

 removing 27

Front fender

 fitting 31

 removing 31

Front wheel

 fitting 47

 removing 46

- Fuel tank**
 fitting 54
 removing 53
- Fuel tap** 11
- Fuel, oils, etc.** 5
- Fuse**
 fitting 52
 removing 52
- G**
- Gas Bowden cable route**
 checking 33
- H**
- Hand brake lever** 10
 adjusting basic position 39
 checking free play 39
- Handlebar position** 32
 adjusting 32
- Hot start lever** 10
- I**
- Ignition curve**
 Changing 52
 Plug connection 52
- L**
- Lower triple clamp**
 fitting 30
 removing 30
- M**
- Main silencer**
 changing glass fiber yarn filling 58
 fitting 57
 Fitting glass fiber yarn filling 58
 removing 57
 Removing glass fiber yarn filling 57
- Maintenance** 5
- Motorcycle**
 cleaning 68
- O**
- Oil filter**
 changing 63
 fitting 64
 removing 64
- Oil screen**
 cleaning 63
- OWNER'S MANUAL** 6
- P**
- Play in gas Bowden cable**
 adjusting 33
 checking 33
- Plug-in stand** 12
- Putting into operation**
 Advice on first use 13
 after storage 69
 Checks before putting into operation 15
- R**
- Rear sprocket / engine sprocket**
 checking for wear 35
- Rear wheel**
 fitting 48
 removing 48
- Rebound damping**
 fork, adjusting 26
 of shock absorber, adjusting 22
- Riding sag**
 adjusting 24
- S**
- Seat**
 mounting 53
 removing 53
- Shift lever** 12
- Shock absorber**
 checking riding sag 23
 checking static sag 23
 fitting 25
 removing 25
- Short circuit button** 10
- Spare parts** 5
- Spoke tension**
 checking 50
- Spring preload**
 of shock absorber, adjusting 24
- Start number plate**
 dismantling 32
 fitting 32
- Starting** 15
- Steering head bearing**
 greasing 31
- Steering head bearing play**
 adjusting 28
 checking 27
- Storage** 69
- T**
- Technical data**
 Carburetor 73
 Chassis 74-75
 Chassis tightening torques 78
 Engine 70
 Engine tightening torques 71-72
 Fork 76
 Shock absorber 77
- Tire air pressure**
 checking 49
- Tire condition**
 checking 49
- Transport** 5
- Troubleshooting** 66-67
- Type label** 9
- W**
- Warranty** 5
- Wiring diagram** 80-81



3211243en



9/2007 Photo Mitterbauer



KTM-Sportmotorcycle AG
5230 Mattighofen/Austria
<http://www.ktm.com>

Free Manuals Download Website

<http://myh66.com>

<http://usermanuals.us>

<http://www.somanuals.com>

<http://www.4manuals.cc>

<http://www.manual-lib.com>

<http://www.404manual.com>

<http://www.luxmanual.com>

<http://aubethermostatmanual.com>

Golf course search by state

<http://golfingnear.com>

Email search by domain

<http://emailbydomain.com>

Auto manuals search

<http://auto.somanuals.com>

TV manuals search

<http://tv.somanuals.com>