

User's Manual

CAMILEO P20

Introduction

Welcome and thank you for choosing a TOSHIBA product.

For your convenience, your TOSHIBA product is furnished with two guides:

a) a Quick Start Guide, and

b) this comprehensive PDF User's Manual.

Contents

Section 1 Getting to Know Your Camcorder	6
Overview	6
Check the Components	6
Safety Instructions	7
System Requirements	7
Front View	8
Rear View	8
Side View	9
Bottom View	9
Section 2 Getting Started	10
Loading the Battery	10
Inserting and Removing an SD Card (Optional)	10
Turning the Camcorder On and Getting Started	11
Turning the Camcorder Off	11
Section 3 Record Mode	12
Button Function	12
LCD Monitor Information	13
Video Recording	15
Photo Recording	16
Taking Close up Photos/Videos	16
Using Digital Zoom	16
Options for Menu	17
Operations	17
Video Setting	18
Photo Setting	22
Effects	25
Delete	27

Contents

Section 4 Playback Mode.....	29
Button Function	29
LCD Monitor Information.....	30
Operations for Playback Mode	32
Video Playback.....	33
Photo Playback	33
Delete File in Playback Mode.....	33
Section 5 Setting Your Camcorder	34
Setup Menu.....	34
Section 6 Viewing Photos and Videos on TV.....	37
Connecting to a High-Definition 16:9(Wide) TV	37
Connecting to a non-high-definition 4:3 TV	37
Section 7 Viewing Video & Photo on PC	38
Installing Bundled Software.....	38
Transferring Photos or Videos to a Computer	38
Section 8 Uploading Files to Internet.....	39

Contents

Section 9 Specifications	42
Section 10 Troubleshooting	43
Section 11 Other Information	44
TOSHIBA Support	44
Operating Environment Conditions	44
Regulatory Information	44
Additional Information.....	46
About the battery pack	46

Section 1

Getting to Know Your Camcorder

Overview

The camcorder with 5 Mega Pixel sensor can take H.264 videos. By way of using H.264 technology, more videos can be taken within certain amount of memory. High quality images with up to 16 megapixels can also be delivered smoothly. With a color LCD monitor, users can compose images and examine them easily.

The camcorder features 3" LCD touch panel which is an ideal platform for you to operate your camcorder. The menu options are accessible with your finger. With the touch panel, you can select the options directly and quickly.

The camcorder also features video recording at HD resolution of 1920x1080. You can also connect it to an HDTV via an HDMI cable, and easily playback the recorded high-definition videos on the wide screen HDTV.

Moreover, the camcorder has an advanced uploading feature. With the exclusive built-in **CAMILEO UPLOADER** application, you can upload the videos or photos captured by the camcorder to Internet more effortlessly.

ISO sensitivity and color balance can either be adjusted automatically or changed manually. A 16x digital zoom helps you to control over the videos and photos you take.

The varied effect options, such as Time Lapse and Slow Motion, make recording more fun.

The built-in memory allows you to take photos and to record videos without a memory card. The memory card slot allows users to increase the storage capacity.



Note

- Partial memory of the built-in memory is used for the camcorder's Firmware code.
- Install the bundled software application for viewing the videos correctly on a PC.

Check the Components

Unpack the package and make sure all standard accessories listed are included:



Camcorder

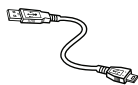

USB Cable

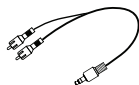

AV Cable

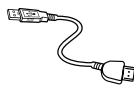

HDMI Cable



AC-Adaptor

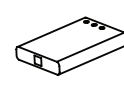

Lithium-ion
Rechargeable
Battery*



MAGIX DVD
(Video Deluxe
Trial Version)
(Optional)



Quick Start
Guide



CD-ROM
(Software &
User's Manual)



Cleaning Cloth



Strap



Pouch



Tripod



Warranty
Leaflet

*preinstalled in camcorder device



Note

Please remove the lens protect film on lens before use.

Safety Instructions

1. Do not drop, puncture or disassemble the camcorder; otherwise the warranty will be voided.
2. Avoid all contact with water, and dry hands before using.
3. Do not expose the camcorder to high temperature or leave it in direct sunlight. Doing so may damage the camcorder.
4. Use the camcorder with care. Avoid pressing hard on the camcorder body.
5. For your own safety, avoid using the camcorder when there is a storm or lightning.
6. Do not use batteries of different specifications. Doing so may lead to the potential for serious damage.
7. Remove the battery during long periods between usage, as a deteriorated battery may affect the functionality of the camcorder.
8. Remove the battery if it shows signs of leaking or distortion.
9. Use only the accessories supplied by the manufacturer.
10. Keep the camcorder out of the reach of infants.
11. Risk of explosion if battery is replaced by an incorrect type.
12. Dispose of used batteries according to the instructions.

System Requirements

- Microsoft Windows XP/Vista/7
- Intel Pentium 4, 2.4GHz or above
- 512 MB RAM
- CD-ROM Drive
- 1 GB free HDD space
- Available USB port
- 16-bit Color Display



Note

The LCD screen is manufactured using extremely high-precision technology. However, some tiny black and/or bright dots (white, red, blue or green) may appear on the LCD screen. These dots are a normal result of the manufacturing process, and do not affect the recording.

Front View

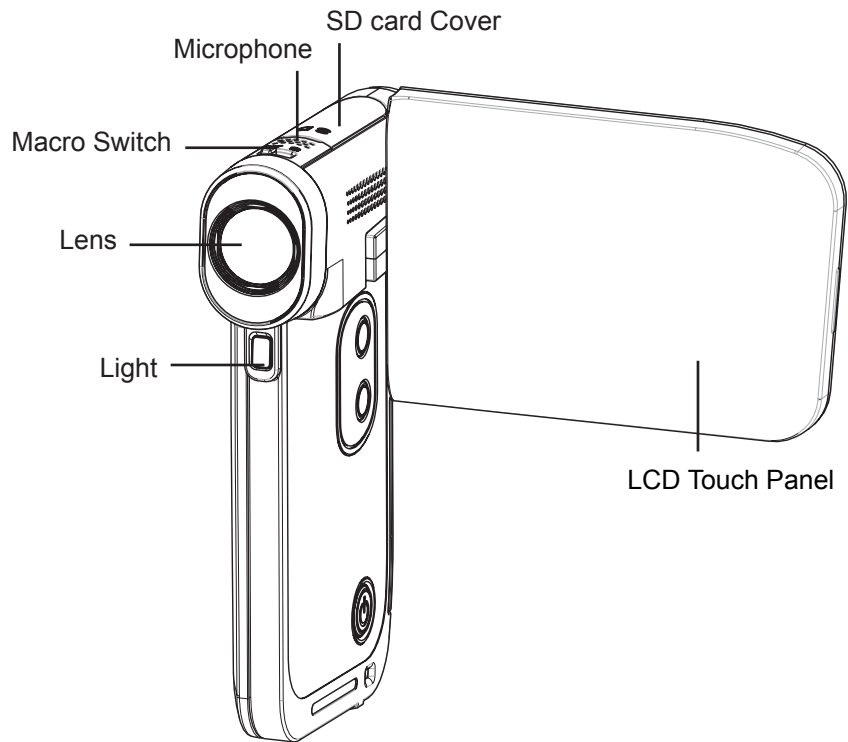

Rear View

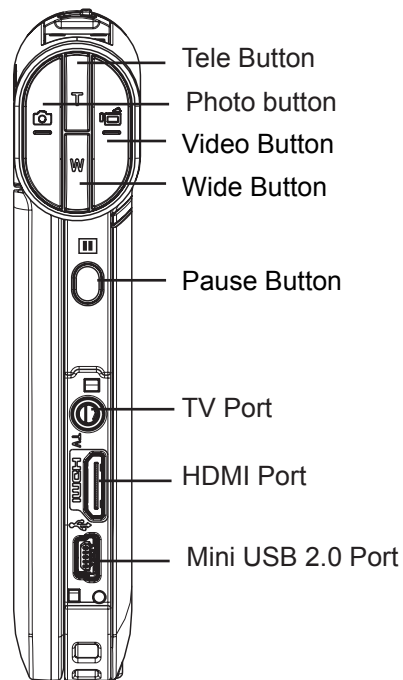

Side View

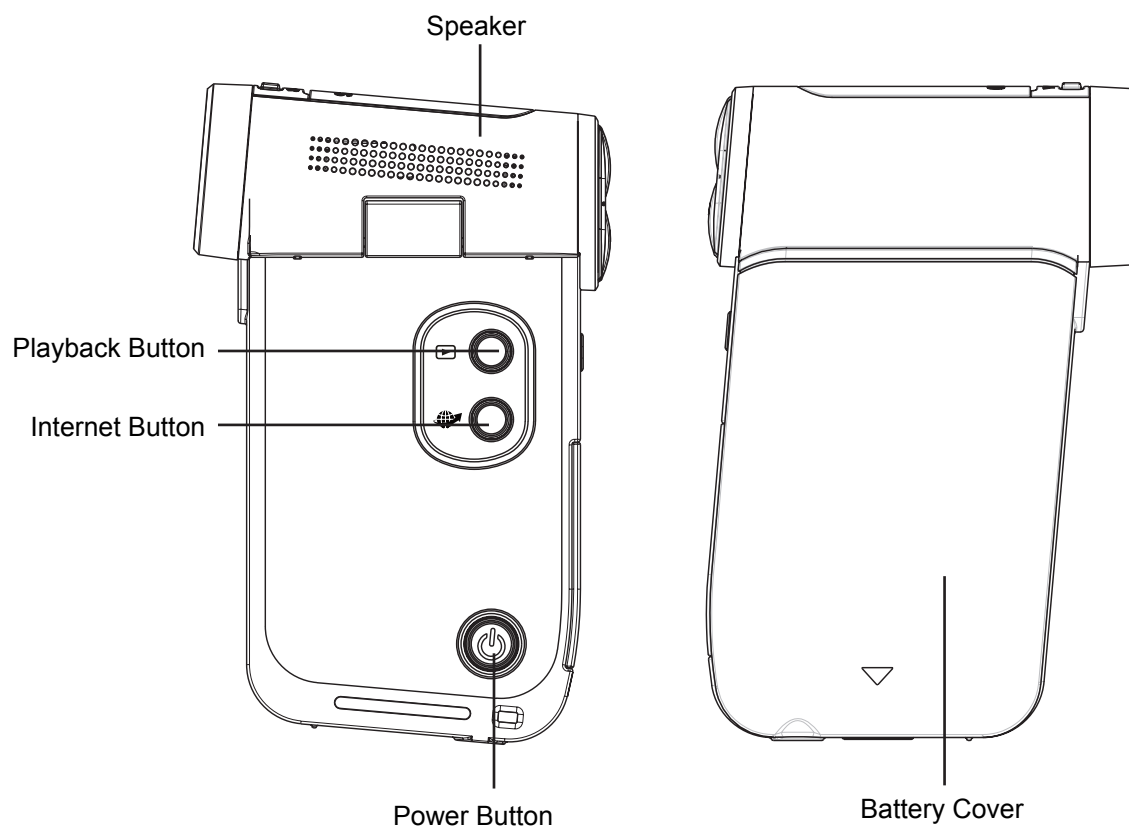

Bottom View

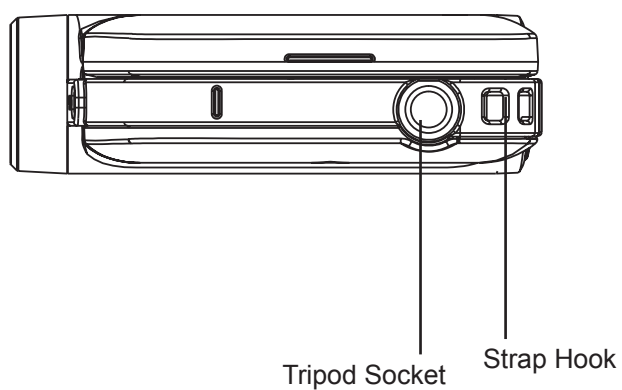

Section 2 Getting Started

Loading the Battery

Before using the camcorder, users must load the Lithium-ion rechargeable battery come within the package.

1. Insert the battery according to the correct polarity marks (+ or -).
2. Close the battery cover firmly.

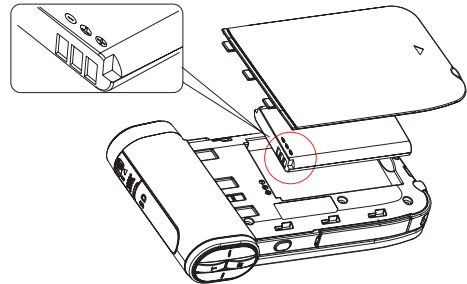

Note

- Please take out the battery from the camcorder and remove the insulator on the battery connection before use.

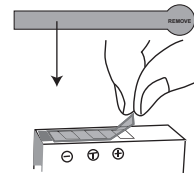

Inserting and Removing an SD Card (Optional)

The camcorder comes with an internal memory which allows you to store photos and videos. You can expand the memory capacity by using an optional SD memory card.

1. Insert the memory card into the slot. Please refer to the figure on the right side.
2. To remove an installed SD card, press the card inwards to release it.
3. When the card pops out, gently remove it from its slot.
4. Recommended memory capacity: 1GB or above.

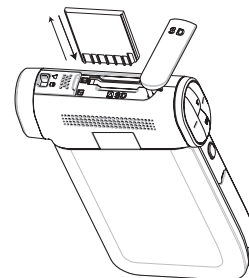

Note

- When a memory card is fitted, videos/photos are saved on the card rather than on the built-in memory.
- *Protecting Data on an SD Card: SD Card is read-only when it is locked. No photos or videos can be recorded when the SD card is locked. Make sure the lock is on the writeable position before recording any media.*

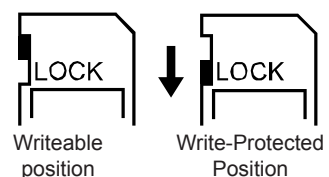

Turning the Camcorder On and Getting Started







- To turn on the camcorder:
 1. Flip out the LCD panel; the camcorder will turn on automatically.
 2. Or press [Power Button] for one second to turn it on.
- To record videos: Press [Video Button] to record videos. To stop recording, press it again.
- To pause recording: Press [Pause Button] to pause recording. To continue the recording, press it again.
- To take a photo: Press [Photo button] to take photos.
- To view stored videos and photos: Press [Playback Button] or touch  (on-screen icon) to switch to the Playback mode.

Turning the Camcorder Off

- To turn off the camcorder: You can either press [Power Button] for one second, or you can place the LCD panel back to its original position.

Section 3 Record Mode

Button Function

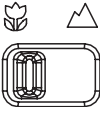





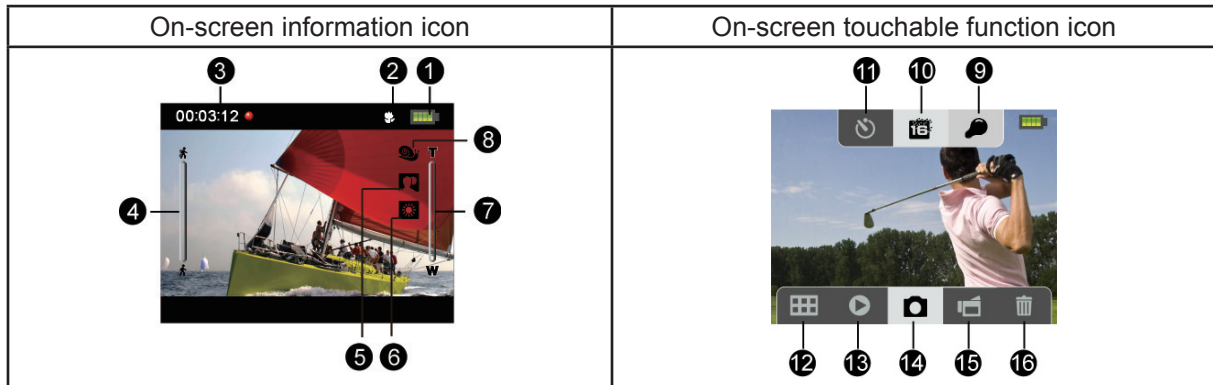













	<p>Video Button:</p> <ol style="list-style-type: none"> 1. Press to take videos. 2. To stop recording, press it again.
	<p>Photo button:</p> <ol style="list-style-type: none"> 1. Press to take photos.
	<p>Tele Button:</p> <ol style="list-style-type: none"> 1. Zoom In. <p>Wide Button:</p> <ol style="list-style-type: none"> 1. Zoom out.
 	<p>Pause Button:</p> <ol style="list-style-type: none"> 1. Press to pause the recording. 2. To continue the recording, press it again.
	<p>Power Button:</p> <ol style="list-style-type: none"> 1. Press down for one second to turn on or turn off the camcorder.
	<p>Playback Button:</p> <ol style="list-style-type: none"> 1. Switch to the Playback Mode.
	<p>Macro Switch:</p> <ol style="list-style-type: none"> 1. Switch between Macro Mode and Normal Mode.





LCD Monitor Information

The indicators shown below may display on LCD when videos and photos are recorded:



(1)		Battery: full power
		Battery: medium power
		Battery: low power
		Battery: empty power
		DC power mode
(2)		Macro Position Focusing
(3)	00:03:12	Recording time
	00:03:12	Pause recording
	250	The amount of photos that can still be taken at current resolution
	▲ 321	Number of current photo
(4)		Motion Detection (Video Record Mode Only)
(5)	Scene	
		Skin
		Night
		Backlight

(6)	Manual White Balance	
		Daylight
		Fluorescent
		Tungsten
(7)		Zoom meter: 1X~16x (16x Digital zoom)
(8)		Slow Motion (Video Record Mode Only)
		Time Lapse (Video Record Mode Only)
		Pre-Record Mode (Video Record Mode Only)
(9)		Digital Light On
		Light On
		Light Off
(10)	Video Resolution	
		Full HD (1080p 30)
		HD60 (720p 60)
		HD30 (720p 30)
		VGA
		QVGA (When Slow Motion function is activated, the video resolution is 320x240(QVGA).)
	Photo Resolution	
		High-16M
		Standard-5M
		Low-3M
(11)	Video Record Mode	
		Stabilization On/ Off
	Photo Record Mode	
		Self-timer On/ Off

(12)		Menu On
(13)		Playback Mode On
(14)		Photo Mode On
(15)		Video Mode On
(16)		Delete Mode On



Note

- Tap on the screen to close the touchable function bars. Tap again to show the bars.
- Filter: Black&White / Classic / Negative can be previewed immediately without the indicator on the LCD screen.
- Stabilization, Time Lapse, and Slow Motion functions can not be used simultaneously.
- Motion Detect, Time Lapse, and Slow Motion functions can not be used simultaneously.

Video Recording

- Press [Video Button] to start recording. When a video is being recorded, a time indicator will display on the LCD monitor. To stop recording, press [Video Button] again.
- To pause recording: Press [Pause Button] to pause recording. To continue the recording, press it again.
- Press [Playback Button] to view the recorded videos.
- Four resolution settings are available:









Video Quality	
	FHD: 1920x1080p 30
	HD60: 1280x720p 60
	HD30: 1280x720p 30
	VGA: 640x480p 30

Photo Recording

- Press [Photo button] to take photos.
- Press [Playback Button] to view the photos.
- Three resolution settings are available:

Image Quality	
	High-16 Mega Pixels: 4608 x 3456
	Standard-5 Mega Pixels: 2592 x 1944
	Low-3 Mega Pixels: 2048 x 1536

Taking Close up Photos/Videos

- Slide the macro switch to change the focus range for different distances of objects.
- To take close-up photos:
 1. Slide the macro switch to Macro ().
 2. Press [Video Button] to start recording or press [Photo button] to take photo.
- In Macro Mode, the macro icon () will appear on the LCD monitor.







Note

Remember to turn the macro switch back to Normal () when you are not taking close-up photos.

Using Digital Zoom



- The digital zoom magnifies images when recording videos or taking photos.
 1. To zoom in/out, press the Tele/Wide Button.
 2. The digital zoom can be set from 1x to 16x.

Options for Menu



Video Setting	Photo Setting	Effects	Setup*	Delete
				
<ul style="list-style-type: none"> • Light • Resolution • Stabilization • Motion Detect • Slow Motion • Pre-Record • Time Lapse • Continuous Play 	<ul style="list-style-type: none"> • Light • Resolution • Self-Timer • ISO • Slideshow 	<ul style="list-style-type: none"> • Scene • Filter • White Balance 	<ul style="list-style-type: none"> • Sound • TV • Language • Time Setting • Format • Default Setting 	<ul style="list-style-type: none"> • Delete Video • Delete Photo • Delete Video & Photo • Delete All

* Please refer to Section 5 for the detailed information about [Setup].

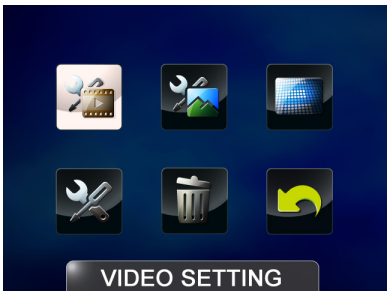
Operations

Operation	Screen
<p>1. Touch  on the screen. The main menu will show on the screen.</p>	
<p>2. The options are Video Setting, Photo Setting, Effects, Setup, and Delete. Touch the desired icon twice on the screen.</p> <p>3. The option menu will pop up on the screen.</p> <p>4. Touch to select the specific option you want to adjust and touch again to enter its setting menu.</p> <p>5. Touch twice to validate the setting.</p> <p>6. Or touch the Exit icon () to exit.</p>	



Video Setting

Operation	Display Screen
<ol style="list-style-type: none"> 1. Touch  on the screen. The main menu will show on the screen. 2. Touch the [Video Setting ] icon twice on the screen to enter its setting menu. 3. The Video Setting menu contains 8 options-- Light, Resolution, Stabilization, Motion Detect, Slow Motion, Pre-Record, Time Lapse, and Continuous Play --for you to adjust the camcorder settings. 	



Light

You can select the mode to brighten the area or to extend the brightness of the objects.

	On	The light will be turned on and provides light when recording.
	Off	The light is turned off.
	Digital Light	Extend the dynamic range for backlight and high contrast sense, so that the objects will be brighter and clearer.

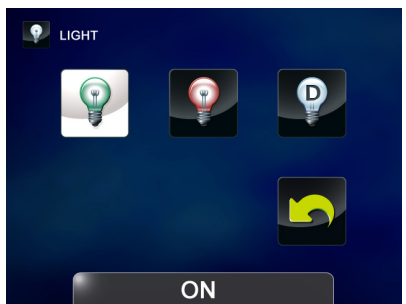
Operation	Display Screen
<ol style="list-style-type: none"> 1. In the Video Setting menu, touch the [Light] icon twice on the screen. 2. Touch to select the desired option. 3. Touch again to validate the setting. 4. Or touch the Exit icon () to exit. 	



Resolution

Four resolution settings are available.

	Full HD	Record videos at 1920x1080p 30 resolution.
	HD 60	Record videos at 1280x720p 60 resolution.
	HD 30	Record videos at 1280x720p 30 resolution.
	VGA	Record videos at 640x480p 30 resolution.

Operation	Display Screen
<ol style="list-style-type: none"> 1. In the Video Setting menu, touch the [Resolution] icon twice on the screen. 2. Touch to select the desired option. 3. Touch again to validate the setting. 4. Or touch the Exit icon () to exit. 	<p>The screen displays the 'RESOLUTION' menu with four options: Full HD, HD 60, HD 30, and VGA. The 'FULL HD' option is highlighted with a grey bar at the bottom.</p>



Stabilization

Record with an effect of reducing camcorder shake to result in more stable videos.

Operation	Display Screen
<ol style="list-style-type: none"> 1. In the Video Setting menu, touch the [Stabilization] icon twice on the screen. 2. Touch to select the desired option. 3. Touch again to validate the setting. 4. Or touch the Exit icon () to exit. 	<p>The screen displays the 'STABILIZATION' menu with two options: ON and OFF. The 'ON' option is highlighted with a grey bar at the bottom.</p>



Motion Detection



Record videos automatically when the camcorder detects a movement.

Operation	Display Screen
<ol style="list-style-type: none"> 1. In the Video Setting menu, touch the [Motion Detect] icon twice on the screen. 2. Touch to select the desired option. 3. Touch again to validate the setting. 4. Or touch the Exit icon () to exit. 5. Camcorder will start to record video automatically if it detects a movement. Stop recording if it does not detect a movement. 	<p>The screen displays the 'MOTION DETECT' menu with two options: ON and OFF. The 'ON' option is highlighted with a grey bar at the bottom.</p>



Slow Motion

Record videos with slow motion effect. When the video is played, the playback time will be longer than the actual recording time.

Operation	Display Screen
<ol style="list-style-type: none"> 1. In the Video Setting menu, touch the [Slow Motion] icon twice on the screen. 2. Touch to select the desired option. 3. Or touch the Exit icon () to exit. 	



Pre-Record

The Pre-record function ensures that you will not miss any critical recording opportunities. The videos are recorded 1 second more before the [Video Button] is pressed.

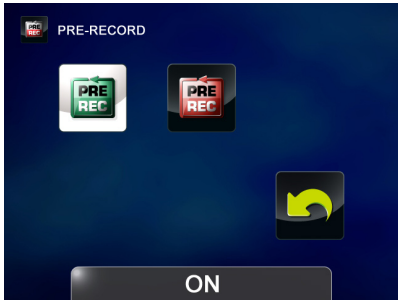
Operation	Display Screen
<ol style="list-style-type: none"> 1. In the Video Setting menu, touch the [Pre-Record] icon twice on the screen. 2. Touch to select the desired option. 3. Touch again to validate the setting. 4. Or touch the Exit icon () to exit. 	



Note

- Be sure to aim the camcorder at the subject and position it securely.



Time Lapse

Record still images at specific intervals you can set and play them as one video file.

	Off	Disable Time Lapse.
	1 Second	Record one frame per second.
	3 Seconds	Record one frame every 3 seconds.
	5 Seconds	Record one frame every 5 seconds.

Operation	Display Screen
<ol style="list-style-type: none"> In the Video Setting menu, touch the [Time Lapse] icon twice on the screen. Touch to select the desired option. Touch again to validate the setting. Or touch the Exit icon () to exit. 	



Note

- *Motion Detect, Time Lapse, and Slow Motion functions can not be used simultaneously.*





Continuous Play

Playback the files continuously.

Operation	Display Screen
<ol style="list-style-type: none"> In the Video Setting menu, touch the [Continuous Play] icon twice on the screen. Touch to select the desired option. Touch again to validate the setting. Or touch the Exit icon () to exit. 	



Photo Setting

Operation	Display Screen
<ol style="list-style-type: none"> 1. Touch  on the screen. The main menu will show on the screen. 2. Touch the [Photo Setting ] icon twice on the screen to enter its setting menu. 3. The Photo Setting menu contains 5 options-- Light, Resolution, Self-Timer, ISO, and Continuous Play--for you to adjust the camcorder settings. 	



Light



You can select the mode to brighten the area or to extend the brightness of the objects.

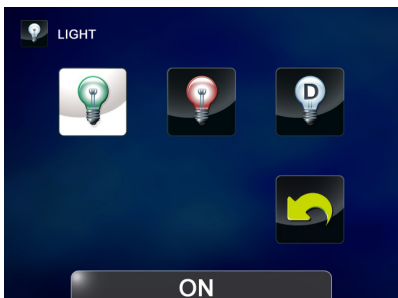

	On	The light will be turned on and provides light when recording.
	Off	The light is turned off.
	Digital Light	Extend the dynamic range for backlight and high contrast sense, so that the objects will be brighter and clearer.

Operation	Display Screen
<ol style="list-style-type: none"> 1. In the Photo Setting menu, touch the [Light] icon twice on the screen. 2. Touch to select the desired option. 3. Touch again to validate the setting. 4. Or touch the Exit icon () to exit. 	

Resolution

Three resolution settings are available.

	High-16M	Shoot photo at 4608 x 3456, 16 Mega Pixels quality.
	Standard-5M	Shoot photo at 2592 x 1944, 5 Mega Pixels quality.
	Low-3M	Shoot photo at 2048 x 1536, 3 Mega Pixels quality.

Operation	Display Screen
<ol style="list-style-type: none"> In the Photo Setting menu, touch the [Resolution] twice icon on the screen. Touch to select the desired option. Touch again to validate the setting. Or touch the Exit icon () to exit. 	



Self-Timer

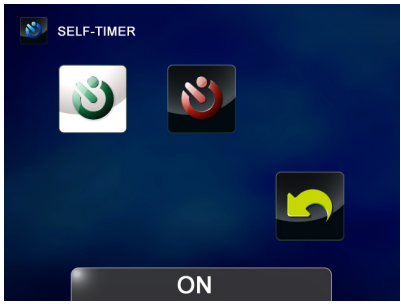

The self-timer allows you to take photos with a ten-second time delay. The self-timer light on the front of the camcorder will also blink. The speed of blinking will increase just before the photo is taken.

Operation	Display Screen
<ol style="list-style-type: none"> In the Photo Setting menu, touch the [Self-Timer] icon twice on the screen. Touch to select the desired option. Touch again to validate the setting. Or touch the Exit icon () to exit. 	

ISO

The camcorder adjusts the ISO sensitivity of its images automatically. Two manual ISO sensitivity settings are available. (800/1600). The larger the number is, the higher the ISO sensitivity is set to. Select a small number to shoot a smoother image. Select a large number to shoot an image in a dark location or to shoot a subject moving at high speed.

	Auto	Set the ISO sensitivity automatically.
	800	ISO 800
	1600	ISO 1600

Operation	Display Screen
<ol style="list-style-type: none"> In the Photo Setting menu, touch the [ISO] icon twice on the screen. Touch to select the desired option. Touch again to validate the setting. Or touch the Exit icon () to exit. 	







Note

The image may become noisy when the ISO number is large.





Slideshow

Display photos one after another in turn.

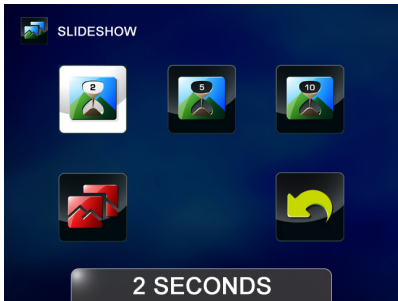
	2 Seconds	Display one photo every 2 seconds
	5 Seconds	Display one photo every 5 seconds
	10 Seconds	Display one photo every 10 seconds
	OFF	Disable Slideshow

Operation	Display Screen
<ol style="list-style-type: none"> In the Photo Setting menu, touch the [Continuous Play] icon twice on the screen. Touch to select the desired option. Touch again to validate the setting. Or touch the Exit icon () to exit. 	



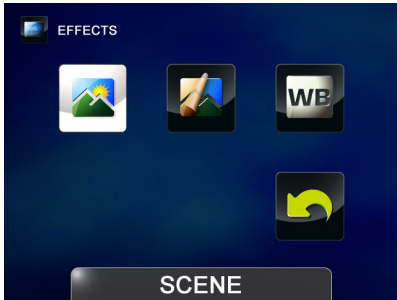

Effects

Operation	Display Screen
<ol style="list-style-type: none"> 1. Touch  on the screen. The main menu will show on the screen. 2. Touch the [Effects ] icon twice on the screen to enter its setting menu. 3. The Effects menu contains 3 options-- Scene, Filter, and White Balance --for you to adjust the camcorder settings. 	



Scene

You can select the mode according to the scene condition.

	Auto	Automatic adjustment
	Skin	Shoot with an effect that makes skin tones more natural.
	Night	Use Night Mode for night scenes or low light conditions.
	Backlight	You can take shots when the bright light is behind the subject.

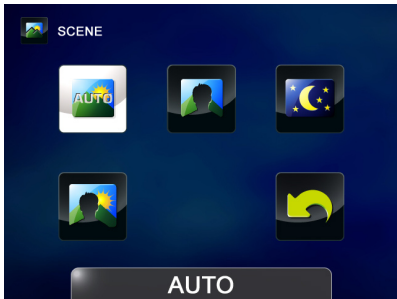
Operation	Display Screen
<ol style="list-style-type: none"> 1. In the Effects menu, touch the [Scene] icon twice on the screen. 2. Touch to select the desired option. 3. Touch again to validate the setting. 4. Or touch the Exit icon () to exit. 	









Note

To avoid blurry photos, place the camcorder on a flat, steady surface, or use a tripod when taking shots in the Night Mode.

Filter





You can select the special filter effects on the videos or photos.

	Auto	Shoot without any special effect on the image.
	Black & White	The image is converted to black-and-white.
	Classic	The image is converted to a sepia look.
	Negative	The image is converted as the negative of the normal.

Operation	Display Screen
<ol style="list-style-type: none"> In the Effects menu, touch the [Filter] icon twice on the screen. Touch to select the desired option. Touch again to validate the setting. Or touch the Exit icon () to exit. 	



White Balance

The camcorder adjusts the color balance of images automatically. Three manual white balance settings are available:

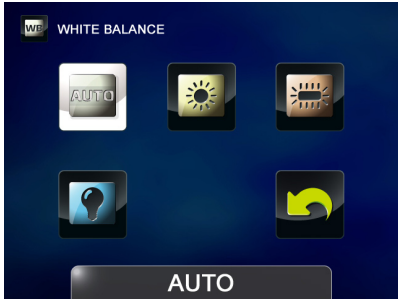
	Auto	The camcorder automatically adjusts white balance.
	Daylight	Under outdoor condition.
	Fluorescent	Under fluorescent light condition.
	Tungsten	Under tungsten light condition.

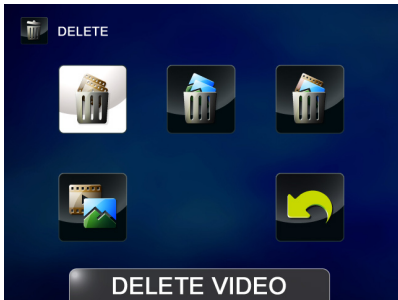

Operation	Display Screen
<ol style="list-style-type: none"> In the Effects menu, touch the [White Balance] icon twice on the screen. Touch to select the desired option. Touch again to validate the setting. Or touch the Exit icon () to exit. 	

Delete

Operation	Display Screen
<ol style="list-style-type: none"> 1. Touch  on the screen. The main menu will show on the screen. 2. Touch the [Delete ] icon twice on the screen to enter delete menu. 3. The Delete menu contains 4 options-- Delete Video, Delete Photo, Select & Delete, and Delete All --for you to manage the videos and photos in the built-in memory or the SD card. 	



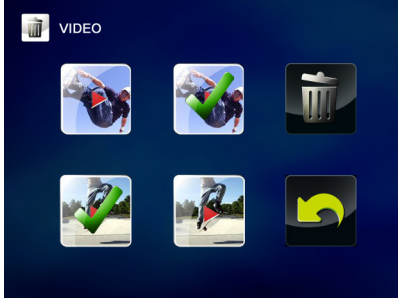

Delete Video

Operation	Display Screen
<ol style="list-style-type: none"> 1. In the Delete menu, touch the [Delete Video] icon twice on the screen. 2. In the video thumbnail screen, touch to select the desired video(s). (The check mark(s) will be shown on the selected file(s).) 3. Touch  to delete the selected video(s). 4. Or touch the Exit icon () to exit. 	



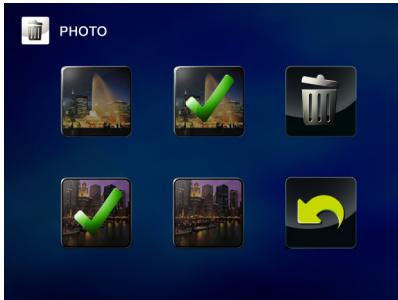

Delete Photo

Operation	Display Screen
<ol style="list-style-type: none"> 1. In the Delete menu, touch the [Delete Photo] icon twice on the screen. 2. In the photo thumbnail screen, touch to select the desired photo(s). (The check mark(s) will be shown on the selected file(s).) 3. Touch  to delete the selected photo(s). 4. Or touch the Exit icon () to exit. 	



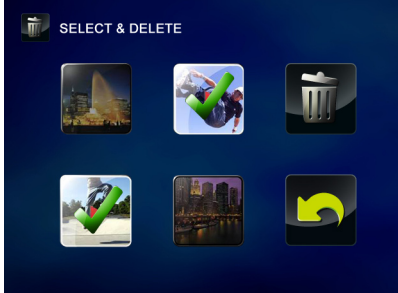

Select & Delete

Operation	Display Screen
<ol style="list-style-type: none"> In the Delete menu, touch the [Select & Delete] icon twice on the screen. In the video & photo thumbnail screen, touch to select the desired file(s). (The check mark(s) will be shown on the selected file(s).) Touch  to delete the selected file(s). Or touch the Exit icon () to exit. 	



Delete All

Use this option to delete all of the videos and photos

	Yes	Delete all of the videos and photos in the built-in memory (When there is no SD card in the camcorder). Delete all of the videos and photos on the SD card (When there is an SD card in the camcorder).
	No	Do not delete all of the videos and photos in the built-in memory (When there is no SD card in the camcorder). Delete all of the videos and photos on the SD card (When there is an SD card in the camcorder).

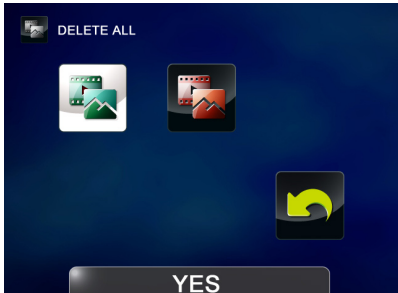
Operation	Display Screen
<ol style="list-style-type: none"> In the Delete menu, touch the [Delete All] icon twice on the screen. Touch to select the desired option. Touch again to validate the setting. Or touch the Exit icon () to exit. 	







Note

- If a memory card has been inserted, you can only delete those videos / photos stored on the card.
- Videos / photos on a written-protected memory card cannot be deleted.

Section 4 Playback Mode

Button Function

The Buttons have the following functions in Playback Mode.

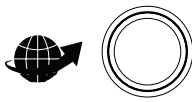





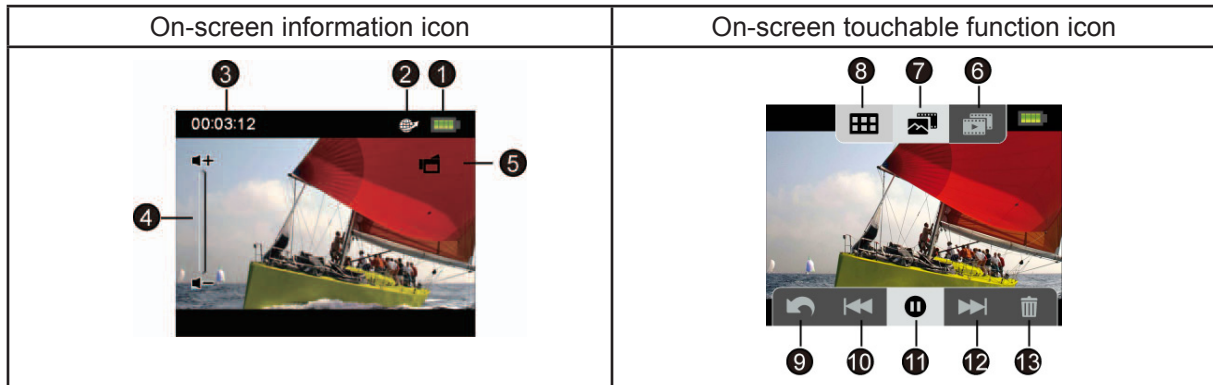

	<p>Video Button:</p> <ol style="list-style-type: none"> 1. Press to go the Video Record Mode
	<p>Photo button:</p> <ol style="list-style-type: none"> 1. Press to go the Photo Record Mode
	<p>Tele Button:</p> <ol style="list-style-type: none"> 1. Volume increase. <p>Wide Button:</p> <ol style="list-style-type: none"> 1. Volume decrease.
	<p>Pause Button:</p> <ol style="list-style-type: none"> 1. In Video Playback Mode, press to pause the recorded videos.
	<p>Internet Button:</p> <ol style="list-style-type: none"> 1. In Playback Mode, press to select the current video or photo to upload to the Internet.

LCD Monitor Information

Indicators on the LCD screen while in Playback Mode:



(1)		Battery: full power
		Battery: medium power
		Battery: low power
		Battery: empty power
		DC power mode
(2)		The current file is selected to upload to the Internet.
(3)	00:03:12	Playback time counter
	▲ 321	Number of current photo
	▼ 250	Total number of photos
(4)		Volume
(5)		Video playback mode
		Photo playback mode
(6)	Video Playback Mode	
		Indicate the function of continuous play on or off
	Photo Playback Mode	
		Indicate the function of slideshow on or off

(7)		Select & Play thumbnail screen On
(8)		Menu On
(9)		Return to Record Mode
(10)		Go to the previous file. Videos fast rewind
(11)		Play files
		Pause
(12)		Go to the next file. Videos fast forward.
(13)		Delete the current file.
(13)		Stop video playing. Stop photo slideshow









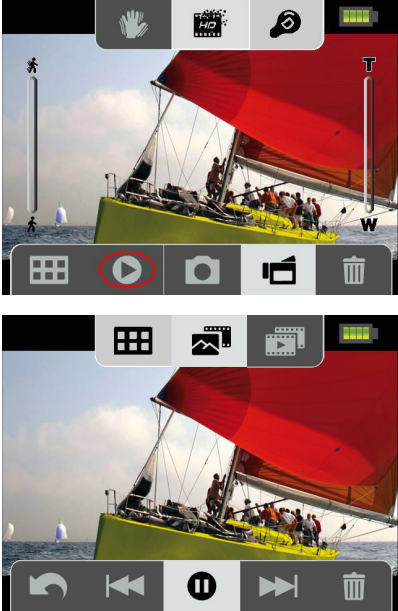

Note

- Tap on the screen to close the touchable function bars. Tap again to show the bars.

Operations for Playback Mode

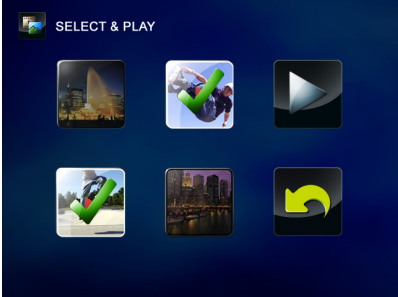
The Playback Mode is for viewing and managing videos and photos on the built-in memory or on an SD Card.

Operation	Display Screen
<p>1. In Record Mode, press [Playback Button] or touch  to switch to the Playback Mode.</p> <p>2. Touch  to go to the previous video/photo; Touch  to go to the next video/photo.</p>	
<p>3. Touch  to open the menu. (Please refer to section 3.)</p> <p>4. Touch  to open the thumbnail screen of videos and photos.</p> <p>5. In the thumbnail screen of videos and photos, select the file(s) you want to play, and then touch  to confirm. (The check mark(s) will be shown on the selected file(s).)</p> <p>6. Or touch  to exit.</p>	
<p>7. Touch  to play the selected files. (Video: full length. Photo: 2 seconds.)</p>	

Video Playback





















Operation	Display Screen
<ol style="list-style-type: none"> 1. In the Video Playback Mode, touch  /  to play or pause the video. 2. Touch  to go to the previous file; touch  to go to the next file. 3. While playing videos, touch  /  to fast rewind/forward. 4. In the Continuous Play On Mode ( is highlighted), touch  to play the all video files continuously. Touch  to stop playing. 5. Use Tele / Wide Buttons to adjust the volume. 6. Press Internet Button to select the current video to upload to Internet. 	

Photo Playback

Operation	Display Screen
<ol style="list-style-type: none"> 1. In the Photo Playback Mode, touch  to go to the previous file; touch  to go to the next file. 2. In the Slideshow On Mode ( is highlighted), touch  /  to play or pause the slideshow. Touch  to stop slideshow. 3. Press Internet Button to select the current photo to upload to Internet. 	

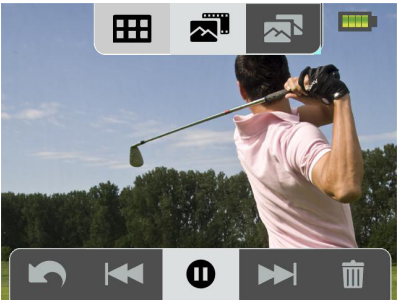
Delete File in Playback Mode

Operation	Display Screen
<ol style="list-style-type: none"> 1. In Playback Mode, touch  on the screen. 2. Touch  to delete the current photo. 3. Or touch  to cancel the operation and exit. 	

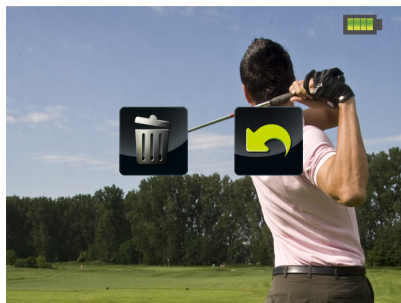



Note

- Videos and Photos on a written-protected memory card cannot be deleted.

Section 5

Setting Your Camcorder

Setup Menu

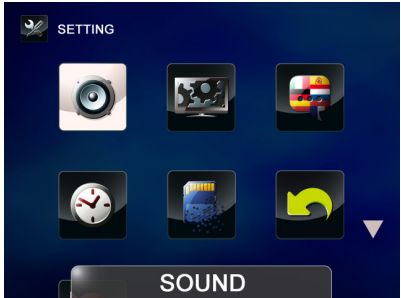
Operation	Display Screen
<ol style="list-style-type: none"> 1. Touch  on the screen. The main menu will show on the screen. 2. Touch the [Setup ] icon twice on the screen to enter its setting menu. 3. The Setup menu contains 6 options for configuring your camcorder setup. They are Sound (operation sound), TV, Language, Time Setting, Format, and Default Setting. 	

Sound

Enable or disable the keypad tone and the operation sound.

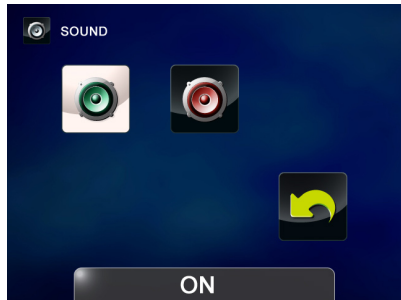
Operation	Display Screen
<ol style="list-style-type: none"> 1. In the Setup menu, touch the [Sound] icon twice on the screen. 2. Touch to select the desired option. 3. Touch again to validate the setting. 4. Or touch the Exit icon () to exit. 	

TV

Ensure that the appropriate TV standard of your area is selected – either NTSC or PAL. Wrong TV system setting may cause image flickers.

	NTSC(60Hz)	USA, Canada, Japan, South Korea and Taiwan, etc.
	PAL(50Hz)	UK, Europe, China, Australia, Singapore and Hong Kong, etc.

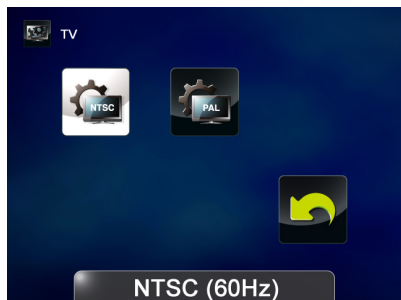
Operation	Display Screen
<ol style="list-style-type: none"> 1. In the Setup menu, touch the [TV] icon twice on the screen. 2. Touch to select the desired option. 3. Touch again to validate the setting. 4. Or touch the Exit icon () to exit. 	



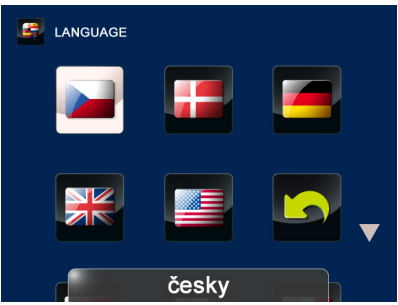

Language

Use this option to select the language of the user interface.

Operation	Display Screen
<ol style="list-style-type: none"> 1. In the Setup menu, touch the [Language] icon twice on the screen. 2. Touch to select the desired option. 3. Touch again to validate the setting. 4. Or touch the Exit icon () to exit. 	



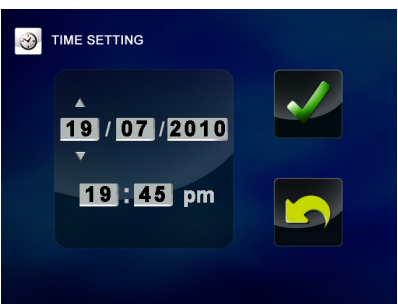

Time Setting

Operation	Display Screen
<ol style="list-style-type: none"> 1. In the Setup menu, touch the [Time Setting] icon twice on the screen. 2. Touch Year, Month, Day, Hour, or Minute to set. 3. Adjust the numeric value by touching the arrows. 4. Touch  to validate the setting. 5. Or touch the Exit icon () to exit. 	



Format

Use this option to erase all data in the built-in memory or the SD card.

	Yes	Format the built-in memory (When there is no SD card in the camcorder) / SD card (When there is an SD card in the camcorder).
	No	Do not format the built-in memory (When there is no SD card in the camcorder) / SD card (When there is an SD card in the camcorder).

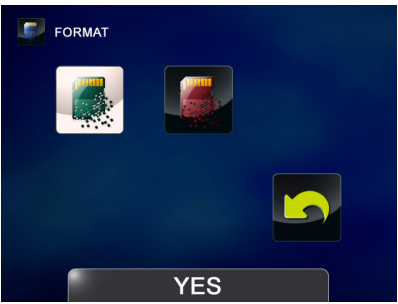
Operation	Display Screen
<ol style="list-style-type: none"> 1. In the Setup menu, touch the [Format] icon twice on the screen. 2. Touch to select the desired option. 3. Touch again to validate the setting. 4. Or touch the Exit icon () to exit. 	





Note

All the data will be erased if the SD card is formatted. Make sure all the data are copied to your PC before formatting the SD card.



Default Setting

Use this option to restore the default factory setting.

	Yes	Restore default factory setting.
	No	Do not restore default factory setting.

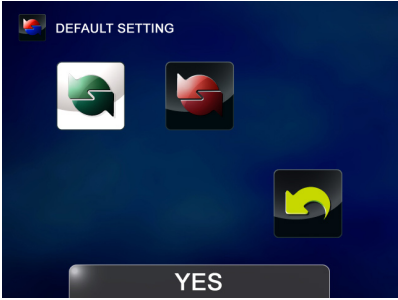
Operation	Display Screen
<ol style="list-style-type: none"> 1. In the Setup menu, touch the [Default Setting] icon on the screen to enter the confirmation screen. 2. Touch the [Yes] icon to execute the operation and the [No] icon to cancel the operation. 	

The following table indicates the camcorder's default settings

Setting	Default Factory Setting
Resolution	Full HD for Video Standard- 5M for Photo
Stabilization	Off
Motion Detection	Off
Slow Motion	Off
Time Lapse	Off
Self-Timer	Off
ISO	Auto
Scene	Auto
Filter	Auto
White Balance	Auto
Light	Off
Sound	On
TV	Depends on shipping area
Language	Depends on shipping area
Volume	Level 6

Section 6

Viewing Photos and Videos on TV

Connecting to a High-Definition 16:9(Wide) TV

1. Connect the HDMI cable to your camcorder's HDMI Out port.
2. Connect the other end of the cable to a television.
3. Set the video input source of your TV to "HDMI".
4. The steps for viewing stored videos and photos on an HDTV are exactly the same as for viewing them on the LCD monitor.

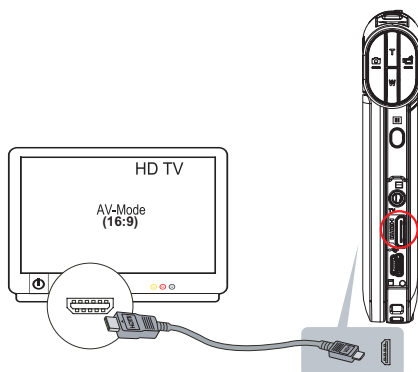

Note

The camcorder can not run menu setting, thumbnail screen, and certain on-screen setting when it is connected to an HDTV.

Connecting to a non-high-definition 4:3 TV

1. Connect one end of the AV cable to your camcorder's AV out port.
2. Connect the other end of the cable to a television.
3. Use the buttons to view the stored photos and videos on the TV.

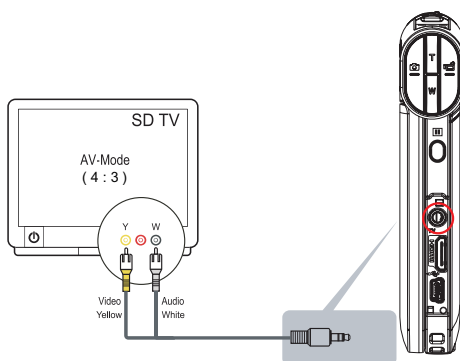

Note

The camcorder can not run menu setting, thumbnail screen, and certain on-screen setting when it is connected to a TV.

Section 7

Viewing Video & Photo on PC

Installing Bundled Software

The CD-ROM supplied with this camcorder contains 2 pieces of software.

- **ArcSoft MediaImpression** is a user-friendly application that helps you managing your media, burning your video into DVD, and uploading your files to the web sites easily.
- **Adobe Reader** is a popular program that you need to have installed to read the User's Manual. Many computer users will find they already have this software installed on their computer.

To install the bundled software:

1. Insert the CD-ROM into your computer's CD-ROM drive. The autorun screen appears.
2. Click "**Install Application Software**". Follow the on-screen instructions to complete the installation.



Note

- *The detailed Instructions for the bundled software can be found within the program once the installation is completed. Click on [Extras] on the title bar and select [Help] to open the instruction manual.*
- *Install the bundled software application, ArcSoft MediaImpression, for viewing the videos correctly on a PC.*

Transferring Photos or Videos to a Computer

You can transfer photos or videos stored on your camera to a computer and send them in e-mails to friends or post them on the web sites.

To do this you should:

1. Connect the computer and camera with the supplied mini USB 2.0 cable.
2. The videos and photos can be found on your computer at "My Computer\Removable Disk\DCIM\100MEDIA". (Under the circumstances of within the SD/SDHC card in the camcorder.)
3. Under this folder, you can view, delete, move, or copy any video/photo you want.

Section 8

Uploading Files to Internet

The built-in **CAMILEO UPLOADER** application offers you an easy way to upload your files to the social websites instantly. It helps you share them with your family and friends on the web sites. Also, the bundled software, **ArcSoft MediaImpression**, can be used to upload your files to the web sites.

CAMILEO UPLOADER

To upload files marked with  to Internet:

1. Select the files in the Playback Mode by pressing [Internet Button] .
2. Connect the camera to your computer by using the supplied USB cable.

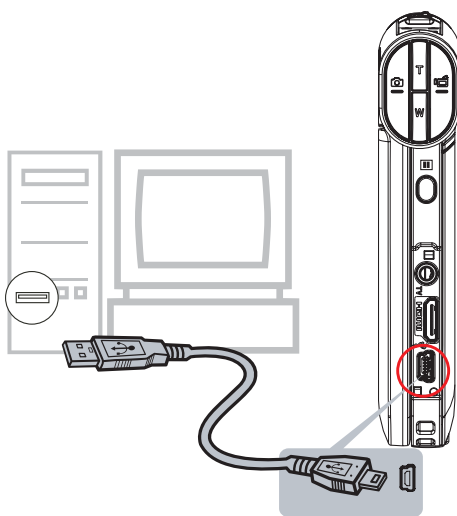



3. Press [Internet Button]  on the camera to launch the CAMILEO UPLOADER application automatically. (To view the recorded clips on CAMILEO UPLOADER, it is necessary to install ArcSoft MediaImpression first.)



Note

Some social websites may not be allowed to access in certain regions.

4. Upload files:

1. Choose the website you want to upload.
2. Press [Internet Button]  on the camera again.
3. The files marked with  will be uploaded to the website automatically. (You may be asked to fill in your account information before uploading or you can fill in the information firstly by click on )
4. Click on “CANCEL” to stop uploading.

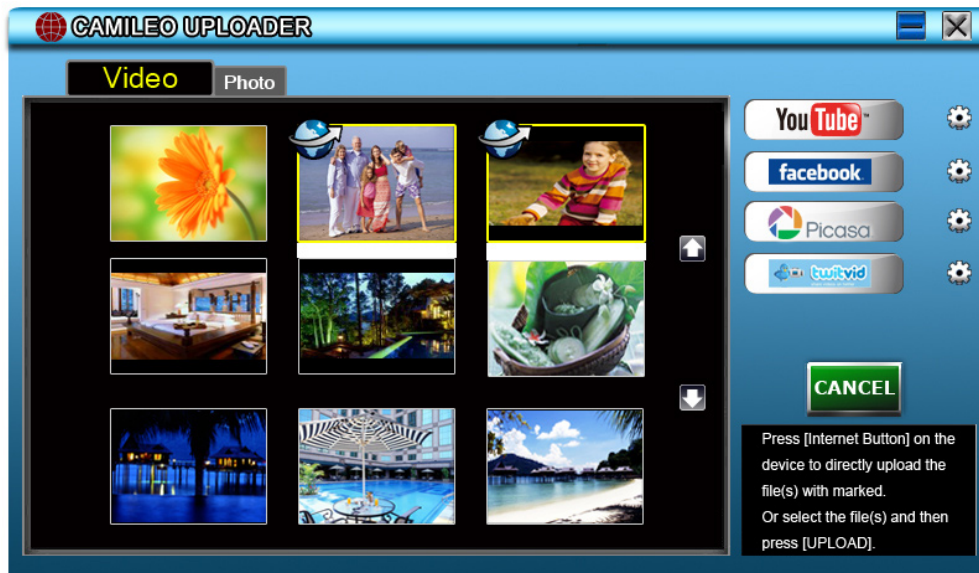



To upload files selected manually to Internet:

1. Follow the step 2 and 3 on the previous page.
2. On the thumbnail screen, click on the up/down icon to change the pages. Click on the files you want to upload.
3. Choose the website you want to upload.
4. Click on “UPLOAD” to start uploading.



To playback the video file:

1. Double click on the video clip on the thumbnail screen.
2. Click on the Play/Pause icon  to play/pause. Click on the Return icon  to return to the thumbnail preview screen.



To setup your account information for the website:

1. Click on  to go to the setup screen.
2. Fill in your account information in the blanks. Then click on "Save".



(If you do not have a account, please sign up on the website first.)

Section 9 Specifications

Specification	
Image sensor	5 Mega pixel CMOS sensor
Operation modes	Video record, Photo record
Lens	Fixed Focus (F 2.5)
Focus range	Macro Mode: 20cm (7.9 inches) Normal Mode: 110 cm (43.3inches) ~ infinite (HD60 & HD30)) 150cm (59 inches) ~ infinite (Photo & Full HD)
Zoom	1X~16x (16x Digital zoom)
Shutter	Electronic
LCD monitor	7.6 cm (3 inches) touch LCD
Storage media	Built-in 128MB memory (partial memory is used for firmware code); SD/SDHC/SDXC card slot support (up to 64GB)
Image resolution	16 Mega Pixels: 4608 x 3456 (Interpolated) 5 Mega Pixels: 2592x1944 3 Mega Pixels: 2048x1536
Video resolution	Full HD: 1920X1080(30fps) HD60: 1280X720(60fps) HD30: 1280X720(30fps) VGA: 640X480(30fps)
White balance	Auto/Manual (Daylight, Fluorescent, Tungsten)
ISO	Auto/800/1600
Self-timer	10 seconds delay
Light	Light ON/Digital Light ON/ Light OFF
File format	Photo: JPG Video: MP4
Image play	Single image/Slideshow
PC interface	Mini USB 2.0 port
TV out	NTSC/PAL selectable, HDMI
Battery	Lithium-ion rechargeable battery
Dimension	60/74mm (W) × 111mm (H) × 20/22mm (T) (2.4/2.9(W) × 4.4 (H) × 0.8/0.9 (T) inches)
Weight	128 g (without battery)

Section 10

Troubleshooting

Troubleshooting

1. If the LCD preview is not clear while shooting, how can the focus be adjusted?

Try to switch between Macro and Normal Mode.

2. The files on the memory card do not display smoothly when the LCD shows the “!” marking.

The “!” means the SD card is low speed or is having wrong content inside. The way to solve this condition is to format SD card by the camcorder instead of a PC (Please refer to the detailed Format instruction in Section 5).

Or please change the SD/SDHC/SDXC card to a high speed one.

3. Why do some of my indoor photos look blurry and dark?

The camcorder extends photo exposure time under low light/ indoor condition. Keep the camcorder (and the target subject) steady for several seconds when taking photos. The shutter will sound when photos are being taken.

4. How do I charge battery?

You must use the supplied AC charger or the USB cable. The camcorder must be turned OFF; blinking light confirms charging, and the light becomes constant after the charging is completed.

In AC charging Mode, the light will turn itself off automatically after 3~5 minutes. The full charge time is about 4 to 4.5 hours. (Actual charging time may vary. It depends on the battery conditions.)

5. After connecting the USB cable to the computer,

1. The disk [DV] shows the internal memory of the camcorder.
2. [Removable Disk] shows the external memory. (Under the circumstances of within the SD/SDHC/SDXC card in the camcorder)
3. The disk [DVAP] shows the built-in CAMILEO UPLOADER application is saved at this disk. Please DO NOT format this disk or delete the application inside; otherwise, the CAMILEO UPLOADER application can not function.

Section 11

Other Information

TOSHIBA Support

Need help?

For the latest driver updates, user's manuals & FAQ's please have a look at the TOSHIBA options & services support page:

computers.toshiba.eu/options-support

Please see

computers.toshiba.eu/options-warranty

for the TOSHIBA hotline numbers.

Operating Environment Conditions

Operating temperature: 5 to 35° C

Operating humidity: 20 to 80 %

(no condensation allowed)

Regulatory Information

CE compliance



This product is CE marked in accordance with the requirements of the applicable EU Directives. Responsible for CE marking is Toshiba Europe GmbH, Hammfelddamm 8, 41460 Neuss, Germany. A copy of the official Declaration of Conformity can be obtained from following website: <http://epps.toshiba-teg.com>.

Working Environment

The Electromagnetic Compliance (EMC) of this product has been verified typically for this product category for a so called Residential, Commercial & Light Industry Environment. Any other working environment has not been verified by Toshiba and the use of this product in these working environments is maybe restricted or cannot be recommended. Possible consequences of the use of this product in non verified working environments can be: Disturbances of other products or of this product in the nearby surrounding area with temporarily malfunction or data loss/corruption as result. Example of non verified working environments and related advices:

Industrial environment (e.g. where a 3-phase 380V mains is being used mainly): Danger of disturbances of this product due to possible strong electromagnetic fields especially near to big machinery or power units.

Medical environment: The compliance to the Medical Product Directive has not been verified by Toshiba, therefore this product cannot be used as a medical product without further verification. The use in usual office environments e.g. in hospitals should be no problem if there is no restriction by the responsible administration.

Automotive environment: Please search the owner instructions of the related vehicle for advices regarding the use of this product (category).

Aviation environment: Please follow the instructions of the flight personnel regarding restrictions of use.

Additional environments not related to EMC

Outdoor use: As a typical home/office equipment this product has no special resistance against ingress of moisture and is not strong shock proofed.

Explosive atmosphere: The use of this product in such special working environment (Ex) is not allowed.

REACH

Following information is only valid for EU-member States:

REACH - Compliance Statement

The new European Union (EU) chemical regulation, REACH (Registration, Evaluation, Authorization and Restriction of Chemicals), entered into force on 1 June 2007.

Toshiba will meet all REACH requirements and is committed to provide our customers with information about the chemical substances in our products according to REACH regulation.

Please consult the following website www.toshiba-europe.com/computers/info/reach for information about the presence in our articles of substances included on the candidate list according to article 59(1) of Regulation (EC) No 1907/2006 („REACH“) in a concentration above 0.1 % weight by weight.

Following information is only valid for EU-member states:

Disposal of products

The crossed out wheeled dust bin symbol indicates that products must be collected and disposed of separately from household waste. Integrated batteries and accumulators can be disposed of with the product. They will be separated at the recycling centres.



The black bar indicates that the product was placed on the market after August 13, 2005. By participating in separate collection of products and batteries, you will help to assure the proper disposal of products and batteries and thus help to prevent potential negative consequences for the environment and human health.

For more detailed information about the collection and recycling programmes available in your country, please visit our website (<http://eu.computers.toshiba-europe.com>) or contact your local city office or the shop where you purchased the product.

Disposal of batteries and/or accumulators

The crossed out wheeled dust bin symbol indicates that batteries and/or accumulators must be collected and disposed of separately from household waste.

If the battery or accumulator contains more than the specified values of lead (Pb), mercury (Hg), and/or cadmium (Cd) defined in the Battery Directive (2006/66/EC), then the chemical symbols for lead (Pb), mercury (Hg) and/or cadmium (Cd) will appear below the crossed out wheeled dust bin symbol.



Pb, Hg, Cd

By participating in separate collection of batteries, you will help to assure the proper disposal of products and batteries and thus help to prevent potential negative consequences for the environment and human health.

For more detailed information about the collection and recycling programmes available in your country, please visit our website (<http://eu.computers.toshiba-europe.com>) or contact your local city office or the shop where you purchased the product.

Additional Information

© 2010 TOSHIBA Europe GmbH. All rights reserved.

TOSHIBA reserves the right to make technical changes. TOSHIBA assumes no liability for damages incurred directly or indirectly from errors, omissions or discrepancies between this product and the documentation.

About the battery pack

- Use only batteries recommended by TOSHIBA as replacements. The battery pack is lithium ion batteries, which can explode if not replaced, used, handled or disposed of properly. Dispose of the battery as required by local ordinances or regulations.
- Charge the battery pack only in an ambient temperature between 5 and 35 degrees Celsius. Otherwise, the electrolyte solution might leak, battery pack performance might deteriorate and the battery life might be shortened.
- Never install or remove the battery pack without first turning off the power and disconnecting the AC adaptor.
- Use only the product connected to an AC power source or optional TOSHIBA Battery charger to charge the battery pack. Never attempt to charge the battery pack with any other charger.

P20_UM_V02_0111

TOSHIBA
Leading Innovation >>>

For more information, please visit:

www.toshiba-multimedia.com

Free Manuals Download Website

<http://myh66.com>

<http://usermanuals.us>

<http://www.somanuals.com>

<http://www.4manuals.cc>

<http://www.manual-lib.com>

<http://www.404manual.com>

<http://www.luxmanual.com>

<http://aubethermostatmanual.com>

Golf course search by state

<http://golfingnear.com>

Email search by domain

<http://emailbydomain.com>

Auto manuals search

<http://auto.somanuals.com>

TV manuals search

<http://tv.somanuals.com>